

THE BROTHERHOOD OF LIGHT[®]



The Books of the Brotherhood

[Book 1: Laws of Occultism](#)

[Book 2: Astrological Signatures](#)

[Book 3: Spiritual Alchemy](#)

[Book 4: Ancient Masonry](#)

[Book 5: Esoteric Psychology](#)

[Book 6: The Sacred Tarot](#)

[Book 7: Spiritual Astrology](#)

[Book 8: Horary Astrology](#)

[Book 9: Mental Alchemy](#)

[Book 10-1: Natal Astrology](#)
[Delineating the Horoscope](#)

[Book 10-2: Natal Astrology](#)
[Progressing the Horoscope](#)

[Book 11: Divination and Character Reading](#)

[Book 12-1: Natural Alchemy](#)
[Evolution of Life](#)

[Book 12-2: Natural Alchemy](#)
[Evolution of Religion](#)

[Book 13: Mundane Astrology](#)

[Book 14: Occultism Applied](#)

[Book 15: Weather Predicting](#)

[Book 16: Stellar Healing](#)

[Book 17: Cosmic Alchemy](#)

[Book 18: Imponderable Forces](#)

[Book 19: Organic Alchemy](#)

[Book 20: The Next Life](#)

[Book 21: Personal Alchemy](#)

Links to Lessons

1	21	45	67	92	115	135	155	176	196	216
2	22	46	71	95	116	136	156	177	197	217
3	23	47	72	96	117	137	157	178	198	218
4	24	48	73	97	118	138	158	179	199	219
5	25	49	74	98	119	139	159	180	200	220
6	26	50	75	99	120	140	160	181	201	221
7	27	51	76	100	121	141	161	182	202	222
8	28	52	77	101	122	142	162	183	203	223
9	29	53	78	103	123	143	164	184	204	224
10	30	56	79	104	124	144	165	185	205	225
11	31	57	80	105	125	145	166	186	206	
12	32	58	81	106	126	146	167	187	207	
13	33	59	82	107	127	147	168	188	208	
14	36	60	83	108	128	148	169	189	209	
15	37	61	86	109	129	149	170	190	210	
16	40	62	87	110	130	150	171	191	211	
17	41	63	88	111	131	151	172	192	212	
18	42	64	89	112	132	152	173	193	213	
19	43	65	90	113	133	153	174	194	214	
20	44	66	91	114	134	154	175	195	215	

Book 1

Copyright
Church of Light
August 2002

The Laws of Occultism

Chapter 1

Serial No. 39
Original Copyright 1921
Elbert Benjamine

Copyright
Church of Light
August 2002

Occult Data

Chapter 1

Occult Data

THE WORD occult means that which is hidden. Occultism, consequently, is the science of hidden forces, and the art of subjecting such forces to human control. Here we will consider the data upon which occultism rests.

Its subjects are not directly apprehended by the five senses upon which the physical scientist relies for all knowledge. The line of demarcation between that which is called occult is, therefore, constantly changing; for scientists every now and then invent a device by which some hitherto occult force is made directly perceptible to the physical senses. It is then no longer considered occult.

Not long since, for instance, the power of the lodestone was held to be occult. Indeed, so far as any knowledge of its nature is concerned, the physical scientists should include the force of gravitation in the occult category; for they admit it operates across immense space in which there is nothing that can be apprehended by the five senses, yet fail to explain by what hidden means the force is transmitted.

The infrared and ultraviolet rays of light, also were occult a few years ago, and are so yet to the majority of people.

All mental forces fall properly into this category, as is admitted in the case of hypnotism, exhibiting, as it does, the power of one mind over another.

It is clear, then, that the common application of the word occult, since it depends upon the experience of the speaker—for what is hidden to one may be perceived by another—is wholly arbitrary.

Man Fears That Which He Does Not Understand

—The word carries with it an air of mystery, it is true; but all forces are mysterious to those who have not studied them; and what is mysterious to the ignorant is obvious to the learned. Yet in all nature, nothing can come permanently under this ban; for all mysteries may be solved. Thus the simplest conveniences of modern civilization are mysterious to the untutored savage. He is wont to attribute their power to some

supernatural agency. But there is nothing supernatural—nothing, that is, not governed by natural laws. Above and below, all obey those by which they manifest; and while these laws are uncomprehended any phenomenon seems mysterious.

It was this Uncomprehension that caused the terror of the Red Man, who, not understanding the natural laws underlying its geysers and boiling paint-pots, feared to enter the Yellowstone Park: while the White Man, sure that its riddles could be solved, has made it his national playground. And just as the savage inclines to attribute such phenomena to some supernatural agency, or similarly to attribute the powers of the burning-glass, and to regard photographs with reverence, so other men, more highly endowed, but not less ignorant in that special direction, can see in spiritual phenomena only Divine intervention and miracles.

Thus do all of us fear that which we do not understand; but with understanding comes courage, for with the dawning of the light of the mind we see how any hidden danger—if danger there be—may be circumvented. Knowledge reveals it either as a scare-crow or as a menace, the one to be ignored and the other avoided except as it can be made subservient to the will of man.

Progression Depends Upon Knowledge

—Man's only progression, here or hereafter, must be founded on knowledge. Only by its means can he subjugate his external environment and enjoy its opportunities. He who is ignorant of the laws of his physical body incurs illness. He who is ignorant of the laws governing acquisition remains in poverty. He who is ignorant of the social laws of his land is likely to be deprived of his liberty.

So it is also with things spiritual. Only through a knowledge of spiritual laws can man mold his spiritual environment and enjoy, while yet on earth, spiritual powers. Ignorant of the laws of his spiritual body, he incurs moral maladies that follow him beyond the tomb. Ignorant of the laws governing the acquisition of spiritual attributes, he misses the greatest treasures of this life, and passes to the life beyond in spiritual poverty. If, still ignorant, he goes to the new life with no knowledge of the laws and customs of the denizens of that realm, or if he contacts them while he is still embodied, he may, in his unenlightened condition, be deprived of his liberty. Only through knowledge of himself, and of the powers and forces by which he is environed, can he expect to progress. And it is for this reason that the occultist applies himself to the acquisition of such knowledge.

Its acquisition, like everything else, depends much upon a proper beginning, and the occult student, starting out on his voyage in search of the Golden Fleece of spiritual truth, needs to take care that he sets sail from the right port and in the right direction. At the very beginning, then, of our bold enterprise, in which we purpose to carry the student safely across the muddy tide of metaphysics and land him securely on the bright shores of occult knowledge, we must indicate our port of debarkation and

show it to be a true port.

All Knowledge Is Based Upon Experience

—No better starting point can be found for such a purpose, nor another nearly so strong and well defended, as the fundamental assertion, I AM. Following Nature as our safest pilot, we discover that the first glimmer of consciousness—that which foreshadows knowledge—is concerned with distinguishing the Me from the Not-me. Thus a sensation registers as something distinct from me but affecting me; and it matters not whether we accept the statement of the Cartesian school, “I think, therefore I am,” or prefer the version of Eliphaz Levi, the learned French Magus, “I am, therefore I think,” the fact remains that the assertion “I AM” is irrefutable.

By no quirk of speculation can we deny the existence of the thinker, who must postulate a being able to think before he can find ground on which to stand to make denial. When he admits the existence of a being able to form an opinion, he has established himself as an entity; for, clearly, if there is no thinker, there can be no thought; and if there is no thought there can be no denial. Consequently, no one can deny his own existence; and from this undeniable premise any correct system of philosophy must start.

The consciousness of the thinker, thus firmly established, is a perception of relations. These relations may be subjective or objective, but to be conscious of them he must be able to compare them. Where there is no change, no relative conditions, there can be no consciousness.

Similarly, limited perceptions of relations mean limited consciousness, and greater perceptions of relative conditions bring greater consciousness. Evolution is thus observed to be in the direction of increased perceptions, that is, to be moving toward greater consciousness. Therefore, as evolution continues, consciousness expands; and as evolution advances toward infinity, the perceptions increase, until absolute consciousness is approached.

In the same way, lower forms of life than man have perceptions of the narrower world in which they live, and these constitute the basis of their actions. But man has not only perception of his immediate environment, he can recall in memory many of these external perceptions and combine them in a new order. Such a complex mental grouping is called a concept. Concepts, in turn, combine into the larger group we call knowledge, which is thus seen to rest upon experience-gained perceptions, grouped in memory.

Even though we gain the knowledge from books, it is nevertheless gained by experience; for to read another’s writing is an experience as truly as if one were to feel in himself the physical sensations of the writer. Such an experience is, of course, mental rather than physical; but it is still an experience. Reasoning, also, is an

experience, arising from the comparison of relations held in memory. In very truth we have no knowledge except that gained through experience, and that experience is a continually increasing consciousness of relations of various perceptions and concepts.

The first form of this consciousness is decidedly limited; for as a new-born babe I possess scarcely more than the instinct inherent in all life to struggle for existence. To what extent these inherited instincts and tendencies depend upon previous experiences of the soul before birth in human form does not concern us now. Enough that I, together with all living beings, have an instinct to sustain existence. This instinct leads to actions that supply nourishment to the body, and these actions register impressions on the consciousness. At this time, I am unaware of more than a few primitive sensations, and my consciousness has a very limited scope. But limited as it is, there soon develops a dim perception of relations. Thus I become aware that the sensation I later call hunger is appeased by taking nourishment, and that certain actions on my part lead to this nourishment being furnished by my mother. Here I take my first step in positive knowledge; for I have discovered the relation existing between two sets of sensations.

All knowledge possible to me, here and hereafter, must rest upon a similar basis; for there is no knowledge that does not rest upon experience, and no experience apart from a perception of relations.

In this typical case I find that a certain set of sensations is followed by another set of sensations. The same thing happens over and over again, until the connection is established in memory. Because of the repeated association of these two sets of sensations in my experience I conclude that the first set is always followed by the other set. This is KNOWLEDGE.

Growing from infancy to childhood, my perception of relations gains a wider scope. Day by day I add to the store of such experiences, and of others. Some objects have thus attracted my attention through the sense of sight, and I have discovered that things thus seen have come into my possession when reached for. So I reach for the object of my desire. Since my experience so far has been very limited, my knowledge is only partial and I reach for an object across the room with the same assurance as if it were near at hand. But I am unable to procure it, and this adds to my experience.

Later I learn, by repetition of this experience, and comparison of it with similar experiences in which I have successfully gained possession of the coveted object, that some objects are close at hand and others are distant. Thus I correct my first impression that reaching brings an object within range of the sense of touch, and a knowledge of the relation called distance enters my mind. This knowledge is emphasized and made important to me through the sensations of pleasure and pain.

Illustrating the function of pleasure and pain, when learning to walk if I reach for a chair that is too far away, expecting it to support me, I fall and am hurt. But if I am correct in my estimate of distance, I avoid the pain of falling and take pleasure in my achievement. Pleasure and pain, when applied by Nature rather than by man, always

are educational; never reward and punishment as society conceives them. (See Course 11, Divination and Character Reading, Chapter 5).

Again, a lighted candle looks very pretty and inviting, and I desire to gain impressions of it through other senses than the sense of sight. I expect a pleasurable sensation to follow touching or tasting it, because it is pleasing to the eye. But in this instance my knowledge is imperfect, and the result is pain. Therefore, after touching the lighted candle I revise my opinion of it, and decide that while it is pleasant to sight, it is painful to both touch and taste. And in later years I can form the generalization that acting upon imperfect knowledge often brings some painful result. This is TRUTH.

We now see that Truth is the conformity of cognition to reality. And while at this early age my limited experience causes me to form many erroneous conclusions from the impressions reaching me from the universe, a wider range of experience enables me to revise my early conclusions and approach more nearly the truth. Thus is growth in consciousness the continued approximation of cognition to reality, casting away that which proves erroneous, and confirming that which proves consistent.

In later life there are experiences of a mental nature by which the result of other person's experiences are conveyed to me through speech and writing. Even a thought, however, is a movement in some substance, and implies a perception of relations. The process, therefore, of following the reasoning of another is an experience as truly as is physical action. And I find that through mental effort I can draw conclusions regarding the probable result of a certain course of action. I myself have never had the experience derived from such actions in my own life, but I can compare them with those which I have had which are most like them. If the resultant conclusions are correct, if they parallel reality, I derive benefit from them; but if they are erroneous I suffer. When I have taken this step I rely more upon mental experience to furnish me the necessary knowledge.

But whether the experience be mental or physical, we have but one reason to rely upon it; which is that it furnishes us with more or less accurate data for future action.

It is only because we have found, in a similar way, that we can more or less clearly anticipate conditions and profit by that anticipation that we learn to rely upon the processes of the mind. Sense impressions and reason are thus alike valuable only in so far as they furnish correct knowledge; for upon this depends the ability of the organism continuously to adapt itself to environment, and upon this ability depends its survival. Failure to adapt itself to an environment accurately apprehended and correctly reasoned upon means first pain, and finally death. On the other hand, continuous adaptation means continued life, and the more perfect the adaptation the fuller the life.

Man, then, has found that reason based upon the perceptions of his physical senses is necessary for adaptation and consequent survival; but its value depends upon their accuracy. Therefore, if some other means can be discovered that will give more

accurate results, or additional information, progress demands its adoption.

The Proper Test of Either Physical or Psychical Faculties

—That such other faculties exist in nature—faculties which, relied upon bring satisfactory results—needs but a glance about us to demonstrate. For example, the homing pigeon needs neither reason nor any past experience of the region over which it flies to find its way unerringly to its roost, hundreds of strange miles away. And a honey-bee needs neither reason nor compass to take a straight course to its hive through forests and over mountains. The oriole also needs no previous experience to enable it to build its cleverly-woven hanging nest. These and many other instincts of wild creatures are reliable within their boundaries, just as man's reason is reliable within certain limits. Experience alone determines in any case how much reliance can be placed on either; and this conformity of later experience to expected results alone is the test of the value of any faculty.

To learn thus to check the reports of the senses by experience—to test in the laboratory of life the accuracy of observation and the conclusions based thereon; especially to be able to do this mentally, without going through the slow and usually painful process of physical testing—is the greater part of wisdom.

Early in his life the great sage, Giordano Bruno, found out this truth. Looking across the undulating foothills to Mt. Vesuvius,¹ apparently scarred and bare of all vegetation, he desired greatly to visit the volcano and observe its barren stretches at close range. Finally the opportunity came for him to take the journey and he set forth from his native fields and vineyards. What was his surprise on reaching the distant mountain to find its sides covered with vegetation, while, looking back on the lands of his fathers from that distance, they seemed as barren and destitute of life as the mountain had seemed. This lesson was never forgotten.

From it he learned to distrust the reports of his senses, and thereafter carefully devised means of checking and testing the accuracy of all sense impressions. As a result he became the greatest scientist of his time and assisted in the overthrow of the Aristotelian system of philosophy and the establishment of the heliocentric system of astronomy, by his achievements proving that he had found the true method of wisdom.

His greatness was directly connected with the fact that he early discovered what we must all discover before we can correct and improve our knowledge—namely, that we constantly misinterpret our sense impressions, and despite repeated efforts to check them one against another and to subject them to reason we almost daily draw from their reports wrong conclusions.

Thus we see a familiar face across the street and go to offer greetings only to find ourselves confronted by an utter stranger. We have made a mistake. Or we hear a

sound, and conclude it comes from a great distance; but investigation proves it to be a faint sound close at hand that, because of lack of volume, we mistook for a greater sound, more remote.

But in addition to the reports received by these physical senses, we have to consider the claims of the super-physical senses; for some people declare they are able to check the impressions of the physical senses by impressions received through other avenues. They also assert that they are able to draw correct conclusions without the ordinary process of reasoning. Both the truth and the reliability of such impressions and conclusions must be subjected to the same tests. Their value—like the value of more usual conclusions—can be determined only by experience.

We have just found that our only excuse for accepting the reports of the physical senses and ordinary reason as a basis for action is that conclusions based upon them have coincided with later experience. The reliability and truth of other methods of interpreting phenomena must be determined by the same standard.

Thus if by some other faculty than physical sight I see a friend approaching, and later this friend actually pays me a visit, and I ascertain he was on the way at the time I had the vision, I tentatively conclude there is an inner sense of sight. If I have frequent experiences of this kind, as some persons certainly do, and if on each occasion when I see the event by clairvoyant vision, the external event actually transpires, though I had no means of knowing, through any physical avenue, that it would so transpire, I am gradually justified in placing confidence in such visions as a basis of future action.

If, again, some business proposition is presented to me and even before I have reasoned about the matter I feel that it will prove a failure, and events later prove this intuition correct; and such occurrences frequently take place, I am justified in concluding that there is a possibility of arriving at a correct judgment apart from reasoning. And if on many occasions I find the experience with reality coincides with the impressions received through intuition, I am justified in basing future actions upon intuition.

If in such a case the report of physical sight or ordinary reason conflicts with the inner sense of sight, and with intuition, I must then reflect which has more generally proved correct in the past, and incline toward that one.

The Dogmatism of Material Scientists

—It should be unnecessary to call attention to the foregoing obvious truths. But there is a tendency among material scientists to overlook the fact that the physical senses are but instruments by which reality may be determined, and that their value lies wholly in their ability correctly to report the universe and to direct man's actions in conformity therewith.

To assert, as many of them do, that the physical senses and reason are the only means by which the universe may be apprehended and knowledge gained, is thoroughly unscientific; for any such assertion is an assumption not verified by experience.

When it takes this attitude, material science is as dogmatic as the religions it ridicules; for it assumes a superiority and infallibility that its own history refutes. It boasts of its experimental methods, but fails to apply those methods except to a very limited section of the universe—a limited section which it dogmatically assumes to be the only legitimate field of investigation. When scientists take such an unwarranted stand, sincere men, seeking the truth in all regions; seeking, that is, to conform cognition to the infinite and inexhaustible Reality, must protest.

Attempts like this to narrow the field of inquiry arise from a very natural effort to bring the subject of study—this vast universe—within reach of the circumscribed intelligence of the investigator.

It is not a new attempt. The Inquisition rose to a similar attempt, and haled before it, a few hundred years ago, the famous scientist, Galileo, who had dared to investigate beyond the ecclesiastical limits and to inquire into the solar system. Such breadth of inquiry was then held sacrilegious, just as the breadth of inquiry of Psychical Research and still more of Occultism is subject to the reproach of orthodox physical scientists. For while today the legitimate field of experimental investigation has expanded to include the entire realm of physical phenomena, it is still restricted to that comparatively limited field, and those who declare that there are vaster realms to be explored, interior to the physical, are considered to be as foolish as were the first astronomers who declared the earth to be, not the center of the universe, but merely one planet among many, moving around a sun a million times larger.

Yet since we agree that all knowledge must be based upon experience, and since repeated experiences, as we have just seen, tend to correct false impressions derived from a too-limited experience, it is clear that any avenue by which man can arrive at that wider and more accurate cognition is legitimate, and that the only test of its usefulness lies in the verity.

Thus if I have a dream, and this dream is followed in a few days by a certain event, and I have the same dream again and again, and on each occasion it is followed by the same event, the dream is just as useful a source of information regarding the approach of this particular event as if the information had come through some recognized physical channel.

If such dreaming is cultivated and the images thus presented to the mind are found by experience invariably to signify approaching events, and by this means situations are foretold accurately and repeatedly that could not have been known by any merely physical means, these dreams become a legitimate source of valuable knowledge, whose reliability has been determined by repeated experiment.

As a matter of fact, many people receive information through such dreams, and there are indisputable records of lives having been saved by them.

True, I am not justified in coming to the conclusion that dreams, clairvoyance, telepathy, and other psychic activities now called occult, are to be relied upon without full proof; and I am not justified in accepting loose explanations of them; or any explanations that have not been tested thoroughly by experiments.

Thus if I hear a voice clairaudiently, purporting to come from someone long since dead, I may accept the fact that I hear the voice and wait for further confirmation of its supposed source. Devices have been arranged to check physical experiments against false conclusions; and tests may be contrived in these cases also to preclude the possibility of deception in determining the identity of a discarnate entity. Nor am I justified in following the advice received through this clairaudient faculty unless I have found through repeated observation of information so gained that it is reliable. Even then, on some particular occasions the information gained might lead astray, just as I might find the advice of a friend unusually good, but on some special occasion it would prove faulty. The accuracy and value of information received through any channel, physical or psychical, equally requires experimental determination.

The literature covering the field of psychical research, here just touched upon, will prove amply to any unprejudicated mind that there are senses and faculties other than the five physical senses.

Physical science, as yet unable to account for these powers, conveniently ignores them, and, assuming an air of enlightened superiority, puts the entire matter aside by simply saying “Bosh!” This is bad enough, as an exhibition of the limitations of our advanced men of science, but it is worse because to the lay mind the utterances of these savants are considered final.

The general impression is that material science is infallible, when the truth is that it is undergoing a constant process of revision, each decade trying to correct the mistakes of the previous decade. Thus what is accepted as scientific today was unknown a few years ago, and may in its turn be refuted in years to come. Indeed, many of the very things science proclaimed to be impossible thirty years ago are now accomplished facts. Current scientific opinion is thus continually overthrown by new discoveries, and the whole structure must be rebuilt to conform to the altered conceptions.

This is not at all to the discredit of material science, and occult science should follow the same procedure; for, as we have been seeing, it conforms to the method by which knowledge grows; but nevertheless to build upon the conclusions of material science alone is to build upon the ever-shifting sands. Its conclusions should be steadied and bettered by the binding cement brought from other and wider regions.

Super-physical Faculties

—But whatever the value of the conclusions of others, every true scientist after assimilating them, desires to read the Book of Nature for himself. Sooner or later he

examines the ground of his own first-hand knowledge, and here he well may start with the positive knowledge "I AM." This, certainly, he knows of himself.

Next, he discovers there is something else than I AM: The Universe Exists. This he Feels.

It is from these feelings that he endeavors to determine the nature of that universe in relation to himself; to the one who feels and knows. And here he discovers the dimly felt presence of the super-physical senses and is almost sure to learn that in his community is someone claiming to possess these senses in a more marked form.

Through this person, or others of the same sort, the earnest scientist supplements the knowledge gained from physical research with the further knowledge to be gained from psychical research. It is probable that his first experiments will be inconclusive; but if he persists over a sufficiently extensive area, he will discover beyond the shadow of a doubt—as has every scientist who has done thorough work in this field—that there assuredly are faculties, principles, and forces as yet undreamed of by materialistic philosophers. With this conviction he becomes an occult scientist.

The Inadequacies of Physical Science

—Already in the realm of physical science he has found its advocates making claim to knowledge they can in no way substantiate. He knows that the things conceded to be the very bulwarks of scientific accuracy and precision are very far from it when put to the test.

Such discrepancies between theory and practice are not loudly announced to the general public, because the bread and butter of scientific men depend upon their reputation for knowledge and accuracy. For example, the Law of Gravitation, which is the basis of all astronomical and mechanical reckoning, and is stated thus—The attraction of Gravity between two bodies is directly in proportion to the product of their masses and inversely as the square of their distance—does not give precision in celestial calculations. By all the teachings of physical science the planets should exert an influence upon each other which could be exactly measured according to this law. But as a matter of experience it is found that a decimal must be added to the squares of their distances, and even with this tampering with figures to make the answer coincide with observed results the actual positions of the planets continue to vary from their calculated places, and there is a continual alteration of the mathematical formulas in an attempt to get the correct answer.

Again, take the theory of the tides as accepted and taught in the schools of the land. One might suppose, from the definite way it is set forth, that this theory is the essence of scientific accuracy. But in actual practice the tides do not at all coincide with their theoretical rise and fall;² indeed, the divergence is sometimes so wide that the Moon apparently repels the tides instead of attracting them,³ and they occur at points almost

opposite those at which they would theoretically be calculated. Therefore in actually predetermining the tides for practical purposes their fluctuations are frankly calculated from past observations. It is the case of getting the right answer without knowing why, like a schoolboy working a problem whose answer is given in the back of the book.

Noting this familiar performance on the part of men of standing in the scientific world, our occult investigator is not surprised to find that there are many claims advanced by enthusiastic students of occultism also that can not be verified. But he no more throws over all of occultism when he makes this disconcerting discovery, than, under similar circumstances, he casts aside all the findings of physical science.

The Proof of the Pudding Is in the Eating

—At this stage, his attention may be called to Astrology. No one can seriously and thoroughly investigate this occult science without becoming convinced that certain positions of the planets coincide with certain characteristics and events in the life of men.

No psychic sense is needed for such a demonstration. It is purely a matter of experiment. For if a certain angular relation of two planets coincides always with events of a certain nature, and enough birth-charts of persons having this position can be secured to prove it to be much more than a coincidence, no amount of theoretical argument can refute the facts.

Physical science is reluctant to accept such conclusions, or even to make the necessary experiments to verify them, because it has so far found no adequate theory to account for them. Isabel M. Lewis, of the U.S. Naval Observatory, writing in *Nature Magazine* for April, 1931, says: "It is doubtful, indeed, if any astronomer would know how to cast a horoscope or make astrological predictions of any kind." (See Course 17, *Cosmic Alchemy*, Chapter 6.) Yet these same astronomers, ignorant even of how to set up a birth-chart, freely pass judgment that astrology must be false because they have no theoretical grounds by which to explain it.

Alchemy may next claim the attention of our investigator. Although he knows it is stigmatized as an exploded science, he no longer accepts as final the dictum of a school he has found to be often prejudiced, a dictum, moreover, pronounced by men without knowledge of the subject they condemn. He finds that the two chief tenets of alchemy, as laid down by the ancients, are that there is a Primitive First Substance of which all physical matter is composed, and that it is possible to transmute one or more metals into another totally distinct metal.

Such ideas have been ridiculed by chemists until within the last few years. Now, however, it has been proved that all atoms are built up in a special way of particles of electricity, some negatively charged, others equally positively charged, all held

within a certain volume by the interaction of the attraction between the negative electrons and the positive positrons. Thus has electricity been demonstrated as the Primitive First Substance.

Furthermore, radium decays into helium and lead. Professor Ramsey has transmuted copper into lithium; and other scientists, through bombarding the atoms of one or two elements, much as radium bombards on its own, occasionally score a direct hit and smash out a piece of the nucleus of the element and thereby transmute each part into an atom of some other element. Thus the very theory and processes of alchemy, so long scoffed at by material scientists, have now been demonstrated in their own laboratories.

By methods as experimental as theirs, under conditions as strictly scientific, the Occult Scientist has demonstrated Magic, Astrology, and Alchemy. This makes him reluctant to discard any branch of occultism without first giving it a thorough investigation.

He approaches different methods of divination with, perhaps, a good deal of skepticism; but even in this he is surprised to find results that can not be attributed to coincidence, and he is forced to conclude that there are laws underlying such matters totally ignored by physical science. But then, he reflects, physical science has never determined the laws governing the source of the sun's heat. Every theory it has formulated to account for this phenomenon—and, for that matter, for numerous others—has been torn to shreds by later investigation. It is not astonishing, then, that it has failed to discover the mental laws governing divination.

But just as the true scientist finds the material sciences oppressed by many erroneous ideas and theories, so also he finds speculation and supposition so largely covering the facts of occult science that he can gain very little through reading the current works upon such subjects.

Mystical folly and absurd and conflicting doctrines meet him on every hand. Everyone whom he consults has an opinion, but usually quite unsupported by experimental facts. His only recourse seems to be to advance, step by step, applying the methods of experimental science to psychical and spiritual things, and so gain knowledge at first hand. He knows that to do this requires application, effort, keen discrimination and, finally, the development of the senses of the unconscious mind.

Although intuition and thought transference undoubtedly are activities or perceptions of the unconscious mind, because they so commonly reported the phenomena of the physical plane the ancients classified them as physical senses, along with the other five. But whether five or seven, the experience gained through these physical senses is the foundation of all knowledge of physical life.

The Seven Psychic Senses

—There are also seven psychic senses by which the phenomena of the world interior

to the physical are reported to the unconscious mind, and from thence may be raised into the region of physical consciousness. The experience gained through the use of these psychic senses is the foundation of knowledge of life on the inner planes. Nor are they so rare as to make this manner of investigation a practical impossibility; for more people than is generally supposed possess at least one of them in a more or less advanced stage of development.

The number is unknown because the ridicule that follows the announcement that one possesses such a faculty frequently deters people from making their psychic ability known. Nevertheless, even a little candid investigation will reveal the fact that such senses exist, and that by their use worlds other than the physical may be explored and understood, even as the physical world is explored and understood through the reports of the physical senses.

Moreover, even as the physical senses may be developed to a state of keenness and accuracy, so may the psychic senses be roused from their dormant condition and be educated to a state of efficiency.

In this education, either one of two methods may be followed. One is negative, mediumistic, passive and destructive to the individuality. It brings a train of evil results and should never be allowed. The other method is positive, controlling, active, and tends to build up the Will and Individuality, increasing the power of the mentality and bringing greater vigor to the body.

Psychic Senses Are Not Infallible

—This constructive method of training brings highly satisfactory results, and may be followed without danger. Moreover, as the psychic senses develop, their reports should be carefully analyzed and verified. They are yet immature, and as it took years after birth to educate the sense of sight so that it became a reliable guide to effort, it may take that long to develop psychic-sight, or any psychic sense, to a comparative degree of accuracy.

Most persons' psychic senses when first awakened are just about as accurate as were their physical senses immediately after birth. Consequently it is absurd to take the reports of these rudimentary faculties as indisputable. Yet they can be developed through exercise; and experience will indicate just how much reliability can be placed upon their reports.

It will be found that they often give information that later can be verified—such information as could not possibly be gained at the time through the physical senses. And as the reliability of the psychic senses increases they may safely be used to report the phenomena of the inner worlds. These reports may be checked, one against another, and compared with later experiences of those realms in such a way as to give the same certainty about the things of the inner worlds as may be had through the physical senses about the things of the outer world.

At a still later period of occult development, if the student has had the patience and ability to follow so far the royal road leading to initiation, it becomes possible to leave the physical body consciously and travel on a plane interior to the physical.

Means may be devised by which it is possible to prove with scientific certainty that this journey was an actual fact, and that the places thus visited were actually entered. When he makes such a journey, the student is able to say with certainty that there are inner regions, just as when he visits a city on the physical plane he is certain that such a city exists, and can describe it.

Immortality is more difficult of proof. Still, one who visits the homes of the dead and converses with them has ample assurance of life after death.

In our experience with the material world we have often found the instincts implanted by nature a better index to reality than reasoning from limited premises; so in this matter also we find our instincts a better guide than prejudice. Thus, instinct teaches animals to prepare warm dens for winter and stock them with food. They do not know of winter by individual experience, for they make this preparation for the first winter of life. Similarly, man instinctively looks for a future life and strives to prepare for it. The occultist, urged on by instinct, prepares for a life immortal, a life of never-ending progression; and by the development of his individual faculties explores its realms, and while yet on earth gains knowledge of its laws.

We repeat that the data upon which occult science rests is purely experimental, and even as in physical science it is necessary to form a hypothesis as a working basis, so also in occult science certain working hypotheses are essential. But occult science does not stand or fall by the correctness of theories any more than does physical science.

For example, the science of chemistry was founded upon Dalton's Atomic Theory, until recently universally accepted. But with the explosion of that theory which so long served as a working hypothesis for all chemists, and the adoption of the Electronic Theory in its stead, chemistry does not fall.

Neither does the disproof of any prevalent occult theory seriously affect occultism. Its truths are based upon observed phenomena carefully checked and compared. Yet when some ideas not sufficiently checked and confirmed are admitted to the edifice, they can be removed or improved without destroying the whole structure.

We Make No Claim to Infallibility

—Every science and every religion of the past which has claimed infallibility has lived to see such claim disproved. In the very nature of things, as I trust I have clearly shown, any claim to infallibility is absurd; because knowledge of the universe is endless and the evolution of intelligence is toward the acquisition of more and more knowledge.

Nor are we attempting to get our ideas accepted on faith. On the contrary, we indicate to the student just how to go about it to develop his own intelligence and his own psychic faculties, and earnestly advise him to disprove or verify every statement we make by experiments of his own.

Most religions teach that there is a life after death. But they discourage any attempt to prove such an existence. We, THE CHURCH OF LIGHT, however, believe that painstaking research should be carried out on every possible plane, and in all departments of nature, including those physical and those spiritual, to the end that man may not merely believe, but may know, the conditions under which he is required to live in each distinct realm, that he may utilize the laws and principles so discovered to be successful, in the larger sense, wherever he may function.

Physical life is but a fragment of that total life which is man's inheritance. The more knowledge we have of the laws of the physical plane, including occult laws, the surer our chances of physical success. Physical success is not to be ignored.

But we must also, if we are to have a basis for success in our life in its vaster scope, acquire a knowledge of the laws governing other planes. The more comprehensive our knowledge, the better we are fitted to adjust ourselves to the demands of this wider life. It is this knowledge that THE RELIGION OF THE STARS attempts to furnish.

These lessons make no claim to infallibility. They do, however, present the present views of those on various planes, including the physical, who anciently or in modern times, have been specially qualified for, and have carried out, research on every available plane. They are offered to students, therefore, not as the final word after which nothing more can be said; but drawing from high intelligences on various planes, as the best information available at the present moment of evolution.

Notes

1. William Boultong, Giordano Bruno, His Life, Thought, and Martyrdom (Salem, NH: Ayer, 1914/1972) .
2. Charles A. Young, A Scientific Book of General Astronomy for Colleges and Scientific Schools, p. 307 (Boston: Ginn, 1888).
3. Sir George Darwin, Tides and Other Kindred Phenomena, p. 161, 188 (Boston: Houghton Mifflin, 1898).

Chapter 2

Serial No. 40
Original Copyright 1926
Elbert Benjamine

Copyright
Church of Light
August 2002

Astral Substance

Chapter 2

Astral Substance

PHYSICAL science has now moved to a position where it fully endorses the dictum of the old alchemists that all existence is composed of the “first matter.” Mass and energy are convertible, each into the other. To quote from *The Evolution of Physics* (1938), by Albert Einstein and Leopold Infeld: “Mass is energy and energy has mass. The two conservation laws of mass and energy are combined by the relativity theory into one, the conservation law of mass-energy. ” The conversion of matter into energy provides a tremendous force which, as so-called atomic energy, may in the future be used to destroy much of mankind, or harnessed by industry may provide many necessities and luxuries of a new and higher civilization.

In addition to matter, which is one aspect of energy, physics also must deal with field. There are, for instance, the gravitational field between material particles, and electric fields and magnetic fields. To quote further from *The Evolution of Physics*:

Field represents energy, matter represents mass. . . . We could therefore say: Matter is where the concentration of energy is great, field where the concentration of energy is small. But if this is the case, then the difference between matter and field is a quantitative rather than a qualitative one. There is no sense in regarding matter and field as two qualities quite different from each other. We cannot imagine a definite surface separating distinctly field and matter. What impresses our senses as matter is really a great concentration of energy into comparatively small space.

The energy thus concentrated has the properties of positive and negative charges of electricity. The positive electric charge, or particle, having a mass equal to that of the electron, and a charge of the same magnitude but differing in sign, is called a positron. The negative electric charge, or particle, having a mass equal to that of the positron, and a charge of the same magnitude but differing in sign, is called an electron. These two electrical particles are the bricks from which all matter is built.

A positron and an electron when united have weight, but are electrically neutral. The prevalent theory at the present time is that the nucleus of an atom contains heavy neutral pieces of matter, formed by the union of positrons and electrons held together by the interaction of the attraction between the negative electrons and the positive

positrons—about 1848 units of weight—tied up closely with a positron whose weight is one unit and whose electrical charge is plus one. Such a combination of positive and negative charges constitute a proton. All atoms of matter have at their core one or more proton.

In 1932, Chadwick discovered that in addition to protons at the nucleus of an atom, there may be other particles built up of positrons and electrons much as are the protons, but containing an additional electron, so that they are electrically neutral and weigh 1849 units. These are neutrons, which because they bear no electrical charge, when they are used to bombard other atoms easily penetrate to their nuclei. Atoms having the same number of free electrons, and thus the same chemical properties, may have in their nuclei a different number of neutrons, and thus a different atomic mass. Such atomic twins are called isotopes.

The positive charge on the proton of an atom is balanced by the negative charge on an electron which revolves in an elliptical orbit around the nucleus of which the proton forms a part. Each atom has an equal number of protons and free revolving electrons, and thus is electrically neutral.

The electrons that revolve around the nucleus of an atom—which contains protons and may contain neutrons—much as the planets revolve around the sun, are arranged in zones. There are not more than two electrons revolving in the zone next to the nucleus, not more than eight in the second zone, and not more than eight in the third zone. Zones farther out may have more than eight electrons. It is the arrangement of these revolving electrons which determines the chemical properties of an atom.

Although two of the chemical elements had not been isolated until 1947, the atomic table listed 92 different elements. Hydrogen, the lightest element, and number 1 in the table, has 1 free electron revolving in an orbit about its nucleus. The next heaviest element, helium, has 2 free electrons revolving around its nucleus; lithium, the third heaviest has 3; beryllium, the fourth heaviest element has 4, and uranium, the heaviest element found in a natural state, with an atomic weight of 238.5, has 92 electrons revolving in its outer region. The synthetically produced neptunium has 93, the synthetically produced plutonium has 94, the synthetically produced americium has 95, and the synthetically produced curium has 96.

By bombarding ordinary uranium with neutrons it is possible to produce neptunium and plutonium. Plutonium and the uranium isotope U235 have a tendency to fission. Bombarding ordinary uranium (U238) gives the uranium isotope U239 plus energy. This isotope is radioactive, and one-half the quantity thus obtained will change into neptunium in 23 minutes. Neptunium is also radioactive, and one half of it will then change into plutonium in 2.3 days. In the fission of either uranium 235 or plutonium, a chain reaction results through the release of other neutrons which bombard other nuclei. Once the process is started it continues until the whole mass is broken down into other elements. The sum of the separate weights of the resulting particles is different than the weight of the parent particle. This means that matter is converted into energy. In the explosion of U235 or plutonium, only one-tenth of one per cent of

matter is thus converted into what is commonly called atomic energy. The problem at this writing is to find a method of controlling the fission of plutonium, so its energy may be released slowly and provide power for the wheels of industry.

In addition to field, where energy concentration is so great that it is commonly called matter, science has observed that energy moves across vast regions of space and exerts an influence. Just how the sun holds the earth in its orbit, and with the moon influences the tides, has so far not been explained. The law of gravitation discovered by Newton states that any particle of matter attracts any other particle with a force proportional inversely to the square of the distance between them, and directly to the product of their masses. But the process by which one particle thus reaches out across space, or through some material obstacle, to attract the other particle is as yet unknown.

Not only do the sun, planets and stars reach across empty space to influence the earth and other orbs through gravitational pull, but they radiate light and radiant heat and other forms of electromagnetism which in some manner traverse vast space. How does the sun reach across 93 million empty miles to light our days? How does its warmth traverse 93 million miles to keep earth's temperature genial enough to encourage vegetable and animal growth?

To account for these and other electromagnetic phenomena science invented the ether. The ether was frictionless, it penetrated everything. It sheared into positive and negative electrical particles. It carried, by means of its waves, radiant heat, light, radio waves, and other electromagnetic energy across space, and in the case of radio waves through the walls of your home where they are picked up and the modulations they carry are amplified by your radio set to give you information and enjoyment.

The tendency of advanced physics now is to forget the ether and try to explain all phenomena, including matter, gravitation and electromagnetic waves in terms of field. All are supposed to be characteristic distortions of space. Space takes the place of the ether. However, this new conception still holds unsolved problems. To quote once more from *The Evolution of Physics*:

“The theory of relativity stresses the importance of the field concept in physics. But we have not yet succeeded in formulating a pure field physics. For the present we must still assume the existence of both: field and matter.”

It is not unlikely that in due course of time radio waves will be commonly mentioned as distortions of space. But in common parlance radio programs come over the ether.

Not only so, but recent text books on physics still refer to the ether. The most recent such text book to which I have access is *Simplified Physics*, by Sidney Aylmer Small and Charles Ramsey Clark, published in 1943. It gives the prevailing present view:

When things take place in presumably empty space we must assume that empty space is not empty, that a vacuum has something in it. To this material that our senses cannot detect but that our intellects demand in order that we may think about light and wireless we give the name of the ether or simply ether.

The ether, then, is something pervading all materials and space, even that space which to our senses seems empty. It transmits heat, light, chemical energy and wireless waves. It when stressed or strained produces magnetism and when sheared (sliced) forms positive and negative charges of electricity.

Because electromagnetism transmits energy from the outer-plane to the inner-plane, and from the inner-plane to the outer-plane, the ether will repeatedly be referred to throughout Brotherhood of Light lessons. It would be awkward each time to speak instead of distortions of space, and confusing to most readers who are unfamiliar with relativity and the field theory. But the reader who is familiar with relativity and the field theory can substitute certain warpings of space when etheric energy is mentioned, and different warpings of space when astral substance is mentioned. And his conceptions will probably be more precise. But for most it is easier to think of matter, not as space distorted in one way, radio waves as space distorted in another way, and the mental image of a cow as space distorted in still another manner. It is much easier for the ordinary individual to think of any existence in terms of substance.

Even the relativists and those most enthusiastic about the field theory of existence still sanction the use of the word ether as it will be employed in Brotherhood of Light lessons. To quote once again from *The Evolution of Physics*:

Our only way out seems to be to take for granted the fact that space has the physical property of transmitting electromagnetic waves, and not to bother too much about the meaning of this statement. We may still use the word ether, but only to express some physical property of space. The word ether has changed its meanings many times in the development of science. At the moment it no longer stands for a medium built up of particles. Its story, by no means finished, is continued by the relativity theory.

The most essential difference between that which is commonly referred to as etheric energy and physical energy is its velocity. Things having low velocities have the properties of physical things. But as velocities increase these properties undergo marked change. As velocities increase time slows down, the length of an object decreases in the direction of its movement, and its mass increases. These results postulated by the Special Theory of Relativity have been tested experimentally and are now universally accepted by those highest in the ranks of physical science.

At the velocity of light an object or an energy acquires some remarkable properties. Commonly, for instance, the walls of our homes keep objects out; but radio waves having their origin a thousand miles away have no difficulty in coming into the room in which we sit. In empty space they have the velocity of light, 186,284 miles per second (1942).

But there is another group of commonly observed phenomena which cannot be explained either by the properties of physical substance or by the properties of electromagnetic energies. Scientists term these the psi phenomena. Psi phenomena embrace all the phenomena covered by the terms extra-sensory perception and all the phenomena covered by the term psychokinetic effect.

Extra-sensory perception embraces all means of acquiring information in which the physical senses or reason are not involved, such as clairvoyance, clairaudience, telepathy, precognition and postcognition. The psychokinetic effect, or psychokinesis, embraces those phenomena in which physical things are moved or influenced without any physical or electromagnetic contact with them. The influencing of mechanically released dice to come to rest with the faces up which had been decided upon, which is the test commonly used in university experiments to prove the existence of this phenomenon, and the influence of planetary energies over human life and other life are examples of psychokinesis. All psi phenomena are due to inner-plane energies.

It was the Special Theory of Relativity, followed to its practical and logical conclusions which led to the discovery of releasing and utilizing atomic energy. And it is this same Special Theory of Relativity followed to its practical and logical conclusions which indicates both how inner-plane energies operate and what can be done to cause them to work more to the individual's advantage.

This theory postulates that at the velocity of light an object loses all its length, time stands still, and gravitation loses its power. Therefore, on the inner-plane where velocity is greater than light, time, distance and gravitation are of a quite different order than they are on the physical plane. And innumerable experiments carried out in various universities prove that this is actually the case.

By 1947, Duke University Laboratory alone had conducted over one-million trials of extra-sensory perception; other university laboratories, following similar methods had reported over two-million trials, and there were something over a million trials, with responses from over 46,000 subjects made by the Zenith radio program in the winter of 1937-38.

These experiments indicate that, as the Special Theory of Relativity carried to its logical conclusion indicates, on the inner-plane where velocities are greater than that of light, not only the Now can be perceived, but consciousness can move either forward or backward along world-lines. Moving backward, it can perceive happenings of the past. Moving forward it can perceive happenings of the future.

One of the serious difficulties now confronting university experimenters is to devise methods by which precognitive clairvoyance can be separated from pure telepathy. It is recognized that perceiving things as they will exist in the future is relatively common. Therefore, if a record is made of the sender's thought at the time the subject makes his call, there is no proof that the information was not obtained through clairvoyantly seeing this record, rather than through telepathy. And if any objective record is ever made of the sender's thought after it is sent, there is no proof that the information was not obtained through perceiving this record as it will exist in the future.

The university experiments indicate also, as the Special Theory of Relativity carried to its logical conclusion indicates, that distance has no effect upon inner-plane perception. Both clairvoyance and telepathy experiments indicate that, other things

being equal, it is as easy to get a telepathic message, or to witness an event clairvoyantly, when the distance is a hundred miles or a thousand miles, as when the distance is only that separating two rooms in the same building.

Furthermore, as the Special Theory of Relativity carried to its logical conclusion indicates, on the inner-plane where velocities are greater than that of light, gravitation loses its influence on things. Along with the experiments on extra-sensory perception, various universities have been conducting experiments also with the psychokinetic effect. And they have proved by exhaustive experiments that the mind, operating through space, can influence physical objects, such as the fall of mechanically released dice, in a predetermined way.

The mind and thoughts of the individual exerting this influence are not physical. They belong to the inner, or astral, plane. If one thinks of a cloud or of a star, no effort need be made to overcome the influence of gravitation on the thoughts. Nor does it take longer to think of a star which is light-years away than to think of a cloud a few hundred feet above the earth. Yet mind and thought have an existence, and possess energy, or they could not influence physical objects, such as the fall of dice in the psychokinetic tests.

Although the field conception of electromagnetic energies is making the old conceptions of the ether obsolete, it is convenient to refer to ether waves in connection with both light and radio. And if the field conception could be carried far enough, it would probably reveal that mental images, astrological energies, disembodied human beings, and the high velocity counterparts of all physical things, are other elastic distortions of space. But because people are familiar with substance, and are not familiar with elastic distortions of space, they will be able to grasp the function of electromagnetism better if they think of it as lines of force or waves in etheric substance. And they will be better able to grasp the functions and the properties of the inner-plane, where velocities are greater than light, if they think of that region as being composed of astral substance, which is frictionless and which penetrates and moves freely through physical and etheric substances.

This brings us to an extremely important fact confirmed by ample observation. For an inner-plane energy to influence a physical object, or for a physical energy to influence inner-plane conditions, electromagnetic energies—which have approximately the velocity of light—must be present to transmit the energies of one plane to the other. Such electromagnetic energies are generated by every cell of the body, especially by the nerve and brain cells, and constitute both the nerve currents and the life of the human form. All psychic phenomena in which there are physical manifestations are produced through the utilization of electromagnetic energies by an intelligence operating from the inner-plane.

Even the most orthodox psychology now embraces the idea that man has a subconscious, or unconscious mind. This unconscious mind, which exists and functions on the inner-plane, is composed of the thoughts, emotions and other states of consciousness which the individual has experienced in his past. These thoughts,

energized by emotion, have been organized in the unconscious mind according to the Law of Association. And, as modern psychiatry and psychoanalysis demonstrate, at all times they exercise a powerful influence over the conscious thoughts, emotions and behavior.

Not only do the desires of the thought-cells and thought-cell groups of the unconscious mind largely determine the individual's thoughts, emotions and actions, but they also exert psychokinetic power to mold his physical environment to bring into his life the conditions and events they desire. The events and conditions some of these thought-cell groups desire are beneficial to the individual, but unfortunately the desires of other thought-cell groups are for conditions and events which are detrimental to the individual.

So long as the individual is unaware of the desires of the various thought-cell groups within his unconscious mind his power to direct his own destiny is sadly limited. Even though he has a brilliant intellect and exercises excellent reasoning power, the desires of certain groups of thought-cells within his unconscious mind, exercising psychokinetic power may, and often do, attract into his life misfortune. Some of the thought-cell groups may have been so organized in his unconscious mind that they work for, and bring him unusual good fortune where business, or honor or speculation is concerned, and other thought-cell groups may have been so organized that they work for, and bring him miserable health, unhappiness in marriage, and repeated difficulty with his friends.

All Physical Things Have an Astral Counterpart

—Even as all physical objects possess mass, so also do they have an astral, or inner-plane, counterpart. As material scientists are not agreed on the structure of matter, it would be presumptuous to go further and describe in detail that of which things on the inner, or astral, plane are composed. It is simpler merely to state they are composed of astral substance, and to state the observed properties of this substance.

While all physical things have an astral counterpart, there are innumerable objects, energies and intelligences on the astral plane which have no physical counterpart. So long as the astral counterpart of any object is bound to it by etheric, or electromagnetic, energies there is an exchange of energies between the physical counterpart and the astral counterpart. The energies having approximately the velocity of light make contact with the low velocities of physical substance and also make contact with the high velocities of astral substance. Through them the physical object transmits energy to, and influences, its astral counterpart, and the astral object transmits energy to, and influences, its physical counterpart.

While the physical also tends to shape the astral counterpart, the most significant relation which commonly exists between physical substance and its astral counterpart is that the astral interpenetrates and has a molding power over the

physical.

This astral counterpart also records and retains in its frictionless substance every experience of a life-form. The most outstanding characteristic of astral substance is its responsiveness to the molding power of thought. All life-forms react to environment through an awareness which is recorded in their astral forms. And this record of experiences not only persists and continues to influence the destiny of the life-form, but the strongest such recorded energies impress the astral counterpart of the germ cells, and through this association hand down to subsequent generations racial memories which express as instinct and racial habits and racial physical characteristics.

The astral counterpart exerts a formative influence over all life. It seems quite certain, for instance, that the force which causes a seed to grow into an organism of a certain form and with certain functions does not lie merely in its chemical properties. Nor does it appear to lie in any particular arrangement of its cells; for two vegetable seeds of the same size and apparently of the same chemical and molecular composition, when planted in the same soil may produce plants whose forms and properties are totally dissimilar. Likewise there is very little observable difference in the chemical composition and molecular structure of sperms and germs that generate animals of entirely different species. Though as yet beyond the view of physical science, this formative power that molds every living thing to its proper shape and structure must lie somewhere.

It is now commonly recognized by psychologists that all memory resides in the subconscious, or unconscious mind. This means that memory is recorded in astral substance, and to be recalled by physical consciousness it must utilize electromagnetic energies to impress the physical cells of the brain.

Every theory based upon a material foundation that has so far been advanced to account for memory has been found inadequate. But if we consider that accompanying and interpenetrating the physical brain is another brain of finer substance, an astral brain, the whole mechanism becomes explainable.

Anything Once Known is Never Forgotten

—We know something of the way physical sensations are transmitted to the physical brain, namely, by nerve currents that follow the nerves much as electricity follows a wire. These nerve currents actually are electrical in nature and communicate movements to the brain that result in setting up a state of consciousness. But such motions in time die away; yet memory shows that in some manner they are preserved. What preserves them, and how? The sensations thus recorded on the physical brain may be entirely forgotten for years—showing that the motions in the physical brain have ceased—and then be suddenly recalled. How does this happen? Or sensations may be completely forgotten by the objective consciousness, and

entirely beyond recall by any objective process, yet be recovered when the person is in a state of hypnotic trance.

It is by experiments with subjects under such hypnotic influence that we know nothing felt or known is ever forgotten. What substance is fine and strong enough to preserve the most delicate impressions for an indefinite period? Scarcely the nerve currents, which are constantly changing, rippling along the fine wires of the nerves and hurrying one sensation on top of another as a telephone wire carries the sound of voices. The telephone does not remember; the phonograph, in a way, does. Connect the telephone to a phonographic blank disc and the impressions made are comparatively permanent. What is the phonographic disc attached to the human brain? It is evident that the motions transmitted through the nerves to the brain are retained permanently in some substance which is capable under proper conditions of again imparting them to the brain in something closely resembling their original form and intensity. Whatever this substance may be, it certainly is something not subject to physical or chemical change.

But if we consider that accompanying and interpenetrating the physical brain is an astral brain, composed of frictionless substance with the property of permanently recording impressions, the matter is cleared up. As every motion imparted to astral substance is retained indefinitely, every sensation which imparts motion to the astral brain is registered in a comparatively ineffaceable manner. It is not retained by the physical brain, because the physical substance is constantly removed and replenished, and any movement in its parts is retarded by friction, even its molecular motion, which expresses as heat, being subject to retardation through cooling. But even as space offers imperceptible resistance to rays of light, or to the planetary bodies passing through it, so astral substance retains permanently, or practically so, all motions imparted to it. Under proper conditions these motions residing in the astral brain can be focused on the electromagnetism of the physical brain and impart motions to it in such a manner that it is recognized objectively; and the resultant consciousness is then called memory.

The astral brain in which memory resides is commonly called the Subjective Mind, the Subliminal Mind, the Subconscious Mind, or the Unconscious Mind. The better and more recent works on psychology call it the Unconscious Mind. It is constituted of those motions derived from experience that reside—organized in a manner later to be explained—in the astral form and do not at the time transmit their motions to the physical brain, remaining below the threshold of objective consciousness; while the Objective Mind, on the other hand, is constituted of those motions derived from experiences that reside in the astral form which at the time are able to communicate their energies to electromagnetism in sufficient power to transmit their motions to the physical brain and thus impress Objective Consciousness.

As an iceberg largely remains submerged below the surface of the sea, so man has one mind, or soul, but the major portion of it, the unconscious mind, remains below the surface of objective consciousness. It is only that small, keen, bright clever reasoning peak of his mind, or soul, which emerges above the surface of objective

consciousness which is designated as the objective mind.

Psychologists recognize that comparatively few of the actions of man or of other forms of life result from the direction of the objective mind. Many of the physiological processes, for instance, such as assimilation, secretion and circulation, are carried on during sleep. They are wholly directed by the unconscious mind. And the unconscious mind in turn is influenced about equally by the physical environment and the astral environment.

Man is About Equally Influenced by Two Environments

—Man has a physical body, and he has an astral body. The physical body, and through its nerve currents, which are electrical in nature, his mind, or soul, which resides on the inner-plane—the small emergent part being the Objective Mind and the submerged part the Unconscious Mind—are influenced by his outer-plane environment. His astral body and his mind, or soul, are influenced by his inner-plane environment; and the thought-cells so affected in turn influence his physical body. Thus does man live in, and is influenced by, both an outer-plane world and an inner-plane world.

From the outer world he is influenced by the objects and people he contacts, by what people say—either vocally or through screen portrayal or the printed page—and by the weather. Objects and people also influence him from the inner-plane, but instead of through physical contact chiefly through their character vibrations. From the inner-plane he is also influenced, not by what people say, but by their thoughts and the thoughts of other life-forms. From the inner-plane he is also influenced by the weather; but this weather is not physical, it is the impact of astrological energies.

As to the degree in which man while still on earth is influenced by each of his two environments, there has been a vast amount of observation, carefully checked, which indicates that if we consider man to consist of his physical body, his astral body, his mind, or soul, and the thoughts he thinks, the inner-plane environment—which includes objects, the actions and thoughts of intelligent entities, and astrological energies—has as much influence over his thoughts, feelings and behavior as do all outer-plane conditions and energies, including the influence of his associates.

This being true, it behooves people to gain as much knowledge as possible about their inner-plane environment in addition to knowledge of the outer-plane environment. While they usually think of it in different terms, almost everyone realizes that his survival depends upon his ability to adapt himself to his environment, and that the more perfectly he adapts himself to his environment the more successful he becomes. His ability to adapt himself to his environment depends upon his knowledge of himself and that environment and the extent to which he makes application of that knowledge. Consequently, the individual ignorant of the astral world and its energies can live only half as successfully as if he understood and

used knowledge of both planes.

Inner-Plane Senses

—Relative to physical sensations, biologists hold that at first there was only one diffused primal sensitivity or irritability in response to stimulus. It is assumed that this diffused primal sensitivity was the sense of touch. In ameboid life, for instance, it is assumed that there is only the world of tangible objects accessible through actual physical contact which is apprehended through the sense of touch and possibly a rudimentary sense of temperature. Then as evolution took place, through a vast amount of trial and error, the other senses slowly and gradually developed from this sense of touch. Taste is one specialization of this sense of touch. Smell is the sense of touch developed in a slightly different direction so that things can be touched a bit more remotely. Another canalization of this sense of touch is the ability to apprehend and interpret vibrations of air by the faculty of hearing.

It is common also to include the sense of sight as one of the five physical senses. It is the ability to sense and interpret waves of energy called light. But as light is not material, strictly speaking the ability to reach out, not merely feet or miles as with the sense of hearing, but also across light-years of empty space, as we do with sight, is hardly physical unless we interpret all common perception as physical. In that case, because animals commonly apprehend conditions through intuition, and telepathy is a common means of communication among them, we are justified in adopting the classification of the ancients and considering all seven as physical senses.

As already mentioned, university experiments have proved the existence also of an inner-plane faculty of apprehending information. It is called the faculty of extra-sensory perception. It embraces all inner-plane means of gaining information. And undoubtedly animals other than man possess this faculty in some degree.

But even as the diffused primal sense of touch became canalized and specialized, so extra-sensory perception by which the unconscious mind of creatures apprehends things on the inner-plane, through exercise and effort at discrimination becomes specialized and more serviceable. We may assume that this sensitivity to inner-plane entities and their vibrations, to the thoughts of intelligent entities, and to astrological energies is universal in some degree with life-forms. But ability in selection and interpretation of inner-plane conditions by this universal sense varies widely.

An artist may take his dog to an art gallery. If it happens to be a greyhound, it has keener sight than its master. The dog can see all the pictures in the gallery as easily as can the artist. But the effect upon his consciousness is vastly different. The dog simply sees flat surfaces daubed with color. If a bone is pictured, he pays no attention to it. He has neither the power to select a picture which conveys information or emotional appeal, nor the power to give it interpretation.

Nor is it because they cannot look about them on the inner-plane with the senses of

the astral form that people fail to gain more information through extra-sensory perception. In some degree at least all people have the faculty of extra-sensory perception. But more often than not they cannot focus the attention of their unconscious mind on the information sought, and even when they do they often are unable to interpret it correctly. And in addition—the most formidable barrier of all—when their unconscious mind perceives something important correctly, it is unable to compete with cerebral activity and sense impressions which monopolize the electrical energies of the brain and nervous system which must be used to impress a thought or sensation on the brain and thus bring it into objective consciousness.

Even as on the physical plane the general sense of touch has been specialized into different types of perception, so also on the inner-plane the general extra-sensory faculty has been specialized. Corresponding to touch is the astral sense of psychometry. Corresponding to taste is the astral sense of energy absorption. Corresponding to smell is the astral sense of aroma detection. Corresponding to hearing is the astral sense of clairaudience. Corresponding to sight is the astral sense of clairvoyance. Corresponding to intuition is the astral faculty of inspiration. Corresponding to telepathy is the astral faculty of spiritual communion.

On the inner-plane all things and thoughts in the universe seem to be related to each other in precisely the same manner that all experiences and thoughts which the individual has ever had persist and are related to each other in his own unconscious mind. And for the individual to contact those he desires to contact with the appropriate astral sense and bring them before the attention of objective consciousness the same laws are operative and must be used that enable him to contact and bring to the attention of objective consciousness the memory of thoughts and experiences he has forgotten.

In Course 5, *Esoteric Psychology*, it is pointed out that all mental processes are governed by the LAW OF ASSOCIATION. Among the most powerful associations by Resemblance is that of identical or similar resonance. This is the key to making contact with things or thoughts, past, present or future, on the inner-plane; for there thoughts and things having the same vibration are together. Distance on the inner-plane is of a different order than in the physical world; there it is measured by disparity in vibratory rates.

On the physical plane the visibility of things and the audibility of sounds diminish with distance, and thus the number of objects it is possible to see or the number of sounds that can be heard is narrowly limited. But virtually all experimenters in ESP are agreed that distance has no effect on extra-sensory perception. That which is on the other side of the earth is as easily seen as that which is in the same room, and the thought of a person on the other side of the earth is as easily apprehended as the thought of a person in the same room. If the pronouncements of university scientists who have experimented exhaustively with extra-sensory perception are to be taken seriously, nothing in the universe is beyond the range of extra-sensory perception, and thus the number of things which it is possible to see clairvoyantly is infinite.

Furthermore, on the inner-plane time is of a different order, and consciousness can direct its attention either forward or backward and by means of the appropriate astral sense perceive objects, life-forms and thoughts as they existed in the past or as they will exist in the future.

These are the potentialities of the astral senses; potentialities meagerly employed as yet by man on earth. But for that matter man has only recently begun to utilize the potentialities of his own outer-plane senses and reason. Potentially they make accessible incalculable knowledge of physics, chemistry and electricity; yet it is only in late years we have used them to acquire that knowledge on which is founded modern science and industry.

Most people, however, at some time in their lives, have observed authentic instances of the operation of one of the astral senses. Spontaneous information has come to them, or to one of their acquaintances, in a manner that precludes its acquisition through reason and the outer-plane senses. And there are others, usually unaware of the source or manner of their inspiration, who employ their astral senses in making contact with information on the inner-plane, and bring this information up into objective consciousness in the course of their creative work. These are the people to whom we apply the title genius.

All genius draws upon information acquired by its unconscious mind which is less accessible to the objective minds of others. Whether it is the great poet, the great artist, the musical prodigy, the mathematical wizard or the most outstanding personalities in science and invention, they each and all, as their biographies reveal, either in dreams, in states of exhaustion resulting from concentration on their problems, while in semi-reverie, or other states which favor the unconscious impressing the information it has gained on the brain, have experienced uprushes from the unconscious mind which have given them knowledge or ability beyond that of those to whom the term genius cannot be applied.

While those who train their psychic faculties, and those who have outstanding spontaneous extra-sensory experiences, usually know the information is coming through from the inner-plane, most people are unable to distinguish between their normal thoughts and opinions and those derived from extra-sensory sources. In the university experiments it is reported that those who give good performances are unable to determine at the time whether extra-sensory perception is operating and therefore whether or not what they are doing is directed by anything but chance. Even of those who employ extra-sensory perception most successfully, it is only the rare individual who can be sure when he is or is not using it.

But merely the ability to employ the astral senses does not confer genius. Genius must have a brain which can, and does, utilize the information and power which uprushes from the unconscious. It requires the harmonious co-operation of the Unconscious Mind and the Objective Mind.

Personal Survival After Death

—As demonstrated under hypnosis and in psychoanalysis, nothing known by the individual is ever forgotten. His experiences, including his thoughts and the expression of personal traits, are organized and retained in frictionless astral substance. That this inner-plane organization, which expresses as an identifiable personality, survives beyond the tomb is attested by a vast and steadily increasing mass of evidence, as set forth in the writings of Dr. John King, Sir Oliver Lodge, Sir Arthur Conan Doyle, Rev. G. Vale Owen, J. Arthur Hill, Horace Leaf, Ella Wheeler Wilcox, W. T. Stead, Dr. A. D. Watson, William O. Stevens, Stewart Edward White, and a score of others.

Those who have passed to the inner-plane may, or may not, have acquired information of value. In psychic work, when information comes through in a continuous stream of intelligence, one may be sure it is coming from some inner-plane entity. It is the opinion of this inner-plane entity which is being received. When information arrives in messages which are continuous, they are not merely the conclusions of the individual himself derived from his own inner-plane observations. Conclusions reached by the unconscious from its own inner-plane observations, and information acquired through the independent use of its astral senses, do not come through as a continuous stream of intelligence, or a well formulated message, but as uprushes from the unconscious, as flash after flash of relevant information, which only when pieced together gives complete knowledge of the matter about which knowledge is sought.

Chapter 3

Serial No. 41
Original Copyright 1923
Elbert Benjamine

Copyright
Church of Light
August 2002

Astral Vibrations

Chapter 3

Astral Vibrations

IT is common knowledge that the energy of all life on earth is transmitted across space from the sun. Furthermore, we are also taught that all physical bodies exert a gravitational influence upon all other physical bodies independent of whether or not there are other physical bodies between them. Then again, energy is propelled to far distant points by radio. Yet in spite of the general recognition of these facts the great scientific men of the world are quite unagreed as to the nature of light, gravitation and radio. How then am I to explain still another form of energy which, like that commonly recognized as coming from the sun, has a wide variety of influences, like gravitation is unhampered by passing through obstacles, and like radio is capable of conveying intelligence? Such a form of energy is astral vibration.

Not so long ago scientific men were agreed that light is the ether moving in transverse waves. But even as the chemistry of the nineteenth century has been displaced by entirely new conceptions, so we find physics and mechanics and geometry also in the throes of revolution. This started with the apparent verification of Einstein's Theory of Relativity by the eclipse observations of May 29, 1919, and September 21, 1921. And it has been gaining momentum since through this theory's apparent verification by all the experiments that thus far have been devised to test its validity.

It may be pointed out that the test of any theory is its ability to predict new phenomena and to correct all known phenomena in the field which it covers. Einstein's Special Theory of Relativity may ultimately fall, just as the recently accepted theories of chemistry, those of geometry, those even of mechanics, as well as those of biology have fallen in the face of new discoveries. But at the present moment Einstein's Special Theory meets the above mentioned tests better than any other advanced in the realms of mathematics and physics. And in the same manner the theory of astral substance and astral vibration covers the field of biology, astrology and psychic phenomena better than any yet set forth. No other theory has been forthcoming satisfactorily to explain a mass of carefully collected astrological, biological and psychological facts.

The theory of astral substance and astral vibration, however, does adequately explain all the known facts of astrology, of psychic phenomena, of biology and of psychology. And at the same time in each of the sciences mentioned it has been able

to predict new phenomena, such as, for instance, the influence of certain positions of Uranus, Neptune and Pluto upon life before such positions had ever actually been observed, and the possibilities and apparent limitations of divination.

But it is not to be supposed that the theory of astral substance and astral vibration as here set forth may not in time need considerable revision to keep pace with new conceptions, such as that suggested in the final paragraph of Chapter III of *The Evolution of Physics* (1938), by Albert Einstein and Leopold Infeld; “The theory of relativity stresses the importance of the field concept in physics. But we have not yet succeeded in formulating a pure field physics. For the present we must still assume the existence of both: field and matter.” And while the astral field concept may take precedence in the future, for the present we must continue to speak both of astral substance and astral vibrations.

This pure field concept relates to Einstein’s General Theory. The Special Theory of Relativity, which is now taught in most universities as fundamental to understanding physics does not make it a necessity. And as we will have repeated occasions to refer to this Special Theory of Relativity, its present standing in university circles should be established. For this purpose let me quote from an article by H. P. Robertson, Ph.D., Professor of Mathematical Physics, Princeton University, which appeared in the June, 1939, issue of *Scientific American Magazine*:

In view of these developments one may say that at present the special theory of relativity is one of the most thoroughly accepted and most firmly established doctrines of modern physics. It has permeated the field of mechanics, electromagnetism (including optics) and atomic physics; while it may appear desirable to have further direct checks on the validity of its mechanical aspects, a deviation from the predicted effects would constitute a most puzzling—and, at least temporarily distressing—jolt for modern physics.

This Special Theory of Relativity holds that physical velocities cannot exceed that of light, and that anything moving with a velocity of light no longer possesses length, has infinite mass and so is practically impervious to the pull of gravitation, and that for it time has come to a standstill.

According to Einstein, if a bullet could be shot from a gun with a velocity of 160,000 miles per second, due to its motion the bullet would shrink to about half its previous length. Yes, and we may add that if the same bullet could be shot from a gun with a velocity greater than light it would not only lose its length, but its other physical properties, and then exist as a bullet on the astral plane. Einstein’s assertion that nothing can move faster than light is true of physical things. But to cover all phases of existence it must be modified by the explanation that anything that moves faster than light is no longer physical, and therefore is not a thing according to Einstein’s conception—for it then loses all its physical properties and acquires those of the astral world.

The reason that light, radio and other electromagnetic phenomena present so many difficulties in the way of explaining their behavior, is that they have velocities

intermediate between those of slow-moving physical substance and fast-moving astral substance. And it is because the gap between the velocity of physical substance and the velocity of astral substance is too great to bridge, that the inner-plane world affects the outer-plane world, and the outer-plane world affects the inner-plane world only through first imparting motion to electromagnetic energy which has a velocity intermediate and thus can be directly influenced by, and directly influence, both the low-velocity and the high-velocity regions.

But when we speak of velocities, we must not confuse these with frequency of vibration; although when vibratory frequencies of low-velocity physical substance become high enough they are able to influence electromagnetic energies, and when electromagnetic energies have certain frequencies they are able to influence the high-velocity astral world.

Vibratory frequencies of from about 16 per second to 30,000 per second—about 12 octaves—in physical substance can be distinguished by the human ear as sound. Death-dealing vibrations in physical substances of frequencies higher than those commonly employed in radio have been developed in laboratories; but they cannot be heard.

Those used in radio are not vibrations of physical substance. They are electromagnetic frequencies. Such as are used in commercial radio have frequencies of from 550,000 to 1,000,000 per second. The short and the ultra-short radio waves have frequencies considerably higher. But these Hertzian radiations are only the lower electromagnetic frequencies. Above them are the infra-red, or dark-heat waves. Light, which is about 45 octaves above sound, and is electromagnetic rather than physical, is next above the infrared. We can feel the sensation of heat for about two octaves and see the vibrations as light only for about one octave. Above visible light is ultraviolet radiation, which is sometimes called the chemical ray. Of higher frequency still are the x-rays, and the gamma rays are still higher. As all of these are vibrations in the Boundary-Line realm of velocities, they are referred to as different bands in the electromagnetic spectrum.

Now under certain conditions physical substance gains the power profoundly to influence electromagnetic energies: and under certain conditions electromagnetic energies gain the power profoundly to influence astral substance. For instance, when an iron is heated its molecules are given greater speed. They are physical substance. But when they attain a certain frequency of oscillation the iron becomes red hot or white hot and then radiates light, which is not physical, but an electromagnetic radiation.

A current of electricity moving over a wire develops a field of force about the wire. If it is an alternating current of low frequency, say of 60 cycles such as is commonly used in transmitting electricity for light and power, at each reversal practically all of the field of energy folds back on the wire. But under certain conditions the energy does not mostly fold back, but keeps right on going. The conditions are that the oscillations must be sufficiently frequent. When they attain sufficient frequency the

energy radiates, and we have waves such as are used in radio.

Furthermore, even as molecular vibrations, which are physical, when they attain certain frequencies are able to impart much energy to electromagnetic waves; and electrical energies, which are at least granular, moving over wires when given certain frequencies radiate non-physical energy into space; so electromagnetic energies generated in living organisms when given certain frequencies are able profoundly to affect energies of the still higher-velocity astral world.

And when astral-world velocities are attained, existence acquires properties that are contradictory to physical experience, but which are none the less consistent with what the Special Theory of Relativity demands when such velocities are present. Under these velocities time as we know it no longer exists, distance as we know it disappears and is supplanted by difference in vibratory frequency, gravitation gives way and its place is taken by the principle of resonance, and instead of mechanical power thought-energy performs many similar functions. These new properties of existence, displacing those with which we are so familiar on the physical plane, permit of various conditions that contradict material experience.

Now all of this, I am well aware, may seem to some highly technical. But it is a necessary prelude, in view of latest scientific opinion, to any adequate discussion of astral vibration. And it leads up to a consideration of astrology.

It may be thought that in the third chapter of a course designed to lead the student by easy and systematic steps from complete ignorance of such subjects to a grasp of those fundamental principles which it is advisable to know before attempting the detailed mastery of the various occult sciences, that the subject of astrology is out of place. This is not the case, however, and the student will find that the sooner he grasps the general significance of astrology the quicker and the easier will he be able to master the whole range of the occult.

This is true for two distinct reasons. One is that all life is constantly being influenced by unseen currents of energy radiated by the planets. Consequently, the precise effect of any other occult force at any given time cannot be known unless the power of planetary currents to modify its influence also be taken into account.

The other reason is that through a peculiar sympathy that pervades all Nature, and the fact that Nature tends to express similar qualities in numerous octaves, when the planetary affinity of an object is known—it being but the expression of the same quality on one octave that the planet expresses on another octave of Nature's scale—this planetary rulership, as it is called, affords a true index to otherwise unknown attributes of the object. Thus through their relationship to the orbs above we easily learn the occult properties of things we otherwise might never know. Astrology, therefore, is the golden key that unlocks the mysteries. It is the most perfect instrument in existence, I am convinced, for the interpretation of man's true relation to the universe and to God. And as a religion is what man believes to be his relation to the universe and to God, when rightly understood, there can be no more perfect religion than the Religion of the Stars.

Now right here is where the student proves himself liberal-minded or a bigot. He may recoil upon his egotism and declare he knows he has a free-will and that the stars have no power to influence him. Yet while agreeing with him in the matter of free will, for astrology does not imply fatality, I must point out that the question of whether he is influenced by streams of energy from the planets impinging upon his astral body can be decided, as can any scientific fact, only by experimental evidence.

In spite of educational prejudice, or preconception, if he will put his opinions to the test, and before passing final judgment learn to erect a chart and judge it according to the rules of the science, he will then indicate a true scientific spirit. But many are afraid to put their ideas to the test. They are so self-opinionated they will not investigate anything with which they are not already familiar. They pass sentence without trial, preferring to remain in the rut of error rather than take the trouble to determine the correctness of their opinions. Such an attitude is inexcusable and leads to stagnation. To condemn a subject without examination is bigotry. And such bigotry is equaled in its folly only by many prevalent mystical notions that anyone of average intelligence who takes the pains to investigate carefully can quickly and completely disprove.

If it apparently does not seem reasonable that streams of unseen energy radiated by the planets affect human life and destiny, let us consider that listening to an opera by radio also seems unreasonable. To be sure, nothing seems more unreasonable than life itself; and scientists have puzzled over it centuries without offering any adequate explanation of it. Yet it exists. And the only way to determine if the planets influence human life is to experiment with them. Any person of average intelligence can in a short time, and at trifling expense for tables of the positions of the planets—those for one year being called an Ephemeris—for various years, learn to set up a map showing the positions of the planets at the time of birth of each of his friends and relatives. Such a map is called a horoscope. From examining such charts it will be apparent very shortly that persons born near noon, when the sun is overhead, have great ambition and ultimately rise to a position of prominence in the particular environment in which they move. It will quickly be recognized that persons born just before sunrise also have a power to rise in the world, in these cases through personal effort, and they continue the struggle to rise as long as life lasts. Then the next step in the investigation will be convincing that any person born when the planet Mars is rising on the eastern horizon is aggressive and warlike; but if Saturn is there instead, the person is careful and cautious.

Still more advanced experiments, in which the movements of the planets after birth are calculated, will show that special after-birth positions, called progressed aspects, coincide with specific events in the life, and that from progressed aspects the time and characteristics of events can, within rather narrow limits, be predicted. This is not fatality, it is merely the ability to predict by astronomical calculations when certain streams of energy will fall upon the person's astral body in such a way as to give unusual activity to certain thought-cells within the person's unconscious mind. The person, if aware of the currents reaching him from the planets, does not need to

act in the manner usually indicated. But if unaware of the influence, the thought-cells thus stimulated lead him to fulfill the prediction.

Someone may now interpose the objection that astrologers still use the geocentric positions of the planets, but that astronomers have long ago abandoned geocentric astronomy. This is a misconception, for every astrologer knows that the sun is the center of the Solar System. So does the astronomer, yet when he wishes to calculate where the shadow of an eclipse will fall upon the earth, or when he wishes to determine the moment a star will cross the meridian, he does not calculate these positions in reference to the sun as a center, but in reference to some particular point on the earth. Likewise the mariner does not calculate the position of a star with reference to the sun as a center to find his position at sea. He must know the position of the star in relation to the earth, and to some definite spot on the earth, at some particular interval of time.

So even as the light of the star that enables the mariner to find his position at sea comes to the earth from a given angle at a given time, making his calculations possible, likewise the energies from the planets that influence life reach the earth from given directions at given times. And it is the direction from which these energies are received on the earth, and the manner in which they converge and combine on earth, that determines their influence upon earthly life and destiny.

It is true that astrologers sometimes fail in their predictions; but when the published report of one of the largest and best equipped hospitals in the land shows that in diagnosing disease 53 per cent of its diagnoses, as shown by hospital records, have been wrong, we should be somewhat lenient with astrologers. (Dr. Richard Cabot says of the findings of the Massachusetts General Hospital Clinic, where precision is carried to the nth degree, that post mortem examination proves that in forty-seven per cent the diagnosis of the clinic is correct.—William Howard Hay, M.D., in *Progress*, for September, 1923.)

Architects also make blunders at times, and chemists sometimes fail in their analyses and in their synthetic processes. Even astronomers occasionally err in their calculations. The fault in each of these cases is not so much the fault of the science as the fallibility of those employing it. None of the sciences is yet in a perfected state, but with the same amount of critical investigation astrology will rival, I am persuaded, other sciences in the precision of its results.

Nature of Planetary Influences

—Having, I hope, made it plain that the rules of astrological practice are independent of any theory, and that their accuracy should be determined by observation, let us next inquire into the probable manner in which planetary positions indicate the character at birth, and afterward by giving new energy to certain thought-cells, have an influence over the life.

To start with, we know that the sun is a giant electromagnet radiating lines of energy into space, and that these lines of energy are cut by the various planets revolving around the sun much as the armatures of a dynamo, as commonly installed in our power plants, cut the lines of energy radiated by the electromagnet at the center. I quote from an article by Edgar Lucian Larkin, director of Mt. Lowe Observatory, published in the spring of 1923:

The astronomers at the Mt. Wilson Observatory made a great discovery with their new delicate magnetometers, that rotating sun spots are surrounded by an electromagnetic field of force, and magnetic lines extend to space. This is an important fact in Nature. A dynamo is a rotating metallic mass in an electromagnetic field of force between poles. Then the earth is an armature, since it contains metals and is in rapid rotation.

The great physicist, Tyndall, many years ago indicated how dependent upon the sun are most mechanical actions, chemical changes, and other manifestations of power on the surface of the earth. And to this conception, investigators into the occult have added the assurance that whatever of a mental and spiritual nature is expressed on earth also derives its energy from the sun.

The sun, then, should be regarded as sending forth not only light, radiant heat, electromagnetic energy, and exerting the power of gravitation, but also as radiating still finer energies through astral and spiritual substances which when expressed manifest as mental and moral attributes. In fact, whatever energies exist upon the earth, we may be sure they were chiefly derived from the sun.

The boundless regions of space undoubtedly are fields of energy; for thousands of universes other than our own, with all its countless hordes of suns and systems, are known to be rushing through it with an average speed, so astronomers say, of 480 miles per second. These universes, over a million of which are known to exist, have long been recognized as Spiral Nebulae, and they certainly radiate energies other than the light by which they are seen. Our universe, known as the Galaxy, or Milky Way, also is traveling at a distance of 100,000 to 1,000,000 light-years from the other known universes. (Light travels 186,284 miles per second, according to 1942 findings, and one light-year is the distance light travels in one year.) And while there are stars in our universe that move with much greater speed, and some that move slower, the more than a billion suns comprising our universe have a usual speed among themselves of from 8 to 21 miles per second. Our sun, carrying with it the earth and other planets of the Solar System, travels with a speed of about $12\frac{1}{2}$ miles per second; and the earth on which we live moves in its orbit around the sun at the rate of $18\frac{1}{2}$ miles per second. These figures, of course, stagger the imagination. But I have taken them from the recent reports of well recognized astronomers for the purpose of indicating that the heavenly bodies are moving with great speed, and that, as we know through the very fact of being able to see them, they are each radiating energy. Therefore, as they move, each in its appointed path, they cut fields of energy set up by the other moving suns and universes.

This being the case we may regard our sun as a great step-down transformer. Our earth and the other planets probably are not suitably constituted for handling the high frequencies that abound in the path of the sun. We are most of us aware that the voltage of electricity as it comes from a power-house to be carried any distance is too high to be used in the ordinary electric appliances. It is necessary to install transformers to lower the voltage before the current is permitted to flow over the lighting system or common power wires. So the sun may be looked upon, not merely as a dynamo, but as a transformer of the high-tension energies of space, stepping them down to such frequencies that they set up a new field of energy about the sun.

The planets revolving about the sun in elliptical paths cut the energy field of the sun. This is not an electromagnetic field of energy only, but also an astral energy field and a spiritual energy field. And the planets cutting this huge energy field in turn become transformers and transmitters of energy. That is, each being of different chemical composition and different density of material, they each are adapted to picking up energies and stepping them down to certain other frequencies and radiating these into space.

In this manner, similar in principle to that which may be observed in modern electrical appliances, the energies of space are gathered up by the sun and again radiated. Then the planets gather up this energy, and each giving it a special trend, again radiate it into space. Thus it reaches the earth and man from the particular direction occupied by the planets at the time, and endowed with the particular attributes imparted to it by each.

As no one up to the present time has been able to explain in a thoroughly satisfactory manner just what light, magnetism and electricity are, it would be premature for me to try to explain just what the astral light is. But this energy by which the influence of the planets is transmitted to the earth is seen by clairvoyants as a peculiar light. It varies in color and luminosity even as the sunlight does, and seems to be the all-pervading medium of vision for those who have left the physical plane and now live in the adjacent astral realms.

As physical science is in heated debate as to how light and other electromagnetic energies traverse space, we need not be too positive as to the nature of the vibrations that transmit energy from the planets to the astral body of man and other things; but we need not remain in doubt that such energies do reach and influence all things upon the earth. For this is a matter easily ascertained by experiment.

Then again, if I am asked why planetary influence is ranged so that there are seven distinct kinds of influence, one kind being transmitted by each of the seven planets more anciently known, and the more recently discovered planets Uranus, Neptune and Pluto transmitting an influence that is the octave expression of Mercury, Venus and the Moon, I can only answer it is because the septenary division is the one mostly adhered to by Nature. Why is it there are seven tones in music, the eighth being a higher expression of the first? Why does the light that comes from the sun, when passed through a prism, or as seen in a rainbow, dissolve itself into seven distinct

colors? Why is it that the 92 chemical elements also tend to follow the same septenary law, the atomic number being determined by the number of electrons revolving about the nucleus of an atom, given multiples of such electrons expressing similar qualities on lower and higher octaves, as witnessed in bromine, iodine, chlorine and fluorine, which each express qualities common to all, but with greater or less activity? The impulses and thoughts of man, likewise, are susceptible to a grouping in which there are seven well marked families, and in which three of the families have expressions on a higher octave which gives them additional characteristics.

Therefore, even as in other departments of Nature, so we observe in planetary influences also, a definite grouping of qualities. We find the same quality that is expressed by the influence of a planet upon human life to be expressed in sound by a certain musical tone, to be expressed in color by a certain hue, to be expressed among minerals by a certain metal, to be expressed among stones by a certain gem, to be expressed among numbers and letters by certain of each, to be expressed among human thoughts by a definite group, and among peoples by particular nations. In other words, the same quality of energy expresses in all these and many other domains of existence, but in each case the expression belongs to a given octave.

1. The Sun, as directly affecting life upon the earth, radiates those frequencies of astral light that produce a dignified and lifegiving influence. It is the same quality that expresses in terms of ordinary light as the color Orange. It expresses in sound as the tone D, and in human thought as Power.
2. The Moon, cutting the field of energy set up by the sun, and the field also due to the earth, is so composed that the wave-lengths and frequencies it transmits into space exert an influence that is plastic and receptive. It is the same quality that expresses in terms of color as the Green ray of the solar spectrum. It expresses in sound as the tone F, and in human thought as Domesticity.
3. The planet Mercury, acting as a transformer and transmitter of energy, radiates an influence that is sharp, active, changeable and clever. It is the same quality that expresses in color as Violet. It expresses in sound as the tone B, and in human thought as Intelligence.
4. Venus transforms the solar energies to a different rate of vibration. Her influence is clinging and submissive. It is the love quality which expresses in color as the Yellow ray. In sound it expresses as the tone E, and in human thought as Sociability.
5. The energies radiated by the sun when gathered up and transformed to a different rate by the planet Mars exert an influence energetic and combative. It is the same quality that expresses in color as Red. In sound it is the tone C, and in human thought Aggression.
6. Jupiter, largest of all the planets, transmits an influence that is cheerful and beneficent. It is the same quality that expresses in color as the Indigo ray of the solar

spectrum. It expresses in sound as the tone A, and in human thought as Religion.

7. Saturn, the planet with the rings around it, transforms the energies it receives into such wavelengths and frequencies that they exert an influence that is cold and reflective. It is the same quality that expresses in color as Blue. In sound it expresses as the tone G, and in human thought as Safety.

8. Uranus is merely the higher octave of Mercury, transmitting an influence original and disruptive. It is a quality expressed in color by all combined into a dazzling white. Its tones are above the physical, such as the astral chimes often heard by psychics. It expresses in human thought as Individuality.

9. Neptune is the octave of Venus, and transmits an influence visionary and idealistic. It is a quality expressed by iridescence, in which colors glint and change and flow one into another. Its tones are likewise above the physical, combining as the music of the spheres, and in human thought the same quality expresses as the Utopian.

10. Pluto is the octave of the Moon, transmitting an influence that is forceful and compelling. The domestic impulses are expanded to embrace a larger group. It is a quality expressed by ultraviolet or infrared in color, and by either harmony or discord of tones. In human thought it expresses as Universal Welfare.

Signs Act As Sounding Boards

—As an instrument affects the tone sounded on it, it should also be expected that the tone quality of a given planetary influence is greatly affected by the astral conditions of the particular portion of the heavens occupied by the planet at the time the note is sounded. We are well aware, for instance, that the effect upon the ear of the tone C is much different when the tone emanates from a cello than when it emanates from a calliope.

Due to the field of energy of the combined sun and earth the astral vibrations received from the planets when in one part of the heavens and those received when in a different part of the heavens, although always the same in pitch, are different in tone quality. That is, they are sent from various sounding boards. Observation proves that the path in which the sun and planets apparently move about the earth is divided into twelve distinct sounding boards, or instruments, for astral tones. This path in which the sun and planets apparently travel is called the Zodiac. It commences, due to the polarity of the earth in relation to the sun, at that portion of the sky where the sun crosses the celestial equator from the south to the north in spring each year. The north and south hemispheres of the earth, as indicated by the magnetic needle, are of opposite polarity, and where the sun apparently crosses from one polarity of the earth to the other in coming north is where the zodiac begins.

This zodiac is divided into twelve equal sections, called signs of the zodiac. Each sign, or section, of the zodiac is named after a particular constellation of stars which

pictures its influence, but which does not coincide with it either in location or extent. As each sign of the zodiac has its own quality as a sounding board from which planetary tones may be sent to earth, it follows that the influence of a planet when in one zodiacal sign is not the same as when in another zodiacal sign. The planet Mars, for instance, when in the sign Aries has a pleasing quality like the tone C sounded on a cornet, but when in the sign Cancer the same tone is displeasing like the tone C sounded on an old tin can. This tone quality as influencing life on earth has been determined by careful observation for each planet when in each sign.

Houses Influence Volume and Show Department of Life Affected

—But besides the quality of a tone we must also take into consideration the acoustic conditions where the tone is heard. Due to these conditions, in some great auditoriums it is easy for the slightest tone to be distinctly heard, and in other halls a tone does not carry, or is reflected from walls and ceilings in such manner as to produce a confusion of sounds. Of this public speakers are well aware. And in like manner the astral vibrations reaching any particular point on the earth are subject to the conditions of the environment in which they are received. The earth and its atmosphere have an astral counterpart, through which astral vibrations must make their way to reach any point on the earth's surface. When these rays come from directly overhead they have less astral substance to traverse, and when they come from other directions they have more in varying degree. The surface of the earth, too, is rotating at the equator at the rate of over one thousand miles an hour, which evidently has an influence upon the field of energy about the earth, which again must have an influence upon any astral waves reaching the earth's surface at a given point.

So we find that the direction from which the astral vibrations of the planets are received, with regard to that point on the earth where received, has an influence upon both the volume and the trend of their influence. This variation in the volume of a planet's energy that actually reaches the spot, and the particular trend that is given to it, may be accurately mapped by a circle divided into twelve equal sections called Mundane Houses. The circle represents a line around the earth to the east with the observer at the center. A horizontal line across the circle represents a line passing from the eastern to the western horizon. A vertical line through the circle represents a line from zenith to nadir. Each of the four quadrants thus mapped then may be divided into three equal sections by other lines radiating from the center. And it is found, and may be experimentally verified, that the volume of energy received from a planet when in the section of the sky mapped by one of these Mundane Houses is not the same, nor has it an influence upon the same department of life, as when received from some section of the sky mapped by a different Mundane House.

Aspects Indicate Fortune or Misfortune

—We now have three different factors under consideration, all pertaining to the manner in which the planets affect life upon the earth: 1. The pitch, or tone, of the astral vibration radiated by a planet. 2. The tone quality, or resonance, given to the astral vibration radiated by a planet by the particular zodiacal sign which acts as a sounding board from which it is sounded. 3. The acoustic condition of the auditorium, the point on earth where the astral vibration has an influence, which determines the volume of energy received, and the particular department of life it most influences. And there is yet another consideration before we have spread before us all the more important factors of astrological influence. 4. The manner in which each tone harmonizes or discords with each and all other tones reaching the same spot.

We are doubtless all familiar with the formation of small whirlpools, so frequently to be seen in large numbers at time of high water in our streams. Currents of water meet at just such angles of convergence that they whirl with the proper velocity to form an independent entity, which endures as such for some period of time amid the boiling, seething flood about it. A funnel-shaped hole in the stream is observed, the waters around it forming a rotating wall. Something has been constructed in the surface of the raging torrent that did not before exist. It has properties quite distinct from any other part of the stream. But currents of water meeting under different conditions, from an angle, let us say, that is more obtuse do not form any such entity. They merely roll and toss and foam, as they tumble along, without forming anything distinct and apart from the general current of the stream.

Those of us who have lived on the desert are also familiar with whirling dust columns. Currents of air meeting at just the proper angle form a rotating air column that sucks up sand and dust, and sometimes larger things, the column of whirling sand reaching from earth to sky, moving off across the desert as an entity possessing properties quite apart from the surrounding atmosphere. There are also stronger winds on the desert that give rise to sand storms, but these have not the properties of the whirling columns. Waterspouts and tornadoes are less familiar to most of us, yet they also present an instructive lesson on how currents of air meeting at the proper angle and velocity become agents of terrific power.

Further, light waves under certain circumstances may be brought together in such a manner as to produce, not more light, but less light. This interference of certain light waves with others gives rise to the dark lines of the spectrum. The waves so combine as to cancel each other's motion.

Now, therefore, with these familiar illustrations of water, air and light currents acquiring distinctive properties due to the manner in which they join, we need not be surprised to learn that astral currents when they converge at certain angles possess

distinctive properties.

And even as careful study of water currents indicates the conditions under which whirlpools form, so also careful observation has established the conditions under which the astral currents from the planets meet to acquire certain definite influences. Whirlwinds all do not have the same properties. They vary greatly in height, in area, and in movement. Neither do astral currents when they join in such a manner as to acquire distinctive properties, express always the same characteristics. In fact, there are ten different kinds of astral whirls known, each formed by a distinct angle of meeting, and expressing distinctive characteristics.

These astral whirls are not produced by the meeting of the rays of the planets from all angles. They are formed only when the planetary rays meet at definite angles, which have been learned through observation. When the angle at which the astral vibrations from two planets meet is such as to form a definite condition, comparable to a whirlwind, or to a rapids in a river, or to the undertow on an ocean beach, this angle is called an Aspect.

In all, then, there are ten aspects, or definite angles at which planetary rays meet to exert a definite influence. The disturbance in the astral streams when they meet from certain angles is, like a cyclone, very violent and destructive. When they meet from other angles the result is the formation of energies that tend to bind together and build up the astral organisms that they contact. These energies are such that they may be constructively utilized by the astral forms receiving them. But other energies, formed by astral currents meeting at other angles, exhibit an explosive tendency when contacting astral forms.

Experience teaches that astral currents from the planets meeting at a right angle, one-half a right angle, one and one-half a right angle, and twice a right angle, each has a disintegrative, or destructive, influence. A right angle, of course, is ninety degrees, and the aspect formed by planetary rays meeting at a right angle is called a Square.

When planetary rays meet at an angle of one hundred and twenty degrees the aspect is called a Trine. And experience shows that when planetary rays converge at a trine, one-half a trine, or one-fourth a trine, each aspect, having an influence peculiar to itself, the influence is distinctly integrative and constructive.

The other three aspects recognized—when two planets are in the same degree of the zodiac, when two planets are in the same degree of declination, and when two planets are one hundred and fifty degrees apart—do not seem integrative or disintegrative in themselves, but depend for their constructive or destructive attributes upon the tone and quality of the planetary streams they combine.

Now the question arises, why it is that all things in the same vicinity are not affected by the planetary streams of energy that converge there in the same way? Before answering this I will ask counter questions. Why is it that when the tone C is sounded in a room where there is a piano, the C string in the piano responds with a sound, and the other strings remain silent? And why is it, listening to a radio, that it is possible to

hear a concert given at a distant place, yet not hear other concerts that are being broadcast from the same place using different frequencies? It is because vibrations strike a sympathetic response from, and thus influence, other things having a similar vibratory key.

The astral body of man, and the astral forms of things, contain centers of energy of the same key as each of the planets. But in one person or thing the center of energy keyed to one planet may be so small in volume as to be capable of almost no response, while the center of energy keyed to another planetary influence may be so large that it is constantly sounding a response to the influence of that planet. All persons and things sound a response, transmitting the influence of all the planets in some small degree. But usually the center of energy that transmits the astral vibration of some one planet is more prominent than the centers of energy that respond to those of the other planets. And when it has been determined which planetary influence the person or thing responds to most strongly, the person or thing is said to be Ruled by that planet.

Diverse Functions of Astral Vibrations

—It will now be seen that astral vibration is the means by which energy is communicated from one astral body to another. By it the clairvoyant sees events happening at a great distance, or in the past or in the future. By it tones are carried to the astral ear, giving rise to clairaudience. Events and environment impress their influence upon the astral forms of all things, and these influences being constantly radiated are carried by them to a sensitive person who thus psychometrizes the object. Thoughts are carried from one part of the universe to another by astral vibrations from the living to the dead, and from the dead to the living. Also it is the means by which the planets each send a special grade of energy to the earth; and each reaching the earth from a certain sign of the zodiac possesses a specific tone quality; and reaching the thing or person from a given direction, or mundane house, has a special volume and trend; and converging with other planetary rays at given angles results in a definite constructive or destructive influence. Thus does astral vibration underlie all occult manifestation.

Chapter 4

Serial No. 42
Original Copyright 1924
Elbert Benjamine

Copyright
Church of Light
August 2002

Doctrine of Nativities

Chapter 4

Doctrine of Nativities

NOW that it has been shown that astral vibrations from the planets have such an important and far-reaching influence upon all life, the next step is to indicate more precisely how these vibrations affect humanity.

Yet the reader should not be given the impression that the destiny of the soul commences at its birth into human life, and that planetary influences operating at this birth are determined by chance. Therefore, it seems advisable first to outline the old Hermetic teachings in regard to the soul.

If the old Hermetic Law of Correspondences holds true—"As it is below, so it is above; as on the earth, so in the sky"—then not only the astral world, but the spiritual world, the angelic world, and the celestial world, are subject to the same seven-fold division as the physical world. In other words, the things and entities of these worlds are, even as the things and entities of earth, subject to planetary rulership. Of course, in the higher worlds the vibrations are transmitted by finer substances than the astral, but nevertheless, the entities of these realms belong to definite planetary families. All those things on any plane that are ruled by a certain planet—transmit that planet's influence more freely than any other—are said to belong to its planetary family. Souls are no exception to this, and at the moment of differentiation in the higher realms each belongs to a certain planetary family.

I may not here speak of the angelic parenthood of souls or of the circumstances surrounding their first existence as differentiated entities. These things are explained in Course 2, *Astrological Signatures*. I may here mention, however, that at its first existence as a soul it is endowed with a definite polarity, or quality. After its differentiation the life-impulse—that impulse which we observe causing all forms of life to struggle to live—carries the soul down through fleeting forms in the lower spiritual world, down through other fleeting and elemental forms in the astral world, and finally enables it to incarnate in the mineral realm of a planet.

Do not think that the rocks and metals are devoid of life. Professor Chunder Bose¹, through extensive experiments, has demonstrated that metals, for instance, are sensitive, may be put to sleep, may be intoxicated, or may be killed. The difference between their sensitiveness and that of higher forms of life is one of degree, due to less complex organization. The idea that I wish to convey here, however, is not

merely that rocks and grass and trees as well as animals are endowed with souls, but that the soul evolves through these different forms.

The Astral Body Is Built of Stellar Cells and Stellar Structures

—In its descent to incarnate in the mineral, and in its ascent through innumerable lower forms of physical life, the soul has experiences of different kinds. The awareness and emotions accompanying these experiences build thought-elements into the high-velocity, or stellar, body. Through other experiences these thought-elements become organized as stellar cells, and these in turn into dynamic stellar structures.

Thoughts, in the sense I here use the term, embrace every form of consciousness and include the sensations felt by even the lowest forms of life. All life-forms react to environment through an awareness which builds mental elements into their finer forms. And a birth-chart—even the birth-chart of a primitive creature—is a map of the character, that is, of the thought-organizations of the finer form, as these have been constructed up to the moment of physical birth.

Living physical matter is composed of protoplasm, which is a combination of chemical elements. And the inner-plane, astral or stellar body of every living creature is composed of psychoplasm, formed of thought-elements in various kinds of combinations.

The physical body is built of cells of protoplasm and their secretions; and the astral body, wherein resides the soul, or character, or unconscious mind, as it is variously called, is built of thought-cells, or stellar-cells, as they are also termed. These stellar-cells are not all alike; but are composed of thought-elements of various kinds and in different proportions. They, in turn, enter into the formation of stellar structures, just as the physical cells are organized into the bony structure, the muscular structure, the nervous structure, etc., of the physical body.

Due to its original Polarity, the soul, through the Law of Affinity—the Law that Like attracts Like—builds a form of similar polarity. Its experiences in this form add thought-elements and thought-cells to its astral body. Therefore, as a result of living for a time in this form it possesses qualities that it did not have before. And these qualities, after it has passed through a period of assimilation on the astral plane, cause it to be attracted to, and enable it to mold and function in, an organism of more complex structure.

The soul, then, after it starts on its pilgrimage to matter and back to spirit again, at every step of its journey is governed by the Law of Affinity. That is, the kind of an external form it is attracted to on the physical plane depends upon the thought-organization (thought signifying any type of consciousness) of its astral form. The thought-organization of its astral form depends upon the various

experiences it has previously had, each adding thought-elements and aiding to organize definite thought-cells and thought structures in the astral form. And these thought-cells and thought structures, which in reality are stored up experiences gained in other forms, give it the ability to handle the life processes, and thus build about it the new and more complex body to which it is now attracted.

The soul accomplishes its evolution, therefore, by being attracted to one form, dwelling for a time in it and undergoing certain experiences, then repelling this form and passing to the astral world. We speak of this repelling of the physical form and passing to the astral plane as death.

Then on the astral plane there is a period of existence during which other experiences are added, and the physical experiences are assimilated and still further organized. These assimilated experiences—derived from both the physical world and the astral world—persisting as stellar-cells and stellar structures in the astral body, give it the ability when cyclic law again attracts it to earth to attach itself to the forming crystal, the spore, the divided cell, or the fertilized seed that forms the physical conditions for the growth of a new physical entity. These experiences in directing the life processes that molded some simpler form in the past, also give it the unconscious, or astral, intelligence which enables it to organize about itself, or grow, the more complex life-form which it now animates.

I speak of intelligence advisedly. We are all too apt to take for granted the myriad wonders performed by the plants and insects and animals about us. To be sure, the intelligence they display is not on a level with that exercised by humanity. Yet from the same soil and air one plant will subtract, as in the case of the common red clover, the material to build a head of long-tubed flowers, painting them rose and purple as flaming advertisements to the bumble bees upon which the fertilization and consequent life of the species depends; while another plant subtracts the material, as in the case of the common white sage, for a shrub whose foliage is mostly white, instead of green and whose flowers are white with very short tubes, easily accessible to the honey bees, and so exposed as to attract them, and thus use them as carriers of the fertilizing pollen. Plants also are far more sensitive than is usually supposed. They possess energy very similar to the nerve currents of higher animal life. The difference between the sense of feelings in plants and that in animals is one of degree. This has been adequately and scientifically demonstrated by Professor Chunder Bose².

Economic problems that still perplex humanity, such as the division of labor, have been solved by the ants and the bees. The orb weaver spider thoroughly tests his base line, then produces radial lines that are as accurately spaced as if drawn by a human architect. The oriole builds a hanging basket nest that any basket-maker might envy, and the wasps here in California anticipate cold storage. They sting spiders in such a manner as to paralyze them without producing death, and with them they fill the nests in which they lay their eggs, that the young may have fresh meat to eat during the larval stage. A thousand other instances of the intelligence of plants and animals might be cited. We may call it instinct if we wish, but this instinct is the expression of

an intelligent adaptation of a means to an end.

Neither does this instinct spring into existence spontaneously. It is the result of experiences which are added to the thought-cells of the astral body. The organization of its astral form is responsible for the soul being attracted to the species of life which it is to animate. The physical sperm and germ, or cell-life, that are the commencement of the new physical form, also have an astral counterpart. And through the thought-cells associated with the genes—those portions of the reproductive cell handed down from generation to generation—race characteristics add their experiences, or mental elements, to the astral body of the entity that uses these cells as a physical basis of life. Thus certain race experiences are communicated to the astral body of each entity incarnating in the species.

The entity cannot incarnate in the species, however, until it has had such experiences in lower forms of life as will give it the unconscious, or astral, intelligence to build up the new physical form it is to occupy. Even the food of the higher forms of life has had enough experience in cell-building that it more readily and intelligently performs that function again. Bacteria are the lowest forms of life above the minerals, and certain bacteria can draw their sustenance directly from inorganic minerals. Plant life does this with greater difficulty, and the nitrates generated by bacteria, and the humus—decomposed organic life—in the soil are a great aid to thrifty growth. This is because the astral counterparts of such organic products have already had some experience with life processes, and therefore the more readily perform these functions.

For this reason it is impractical for chemists to make food. The chemist can make bread that contains just the correct amount of each chemical element. But if this bread is to sustain life, in some manner these elements must be given the intelligence usually acquired through the experience of growth. They must be forced at once from the kindergarten, as it were, to high-school intelligence.

Each Cell Has a Soul

—Each cell is an entity, and possesses an intelligence of its own. It may thus be said to be the expression of the soul. It has recently been estimated that there are about as many cells in the human body as there are suns in our galaxy—possibly 40,000,000,000. However, to bring our comparison nearer home, let us say there are 180,000,000 people in the United States. Now each person in the United States has a soul, and lives his own life. The United States forms the opportunity for him to live and evolve such qualities as he can. Likewise the physical body of man affords the opportunity for its numerous population of cell-life to undergo evolution. The President of the United States governs the inhabitants of the United States in much the same manner that the soul of man governs the cell life comprising his body. And as the mind of the President is not the aggregate of the 180,000,000 minds he governs, neither is the soul of man the aggregate of the minds of the cells comprising

his body. And were the comparison drawn still closer, the soul of man would be likened to an imperial ruler to whom the subject cells should give unquestioning obedience.

The reproductive cells which unite to furnish the physical conditions by which a human soul may build about itself a physical body, each may be said to have a soul. But the souls, or intelligences stored in the astral forms of these reproductive cells are, like other cell life, undergoing their own evolution, and they do not become the soul of the child. The soul of the incarnating child has its own astral form, in which are stored as organizations of stellar-cells, all the experiences of its past.

The union of the sperm and germ furnish the conditions for it to become attached to the physical cells, and through cell division to build up about it a human form. The heredity genes in these reproductive cells form the physical link by which race and family characteristics, stored up in the stellar cells of their astral counterparts, are transmitted to the astral body of the child. These race and family characteristics are experiences which are handed on from generation to generation, even as human traditions are passed from one to another by word of mouth. They are thus acquired by the incarnating soul through mental experience. They are experiences derived through the astral rather than through the physical. But as we shall later discern, experiences coming from the astral plane are quite as effective as those coming from the physical.

The soul that incarnates in human form has evolved up through innumerable lower forms of life, at each step gaining new experiences that enable it to be attracted to, and more or less successfully build about itself, a higher form. It now, along with other souls, exists on the astral plane. Whenever there is a ripened ovule in the female organism, one of the conditions is fulfilled for attracting a soul from the astral plane. The intense emotions of the sexual union raise the parents' vibrations to a state where they unconsciously are closely in touch with the astral plane. They actually attract entities from the astral plane to them at this time that correspond to the plane of their desires and emotions and the harmony or discord between them. They contact energies at this time that they do not at any other, which makes it exceedingly important that the motives be lofty and pure.

This astral plane, inhabited as it is by innumerable entities and forms of life, is not away off somewhere in space. It is all about us, and it requires but the proper conditions to be contacted at any time. Observation indicates, however, that astral substance does not communicate motion directly to physical substance. The difference in velocity between the two planes seems to be too great for such direct transmission. But electromagnetism, whose velocity seems to lie between them, performs the function of transmitting energy from the physical to the astral, and from the astral to the physical.

To be able to affect physical substance, an astral entity must utilize electromagnetic energy that already is associated with physical substance. Certain persons emanate electromagnetic energy in large volume, and in such a form that it can be used to

transmit astral motions to atomic matter. Astral entities then use this electromagnetic energy for the production of supernormal physical phenomena. And the person furnishing the excess of electromagnetic energy is called a Medium.

It is this electromagnetic energy that constitutes the vital principle of all physical life. When associated with minerals it is called Mineral Magnetism. As the vital element in vegetable life, binding together the thought-cells and the physical cells and furnishing the motive power for the various vegetative functions, it is known as Vegetable Magnetism. In the animal kingdom it binds together the astral and the physical body, constitutes the vital energy, and is known as Animal Magnetism. In man it performs a like function, and is known as Personal Magnetism. Its quality depends upon the organization of the physical life it vitalizes. It persists only so long as the astral counterpart and the physical are held together, forming the means by which energy is conveyed from one to the other. At the death of the organism this electromagnetic counterpart, or electromagnetic organization, quickly dissipates as the physical particles disintegrate.

Now, nerve currents are electric energies. And when the intense vibrations of sexual union create an electromagnetic vortex, this also creates a vortex in astral substance, and the field of force so created, if there is a ripened ovule in the female organism, attracts the soul of a child of corresponding vibration.

That is, the souls on the astral plane, that have evolved through the various lower forms of life to a point where they are now ready for human incarnation, vary as greatly in quality as do the people of the world which they become. This variance is due to their having had a different polarity at differentiation, which in the course of evolution attracted them to widely different experiences, and these divergent experiences organized different thought-cells in their astral bodies.

From the cosmic standpoint such variety seems necessary, for if all had the same experiences, all would become fitted for the same task in cosmic construction, and it seems that cosmic needs are such as to require souls whose educations bring out a wide variety of talents. But however that may be, the astral bodies of different souls have been differently organized through experiences, and the vibrations of the parents at the time of union attracts a soul whose astral body corresponds in vibratory rate to the vibrations set in motion by the parents. Even should there be no physical union of the parents—for the astral plane is ever ready to utilize whatever conditions permit the physical incarnation of the life-forms which crowd it—if conception takes place, it is the vibratory rates of the parents, imparted to the sperm and germ, that determine the type of soul which is able to become attached to the fertilized cell.

If the general plane of the parents' thoughts are low, and particularly if they are on a low plane during union, the soul attracted will be of corresponding low moral bias. If their love vibrations are exalted, and the general level of their thoughts and aspirations are high, a soul of high spiritual qualities will be attracted. The mental abilities of the soul attracted, as distinct from the moral, depend more upon the intensity of the union. And the physical strength and vitality depend more upon the

harmony between the parents. The soul thus attracted is magnetically attached at the climax of the union to the physical ovule through the electromagnetic field then formed.

The positive electric energies which are the foundation of the future child's vitality are furnished by the father. They are strong or weak as he is or is not virile and intense at the time of union. The receptive magnetic energies which are the foundation of the future child's constitution and general health are furnished by the mother. They are strong or weak as she is, or is not, virile and intense at the time of union.

Upon the harmony between the parents, and the balance in intensity, depend the physical balance and in a measure the general success and happiness of the future child. That is, any discord or lack of balance between the parents in general, and especially at the time of union, will attract a soul in whose astral form are similar qualities. And these discordant thought-cells in its astral body will during life attract inharmony in environment and inharmonious events. Did parents but more fully understand the importance of complete harmony between them, certain souls now born in human form would be compelled to evolve higher upon the astral plane before incarnating, and there would be fewer children born with improper equipment for life.

When conception takes place the astral form of the soul becomes permanently attached to the united sperm and germ. The electromagnetic energy furnished by the father becomes the vital force, and that furnished by the mother becomes the magnetic force, and together they form the electromagnetic form. Through the medium of this electromagnetic energy the astral form attracts the physical particles in the process of growth in such a manner as nearly as possible to build a physical counterpart of the astral form. The astral form is the mold which the physical particles strive to fill in detail, even as hot metal will take the form of the mold into which it is poured. In so far as the physical materials at hand will permit, the physical body grows into an exact likeness of the astral body.

The child, during the period of gestation, has entered an environment largely influenced by the thoughts and feelings of the mother. Both the physical and the astral bodies of mother and child are closely associated. There is a constant exchange of energies between them. As a consequence mothers frequently notice that their natures and dispositions change markedly during pregnancy. This is due to the astral vibrations of the child communicating themselves to the mother. If there is a marked discord between the astral makeup of the mother and the child, she will suffer from this discord. In this case the discord may not belong either to the mother or to the child except that their association, due to difference in vibratory rates in their astral bodies, sets up discord.

But of far more importance than the temporary influence of the child upon the disposition of the mother is the mother's influence upon the unborn child. The child's astral form at this stage is unusually plastic and receptive to vibrations. Thus it is that cases are known in which the mother kept the image of a loved one in her mind during

gestation, and the child when born resembled in features this loved one rather than the father or the mother. A sudden strong desire during pregnancy, or a sudden fright, sometimes results in a birthmark more or less resembling the object causing it. Such fright, when extreme, has been known to deform the offspring. In this intimate relation between mother and child during pregnancy the mother has a wonderful power for good. Her thoughts, her emotions, and her desires are the environment in which the child is living. They communicate rates of motion to its astral form, modifying the thought organizations already there. Upon the thought organization of the astral form, thus modified by the mother's influence, depends the character of the child when born and the events of its life.

It is not necessary here to enter into a discussion of the Prenatal Epoch, as the theory of the relation between the time of conception and the time of birth is called, for this is treated in Course 10-1, *Progressing the Horoscope*, Chapter 8. Nevertheless, it should be pointed out that gestation is under astrological law, and that the child will not be born and live until the astral vibrations at that place set up by planetary positions correspond in pitch, tone, harmony and discord with the astral vibrations of the child then born. It is not to be supposed that this vibratory correspondence is so strict as to allow no latitude. For instance, in tone, the vibrations between certain limits all are said to produce middle C. The color red, likewise, is not a set number of vibrations per second, but those vibrations within a certain range. In the case of birth, however, if the difference between the vibrations of the astral body and those of the planetary influences at the time of birth are extensive, the child suffers, and if too great it will die under the first discordant Progressed Aspect. Hence it is that instrumental deliveries and artificial births may cause an entity to function through a form incapable of responding to its internal nature. Yet there are other times than at the end of the nine-month period, notably at seven months from conception, when the vibrations set up by the planets correspond closely enough with the astral form of the child for it to be born and live to a ripe old age.

**The Birth-Chart Accurately Maps
the Character
as It Has Been Built Up to the
Moment of Birth**

—While there is a certain range of vibratory rates within which the similarity between those of the character and those in the sky is close enough that the child then born will live, nevertheless this similarity—as careful analysis of tens of thousands of birth-charts by our Research Department proves—is always close enough that the outstanding factors of character are accurately mapped in the birth-chart.

And as not only the abilities, but every event of life, is an expression of, or is attracted by, those thought organizations which comprise the character, the birth-chart gives a clear picture of the life if nothing special is done to change the character. That is, as all that happens is the result of character, the only manner in which the destiny can be

changed is to change the character. Furthermore, as destiny is the outcome of character, and through intelligently directed effort the character can be changed, the life indicated by the chart of birth—which is merely a map of the character with which the individual is born—can be markedly altered in any direction desired.

As indicated in chapter 3, scientific astrology need concern itself with but four sets of factors:

1. The 12 zodiacal signs and their 36 decanate subdivisions.
2. The 10 planets.
3. The 12 mundane houses.
4. The 10 aspects.

In that chapter it was indicated what each of these four sets of factors represents as an influence from without. Now, therefore, let us consider, that we may the better understand how the character and thus the fortune can be altered in any direction desired, what each of these factors maps in the astral body.

Signs Map the Zones of the Astral Body

—Aries always maps the region of the head, Taurus the region of the neck and ears, Gemini the hands and arms, etc. They also map the series to which the thought-cells in the compartments of the astral body coincident with these zones belong. Thus the thought-cells in the Aries zone belong to the I Am series, those in the Taurus zone to the I Have series, those in the Gemini zone to the I Think series, etc.

Mundane Houses Map the Compartments of the Astral Body

—The astral, or inner-plane body, is divided not merely into zones as is the physical body—head, neck, arms and hands, heart and back, etc.—but is also separated into 12 different compartments. And these compartments of the astral body are not located in reference to the zones of the astral body the same in different persons. That is, compartment one may largely lie in the Aries zone, the Gemini zone, or some of the other zones, according to the character of the individual. This relationship is indicated by the manner in which the signs are arranged in relation to the houses in the particular birth-chart.

Yet whatever zone covers it, experiences relating to health and the personality build

their thought-elements into the 1st compartment; experiences relating to personal property build their thought-elements into the 2nd compartment; experiences relating to short journeys and brethren build their elements into the 3rd compartment; experiences relating to the home build their thought-elements into the 4th compartment; experiences relating to love affairs, entertainment and children build their thought-elements into the 5th compartment—and so on in such a manner that every department of life builds by its experiences, thought-cells in one of the 12 compartments of the astral body.

In a birth-chart the houses accurately map these 12 compartments of the astral body. Each house of the birth-chart, therefore, maps the thought-cells relating to one department of the life. As what comes into the life, and whether it comes fortunately or as a misfortune, is determined wholly by the amount of activity and the harmony or discord of the thought-cells in the astral body relating to that department of life, the houses of a birth-chart accurately map what may be expected if nothing special is done about it, from each department of the life. That is, what happens is due to the activity of the thought-cells working from the high-velocity plane; and if we know how they are organized and energized we can discern the events they will attract to the individual in whose finer form they make their abode.

Planets Map Dynamic Stellar Structures Which are Also Receiving Sets

—The thought-cells of a particular type which have had added to them experiences of greatest intensity, and through repetition of similar experiences the greatest volume of energy, become organized through these intense and closely related experiences into a stellar structure of a highly active nature. We call such an energetic group of thought-cells in the astral body a Dynamic Stellar Structure. And in the birth-chart it is always mapped by the planet ruling the thought-element which is most active in it.

To put it another way, those experiences which are most intense and belong to a given planetary family build a highly dynamic organization of thought-cells in some particular region of the astral body; and this energetic organization of stellar-cells is always mapped in the birth-chart by the planet most closely related to the experiences which are responsible for its construction. Such a dynamic stellar structure acts as a receiving set for transmitting to the thought-cells of the astral body the vibrations of the planet mapping it in the birth-chart.

Aspects Map Stellar Aerials Which Pick Up, Radio Fashion, Invisible Energies

—Experiences, however, are not isolated events, but through the Law of Association (see Course 5, *Esoteric Psychology*) are related to other experiences. Events that affect one department of life also frequently affect other departments. Furthermore, experiences are pleasant or painful, that is, harmonious or discordant; and it is the amount of harmony built into the thought-cells thus formed that determines the fortune they will attract to the individual; and it is the amount of discord built into the thought-cells so formed that determines the misfortune they will attract to the individual. In other words, if they feel happy, they work from their high-velocity plane to attract good fortune; but if they feel mean, they work with equal diligence to attract misfortune.

These relations between types of experiences of sufficient energy to form dynamic stellar structures, build lines across the astral body from one dynamic structure to other dynamic structures with which experience has thus associated them. Such a line forms a ready avenue by which the compartment of the astral body at one end is able to transmit energy to the compartment of the astral body at the other end. That is, departments of life so associated continue throughout life, if nothing special is done about it, to have an influence of a particular kind over each other.

Such a line, by its length, also indicates whether the two compartments are associated harmoniously or inharmoniously, and thus whether the thought-elements mapped by the planet at either end have entered into a harmonious or discordant thought-cell compound.

But in addition to this, each such line acts as a stellar aerial to pick up, radio fashion, the energies of similar quality radiated from the planets. That is, if it is of a length suitable only to picking up discord, it will pick up the energies of the planets mapped at each end only so loaded with static that this energy disturbs the thought-cells in a very disagreeable manner. But if it is of such length as to pick up the energies mapped at each end harmoniously, it delivers these planetary energies to the thought-cells at either end in such pleasing quality as to cause them to work from their high-velocity plane to attract fortunate conditions into the life.

These lines across the astral body, which, unless something special is done to change them, all through life pick up, radio fashion, planetary-energy, thought-energy, and character-energy radiated from objects, in a particular manner, are called PERMANENT STELLAR AERIALS. They are mapped in the birth-chart by the ASPECTS.

Character Constantly Reacts to the Forces of Its Environment

—Environment constantly stimulates changes in all life-forms; and chief among these environmental forces are the invisible radiations from the planets. As the planets move forward after birth through the signs of the zodiac the energies fall upon the zone of the astral body governed by the sign they are passing through. And it seems that the astral body of a child is more plastic and receptive to these astral vibrations during the early days and months of its life than when older. Furthermore, the energies then received do not spend their force at once, but are liberated through cycles.

In the same way that we determine the cycles governing the different stages of development of the embryo in a duck egg, and can thus make definite predictions from this knowledge, or as we can predict that a certain strain of corn when planted will be out of the ground in so many days, in so many weeks will tassel, in so many months will be in the milk, and that one hundred days from the time placed in the ground will mature; we can also determine the cycles governing similar releases of energy stored in the human astral body. That method is through observation.

The Three Releases of Energy

—Observation acquaints us with the fact that there are three distinct releases of energy, each measured by its own cycle. The most important such release is at the ratio of the movements of the planets during one day after birth releasing energy then stored during one year of life. The next most important such release of energy is at the ratio of the movements of the planets during one month after birth releasing energy then stored during one year of life. And the least important such release of energy is at the ratio of the movements of the planets during one day after birth releasing energy then stored during the same day of life.

Because the mapping of these three methods of energy storage and release is done by moving, or “progressing” the planets through the degrees and signs of the birth-chart, the releases of energy after this manner are called Progressions. They are comparable to the releases of energy of a clock which has an hour hand, a minute hand, and a second hand.

Energy is stored up in the clock by being imparted to a spring, or by weights being lifted. The energy stored up in the clock weights is not released all at once—no more so than the energy stored up by planetary movements immediately following birth. In the case of the clock it is released by the cyclic movement of the pendulum or other device; and in the case of the birth-chart it is released by the cyclic motion of our earth about the Sun.

The hour hand of the clock corresponds to the important day for a year ratio of release in the astral body, which is the ratio of Major Progressions.

The minute hand of the clock corresponds to the next most important month for a year ratio of release in the astral body, which is the ratio of Minor Progressions.

The second hand of the clock corresponds to the least important day for a day ratio of release in the astral body, which is the ratio of Transits.

As the planets thus move forward after birth, regardless of aspect, or aerial, they store up energy which when released according to the ratios of progression, imparts their type of energy to the zone where they are shown by progression; and this gives the thought-cells of the indicated region more than their normal activity. And this is true whether the planet moves through the sign by Major Progression, by Minor Progression or by Transit; although the amount of energy thus imparted and released by Major Progression is far greater.

Progressed Aspects Map Temporary Stellar Aerials

—From what has now been said I think it will be clear that the function of Progressions is to map those structural changes which take place in the astral body, in obedience to cyclic law, that permit energies from the planets at definite and predictable times, to reach certain groups of thought-cells in volume enough to give them extraordinary activities.

When a planet progressing according to one of the three indicated ratios forms an aspect with a planet in the birth-chart, or with another major progressed planet, the energy-release then builds across the astral body a line which acts as an aerial which picks up and transmits to its two terminals, energy of the type of the two planets involved in the aspect. Experience proves that these temporary stellar aerials, mapped by progressed aspects, while their influence may be felt over a somewhat longer period, are seldom clear cut enough to pick up sufficient energy to bring an event into the life either before or after the planets are within one degree of the perfect aspect.

These temporary stellar aerials thus formed by the cyclic release of energy, have a length indicated by the aspect which maps them, and this determines whether the astral energy, from any source derived—thought-energy, and character-vibration energy as well as planetary energy—which they pick up, will be given a harmonious turn, or will be loaded with discordant static.

To the extent they transmit energy which is harmonious to the stellar-cells at their terminals, are the thought-cells there given an impetus to work to attract favorable events. Likewise, to the extent these temporary stellar aerials transmit energy which is discordant to the stellar cells at their terminals, are the thought-groups there located given an impetus to attract misfortune.

**Events Are Attracted Into the Life
Only by Unusual Thought-Cell
Activities**

—The stellar-cells of which the astral body is composed, the more active of which are organized into dynamic stellar structures which are mapped by the planets in the birth-chart, have a certain intelligence of their own, and work from the high-velocity plane to attract into the life conditions and events corresponding to the way they feel. When they receive no additional energy from any source they have only the amount and kind of activity indicated by the birth-chart. It is only when, from some source—astrological vibrations, thought vibrations, or the character vibrations of objects—they receive an additional energy supply that their activity is greater than the normal thus shown.

The whole problem of predicting the nature and time of events by natal astrology, therefore is to ascertain the time when certain groups of stellar-cells within the astral body will receive additional energy; and in what volume and in what harmony or discord it will reach them. And it is this that a knowledge of Progressed Aspects enables us to do.

Because, except some special effort based on astrological knowledge is made, the stellar cells of the astral body receive additional energy of sufficient intensity only when Progressed Aspects indicate Temporary Stellar Aerials have been formed across the astral body; events apart from the normal everyday trend of life are attracted only when Progressed Aspects are present within one degree of perfect. And as the temporary stellar aerial thus mapped is plainly associated with certain compartments of the astral body, as mapped by the houses of the birth-chart influenced by the aspect, the department of life to which the thought-cells belong which are thus given additional activity is readily apparent.

The families to which the thought-cells belong, and therefore their type of activity—aggressive, social, timid and cunning, etc—are indicated by the planets involved in the Progressed Aspect. The department of life to which they will give increased activity is shown by the house rulership of the planets involved in the Progressed Aspect. And—taking also into consideration the normal harmony or discord of the thought-cells thus given activity—the nature of a Progressed Aspect determines whether, and to what extent, the unusual activity of the thought-cells thus given energy will be favorable or unfavorable in the type of events they attract.

**Events Shown by Progressed
Aspects Are Not
Inevitable but Are Subject to
Intelligent Control**

—While it is true that the structure of the astral body responds to cyclic law and tends to build lines, or temporary stellar arials across the astral body, at the time energy is released through Progressed Aspects; it is also true that the astral body, unconscious mind, or character, as it is variously called, is equally responsive to properly directed thoughts and emotions.

Anything that can be done in the way of structural changes and adding energy to thought-cells by planets, can be done equally well through persistently directed thoughts and cultivated experiences. The thought-cells were built into the astral body in the first place through states of consciousness stimulated by environment. They were not built there by the environment, but by the mental reaction to it. And by cultivating a proper reaction to planetary vibrations at the time of the release of energy by Progressed Aspects the events usually to be expected can be markedly changed in the direction desired.

**A Complete Reading of a
Birth-Chart**

—In a complete birth-chart reading, therefore, the following seven factors should be included:

1. The person receiving the birth-chart should be told just what it represents
2. He should be told, in connection with each department of life, what will be attracted, and why, if nothing special is done about it.
3. He should be informed as to the best methods to follow to change the destiny of each department of life in the desired direction.
4. He should be told what a progressed aspect represents.
5. He should be told what events each progressed aspect during the period covered may be expected to attract if nothing special is done about it.
6. In connection with each progressed aspect during the period covered he should be told the very best method of causing the energies then present to attract, not what they otherwise would, but what he desires.
7. To show that the basis for such information is at hand he should be given an accurately erected chart of the time of day of birth.

Notes

1. Response in the Living and Non-Living.
2. Plant Response.

Chapter 5

Serial No. 43
Original Copyright 1925
Elbert Benjamine

Copyright
Church of Light
August 2002

Doctrine of Mediumship

Chapter 5

Doctrine of Mediumship

IT IS NOT within the province of these lessons on mediumship to offer proof that the numerous kinds of psychic phenomena considered are genuine, but to cite where such proof may be found and to explain them according to the findings of Hermetic Initiates.

The most convincing proof, to be sure, is that based upon personal experience, and thousands are having such proof each day. But my personal experience, or your personal experience, has very little weight with those who have had no like occurrence. We must refer such to the innumerable cases of psychic phenomena, belonging to all classes, which have been painstakingly collected by men of international scientific standing and integrity. A host of such phenomena have been witnessed and critically analyzed under such circumstances as to make fraud or illusion impossible. The person nowadays who denies a wide variety of psychic phenomena, ranging from telepathy, clairvoyance and premonition to, and including, haunted houses and materializations, is merely behind the times and ignorant. Of the many men of international scientific reputation who have seriously investigated such psychic phenomena I know of not a single one who remains unconvinced of their genuineness.

Since these lessons were first written there has been a vast amount of additional proof published. In 1923 Charles Richet, Professor of Physiology in the University of Paris, came out with a book of over six hundred pages, "Thirty Years of Psychical Research," in which he gives a large number of carefully verified instances of the numerous types of psychic phenomena. In 1920 there appeared in English, "Phenomena and Materialization," by Baron Von Schrenk Notzing, a large volume illustrated with two hundred twenty-five photographs of spirit materializations. The conditions under which these photographs were obtained were of the strictest nature, and not only afford positive proof that materializations actually take place, but yield much new knowledge of the manner in which they are formed.

In 1922 there was published, "Death and Its Mystery," by Camille Flammarion, a large collection of authentic instances of telepathy, clairvoyance, the sight of future events, etc. Also in 1922, another book of the same series, "At the Moment of Death," by Flammarion, was published. This book contains a large collection of well verified

cases of phantasms of the living, apparitions of the dying, psychic warnings of approaching death, deaths announced by blows from invisible agents, and other psychic manifestations of the dying. In 1923 the third of this series, "After Death," by Flammarion, appeared. It contains a large collection of verified cases where the dead have returned according to previous agreement, and of other manifestations and apparitions after death. The latter are arranged according to the length of time after death that they appeared, and constitute conclusive proof that the dead do sometimes return, the length of time elapsing after death before the return being any time from a few minutes to thirty years.

Finally, in 1924, "Haunted Houses," by Flammarion, was published. This book is a collection of a very large number of cases of genuine hauntings, and forever disposes of the question of whether or not there actually are haunted houses. Camille Flammarion, who has attained an international reputation as a scientist through his astronomical work, has been gathering data on psychic subjects for the last fifty years. In 1899 he intensified his efforts in this direction, and put forth a wide and systematic effort to collect well authenticated cases of psychic phenomena. Up to that time he had received some 500 psychic observations. Since then he has received more than 5,600 different psychic observations. The Psychic Research Societies of France, England, Italy, Germany and other countries have published about as many more that have come to his notice, so that he had some ten or eleven thousand different psychic observations from which to draw conclusions.

Facts are always of greater weight than theories. Here we have facts; innumerable facts; verified facts; incontrovertible facts; all testifying that psychic phenomena take place, and a great many of them testifying that the dead survive.

It seems strange that the very religions that teach life after death are so bitter against proof being offered that such is the case. If an enlightened people are to believe in a life after death there must be some proof of it. What better proof can there be than that the dead return and manifest a personality that is recognizable? If the dead still live, why should we think there are insurmountable barriers to communicating with them? As I write no airship has flown across the Pacific Ocean. Some think such a feat impossible. But it will be done. A retrospect shows a thousand obstacles to man's achievement that were once thought insurmountable. But one by one they have been overcome. Today's psychic phenomena, it is true, is more or less sporadic and imperfect. But in spite of this, a vast proportion of it is genuine. As such it points the way to a more perfect form that may be brought under the control of the human will.

I should not omit mention of "The Case for Spirit Photography" (1923), and "The Coming of the Fairies" (1922), by A. Conan Doyle. The former book relates instances of spirit photography and is illustrated from spirit photographs. The latter is an account of an investigation of some fairies which were photographed by two little girls under such circumstances as to make fraud impossible.

There are other books and many magazine articles that have appeared in the last few years, all offering definite examples of psychic phenomena. But those mentioned

will be quite conclusive to any person who can be convinced through reading about the experiences of others. To those who must have personal experience to convince them, there is always open the more arduous, but very satisfactory road of experimental investigation. Of this I feel confident; any person who will approach the problem with an unbiased mind and investigate painstakingly over a long period cannot but be satisfied both as to the reality of the various kinds of psychic phenomena and that the human personality survives death.

This being the case, the question naturally arises: how it is possible for those existing on other planes of life to manifest themselves through such phenomena, or in any manner communicate with those yet in the flesh. To answer this question we must first understand, in its broadest sense, what the term mediumship implies.

Take the smith who shapes a horseshoe. When the iron is placed in the fire it is cold, meaning that it has a slow molecular motion. The fire, on the other hand, has a swift molecular motion—is hot. Through contact some of the molecular motion of the fire is imparted to the iron, increasing its molecular motion. It, in turn, becomes hot, which is but another way of stating that it is a passive agent of the fire in the forge and has become a medium for the transmission of its energy.

Next the smith removes the red-hot iron from the fire, places it upon the anvil, and by means of blows from a hammer shapes it to the form he desires.

He has in his mind an image of the shape it is to assume. His motor nerves respond to his mind as mediums for transmitting his thoughts to his muscles. The hammer in his hand is the medium through which he transmits the energy of his muscles in a particular manner to the iron he is shaping. The iron he shapes, the fire in the forge, the hammer in his hand, his muscles and nerves; all are mediums through which the smith transmits a subjective form of energy called an idea into an objective form of energy called a horseshoe. There is an unbroken chain of mediumship between the active thought held in the smith's mind and the passive piece of iron that has become a horseshoe. In each instance that which was more active controlled and used as a medium that which was less active. And this is one of the fundamental laws of mediumship, that the passive is always controlled by the active.

This law in mediumship is as fundamental as that of the conservation of energy. Conservation of energy not only applies to psychic matters, but is the very Gibraltar upon which physical science rests. It is the law that energy can never be created or destroyed. Therefore all energy existing today is derived from some preexisting form of energy.

Energy may be transformed in a thousand different ways, some of which were noticed in the case of the smith shaping the iron, but it can never be lost to one thing except through giving it to something else. Thus the energy residing in the mineral and in the carbon of the air is assimilated by plant life, and this still later is organized into the cell life of an animal, finally to return to the soil to be assimilated by some other life form. The energy reaching the earth from the sun may be stored up in plant life and buried, subjected to great pressure which transforms it into coal, and finally

be dug up by man and used as fuel to generate power for use in all the intricate ways of modern manufacturing industry. In fact, a little reflection will show that the whole Solar System is but the medium through which the Sun exercises its controlling power. To be sure, as still further reflection will indicate, everything in existence from the highest spiritual beings to the dense rocks of earth are mediums for transmitting particular kinds of energy.

To sum up the extent of mediumship, without taking space to enumerate examples in proof of it, the statement may be made that the whole Universe is mediumistic in the sense of receiving and again transmitting energy, God being the One Great Controlling Power.

Now if we look about us we perceive that everything is in motion. At least a close analysis will reveal that those things which are stationary are only so because of our dull perceptions. This motion implies that something is acting as a medium for the transmission of energy. Thus positive and negative electric charges oscillating about each other may set up the particular transverse wave motions that we call light. Space then becomes the medium for the transmission of energy. It is passive to and controlled by the electric charges. Likewise, molecular motion, as heat, may be transmitted from one object to another. In this case the heat is the controlling agent, and the object receiving the heat the passive medium. Or radiant heat, which is electromagnetic motion, may be transmitted across space without a material agent, communicating motion to the molecules of physical substance, and the physical substance becomes hot, as when we place an object in the sunshine. The physical object then becomes the medium for the expression on the physical plane of an energy received through a non-material medium, from a distant controlling center, the sun. The radio is another instance of the power of a distant controlling influence to transmit energy through space and set up physical motions through a passive receiving medium.

The mind of man, as taught by Hermetic Science, is an organization of energy in astral and still finer substances. These astral energies may be communicated to physical substance, as was seen in the case of the smith shaping the horseshoe. Mental energies, residing as they do in substances finer than the physical, are more active than physical energies, and hence, following our fundamental law that the passive is always controlled by the active, they exercise a controlling power over the physical.

It is not the volume of energy present that determines its power to control so much as its relative activity. This relative activity may obtain by virtue of various circumstances, as when the throttle of an engine is opened, or a small shove is given to an object nicely balanced on the edge of a precipice. In such cases neither the throttle nor the shove generates the large amount of energy used. They but release in a definite direction energy that is already present. Nevertheless, at the moment they exercise controlling power the throttle and the shove relatively are more active than the energies released by them.

The human mind, also, by advantage of its intense activity, constantly releases energies already existing on the physical plane.

One is justified in saying, I believe, that man is man and not something else because he has learned how to utilize and control very numerous and complex forces and functions. The soul, which embraces all the various states of consciousness stored in his astral and spiritual makeup, is able to function through the body of man on the physical plane only because through a long period of education and effort it has learned how to control such a body.

The process of evolution is a schooling in the capture, storage, and release of energy. The physical bodies of all kinds of mundane life are the mediums through which energy previously existing is diverted into special channels by the intelligences occupying such bodies. This energy may merely be the food partaken of, which is utilized in the movements and life processes of the organism. Or it may consist of the finer astral energies radiated by the Sun and planets. But in any case the height of an organism in the evolutionary scale is determined by its power to control and intelligently direct complex energies.

The mollusks, the fishes in the sea, the amphibians, the reptiles, the birds of the air and the beasts of the field each capture, store, and release energy. They are all mediums in the sense of receiving and transmitting force. Each, however, in the order named, has improved upon the methods of the previous one in the power to control and intelligently direct this energy. Furthermore, man is superior to all other forms upon the earth, not by virtue of the volume of energy within his body, but by his ability to control and intelligently direct himself. So long as he has the power intelligently to direct himself, he is able to utilize not only the energy of his own body, but a multitude of other energies by which he is surrounded.

The whole struggle for survival is but a struggle of the species and the individual to preserve and perpetuate the control of its organism. Any tendency, therefore, to relinquish the control of the human body or to permit another to control it, tends toward the destruction of the individuality.

This is immediately apparent from a study of material biology only. But when we consider the methods by which a soul evolves through form after form, in each learning how to control some new function and process, until at last it has had experience enough in intelligently controlling energy to be able to incarnate in human shape, we see from a new angle that the control of one's organism is perhaps the most vital thing in human life.

That which people who are striving to accomplish anything continually do is to endeavor to acquire greater and greater control over their own bodies, their own energies, and their own thoughts. To be unusually accomplished in any direction means that an unusual amount of control has been gained over some set of muscles, or over some mental process, or both. Control over self is the first requisite to success, and the greater the control the more certain the success. If there is good control in one direction and lack of it in another, there will be good prospects of

success in the direction of the control, and none in the direction of lack of control.

If we but reflect upon the steps that must be taken by the child in learning to control and intelligently direct himself before he is capable of making his own way in the world we will perceive how vastly important is this element of control. It is only through repeated effort over considerable time that he learns to talk. At first he cannot control and properly direct the muscles of the tongue and mouth to produce the sounds he wishes to make. Learning to walk is another process that takes considerable time. By and by, through repeated effort, control is gained over the muscles used in walking. We thus might proceed with one thing after another that the child must learn, each requiring repeated effort over and over again until that nice coordination between mind and muscles is attained which enables him to perform the desired act. This laborious process of gaining control of his body on the part of the child is but a similar, though briefer, process to that followed by the whole of life in its evolutionary struggle.

We also are familiar with the fact that an acquired power is soon lost if not used. A marksman, a musician, a mathematician, all must keep in practice if they are to excel. The college athlete ten years after leaving usually is unable to do any one of many things he could easily do while in college. Even a doctor or a lawyer must keep in practice to be able to do good work. A faculty not used atrophies.

Fish that live for generations in the water of underground caverns often lose their sight. The vermiform appendix, which causes men so much trouble, appears to be but the degenerate vestige of a larger tract present in man's ancestors, which was used to break up cellulose when they ate, as do horses and cows now, grasses and vegetables having this abundant in their structure. A change of diet has caused it to be no longer used for its original purpose. Through lack of use it has grown smaller and smaller, until now it is present only in miniature.

It will be seen, I believe, without further illustrations, which could be supplied indefinitely, that the acquirement of control over one's body, or any portion of it, is at the expense of much energy, and that such control when once gained is easily lost. Further, it should be evident that as gain in control is progress, loss of control is retrogression.

Also, as control is gained by effort and practice, loss of control certainly follows lack of effort and practice. And of all forms of lack of effort toward, and practice in, self-control, the most rapid method of losing such control is to relinquish the controlling power to some other entity.

Every form of life, from its birth to its death, must struggle against the invasion of its organism and more or less complete control of it by other entities. Plants must resist various insects and parasitic forms. Note how certain insects cause the oak to grow oak-galls, distortions that are of no benefit to the tree, but benefit the insects only. Animals must resist parasites and a thousand kinds of germs, and man also must keep his body clean and vigorous if he would resist the ravages of disease.

Man, too, has had to struggle continually against autocratic powers that would enslave him physically and financially, and against religious hierarchies that would enslave his mind. Whenever any form of life ceases to resist invasion, there are always entities eager to use this loss of control for their own advantage. Whenever man has relaxed his vigilance politically, he has been despoiled. Look at history and weigh this well. Whenever man ceases to resist it, religious intolerance takes control. Read history again. Likewise, whenever man relinquishes the control of his body and mind to another he is inviting slavery to a master of whose identity he cannot be sure.

But of even greater importance is this, that every time a person delivers the control of any faculty or function to another he is undoing what it took him so long to learn to do. The control which is so vital a factor in his life was gained by getting his nerves and muscles into the habit of obeying him. Such a habit is readily destroyed. Even the habit of thinking correctly is easily superseded by the habit of permitting some other entity to do the thinking. It is so much easier. A man who has been sober all his life can become a habitual drunkard in a few weeks, and unable to remain sober. A man, likewise, who has a remarkable power of self-control built up over a lifetime can so destroy that self-control in a few weeks by permitting some other entity to use his brain and body that he finds it impossible to do what he wishes to do, and impossible to refrain from doing as the dominating entity suggests.

There is another biological law that any life-form that becomes a parasite ceases to evolve and degenerates to a lower level. No longer being under the necessity of procuring food in open competition with other forms of life, having found a way in which to live with little effort, it sinks to a lower biological level. In a manner not dissimilar, those who permit themselves to be dominated by some other intelligence, not only lose the power to control themselves, but become so dependent upon other intelligences that they fail to progress and tend physically, mentally, and morally to slip back.

The soul gained whatever control it has over the brain and physical body through organizing lines of force in the astral form. These special astral lines of force, organized by ceaseless effort to control the thoughts and actions, transmit the orders of the soul to the brain and nervous system. The electromagnetic motions thus set up cause the person to think objectively in a certain way and to act in a certain way, just as the soul dictates.

Now, however, if the soul turns the control of its brain and actions temporarily over to some other entity, this other entity, in order to exercise control, must organize lines of force in the person's astral form suitable to transmitting its orders to the person's brain and nervous system. Just as every time the person exercises control over his own actions, the lines of force in his astral body establishing such control are strengthened, so any time any foreign entity exercises control over the person such lines of force are strengthened and will the more readily enable a foreign entity to obtain and exercise controlling power.

Further, in order that the invading entity, whether it be a hypnotist on the material

plane or a discarnate entity on the astral plane, may be insured against its control being interrupted inopportunately, it becomes necessary for it temporarily to resist any effort of the person to break such control. The very act of resisting the person's attempts to regain complete control of his own body directs energies toward breaking down the lines of force in the astral body by which the soul has been accustomed to control his own brain and body.

The spirit medium, therefore, who undergoes so-called development by becoming passive and permitting some discarnate entity to take control, is undoing the most important work of his life and of evolution. Instead of resisting invasion he is permitting another entity to build lines of force in his astral body that when strong enough will permit that entity to take possession of the brain and body in spite of its rightful owner any time it desires to do so. He is permitting lines of force to be established that provide an open door by which any other entity on the physical or astral plane may gain a like control over him in spite of himself. He is permitting lines of force in his astral body which he has spent so much time and effort in building, and by which he exercises control over his body and its functions, to be wantonly destroyed.

Every time a person goes wholly or partially under the control of a spirit, a mesmerist, or a hypnotist, he is assisting in the destruction of his own individuality. Permitting such control is irresponsible and disintegrative mediumship. Such practices persisted in bring the unfortunate subject or medium to a state where he is helpless to repel the invasion of his organism by any active entity, incarnate or discarnate. Irresponsible mediumship tends to destroy the will and soul.

There are various ways by which these negative states may be induced and irresponsible mediumship attained. The first requisite is to attain a blank, passive state of mind in which the soul has no point of contact with or control over the objective thoughts and actions. In developing circles the sitters are so arranged as to generate a strong current from their electromagnetic emanations, which is used by astral entities present to produce a mesmeric effect, and so hasten absolute passivity. In hypnotism the attention is fixed steadily in some direction to produce a state of abstraction in which the subject accepts without resistance any suggestion offered him.

In all these cases the divine soul ceases to act with much force upon the unconscious mind, other lines of force being set up in it by the dominating idea or entity. It matters not whether the operator is a hypnotist, a discarnate entity, or the combined thought forms of other people with whom the subject associates, the effect is the same. He sees, hears, and desires what the operator demands. These things may be true or false, but the subject has no method of discriminating. If the controlling entity is intelligent it may impart useful information. If not, it may utter mere nonsense. In any case the subject is not exercising his own functions, but merely shadowing what some other entity wishes him to do or feel. For this he is paying a fearful price, for he is gradually losing the power to direct his own organism, and is becoming the abject slave to disintegrative forces. He is undoing what he has struggled so hard to accomplish,

losing the ability to mould a form to meet his needs.

For those unfortunate individuals who have become irresponsible mediums I have only sympathy and no word of condemnation. Many of them have added to the happiness of the world by bringing comfort to those whose loved ones have passed on, and the assurance that there is a life after physical death. Many of them have submitted themselves to the most rigid tests of scientific men, and have thus provided irrefutable proof of the various kinds of psychic phenomena, proof also that is beyond denial that those who have passed through the tomb yet live. The world owes a great obligation to a host of self-sacrificing spirit mediums.

The world also owes its thanks to valiant doctors who have injected serums into their own veins to prove their effect. It owes its thanks to thousands of others who have suffered martyrdom for the sake of science. Nor have I one word of objection to any person, after he has weighed the consequences well, developing the irresponsible phase of mediumship. If he is convinced he can be of greater benefit to society by permitting his individuality to be destroyed that entities from another plane may use him as an instrument by which to manifest on the physical plane, he should have full option in the matter. It is desirable, however, that all the facts be known beforehand so that those who do not wish to make such a heroic sacrifice may not be led into it under misapprehension.

If the astral plane, where disembodied entities dwell, were the abode of human beings only, the matter of surrendering self-control would not assume so serious an aspect. The thought even of surrendering the body and brain to discarnate human beings is not altogether pleasant when it is remembered that all the vicious, criminal, insane, and morbid people who die do not, for considerable time, change in their desires, tendencies, and traits. In fact, the lower strata of mankind remain very close to the earth for some time, being earth bound by their physical desires. They welcome the opportunity to realize those desires through the physical body of any mediumistic person they can seize. Many an act of crime, many a repulsive habit formed, many an erratic action, may be laid at the door of a discarnate entity who has found opportunity temporarily to get control of some person whose power of resistance is weak.

But depraved human beings, and those not depraved, are not the only astral entities by any means. Every insect, reptile, fish and mammal that dies on the earth exists for a time on the astral plane. In addition to these forms of life, with which we are more familiar, there are also countless myriads of other forms, some of which are called elementals, which have no counterpart on earth, but live wholly on the astral plane. These elementals have a certain amount of intelligence. Other astral entities have intelligence in different degrees. Some are malicious, some are cunning, some are mischievous, some harmless and mirthful. Any one of these creatures may find the opportunity to take control of an irresponsible medium. The lines of force permitting foreign control have been established in developing, and provide an open door, by which any astral entity may find it convenient to enter and manifest itself, even as an animal may walk into a house when the door is open.

Such entities are not above impersonation, and some are quite clever at it. Surely no one in his right mind can listen to the senseless drivel sometimes given forth by a medium in the trance state as coming from an intelligent loved one who has passed beyond, without realizing there is imposture. The mightiest intellects of the world are supposed by some to come back through mediums and utter time worn platitudes and inane remarks. They revel in the puerile and frivolous. Nor is the medium a fraud, he has merely been taken possession of by some astral entity who delights in perpetuating a hoax.

Yet because of such obvious untruthfulness and lack of integrity on the part of the entities that all too often control mediums we must not jump to the conclusion that all communications are unreliable, or that irresponsible mediums never really transmit messages from the dead. Sometimes the messages are genuine, and reveal beyond doubt the personality of the loved one. Sometimes the control is a departed friend who offers such proof of his identity that it can not be disputed. Particularly when the mediumship is developed and practiced in the sanctity of the home, and is accompanied by high spiritual ideals and noble desires is it more common to receive genuine communications from the dead. A pure heart and noble trend of mind do not tend to attract low or mischievous astral entities.

Sir Arthur Conan Doyle vouches for the following case of a spirit message which cannot be satisfactorily explained except as a genuine communication from the dead. He maintains that the circumstances were fully investigated and found to be quite authentic:

It seems in Australia the two sons of a couple interested in spiritualism had a boat in which they occasionally took a ride on the bay. On the particular day in question no one knew they were going boating, and no one saw them go. But at evening they failed to show up for dinner. Considerable concern was felt and after a time, when they failed still to appear, a seance was held. One of the youths took control of the medium and stated that a squall had upset their boat and that he had been devoured by a large fish which he described. No trace of the boys or the boat was found, but some days later a large shark, of a species which is almost never seen in those waters, drifted upon the beach, and in its stomach were found the watch and pocket knife of the boy who stated through the medium he had been devoured when the boat upset. The shark, a large blue one, if I remember correctly, also answered his description, being of great rarity in that region.

As no one knew the youths went boating, or knew that they upset, the information could not have been received telepathically from a living person. Besides, it would be beyond the power of any living person unless he was actually with the boys when the accident took place, to know what kind of a fish had devoured him, or that he had been eaten by a shark. Yet the description of this unusual fish was furnished.¹

My very plain statement of the effects of irresponsible mediumship, based upon careful research and observations covering more than a quarter of a century and an intimate acquaintance with a great number of mediums, may seem quite

discouraging to those who have hopes of communicating with their loved ones who have passed beyond the physical plane. But it need not be so, for I have so far only considered the negative, irresponsible and disintegrative phases of mediumship. There is another form of mediumship that is positive, responsible, and constructive, by which it is possible, and without any injurious effects, to duplicate any phenomena that may be produced by the irresponsible and disintegrative method.

Tasting, smelling, seeing, hearing, and feeling are all forms of mediumship. Through direct contact with substances, or small portions of substances, the organs of taste, feeling, and smell have energy imparted to them that is transmitted by the nerves to the brain and thence through electromagnetic motions to the unconscious mind. Such mediumship does not depend upon negativeness and passivity, but upon the development of sensitive organs and upon the alertness that enables them to receive impressions from the outside world.

The faculty of clairvoyance² may be exercised with no more negativeness than it is necessary to exercise in the ordinary sense of sight. Transverse wave motions in space convey the image of an object to the eye. Through the optic nerve and brain the image is registered in the astral consciousness. Wave motions in the astral substance, corresponding to a transverse motion in space, convey the image of an astral object—and all physical objects have astral counterparts—to the organ of sight of the astral body. Through the astral eyes the image is registered upon the unconscious mind. When the image is raised into the region of consciousness the result is clairvoyance. Material objects offer no resistance to the passage of astral vibrations, hence by clairvoyance one may see what is transpiring on the opposite side of the earth, or in the homes of the dead. To do this requires the development of the ability to direct the astral sense of sight and the ability to raise from the astral brain the image so received into the physical brain. This is no more negative or disintegrative than is the exercise of memory, which it greatly resembles.

The old hermetic scientists classified telepathy³ as the seventh sense, intuition being the sixth. It certainly presupposes a particular kind of sensitiveness by which the wave motions sent out through space by a person thinking may be intercepted and registered. It would seem, much as in a radio set, that the receiver must be able to tune in, or be keyed to a similar rate of vibration, in order to receive thought messages. Such ability does not depend upon negativeness, but upon sensitiveness or ability to extend consciousness. It is a faculty that may be cultivated without in any manner impairing self-control.

To hear another person speak it is not necessary that we subject our will to his. Neither is it necessary to be in any manner under the control of another in order to hear clairaudiently.⁴ The astral body has organs of hearing, astral ears. Just as wave motions in the air carry sound to the physical ear, so other similar wave motions in astral substance carry astral sounds to the astral ear. The ability to hear clairaudiently may be cultivated much as the ability to hear physically may be cultivated, and exercised with no more injury.

To feel an object which we can touch necessitates a certain form of mediumship, but does not necessitate our being under some other entity's control. Everything has its astral counterpart, which retains as modes of motion the vibrations of its past and present environment. Through the astral sense of touch, called psychometry⁵ these vibrations may be discerned, and their meaning may then be interpreted by the soul. This interpretation when raised into the region of consciousness may reveal all the events that have happened in the vicinity of the object. But this exercise of the psychometric faculty, while requiring alertness and the development of the ability to recognize the sense impressions of the astral body, needs no more irresponsible mediumship than does the physical sense of touch.

Prevision,⁶ the seeing of that which is still in the future, is not dependent upon the disintegrative forms of mediumship. If one is so situated as to observe an aeronaut drop a sand bag from a balloon, he may predict to a friend standing in an adjoining room that in a few seconds a bag of sand will strike the earth at about a given spot. The friend, not seeing the balloon, may be quite startled at the fulfillment of the prediction. Man's astral senses are able to see the various factors converging which culminate in an event.

It should be remembered that all that is ever experienced is retained in the unconscious mind, or soul. This is proved both by hypnosis and by psychoanalysis. Under hypnosis a subject may be made to recall any event of his past, events which are entirely beyond his ability to remember in his normal waking state. Likewise, through the free association method, the psychoanalyst causes his patient to remember events even in minute detail, which have long been forgotten, and which ordinarily could not have been recalled. Whatever man once knows he never loses, for he retains it in his soul. Moreover, what any man has ever known is never lost to the human race, for the record is preserved as modes of motion persisting in the astral world, and may be recovered by any person who can tune in on this record.

With such a storehouse of information to draw from, in addition to the use of the psychic sense organs, previsions, remarkable as they often are, seem less astounding.

These storehouses of knowledge are invariably drawn upon by those whom the world calls geniuses. Usually the genius is unaware of the source of his knowledge and inspiration. Nevertheless a critical comparison of the birth-charts of people who are naturally psychic reveals that any person who has the planet Neptune unusually prominent in his chart of birth may develop the ability to contact and draw information, consciously or unconsciously, from the astral plane. Thomas A. Edison, the inventor, for instance, may or may not have faith in psychic matters, yet he has the Sun and Mercury in conjunction with Neptune, and all exceedingly strong by position, in his birth-chart. This makes it unusually easy for him, through extrasensory perception, to contact and draw information from the inner planes. In fact, of all the geniuses whose birth-charts I have examined up to the present time, I have so far found not one in which a prominent Neptune is absent. It would seem that every imaginable form of knowledge exists on the inner planes of life, and is accessible to those who can raise their vibrations sufficiently to tune in on it. Genius

is the ability to contact such higher planes and assimilate the knowledge so received in such a manner as to be able to transmit it to less capable minds.

Not only do inanimate objects retain in their astral counterparts the impress of the events that transpire in their vicinity, but all organic material retains the mental impress of the life form that organized it. The desires and fears of an animal, for instance, are strongly implanted in the astral substance associated with its flesh. When man eats this flesh its astral vibrations tend to build up and fortify the animal nature within himself. If the animal was slain while in great pain or terror, this influence is incorporated into the astral counterpart of the flesh, and has a tendency to impart a similar vibration to the person eating it.

It is undoubtedly true that the original vibrations of the food one eats may be changed. Yet the food has had its astral vibrations polarized toward the soul of the form of which it was a portion, and so transmits more readily the grades of energy necessary for that form. Now man can obtain the proper chemical elements in organized form from widely different combinations of food. But while any balanced ration may supply him with blood and tissue and also transmit a grade of astral vibrations, still it is found he has greater difficulty in raising the tones to higher octaves of transmission with some foods than with others.

One of the laws of mediumship is that the grade of energy transmitted by anything depends upon the refinement of the substance. The more refined the instrument the higher and more potent the grade of energy that may be transmitted through it. Some foods have become so set in transmitting only the lower octaves of astral force that it is almost impossible to raise their vibrations to a point where they will transmit higher grades. At the same time these strongly polarized foods, such as the flesh of animals, while unaccustomed to transmitting finer forces, are capable of conveying even more readily those energies, which also are very useful in their proper place, that go to build up brute strength and physical force. The higher kinds of vegetable foods, not having been dominated by desires, not so strongly polarized, may more readily be converted into a medium for the transmission of those higher kinds of energy that nourish the intellect and soul powers.

From the laws of mediumship thus far mentioned it may be seen that life depends upon an organization capable of receiving and transmitting complex forms of energy, and the more refined the organization the higher the grade of energy transmitted and the higher the quality of life. Life, Light, and Love originate with God, and the amount of energy, intelligence, and affection any being expresses depends upon its ability to receive, utilize, and transmit some portion of these universal qualities.

In addition to pointing out the general laws of mediumship, I have been at some pains to explain the disintegrative effect of irresponsible mediumship. In the two following chapters I shall take up and explain the methods by which the various kinds of spiritistic and psychic phenomena are produced. But the student should not forget that any phenomena produced on the physical plane by a discarnate entity operating

through a medium under control, might have been produced by the medium without such disintegrative control if he had undergone proper training.

Full instructions on the training necessary to produce such phenomena by the constructive method, and without being under the control of another, will be furnished the neophyte at the proper time. As to the methods by which the faculties of clairvoyance, telepathy, clairaudience, psychometry, and prevision may be developed along constructive lines, these are furnished without cost to all Church of Light members who demonstrate their fitness to use this knowledge by passing examinations on the B. of L. courses.

Notes

1. From a lecture given by Sir Arthur Conan Doyle at Trinity Auditorium, Los Angeles.
2. Book II, Ch. III and VI of *Thirty Years of Psychological Research*, by Richet, and Ch. VII of *Death and Its Mystery*, by Flammarion, are devoted to numerous authentic cases of clairvoyance.
3. For numerous authentic instances of telepathy, see Book III, Ch. II, of *Thirty Years of Psychological Research*, by Richet, and Ch. VI of *Death and Its Mystery*, by Flammarion, p. 91.
4. For authentic cases of Clairaudience see *Thirty Years of Psychological Research*, by Richet, p. 272, and *After Death* by Flammarion, p. 91.
5. For authentic cases of psychometry see *Thirty Years of Psychological Research* by Richet, p. 188.
6. For numerous authentic cases of prevision see *Thirty Years of Psychological Research*, by Richet, Ch. VII, and *Death and Its Mystery*, by Flammarion, Ch VIII and Ch. IX.

Chapter 6

Serial No. 44
Original Copyright 1925
Elbert Benjamine

Copyright
Church of Light
August 2002

Spiritism

Chapter 6

Spiritism

AS IT IS now impossible for the well informed person to doubt the reality of a wide variety of psychic phenomena, there is an increasing demand for their rational explanation. I propose, therefore, to take up, one after another the various types of such phenomena, and elucidate them according to the doctrines of Hermetic Science.

Before doing this, however, it may be well to mention a few of the numerous other ways in which mediumship plays a part in human life.

It has already been mentioned that the active always controls the passive, and that the grade of energy transmitted by anything depends upon its refinement. A water pipe transmits a flow of water because it has a structure suited to such transmission. A copper wire, on the other hand, because of difference in composition and form, will not transmit water, but is a medium for the ready transmission of electricity. A coarse-textured man, because his nervous system and brain are coarser in structure, transmits a grosser form of emotional and sensational energy, and consequently enjoys a form of recreation quite repugnant to the fine-skinned, fine-haired, more sensitive person. The finer the structure and the more highly organized it is, the finer the quality of energy that may pass through it.

In man we find the climax of physical evolution. In his brain and nervous system there is greater refinement and a higher organization than in any other mundane form. As a consequence, man is able to receive and transmit more subtle energies than lower forms of life.

Man A Microcosm

—His physical body is the product of evolution, as the many vestigial structures present in it clearly prove. Embryology also points this out in no uncertain terms, for the human embryo, as do all embryos, briefly recapitulates the history of its ancestry. The life forms through which it has developed are shown in the forming child. In addition to such a physical history, man also contains within himself the history of his soul's evolution through lower life forms. The various traits of character, the

impulses and desires, present in lower forms of life, are all present in man, as psychoanalysis plainly reveals. But for the most part they have been developed, transformed, and sublimated, into something higher and more beautiful. Nevertheless, in man are the vestiges, both of the structures and the tendencies, of innumerable other and lower forms of life.

It is further true, as a study of natal astrology demonstrates, that man has within himself in miniature all that is in the heavens above. The zodiacal signs and the planets, as well as other celestial bodies, have their correspondences within his constitution. When they move they produce discernible changes in man. When they form definite relations to each other, called aspects, man feels differently than he did when such aspects were not formed, and unless he understands the source of his impulses, he may act in response to these feelings.

Because man has within himself something corresponding to all that is below him in the scale of evolution, and correspondences to all in the sky above, and also, it is to be inferred, to all forms of intelligences above him in the evolutionary scale, the ancient Hermetics called man a microcosm. This means that man may be considered a universe in miniature.

Man A Transformer of Energy

—As a microcosm, or little universe, man is able to receive and transmit a very wide variety of energies. In addition to the energy derived from the food he eats and the air he breathes, he is also the medium for countless other forces.

His astral body constantly receives and transmits the energy radiated by the planets. Even as the sun acts as a transformer for the high-frequency energies of space, so man in his turn acts as a transformer of planetary energies. He is also a transmitter of intellectual and spiritual energies that reach him as wave motions from regions of greater intelligence and spirituality. The grade of intellectual and spiritual force he transmits depends upon his mental development and soul unfoldment.

The astral energies radiated by the planets are intercepted by his astral body, being received more freely at those points in his astral structure, as indicated by planets in his birth-chart, that were organized by states of consciousness previous to his birth. These astral energies are even more essential to the welfare of the astral body than is sunlight to the welfare of the physical body. Only a portion of such energies received, however, is utilized by the person. The balance undergoes transformation, or change in frequency of vibration, and is again radiated, much as the sun and planets receive energy of a more general character and giving it a special trend radiate it again.

Likewise, such spiritual and intellectual energy as man receives or generates is again in large measure radiated. As seen by clairvoyant vision this radiation is of two distinct and separate qualities. The more gross astral energies and thought vibrations flow forth to remain in contact with the earth, and may be received in measure by

lower life forms. In other words, the thoughts and feelings of man, as well as certain other astral energies, flow about and permeate the earth, so that other life forms coming in contact with them may receive and appropriate such of them as their organization will permit. In the upward struggle of the seven sub-mundane degrees of life, this force radiated by man and penetrating to the very center of the earth, is of great assistance. It affords these degrees of life from mineral to man whatever of intellectual energies they are capable of absorbing and utilizing. It thus hastens their evolution through providing them with mental nutriment and the incentive to effort.

The other and more spiritual portion of the force radiated by man travels away from the earth and the astral plane immediately surrounding it. There are seven super-mundane realms of life; realms of life whose denizens have never been, and never will be, incarnated on earth. They form a gradation in spirituality of seven steps between man and the angel. Being too spiritual and lacking in penetrative and initiative force for incarnation in gross matter, they depend upon man for all knowledge of material conditions. The higher essences of man's intellectual and spiritual endeavors may be assimilated by them and give them information that is a requisite of their progress.

But now I must return to earth, and to matters that are susceptible of proof by the average man.

Action of Mind At A Distance

—A very common phenomenon, and one that should be understood by everyone so that all may avoid becoming the dupes of unscrupulous practical psychologists, is the exercise of thought power to influence another person's thoughts and actions without the intervention of the spoken word or any sign.

It is possible, for instance, in a public gathering, to concentrate the mind on some person and make him turn and look at one. If the person is known to the experimenter it will be much easier thus to influence him, for a point of contact will previously have been established. But it is possible thus to influence a total stranger. Such experiments which have been rigidly tested out and after coincidence has been eliminated found actually to produce the desired effect, are very simple, but they demonstrate in a very forcible and convenient way that the mind of one person can, and sometimes does, influence another person at a distance.

Further, it is not uncommon for a hypnotist to direct the actions of his subject by mental command alone. There is plenty of irrefutable evidence that this has been successfully done.¹ The various kinds of absent treatments applied by metaphysicians, mental scientists, christian scientists, and new thought practitioners, are practical applications of this power of one person to influence another at a distance.

The thought of one individual sets up lines of force in astral substance which reach

the second individual, and if the experiment is successful, sets up vibrations similar to the thought held, in the unconscious mind or astral body of the other individual. If the person to whom the thought is sent is one who is in the habit of controlling his own thoughts and actions his unconscious mind will repel, and will not accept the thought sent to it, unless it is a thought quite acceptable and perceived to be for his welfare. But if the person has cultivated irresponsible mediumship, or is naturally negative, the thought will enter the unconscious mind and may quite dominate it. The thoughts and actions then will be those willed by the person sending the thought.

No person who habitually controls his own thoughts and actions need be dominated by any other person or entity.² The soul that has built the body about itself, under normal circumstances is quite able to resist foreign invasion from any source. It is aware that to turn around and look at someone who is concentrating on it in a public meeting is not apt to prove detrimental, but it will resist detrimental mental commands even as it would resist them if they were uttered aloud.

Power of Thought to Change Bodily Form

—Once a thought image has been accepted, however, particularly if the image be strong and vivid, momentous results may follow. The physical body is shaped and moulded by the astral body. Normally this moulding is quite gradual, but when the image in the unconscious mind is supported by an unusual amount of energy it brings about such a radical and abrupt change in the astral form that the physical also is drastically transformed. In proof of this, it would be an easy matter to cite numerous instances in which persons have been instantly healed by mental or spiritual treatment, such healing being accompanied by marked changes in the body and its functions. Almost everyone nowadays knows of one or more such cases.

Stigmata

—But this power of the mind, acting through imagination upon the astral body, to make radical changes in the physical, is even more dramatically exemplified in numerous cases of stigmata. Stigmata is the receiving upon the body, through religious devotion, wounds similar to those of which the Nazarene died on the cross. Holes are formed in the palms of the hands and on the soles of the feet, and the side opens as if it had been pierced by a spear. Blood actually flows from these holes, and also often from wounds on the forehead where the Nazarene wore His crown of thorns, being caused solely through the action of the mind.

Saint Francis of Assisi received such stigmata. Yet as he lived so long ago, materialists put the whole matter down as a legend. But cases of stigmata also occur at the present day, and have been thoroughly investigated by competent scientists. The verdict is that stigmata do actually occur, and that they emit blood.³

Speaking in Strange Tongues

—Before leaving the subject of the power of one mind to influence another at a distance, it is well worth recording that a command given in a language that the person influenced does not understand has almost as much force as if given in his own language. His unconscious mind, having much keener perceptions than his objective mind, recognizes the thought behind the words, and tends to be influenced by this thought.⁴

From this ability of the unconscious mind to recognize the import of words of a strange language, to speaking in strange tongues, is but a step. There is no doubt now of the ability of many persons when more or less under the control of a hypnotist or astral entity, to talk intelligently in a language with which they are normally unfamiliar. Such ability is reported to have been common among the saints and early Christian fathers. By certain religious sects at the present day, talking in strange tongues and the ability to heal by laying on of the hands is required of those who claim to have received grace in full measure. To be sure, in many instances this strange speech is unintelligible, but at other times it is really recognizable talk.

In these cases, as in the cases of the saints of old who often had aureoles about their heads, appeared simultaneously in more than one locality, possessed an “odour of sanctity,” had the faculty of prophecy, suffered levitation, and were insensible to fire; it is difficult to determine just how much of the phenomena is produced by the activity of their own unconscious minds and how much is due to the control exercised over them by discarnate entities. In cases of speaking in tongues at religious conversions, I believe, from my own observations, that a high percentage in their emotional frenzy become dominated and controlled by astral entities of some kind.

The Ouija Board

—One of the most familiar approaches to psychic phenomena is by way of the ouija board or planchette. Particularly since the war, during which so many gallant sons and fathers laid down their lives, has the ouija board come into vogue. Little wonder, when the craving is so strong to again converse with loved ones from whom violently parted.

The ouija board and planchette consist of either a flat board or a dial upon which are printed letters, numbers, and perhaps a few useful words. There is a movable pointer so arranged that it may easily be moved over the board in such a manner as to point to the characters on the board or dial. This pointer is of such size that one or several persons may rest their finger tips gently upon it.

In operating the ouija board—and the planchette works practically the same—the most approved method is to place the board upon the laps of two persons, preferably a

lady and a gentleman. The fingers of both are placed lightly but firmly upon the small table which acts as a pointer, this table being on the board and permitted to move freely over it. In a few minutes this small table commences to move; at first slowly, and then with more speed. Thus it is able to talk by touching the letters and characters printed on the board, and if questions are asked it will answer them.

In using the ouija board and similar appliances, the more negative and passive the experimenters, as a rule, the more satisfactory the results. The questions may be asked either orally or mentally and are answered with equal success.

Now, most of the motions made by man are not the result of premeditated thought, but are directed by the unconscious mind. To be sure, we think of walking and then walk. But walking is a very elaborate and intricate process of balancing the action of one muscle against another. That is, the nervous system has been educated to respond with the utmost alacrity to commands issued by the unconscious mind.

Because of the facility with which the unconscious mind can cause unconscious muscular actions, it is easier, in the normal run of things, for the unconscious mind to communicate intelligent thoughts through directing appropriate muscular actions than for it to impress the thoughts directly upon the physical brain. Hence it is that the use of unconscious muscular activity is the easiest method possible, under ordinary circumstances, for communicating that which is in the unconscious mind to the cognition of the physical brain. It is due to this that more people can get psychic messages through the ouija board and such devices than through any other method.

Range of Information of the Soul

—As has been pointed out in the last chapter, the field of information accessible to the unconscious mind is enormously greater than that open to the physical consciousness. All that the person has ever experienced or known is stored up in the unconscious mind. The range of the astral perceptions is infinitely greater than those of the physical senses. It may tune in on almost any imaginable source of information, not only on the record preserved in the astral world of all that man has known and thought, but it may also come mentally in touch with still higher centers of information. Therefore, the questions that the soul of a person using the ouija board may answer intelligently are exceedingly wide in scope. And undoubtedly it is commonly the case that a portion of the information given through the ouija board emanates from the experimenter's unconscious mind.

While such a range of perception and such a storehouse of knowledge may be used by the unconscious mind, it is probable, because the unconscious mind requires much training to utilize a very extensive range, that in many cases a large part of the information received through the ouija board comes from some discarnate entity. This is all the more certain because the astral world about and interpenetrating the earth is so crowded with astral entities who seem to have no objection whatever to taking control of a negative person and manifesting through him whatever of

intelligence, or lack of it, they possess.

Another factor influencing the veracity of psychic communications of all kinds is the susceptibility of the unconscious mind to suggestion. It has been educated to obey the desires of the objective mind. Therefore, if there is a strong desire for a certain type of manifestation, and no controlling entity is present, it quite naturally endeavors of itself to produce the phenomena. If there is a strong desire present on the part of the experimenter to receive a message of a certain kind, or on the part of other persons present, which it is able to perceive, it will try to deliver such a message as is wanted. The message but reflects the desire of someone present, and may be widely at variance with the truth. And even though some other entity is in control and trying to give a truthful and important message, the unconscious mind, under the influence of the desires of those present, may still have power enough to warp the message out of all semblance to its original self. Truthful, serious messages may be expected only when those present are serious, and above all else, desire the truth, however discomfoting it may be.

Factors Influencing Veracity of Spirit Messages

—We now perceive that in all spirit messages there are three factors which may be present in widely varying proportions, and which may have an influence upon the message. There is the unconscious mind of the medium, which may be entirely responsible for the message, or which may have almost nothing whatever to do with it. There is the desire and combined thought force of those present acting upon the subconscious mind of the medium. This may amount to almost nothing in some instances, and in others may be the deciding element. Then there is the presence of one or more astral entities, which may be intelligent or may be ignorant, which may be impersonations and hoaxes, or may be as they represent themselves to be. They may have but partial control of the medium and not be responsible for the message, or they may be in complete control and the sole authors of it. The self-controlled clairvoyant can see these entities and can feel whether or not they are genuine or are wearing a mask of deception, but the irresponsible medium has no way of knowing whether or not his controls are as represented.

Proof of Human Survival

—Undoubtedly those who have once lived on the earth and passed to the next realm sometimes communicate with those yet in the flesh through such simple devices as the ouija board. Ouija board answers usually are trivial and shallow, or but shadow the thoughts of those present. Yet occasionally information is thus received of astounding correctness and great value. Instances are recorded in which such messages have saved lives, and other instances in which information was received

known to no living person. People who have disappeared leaving no trace, drowned without witnesses, have been able to communicate the method of their death and direct searchers to the physical remains.

There are other cases recorded where people have been directed to dig for mineral deposits where there were no surface indications; consequently the location could have been known to no living person, and the mineral deposits so located have proven of great value. These are exceptional cases, it is true, and many a poor dupe has been sent to dig for mineral where there was none. Yet these successful cases can not be accounted for by the theory that the knowledge was transmitted from the mind of some living person. Undoubtedly, as I said, under certain circumstances those physically dead communicate again with the living.

The range of power of the unconscious mind of living man is so extensive that it taxes human ingenuity to the utmost to devise any test by which human survival may be proved. One of the tests, recently devised, called cross-correspondences, is meeting with considerable success. The discarnate personality, through several widely separated mediums, gives fragments of classical quotations, or other matters with which he was familiar when on earth, and of which the mediums are quite ignorant. These fragmentary messages, having no meaning separately, are directed to be sent to the Psychical Research Society, where they are pieced together, and not only make sense, but reveal something that research shows the person giving the message was familiar with, and would naturally use to establish his identity. These experiments are yet in their infancy, yet even so far as they have been carried, they seem to me to establish the survival of the human personality beyond a reasonable doubt.

In these communications which we have been considering, the medium is more or less under control. I shall not violently condemn the use of the ouija board. It does imply, however, loss of control of the body and mind in small degree. In just so far as there is success with the ouija board, precisely so much has disintegrative and irresponsible mediumship been established. Some force other than the normal personality has usurped the power temporarily to use a portion of the astral brain, nervous system, and muscles. It is so much lost in the struggle to command the body and progress in evolution. Yet a few raindrops do not make a river, nor do a few drinks make a drunkard. Many people believe that strong liquor in moderation is more beneficial than the reverse. They admit that excess is ruinous, but contend that the pleasure to be derived from drinking within limits is greater than the harm done the body by the alcohol.

Such persons could with equal logic extend their argument to the use of the ouija board. At least it seems to be the least harmful of negative mediumistic endeavors. As a rule the amount of control is small. And while I know of a few persons who have gone to excess with the ouija board and landed in the psychopathic ward, as also I know certain drunkards who once believed they could "drink or leave it alone," yet I also know hundreds of people who have experimented with the ouija board, and even with automatic writing, which requires a stronger extraneous control, who, from all

appearances, are none the worse for it.

Wise Spiritual Intelligences Use Impression

—Of this, however, I am quite positive; truly wise spiritual intelligences do not make a practice of communicating through a person under control. In dire necessity, on some rare occasion, they may do so, but only because no other avenue is available and the message must be given.

Wise spiritual intelligences, when they are permitted to do so, give their messages by impression. Aware of the disintegrative effect upon the medium of controlling him, they refuse to exercise such control. They merely talk forcefully to the astral counterpart of the person they wish to impress. The astral body is not controlled, but has full knowledge of what is being said and who is saying it. It is a matter of conversation, not always one sided, even as two people ordinarily talk on meeting. This communication, which is given by an astral person—a disembodied person—to the astral counterpart of a person still in the flesh, rises from the unconscious mind into the region of objective consciousness. It may seem, if the person is not accustomed to receiving such impressions, but a vague realization that a certain thing is a fact. If the person receiving the message is a little more advanced in psychic matters, it may rise into objective consciousness as a series of complete and precise sentences, but with no very clear knowledge of the source from which derived. But if the receiver has practiced to develop the ability, he may be as fully aware of who is talking and what is being said as if he were talking to a friend in the flesh.

A great deal of information, and I am sorry to say misinformation also, is given by those of the inner planes to those on the outer plane who delve into occult matters, without the recipient being aware of the source from which his impressions come. He merely feels that something is true, or all at once some information flashes into his mind. I speak of misinformation advisedly, for those who pass to the next plane of life do not immediately become all wise. Until educated away from them, which may be a very long time for one who on earth was very set in his ideas, they still hold to the same beliefs and habits of thought that they held on earth. They may be quite as much in error, and quite as dogmatic about it, as anyone in the world. Only those who keep an open mind and endeavor to learn the unprejudiced truth make rapid progress on the inner planes toward a better understanding of truth than those on earth. And these, invariably, when they find a seeker who is worthy, endeavor to impress him with a knowledge of truth as they have found it. Hence the oft repeated slogan in occult circles that whenever the neophyte is ready, behold, the master appears. But a master teaches, admonishes, and advises his chosen pupil, the same as he would do if he were a spirit in the flesh. No true master places his neophyte, or anyone else, under control.

It is always a joy to the scholarly men of earth to find someone with a desire to

emulate them in the acquirement of knowledge. As I know from observation and experience, those who master difficult branches of learning are ever eager to help the younger student who aspires to acquaint himself in the same branch. And when they find a pupil who shows considerable ability they go to great pains to help him over the difficult parts of the road.

This is quite as true of wise spiritual intelligences. They are always eager to find a pupil who is worthy of instruction. Yet they are not desirous of shouldering all his responsibilities in life, or of advising him on every trivial matter. Each soul should cultivate his individuality and learn to decide his own issues whenever possible. But wise spiritual beings are ever ready to advise us if we indicate by our efforts and aspirations that we are striving to help ourselves. This they do through impression.

Automatic Writing

—Next to the ouija board in popularity is automatic writing. The medium sits at a table with a sheet of paper before him. He grasps a pencil in his hand and places his hand in the position of one writing. He then becomes passive and awaits results. When the controlling entity has succeeded in establishing rapport with the sitter—which really consists of organizing such lines of force between its astral form and the astral form of the sitter that it can communicate its own motions to the form of the subject—the hand begins to write through no volitional effort of the medium, and usually the medium is ignorant of what is being written.

Rapport

—Before going further I should explain more about rapport. Both those in the flesh and those out of the flesh can raise and lower their vibrations temporarily to a certain extent, much as the strings of a musical instrument can be changed in tension. To communicate rates of motion from one entity to another requires only that some of the vibrations of their astral bodies have similar frequencies. This forms a point of contact through which the more active can inject its rates of motion if the frequencies are made synchronous—that is, vibrate in unison, the crest of a wave motion in one corresponding in point of time to the crest of a wave motion in the other. Synchronism is easy when one of the entities becomes passive.

The active entity, once a point of contact is established, injects more and more of its rates of motion into the astral body of the medium. The vibrations of the medium are thus raised or lowered until they very largely vibrate in unison to those of the controlling entity. The entity then has complete control and the medium is powerless.

Rapport is established when the vibrations of one entity vibrate in unison with those of another entity. Rapport does not imply control, for two persons may be in rapport and neither exercise control of the other. Rapport merely facilitates the exchange of

energy, and may be the result of similar rates of energy present due to similar thoughts and similar planetary influences at birth, or it may be produced artificially by raising or lowering the vibrations. Rapport is very important and valuable, but in the case of negative mediumship it is a principle used by the controlling entity for obtaining control of the medium. Once control is gained, the more thorough the rapport the fuller the control.

The astral world is so crowded with entities of different grades and kinds that a call sent out by a medium for a control is quite sure to be answered by something. It may even be answered by the deceased personality who is supposed to be in control. But however the message may be communicated through an irresponsible medium; whether by the ouija board, automatic writing, table tipping, the control of the medium's vocal organs, or in some other fashion; in addition to the probability of some entity exercising control of the medium's body, there is also a possibility that the message emanates from, or at least is colored by, the unconscious mind of the medium or the thoughts, conscious and subconscious, of those present.

In automatic writing the controlling entity, after establishing rapport with the medium, is able to direct the arm and hand in writing whatever it may desire.

Table-Tipping

—In table-tipping⁵ unconscious muscular contractions, such as are used in ouija board communications and automatic writing, are made use of to start with, but there soon develops an additional factor. Those present sit in a circle about a small table, placing their finger tips lightly upon it. Soon the table begins to vibrate distinctly, and when this vibration reaches a certain tension the table begins to move about in a more or less intelligent manner.

It is truly wonderful what power of expression can manifest through a small wooden table. It often moves toward one of the sitters and actually caresses him, or it may manifest enmity through violent gyrations. Someone present asks the table if the control is a certain person long dead, and when the right name is mentioned the table pounds violently on the floor. It answers questions by pounding on the floor or rocking violently to express an affirmative, and slows almost to a stop to express a negative reply. It also communicates by a prearranged code, tapping on the floor, or moving in a certain manner to make itself understood.

The additional factors, of which I made mention, are the electromagnetic emanations of those present, which are used by the control to set the table vibrating and to assist in its movements. The control, through its rapport, or close association with the astral form of the medium, is able to communicate motions set up by it in astral substance to these electromagnetic forces drawn from the sitters. This electromagnetic force may then be directed through the table and its motions imparted to the physical substance of the table.

The use of electromagnetic energy drawn from organic substance, and in the case of table-tipping drawn from the medium and others present, seems to be an absolute requisite for the exerting of physical force by a discarnate entity. Another rule, while perhaps not absolute, yet at least of common observance, is that the more physical force exerted by a discarnate entity the less intelligence it manifests. Clairvoyants and seers of all ages claim that strong physical manifestations of psychic force are nearly always produced by entities low in intelligence, chiefly elementals, but who possess much strength in the lower astral currents. It is truly surprising how many mediums who do healing or produce physical phenomena claim American Indians as controls. They hold that the Indians are closer to the earth and consequently have more power to give strong physical manifestations.

In table-tipping the particles of the table become so charged with energy as to give the impression of being alive. Anyone who has had experience with genuine table-tipping could not be deceived as to whether or not there is a strong psychic influence present, for there is a peculiar vibration in the wood that may be distinctly felt before, and as, the table begins to move. Not infrequently, also, the table is levitated completely from the floor, or continues to rock, while no fingers are closer than several inches above it, and on occasions it moves entirely across the room with no one touching it.

Levitation

—This brings us to the subject of levitation.⁶ The movement of light objects, and also the movement of heavy objects, at a distance from the medium, sometimes at a great distance, and without physical contact of any kind, has been thoroughly established by men of international scientific reputation. Chairs, tables, and many other objects, including sometimes the medium, are lifted into the air and suspended there without visible means of support.

The late Mr. W. J. Crawford, D.Sc., lecturer in engineering at the Municipal Technical Institute, Belfast, by a great number of experiments, established, through placing the medium on a weighing machine, that it is customary for the medium to gain in weight as much as the object lifted; also, that when an object is made heavier than normal, the medium, though at a distance, loses in weight the amount gained by the object. This leads to the conclusion that there is an invisible astral and electromagnetic connection between the medium and the object acted upon. The controlling entity extends the medium's astral body, and this becomes the moulding power by which electromagnetic emanations present are used as energy to lift the distant object or to hold it down. It is as if an invisible and extremely elastic arm reached out from the medium to act upon the physical object.

Other experiments indicate that it is quite common where objects are lifted or moved by invisible forces, for each of the persons present, some more and some less, to contribute to the moving force. Each person in the circle may gain something in

weight when a heavy object like an oak table or a piano is lifted from the floor by an invisible force. The controlling entity is able not only to use the electromagnetic emanations of the medium, but also to use extensions from the astral bodies and the electromagnetic energies of every person present, in more or less degree, in the lifting of material objects. If a sudden shock disturbs the medium, the object will drop to the floor, because the communicating lines of force between the medium and the object have been broken.

It would be stating more than has been proved, and more than is probable, to say that objects are only levitated by pressure exerted by an extension of the medium's astral and electromagnetic bodies. In certain cases of hauntings, which will be discussed in the next chapter, objects apparently move when there is no human medium near, and irrespective of whether or not there are witnesses. It is not uncommon for pictures to be violently thrown from the wall, clocks to stop, raps, knocks, and other physical manifestations to take place at the moment of death of a relative in a distant land.⁷ The dying person may act through the astral body and electromagnetic emanations of some person in the house where the manifestations take place, may use the electromagnetic emanations drawn from his own body, or in rarer instances there may be electromagnetic energy associated with the physical substance of the environment that is available. It seems that it is not always essential for the production of physical phenomena to have a human being to draw upon, but such human is at least present in by far the majority of cases. Certainly, in all cases, there is present an available supply of electromagnetic energy that has been associated with organic life.

If we bear in mind the way in which an extension of a medium's astral body is able to act as a lever to lift objects at a distance, we at once see how an extension of the medium's astral body, which is able to assume any desired form, may hold the medium to the floor. In this way, certain mediums are able to increase their weight at will, although of course, being in a trance state, they know nothing about how the effect is produced.

Spirit Rappings

—We also now are able to perceive how spirit raps⁸ and knocks are produced. These noises in the home of the Fox sisters were the commencement of modern spiritualism. They may occur on a table, on the walls, on the ceiling, or apparently even from the air overhead. When the raps seem to come from a wall or solid object, the wall or object vibrates as if it had received a blow. An invisible projection from the medium sufficiently strong to lift a chair or table, it seems to me, should experience little difficulty in striking a blow that can be heard, or in producing condensation and sudden expansion of the air in limited areas to produce an explosive effect. But in all these cases the noises are, as I believe, produced through electromagnetic motions organized by astral lines of force from the medium, to such a consistency as to be able to communicate motion to physical substance.

Slate Writing

—Slate writing and direct writing⁹ are doubtless produced by extensions of the medium's astral body being used by the controlling entity to establish lines of electromagnetic energy sufficiently strong to write messages with a pencil. Slate writing is usually accomplished by placing a bit of slate pencil between two slates, that have been washed clean, locking the slates together, and giving them to the medium or to some person present to hold. In a few minutes the noise of writing is heard on the inside of the slates, and after a rap is given by the entity as a signal that the work is finished, the slates are opened and found to contain a message signed by some deceased person.

Other writing is produced on blank sheets of paper on which have been placed bits of lead pencil.

Precipitation

—Still another phase of writing is known as precipitation. Cases are on record where blank sheets of paper have been covered with writing, voluminous MSS. containing information unknown to the medium, being so received in a short time. Beautiful pictures also sometimes appear on slates or upon paper in the same manner.

The rapidity with which such writing and such pictures are produced leads to the belief that the controlling entity is able to visualize clearly a whole picture, or a whole page of writing, and to transfer bits of pencil, or the various pigments, to the slate or page almost at once. That matter may be made to pass through matter was first demonstrated by Prof. Zollner and set forth in his book, "Transcendental Physics." The experiments with materializations, to be discussed in the next chapter, indicate that dematerialization of matter sometimes takes place. The bits of pencil used in precipitated writings, and the pigments used in precipitated pictures, may be materialized from non-material substance, or they may be produced by collecting the minute particles of all substances that exist in the air. But more likely they are derived from existing pencils and pigments and are transported to the place where precipitated in a dematerialized state, to assume the normal physical form again when precipitated as writing or as a picture.

In these cases also, the controlling entity undoubtedly uses the astral body and electromagnetic emanations of the medium. It uses them to build such lines of force as will collect and precipitate the proper materials in the form it has visualized.

Extrasensory Perception

—The discovery of Pluto, the inner-plane planet and the planet of statistics and mass production, early in 1930, was immediately followed by the application of experimental methods and statistics to the investigation of telepathy, clairvoyance and precognition by a dozen universities, encouraged by the work of Dr. J. B. Rhine at Duke University. The university scientists now group these and allied faculties of the soul under the one term, extra-sensory perception, usually designated merely as ESP.

Dr. Rhine published his monograph, “Extra-Sensory Perception,” in 1934; Stuart and Pratt published, “Handbook for Testing Extra-Sensory Perception,” and Rhine published, “New Frontiers of the Mind,” in 1937; and in 1940 Rhine, Pratt, Greenwood, Smith and Stuart collaborated in publishing, “Extra-Sensory Perception After Sixty Years.” The painstaking work of these men, and that of other university experimenters, not only conclusively prove that man possesses ability to gain information by telepathy and clairvoyance, but that almost as easily it is possible to gain information of the future, termed by them precognition.

Also coincident with the discovery of Pluto, university scientists began to accept, and use in teaching physics, Einstein’s Special Theory of Relativity. This acceptance is now practically universal.

Relativity holds that time and velocity are always interrelated, that physical velocities cannot exceed that of light, that anything moving with the velocity of light no longer possesses length, has infinite mass, and for it time has come to a standstill. Yet in the region where the soul chiefly functions, on the inner plane, or astral world, velocities are greater than those of light, and there consequently is a different order of gravitation, a different order of distance, and a different order of time.

This slower time of the inner plane enables us in a logical manner to account for both postcognition and precognition: Seeing something as it existed at some particular instance in the past or as it will probably appear at some particular instant in the future; which the university scientists prove man sometimes actually does. When we move our consciousness to the inner plane—the realm in which life normally functions after physical death—where velocities are greater than those of light, an infinite number of events can be condensed into one moment of this stand-still time and we are able to see backward and forward along the time-flow of external life and observe or have in one moment, experiences which in the rapid time of external life would occupy days, months or even years.

Relativity also makes clear why the inner-plane high-velocity, slow-time region cannot exchange energies with the low-velocity, fast-time region of outer-plane existence directly, but that all contact between the two must be made through Boundary-Line electromagnetic energies which have approximately the velocity of

light. The various relations of inner-plane existence and outer-plane existence are set forth in full detail in Course 4, *Ancient Masonry*, Chapters 9, 11 and 13, Course 11, *Divination and Character Reading*, Chapter 1, and Course 20, *The Next Life*.

Seance Rooms

—Now, before closing this chapter, as I have repeatedly referred to irresponsible mediums and their seances, I should perhaps give a certain warning to the less experienced about seance rooms. Every person should, it seems to me, avail himself, if the opportunity arises, of seeing some genuine psychic phenomena. People of a scientific turn of mind and positive makeup can investigate mediums with impunity. Persons less positive readily become influenced by astral entities if they attend seances, it is particularly true if they attend developing circles.

It is quite common for the entities controlling the medium to use the astral and electromagnetic energies of the medium to crush any resistance offered to their control of other persons present. They also use these energies to form a point of contact with persons present, following them home and endeavoring to make the contact permanent and take full control. If such a person is mediumistic or sensitive, the astral entities may gain a power of influence, even though the person is unaware of it. Such a person, if no more serious influence is experienced, gets the seance habit, and runs to a medium for advice on every trivial occasion. He becomes a seance addict. The seance room, while it serves a useful scientific purpose, is not without its dangers.

Notes

1. *Death and Its Mystery*, by Flammarion, Chapter V.
2. Explicit instructions for protecting oneself from the mental influence of another are given in Course 9 *Mental Alchemy*, Chapter 7.
3. *Death and Its Mystery*, by Flammarion, Chapter V.
4. Ibid.
5. For authentic examples see *Thirty Years of Psychological Research*, by Richet, p. 401.
6. Abundant authentic instances of levitation are given in *Thirty Years of Psychological Research*, by Richet, p. 421.
7. For authentic instances see *At The Moment of Death*, by Flammarion, Chapter IX.
8. For authentic instances see *Thirty Years of Psychological Research*, by Richet, p. 443.
9. For authentic instances see *Thirty Years of Psychological Research*, by Richet, p. 448.

Chapter 7

Serial No. 45
Original Copyright 1925
Elbert Benjamine

Copyright
Church of Light
August 2002

Phenomenal Spiritism

Chapter 7

Phenomenal Spiritism

BEFORE discussing the weird subject of haunted houses, and the astounding discoveries recently made in regard to materializations, it will probably be best first to explain certain phenomena of more common experience.

Among these, and having occurred to some member of almost every family at some time, are monitions. Monitions differ from premonitions in that while they denote a recognition of some event or condition that could not be known by the normal faculties, they do not anticipate future events.

These monitions generally occur at the time of an accident to an acquaintance, at the time of the illness of some person not present, or at the time of some absent person's death. But sometimes they occur concerning trivial matters. They occur to persons who are not generally regarded as unusually sensitive, and who, perhaps, have had no other such experience in their lives.

More commonly there are no objective phenomena. The person receiving the monition sees the image of a distant friend, or hears the friend calling him, or hears a loud knock on the wall, or has a dream in which he sees the friend dying or meeting with an accident. Later the news comes that the friend actually has died, or has had an accident.

Thousands of people have had such experiences, and there is a multitude of authentic cases on record.¹

Premonitions

—Premonitions, also, are of everyday experience. There are numerous authentic records² in which, without knowing a certain person is approaching, and perhaps not having seen him for a long time, other persons will commence to talk about him, and be very much surprised when he puts in an appearance. At times someone will see the phantasm of the approaching person so plainly for a moment as to think it an objective reality, and believe he actually sees the person in the flesh, until he appears and disclaims having been in that vicinity before. Sometimes a person usually normal sees a friend enter a distant building at a certain hour of the day, which he times, and later verifies from the friend that he actually entered the building about that hour. Sometimes an acquaintance is seen talking to a stranger, at a place beyond the normal powers to discern, and later upon describing the place and the stranger, the acquaintance verifies the description as accurate. Happenings seen in dreams,

also, not infrequently are found to be records of what has actually transpired, or what actually later comes to pass.

Recorded cases of this kind are so numerous that a book might easily be filled with them. They reveal that the astral body has sense organs by which it may recognize that which is happening at a distance.

In the case of accident, or the death of an acquaintance, it is highly probable that there is a conscious or subconscious desire on the part of the person dying or hurt to communicate this information. The wave motions thus sent out are intercepted by the person receiving the information. In other cases it seems that the clairvoyant faculty, or other astral sense organ, has perceived the happening or condition and made the astral brain aware of it. Conditions then have been favorable for the astral brain to impress this information on the physical brain and obtain a conscious recognition of it.

Because of the difficulty experienced by the astral brain in impressing information perceived by it upon physical consciousness, it often makes use of symbols. Because of the association of thoughts, one thought, or image, suggesting another, the astral brain often finds much less resistance to presenting information in symbolic form than to presenting it as conversation or as an image of the happening. It is sometimes easier for it, for instance, to produce the sensation of smelling a strong pipe, to acquaint a person of the astral presence of someone who before death smoked a strong pipe, than to show a phantasm of the person, or to cause his voice to be heard. Symbolism is the easiest method, and the most common one, by which the astral brain transmits information to the everyday consciousness.

But whether it makes use of symbolism, or some more direct method of apprising the external consciousness of something, it is frequently not able to gain the recognition of the external consciousness at the time the information is first perceived. It may be hours, days, or even weeks, after the astral brain recognizes some important fact, before it finds suitable conditions—such as unusually sound sleep, or sufficient lack of alertness to facilitate some involuntary movement—for transmitting the knowledge to the physical brain.

Not all monitions, and not all premonitions are confined to subjective phenomena. Sometimes several persons present see the same vision, or hear the same knock or disturbance, and sometimes physical objects are moved with no one touching them.³ In such cases either an astral entity, or the astral brain of some person present, uses the electromagnetic emanations of those present to cause a movement of physical matter. Electromagnetic energy derived from organic substance, and preferably from a living person of mediumistic temperament, so far as is now known, is an absolute requisite for the psychic production of movement without physical contact.

In all cases the controlling entity, whether it be the astral brain of some person in the flesh, or some discarnate entity, or merely a strong thought-form, does not generate the energy used. By establishing proper rapport with a source of energy it merely directs it into a given channel. It acts on much the same principle as the electrician

who closes a switch that permits an electric current to flow through and set in motion ponderous machinery. The electrician need not be strong to do this, neither need the controlling entity be strong to produce startling physical manifestations of psychic phenomena. The entity needs a sufficient supply of electromagnetic energy that has been generated through organic processes, and needs to effect a rapport with the astral substance associated with it. The electromagnetic energy is directed by means of the astral substance associated with it, and when rapport has been established this astral substance may be controlled, if no opposing intelligence is also in rapport with it, with very little effort and in a surprisingly effective manner.

Bilocation

—Similar principles are involved in cases of bilocation. Bilocation takes place when a person appears simultaneously in two different locations. The lives of the saints, and other legendary literature, abound with mention of such cases. Authentic cases are also known at the present day.⁴ The double, which appears at a distant spot and perhaps to several persons, and sometimes even moves objects, may be the astral body, or it may be a thought-form.

A thought is primarily certain rates of motion in astral substance that assume a form. Such an astral thought-form may, or may not, be vitalized with electromagnetic energy. That thoughts are capable of communicating such motions is demonstrated through the photography of thought-forms by Dr. Baraduc of France and others. If one person thinks strongly of another, the image of the thinker will be conveyed through astral vibrations to the astral brain of the person thought of. If the person thought of is receptive, his astral brain will perceive this image of the thinker, and if he is accustomed to bring up into everyday consciousness the things he perceives in the astral—if he is sensitive—these rates of motion will be communicated to his physical brain and he will apparently see the person doing the thinking.

Another person, who is not a sensitive, may be present and perceive nothing. But if the thinker has the ability to impart strong electromagnetic motion to the thought-form it is possible to set up such electromagnetic oscillations that it will register as a transparent image upon the physical organs of sight of those who are not in the least psychic. The person may thus be seen distinctly by many people at a long distance from his body. But really he does not leave the physical, only projects a thought-form vitalized with electromagnetic force. By this means he may appear simultaneously in several localities at the same time.

Astral Travel

—Yet only a portion of the cases of bilocation can be explained as thought-forms. In other cases, undoubtedly, the person is traveling in his astral body. The electromagnetic emanations of a person may be sent to a distance, or may be used by

the astral body to build up a visible form at a long distance from the physical body, but the etheric body, being continuously dependent upon the life processes of the physical, never leaves the close proximity of the physical form. The astral body, however, is not so restricted, and during physical life may almost entirely leave the physical body. When so absent it is connected with the physical by a very thin line of force in astral substance.

The astral body when absent from the physical may visit the homes of the dead in astral realms, may attend schools on either plane and bring back the memory of what has been seen and heard, or may visit distant physical or astral lands. Full instructions for developing the ability to do these things are presented in the MS., "How to Travel in the Astral," which is given without charge to all members of The Church of Light who pass the final examinations on eleven courses of study. This astral body, being occupied by the mind, or soul, when it appears at a distant place is able to carry on intelligent conversation, which a thought-form can not do. The physical body, meantime, acts in a purely mechanical and automatic manner. In order to become visible to the physical sense of sight, or to move physical objects, the astral body utilizes the electromagnetic emanations of its own physical body, or the electromagnetic emanations of the persons to whom it appears, or who are in the vicinity of the objects moved.

It should be understood that these electromagnetic energies used by astral entities both in the flesh and out of the flesh to produce physical phenomena, are generated by organic life. They are emanations from the etheric counterpart. This etheric counterpart never leaves the physical replica. It is sometimes taught that an etheric "shell" may be drawn from the dead physical body and used to simulate the deceased person. I believe such teaching to be an error, and a close study of the biological processes that generate and maintain the etheric bodies of organic life leads me to conclude that the etheric body is so closely associated with, and dependent upon, the chemical processes of the physical that it never leaves its immediate vicinity.

At death the astral body of man usually severs its connection with the etheric body. The etheric body then has no more intelligence than the physical corpse. It is, in fact, the vitality of the physical body. After death there is still some energy radiated by the corpse until it dissolves, but as the physical body disintegrates so does the etheric body. It might furnish some energy to an astral entity if a point of contact could be established, but not nearly so potent as may be derived from a living person. Its organization is possible only so long as the cells of the body carry on their life processes, for from them it draws its energy. Until the body disintegrates it may hover over the corpse, and is often seen as phosphorescent light. But I have every reason to believe that it cannot be disconnected from the corpse and used as a vehicle for magical work, or control a medium for the purpose of impersonation.

Etherealization

—In a seance room, and sometimes elsewhere, an astral entity—which may be either a deceased person or one yet in the flesh or a non-human intelligence—by getting in rapport with a medium's astral body may be able to utilize the electromagnetic energy present to rarefy the atmosphere in limited areas and set the atmospheric particles in such rapid vibration as to produce a luminous effect. This luminous area may take the form of a hand or face, or even a human figure. Such a manifestation is called an etherealization.

Or the entity may set the ether to vibrating in a certain spot with the frequency of light. This light may then be moved about the room. Such lights are not infrequent at spirit seances, and are sometimes also seen elsewhere.

Spirit Photographs

—From etherealization to spirit photographs is but a step. If there is a figure present luminous enough to be seen, it probably also can impress a photographic negative. In point of fact, faces of the deceased, messages written in their own handwriting and signed with their signatures, and relating things that only they could know, appear on photographic negatives even when they are invisible to the human eye. Some astral entity has succeed in utilizing the electromagnetic emanations of those present to set up rates of motion in the ether that impress the negative much as light would do. A photographic negative is much more sensitive to certain high light vibrations than the human eye. So while it is not uncommon for the presence photographed to be seen by persons in the same room, yet it may also be photographed while invisible to the human eye.⁵

Other than human astral entities may likewise be photographed. There are myriads of magnetic elementals, nature spirits, and such creatures, so dense in their structure and so close to the earth that it takes only a moderate development of clairvoyance to see them. Fairies, pixies, and the like are not mere fables. Their power, no doubt, has often been exaggerated; for it is doubtful if they are able in any manner to affect human life and destiny except through rapport with, and at least partial control of, some human medium. Nevertheless, they exist as astral entities. As such, through rapport with a human medium, they may collect about themselves sufficient of the electromagnetic emanations of the medium to become visible to physical eyes, and to impress a photographic negative with their pictures.⁶

Inspirational Speaking

—Another phase of mediumship, one of the most common in fact, is inspirational speaking. A medium takes the rostrum and goes fully or partially under control. Some astral entity may direct the speech that follows, but far more frequently the astral brain of the medium simply receives the thought emanations from the astral brains of the audience. These thoughts—which are not only the conscious opinions of the audience, but also the information contained in their astral brains—are constantly radiating their energy through the astral substance. They are received by the medium's brain and become the source of his inspiration. He gives back to the audience their ideas and opinions colored by his own.

Test Readings

—In test readings also, although the medium may have a wider source of information, it is common for the information to be gathered from the minds of the clients. The medium, of course, knows nothing about the source of information. Yet when a question is asked or written, whatever information about the subject is present in the astral brain of the client is radiating energy through astral substance. The medium then tunes in, unconsciously, on these wave motions and combines the various factors so received in a manner that will give a plausible answer.

Trumpet Speaking

—Trumpet speaking is still another rather common form of mediumship. The controlling astral entity in such manifestations utilizes the electromagnetic force present to produce motions in the atmosphere within a trumpet or megaphone that give a rate of vibration similar to that used in speaking. These compressions and rarefactions produce the same effect as some one talking. The trumpet is often picked up by invisible hands and carried about the room, talking, singing songs, and laughing. It is probable that the astral vocal chords of the medium, or the entity, are actually placed in relation to the trumpet just as they would be in speaking through it physically. About these astral vocal chords are attracted compressed air or other atomic matter of sufficient consistency to be used to produce the effect of a physical voice speaking through the trumpet.

Apports

—The carrying of physical objects long distances through no physical agency is a

more rare phase of mediumship. Objects obtained in this manner are called *apports*.⁷

The most astounding phenomena in connection with such *apports* that have come to my attention were those produced some years ago at seances held in Australia under the leadership of the late Mr. Stanford.

The medium was stripped and searched and taken into a room specially prepared by the investigators with the view of making deception impossible. Under such conditions antiques and other objects of considerable volume and weight, upon demand, suddenly appeared in the midst of the investigators, apparently being pilfered from countries sometimes thousands of miles distant.

To produce such an effect it is necessary not only that the astral body of the medium be able to travel to the spot where the *apport* is located, but also that he organize lines of electromagnetic force from his physical body to his distant astral body. This electromagnetic energy, then, must be used as a magnetic force to polarize the protons and electrons within the atoms of the object to be transported. The object when thus reduced to its electronic state may be moved with the speed of electricity along the lines of electromagnetic force established by the medium. In this dematerialized state physical things would offer no resistance, no more so at least than to radio waves, and the object could be transported into a locked room as easily as anywhere else. Then when it had reached its destination, if the polarizing force were removed the object would resume its normal shape and properties.

Many years ago Zollner, professor of physical astronomy of Leipzig, experimenting with the medium, Slade, had proof of the movement of objects without contact, and also that matter could be made to pass through matter. This was set forth in his book, *Transcendental Physics*, now unfortunately out of print. At the present time, since it is known that the electrons of what appears to be solid matter are relatively as far apart as the planets of the solar system—there being about as much space for the particles to pass as there is in proportion to their size for the planets to pass each other—the mystery of matter passing through matter is not so great. If the force used to suspend the motion of the electrons were similar to an electric force, the electrons would not retain their original relative positions, and the form would be completely destroyed. But if the movement of the electrons can be suspended, say, by something similar to a magnetic force, then when matter has passed through matter and the magnetic force is removed, they again resume their original motions, and there appears the original object.

Materialized Flowers

—It is difficult to say just what percentage of the flowers that so often suddenly appear, apparently out of space, in a seance room, are really *apports* and what percentage are materialized flowers. Probably the most of them have been culled from someone's garden and brought to the room by invisible agencies as *apports*.

On the other hand, it is not impossible that flowers are at times actually materialized. This is not more wonderful than that the materialized form of Katie King should give Crooks a lock of her hair, or that the materialization Phygia should permit Richet to cut hair from her head, or that Mme. d'Esperance should allow sitters to cut off pieces of the materialized draperies surrounding her.⁸

Perhaps I may here be pardoned for relating a personal experience: Many years ago some persons of my acquaintance held regular private seances at which they sometimes beheld wonderful phenomena. At one of these circles a person present wished a token from a loved one long dead. Slate writing was a common thing in the circle and slates were present. The controlling entity told the lady making the request to take off her wedding ring and lay it on the slate. This was done, and the slate kept in full sight, although given no special notice as some of those present were engaged in conversation. Presently, on taking up the slate, the lady found a beautiful golden rose painted on it. This rose, which expert jewelers pronounced gold plating, was as perfect twenty-five years later as on the day it was painted.

The discarnate person was very fond of roses. Evidently the electromagnetic forces of the medium were directed by some astral intelligence in such a manner as to overcome the cohesion of some of the atoms of the gold ring and place them in the desired arrangement to form a rose. It was a case of precipitation in which gold was the substance used.

Materialization

—This brings us to the most wonderful of all psychic phenomena—to materialization.

The evidence for the genuineness of materializations is voluminous and quite irrefutable. As a rule they do not form instantly, but gradually condense from a white nebulous vapor about a nucleus. This white vapor, called “ectoplasm”, from two words meaning “outside”, and “form”, is a condensation of the emanations from the medium's body. It is really an extension of the medium's astral body about which physical particles are collected in such a manner as to give it temporarily, and sometimes permanently, the properties of physical substance.

The startling thing about ectoplasm is that it seems capable of assuming the form, shape, and properties, not only of any conceivable inorganic substance, but also of any conceivable living organ or organism.

Quoting from “Thirty Years of Psychical Research”, by Richet:

In any case we can, thanks to the experiments of Crawford, Ochorwicz, Mme. Bisson, and Schrenck-Notzing, form some idea of the genesis of these phenomena, and sketch out a kind of embryology. This embryo-genesis may not be identical in all cases, but in some that have been exactly observed and illustrated by photography, a kind of nebulous, gelatinous substance exudes from the medium's body and

gradually is organized into a living, moving form. The ectoplasmic cloud would seem to become living substance while at the same time veils develop around it that conceal the mechanism of its condensation into living tissues (page 491).

I have also, like Geley, Schrenck-Notzing and Mme. Bisson, been able to see the first lineaments of materializations as they were formed. A kind of liquid or pasty jelly emerges from the mouth or the breast of Marthe which organizes itself under degrees, acquiring the shape of a face or a limb. Under very good conditions of visibility, I have seen this paste spread on my knee, and slowly take form so as to show the rudiment of the radius, the cubitus, or metacarpal bone whose increasing pressure I could feel on my knee (page 467).

In the experiments of Sir Wm. Crookes with the medium Home, everything witnessed took place in the light, and materializations were frequent. His experiments with the medium Florence Cook and the materialization which called itself Katie King were even more conclusive. His letter of March, 1874, says:

I have at last obtained the absolute proof I have been seeking. On March the 2nd, during a seance at my house, Katie (the apparition), having moved among us, retired behind the curtain and a moment later called me, saying, 'Come into the cabinet and raise my medium's head.' Katie stood before me in her usual white robe and wearing her turban. I went toward the bookcase to raise Miss Cook, and Katie moved aside to let me pass. Miss Cook had slipped down, and I had the satisfaction of seeing that she was not dressed like Katie, but was wearing her usual dress of black velvet.

Crookes says further:

Katie is six inches taller than Miss Cook; yesterday with bare feet, she was four and one-half inches taller. Her neck was bare and did not show the cicatrice that is on Miss Cooke's neck. Her ears are not pierced, her complexion is very fair, and her fingers much longer than those of Miss Cook.

Richet, speaking of a seance he held with Eusapia Palidino, at which Mme. Curie was present, says:

It seems hard to imagine a more convincing experiment, for in twenty-nine seconds the element of surprise is eliminated. In this case there was not only the materialization of a hand, but also of a ring. As all experiments demonstrate, materializations of objects, garments, and woven stuffs are simultaneous with human forms, these latter never appearing naked, but covered by veils which are at first white semi-luminous clouds which end by taking the consistence of real woven fabrics.⁹

Many scientific men of international reputation have experimented with numerous materializing mediums and found them genuine, as did Geley who, "after describing very precisely the variations in the gelatinous embryo-plastic mass, adds: 'I do not say merely, There was no trickery, I say, There was no possibility of trickery. Nearly all the materializations took place under my own eyes, and I have observed the whole of their genesis and development.'"¹⁰

Baron Von Schrenck-Notzing in his book, "Phenomena and Materialization", gives a critical account of his own very extensive experiments, and illustrates it with reproductions from 225 photographs of materialized forms in all their various stages of development as they exude from the medium and take human shape.

Although no further evidence is necessary to make certain the fact that materializations actually take place, still more recent experiments leave no possible loophole of uncertainty. I quote from Richet:

Plaster Casts of Materializations

—Geley and I took the precaution of introducing, unknown to any other person, a small quantity of cholesterin in the bath of melted paraffin wax placed before the medium during the seance. This substance is soluble in paraffin without discoloring it, but on adding sulphuric acid it takes a deep violet-red tint; so that we could be absolutely certain that any moulds obtained should be from the paraffin provided by ourselves. We therefore had certain proof that the moulds obtained could not have been prepared in advance but must have been produced during the seance itself. Absolute certainty was thus secured.

During the seance the medium's hands were held firmly by Geley and myself on the right hand, and on the left, so that he could not liberate either hand. A first mould was obtained of a child's hand, then a second of both hands, right and left; a third time of a child's foot. The creases in the skin and the veins were visible on the plaster casts made from the moulds.

By reason of the narrowness at the wrist these moulds could not be obtained from living hands, for the whole hand would have to be withdrawn through the narrow opening at the wrist. Professional modellers secure their results by threads attached to the hands, which are pulled through the plaster. In the moulds here considered there was nothing of the sort; they were produced by a materialization followed by a dematerialization, for this latter was necessary to disengage the hand from the paraffin 'glove'.

These experiments, which we intend to resume on account of their importance, afford an absolute proof of a materialization followed by a dematerialization, for even if the medium had the means to produce the result by a normal process, he could not have made use of them. We defy the most skillful modellers to obtain such moulds, without using the plan of two segments separated by a thread and afterwards united.

We therefore affirm that there was a materialization and a dematerialization of an ectoplasmic or fluidic hand, and we think that this is the first time that such rigorous conditions of experiment have been imposed.

I may add that the experiments were continued, and casts of folded hands were obtained. Reproductions from photographs of some of these casts are given in the

“Scientific American,” for November, 1923.

It remains but to be said, in regard to the nature of the materializations, that once formed there is a circulation of the blood, warmth, perspiration, and the other functions exhibited by ordinary flesh and blood, as well as intelligent action. Small pieces of skin left behind when a form dematerialized has been found under the microscope to differ not in the least from ordinary human cuticle. A full formed materialization is actual human flesh and blood as long as it lasts.

In regard to the method by which materialization is accomplished, I believe in all cases the form condenses about a projection of the medium’s astral body. The atmosphere contains all the elements of which the body is composed in minute states of subdivision. Such particles, no doubt, may be utilized to assist in building up the materializing form. But recent experiments go to show that in some instances, at least, the material is drawn from the medium’s body. Mediums have been weighed before a materialization has taken place, and then again while there was a materialized form present. A comparison of the weights indicates that substance is subtracted from the medium’s body. The materialized form, in such instances, approximates in weight the amount lost by the medium. Further, in some instances weighing shows that others present at the seance also lose weight during the manifestation, indicating that they likewise furnish substance for the materializing form.

It appears, then, in those cases in which the materialization is quite bulky, that commonly flesh and blood from those present, chiefly from the medium, is dematerialized, and then gradually materialized about an extension of the medium’s astral body. This projection of the medium’s astral body may assume any shape, and the materialization will conform to it in contour and texture. When dematerialization takes place the flesh and blood extracted from those present is returned to the original owners.

Not only at seances, but also where there are hauntings, a peculiar cool draught, a draught that gives the impression of rapid evaporation rather than of moving air, is commonly felt just before there are physical manifestations. Such a draught is really the sensation felt when electromagnetic energy is drawn from the person to supply it for the manifestation. In the case of materializations this electromagnetic energy is used to dematerialize physical substance and with it build up a different form. So far as investigations have gone it would seem that all materializations are composed of substance that has not been created at the moment, but that has been drawn from some other already existing matter.

When a complete personality materializes, the astral body of the medium is almost wholly absent and occupying the materialized form. Even as when a person travels in the astral body, only a slight line of communication may connect the astral form and the physical body. Should this line be severed, death ensues. Therefore, it is quite dangerous to the medium unexpectedly to grab a materialized form, and quite dangerous to a person out of the physical body in sleep rudely to awaken him. In

either case the shock if severe enough may sever the astral thread connecting the two bodies, or at least cause severe injury to the nervous system.

Hauntings

—A different order of phenomena from any so far considered are hauntings.¹¹ Hauntings, while of numerous kinds, may roughly be classified in four categories. There are hauntings that only occur in association with some particular person or some particular type of person. There are other hauntings which are not associated with some person or particular type of person, but are associated with some particular locality. Both these phases of hauntings sometimes are obviously associated in some manner with a person who has died or been killed. Both phases, likewise, sometimes occur under such circumstances as to show no association with a dead person, and, indeed, to make such association extremely unlikely.

Localities that are haunted independent of the presence of a person of mediumistic temperament, and which indicate the influence of a dead person, usually are places where death has taken place under great stress of mind. More rarely the place haunted is a locality where the deceased long resided previous to death.

The intense emotion, or mental attitude, chains the astral body to the particular spot, which has become permeated with the electromagnetic emanations of the person during life. These electromagnetic emanations, with which rapport has never been completely severed, enable the entity to exercise considerable physical force. Doors may be opened, physical objects moved, or some tragic event may be performed in pantomime. When a person goes to sleep after working unusually hard at some routine employment he often repeats the work over and over again in his dreams. A ghost, such as I have mentioned, because something has been impressed strongly on his emotions, for a very similar reason repeats some act over and over again. He has not freed himself from a strain to his mentality. He is said to be earthbound.

Other ghosts appear only in the presence of persons of mediumistic temperament upon whose electromagnetic emanations they draw for force enough to make their presence known. They, likewise, may be earthbound human beings, not yet freed from some intense emotion. They may be attached to the locality of death, to the place where they resided before death, or occasionally can manifest themselves at other places through being able to use the electromagnetic emanations of a person to whom they are attached.

As a rule a ghost possesses almost no intelligence, because it is wholly under the control of and dominated by the idea that binds it to earth. It is like a hypnotized person who has been put to sleep and told to do some one thing over and over. The hypnotic subject does this, and pays no attention to anything else, being quite oblivious to the presence and questions of others. Ghosts of this class are deceased human beings under the influence of powerful auto-suggestion.

If they can be induced to talk they may be convinced of the error of their ways and go about their business in the astral world and cease to burden the earth with their presence. But it is like trying to argue with a subject in the deep hypnotic state. Usually they can perceive only the idea that dominates them. If the idea is to perform some physical task, such as returning stolen money or giving some information, as soon as this is accomplished they haunt no more and pass into other regions on the astral plane.

Differing from the above in that they show no association with a person who has died are the so-called poltergeist phenomena.

Noises, uproars, the throwing of sticks and stones by unseen hands, the opening and closing of doors by invisible agency, the movement of furniture and breaking of crockery without physical contact, and other phenomena of a trivial or mischievous character are rather more numerous than most people suppose. This class of phenomena is usually due to non-human astral entities called elementals.

In far the more numerous cases of this kind the phenomena take place only in the presence of a certain person, who is often an adolescent boy or girl.

Mischievous astral entities are able to get in rapport with such persons of unusual mediumistic tendencies and use their electromagnetic emanations to manifest physical violence. In some instances it is also quite possible that the astral counterpart of the mediumistic individual has a part in directing the phenomena. When the mediumistic individual departs from the vicinity, in these cases, either the phenomena follow the medium, or cease.

In still more rare instances these poltergeist phenomena take place in certain localities irrespective of how many persons are present, and irrespective of any person being in the immediate vicinity. If people take notice of the phenomena, or of a human ghost, electromagnetic energy sometimes is drawn from them to strengthen the manifestation, their thoughts establishing a line of communication for the transfer of energy. Such phenomena are made possible through the electromagnetic emanations of people's thoughts being made use of by elementals. These thought-forms may converge at certain places due to a variety of causes. A building so haunted, or one haunted by a human ghost, when torn down usually destroys the condition of rapport, and there being no adequate supply of electromagnetic energy to draw upon, the phenomena cease.

Fake Mediums

—Let us now return to the subject of mediums. It should be understood that a demonstration of mediumistic power requires the expenditure of energy. The medium himself radiates a limited supply of electromagnetic energy, and other persons present also a limited amount. Enough energy is only occasionally available to make a thrilling demonstration. But the public, ignoring this fact, demands that the

medium repeat the phenomena every time he is asked. This is just as sensible as to ask an athlete who has established a world record as a foot racer to repeat his best work on all occasions.

Certain conditions are necessary for the athlete to establish a record, and certain conditions are necessary for a medium to do his best work. If, because a medium cannot under different circumstances and at different times repeat his performance, we assert his claims are false, we also should demand that a world champion runner be able to make his record again any time we suggest, without going into training, without spiked shoes, and on the pavement or in the mud. As a matter of fact, an athlete is seldom able to reach his record more than once. Likewise, if a medium once produces genuine phenomena, about which there can be no doubt because all possibility of trickery has been guarded against, this establishes the phenomena as real.

It has been objected by some that the condition of darkness imposed at some seances is merely to facilitate fraud. Yet the same criticism might be leveled at radio operators. Radio messages do not carry so well in sunlight as in darkness, and strange to say some radio operators claim that moonlight is beneficial to radio work. They say that a message will carry farther from east to west when the full moon has just risen than at any other time. Yet why admit that a noon day sun interferes with radio and not admit that it may interfere with psychic phenomena?

It is related of the famed discoverer of photography that in order to bring his invention before the public he desired to take a photograph of a famous court beauty. He diligently explained the condition that was necessary: that he could only take the picture by sunlight. As the lady knew she appeared to better advantage by the false light of the evening ball-room, she insisted her picture be taken by lamplight. As the inventor could not take the photograph as demanded, he was laughed out of court, and his discovery called a hoax. All the evidence goes to show that it takes more energy to produce physical manifestations of psychic phenomena in the light than it does in the dark.

To be sure, it is probable that any good medium will perpetrate frauds under given circumstances. We might almost say that in negative mediumship unless the medium is sufficiently under control to be quite unaware of what he is doing the results are not of the best.

A hypnotized subject tries to do whatever he is told, and even though he is going through a lot of nonsense, believes he is performing as he is told to do. If he is told to smoke a cigar, and no cigar is at hand, he will proceed to smoke a stick, and if he has no match, goes through the motion of lighting one, and is unconscious of the fact that he is not strictly carrying out his orders.

Of course there is no excuse for mediums who premeditate fraud. But once a medium is in the trance state he is no more responsible for his actions than is a hypnotized subject. If those present demand a certain type of phenomena, this suggestion takes hold of the mind, and he tries to produce them. He may be able to produce genuine

phenomena, just as the hypnotized subject would actually smoke a cigar if one were present. But if genuine phenomena are not forthcoming, the suggestion to produce them has the effect of causing him to stimulate them to the best of his ability. For this he is nowise responsible, for one of the essential conditions of this kind of mediumship is that the medium must be unconscious of and irresponsible for his actions while under control. If fraud takes place, which is not prepared for in advance by the medium, the only ones at fault are the experimenters, whose duty it is to make fraud impossible.

Even in clairaudience, clairvoyance, psychometry, telepathy, and prevision, the irresponsible medium only hears, sees, feels, thinks, or has cognizance of, what is imparted to him by his control. Everything is second hand, and depends for its veracity upon both the integrity and the ability of the controlling entity. On the other hand, the person who develops these faculties by the integrative method is not dependent upon another for information. He uses his astral sense organs as he does his physical sense organs. He controls himself and his faculties. This is the difference between disintegrative mediumship and mastership.

Notes

1. Many authentic cases of monitions are given in *Thirty Years of Psychical Research*, by Richet, Ch. VI; and in *At the Moment of Death*, by Flammarion, Ch. VI.
2. For authentic cases see *Death and Its Mystery*, by Flammarion, Ch. IX.
3. Ibid.
4. *Thirty Years of Psychical Research*, by Richet, p. 156; and *Death and Its Mystery*, by Flammarion, p. 125.
5. For authentic examples of spirit photography see *The Case For Spirit Photography*, by A. Conan Doyle.
6. For authentic photographs of fairies see *The Coming of the Fairies*, by A. Conan Doyle.
7. For authentic instances of objects carried without physical contact see *Haunted Houses*, by Flammarion, Ch. IX.
8. *Thirty Years of Psychical Research*, by Richet, p. 476.
9. Ibid., p. 407
10. Ibid., p. 525
11. For numerous authentic cases of hauntings see *Haunted Houses*, by Flammarion.

Book 2

Copyright
Church of Light
August 2002

Astrological Signatures

Chapter 1

Serial No. 2
Original Copyright 1925
Elbert Benjamine

Copyright
Church of Light
August 2002

The Two Keys

Chapter 1

The Two Keys

In all ages and in every land and clime there are progressive souls whose spiritual vision pierces the murky clouds of dogmatic illusion with which priestcraft and statecraft have ever sought to obscure the sun of divine truth. These bold aspirants to esoteric wisdom have the courage to burst the fetters that chain them to the lifeless creeds which are forced upon a benighted world. They free themselves from the thralldom of prejudice, and from that of servility to popular opinion. They intrepidly turn their faces from the blackness of the dead ages to knock resolutely at the door of the Temple of Knowledge. They realize that only within the sacred precincts of nature's sanctuary burn the altar fires whose light produces the shadowy illusions which are believed by the multitudes who worship them to be the only reality. And they learn that this sanctuary may be unlocked only by the use of two keys.

Such a candidate for initiation, having become as a little child, after divesting himself alike of the shroud of orthodoxy and the incumbrance of current scientific opinion—the one as dogmatic as the other—stands at the entrance of the temple, seeking admittance. This structure is the edifice of nature, the home of Isis, the lodge room of our Grand Master, King Sol; and is referred to in the Bible as Solomon's Temple. Now this name can hardly have been derived directly from so many divergent sources, yet in spite of this, SOL-OM-ON presents some interesting correspondences; for Sol is the Latin name of the Sun God Phoebus; Om is a Hindu name of Deity; and On is the Sun God of Heliopolis, Egypt, which anciently was called the City of On.

The candidate has heard it said, "Knock and it will open; Ask and ye shall receive; Seek and ye shall find." So, sustained by a love of justice, he stands with clean hands and a pure heart at the gate to the sanctuary. After a time his efforts are rewarded by glimpses of the interior as the gates are opened by other hands, or the intuitions of his soul penetrate their opaqueness. His summons are finally answered by the Voice of the Silence, encouraging him to further endeavor; but at the same time admonishing him that there is no vicarious atonement or attainment. Each must unlock the doors that bar his progress and that guard the temple from profanation, for himself.

King Solomon's Temple has two doors; so also, there are two doors to its oracle. He who would enter either must possess their respective keys. The door on the right is opened only with the aid of a golden key; that on the left requires a key of silver.

These same two keys with which the outer doors of the temple may be unlocked will also open the doors of the oracle; but the keys that are turned from right to left in the outer doors must be turned from left to right to unlock the inner.

That keys are extant by which their possessor may penetrate the barriers of objective phenomena is common knowledge among all well posted occultists. Students of masonic symbolism go further; for they recognize that these keys are two in number.

In fact, the literature on ceremonial magic very largely revolves around the two productions, the one entitled, "Clavicula Solomonis" (The Key of Solomon the King), and the other entitled, "Lemegeton" (Lesser Key), there being an English translation of both. But the usefulness of these volumes, if they may be said to have a use, pertains to the history of mystical aberration, and to magical practices of doubtful quality, rather than to any revelation of the mysteries.

Turning from these again to freemasonry, we find the symbol associated with the Fellow Craft degree to be complex. We are in search of keys, therefore the other symbology need not here concern us. But one prominent feature of the symbol are Two Crossed Keys, one of Silver and the other of Gold. These are the keys for which we seek. Masonry in its symbolism has preserved the keys to initiation. They are the keys that unlock the doors of King Solomon's Temple; but precisely what these two keys symbolize in occult science no modern expounder, in so far as I have been able to learn, has explained. Therefore, I shall devote this lesson to bringing to the notice of all and sundry who are interested in occult matters, both the importance and the nature of the key of silver and the key of gold.

The better to understand the conditions which confront the present day searcher after truth, let us review the past with an eye to discerning the method by which whatever of enlightenment we now possess was gained. Perchance that method will give us a clue to the manner in which the many perplexities that now confront us may be solved.

Turning back the pages in the book of history a few hundred years, we find the utmost confusion in the realm of scientific thought. Prior to the seventeenth century material science was a wild jumble of notions. It was as great a medley of inconsistencies as we find today in the realm of religion and mysticism. And even as today assertions regarding religion are thought to be proved by citing authorities, so then the facts of material science rested upon authority as their final criterion. Just as mystics and religionists now feel free to give the particular interpretation of an authority—the Bible, for instance—that best suits their convenience, so then students were equally free in giving their own interpretation of scientific authorities. The controversies and animosities of present day religious sects and mystic cults are paralleled by the contention and turmoil in scientific circles preceding the seventeenth century.

This conflict between various schools was at an acute stage when, early in the seventeenth century, an event occurred which revolutionized the methods of scientific thought. The existing chaos of science was well recognized. Therefore, in the hope of establishing some kind of order, Cardinal Bagne called together the

notables and savants of his time to listen to the discourse of a scholar, M. Chandoux, who expounded the principles of a new philosophy. Present at that discourse was young René Descartes.

M. Chandoux was an eloquent speaker and clothed his thoughts in flowery language. With one exception his hearers were convinced and applauded loudly. The exception was René Descartes.

An acquaintance, noticing Descartes' reticence, asked him to explain in what manner he disapproved of the new principles so eloquently presented. Descartes complimented the speaker highly upon his ability, and then voiced an axiom that every occult student should constantly bear in mind. It is due to the failure to realize the importance of this fact that a thousand and one intellectual crudities are being palmed off on a credulous world today. He said: "Nothing Can Be Proved or Disproved by Unproved Principles."

What was true of material science in Descartes' time is equally true in regard to occultism, mysticism, and religion at present: "The probable being often substituted for the true, it being easy to mistake the fictitious for the true when dressed in false guise."

To illustrate this, Descartes asked the assembly to give him some well recognized fact. Then, by means of twelve statements he proved the fact to be true. After which, he took twelve other statements, and, to the consternation of all present, proceeded with equal ease, and in an apparently irrefutable manner, to prove its falsity.

The experiment was repeated again and again, to the great dismay of his audience. A confusion resulted that resembles that of religion and occultism today. The apparently proven facts of man's proper relation to other entities in the universe and to Deity are subject to just such jugglery, to affirmation by some authorities and to denial by others; both being sustained by arguments. No wonder the student often doubts the possibility of knowing without mistake the real truth concerning anything.

So it was with Descartes' hearers. They began to doubt their ability ever to recognize the truth. Consequently they sought his opinion about the matter. His reply is quite as important to religion and occult science today as it then was to material science, and if his advice is followed it will work as important a change for their betterment as it then worked for the advancement of material knowledge. He stated that Mathematics Alone avoids sophisms, and by its aid All Problems can be Solved, if Proper Principles be Followed.

That was the beginning of what is now called exact science. Its success during the intervening years has been due to the ability of its votaries to follow proper mathematical principles. Furthermore, the incongruities of certain materialistic philosophers and scientists are due to their departure from mathematical methods and their attempting to prove their doctrines by unproved principles.

Now it is not my purpose to convey the idea that the physical intellect alone is

capable of successfully wrestling with nature's arcane truths; for the soul, when free from the bondage of the physical senses, becomes a far superior judge of reality. The perceptions of the astral brain have a far greater range than those of the physical, and the sense organs of the spiritual body have even a much greater range than these. Furthermore, on the inner planes, intelligences of vastly greater ability than any on earth may be contacted. The soul when free from the body and functioning in a finer form is infinitely more capable of grasping the true inner significance of nature's wondrous manifestations.

But it is only the exceptional individual, under exceptional circumstances, who is able so to free himself from the limitations imposed by the flesh, that upon his soul's return to its earthy tenement from sublime flights in the starry realms of aeth his physical organism grasps the truths he has contacted without coloring them to conform to preconceived ideas, to prevalent opinions, or to the personal peculiarities due to centers of energy within his astral form that are mapped by his birth chart. The soul's experience may be compared to the pure white radiance of our sun, which is stained to different hues as it passes through colored cathedral windows.

People in general are greatly influenced by thought currents. Some dominant character puts forth an idea. Other less positive minds receive this idea either through unconscious thought transference, or through the written or spoken word. The positiveness with which the idea is launched enables it to gain a controlling power over a few. These then, having become dominated by the idea, formulate it anew. Thinking about it strongly, they send out astral waves that reach the astral brains of a whole nation. One after another people begin to accept the idea, and the more people there are thinking it the stronger becomes its power to dominate others.

The ease with which a few men in high political office often are able to warp the judgment of a whole people well illustrates this. No matter how pernicious or illogical the idea is, if it is launched strongly enough and gains momentum, it will dominate the majority. History abounds with the follies of whole nations temporarily so dominated. They are so under the power of suggestion that they fail to see the matter in any light but that under which it has been presented to them. They lose the power to reason about this particular thing, just as a hypnotized subject must accept what the operator suggests without question, and may imagine he is quite logical and rational. Likewise, the memory of the soul's experiences when free from the physical body has a tendency to be warped by thought currents into conformity with them.

There is also a tendency, deeply rooted in the makeup of the astral body, on the part of mystical minds to be controlled by autosuggestion. They sometimes become so dominated by some religious belief, or by some phantasy that has gained a strong hold in the astral brain, that the meaning of both physical and astral experiences is greatly distorted to confirm it. If there is much egotism, conversation with any disembodied entity may be construed as talking directly with Deity, even though others recognize the entity as an elemental. In such cases the mystic follows the dictates of the voice, even if it leads to death. And even where no such dominant idea is present, early beliefs often are so strongly entrenched in the astral brain as to

considerably color the memory of experiences brought back from excursions into higher realms. Consequently, there is always the need of critical analysis of such experiences, and the application of as competent methods as possible to test their accuracy. Such methods are embraced within the silver and golden keys.

Let us consider that nature in all her various manifestations is under law, and that this law invariably is based upon mathematical principles. Mathematical relations are absolute, and pertain as well to spiritual, celestial and angelic spheres, as they do to our humble planet. Everything, from the tremor of a thought wave to the evolution of a universe, operates in strict obedience to numerical law. The eight volved tower of Babel rose on Shinar's plain to exemplify the numbers understood by the Magi to govern race evolution. The pyramids yet stand as a monumental proof of the numerical relations existing between the earth, the universe, and the soul of man. And though the Pythagorean system of numbers was never placed in writing, and hence is dimly grasped except by the few, yet its fame has echoed down the corridors of time and prompts our soul to listen to the music of the spheres.

Mathematics alone enables one to avoid mental pitfalls, and it is due to this fact that the Golden and Silver keys are the most valuable possessions that the occultist can obtain in the world of mental research; for they are each grounded in, and strictly built upon numerical proportions.

To comprehend their function we must have recourse to the Written and Oral Laws.

Initiates understand the Written Law to be that Law inscribed in scintillating characters of light, by the ever moving finger of Deity, in the azure dome that spans our midnight sky. It is written in the Language of the Stars, and thus revealed His will to the primitive Assyrian Shepherds. Its study later gave to Egypt her splendor, and made the Chaldean Magi so justly famous. It was the knowledge of this ineffaceable Written Law, the sublime science of the starry heavens, that constituted the wisdom that flowed from the magical schools of Atlantis toward the rising sun; and in the dim and distant past, in those remoter periods of racial childhood, before material struggles had crystallized the sensitiveness of the soul, it was the pure intuitional recognition of the Written Law that constituted primitive religion.

Man is an epitome of the universe; is, in fact, a universe in miniature, built upon the exact plan and proportions of the larger one. His component parts interact with one another, even as do the orbs of nature; and they also interact with those larger bodies. Man, in his ignorance, imagines himself an isolated unit; but as his vision expands, he more and more recognizes the unity existing between himself and his divine source; and between himself and the infinitude of other manifestations.

Can we wonder then, realizing the mystical relation that exists between the soul and the stars, that a primitive people whose spiritual faculties were infinitely more sensitive and active than our own, should formulate their system of religion to conform to the heavenly bodies? They worshipped Deity by striving to learn and obey His laws. The Heavenly Father was looked upon as a benefic being whose mandates were to be obeyed, even as a child places loving confidence in the wisdom

of its parents.

Observation had convinced these primitive races that everything of importance occurred conformably to the position and movements of the heavenly bodies. The recurrence of certain celestial phenomena always brought the rains of winter; other positions ever heralded the time for sowing, and the time for harvest. The rivers overflowed their banks when at dusk or dawn certain stars were in the ascendant; and the tides of human life, as well as those of the sea, ebbed and flowed in obedience to the dictates of the heavenly orbs. These children of nature worshipped Deity by obedience to the dictates of nature. And it was only because they had become convinced that it is God's method of instructing His children that they bowed in reverence to the Written Law.

Thus it need not surprise us to find the remnants of an Astronomical Religion in every land. Being founded upon long ages of carefully tabulated facts, as well as subject to searching verification by specially qualified souls, it constituted a Science as well as a Religion. The qualities and interior principles of stellar influence were made the subject of systematic study for centuries; and their correspondences were located, both on the earth and in the human constitution. This religion was the worship of nature's laws.

In after years, when only a few could comprehend its scientific aspect because of spiritual and mental degeneration due to cyclic changes, the result of these studies was formulated into myths, each portraying the attributes and qualities of some stellar orb or celestial phenomenon. Certain qualities ascribed to Deity in his manifestations through the orbs and stars thus became the object of special worship by some people. Fire worship, sex worship, serpent worship, all sprang from this source; as well as the worship of mythological characters, who always portray with accuracy the qualities of celestial bodies. It certainly would greatly surprise the orthodox devotees of the twentieth century if they could but know how much of their religion is borrowed, with little or no alteration, from astronomical worship.

Astronomy is the Written Law; and the Golden Key to its interpretation is Astrology.

This golden key is constructed strictly upon mathematical lines; is, in fact, the only means of positively applying mathematics to the door of the past and future, and thus minimizing the chance of error. The student ignorant of its use can never realize the relation of his soul to the universe; nor comprehend astromasonry, astrotheology, nor astromythology. The philosophy and religion of the ancients will be to him a perplexing labyrinth; because they are founded upon the principles of astronomy and astrology. It is by the use of this key alone that natural sympathies and antipathies become understandable; and the cyclic locks that alike are found to guard men, nations, worlds, and starry systems, are turned in their wards by the hand of the mind only by its aid.

This golden key unlocks the door of positive knowledge in King Solomon's Temple. It reveals the why and wherefore of man's past, present, and future condition. It is mathematical certainty alike in religion, philosophy, and science; for it deals not with

effects, but with causes. The alchemist who neglects the golden key will seek in vain to transmute base metals into gold, and will fail utterly in producing the elixir vitae. The physician ignorant of its use, be he homeopathic, allopathic, chiropractic, osteopathic, mental scientist, christian scientist, or divine healer, will in many instances receive unexpected results from his best efforts; because he fails to grasp the inner magnetic relation of his patient, himself, and the method he employs. What is one man's poison is another's cure; and this may be magnetic poison, or mental, as well as physical; and these inner sympathies and antipathies only become recognized through familiarity with the principles of astrology.

It is a generally accepted fact that nations rise and fall with rhythmic precision; but such periods of ascension and decline can only be known by use of the golden key. Our government may continue to endow meteorological stations with millions, but the state of the weather will never be known more than a few days in advance until they recognize this key; and man without its proper use will continue to grope in darkness where spiritual facts are concerned.

The golden key alone made possible the wonderful cures wrought by Paracelsus, it guided the mystic Jacob Boehme in the erection of a religious and philosophical system; and in all past ages it has constituted the most reliable chart for those souls who boldly attempted to sail the wide ocean of spiritual research. It has been the means by which, at last, they have reached the haven of attainment.

But now let us again consider more primitive times. The intellectual and spiritual condition of the world is, like all things manifest, subject to cyclic law; and there have been recurring periods of comparative light and comparative darkness. After the mental forces have spent themselves in any age, they begin to wane, and the race declines into barbaric ignorance. When these periodic conditions of spiritual decline set in, there is an effort made upon the part of the most enlightened to preserve their knowledge for the few who will be able to appreciate it during the dark ages to follow, those who will pass it on in substance to future generations when the spiritual forces again rise in the world's ascendant. Thus originated the Hermetic Schools which are custodians of the Secret Doctrine.

The hierophants of these schools collect as many facts as possible relating to spiritual things, and formulate them into allegorical systems suitable for communication by word of mouth. In order that these mysteries shall not become entirely lost they are frequently given, in part or as a whole, to the populace. Such allegories become the religious doctrine of the multitude, and passing into writing may constitute a holy book. Thus originated the Vedas, the Avesta, the Bible, and other sacred writings. But as a rule, at their inception, these traditions have been transmitted orally, by word of mouth, and thus are known to initiates as "The Oral Law."

The Oral Law is the Secret Doctrine, and having been formulated by the Magi, it is constructed in such a manner as to be incomprehensible to the vulgar, yet not difficult of interpretation to one possessing its key. This key was explained only during the course of initiation into the mysteries, after the recipient had proven indisputably his

physical, intellectual, and moral integrity. And just here it may be well to digress long enough to explain that, following in the literary custom, I use the masculine pronoun in these lessons to include both sexes; for never has woman been barred from membership and equal privileges with her brothers in any true Hermetic School. The doors of Luxor, Rosicrucia, and The Brotherhood of Light, have ever welcomed her.

But to proceed: This open sesame to all traditional knowledge exists at the present day and has been recognized and used advantageously by a number of eminent kabalists, mystics, and savants; but has received scant attention from those outside the portals of certain secret societies. This Silver Key to the Oral Law is none other than the Sacred Tarot, or Book of Thoth. From its pages the illuminated St. Martin drew inspiration. Aided by, and in strict conformity to its revelations, the savant, Eliphas Levi, wrote his truly marvelous work, *The Dogma and Ritual of Transcendental Magic*. This key was held in the highest esteem by the erudite Count de Gebelin; was the basis of William Postel's *Key of Things Kept Secret from the Foundation of the World*; and constituted the *Ars Magna* of Raymond Lully, by which he claimed all problems might be solved. Lully was a profound kabalist, and the crowning effort of his life was his philosophical wheel, or method of applying the Tarot.

Not only do archaeologists find remnants of the golden key in all portions of the world, but by their side fragments from the key of silver. The Book of Thoth, under various names, was known to remotest antiquity. It was formulated by the same master minds who peopled the starry heavens with mystic characters and forged the golden key to their interpretation, to serve as the handmaiden to religious astrology.

Now the golden key has a stem of twenty-two symbols—twelve zodiacal signs and ten planets. It has a ring of four decades—thirty-six decanates and four seasons of the sun's annual cycle. It has wards, consisting of the twelve mundane mansions and the elemental ruler of each of the four quadrants, that turn in three worlds. In its action it is masculine and positive.

The silver key is a duplicate of the one of gold, except that in its action it is feminine and passive, thus bearing the same relation to the latter that woman bears to man. The twenty-two Major Arcana of the Tarot each bear an exact correspondence to one of the twelve zodiacal signs or ten planets and constitute an esoteric interpretation of them. The forty numbered Minor Arcana bear a strict relation to the thirty-six decanates and the four seasons of the sun's annual cycle. The sixteen members of the Tarot Court accurately describe the twelve mundane mansions and the elemental ruler of each of the four quadrants.

In fact, the Tarot bears the same relation to astrology that the Moon bears to the Sun, and even as the Sun illuminates the day, so does astrology shed its radiance upon the more evident truths of occultism. But those deeper and more recondite mysteries remaining in the shadow cast by objective existence would forever remain in the dark, even as at night nothing is seen until the Moon has risen, were it not for the soft

radiance of the silver key. It is true, the moon shines by borrowed light; yet we are grateful for her rays. Just so the Tarot borrows her significance from her heavenly spouse, astrology; yet she sheds an ever welcome illumination upon our darkest mental paths.

Bearing this explanation in mind a much quoted passage from the Zohar, one of the books of the Jewish Kabbalah, becomes luminous. It runs thus: “At the death of Moses the sun was eclipsed and the Written Law lost its splendor, and at the death of David the moon diminished and the Oral Law was tarnished.”

Moses according to tradition—and the word kabbalah means traditions—was raised by the Egyptian Magi, and was initiated into the mysteries. Consequently he was familiar with both astronomy and the kabbalah, or the Written Law and the Oral Law; and had been given the keys to their interpretation. In fact, the story of creation as allegorically given in Genesis, when correctly interpreted, is capable of a mathematical proof that harmonizes with the law of cycles as known to present day initiates. Furthermore, the whole Pentateuch, by whomsoever written, teems with thinly veiled references to astronomical cycles, laws, qualities, and movements. As these references are found to coincide with observed phenomena, they indicate a deep knowledge of astrology, the golden key, upon the part of their composer. So the kabbalists, having reference to the positive illuminating power of the golden key, compared it to the sun. This sun, meaning astrology, was eclipsed at the death of Moses. Its proper use was lost to the Jews; hence the Written Law, astronomy, lost its splendor, or became meaningless. And this fact is confirmed by Bible study.

The silver key, the intuitional, feminine counterpart of astrology, was compared to the moon, which diminished at the death of David. That is, the Jews were skilled in the meaning and use of the Tarot down to the time of David, but at his death they lost the final key to their mysteries, hence the Oral Law was tarnished. They yet retained the Bible and the kabbalah, but had lost the key to their interpretation; and when a part of the latter finally was committed to writing, the ignorance of this key on the part of its scribes gave to it a garbled form.

The ark of the covenant, which the Children of Israel ever carried with them was a synthetic representation of the Tarot, or Book of Thoth. Now the silver key has wards opening the three worlds of existence. Corresponding to these are the three stories of the ark. The base was of square form to represent the physical world and the alchemical kingdom of salt. Each of the two rings on either side, through which were thrust the carrying poles, thus represents the number ten, the sacred emanations of the Sephiroth. The four rings collectively represent the Sephiroth in all four of the elemental realms, corresponding in this to the forty Minor Arcana of the Tarot. As mind is superior to matter, the coffer just above the base corresponds to the intellectual world and the alchemical kingdom of mercury. This is represented in the Tarot by the human figures that constitute the Court Arcana. The divine world was symbolized by the uppermost section, that region above the mercy seat. This corresponds alchemically to the kingdom of sulphur, and in the Tarot is represented by the twenty-two Major Arcana, typifying as they do the signs and planets of heaven

whose influence is ever active upon both the lower forms of life and the actions of men.

In this ark were carried¹ the four symbolical suits of the Tarot. There was the golden pot, or suit of cups. Aaron's rod that budded represents the suit of scepters. The tables of the covenant, or law, correspond to the suit of swords; and the mana contained in the golden pot well symbolizes the suit of coins.

The cherubs at either end of the mercy seat typify in the divine world the Father-Motherhood of God, in the intellectual world the rational and intuitional methods of gaining knowledge, and in the physical world the positive and negative forces of nature. Kabalists assert that it was between the wings of these cherubs that the high priests consulted the Lord by means of Teraphim, Urim, Thummim, and by Ephod; and such biblical mention as is made of the matter tends to confirm the opinion. This method was none other than the use of the silver key, the sacred Tarot.

This is but one of the many examples that might be cited to show an early knowledge of the silver key upon the part of the Hebrews; but their later writings, with some exceptions, do not indicate the same familiarity with it. Ezekiel evidently recovered it, for by its application alone can the mystic symbology of his writings be intelligently interpreted. Daniel also evinces some knowledge of its use; and the whole Apocalypse, whoever its author may have been, is based upon the Tarot. In fact, each of the twenty-two chapters is an exemplification of one of the twenty-two Major Arcana in its relation with the others, as applied to prophecy. Thus it well may be said that at the death of David it was lost to the Jewish priesthood, yet it is equally certain that afterwards it was recovered by some of the inspired prophets.

Not only the Bible but the sacred writings of other nations of antiquity may be interpreted by use of the silver key; for their allegories came alike from a common source, and have suffered minor alterations due to later environment. We may confidently say, then, that no one can thoroughly understand the inner meaning of the ancient sacred books who is ignorant of the Tarot. Or, stating it in the words of Eliphas Levi we may say:

Without the Tarot, the magic of the ancients is a closed book, and it is impossible to penetrate any of the great mysteries of the Kabbalah.

We may be sure that the gigantic intellects who first discovered the Written Law, and who formulated the Oral Law, perceived in nature a unity whose ever varying manifestations are due to certain fundamental principles. The universe is but the action and reaction of these principles under the dominion of one law, and this law conforms strictly to mathematical relations. These mathematical relations once discovered through observation of the Written Law, it was but a step to incorporate them in the Oral Law. Likewise they are maintained in, and contribute to the value of, the silver key.

The keen intuitions and spiritual perceptions of the ancient Magi enabled them to formulate the exact correspondence between the soul and the stars. They likewise

forged the golden key as a means of unlocking this realm of positive knowledge. But the inner, more secret, intuitive interpretations; wherein they often exemplified the personal experience of the soul in other realms than this, required a key of different composition. Therefore, in its construction they employed the language of universal symbolism. The silver key, constructed as a mathematical duplicate of its golden counterpart, if intelligently applied, will not fail to open one of the principal doors to King Solomon's Temple.

In fact, the traditions of freemasonry aver that owing to the death of one of their grand masters the master mason's word was lost, and with it the key to certain of their mysteries. At a later date, through an accidental discovery, the lost word and lost key were recovered. This discovery is represented as the disinterment of the ark of the covenant containing the four emblems that each mark one suit of the Tarot.

From the ark are taken, first the Book of Laws, and then four pieces of paper or scrolls of parchment bearing the key to the characters of their mysteries. As has been mentioned, the ark of the covenant is a symbolical synthesis of the Tarot. The Book of Laws represents the Oral Law. The four scrolls of parchment signify the four quadrants of the heavens upon which is inscribed the characters of the Written Law.

The master's word is found upon the ark, covered with three squares, which are the jewels of the three ancient grand masters. These jewels are astronomical measures, and form a portion of the golden key.

Freemasonry undoubtedly is derived from the ancient mysteries of initiation. Each of the first thirty-two degrees is founded upon one of the ten numbered Arcana, or one of the twenty-two Major Arcana. The members of the lodge by whom the candidate is surrounded are represented by the Court Arcana. The thirty-third degree is typified in the Tarot by the mystic seal. These degrees also correspond to the thirty-three chapters of the kabalistical book, Sephir Yetzirah, or Book of Formation, which, founded upon the Tarot, has thirty-three chapters, and is explained by a commentary entitled, "The Thirty-two Paths of Wisdom." As masonic ritual is based upon the Tarot, its esoteric meaning is only comprehensible when proper application is made of the silver key.

Nor is the use of the silver key confined to revealing the mysteries of antiquity, for it can advantageously be applied to the solution of all the problems of science and philosophy.

Letters are absolute ideas; absolute ideas are numbers; numbers are perfect signs. In reuniting ideas to numbers we can operate upon ideas as upon numbers and arrive at the mathematics of truth.² Thus the possibilities of the Tarot are only limited by the ability of its user. Its prevalent abuse as a divinatory instrument, it is true, has brought it somewhat into disrepute. Yet while not denying the effectiveness of either the golden key or the silver key in divination, I should not fail to emphasize that this is the lowest plane of their usefulness, and that their application to spiritual matters will yield the seeker far superior rewards for effort expended.

Again to quote Levi in regard to the Tarot: “It is a truly philosophical machine, which keeps the mind from going astray while leaving its initiative and liberty; it is mathematics applied to the absolute, the alliance of the positive and the ideal, a lottery of thought as exact as numbers, perhaps the simplest and grandest conception of human genius.”

This is a stupendous thought. And lest the reader be given the impression that there is something complex and difficult in the principle underlying the golden key and the silver key, before bringing this lesson to a close, I shall risk introducing an element of crudeness by descending from philosophical concepts to the most material and commonplace matters of which, at the moment, I can think.

For the sake of illustration only, and admitting it to be rather an undignified example, let us suppose that a man desired to build and furnish a dwelling.

He is confronted with purchasing quite an assortment of things, and it becomes necessary to know how much of each to purchase, and what the cost will be. He must have dimension lumber, siding, sheathing, brick, nails, sand, lime, plumbing fixtures, and many other things in addition to paying for the labor. How is he to determine the influence of this proposed dwelling upon his bank account?

Obviously, he can not merely visualize the house as built and furnished, and from such a picture draw any accurate conclusions as to its complete cost. Nor will visualizing the materials as brought together in crude piles assist him much.

Now lumber is sold by the board foot. Therefore, having recourse to mathematics, he determines how many board feet of each kind of lumber are required. Then, multiplying each kind by the price per foot for that kind, and adding together the various prices so obtained he arrives at the cost of his lumber bill.

But brick, being sold by the thousand, cannot be computed in board feet. To find the cost of the brick required he must multiply the number of thousand brick by the cost per thousand.

Sand is sold neither by the thousand nor by the board foot, but by the yard. The number of yards of sand required multiplied by the price per yard, therefore, gives him the cost of the sand.

Nails, which are also required, are not sold by the thousand, nor by the yard, nor by the board foot, but by the pound. Consequently, to find the cost of the nails he must multiply the number of pounds of nails by the price per pound.

Without going into the details of other requirements; such as lime, sold by the barrel; wall paper, sold by the roll; rugs, sold by the square foot; chinaware, sold by the dozen; and skilled labor, sold by the hour; it is quite evident that an accurate estimate of each requirement can only be made by first associating it with its own symbol of commensuration. Nails cannot be computed by associating them with board feet, but they can be computed by associating them, according to proper mathematical principles, with pounds, which is their proper symbol of commensuration.

Furthermore, when each requirement has been properly associated with its own symbol of commensuration, and through this its cost calculated, by then adding together the prices of these various items the cost of the completed dwelling may be made known.

So much for boards, and nails, and chinaware, and the even more familiar commodity, human labor.

But even as there is a symbol of commensuration for each of these common things, by which alone its influence upon the bank account may be ascertained, so likewise is there a symbol of commensuration for every object and force in the universe, by which alone its true quality and influence may be made known. These are astrological terms. As has been shown in an earlier lesson, everything, in its vibratory rate, corresponds to some astrological quality. Even ideas and spiritual principles have astrological correspondences. Therefore, by associating the symbol of its astrological correspondence with anything we are using its own symbol of commensuration; and much as board foot associated with lumber enables it to be measured, so the astrological term enables us to form a just estimate of other things.

Furthermore, when things are associated with their proper astrological symbols, and thus made commensurate, their influence upon each other or upon an individual may be learned. When stated in astrological terms the most diverse matters become commensurate. As nails and boards and sand and lime, when first made commensurate by associating each with its own proper symbol, and that stating in terms of dollars and cents, may thus be combined to give a total cost; so, by associating them first with their own astrological symbols, and then stating in terms of vibratory harmony and discord, the total influence upon human thought and life of the most diverse things may be known.

Among the most potent of these diverse things to influence the course of human life are invisible planetary rays. That we are unconscious of their power to influence us at certain times to think and act in one way, and at another time to think and act in an opposite manner, mitigates their influence not in the least. Is the sunflower, whose face follows the course of the sun, aware that its movements are influenced by light? Both plants and animals are continually influenced in their growth and behavior by gravitation, yet what is gravitation? Animals and plants, both in growth and in movement, respond markedly to changes in temperature. Subconsciously they may be aware of the desire that leads to these various behaviors, as no doubt man is subconsciously aware of the desire to act in a certain way because of his astral body being stimulated by planetary vibrations. Objectively he merely experiences certain impulses without knowing why. The moth does not know why it flies into the flame. It flies into it because light has the power of stimulating it to fly in the direction of the light. This tropism, as it is called, causes the moth to react to certain vibrations in a specific way, and another tropism causes man to react to planetary influence in a way that may not be dissimilar.

This, then, is the method incorporated into the two keys. They are constructed to

reveal astrological correspondences and thus facilitate the use of the proper symbols of commensuration. They are constructed to indicate, once the proper symbols have been obtained, the influence of one thing or idea upon another. They include in their composition such mathematics as is necessary to determine the total harmony and discord, and hence the total influence, of the most diverse things when they are brought together. They constitute a means of measuring both special and universal forces.

In conclusion, I again state the words of Descartes, who, it may be mentioned, before settling down to his final life work, roamed the whole of Europe in search of someone who could initiate him into a secret occult fraternity; "Mathematics alone avoids sophisms."

In this we find the greatest commendation for the use of both the golden key and the silver key, for both conform to mathematical principles. And in no other field will the student be so well rewarded for his labor, and less likely to become grounded in error, than in applying to the macrocosm and the microcosm these two invaluable keys.

Notes

1. Hebrews 9.4.
2. *Dogmas and Ritual of Transcendental Magic*, by Eliphas Levi.

Chapter 2

Serial No. 46
Original Copyright 1926
Elbert Benjamine

Copyright
Church of Light
August 2002

The Zodiac

Chapter 2

The Zodiac

ANY worth-while study of the occult sciences must be based upon familiarity with the golden key, Astrology. The various astral vibratory rates that constitute the occult properties of objects can only conveniently be classified by associating them in terminology with similar vibrations of the zodiacal signs and the planets. We have no other terminology than the astrological at present by which to designate the various astral forces, which are the chief subjects of study in the occult sciences. The language of the stars, then, is the only language we possess today by which we can converse intelligently of occult matters. The alphabet of this language has twenty-two letters comprising the ten planets and the twelve zodiacal signs. The planets constitute the vowels. In Chapter 3, Course 1, *Laws of Occultism*, I have already designated the chief vibratory quality of each planet. And now, that we may be familiar with the whole alphabet customarily used in occult discourse, I shall take up the discussion of the consonants, the Twelve Zodiacal Signs.

To begin with, we must understand of what the zodiac consists. The earth, in its annual journey around the sun, follows an elliptical path. This is the same path apparently followed by the sun. Because the eclipses of the sun and moon all take place along this path it is called the Ecliptic. In astrology, to avoid the constant repetition of the phrase, "sun, moon, and planets," it is customary to include all in the term "planets." The sun, strictly speaking, is not a planet but a star past middle age. Neither is the moon a planet. It is a satellite of the earth, relative to its own life processes hoary with years. With this definition in mind I may next say that none of the planets in their orbital revolutions move much to the north or south of the ecliptic. That is, none of them in its movement gets more than a few degrees away from the apparent path of the sun.

There is thus a belt arching the heavens from west to east from which the planets never wander. This belt was considered by the ancients, from whom much of our astrological knowledge is derived, to extend nine degrees north and nine degrees south of the apparent path of the sun. The very word "planet" means "wandering," and unlike the stars, the planets may be observed to meander along this path. The stars are self luminous suns, but the planets are masses of matter much smaller than our sun. They shine by reflected light, and held by the gravitational pull of the sun, revolve around it, as does the planet earth, in elliptical orbits. This belt, through

which all the planets move, is mapped by starry constellations. These, for the most part, are traced to represent animals. Hence, as the word means “an animal,” this belt through the sky, in the center of which is the apparent path of the sun, is called the Zodiac.

Bearing in mind that the center of the zodiac is the sun’s path—for while it is really the earth that moves, yet to avoid countless repetition of the word “apparent” it is customary to speak as if it were the sun that moves—it is easy to see that the zodiac may have a definite starting point. The sun each year moves north from the southern celestial hemisphere to the northern celestial hemisphere, bringing with it the summer season. It does this because its path, the ecliptic, is inclined at an angle of 23 degrees, 26 minutes, 56 seconds to the plane of the earth’s equator, the projection of which in the sky is called the Celestial Equator. Because the ecliptic and celestial equator are not identical and not parallel they must intersect each other. The line of their intersection is called the equinoctial colure. The points where the sun, following its path, the ecliptic, crosses the celestial equator, are called the vernal equinox and the autumnal equinox. They are called equinoxes because when the sun reaches these points the nights are equal in duration to the days.

Such terminology may seem slightly technical. Everyone, however, is familiar with the changes of the seasons from winter to spring and from summer to autumn. These changes are caused by the sun crossing the equinoctial colure, crossing from the southern celestial hemisphere to the northern celestial hemisphere about the 21st of March each year, and from the northern celestial hemisphere to the southern celestial hemisphere each year about the 23rd of September. These points in the path of the sun where it crosses the celestial equator are easily ascertained in the sky, and, since they usher in the two halves of the year, winter and summer, are manifestly of great importance.

Of these two points it is found experimentally that the one where the sun crosses the celestial equator in spring is the more important, and constitutes the commencement of the zodiac. The zodiac, then, though a circular belt in the sky, has a definite starting point. This starting point is not determined by any of the stars or constellations, but by the place among the stars and constellations during any given year where the sun crosses from south declination to north declination. It commences at the vernal, or spring, equinox.

There is undoubtedly a good reason, one that with sufficient knowledge could be traced, why man has ten fingers and ten toes, while a chicken has but four toes and only the atrophied remnants of fingers. We are accustomed to accept the number of toes an animal has without much questioning, merely because observation teaches us that it is common for certain creatures to possess a given number of digits. Likewise we may accept, because observation demonstrates it to be true, that there are twelve major divisions of the zodiac. Were we to delve deeply enough we undoubtedly should learn why twelve and not ten; but as observed in their influence upon human life there are twelve equal chief divisions. That is, starting at the point where the sun crosses the celestial equator in the spring, and following its path until again it crosses

the celestial equator the following spring, some twelve months later, this circular pathway is found to have twelve equal segments, each segment possessing a vibratory influence peculiarly its own. Such a segment of the belt about the heavens, the center of which is the sun's path, is called a Sign of the Zodiac.

The signs of the zodiac should not be confused with the constellations. The position of the signs in the sky is referable to the position of the sun relative to the earth. The place among the stars where the sun crosses the celestial equator during the spring of any year is the point where the zodiac commences that year. This point constantly, but not uniformly, shifts in reference to the stars and constellations. It shifts back among the constellations—these being composed of stars—that lie along the zodiac at such a rate that it moves completely around the circle of stars in 25,868 years. This precessional movement is not uniform, but variable, almost ceasing at some times and at others becoming rapid. Thus while the average amount may be taken as 50.20 a year, should it be necessary to calculate the exact motion at any time, what is called the equation of the equinox must be taken into account, which is the difference between the actual position and the position had it moved uniformly. This backward movement of the commencing point of the zodiac is called the “precession of the equinoxes,” and its motion through the constellations of stars gives rise to the various astrological ages.

So far as the effect is concerned it makes no difference whether the armature revolves around an electromagnet or the electromagnet revolves around the armature. The sun is an electromagnet, the lines of force from which are cut by the planets as they revolve around it. The stars of space also radiate energy, the lines of which are cut by the sun in its movement among them. Such fields of force as are radiated by our sun and by the stars probably vary in intensity in different places just as the field of force about a magnet varies at different points in a circle traced around it, due to the location of its poles. We need not be surprised, then, to find that the vibrations that reach the earth from the sun and planets from different sections of the circle they apparently make about the earth are dissimilar in quality and in power.

The celestial equator, coinciding on earth with the earth's equator, divides the earth astronomically into north and south polarity. And it is found experimentally that the relation of the sun to this division of the earth determines the relation of the earth to the various sections of the field of force through which the planets move. In other words, the signs of the zodiac owe their peculiar vibratory quality to the definite section of the heavens they occupy relative to the positions of the sun and earth. In determining these various intensities in the field of force through which the planets move, the stars seem to have little or no influence, for, although the zodiac shifts continually through the constellations, the influence of the signs of the zodiac throughout the ages has remained unchanged.

This is not the place to discourse of astrological Ages. But it would be amiss not to point out that the constellations do have an influence of their own, an influence that apparently is quite distinct from the signs although it must be gauged in association with them. I have already mentioned the backward shifting of the signs through the

constellations. This apparent motion is caused by the attraction of the sun and moon on the earth's equator. The earth is flattened at the poles, being thicker at the equator. Hence the gravitational pull at the equator is greater, and as the equator is inclined to the plane of pull of the sun and moon, the latter influence is toward causing the inclination to become less, in other words, to pull the equator down closer to the direction of their pull. The earth, however, is revolving rapidly, like a top. And like a top that leans from a vertical position and yet spins without falling, the earth resists this pull at the equator, and remains spinning and leaning at about the same inclination. But, as the peg of a leaning top slowly moves about in a circle, causing its equator to gyrate, so the pole of the earth and its projection in the sky move in a circle about the pole of the ecliptic. This does not cause a change of inclination in the axis of the earth, but causes the axis to gyrate, and this causes the equator of the earth and its projection in the sky to slowly move in relation to the ecliptic.

In determining this movement the vernal equinox, the point in the heavens where the sun crosses the celestial equator, is the station of importance. The constellations bear the same names as do the zodiacal signs. In fact, each evidently was traced among the stars pictorially to represent the influence of the sign bearing the same name. When the sun at the vernal equinox, the commencement of the zodiac, is found in the constellation Aries, the period is said to be in the Arian Age. When the sun at the vernal equinox is found to be in the constellation Pisces, it is said to be the Piscean Age. When the sun at the vernal equinox is found in the constellation Aquarius, it is said to be the Aquarian Age. These ages, and their lesser subdivisions, are found to influence the world at large. They denote that the sun and earth are in such relations to the stars, among which our whole solar system is rushing, that they transmit vibrations from this wider region, cut definite fields of energy, that influence the whole of humanity, giving direction to its evolution.

Having stated that each sign of the zodiac differs from the others in vibratory quality, it is next in order to discuss in what way this difference expresses itself. It manifests chiefly, but not exclusively, by modifying the tone quality of any planet located in the signs. In effect, the signs of the zodiac act as so many sounding boards from which the planetary vibrations are transmitted to us. Each planet has its own particular tone, which it always retains. From a musical standpoint, however, the tone C, or the tone G, or any tone within the octave, may be sounded on a wide variety of instruments. The chief vibratory rate will remain the same, but the tone quality will greatly vary. The same tone sounded on a violin has an entirely different effect upon the hearer than if sounded upon a bugle. The difference in the influence of the same planet when in one sign and when in another sign may be quite as great. The difference in such a musical tone, and the difference in the vibratory quality of such a planet, is due not to any change in the essential vibratory rate, but to the difference in the sounding boards from which they are sent forth. The zodiacal signs are the sounding boards that determine the precise resonance and quality of the planetary vibrations.

The signs, because they are keyed to particular vibratory rates, each transmit certain tones much more readily than other tones. They are thus each so sensitive to the

vibratory rates of certain planets that they send forth a responsive tone even when the planet is not in the sign. This seems to be on the same principle that made it possible for Caruso to shatter a wine glass across the room by first finding the tone to which it was keyed and then singing this tone. Although the great singer was not touching the glass he caused it to respond with its own key, and finally caused this tone response to become so violent as to break the glass. Though acting as a sounding board, or medium of expression for the planet, each sign has its own key.

Likewise everything on earth has a key to which it vibrates. When it is discovered that some particular thing on earth, in the astral realm, or elsewhere, vibrates to the same key as that to which a zodiacal sign vibrates, the thing is said to be ruled by that zodiacal sign. In other words, when discussing occult subjects, if we are told that a certain thought, a certain color, a certain planet, a certain insect, or what not, is ruled by a given zodiacal sign, we are thereby apprised of the inner vibratory quality, or key, of the thing considered.

Such knowledge is of paramount importance to the occultist. Let us, therefore, without further delay, take up the study of the qualities that a vast amount of careful observation has shown to reside in each sign.

The first step in this direction should be to learn the names of the twelve signs, their correct order of sequence, and the particular section of the heavens occupied by each when the vernal equinox is on the eastern horizon. Also, as the signs are designated by symbols in astronomical and astrological tables and literature, such as almanacs and ephemerides, the symbol commonly used to denote each sign should be learned. This information may all be obtained from an inspection of the diagram on page 18 where each sign is associated with its symbol, and the correct sequence is denoted by numerals.

Now, although such a method of approach is not absolutely essential, for the sake of systematizing our knowledge of the signs, I find it convenient to have recourse to the magical quaternary rendered in the Bible of Jehovah, but known to initiates as Jod-He-Vau-He. This is a formula that is found to be as valuable in the solution of occult problems as any formula of algebra is valuable in the solution of engineering problems. It is the formula, stated in terms of universal principles, that all life, action, and progress are the result of two interacting forces. The first term of the formula is a positive force. The second term is a negative, or reactionary force. The third term of the formula is the point of union where the two meet. The fourth term is the result of that meeting.

This formula, Jod-He-Vau-He, is universally applicable. Thus if we desire to apply it to economics, the radical political element of society becomes the Jod, or impelling force. The conservative, or reactionary, political element becomes the first He. The point of union, or Vau, is the political convention or ballot box. The final He, the product of the struggle, is the form of government resulting.

Now, by applying this ancient formula to the zodiacal signs, we find that they separate into four equal groups bearing just such relations to each other as the terms

Jod-He-Vau-He suggest. As there are twelve signs in the zodiac, of course each of the four equal groups must contain three signs. And to designate that there are three signs in each group, the groups are called a Triplicity. There are, therefore, four zodiacal triplicities.

Each triplicity is named after one of the four ancient elements to which it corresponds. These were not considered elements in the sense that chemistry considers sulphur, mercury, carbon, and radium, elements. After all, in the true sense of the word, these latter are no more elements than the ancient fire, water, earth, and air; for all are composed of electrons and protons. Fire, to the ancients, was an abstraction by which the qualities of energy, zeal, and enthusiasm, whether expressed in a mineral such as sulphur, or in a vegetable such as mustard, or in a beast, such as a wildcat, might be designated. Water was used to express fluidity, receptivity, and germination. Earth was used to express coldness, concreteness, and solidity. Air was used to express vacillation, intangibility, alertness, and fleetness. The terms, fiery, watery, earthy, and airy, were applied alike to objects, persons, and zodiacal signs.

Applying our magical formula, the fiery triplicity represents the positive, masculine Jod, even as the heat rays of the sun fall upon the world. The watery triplicity is the negative, feminine first He, such as the moisture that quenches the thirst of the parched desert. The earthy triplicity is the point of union of masculine and feminine forces, the Vau, as water and heat meet in the earth to germinate whatever seeds lie in the ground. The airy triplicity is the product springing from the union, the final He, the harvest brought forth in due season. As applied to man we may say that the union of enthusiasm and affection gestates as effort which results in intelligence. Or, stating it in terms of the four-fold sphinx, we may say that the energy of the Lion expresses through the sex of the Eagle, bringing about material incarnation and the plodding toil of the Bull, to the end of evolving the immortal Man.

In our study of the triplicities, and in our study of the signs as separate influences, we shall find it convenient to designate their relation to human types and human life. Not that their influence is confined to humanity, but because we are familiar with human qualities. When we learn their correspondences in terms of human character, it will then be no difficult task to determine their correspondences in other departments of nature. In considering the quality of a sign or group of signs as expressing through humanity I shall have special reference to people who have the Sun in their birth charts in these signs. The sign the Sun is in indicates in large measure the quality of the Individuality. However, the sign the Moon is in at birth largely determines the quality of the mentality, and the sign on the Ascendant determines largely the quality of the Personality. Furthermore, it should be understood that the sign the sun is in at birth is only one of many factors of the birth chart, all of which must be taken into consideration, and which may greatly modify the characteristics of the sign. Only certain deep-seated motives and impulses that underlie the character can be determined with certainty from the sun sign alone.

As there are different classifications of the zodiacal signs, so there are also different

methods of classifying people. One of the oldest methods, and one that has distinct advantages as viewing them in relation to the zodiacal triplicities, is to divide them into four general groups. These groups have to do with the predominant temperament, classified as sanguine, lymphatic, bilious, and nervous.

The Fiery Triplicity embraces the signs, Aries, Leo, and Sagittarius. People born under this triplicity—meaning primarily the Sun being in this triplicity, as explained in Chapter 2, Course 10-1, *Delineating the Horoscope*—tend to the sanguine temperament. They possess self-reliance, enthusiasm, zeal, courage, daring, the ability to command others, and a love of activity. In the sense of being able to arouse in themselves and communicate to others initiative and enthusiasm, their characteristic quality is INSPIRATION.

The Watery Triplicity embraces the signs Cancer, Scorpio, and Pisces. People born under this triplicity tend to the lymphatic temperament. Their lives are largely centered in the home and affections. They are sympathetic, timid, dreamy, submissive, given to domestic life, receptive, yielding, mediumistic, and greatly influenced by their surroundings. In the sense that they are chiefly actuated by their feelings, rather than by carefully reasoned lines of conduct, their characteristic quality is EMOTION.

The Earthy Triplicity embraces the signs Taurus, Virgo, and Capricorn. People born under this triplicity tend to the bilious temperament. They are not given to bursts of enthusiasm, but express their ideas concretely, having the ability to apply themselves patiently to the affairs of this life and to turn all they contact to some material use. On the farm, associated with some industry, or managing some great corporation, they are toilers. In the sense of relying upon reason and the reports of the senses, and in interesting themselves in the affairs of earth that have value here and now, their characteristic quality is PRACTICALITY.

The Airy Triplicity embraces the signs Gemini, Libra, and Aquarius. People born under this triplicity tend to the nervous temperament. They are mentally alert, volatile, changeable, and socially inclined, desiring to live largely upon the mental plane. They are interested in education, literature, and art, are fond of conversation, and find pleasure in the exchange of ideas. In the sense of desiring refinement and intellectual culture, their characteristic quality is ASPIRATION.

We have now applied our magical quaternary formula in its broadest sense. Under this formula things are not only perceived to express our broad qualities, but viewed from a different perspective are seen to be a trinity. Then, turning them to be viewed still closer we perceive them also to be a duality; and finally, from another point of inspection, to be a unity. It will readily be seen, however, that these views offer no contradiction to the magical quaternary, for we perceive the three to be already contained in the four. The duad likewise appears in the quaternary. It is the principle of polarity. And, of course, unity expresses in the various separate parts of the four. Altogether, then, this magical formula, when its different perspectives are added together, completes the cycle and starts another; for 4-3-2-1 added together are 10.

As I illustrated briefly the application of the four factors of the magical formula I should not, I think, omit a brief illustration of the trinity. It is everywhere manifest, but that now most immediate to my consciousness is the sense of sight. How do we distinguish the objects we see? By a trinity. Straight lines are positive. Curved lines are negative. These are two factors. The third is their point of union, the combination of straight and curved lines. As you look at this page its meaning is conveyed to you by a trinity, straight lines, curved lines, and their mutual relation to each other. The lines themselves, as well as every object and every picture, is conveyed to the consciousness by still another trinity. There are light spaces and there are shadows, or colored spaces. Neither alone has significance. It is only when dark spaces and light spaces have the third element, the point of union, that form is perceived.

Now it is true that in considering a trinity it may be turned so as to be viewed as a quaternary or as a duality or as made up of unities. As a quaternary we might say that the fourth factor in the above illustration is the printed word or the form as perceived, just as we could properly consider straight lines and curved lines as the duality, and each as a unity. But this is changing the perspective, and in no way vitiates the usefulness of the trinity. Matter, for instance, exists in three states; gaseous, liquid, and solid. Likewise the zodiacal signs fall into three groups; the movable signs, the mutable signs, and the fixed signs.

We have already seen that there are four triplicities. Each triplicity contains three signs, and each of these signs expresses the element to which the triplicity corresponds in a different state of activity. This different state of activity is called the Quality of the sign. Triplicity and Quality must not be confused. There are four triplicities—fire, water, earth, and air—but there are only three Qualities—Movable, Mutable, and Fixed.

The signs of the Movable Quality are Aries, Cancer, Libra, and Capricorn. They express the nature of each of the four elements in the highest state of activity. Matter in the gaseous state, though chemically the same, is far more active and possesses different qualities than when in the liquid or solid state. People, also, born under the movable signs, are active, energetic, and given to change; even as gas generates power and finds it easy to move in various directions little hindered by gravitation. They break the trails that others follow, and start the enterprises that others finish. The natives of Aries pioneer in daring enterprises and adventure. Cancer people pioneer in home building and in foods. Those born under Libra pioneer in literature, art, and social affairs; while those belonging to the sign Capricorn are pioneers in business and industry. The signs of the movable quality produce people who are PIONEERS.

The signs of the Mutable Quality are Gemini, Virgo, Sagittarius, and Pisces. They express the nature of each of the four elements in a medium state of activity. Matter in the liquid state, though possessing the same chemical elements as when gaseous or solid, is more subject to gravitation and less aggressive in its chemical action than when gaseous; but more active and yielding, and less given to permanence than when in the solid state. The mutable signs are a happy medium between the excessive

activity of the movable signs and the stubborn resistance of the fixed signs. Liquid cannot force its way through an aperture as easily as can gas, but once a channel has been established it quickly follows the line of least resistance. People born under the mutable signs seldom break trails, but follow on the heels of the pioneers. As liquid conforms to the object with which it is in contact, so mutable people are the most adaptable of all. The signs of the mutable quality produce people who seldom originate an enterprise. They are the DEVELOPERS.

The signs of the Fixed Quality are Taurus, Leo, Scorpio, and Aquarius. They express the nature of each of the four elements in the lowest state of activity. Matter in the solid state is rigid, durable, and unyielding. People born under the fixed signs are quite as unbending, firm, and resistant. Solids find difficulty in altering their form and location; and people belonging to the fixed signs are strongly attached to their customary environment, their customary manner of doing things, and their customary methods of thought. They have great resistance to pressure of all kinds, strong endurance, plodding perseverance and the ability to give close attention to detail. They are not originators, and not enthusiastic developers; but when development has reached a high degree, they work out details that constitute improvements. The signs of the fixed quality produce people who are PERFECTERS.

Now we found when considering sight, that it could be viewed as a trinity from two different perspectives. We also find that the signs of the zodiac may be viewed as a trinity in two different ways.

In addition to the Quality, which, as we have seen, relates to the state of activity of the signs belonging to each of the four elements, there is also the matter of precedence in the zodiac of the signs belonging to each of the four elements. Thus of the fiery signs, one of them occurs first in the zodiac, another second, and another third, in the order of their succession, commencing with the vernal equinox. It is found that this matter of precedence in the zodiac has much to do with the etherealization of the spiritual and mental forces as expressed through the signs. This manifests itself in human life chiefly in regard to whether the motive for action is largely internal or largely external.

Reverting to our comparison of the radiations from the planets to definite musical tones, and of the signs to sounding boards from which these tones are reverberated; we might class the fiery signs as stringed instruments, the watery signs as the liquid chimes, the earthy signs as the booming drums, and the airy signs as the wind instruments. We might even go further, and class the movable signs as those instruments that take the celestial treble, the mutable signs as those that take the ripe tenor, and the fixed signs as those that sound the rolling bass. Yet, even with such a classification, there would still remain to be considered the particular tone quality of each instrument, by which it could be discerned from other instruments, even from those playing the same tones and employing a similar method, as the tone of a guitar may be distinguished from the same tone on a violin.

This tone quality is thus still further elaborated by considering the sign's precedence in the zodiac, compared to other signs of the same triplicity. This designation is called its Degree of Emanation. The first sign of a triplicity in the zodiac belongs to the first degree of emanation, the second sign to the second degree of emanation, and the third sign to the third degree of emanation.

The signs of the First Degree of Emanation are Aries, Taurus, Gemini, and Cancer. People born under these signs act from motives that chiefly spring from their own feelings, ideas, and inward yearnings. When expressing themselves they tend to externalize their own inner nature with LIBERTY.

The signs of the second Degree of Emanation are Leo, Virgo, Libra, and Scorpio. People born under these signs act from their own feelings, ideas, and inward yearnings, tempered by a full consideration of what other people feel, think, and advise. When expressing themselves they tend to externalize their own inner nature with MODIFICATION.

The signs of the Third Degree of Emanation are Sagittarius, Capricorn, Aquarius, and Pisces. People born under these signs act less from their own feelings, ideas, and inward yearnings, than from ideas and attitudes that have reached them from without. When expressing themselves they tend to externalize their own inner nature with RESERVE.

We are now ready to consider the zodiacal signs as a duality. Commencing with Aries as the first positive and masculine sign, every alternate sign is negative and female. The positive, masculine, electrical signs are: Aries, Gemini, Leo, Libra, Sagittarius, and Aquarius. The negative, feminine, magnetic signs are: Taurus, Cancer, Virgo, Scorpio, Capricorn, and Pisces.

To complete our view of the zodiacal signs we have yet to discuss them as a unity. We have considered them as a quaternary, as a trinity, as a duality; and now we must consider them as a unity, each sign as a sounding board of specific tone quality for celestial vibrations.

Aries

Pictured among the constellations by the Ram, is the first sign of the zodiac. It belongs to the element fire; hence we expect it to be energetic, courageous, and daring. It is a movable sign, comparable to burning gas, therefore not to be confined, or dictated to by another. Belonging to the first degree of emanation, it is little influenced by precedent or environment. It is a masculine sign, and assertive. In human anatomy it rules the head. As the first sign of the zodiac it represents birth, as ruling the brain it signifies perception. Aries people express a fiery will, a militant power, executive ability, imperious leadership, and the dauntless pioneer spirit. They are ambitious, enterprising, forceful, combative, self-willed, keen, independent, active, and desirous of being in command. Impulsive and fiery, yet even in apparent

rashness they are guided by intellect. All the world seems new to Aries people. Their dominant idea is I AM.

Taurus

Traced among the stars as the Bull, is the second sign of the zodiac. It belongs to the element earth; hence we expect it to be industrious, patient, and practical. It is a fixed sign, comparable to frozen earth, therefore, stubborn, immovable, and conservative. Belonging to the first degree of emanation it bows little to the opinions of others, and usually has a tendency to become interested in psychic phenomena. It is a feminine sign, reserved and not intruding. In human anatomy it rules the ears, the base of the brain, the neck, and the throat. Commands are received through the ears, and Taurus people are obedient servants, careful, plodding, and self-reliant. The motor nerves spring from the region ruled by Taurus, hence we find them persistent and untiring workers. They have pronounced powers of discrimination, will wait a long time for plans to mature, are secretive, and possess enormous reserve energy. They are strongly attracted to money, and express themselves by its use. Capricorn is the organizer of industry, Virgo the engineer, and Taurus the perfecter of its details and the custodian of its wealth. The dominant idea is I HAVE.

Gemini

Pictured in the sky by the Twins, is the third sign of the zodiac. It belongs to the element air, consequently is volatile, intellectual, and changeable. It is a mutable sign, comparable to liquid air, therefore possessing wonderful powers of mental expansion and a constant flow of ideas expressed through conversation or writing. Belonging to the first degree of emanation, it is not bound so much by material motives as actuated by the desire for mental expression. It is a masculine sign, able to exert considerable initiative. In human anatomy it rules the hands, arms, and upper respiratory system. The hands, as organs of execution, are dual, and Gemini people are remarkable for both executive ability and versatility. They usually are interested in several things at once, and change their occupation often. They have a fondness for learning, are restless, dexterous, sensitive, skillful, and intuitive; and ever on the alert to learn the "Why" of things. Their dominant idea is I THINK.

Cancer

Represented in the heavens as a Crab, is the fourth sign of the zodiac. It belongs to the element water, therefore is sensitive, receptive, and timid. It is a movable sign, comparable to fog, subject to whims, moods, and varying changes, not to be confined in a single environment, but possessing unusual freedom to alter its own position.

Belonging to the first degree of emanation, its moods and yearnings are expressed pronouncedly. It is a feminine sign, but makes up with tenacity its lack of aggressiveness. In human anatomy it rules the seat of nourishment, the breasts, bosom, lower lungs, and stomach. Cancer people absorb ideas and conditions and after digesting them are capable of diverting them to their own use. They are not active physically, but are intensely active assimilating and redistributing sense impressions. Mediumistic, reflective, dreamy, mild of temper, emotional, very domestic, they respond to kindness, sympathy, and approbation, are fond of publicity, and are influenced by their surroundings. The dominant idea is I FEEL.

Leo

Designated in the firmament by a Lion, is the fifth sign of the zodiac. It belongs to the element fire, therefore is impulsive, passionate, and daring. It is a fixed sign, comparable to hot metal, dominating, ambitious, and resolute. Belonging to the second degree of emanation, its actions spring from the emotions rather than from the intellect. It is a masculine sign, possessed of unbending dignity. In human anatomy it rules the heart and back. Leo people are sympathetic, warm-hearted, candid, forceful, and fond of honors and high office. They are not so active as Aries people, but possess great determination to rise, and strive to rule through strength and stability rather than through alertness and activity. Their ideas are large and majestic, despising petty effort, and in striving to reach higher states often overreaching. Unlike Aries people, when aroused emotionally they do not count the cost. The dominant idea is I WILL.

Virgo

Emblazoned above as the celestial Virgin, is the sixth sign of the zodiac. It belongs to the element earth, therefore is practical, industrious, and worldly. It is a mutable sign, comparable to liquid earth, such as mortar, binding together what others quarry, selecting materials furnished by other people and placing them in their proper order. Belonging to the second degree of emanation, it is neither so independent of environmental influences as Taurus, nor so dependent upon them in regard to its completeness of expression as Capricorn. It is a feminine sign, preferring arbitration to combat. In human anatomy it rules the navel and bowels. Virgo people are intensely discriminative, even as the function of the intestines is to assimilate the food required by the body. The constant process of analysis for the purpose of discrimination inclines them to be critical. Intensely active mentally, they have a faculty for acquiring knowledge, being studious, scientific, mentally alert, ingenious, witty, fluent, discerning, and ever seeking "How" desired results may be accomplished. The dominant idea is I ANALYZE.

Libra

Pictured along the pathway of the sun as the Scales, is the seventh sign of the zodiac. It belongs to the element air, therefore is changeable, bright, and socially inclined. It is a movable sign, comparable to the gusts of wind on an April day, pioneering in the arts and in social affairs. Belonging to the second degree of emanation, it combines idealism with worldly motives. It is a masculine sign, adaptable, but not submissive. Libra people are easily influenced by others, but quickly regain their equilibrium. They are sensitive, refined, sympathetic, artistic, neat, particular, dislike unclean work, and are inordinately fond of approbation. Lovers of justice, peace, and harmony, they are kind, generous, and affectionate, finding social relations extremely important, and a partner often essential to their happiness. They are fond of music and entertainment, are courteous, and desire to make many friends, yet in their affections are somewhat changeable. The dominant idea is I BALANCE.

Scorpio

Pictured among the constellations by a scorpion, is the eighth sign of the zodiac. It belongs to the element water, hence has strong emotions and is domestically inclined. It is a fixed sign, comparable to water crystallized through great pressure rather than through lowered temperature, and therefore capable of exerting tremendous force, boiling the moment it finds an avenue of escape. At once unyielding, yet it is capable of exerting immense pressure upon its environment. Belonging to the second degree of emanation, it moves more with the world's mental current than athwart its flow. It is a feminine sign, very receptive and meditative. In human anatomy it rules the generative organs and procreative attributes. Scorpio people have a never failing fund of ideas and resources, and an abundant life giving magnetism. They are proud, secretive, reserved, jealous, energetic, ingenious, strong willed, determined, enterprising, and skillful, making good surgeons, doctors, chemists, scientists, and mechanics. Their dominant idea is I DESIRE.

Sagittarius

Represented among the stars as a Centaur, is the ninth sign of the zodiac. It belongs to the element fire, hence is energetic, hasty, and enthusiastic. It is a mutable sign, comparable to molten metal, aggressive and impulsive, but not dominating. Belonging to the third degree of emanation, its actions are largely shaped by what other people think proper and in good taste. It is a masculine sign, positive and forceful. In human anatomy it rules the hips and thighs, which are the foundation of volition and locomotion. Sagittarius people are a happy medium between Aries

people, who are ruled by their heads, and Leo people, who are ruled by their hearts. They love outdoor sports, are loyal, patriotic, generous, free, ambitious, charitable, and jovial. Frank, outspoken, self-reliant, they are great travelers, are very conservative, have prompt decision, and the ability to command others. The dominant idea is I SEE.

Capricorn

Traced in the constellations as the Goat, is the tenth sign of the zodiac. It belongs to the element earth, hence is practical, industrious, and acquisitive. It is a movable sign, comparable to dust, adapting itself to every requirement to gain its ends; persistent, subtle, and ambitious. Belonging to the third degree of emanation, it acts largely from external motives. It is a feminine sign, gaining its point by cunning rather than by force. In human anatomy it rules the knees. Capricorn people are humbly submissive to those in power, and unceasing in their efforts to gain power that others may bend the knee to them. They are diplomatic, good organizers, ever alert to take advantage of circumstances or the weakness of the other people, are careful, cautious, frugal, and insistent, with thoughtful, serious, reflective minds. Their dominant idea is I USE.

Aquarius

Shown in the vault of heaven as the Man, is the eleventh sign of the zodiac. It belongs to the element air, hence loves the society of others and the interchange of ideas. It is a fixed sign, comparable to crystallized air, is the most practical of all the airy signs, and the one possessing the most continuity. Belonging to the third degree of emanation, its actions are greatly influenced by its external environment. It is a masculine sign, extremely assertive. In human anatomy it rules the ankles, the active power of locomotion. Aquarius people are very progressive, usually possessing ideas more advanced than their companions. They are inventive and scientific, pleasant, friendly, quiet, patient, determined, faithful, cheerful, sincere, easily influenced by kindness; artistic, refined, have strong likes and dislikes, are greatly interested in education and new discoveries, and like nothing better than an argument. The dominant idea is I KNOW.

Pisces

Represented among the constellations as the Fishes, is the twelfth sign of the zodiac. It belongs to the element water, hence is dreamy, mystical, and romantic. It is a mutable sign, comparable to water, mirroring like a lake its environment, moved by every motion near it. Belonging to the third degree of emanation, it tends to become

all things to all people. It is a feminine sign, listless and negative. In human anatomy it rules the feet, the foundation of the human temple. Pisces people, though imaginative and dreamy, have the ability to flow into such grooves of the world's affairs that they usually acquire the material things necessary for comfort. They are idealistic, sensitive, mediumistic, prone to worry, peaceable, sympathetic, prudent, modest and often lack self-confidence. No other sign has such extremes of temperament and ability; for Pisces people will be found both on the height and in the depth, and some of them are successful in almost every line of human endeavor. The dominant idea is I BELIEVE.

EXPRESSION OF PLANETS THROUGH THE HOUSES

A planet in a house, or ruling it, influences the events of the department of life mapped by that house in the following manner:

Sun, expresses through VIGOR.

Moon, expresses through FLUCTUATION.

Mercury, expresses through THOUGHT.

Venus, expresses through GRATUITIES.

Mars, expresses through STRIFE.

Jupiter, expresses through ABUNDANCE.

Saturn, expresses through POVERTY.

Uranus, expresses through ECCENTRICITY.

Neptune, expresses through ILLUSION.

Pluto, expresses through COERCION.

DEPARTMENTS OF LIFE RULED BY THE HOUSES

Each Mundane House maps the particular section of man's astral body, or the particular section of the world's astral form, the inner-plane activities of which determine what happens in one department of life. The departments of life thus mapped are as follows:

First House: personality, health, the body.

Second House: money, personal property.

Third House: thoughts, studies, short journeys, relatives.

Fourth House: father, real estate, home, end of things.

Fifth House: speculation, children, love affairs, entertainment.

Sixth House: work, illness, food, employees.

Seventh House: marriage, partnership, public, open enemies.

Eighth House: death, inheritance, taxes, money of others.

Ninth House: publicly expressed opinions, books, religion, long journeys.

Tenth House: the job, business, honor, reputation.

Eleventh House: hopes, friends, acquaintances.

Twelfth House: secret enemies, disappointments, astral entities.

Chapter 3

Serial No. 47
Original Copyright 1926
Elbert Benjamine

Copyright
Church of Light
August 2002

Mundane Houses

Chapter 3

Mundane Houses

PLANETARY vibrations not only must have a point of departure, but also, if they are effective, must have a place of reception. A tone reverberating from the sounding board of one of the zodiacal signs must reach the earth in order to affect the destiny of the inhabitants of the earth. To do this it must penetrate the astral field associated with the earth. The direction from which such a planetary vibration reaches a given spot on the earth determines the relative direction of movement of the astral field penetrated, and also the amount of astral field through which it must pass. These two factors, it has been ascertained by observation, determine the department of life which the vibrations will influence. To ascertain the volume of planetary vibrations reaching the earth from given directions, and the departments of life they influence, is our object in the study of Mundane Houses.

In preceding lessons I have compared the planetary vibrations to musical tones. In fact, I know of no better designation for them than planetary tones. Each planet sounds its own tone. The zodiacal signs I have compared to sounding boards from which these tones resound. The tone is modified, not in its essential vibratory rate, but in tone quality, by the sounding board, or zodiacal sign, from which it reverberates. Furthermore, musical tones and planetary tones have both a point of departure and a place of reception; and the place of reception of planetary tones, so far as we are concerned, is the earth, acting as a grand auditorium.

In most auditoriums, due to distances from the instruments, to obstructions that may intervene, and to other acoustic factors, tones are not heard in the same volume and with the same precision throughout all its sections. The earth as an auditorium is unique; for the various musical instruments, the zodiacal signs, are ranged completely around the outside of it. Nevertheless, as in most auditoriums, the relation of a particular point in it to the positions where tones are being sounded, modifies the tones at the place of reception. That is, tones coming from one direction are stronger and clearer than tones coming from another direction, because they have less of the astral field of the earth to penetrate, and are less interfered with by its rotation due to the turning of the earth on its axis.

It will thus be seen that persons occupying different portions of the terrestrial auditorium-situated at different stations on the face of the earth-will not hear the

tones from the celestial instruments with the same clarity. At any given time some may be more favorably located than others for the reception of certain tones.

Because in the case of the earthly auditorium it seems to be the thickness or thinness of the astral field of the earth at a given point, together with its movement, that determines the ease with which planetary tones reach a given point, we may compare the terrestrial auditorium to a building the walls of which are of varying thickness. At certain intervals there are doors, and at other intervals there are windows. Thus the musical instruments ranged around the outside easily find access for their tones through the wide-open doors; find access with less ease through the windows; and reach the interior only with great difficulty through the denser portions of the walls. It is to map these sections of varying resistance that we have recourse to a diagram of the Mundane Houses.

Thus to map the amount of wall thickness, and the tone modifications due to earth rotation, at any given spot on the surface of the earth; that spot is taken as the center, about which, from west to east, is circumscribed a circle. This circle, commencing at the eastern horizon, is then divided into twelve equal segments. Mundane means pertaining to the earth. A house is a dwelling place. A Mundane House, then, is the dwelling place of a celestial influence at any moment of time, considered solely from the point on the earth where the influence is received. Each of the twelve equal segments of the circle about the earth from west to east is a Mundane House.

A clearer conception of the Mundane Houses may be had by facing the south and imagining one's self the hub of a great wheel, the circumference of which passes directly from the horizon in the east, on the left, under one's feet around to the horizon in the west, on the right, from thence directly overhead, and back to the eastern horizon again. Let one then imagine this great wheel to possess twelve spokes radiating into the sky from the point where one stands as a center, these spokes equally spaced about the wheel. Such a wheel accurately pictures the twelve houses of a horoscope, the dividing line between two houses, called a House Cusp, being represented by each spoke.

The first spoke in this great wheel is occupied by the horizon directly to the east of where one stands. The eastern horizon, then, is the cusp of the First House. This is a very important point in a horoscope, and because it is at this place that the planets rise from below the horizon into view it is called the Ascendant.

The opposite horizon, directly to the west of the observer, representing the seventh spoke of the great wheel, is the cusp of the Seventh House. Because it is the point where the planets sink from view below the western horizon it is called the Descendant.

The point directly beneath one's feet, representing the fourth spoke of the great wheel, is the cusp of the Fourth House. Because it is the lowest point it is called the Nadir.

The point directly overhead, the zenith, representing the tenth spoke of the great

wheel, is the cusp of the Tenth House. This is also a very important point in a horoscope, for it is here that a planet reaches its greatest elevation. It is called the Mid-Heaven, or more often abbreviated from its Latin equivalent, Medium Coeli, and merely termed the M. C.

These four spokes divide the earthly auditorium into four quadrants. At sunrise the sun is exactly on the cusp of the Ascendant. At midnight the sun is exactly on the cusp of the Nadir. At sunset the sun is exactly on the cusp of the Descendant. At noon the sun is exactly on the cusp of the M. C. (See diagram, page 18).

Because we of northern latitudes must look south to view the sun or a planet when it is on the M. C., the cusp of the Tenth House is also called the South Point. And because the Nadir, abbreviated from the Latin Imum Coeli as I. C., is opposite the South Point, it is sometimes called the North Point. The four points, Asc., M. C., Desc., and Nadir, are the strongest points in a horoscope in the sense that a greater volume of energy reaches the earth from a planet when it is located near one of these points than when it is located in any other section of the heavens. This is not difficult to demonstrate experimentally. It is as if at other stations there were walls of varying thickness, but at these points the doors were wide open so that the planetary tones may enter the auditorium without interference.

Now as the zodiacal signs are each thirty degrees in extent, and the houses of the horoscope are also of thirty degrees expanse, at first thought it might be assumed that the equivalent of one sign, or thirty degrees of the zodiac, always occupies exactly one Mundane House. This certainly would be the case if the circle of Mundane Houses coincided with the zodiac. However, it does not coincide with the zodiac. Except at the equator the Mundane Houses are to the north or to the south of the mean position of the zodiac. The effect of thus being to the north or to the south of the equator in its extreme influence is familiar to us in the accounts of arctic explorers who witness a midnight sun.

In such a case the degree of the zodiac occupied by the sun does not, during the twenty-four hours, pass into any of the six houses below the horizon. This midnight sun, as well as the phenomenon of six months daylight followed by six months darkness near the poles, is the result not merely of the observer occupying a high latitude, but also to the incident that the zodiac is inclined at an angle of over 23 degrees to the equator. That is, even at the equator, the zodiacal signs rise diagonally. The further to the north or to the south of the equator the observer moves the more diagonally do the signs rise. Thus in north temperate latitudes in summer, the sun appears on the horizon, when it rises, well north of east of the observer, and as it moves toward noon it swings up and to the south. The farther north the observer goes, the farther to the north the sun appears to rise in summer, until finally, in extreme north latitudes, it fails to set, merely circling around the north horizon from the west to the east at night without disappearing.

Now if you draw two parallel lines an inch apart, and then measure the distance between them diagonally instead of straight across, you will find that the diagonal

line is much more than an inch. In fact, the more the diagonal inclines to the parallel lines the longer it must be. Without entering into a technical explanation of the matter, it will be seen that if the zodiac rises diagonally, as it were, that it is necessary for some of the Mundane Houses of thirty degrees extent to contain more than thirty degrees of the zodiac. Furthermore, being true circles, if the zodiac is diagonal to the Mundane Houses at some points, relative to the zodiac the Mundane Houses are diagonal to it at other points. To state it more precisely, as there are 360 degrees in the zodiac and 360 degrees in the Mundane Houses, if more than thirty degrees of one section of the zodiac occupies one house, less than thirty degrees of some other section of the zodiac must occupy some other house.

A technical explanation of the reason why, in making a chart of the heavens, more often than not some Mundane Houses will hold more than thirty degrees of the zodiac and others less than thirty degrees of the zodiac, would be out of place here. I trust, however, these remarks will give a general idea why it is that more than one zodiacal sign may, and often does, occupy one house of the horoscope. As the basis on which the Tables of Houses commonly employed are constructed is that each shall contain precisely thirty degrees, I trust also that it will be clear that so long as we employ such tables, each Mundane House must be exactly thirty degrees in extent, irrespective of the number of degrees of the zodiac it holds.

To make a map of the Twelve Mundane Houses the student should draw a circle and bisect it with a heavy horizontal line from left to right. This horizontal line represents the horizon, and the half of the circle above this line represents the visible portion of the heavens—all that is above the horizon. The half of the circle below this line represents the portion of the heavens that is invisible due to being below the horizon.

Next the circle should be bisected by a vertical line. All to the left of this line is eastward, and all to the right of this line is westward, from the observer. As to see the planets and the zodiac we face the south, the top of the map is south; just the reverse of a geographical map. The four quadrants now mapped by the two intersecting lines should each be divided by two radii from the center of the map, thus dividing each into three equal sections. This gives a circle divided into twelve equal segments (See diagram, page 18), which should be numbered, commencing with the segment just below the eastern horizon as the First House, the next segment below it as the Second House, etc.

That energies of tremendous power, hitherto quite unrecognized, are pelting the earth day and night from the regions of space, has been demonstrated by the discovery in 1925 of the Cosmic Ray. That such a force—so powerful that were its volume to increase it is believed it would constitute a serious menace to life upon the earth—should remain undiscovered so long, leads to the inevitable conclusion that there may be numerous other energies reaching and influencing the earth as yet to be brought within the ken of material science. And one willing to investigate will find that a planet sending its rays to the earth through a certain one of the Mundane Houses has an effect upon a different department of life than if its rays were received through any of the other houses.

Consider for a moment that most of us feel differently than at other times when the sun is in the Third House—from midnight to about 2 a.m. Physical vitality is low at this period, and more people die—so medical statistics state—during this interval than during any other. While the sun is in the Second House—from about 2 a.m. to near dawn—not merely the physical forces are sluggish; but the courage is low and the mind depressed. It is the zero hour. Yet with the coming of dawn, and from then to sunrise—while the sun is in the First House—there is a general awakening of life energies the world over. Immediately after sunrise there is a temporary lull, and yet a very different influence again in the period just preceding noon.

I am here merely calling attention to conditions that are familiar to all who observe closely. The rotation of the earth causes rays from the planets to meet with different densities of astral field, or with the astral field moving differently, as they reach the earth through the various Mundane Houses. In some manner this resistance offered by the earth's astral field—under the particular motion that obtains in each respective house—causes whatever planetary energies that pass through the house to have a specific affinity with the section of a person's astral body where are stored the thought-cells relating to some special department of life. All the mechanical steps by which vibrations coming through one house influence chiefly one special department of life may not be theoretically clear. But for that matter neither is it mechanically clear why the roots of a plant grow away from the sunlight and the stalk of the plant toward it. Yet we can prove they do so; and it is not a more difficult task to prove—using the birth chart of the first person at hand—that planetary energies reaching the earth through a certain Mundane House have an affinity for a certain department of life. The consideration of this relation between the Mundane Houses and the department of human life affected through each, is the next matter to engage our attention.

As we found the magical formula, Jod-He-Vau-He, of great assistance in studying the zodiacal signs, we shall also find it advantageous to apply it in a similar manner to the Mundane Houses. Even as the signs were found to separate into four equal groups of three signs each, so likewise the Mundane Houses separate into four trinities.

The Trinity of Life embraces the First, Fifth and Ninth Houses. The first house influences the constitution and vitality. The fifth house influences the life of the offspring. The ninth house influences the life in relation to religion and philosophy. This trinity corresponds to the fiery signs of the zodiac.

The Trinity of Psychism embraces the Fourth, Eighth, and Twelfth Houses. The fourth house influences the home and the end of life. The eighth house influences death and inheritance. The twelfth house influences sorrows and imprisonment. This trinity corresponds to the watery signs of the zodiac.

The Trinity of Wealth embraces the Second, Sixth, and Tenth Houses. The second house influences personal property. The sixth house influences labor and servants. The tenth house influences business and honor. This trinity corresponds to the earthy signs of the zodiac.

The Trinity of Association embraces the Third, Seventh and Eleventh Houses. The third house influences the thoughts and the brethren. The seventh house influences partnership and marriage. The eleventh house influences hopes and friends. This trinity corresponds to the airy signs of the zodiac.

Next we must consider the houses as of three different Volumes; each volume embracing four houses.

The Angular Houses are the First, Fourth, Seventh, and Tenth. These are of the strongest volume. It is as if there were wide open doors about the earthly auditorium at these stations, through which the full volume of planetary influence may enter unimpeded. They are called angular because their cusps, being directly upon the eastern and western horizons and upon the zenith and nadir, are the lines dividing the heavens into quadrants.

The Succedent Houses are the Second, Fifth, Eighth, and Eleventh. They are of moderate volume, as if there were but small windows in the earthly auditorium at these stations, through which celestial tones may enter only in reduced amounts. They are called succedent because they succeed, or follow, the angular houses.

The Cadent Houses are the Third, Sixth, Ninth, and Twelfth. These are of the least volume, as if at these stations about the earthly auditorium there were thick walls through which the heavenly tones penetrate only as muffled sounds. They are called cadent—meaning to “fall away”—because they fall away from the other houses both in volume of influence and in position.

Now we found that the zodiacal signs were divisible not only into Three Qualities, but also into Three Degrees of Emanation. Likewise, we find that the Mundane Houses are divisible into Three Volumes; also into Three Societies.

The Personal Houses embrace the Twelfth, First, Second, and Third. They influence personal sorrows, the personal body, the personal property, the brethren and personal thoughts. These houses have to do with the private life.

The Companionship Houses embrace the Fourth, Fifth, Sixth, and Seventh. They influence the companionship in the home and at the end of life, the companionship in pleasure and with children, the companionship in work and with servants, and the companionship in partnership, in marriage, and in meeting the public. These houses have to do with closely contacting people.

The Public Houses embrace the Eighth, Ninth, Tenth, and Eleventh. They influence the public life through deaths and legacies, through advertising and public utterances, through reputation and credit and through friends. These houses have to do with matters that become widely known.

As a Duality, the Mundane Houses may also be viewed in two different ways. They may be considered in relation to the facility with which their influence gains recognition. And they may be considered in relation to the waxing or the waning of their power. The Six Houses above the Horizon—Seventh, Eighth, Ninth, Tenth,

Eleventh, and Twelfth-are positive and tend to the ready expression of any influence found in them in such a way that it gains recognition. The Six Houses below the Horizon-First, Second, Third, Fourth, Fifth, and Sixth-are negative and tend to the development of whatever influence is found in them in secrecy. The Six Houses on the East side of the chart-Tenth, Eleventh, Twelfth, First, Second, and Third-tend toward increase, and whatever influence is found in them inclines to further development. The Six Houses on the West Side of the chart-Fourth, Fifth, Sixth, Seventh, Eighth, and Ninth-tend toward decrease, and whatever influence is found in them inclines to dissolution.

Having now discussed the Mundane Houses as a quaternary, a trinity, and as a duality, to complete our magical formula, 1-2-3-4 equals 10, we have yet to consider them as a unity.

The First House belongs to the trinity of life. It is an angular house; consequently transmits energy of the strongest volume. It is a personal house, related to the private life. Being below the horizon its influences tend to develop in secret; but as it is on the east side of the chart they develop persistently. It influences the health, the personal appearance, the temperament, such matters as cause changes in the form or location of the person; and in general the personality through which the character must express.

The Second House belongs to the trinity of wealth. It is a succedent house; consequently transmits energy only in moderate volume. It is a personal house, related to the private possessions. Being below the horizon these possessions are not open to public inspection; yet any influence expressing through this house tends to development. The tenth house represents the business, and the sixth house the labor involved; but the second house represents the fruits of these in terms of cash and other personal property.

The Third House belongs to the trinity of association. It is a cadent house; consequently transmits energy very weakly. It is a personal house, related to the private thoughts. Being below the horizon these thoughts may never be expressed to others; but any influence in this house tends toward development. It influences the thoughts, which are the mental associates; the brethren, neighbors, writing, short journeys, correspondence, and education.

The Fourth House belongs to the trinity of Psychism. It is an angular house; consequently transmits energy of the strongest volume. It is a companionship house, relating to those in the home. Being below the horizon its influences tend to be kept from the public, and as it is on the west side of the chart they have little power of growth. This house influences the parentage, the father in particular, the home and general domestic environment, inherited tendencies, real estate, hidden things, and the condition at the close of life. These things, as exerting a powerful influence on the unconscious life, are of psychic import.

The Fifth House belongs to the trinity of life. It is a succedent house; consequently transmits energy only in moderate volume. It is a companionship house, relating to

the companionship of children and the companionship in pleasure. Being below the horizon its influence is not heralded to the public, nor do we expect any influence here to undergo great development. It rules broadly the life of the affections, of the children, and of the pleasures; governing speculation, amusements, offspring, and love affairs.

The Sixth House belongs to the trinity of wealth. It is a cadent house; consequently transmits energy very weakly. It is a companionship house, relating to servants and to those with whom one works. Being below the horizon any influence here tends to be kept secret, and as it is on the west side of the chart there is little opportunity for growth. It influences broadly those things that assist or hinder the acquisition of wealth, such as assimilation, illness, labor, inferiors, and servants.

The Seventh House belongs to the trinity of association. It is an angular house, consequently transmits energy of the strongest volume. It is a companionship house, relating to partnerships and marriage. Being above the horizon its influences tend to gain wide recognition; although there is little growth from them. It governs the relations with the public, partnerships, open enemies, lawsuits, and marriage.

The Eighth House belongs to the trinity of psychism. It is a succedent house; consequently transmits energy only in moderate volume. It is a public house, and the things it influences are kept secret with great difficulty. They do not, however, tend toward any great development. It influences the relations to the public's money, and to the money of the partner: also the relations to the dead, both their psychic influence and the inheritance from them. In addition to such legacies it also influences the conditions surrounding the person's death.

The Ninth House belongs to the trinity of life. It is a cadent house; consequently transmits energy very weakly. It is a public house, having to do with the public expression of opinions. Being above the horizon the things it influences tend to gain wide recognition. They do not, however, tend to continued development. This is the house ruling advertising, publishing, dreams, long journeys, philosophy, religion, and the public expression of ideas.

The Tenth House belongs to the trinity of wealth. It is an angular house, consequently transmits energy of the strongest volume. It is a public house, relating to the credit and honor. Being above the horizon there is public recognition of the things it influences. These things are subject to much development. It influences the mother, the trade or profession, the business qualifications, superiors, credit, reputation, and the esteem in general with which one is held by others. It thus greatly influences material success.

The Eleventh House belongs to the trinity of association. It is a succedent house; consequently transmits energy only in moderate volume. It is a public house, and the things it influences are widely known. Being above the horizon there is full recognition of all its affairs, and they are subject to persistent development. Its associations are occasional rather than constant. It governs acquaintances, friends, hopes, and wishes. In particular it influences the attitude toward, and the benefit that

may be derived from, acquaintances.

The Twelfth House belongs to the trinity of psychism. It is a cadent house; consequently transmits energy very weakly. It is a personal house, and its affairs are kept as secret as possible, although being above the horizon the things it influences nevertheless gain some recognition. They also tend to persistent development. It influences secret enemies, sorrows, disappointments, restrictions, limitations, imprisonment, unseen forces, and the relation to astral entities.

Now let us apply the magical quaternary, Jod-He-Vau-He, to the planets. They are naturally divisible into such a quaternary because their energies affect four different phases of human life. Thus there are Vital Planets, Intellectual Planets, Social Planets, and Business Planets. The vital planets are the Sun and the Moon. The intellectual planets are Mercury and Uranus. The social planets are Venus, Mars, Neptune, and Pluto. The business planets are Saturn and Jupiter.

The trinity into which the planets are divisible is based upon whether their usual effect upon human life is Harmonious, Discordant, or Convertible. The harmonious planets are Jupiter and Venus. The discordant planets are Saturn and Mars. The convertible planets are Sun, Moon, Mercury, Uranus, Neptune, and Pluto. These convertible planets are not essentially harmonious or discordant, but may become either through the aspects received from other planets.

As a duality the planets are divisible into those that are electric and positive, and those that are magnetic and negative. The electric and positive planets are Sun, Mars, and Jupiter. The magnetic and negative planets are Moon, Venus, Saturn, Neptune and Pluto. Uranus is neutral and electromagnetic. Mercury is either positive or negative according to its association with other planets, being but the mediumistic transmitter of the positiveness or the negativeness of the other planets.

We have now discussed the planets as a quaternary, a trinity, and a duality, and to complete our 1-2-3-4, it remains to treat them as a unity.

1. The Sun is a vital planet, and a convertible planet, exerting either a harmonious or a discordant influence according to the aspects received from the other planets. He is electric, masculine, and positive, hence in his influence he is majestic and commanding. In human anatomy he rules the heart, the vital center of life. This gives us an insight into his character; for as the heart is the dominant physical organ, its pulsations being the source of circulation which makes life possible, so he rules the electrical energies on which the vitality depends. In his influence over the mind he rules the group of mental factors designated as the Power Urges, embracing pride, firmness, approbateness, conscientiousness, and self-esteem. His influence is greater than that of any other planet, being proud, grand, firm, unbending, kindly, gracious, paternal, considerate, moderately liberal, and controlling. His nature is best expressed in one word as VITALITY.

2. The Moon is a vital planet, and a convertible planet, exerting either a harmonious or a discordant influence according to the aspects received from the other planets.

She is magnetic, feminine, and negative, hence her influence is plastic and mediumistic. In human anatomy she rules the fluidic system of the body, the foundation of the health and general constitution.

This gives us an insight into her character; for as the fluidic system digests, assimilates, and distributes nutriment, so the Moon rules the assimilation of mental food by the astral brain, or unconscious mind. Her influence is cool, yielding, and formative, ruling the constitutional magnetism which markedly influences the health. In her influence over the mind she governs that group of mental factors designated as the Domestic Urges, embracing time, tune, sublimity, and philoprogenitiveness. Her influence over the strength of the constitution and the general state of the health is marked. She is changeable, negative, dreamy, inoffensive, and lacking in force. Her nature is best expressed in one word as IMPRESSIONABLE.

3. Mercury is an intellectual planet, and a convertible planet, exerting either a harmonious or a discordant influence according to the aspects received from the other planets. He is electric and positive when associated with electric planets, and magnetic and negative when associated with magnetic planets. In human anatomy he rules the tongue, brain, and nervous system. This gives us an insight into his character; for as the nervous system carries messages to and from the brain to all parts of the body, so Mercury acts as the messenger for the influence of other planets. As the tongue is the most used organ in the expression of thought, Mercury rules writing, talking, traveling, and the manner in which the mental ability is expressed. Thus while the Moon governs the Mentality, Mercury indicates the Ability, and the channels used, in giving the mind outward expression. And as there are afferent, or ingoing nerves, and efferent, or outgoing nerves; so Mercury influences both perception and expression. He has dominion over the perceptive and comparative group of mental factors designated as the Intellectual Urges, embracing eventuality, language, calculation, and the recognition of size, weight, form, and color. He is witty, quick, ingenious, intelligent, scientific, volatile, voluble, bright, enterprising, changeable, and persuasive. His nature is best expressed in one word as PERCEPTION.

4. Venus is a social planet, and a harmonious planet. She is magnetic, feminine, and negative, hence yielding and submissive. In human anatomy she rules the skin, venous system, and internal generative functions. This gives us an insight into her character; for as the skin is the organ through which feeling is experienced, so Venus is coy, shy, and sensitive. The venous system gently yields to the arterial pressure and carries the blood back to the heart, and Venus seeks the line of least resistance. The internal generative functions carry out the work of reproduction, and Venus, the planet of love, reproduces through the various arts the mental creations. In social life she inclines to affection and attraction. In her influence over the mind she rules that group of mental factors designated as the Social Urges, embracing, affection, friendship, mirthfulness, conjugality, and inhabitiveness. She is cool, moist, pliable, amiable, receptive, clinging, convivial, harmonious, and artistic. Her nature is best

expressed in one word as MILDNESS.

5. Mars is a social planet, and a discordant planet. He is electric, masculine, and positive, hence aggressive and penetrating. In human anatomy he rules the external sexual organs, the muscles, and the sinews. This gives us an insight into his character; for as the muscles and sinews are the organs of physical activity, so does Mars ever tend to rapid expansion and active effort. As the sexual organism is the seat of strongest desire, so does Mars have dominion over the animal appetites and passions. In social life he inclines to desire and strife. In his influence over the mind he rules that group of mental factors designated as the Aggressive Urges, embracing amativeness, destructiveness, combativeness, and alimentiveness. He is the exact antithesis of Saturn, being diffuse, hot, impulsive, rash, headstrong, and assertive. He is devoid of fear and timidity, is sharp, energetic, thoughtless, free, fierce, intrepid, and unrelenting. His nature is best expressed in one word as ENERGY.

6. Jupiter is a business planet, and a harmonious planet. He is electric, masculine, and positive, hence dignified and bold. In human anatomy he rules the liver and the arterial system of the body. This gives us an insight into his character; for as the arterial blood distributes warmth and nourishment to the whole body, so Jupiter ever tends to generosity, warmth, and gentle expansion. He is neither the rigid ice of Saturn, nor the fierce fire of Mars, but a genial radiant warmth, imparting happiness to all. In his influence over the mind he rules that group of mental factors designated as the Religious Urges, embracing benevolence, good cheer, veneration, hope, reverence, and spirituality. Whatever good Jupiter brings seems to come freely as the result of good will and good luck. Saturn gains in business through careful systematic effort, while Jupiter gains through patronage and favor. He is cheerful, generous, benevolent, magnanimous, just, charitable, honest, and discriminative. His nature is best expressed in one word as JOVIALITY.

7. Saturn is a business planet, and a discordant planet. He is magnetic, masculine, and negative, hence timid and retiring. In human anatomy he rules the bones, cartilage, and spleen. This gives us an insight into his character; for as the bones are the most solid portions of the body so does Saturn tend to the practical and concrete. As the spleen is a reservoir of electrical energy, so does Saturn try to collect and hoard the treasures of the earth and the treasures of the mind. In his influence over the mind he rules that group of mental factors designated as the Safety Urges, embracing secrecy, acquisitiveness, covetousness, causality, and comparison. He collects the various perceptions that are ruled by Mercury and synthesizes them into conceptions. He thus has rule over the reflective powers and the selfish sentiments. Whatever good comes from his influence is the result of carefully laid plans, plodding effort, subtlety, craft, and cunning. He dislikes to take the initiative, preferring to remain in the dark and accomplish through deception rather than through force. He is solitary, cold, reserved, melancholy, repentant, and fearful. His nature is best expressed in one word as CRYSTALLIZATION.

8. Uranus, the higher octave of Mercury, is an intellectual planet, and a convertible planet, exerting either a harmonious or a discordant influence according to the

aspects received from the other planets. He has no sex, and is electromagnetic, alternately attracting and repelling, hence particularly unreliable where the affections are concerned. In human anatomy he rules the electromagnetic body. This gives us insight into his character; for as the electromagnetic body is ordinarily imperceptible to the physical senses, yet is the dynamic energy of the body and the source of personal magnetism, so does Uranus direct and control the electrical energies and confer the ability to understand and utilize the occult forces of nature. In his influence over the mind he rules that group of mental factors designated as the Individualistic Urges, embracing independence, originality, inventiveness, and unconventionality. The moons of Uranus travel in a reverse direction to those of the other planets, except Neptune, hence he influences to take the reverse view of life from that commonly accepted, and is thus a radical; and he also inclines to look away from the physical to the things of the astral plane, having a strong influence over clairvoyance and intuition. He is thus the Inspirational ESP planet. He is abrupt, erratic, independent, sudden, penetrative, original, occult, scientific, unconventional, and progressive. His nature is best expressed in one word as DISRUPTIVE.

9. Neptune, the higher octave of Venus, is a social planet, and a convertible planet, exerting a harmonious or a discordant influence according to the aspects received from other planets. He is magnetic and negative in nature. In human anatomy he rules the astral body. This gives us an insight into his character; for as the astral body is molded by every desire, so does Neptune feel every mental current and psychic influence. As the astral body has the power of leaving the physical body, so does Neptune often depart from the practical and give its attention to unrealizable ideals. His dreamy and mediumistic qualities may lead to fantasy and the belief in grand hopes that are never realized. His moons, like those of Uranus, revolve about him in the reverse direction of those of the other planets. And his influence is to direct the mind from the sordid and the material to lofty spiritual ideals which when received in suitable soil tend to the development of the conditions and qualities that prove of greatest possible value to the human race. In social life he brings romantic attachments and platonic friendships. In his influence over the mind he rules that group of mental factors designated as the Utopian Urges, embracing certain high phases of majestic and utopian ideals, and the ability to bring into the realm of objective consciousness what has been seen, felt, heard, and otherwise experienced in the astral world. Neptune is the Feeling ESP planet. He is the promoter of worldly schemes to gain wealth without work. He is subtle, impressionable, psychic, emotional, mild, pleasant, theoretical, and fanciful. His nature is best expressed in one word as VISIONARY.

10. Pluto, the higher octave of the Moon, is a social planet, and a convertible planet, expressing either a harmonious or a discordant influence according to the aspects received from other planets. Like the number 10, which starts a new numerical cycle, Pluto is a transitional influence, and more than any other planet may express in either of two diametrically opposite qualities. He may express positively and electrically, but his more common influence is negative and magnetic. In human anatomy he rules

the spiritual body. In his influence over the human mind he rules that group of mental factors designated as the Universal Welfare Urges. They relate to groups, cooperation, the inner-plane, hidden forces, inversion, the inside of things, mass production, and to aggressive spiritual activity. The Lower-Pluto forces are drastically insidious and destructive, the Upper-Pluto forces are the finest and most spiritual of all. Not the individual who instigates the action, but the victim of coercion, has this planet prominent. To such events as he attracts, or to which he contributes, he adds a drastic quality. Pluto is the inner-plane planet and the planet of Transition ESP. His nature is best expressed in one word as COOPERATION.

I have now discussed in some detail Mundane Houses and Planets, and in chapter 2 the zodiacal signs were considered. To complete our magical formula, Jod-He-Vau-He, the fourth factor, that of aspects, must also be considered. But as these aspects are explained in Chapter 3 of Course 1, *Laws of Occultism*, and are fully considered in Chapter 2 of Course 8, *Horary Astrology*, I shall here merely enumerate them.

1. The Conjunction aspect is formed when two planets occupy the same zodiacal degree. It has an influence comparable to the Sun, being very powerful, convertible in nature, and either harmonious or discordant according to the planets making it. It is the aspect of PROMINENCE.
2. The Semi-Sextile aspect is formed when two planets are 30 degrees apart in the zodiac. It has an influence comparable to the Moon, being mildly harmonious. It is the aspect of GROWTH.
3. The Sextile aspect is formed when two planets are 60 degrees apart in the zodiac. It has an influence comparable to Venus, being cheerful, bright and strongly harmonious. It is the aspect of OPPORTUNITY.
4. The Square aspect is formed when two planets are 90 degrees apart in the zodiac. It has an influence comparable to Mars, being energetic, forceful, violent, destructive, and strongly discordant. It is the aspect of OBSTACLE.
5. The Trine aspect is formed when two planets are 120 degrees apart in the zodiac. It has an influence comparable to Jupiter, being jovial, fortunate, constructive, and harmonious in the highest degree. It is the aspect of LUCK.
6. The Inconjunct aspect is formed when two planets are 150 degrees apart in the zodiac. It has an influence comparable to Neptune, being slightly separative in action, slightly harmonious between harmonious planets, and slightly inharmonious between discordant planets. It is the aspect of EXPANSION.
7. The Semi-Square aspect is formed when two planets are 45 degrees apart in the zodiac. It has an influence comparable to Mercury, being vacillating and somewhat inharmonious. It is the aspect of FRICTION.
8. The Opposition aspect is formed when two planets are 180 degrees apart in the zodiac. It has an influence comparable to Saturn, being slowly separative, coldly

disintegrative, and discordant in the highest degree. It is the aspect of SEPARATION.

9. The Sesqui-Square aspect is formed when two planets are 135 degrees apart in the zodiac. It has an influence comparable to Uranus, being sharply disruptive, sudden, and somewhat discordant. It is the aspect of AGITATION.

10. The Parallel aspect is formed when two planets occupy the same degree of Declination, which, like the number 10, is a different plane of influence. It has an influence comparable to Pluto, adding a drastic quality to the effect of other aspects. It is also similar to the conjunction, though more persistent and less precise in action. It is the aspect of INTENSITY.

Chapter 4

Serial No. 4
Original Copyright 1927
Elbert Benjamine

Copyright
Church of Light
August 2002

The Mission of the Soul

Chapter 4

Mission of the Soul

THE PURPOSE of this lesson is to give information about the human soul such as will serve as a working basis for those who are struggling to attain Self-Conscious Immortality. To begin with we must know just what the soul is, and what it is not. Then it will be advantageous to know just how it was formed, and how it continues to grow. And finally, as the end which is of paramount value to each individual, the method will be outlined by which Self-Conscious Immortality can be won.

The reflective mind will hardly deny that self-culture is an object of highest import to man. Externals are of value only when there is an inner capacity to appreciate them. Of what value, for instance, is anything to that which has no consciousness? The struggle of life in all its forms seems to be but the effort to acquire, retain, and express, consciousness. Lower creatures cling to life, and the hope of immortality dwells within each human breast. It is the climax and crowning glory of evolution, the longed-for goal of every aspiring heart.

Such being the case, we are warranted in studying thoroughly how this desired end may be reached. And we can do no better in this at the start than to consider the principles underlying other great attainments. Take, for example, the stupendous achievements of the present age along industrial lines. These are without exception, founded upon man's increased ability for exhaustive detailed research, together with his ability to combine the innumerable factors revealed by such research into an efficient plan of action. Whether he be a builder of warships, skyscrapers, power plants, or railroads, his success depends primarily upon his grasp of all the factors and principles involved, and upon his ability to combine them in such a way as to give a true picture of the means to be used to attain striven-for results.

The Formula of Success

—The primary requisite for success in any enterprise, then, is adequate knowledge. That success may actually be attained, adequate knowledge must be followed by adequate action based upon this knowledge. If we were to require a formula for success in any effort we might state it thus: The best and most certain results in any line of endeavor can be attained only by one clearly comprehending all the various

factors and principles involved who, after becoming familiar with methods, and having decided upon some definite aim, carefully plans a course of action and persistently adheres to it in the face of all obstacles, making adaptations only to meet changing environment, or as the dictates of matured experience demands.

If the human heart craves immortality, as it universally does, this is an end to be attained. As such it is subject to the formula just stated. That is, it can be attained more surely if its various factors are clearly comprehended and serve as a basis for persistent endeavor.

What is it, then, that may be immortal? The soul. But what is the soul? This we must ascertain. Suppose we begin the explanation by saying that thought implies a thinker. If anything is known, there must be a knower. The individual who thinks and feels logically concludes he has an existence. Furthermore, in some manner, he feels sure of the identity of the "I" of yesterday with the "I" of today. There is something about the "I" of today which is the same as, and something which is different from, the "I" of yesterday. What it is that is the same, and what it is that is different, only analysis will reveal.

Now back of consciousness resides the energy that expresses consciousness. Back of life in manifestation is the energy that expresses life. Back of all expressions of that which ultimately becomes the mind of man is energy. We are unable to think of the universe as nonexistent. Its energies must have been present in some state throughout the entirety of the past. In other words, the universe is manifesting today a potentiality that has always been present; for energy is not derived from nothingness.

Likewise, back of all expressions of individual consciousness and form there is a potentiality. This potentiality, this energy that expresses itself through consciousness and form, finally expressing through the human form as the mind of man, was not derived from nothing. It is a potentiality as eternal as the potentiality behind the universe; for while energies express in different forms, one of the most stable natural laws is that of conservation of energy, the law that there is no more and no less energy in the universe today than there was in the infinitely distant past, or than there will be in the infinitely distant future. The "I", therefore, that does not change, the "I" that we feel existed farther back than we can remember, and that we can hardly imagine as not existing in the future, is the potentiality which activates our existence. It is usually referred to as the ego.

As to our consciousness, it cannot be said to be changeless. On the contrary it continually changes. I do not mean merely that the objective consciousness is aware of different things at different times, but that because new experiences are each day and each hour added to the total of our consciousness, that consciousness, in its entirety, is in a state of flux. Yet we identify ourselves with our states of consciousness. Insofar as we do this the "I" of today is different from the "I" of yesterday. The totality of these states of consciousness is the soul.

We have no experience of energy not associated with substance, and no experience of consciousness not associated with substance. Nor are we justified in assuming that

energy and consciousness are possible apart from some kind of substance. In fact, the human mind is incapable of thinking of a condition in which substance is absent. Of course, there are substances much finer than matter; but for energy to express, or for consciousness to be present, each must be associated with substance. When energy expresses as consciousness in association with substance, the substance is spoken of as the form, or body.

The Sole Attribute of the Ego Is Potentiality

—From the fact that we now exist, no new energy ever being created, it is logical to assume that we each have at least potentially always existed. That is, the potentiality which we call the ego never had a beginning and never can have an end. But states of consciousness are more than potentialities, they are the result of specific activities. Until the ego inaugurated these specific activities there was no consciousness, consequently no soul. The ego must always have existed, but the soul only came into existence as the result of definite activities of the ego. The soul, therefore, probably has not always existed.

When that potentiality which we now call the ego inaugurated the specific activities that resulted in the first gleam of consciousness, the activity was a movement of substance, and the consciousness itself was a special kind of motion in substance. Thus, the moment there was consciousness there was also a form. Consciousness, in fact, must be nothing, or it must be a movement in some kind of substance. Logically it cannot be nothing. And as movement in substance has form, and the soul embraces states of consciousness, the soul is ever associated with a form. Consequently, as soon as the ego has the first rudiments of a soul it also has at least the rudiments of some kind of a body.

Before it had a soul, the ego existed as a potentiality, as an eternal spark of the infinite; co-eternal with Deity. But there came a time when it initiated specific activities. Hermetic tradition holds that this was due to the love vibrations of angelic parents occupying a plane interior to the spiritual. That is, the undifferentiated potential spark of Deity was drawn to the celestial realm and there given birth by beings occupying that realm. At least it is certain that its potentialities were given a definite trend, otherwise there would have been no soul.

As soon as specific activities commenced, there also developed an awareness of these activities. The ego came in contact with its environment, which was that of the celestial realm, and began to have states of consciousness as the result of its experiences. These states of consciousness of the celestial realm developed a soul sphere, a sphere of consciousness organized in celestial substance, about the ego. But the trend of activity given the ego by its divine progenitors was of immensely greater scope than could find expression in the infinitely tenuous realms of celestial life. Its potentialities were directed to penetrating and conquering, that it might develop

deific attributes, the lower realms of existence known as the spiritual plane, the astral plane, and the material plane.

Hermetic tradition holds that due to laws governing such processes, the celestial soul sphere—the organizations of consciousness in celestial substance surrounding the ego—is unable to communicate energy to, or receive energy from, substances grosser than that of the highest spiritual realm. Because celestial substance is so much finer than the others, there are insufficient points of contact to transmit motion. A familiar illustration of this principle is the transmission of energy by radio. This energy has not sufficient points of contact with most physical objects to affect them. To cause motion in physical substance requires special conditions. And the ego, so Hermetic tradition holds, is able to impart its energies and directing power to substance coarser than the finest spiritual substance, only under conditions of a certain kind.

These conditions, under which the ego, operating from the seventh state of the spiritual world, is able to contact lower spiritual substance and thus transmit energy to still coarser astral substance and physical substance, are believed to be the polarization of its energies into two separate channels of flow; related to each other as positive and negative, masculine and feminine. The states of consciousness evolved by the ego, then, in the spiritual world, the astral world, and the physical world, represent two separate organizations. Each of these organizations of consciousness is a soul.

We are familiar with somewhat similar organizations in the study of the structure of the atom. Each atom of matter, according to the chemistry of today, is a positive nucleus of energy about which revolves one or more negative charges of energy, or electrons. Each different element has a definite number of electrons revolving around the positive nucleus. In the case of man, according to the Hermetic conception, the constant factors are a single ego, about which revolve two human souls.

The potentialities of the ego, therefore, are directed, due to the trend given it by its angelic parents, to developing these two, male and female, souls.

This development is accomplished through experience. In fact, the only possible way of developing consciousness is through experience. All knowledge, as was illustrated in detail in Chapter 1, Course 1, *Laws of Occultism*, necessarily rests upon experience. This will the more readily be understood when it is realized that consciousness is a perception of relations, and that apart from an awareness of relations there can be no consciousness. But in order for there to be such awareness, relative conditions must be contacted. These conditions are present only in association with substances. That is, it is possible to evolve consciousness only through contact with substances that in some manner display differences; for only through the awareness which perceives likeness and unlikeness is there consciousness.

To Become Conscious the Ego Must Contact Relative Existence

—It will now be perceived that if the ego is to emerge from its state of unconsciousness, in which it has neither wisdom nor feeling, its sole attribute being potentiality, it must contact the plane of relative existence; it must contact the region of substances; it must contact conditions that provide it a basis for comparison. Let us get this clear: Either the ego remains in a state of absolute ignorance and absolute insensibility—a state that is better than complete annihilation only because it contains the potentiality of becoming the other alternative—or it must gain experience through contact with relative conditions. If the ego is to possess the qualities that make for an existence that can be considered worth while, it must have experience with various grades, or conditions, of substances.

What, then, is necessary to contact substance, and what is necessary to utilize the perceptions gained by such contact? To contact substance, there must be an attractive power. To utilize impressions gained from substance there must be developed a mechanism of consciousness. The soul, then, develops a dual function: It acquires the power to attract substance, and it evolves the quality of retaining, in specially organized substances, the consciousness of its experiences with other substances.

In order that these experiences should be varied enough to constitute worth-while knowledge, to constitute a consciousness of some scope, it is obligatory that the ego, through the soul, should contact numerous conditions and states of substance. These are to be found in form. Thus it is that the various forms of life with which we are familiar are all being used as vehicles, by which souls gain experience and so widen their knowledge.

The scope of experience that may be had in association with any single form is limited. Therefore, the soul developed the power of attracting one form and using it as a vehicle of experience for a time, and then attracting another form. Yet before the second form can be utilized as a vehicle, the first form must be left, or repelled. But the universe is not filled with ready-made forms. Consequently, in order that it may have just the form to meet its temporary requirements, the soul developed the power to mold forms.

To state this conception in a somewhat more concrete way, let us think of the ego as the source of energy. The ego has no wisdom, no consciousness, until it has experience; for consciousness is the result of experience. When it does commence to have experiences, these experiences are recorded as states of consciousness; and the sum total of all these states of consciousness comprise the two souls of one ego. That is, according to the Hermetic tradition, each ego, in so far as substance coarser than the finest spiritual substance is concerned, has two different organizations of consciousness, two souls.

But the function of a soul is not merely to record states of consciousness. A state of consciousness is not nothingness, therefore, it must be something. And it can only be an organization of energy in some kind of substance. It may be an organization of energy in astral substance, or if fine enough, in spiritual substance, or if of still greater sublimation, even in substance interior to the spiritual. But it is always an organization of energy, and as such has the power to perform work. That is a function of all energy; to perform work. And the energy of consciousness has the power to attract substance and mold itself a form, or body, that corresponds to that consciousness.

It uses this form to gain still further experiences, and these experiences are recorded and become a portion of the soul. Because it now has a more complex organization than before, it is able, after repelling a form, to attract another that is of greater complexity. Experiences in successive forms enlarging its states of consciousness, which are additional organizations of energy, enable it later to attract a body of still higher organization.

The Soul Has a Dual Function

—Thus it is that the soul has a dual function: that of attracting, molding, and repelling the various forms that give it experience; and that of recording these experiences. Consciousness, which records these experiences, implies an adjustment of internal relations to external relations, and this process of continuous adjustment we call conscious life.

But even as there can be no consciousness, knowledge, or wisdom, except that based upon experience with forms; so there can be no love, no attraction, other than through association with form. The former are perceptions of relations; but these relations which are perceived are simply the feelings of various degrees of attraction and repulsion. Without the perception of relations there are no attractions and repulsions. Yet these, when they become sufficiently complex, we term love. As love is dependent upon perceptions of relations, and these are dependent upon experience, it will be seen that apart from experience with relative conditions there can be no love, and no knowledge of love.

There can be no consciousness of attraction, no love, except that developed through experience with forms that have various qualities. Not only then, does the soul exercise the power of attracting and repelling forms, but its ability to attract and repel forms depends upon its experiences in so doing; for each experience adds to the consciousness. It should be plain, therefore, that without the experiences of external life, without the experience of functioning through various forms in some sort of substance, there would be no soul, and there could be neither feeling nor knowledge, neither Love nor Wisdom.

Life, likewise, implies change. We cannot think of life apart from alterations of the internal structure. Yet movement is impossible apart from substance. Consequently,

the ego could have no life, other than being merely a potentiality, except through association with form. Without the experience of functioning through various forms in some sort of substance there could be no love, no wisdom, and no Life.

Why We Are Here

—To the question so often asked as to why we are here, why man must pass through experiences, some of which seem heart-rending, the answer is plain: Without some such experience there could be no Life, there could be no Love, and there could be no Wisdom.

We cannot perceive the light, except we have had experience with varying degrees of its intensity; and if we have had some experience with darkness, we the more readily appreciate the light. We can have no knowledge of the good, unless we have had some experience with that which is less good; and if we have had some experience with that which we call evil, the good is the more appreciated. Sweetness, to the sense of taste, is only perceived by comparison with things less sweet. It takes the sour, such as lemon, to bring out in proper contrast the sweetness of honey. In fact, the wider the range of experience the clearer the perception of qualities and values. Without some such experiences with form as we are familiar with there would be no life, no consciousness, no knowledge, no love. It is impossible to imagine how life, wisdom, and love could be developed, or could exist, without some such chain of experiences as those with which we are familiar.

As to the why of existence itself, that is, the why of the potentiality manifesting through the universe of form, we are not called upon to explain it. We cannot conceive of a condition in which existence is lacking, nor have we had any experience that suggests such a condition ever was possible. It is quite enough, then, for the human mind to attempt to explain how existence acts and is conditioned, without attempting to commence from nothingness, which is logically impossible, and show how all that exists was derived from this unthinkable, impossible, abstraction. But if we commence with a potentiality, such as the ego undoubtedly is, it is not difficult to trace the steps by which the soul must have gradually developed until it finally functions through the body of man.

As I have already shown in some detail, the attractive power that for convenience I call Love and the consciousness that for convenience I call Wisdom, are developed only through experience with form. I mean here that all activity and life are due to the principle of attraction which to generalize I refer to as Love, and that consciousness results from the activities so engendered. Such consciousness, in all its forms, I generalize under the term Wisdom. Furthermore, the feeling of attraction and the consciousness are intensified in proportion to the contrasts in experience. For instance, if we have just tasted something sweet, we are the more conscious of, and the more repelled by, the taste of something bitter. In fact, the wider the contrast is between experiences, the stronger they tend to impress themselves upon

consciousness and the stronger they attract or repel. And the more varied the experience, the more shades of consciousness, the more discrimination possible; and the more shades of feeling, the wider the sensations and emotions.

Therefore, if the soul is to develop power; which depends upon its strength to attract and repel, upon Love; and if it is to develop knowledge, and not remain semi-conscious, it must have experiences of as wide contrast and of as great variety as possible. Contrast means strong impressions and strong desires. Variety means discrimination and fine shades of feeling. A creature without these is not alive in the full sense that man is alive.

The greatest contrast of which we know is that between spirit, or still finer substance, and matter. And the greatest variety of which we know is the countless forms on the physical, the astral, and the spiritual planes.

If, therefore, the soul is to develop its powers, there is no means that we can imagine which would be so effective as its association with the various forms of the physical, the astral, and the spiritual worlds; for these forms offer the widest possible contrast of which it is possible to conceive. They, therefore, offer the greatest opportunity to develop the attributes of attraction and repulsion; the greatest opportunity to develop feeling, to develop that which becomes Love.

And if the soul is to develop discrimination, there is no means that we can imagine which would be so effective as its association with the various forms of the physical, the astral, and the spiritual worlds; for these forms offer the widest possible variety of which it is possible to conceive. They, therefore, offer the greatest opportunity to develop the attributes of perception and comparison; the greatest opportunity to develop knowledge; to develop that which becomes Wisdom.

That the soul may acquire Self-Consciousness it must attain Wisdom. Life, however, depends also upon love; for love is the power that attracts and holds together whatever form the soul occupies. If the soul is to be immortal it must develop sufficient love, sufficient attractive power, to build such forms as are necessary for its imperishable existence. Love and Wisdom are the essential factors of Immortal Life.

Because there is no conceivable way by which the soul can acquire love and wisdom except through varied experiences in form, the cycle through which the soul passes, from spirit to matter and from matter back to spirit; living in countless forms in each of the three realms; is called by initiates, "The Cycle of Necessity." That is, this cycle of experiences in various forms is a necessity if the soul is to acquire the love and wisdom which alone make possible Self-Conscious Immortality. The mission of the soul, therefore, is to acquire Love and Wisdom to the end that Self-Conscious Immortality may be attained.

The Cycle of Necessity

—Now let us trace the soul in its Cycle of Necessity. It is first differentiated in the

highest state of the spiritual realm. It then possesses neither consciousness nor feeling; but is supplied by the ego with energy, and by the ego is given a specific trend. This specific trend is determined by the love vibrations of its angelic parents that brought about the ego's differentiation. That is, such ego with its two souls is a part of universal society, differing from all other egos. In universal society, as in all meritorious organizations, there is division of labor. Nature moves toward specialization, each specialized part performing a definite function. Therefore, the soul impelled on its cyclic journey is given that trend which offers it the opportunity to develop such attributes as it requires if it is ultimately to fill its proper sphere as a useful member in the cosmos.

It therefore attracts about itself, as the result of the energy supplied it by the ego, a form of spiritual substance of the highest state. Its experiences in this form give it some slight consciousness; being energy, when it repels the present form gives it additional power to attract another form of slightly greater complexity. Its experiences in the second form give it the consciousness, and the attractive ability, later to attract a third spiritual form of higher complexity still.

Its attractive power and its subjective consciousness increasing, it gradually gains the ability to attract forms of grosser spiritual substance; and after much experience living subjective lives in the lowest grade of spiritual substance, it finally gains the power to draw about itself an astral form. This process continues in the astral realm. These forms inhabited on the astral plane are termed elementals. As soon as the experiences in one astral form have been assimilated, this form is repelled and the organizations of energy thus gained enabled it to attract a still more complex, and a still more dense form, until finally a time is reached when the soul has enough energy, or love power at its command, as the result of its experiences in spiritual and astral forms, to enable it to attract about itself a physical form. This is the first objective experience; it becomes incarnated in a mineral.

The mineral form of life is the lowest rung on this Jacob's Ladder by which the soul descends from, and ascends to, heaven. Carried on the mineral life wave it enters the zone of the planet where its first expression of external life is to be experienced. By its power of love, which is the outcome of its experiences upon the descending arc of its cycle, it attracts to itself the attributes which constitute a crystal of matter. This initial crystal is the simplest form of mineral. The attributes expressed by it are due to the polarizing power of the soul.

After undergoing its cycle of life in the form of the lowest mineral, the soul begins to lose affinity with it, and finally, as the result of repulsion, passes into the astral realms. The mineral is dead. After a period of astral life, however, the soul, by the power of its accumulated love, attracts a new form and undergoes incarnation; this time in a mineral a step higher in the scale of evolution. Having reaped and recorded the experiences of one form, the soul is impelled, by the restless ego in search of wisdom, to exert its power to attract and mold a higher and more complex form. Thus it evolves, step by step, in its first evolutionary state, through the various kinds of mineral life.

From the highest mineral form, the monad is carried into the astral zones corresponding in astrological quality to the next planet of the septenary chain, there to undergo a period of subjective life. This is the second evolutionary state. Finally it is carried forward by the life wave and becomes incarnated, as its third evolutionary state corresponding to the next planet, in the vegetable kingdom. Here the action of love and wisdom evolves it still more rapidly by means of successive births and deaths. The lowly lichen forms but a step, and as it dies the soul, by its inherent power of love, attracts to itself a higher form of plant life, evolving rung upon rung on the ladder of evolution, ever attracting, evolving, and perfecting forms for more perfect and complex expression; and finally repelling them for those still higher in the gamut, until at last it blooms as the blushing rose.

From the highest type of plant life the evolutionary life wave of the solar system carries the impersonal monad to its fourth evolutionary state, astrologically corresponding to the next planet of the septenary, to undergo another cycle of assimilation in the astral spheres. Thence, after a period of subjective gestation, it passes to the fifth evolutionary state, corresponding astrologically to the next planet, to enter what has now become the animal life wave. Through attraction, or love, the soul becomes incarnated in the lowest form of animal life. Through love, which is the expression of accumulated wisdom, it molds the form it temporarily occupies. Then, after its cycle of experience in this form, the animal dies, and the soul, having more complex needs, or desires, attracts to itself a still more complex form, evolving, through the power of love, or desire, this form to meet as nearly as possible the requirements of its environment.

Having exhausted the realms of animal life, and ever impelled by the restless energy of its ego to seek new and more complex experiences, it passes from the region of its animal experiences to undergo another period of subjective assimilation in the astral spheres, the sixth evolutionary state, corresponding astrologically to the next planet in the septenary; thence onward to the seventh evolutionary state, in which it reaches the climax of incarnated perfection.

In the scheme of universal law the seventh state is always that of action and completion insofar as expression is concerned. The seventh condition is always a synthesis of the six preceding, and constitutes the point of transition to a new octave of existence. So, in the seventh evolutionary state from its commencement, the soul undergoing the Cycle of Necessity attains the estate of manhood, where it recapitulates in a single life all the various states through which it has passed, and attracts to itself the perfect form which has an exact correspondence to every plane, state, and center of life in the universe.

At this point in its journey, for the first time, and as the result of the accumulated impersonal wisdom gathered through the power of love, or attraction, it becomes self-conscious. It is no longer an impersonal being impelled forward by inner and to it unaccountable yearnings. It is now a self-conscious entity endowed with all the responsibility of a morally free agent; a responsibility varying in individual cases, being proportional to the ability and the opportunity.

The Structure of the Soul

—At every step of the wearisome journey there has been the dual action of the soul. It has ever recorded for the ego the perceptions which constitute its store of wisdom, and these states of awareness for the sake of convenience we can classify as thoughts. Thus also all experiences which the soul has had may be classified according to the kind of thought-elements they contain. And even as the protoplasm of physical life exists as cells, so does the psychoplasm composed of thought-elements exist within the finer forms as thought-cells and thought structures they have built. And these exercise the power of love to attract, evolve, and finally to repulse forms.

The form which the soul occupies at any given moment of its journey is determined by the strength and direction of its love. The strength and direction of its love at any given time is dependent upon its accumulated experience, which I here term wisdom. Thus the soul has been gaining in both Love and Wisdom at every step of its cyclic journey, and these two are the Isis and Osiris of all life.

An acorn falls to the ground, germinates, and becomes the giant oak. No materialist can say, in spite of chromosomes and chromospheres, just what and where is the power that molds the oak into its unyielding form. Remove any single root or branch and the oak still lives. Cut it down in its prime and a new growth springs up. We cannot say the oak is another tree if it loses a branch, nor can we point out the exact locality in space where the real oak lives; yet we tacitly admit that there is a real oak that molds the physical to its present form and structure, a something that shapes it thus rather than to the form of a pine.

In time the tree dies, its physical form disintegrates, and the particles which have formed its body pass into other forms. What, think you, has become of the force that molded these particles to its specific structure? Do you think it is lost? No so! It has passed onward again to mold a form, this time a higher form that will meet its more advanced need of expression. It never again becomes the oak, for evolution is the law of objective existence. It is never, therefore, attracted to the same form, but always to one still more perfect, one more advanced, even though slightly, in the scale of being.

The scale of being is complete in the divine form of man. In man form reaches its highest state of perfection insofar as mundane life is concerned. The gamut of being embraced within the human form is a miniature representation of the entire universe. Reaching down from the realms of undifferentiated unconscious spirit to the dense mineral there is a perfect gradation of substance, and a perfect scale of life forms.

From mineral back to God extends Jacob's Cyclic Ladder, each rung upward a more perfect form, a more complex expression of Love and Wisdom. Each ascending step in this progressive movement is a more perfect form. Through form alone can the soul gather from the tree of the knowledge of good and evil, and only after partaking of this fruit, which embraces its experiences, is it also able to partake of the tree of

life; of undying love. In this cycle of experience it passes through all the lower forms of life, but its orbit being spiral, ever ascending, it is never required to enter the same form of life a second time, never compelled to taste of the same fruit twice, never forced back into a form through which it has once passed.

Man is not, by any means, the acme of perfection, nor the climax of evolution; but contains within his form all the states through which he has already passed, and in addition, those in embryo through which his future evolution in super-mundane spheres will enable him to progress. Man is simply the point of transition from mundane to super-mundane realms of life. From mineral up to man there are seven evolutionary states of life, and from man up to the angel there are seven more. Man, therefore, stands midway between the mineral and the angel. He is ushered into physical life in the human form because he has earned the right to that form by virtue of the soul's evolutionary journey through the lower realms of impersonal being. He possesses the potencies both of mortality and of immortality; he has the possibility of becoming either God or Devil.

In man the acquired experience of attraction and repulsion, the various manifestations of the love principle as tabulated by his soul, blossom forth as Self-Consciousness. This self-consciousness is a much wider perception than is possible in any of the lower forms of existence, but it is by no means the highest state of consciousness possible even to embodied humanity. Exceptional individuals spontaneously, and others through training, have the power to place themselves so in rapport with the universe as a whole that they discern the oneness of all life and the relation of the various life-forms to the whole. This wider mental state is called Cosmic Consciousness.

And there is still a higher consciousness, called Divine Consciousness, that can be attained while the soul occupies the physical body, in which it attains rapport with the soul sphere of the ego. This soul sphere of the ego retains the records of the ego's experiences in higher than spiritual worlds. The soul by this means has access not only to the perceptions of the astral brain, but is able to utilize the almost unlimited consciousness of a well developed spiritual brain, and even tap, through its conscious rapport with the ego, information relative to still higher spheres.

The Cause of the Fall

—It will now be apparent, in spite of such an interpretation by religious hierophants who wished to place and keep woman in servility, that woman was not the cause of the fall. That man fell from a state of Edenic purity into grosser conditions through yielding to temptation is a tradition held by widely disseminated peoples. Eve yielded, and partook of the Apple of the Tree of Good and Evil, because she was promised it would bestow wisdom. This apple is the fruit of incarnated experience. The soul, therefore, descended from its spiritual state to enter physical form, where it must gain its daily bread by the sweat of its brow, because it was tempted by the

desire for wisdom, which could only be attained by experiences in form.

And the Lord God said, Behold, the man is become as one of us, to know good and evil; and now, lest he put forth his hand, and take also of the tree of life, and eat, and live forever.

What is the tree of life? Immortality is life without end. Life and consciousness are only possible in association with form. Therefore, immortal life depends upon the ability of the soul to attract to itself such forms as will enable it successfully to adapt itself to its environment; for life only expresses through form so long as there is successful adaptation to the environment. Continuous adaptation to environment is continuous life. And while the life of the physical body may undoubtedly be greatly prolonged, the earth in time will reach a state when it will no longer support physical life. Man can hope for lengthy life, but not for immortality, in the flesh. He must, therefore, if self-conscious immortality is to be attained, develop the power to attract about his soul a form of the substance of the plane whither the tides of the evolutionary life wave carry him.

Nor will he tarry indefinitely in the astral; for the astral, like the physical, is subject to changes that in time will make it unfit as his abode. Ultimately, he will be swept along by forces that are as certain as is physical death, to realms above the astral, to the spiritual realm; yes, later, to regions even above this.

But if he is to survive on the spiritual plane; that is, if he is to retain consciousness, he must have the power to build himself a form of spiritual substance. Such a form can retain, as modes of motion, all the past experiences of the soul, if points of contact are provided by which the slower velocities of astral substances can transform their energy into spiritual velocities. To carry the consciousness into spiritual realms, vibratory rates must be set up of sufficient frequency that they will organize spiritual substance into a form which will receive from the astral body, and retain, the states of consciousness recorded there.

The rates of motion of common worldly thoughts, those of base desires, and those of selfish interest, have too low a frequency to influence spiritual substance. The person who has no higher thoughts and aspirations than these does not build a spiritual body. If he ever gets a spiritual body, which he probably will, he will have to organize it by noble aspirations, unselfish endeavor, and devoted love on the astral plane, after physical death.

Individual survival depends upon the ability of the entity to adapt itself to ever-changing environment. There is no such thing as rest in nature; there is an eternal procession of creation and destruction of form. Continuous consciousness, therefore, depends upon the ability continuously to adjust the internal relations to the external relations. Conscious life consists of this adjustment, and if it is to be without end, there is Immortality.

To accomplish such a progressive adaptation the soul is concerned with but two factors: Love and Wisdom. These are the tools with which it works. They are equally

important and essential, and the successful performance of its task depends upon their continuous application to an increasing range of material. And in this application, quality is important as well as quantity.

The Method of Redemption

—The plan of action by which Self-Conscious Immortality is to be attained is this: Man must develop, to the highest possible extent, the attributes of Love and Wisdom.

Knowledge of physical phenomena is essential on the physical plane, but life on the higher planes requires man to gather, through study, meditation, and the exercise of the psychic senses and the higher states of consciousness, as much information as possible about higher realms and about living the life of the spirit. Furthermore, in the exercise of the wisdom which contributes to immortality, the attitude toward the various events of life, the freeing them of the dross of experience, and combining them mentally so they will flux to give an intensity of vibration sufficient to affect the higher velocity of spiritual substance, is important. This subject is given detailed discussion in Course 3, *Spiritual Alchemy*.

Love, also, like wisdom, is of various grades, and man must strive for quality. He must not permit his love nature to atrophy; for upon love, fully as much as upon wisdom, depends immortality. Nor in the exercise of love should he make the mistake of trying that which psychology proves to be impossible, trying to love all without first loving one or more of the individuals embraced within the all. The love of husband and wife, of parent and child, are sacred, and are the most certain steps by which is developed the love of God, the love of mankind, and the love of all creatures.

This discussion has now shown, I trust, that the soul embraces all the various states of consciousness organized in astral substance and in spiritual substance by the monad in its descent from spirit to matter and in its evolution from mineral upward. This organization of energy which constitutes the soul results from its experiences with form.

To attain immortality the soul must have the love and wisdom to construct for itself forms in which to function on higher planes of existence than the physical and the astral. To do this it must continue to exercise and develop Love and Wisdom to a degree that it can influence the substances of such higher planes. To gain as much information about all other entities in the universe and one's proper relation to them is the exercise of the greatest Wisdom. To work persistently to be of greatest possible service in this universal society is the expression of the highest love. A life devoted to the exercise of such Wisdom and such Love builds for itself an imperishable form on the spiritual plane that provides, here and now, for Self-Conscious Immortality.

Chapter 5

Serial No. 3
Original Copyright 1927
Elbert Benjamine

Copyright
Church of Light
August 2002

Physiology and Correspondence

Chapter 5

Physiology and Correspondence

AS there is a strict correspondence between the inner and the outer, between functions exercising on one plane and functions exercising on other planes, the physiology of man may be used as an index to occult processes, and to the nature of functions exercised by man on other than physical planes. By the application of this law of correspondence we shall acquire a clearer conception, I believe, of certain principles that are of vital importance to the welfare of man.

If we are to know anything about that which remains occult we must study correspondences. That which cannot be perceived, which has no recognizable form, can only be recognized by its formative action. The form presented by any object or entity necessarily represents the sum total of the various energies that converge in it; that is, the form is the expression of the internal attributes, and there must be a strict correspondence between the internal attributes and the form. Thus, if we find certain qualities expressed in the form, we are warranted in concluding they are the manifestation of similar internal attributes, or they exist without an adequate internal cause. If the latter be possible, the nature of the real is forever a closed book, and there can be no science of occultism. As the occult can only be recognized through its influence upon form, the correspondence of the form to the energies it expresses is the only measure we possess for gauging occult forces.

The occult is that which is hidden, and it can only be apprehended by comparing it with that which is revealed. A form is always the expression of a formative principle. The outward is ever the manifestation of the inward. The visible results from the action of the invisible. The science of occultism, consequently, is based upon the fact that there is a strict correspondence between the inner and the outer, the below and the above, the effect and the cause; in other words, that the visible and known constitutes the proportional measure of the invisible and unknown.

When, therefore, we are brought in contact with such loose thinking as the assertion that a certain individual is really a man incarnated in a woman's body and that another individual is a woman incarnated in a man's body, we should cite the law of correspondences. Inasmuch as the body and the actions are masculine, they must be the expression of masculine forces. In as much as the body and actions are feminine, they are the expression of a feminine nature. If female forces can express as a

masculine form, or if masculine forces can express as a feminine form, we are warranted in asserting also that heat can express as cold, and that light can express as darkness. Logical thinking requires that there shall be an adequate and proportional cause for every observed effect.

The Soul Always Functions Through a Form

—Now on the physical plane man has a body through which he functions. Likewise, on whatever plane of existence man may express in the future he must possess a body. The absence of form is nothingness. And as nothingness lacks expression, every existing thing must have a form. The soul of man, therefore, if it persists, must manifest through a form or body. But the body through which it manifests need not be material; it may be composed of substance of any plane or existence. It is composed of the substance of the plane on which the soul at the time manifests.

Man while still occupying a physical body is not confined in his expression exclusively to the physical plane. He manifests strongly in the electromagnetic Boundary-Line region, the astral plane is the scene of most of his unconscious activity, and in the expression of his nobler sentiments and higher ideals he also manifests upon the spiritual plane. Under normal circumstances man possesses not only a physical body, an electromagnetic body, and an astral body, but also at least the rudiments of a spiritual form.

These various bodies are replicas of each other insofar as the planes to which they belong permit. The physical body belongs to a plane of existence where velocities are so low that things have the properties which we call material. The electromagnetic body belongs to a velocity of existence where material properties give way to the peculiar ones found in light and other electromagnetic phenomena. At this velocity, for instance, time stands still. The astral body belongs to a realm of still higher velocities in which space, time and gravitation as we know them no longer obtain, but give way to still other properties; these are explained in considerable detail in Course 4, *Ancient Masonry* and Course 9, *Mental Alchemy*. The spiritual body, furthermore, is a body on a plane where still higher velocities, and still more unbelievable properties obtain.

Yet aside from such differences as relate to the inherent qualities of the planes on which they manifest, every organ and function in the physical body is also present in the electromagnetic body, the astral body, and the spiritual body. The conditions of the spiritual plane, however, do not permit the various organs to be present in their grosser form. We should not think of the spiritual body as possessing a heart, a stomach and kidneys modeled in their shape after these organs of the physical body. But the spiritual body does have organs that perform on the spiritual plane corresponding functions. Due allowance being made for the difference in plane, there is a strict correspondence between the organs and functions of the physical

body and the organs and functions of the spiritual body. Let us consider, however, those which exist between the physical body and the astral form.

The physical body is composed of protoplasm and its secretions. And in a similar manner, the astral body is composed of psychoplasm, this being the term used to designate inner-plane substance organized by thought and feeling into a definite composition suitable for inclusion in the astral form. Psychoplasm is organized of thought elements even as protoplasm is organized from the elements of matter.

The protoplasm of the physical body is organized further into definite cells, and these cells of various kinds go to build up the organs and structures of the material form. Certain types of cells build up the nervous system, other types of cells form the muscular system, still others contribute themselves to the osseous system. Some cells unite to do the work of the heart, some to perform the work of the stomach, and still others form the protective covering called the skin. And in a corresponding manner the ten families of thought-elements which each are ruled by one of the planets unite in various combinations to produce the different types of thought-cells within the astral body, and these are organized not merely to perform functions relative to each of the twelve departments of life, but in those associations with each other which enable them to do the work indicated by the aspects of the individual's astrological chart.

The oldest of all desires is the desire to survive and be something. This most powerful desire, that for significance, as explained in Chapter 5, Course 5, *Esoteric Psychology*, expresses as a positive and a negative, as the reproductive desire and the nutritive desire. Fundamental desires of all living things—plants, animals and men—are food hunger and sex hunger. These hungers being of such great importance upon the physical plane, we may well inquire as to their existence upon the inner planes of life. The functions of physical life by which these two basic yearnings are satisfied must, by the law of correspondence, represent all-important functions in the life of spiritual man.

Food Hunger

—We are aware that the body is unable to survive unless it is supplied with food. Action of any kind consumes energy, and this energy must be replenished if action is to continue. Food in its various forms constitutes the energy supply that permits the continuation of activity. This activity may be that of internal changes, or that of movements of the body or of its organs; but wherever life expresses there is movement of some kind that consumes energy. All forms of life, therefore, must have food. Bacteria have various sources of food. The chief food supply of plants is the carbon of the atmosphere. The food supply of animals consists of plants, or other animals, of water, and of the oxygen of the air. Nothing upon the earth lives without food; nor have we any reason to suppose that on the spiritual plane, or even on higher planes, life without food is possible.

Of course, the nature of the food changes with the plane of activity, just as the nature of the food for various forms of life is different. To sustain the electromagnetic form and afford energy for objective thought, as explained in detail in Chapter 9, Course 5, *Esoteric Psychology*, man acquires in his food protein molecules which contain the high-frequency energy of the lightning which fixed the nitrogen which plant life took from the soil. And to feed the upper-octave electromagnetic Boundary-Line energies required for direction and proper control of inner-plane activities, the electrical energies of the nervous system must be released in unusual volume and high-frequency, as explained in full detail in 5th Award NOT SOLD Manuscript, *Breathing to Acquire Adequate Electrification*.

In order that it may survive and continue active, not only the electromagnetic body but also the astral form must be supplied with energy. This is the law on all planes; that whatever energy is used must have a source of supply. And while planetary radiations afford a certain amount of the energy used by the thought-cells and thought structures of the astral body, and during physical life the astral counterpart of the food partaken of and assimilated affords some, the thoughts of the individual provide by far the most important supply. Or to express it still another way, the most valuable food supply of the astral body, not merely of man but of all other life forms, is that derived from experience.

Every experience contributes energy to the astral form. States of consciousness cause the astral body to extract nourishment from the astral region surrounding it, much as sunlight causes a green leaf to extract nourishment from the atmosphere. The light of the sun is responsible for plant nourishment, and the light of consciousness is responsible for the nourishment of the astral body. Whenever there is a ray of consciousness, whenever there is a mood, a feeling, a thought, or an aspiration, the astral body receives nourishment.

This food of the astral body may be wholesome, or it may be the reverse. If the factors composing it are associated with the feeling of pleasure they form constructive compounds in the astral body. These in turn work to attract fortunate events into the life. If the factors partaken of are associated with the feeling of displeasure or pain, they form destructive compounds. In this case they work from the inner plane to attract unfortunate events into the life. Course 9, *Mental Alchemy*, is largely devoted to explaining about such astral foods, and how to select those which when assimilated will enable the individual to have the kind of life and destiny he desires.

The spiritual body, the body that the soul after it leaves the astral plane must function in if it is to survive, also must have its food. The laws of nature are not transcended on the spiritual plane. Movement and accomplishment on the spiritual plane consume energy, and this energy must be derived from some previously existing source. If man is to have a spiritual body in which to function on the spiritual plane, he must supply it with the food necessary to its growth; and if the spiritual body, once grown, is to continue active, more food must be supplied to it. Life on any plane of existence implies the capture, storage and expenditure of energy. The source of this energy is called food. To grow to maturity and perform its functions the spiritual body must be

supplied with spiritual food.

The food of the spiritual body is provided by certain grades of thought that combine to produce high vibratory rates, and by certain moods and emotional states that in themselves are of exceptionally high-frequency vibratory rates. Course 3, *Spiritual Alchemy*, is devoted to explaining how to develop thought-food of the quality necessary to build a vigorous spiritual form, but it will not be out of place here to indicate the general principle involved.

The spiritual body is the substance of a different plane than the astral; or to state it differently, its velocities belong to a different phase of existence. To illustrate: A bar of iron normally has those velocities which we associate with physical substance. But suppose we heat it. The molecules increase their vibrations and communicate their energy to surrounding molecules, so that whatever touches the bar also becomes hot. This heat energy of the bar, while it may be used as a source of power to perform work on the physical plane, does not affect appreciably energies which have a velocity which gives them other than physical properties.

But if the bar is heated to high enough temperature, if its molecular and therefore physical vibrations become of sufficient frequency, they impart energy to the Boundary-Line region. The bar becomes red hot and electromagnetic energies called radiant heat and light come into existence which have a velocity greater than things of the physical world, and possess properties which physical things do not. At the velocity of these electromagnetic energies particles gain tremendously in mass, shrink amazingly in length in the direction of their travel, and time stands still.

Even as the cold bar fails thus to affect electromagnetic Boundary-Line energies, so the ordinary energies of the astral body and of animal-like thinking fail to generate velocities sufficiently high to affect the spiritual body, or to afford it nourishment. It is only thoughts in special combinations, and especially those with vibratory rates entirely above self-interest, that furnish the energy which enables the spiritual body to indraw spiritual substance. This energy derived from the motive, *Contribute Your Utmost to Universal Welfare*, builds a complex and highly organized spiritual form.

Sex Hunger

—Now let us turn from food hunger to sex hunger as the other pole of the one irrepressible biological urge for significance: As man's stronger emotions are more commonly associated with the expression of his love life, it is obvious that this love life, in its various manifestations, constitutes one of the most important supplies of food for the astral body. The astral food thus derived may be intensely harmonious and act powerfully in the construction of beneficial compounds, or it may be disastrously discordant and thus act powerfully in the construction of misfortune-attracting compounds. Furthermore, as the quality of love's expression varies from gross bestiality up to ineffable sublimity, the quality of the astral food derived from expression of the love nature may be anything from fetid corruption to

spiritual ambrosia. It is thus possible to elevate love to a plane of expression that is entirely above the physical; the expression being spiritual, and consequently furnishing strength and nutriment directly to the spiritual body. But as this phase of the love life is discussed in detail in Course 4, *Ancient Masonry*, we will here take up another phase, which considers union, not from the standpoint of the emotional energies, but from the standpoint of energy exchange.

Sexual union throughout nature's various life forms is not merely for the purpose of reproduction. In fact, reproduction seems to be a secondary object. Reproduction takes place in innumerable life-forms without sexual union. The aphids, insects which are so great a nuisance to plant growers, reproduce independent of sexual union. There are plants that reproduce without union of male and female parts, in addition to those that reproduce by means of runners, those that stool out, and those that grow from shoots, cuttings, and tubers. The object of sexual union is not to make reproduction possible, but through an exchange of qualities to give the offspring, if offspring is the result, attributes not possessed by one of the parents independent of the other.

Some of the protozoa, low forms of animal life, reproduce themselves repeatedly without union with another protozoan. But unless they unite with another protozoan after a certain length of time they die. If they do find and mate with another, they continue to reproduce by subdivision, and do not die. Union is not necessary for reproduction, but it is necessary for continued life.

In the sexual union of these low forms of animal life there is a complete fusion of protoplasm and chromosomes. When they separate it is believed that each has exchanged some of its substance for some of the substance of the other. Both are different in composition than before, and both have new vitality. When they subdivide in the production of offspring, the offspring may partake, not merely of the qualities of one, but of the qualities of both.

In all reproductive cells, either of plants or animals, there are minute filaments, called chromosomes. The number of chromosomes in the reproductive cell is constant for each species of animal. These chromosomes, with genes strung along them like beads, are the physical carriers of hereditary traits. Half the chromosomes of the fertilized cell are furnished by the male, and half by the female. The plant or animal, then, that grows from a fertilized seed, may contain the potentialities of the ancestors on both sides of the family. Only a portion of these potentialities express, however, in any individual. The laws governing this are set forth in Chapter 4, Course 17, *Cosmic Alchemy*. Here it is sufficient to say in this connection that because the offspring contains genes from both parents it may differ widely from either parent through the combination of these hereditary factors. This gives rise to variation and makes evolution possible.

The union of male and female entities is for the purpose of exchanging qualities. But we need not confine our observations entirely to the physical plane. Instead of directing our attention to plants and lower animals, let us consider human relations,

not merely physical relations, but all those relations involving electromagnetic exchange.

When we clasp the hand of another in token of welcome or friendship there usually passes from the body of each to the other electrical energy. Each has partaken of energy that previously belonged to the other. In such casual relations no great quantities of energy are exchanged. But in the more intimate relations of life there may be such a complete exchange of electromagnetic energy through the blending of the electromagnetic bodies that each noticeably partakes of the characteristics of the other. It is a common observation that people who live long together grow to look alike and act alike. The exchange of energies is so complete that each loses part of his individuality in the other.

Such exchanges of electrical energies either in marriage or in less intimate association may be very beneficial, or it may be very harmful, depending upon the natural harmony between the individuals, and upon the quality of energy exchanged. But for a proper balance of the electromagnetic forces some contact with the opposite sex seems essential. Men who go to far regions where they see no women for a long time, and both men and women who are confined where they do not meet the opposite sex, exhibit a strange irritability. But there may be an unconscious exchange of electromagnetic energies, and marked benefit therefrom, without close physical contact. Merely to be in the same room with others, or to engage in conversation with them, offers opportunities for sufficient exchange to overcome magnetic tensions and to re-establish nervous balance.

Whenever people meet there is likewise an exchange of astral energies. Thoughts originating in different minds may fuse and blend to form an entirely new idea. Among people closely associated, particularly in the marriage relation, there is also a very complete exchange of astral energies, each influencing the thoughts and feelings of the other. Unconsciously, by their thoughts, people continually give mental treatments to their acquaintances. If they think and express kind thoughts concerning an acquaintance, these energies tend to enter the astral body of the acquaintance as constructive elements. If the thoughts are critical and abusive they tend to enter the astral body as destructive elements. In associating with one another, in exchanging ideas, in thinking about each other although far separated on the physical plane, we are exchanging astral energies. Through these exchanges of astral energies we are not what we were before.

We receive mental elements, both pernicious and beneficial, from others, and they receive from us. When we are no longer capable of both giving and receiving ideas, of exchanging mental energies, we are mentally dead. When we can no longer learn from others we have ceased to progress. It is only through mental exchanges that the mind is rejuvenated, only through the exchange of astral energies that mental vigor is maintained. If our minds are to remain young we must find opportunity periodically for association that will permit a complete exchange of ideas.

Union On the Spiritual Plane

—Better to understand this function of union, especially as applied to the spiritual plane, it now seems advisable to trace the steps by which sperm and germ enter into union for the purpose of producing a new individual. As we are discussing human life and its possibilities, although the process is very much the same in all plants and animals, it seems better for the purpose of drawing close correspondences to use as example the human seed.

Both the ovule and the spermatozoon before they are capable of entering into union which forms the nucleus of a new human body must undergo quite a complicated preliminary process. These changes by which they are ripened for a final fusion into a single organism are called maturation. Maturation of the seed is marked by three chief stages: In the first stage the seed is of full size, but not yet capable of permanent union with another cell of the opposite sex. From this stage it arrives at the second and third stages by two successive cell divisions that differ somewhat from ordinary cell division.

Now in the cells of each species of animal there is a characteristic number of filaments called chromosomes. These chromosomes, as I have already mentioned, are the physical carriers of heredity, and the typical number for the tissue cells of man is forty-eight. But in the ripening of the seed, just previous to the first cell division, there is a pairing of the chromosomes, it being believed that one of each pair, that thus fuse to become one, was originally paternal in origin, and the other was maternal in origin. By the marriage of the chromosomes they are reduced in number to twenty-four. The fusion of paternal and maternal chromosomes corresponds to the fusion of selfish and unselfish desires in man under the influence of true wisdom.

Following this internal reduction occurs the first of the two processes of cell division. In the case of the ovule, one of the two ovules thus produced, each containing twenty-four chromosomes, is of less size than the other. It is called the first polar body, and is cast off as of no further value. So also man in the development of his soul learns to free himself from the physical body and function consciously in the astral form. The extrusion of the first polar body, then, corresponds to the elimination of bondage to the physical plane.

The first polar body, after being cast aside, may again divide in the formation of two cells, both of which later disintegrate. Thus in leaving his physical body to travel in the astral, or in leaving it at death, man must also abandon his electromagnetic body, which is closely associated with the physical form. Both the electromagnetic body and the physical body are left behind when the soul functions consciously on the astral plane.

In the third state of ripening, cell division again takes place, with an equal splitting of the chromosomes, so that in each resulting cell there are twenty-four chromosomes.

In this division, likewise, one portion is much smaller in size than the other. It is known as the second polar body, and is cast off to disintegrate. This extrusion of the second polar body corresponds to man freeing himself from his astral body as well as from the physical form. It corresponds to his state when he is able to function consciously in his spiritual form.

Until these two polar bodies are cast off the egg is not ripe, and is unprepared for fertile union. And so long as man is chained by his physical senses and subject to astral intoxication he will attempt in vain to find his true spiritual mate. The union of twin souls, the marriage of the Lamb, is a spiritual union, successfully accomplished only after both have ripened to spiritual maturity.

The chromosomes of the seed may be compared to the various desires that determine the character of a man and give direction to his activities. Before he undertakes spiritual training these desires are rather equally divided between those purely selfish and those more or less unselfish. But as soon as he perceives the truth, that his own advancement and welfare are bound up with the advancement and welfare of all others, that so-called unselfish actions are those from which ultimately he receives greatest benefit, and that all so-called selfish actions always ultimately are detrimental to his welfare, these two sets of desires, the selfish and the unselfish, like the maternal and paternal chromosomes of the maturing seed, amalgamate. Selfish and unselfish desires unite in the formation of desires based upon the motive, *Contribute Your Utmost to Universal Welfare*.

After physical death man functions in his astral body, leaving the physical form behind. When traveling in the astral, while still possessing a physical body, he also leaves the physical form behind. To function on the spiritual plane he must not only discard the physical body and the electromagnetic body—corresponding to the first polar body which when cast off again divides—but he must leave his astral body—corresponding to the second polar body—also behind. At the second death man permanently loses his astral form, and henceforth must function in a spiritual body.

Now in order for the seed to grow into human form it is absolutely essential not only that there shall be a reduction of the chromosomes by fusion, and the two successive stages of cell division described, but that the female seed must meet and fuse into a single form with a male seed. Without the permanent blending in a single form of ovum and spermatozoon the seed never grows into a child. Likewise, according to the Ancient Hermetic Teachings, the angelic form is only developed from the permanent fusion of a male and a female soul.

This doctrine, handed down from the remote past, deals with a condition commonly attained only after the death of the physical body and also after the second death, or disintegration of the astral body. Before this permanent spiritual union of twin souls can take place it is absolutely necessary that each shall have developed a well organized spiritual body. Before this marriage of the Lamb, unselfish and selfish desires must be wed in true wisdom, there must be freedom from physical

limitations, and freedom from astral enthrallment. It has nothing to do with physical marriage, and nothing to do with astral fusions. It is the final union, on the boundary of the sixth and seventh state of the spiritual world, of the spiritual bodies of a male and a female soul.

The Nine-Point Plan Which Must Be Followed

—The mere union in the spiritual world of a male and a female soul, however, does not provide the form and functions of an angel, nor does the mere union of spermatozoon and ovum insure that a child will be born. No more so than that the union of inner-plane facts and outer-plane facts, such as are represented by the two wavy lines which symbolize the sign Aquarius, alone insure there will be the New Civilization which the humanitarian side of the sign demands of the Aquarian Age. In each case, if that of which the union is but the start is properly to develop and result in the promised birth of something more perfect and glorious, development must take place which follows a definite nine-point plan. And even as in numerals the number 10 starts a new cycle, so the tenth step, of course, is the one of transition which marks the birth of that which has undergone the nine phases of gestation.

While the nine-point plan and its final result on each level very broadly correspond to the chain of ten planets, much more detail can be learned from the precise correspondence of the planet or sign to the sequence number in the plan. This astrological rulership of the numerals is set forth in Course 6, *The Sacred Tarot*.

In the Cycle of Necessity the soul undergoes development in nine realms before becoming the transcendent angel which permits its birth into the celestial realm from which it started. This is the nine-point plan which to be successful it must follow: I Celestial, II Spiritual, III Astral, IV Mineral, V Vegetable, VI Animal, VII Human, VIII Astral, IX Spiritual. With these nine phases of gestation completed, Self-Conscious immortality has been won and transition may take place in the perfect angelic form to X Celestial.

In the adjustment of mankind to the Aquarian Age, now at hand, the tenth and final step is the attainment of a truly enlightened and humanitarian civilization. And to make this transition properly, humanity must proceed according to the nine-point plan which follows:

As a cooperative intelligence working for the realization of God's Great Evolutionary Plan, the development of the powers and possibilities of his own soul is of paramount importance to the individual, and of paramount importance to the whole in proportion as the abilities and characteristics thus developed contribute to universal welfare. And this character development is influenced and conditioned by the environmental forces which it contacts not merely on one plane, but on both the inner and the outer plane.

Both the behavior of the individual and the events which come into his life are primarily determined by the desires of the thought-cells and thought structures of his own soul. These thought-cell desires, in turn are determined by the experiences which have formed them or added to them; experiences with both the inner-plane environment and the outer-plane environment. Secondly, the behavior of the individual and the events which come into his life are determined by planetary or other inner-plane energies added to the thought-cells of his soul at a given time, which increase their activity and modify somewhat their desires, and by the facilities afforded by the outer-plane environment to some actions and events and the resistance the outer-plane environment offers to others.

Either freedom from want or any one of the other three essential freedoms which should be present in the outer-plane environment, implies effective use of abilities on materials, and the avoidance of disaster. Square pegs in round holes, people engaged in enterprises for which they have no talent, and people engaging in enterprises at times when failure is sure to result, do not lead to freedom from want. Effectively to guide character development, and to have freedom from want in ample measure, as well as to have the other essential freedoms, the 9-point plan states:

FIRST, that men should be familiar with the Facts of Astrology.

A lifelong physical environment of illiteracy, poverty, disease and heartrending toil, such as vast portions of the world have experienced, is not conducive to developing the potentialities of the soul. Nor is the acceptance of the doctrines of atheistic materialism. Under such physical environmental handicaps the individual ignores or denies the existence of his soul, and is trained to function, whether his intellect is active or numbed by hardships, only on the self-seeking plane of the brutes.

To have sufficient leisure from incessant toil, and to possess the things properly to live, while thought is given to the soul, and effort spent in character development, the 9-point plan states:

SECOND, that men should have Freedom from Want.

A haphazard universe moving without purpose gives few assurances that the individual will not be overwhelmed by disaster. Atheistic materialism, by force of arms if able to do so, and by cunning suppression of all facts which prove there are inner-plane forces, or life on any plane but the physical, if force of arms does not give it world dominance, is determined to compel all men to accept such a purposeless universe, in which selfish force and brutal shrewdness are extolled as the highest virtues. But millions of people, past and present, through their own personal experiences have proven to themselves that there is a Supreme Guiding Intelligence permeating the universe which, under special conditions, men can contact. And millions of people, past and present, through their own personal experiences have proven to themselves that physical death does not end either consciousness or the progress of personality. And in order that people may thus prove to themselves the existence of God, and the persistence of life and personality after the dissolution of the physical, the 9-point plan states:

THIRD, that men should be familiar with the Facts of Extra Sensory Perception.

There is possible either a constructive or a destructive approach to every situation of life. An approach which is accompanied by the emotion of fear is to that extent destructive, for fear is an agent of ineffectiveness and the foe of health and happiness. Even the facts of astrology when viewed from the standpoint of fear may be made detrimental, and freedom from want in proper measure is repelled by fear. Yet the attitude of fear is a conditioned state. It arises from considering the possibility or probability of want, disease, or other disagreeable things, including the cessation of life. Confidence that disagreeable things will not happen, that dangers can be surmounted, and that death merely brings a continuation of life on another plane, assist in conditioning the emotions to resist this most destructive of all attitudes. In order to promote happiness, usefulness and spirituality, the 9-point plan states:

FOURTH, that men should have Freedom from Fear.

The success with which an individual is able to express his natural aptitudes, to contribute to the welfare of all, and to develop his own soul depends, in addition to his familiarity with astrology and ESP and possession of the four freedoms, on the desires of the thought-cells and thought structures of his own soul. The conditions of external environment afforded by the four freedoms facilitate soul growth, and knowledge of astrology and ESP indicate the best course to pursue. But, in spite of knowledge and environment, both the actions which take place which we call behavior, and the events which come into the life, are chiefly determined by the way the thought-cells and thought structures within the soul then feel.

The thought-cells and thought structures have the desires they do, and therefore influence the behavior and events in the manner they do, because of the feeling energy and the emotional energy which have been built into them in the past. And the only way to get them to have different desires, and consequently influence the behavior in a more beneficial manner, and to work from the inner plane to attract more favorable events, is to impart to them appropriate feeling and emotion. To do this intelligently requires the use of deliberately induced emotion. Thus the 9-point plan states:

FIFTH, that men should be familiar with the Facts of Induced Emotion.

But men will not be permitted to become familiar with the facts of astrology or the facts of ESP if atheistic materialism is able to gain the intellectual dictatorship over the people of the world it desires. Nor will it be possible to have either freedom from want or freedom from fear if such intellectual dictatorship is permitted to suppress facts relative to economic conditions and political oppression. To gain power through which to use others for their own selfish and brutal ends, tyrants always have found it essential to suppress and distort the facts.

But even when they have free access to facts, men also have individual aptitudes without the expression of which, either in the vocation or the avocation, they are unable to find happiness and are unable to contribute most to universal welfare.

These creative talents should not be wasted through denying them opportunity for exercise. Therefore the 9-point plan states:

SIXTH, that men should have Freedom of Expression.

The proper exercise of each of the four freedoms, and the proper employment of the facts of astrology, the facts of ESP and the facts of induced emotion, that these may Contribute Their Utmost to Universal Welfare, imply that intelligence must be applied to formulate an effective plan, and that the energies instead of being permitted to wander aimlessly from this plan, be directed into its fulfillment. The energies tend to flow into and develop whatever thought the mind consistently entertains. Thought ever affords, both on the outer plane and the inner plane, the pattern of action. Consequently the 9-point plan states:

SEVENTH, that men should be familiar with the Facts of Directed Thinking.

The most important thing in the universe is God's Great Evolutionary Plan. The conception of this plan depends upon the spiritual and intellectual level of the individual trying to comprehend it. Also, as physical science and spiritual science discover new facts any adequate conception of this plan must be enlarged to embrace them.

To the individual, the most important thing of all is the progress of his own soul. And soul progression cannot be applied to him from the outside by others, no more than can intelligence. It requires effort on his own part to live, not as someone else believes, but according to his own highest conception at the time. It requires the liberty, as more complete information is gained, to modify the conduct to conform to this new information. Therefore the 9-point plan states:

EIGHTH, that men should have Freedom of Worship.

Both the progress of his own soul and the unfoldment of God's Great Evolutionary Plan depend upon the welfare of the various individuals who make up the conscious cells embraced within the whole. What affects one individual, in some degree affects all individuals. The 9-point plan therefore states:

NINTH, that men should adopt as the constant and dominant motives of their lives that they should contribute their Utmost to Universal Welfare.

The four freedoms set forth in association with the negative, or even, numbers, 2,4,6, and 8, relate largely to important factors of the outer-plane environment. There is no assumption that we know all we should about them. In fact, as evolution advances, we are sure to learn details which will assist us more perfectly to realize these four freedoms. And we should strive persistently to acquire such knowledge, which, no doubt, will be made available through the ordinary channels of education.

The four orders of facts set forth in association with the positive, or odd, numbers, 1,3,5, and 7, however, relate largely to important factors of the inner-plane environment. As information relating to them is mostly lacking through the more ordinary channels of education, the Brotherhood of Light lessons were written to

make it accessible to all.

Yet these lessons, which are as comprehensive as it is possible to make them at this day, make no assumption that we know all we should about these four orders of inner-plane activities. In fact, although we now know the fundamental principles through which each operates, as times goes on we are sure to gain many new details which will assist us more perfectly to utilize these four different categories of inner-plane forces. As this new knowledge is gained it will be included in revised copies of The Brotherhood of Light lessons. And to hasten acquiring it, The Church of Light maintains three active research departments: The Brotherhood of Light Astrological Research Department, the ESP Research Department, and the Control of Life Research Department.

Even as Aquarius is symbolized by two wavy lines, one above the other, are there four essential freedoms which relate chiefly to the physical environment, and four orders of facts which relate chiefly to the inner-plane environment, the utilization of which are essential. But between the four outer-plane freedoms and the four inner-plane orders of facts, must ever remain as the central theme the all-inclusive principle indicated by the Deific number 9, the number of Aquarius: the constant and dominant motive in men's lives must be to Contribute Their Utmost to Universal Welfare. This is the most important factor of all in the Nine-Point Plan for the New Civilization.

The nine-point plan by which the united spermatazoon and ovum successfully develop to the point where a healthy child may be born is as follows:

During the first month the two cells that fused into one at conception undergo a constant geometrical progression of cell division so that within twenty-four hours there are thousands of cells. This process is accelerated from day to day until by the fourteenth day there is a distinct embryo, and by the end of the month the embryo is about one inch in length and the principle organs are discernible.

The second month brings remarkable increase in the size of the head, the tail becomes less conspicuous, there is rapid growth of the limbs, and the human form is definitely established.

The third month is marked by establishment of the generative organs; the limbs take definite shape and the nails form.

In the fourth month the chin, index of determination, begins to be prominent, the sex becomes well marked, and the embryo begins to show signs of life.

During the fifth month the skin becomes more consistent, and the hair is more extensively developed than previously.

In the sixth month the eye-lashes and eye-brows make their appearance, and the sternum becomes well developed.

Then comes the seventh month at the end of which if the child is born it usually lives. The bones forming the skull become strongly convex, and the central point of each,

from which ossification commences, forms a noticeable prominence.

During the eighth month the most important changes are those relating to nerve force and the electromagnetic body.

The ninth month brings the final adjustment between the astral body of the child and the vibrations of the planets. This period is not at an end until the astrological rates correspond closely, both in trend and in harmony or discord, with the thought-cell pattern of the unborn child.

Chapter 6

Serial No. 5
Original Copyright 1927
Elbert Benjamine

Copyright
Church of Light
August 2002

Doctrine of Signatures

Chapter 6

The Doctrine of Signatures

THE English word signature is derived from the Latin “signare,” meaning to sign. A signature, therefore, is a mark of identification. The Latin “docere,” from which the word doctrine is derived, signifies to teach. In occult science “The Doctrine of Signatures” relates to that which is taught about the marks placed upon all things by stellar influences. It is of these stellar marks of identification that I shall have considerable to say.

Turning for the moment from the stars, we find that the owner of livestock places a brand upon his cattle by which his property may be recognized. The manufacturer, that its source may be recognized, stamps a trademark upon his product. The public official places his seal upon legal documents to denote their importance and character; and correspondents sign their letters with their autographs that no doubt may arise in the mind of the recipient as to whom the sender may be. These are circumstances commonly recognized. But less commonly recognized is the fact that all things external have upon them the stamp of their origin in the cause world and that this relates them as definite kin to certain other things.

It is not surprising that one may fail to recognize the seal of the Emperor of China or the signature of an Indian prince. Yet to one familiar with the language, history, and customs of China and India such signs are evidence enough upon which to establish the source of a missive and determine the prestige of its sender. Likewise, the man in the street is ignorant of the signs by which the planets and zodiacal signs mark their progeny; but those familiar with celestial language recognize these marks and, in addition to deducing their common origin, quickly perceive the relationship of anything so sealed with other objects bearing the same impress.

Now to facilitate the study of the Doctrine of Signatures let us turn to that much misunderstood tradition the Jewish Kabala. Not that the Jews knew more about occult doctrine than other ancient peoples, perhaps much less than some; but because through their contact with the priesthood of both Egypt and Chaldea they became familiar with the Mysteries that in these countries were taught only to initiates. Moses, the great law giver of the Jews, according to the most authentic tradition, was saved from the waters of the Nile by Thergmuthus, the daughter of Pharaoh Amenophis. He was raised by the Magi, or Ancient Masons, and drew from their

secret teachings the religious, political, and social ideas which were the basis of the legislation of the Hebrews after their exodus from Egypt. That Moses received initiation from the Egyptian Priesthood is made apparent in the Bible, Acts 7:22 “And Moses was learned in all the wisdom of the Egyptians, and was mighty in words and in deeds.” Thus did the laws and rites of Ancient Masonry pass in great measure into the theocracy which Moses founded.

The religious laws of antiquity in general and of Egypt and Chaldea in particular forbade that any part of the Mysteries should be committed to writing. These things, nevertheless, were evidently revealed by Moses to the Hebrew Elders and handed down by them until the second destruction of the Temple, because at that time it was placed in writing as the Kabala. A great deal of this traditional wisdom was also, from time to time before the advent of the written Kabala, but during and subsequent to the Babylonian captivity, concealed in the Bible. In these two Jewish books, the Bible and the Kabala, that all may read who can penetrate the veil, we have the esoteric doctrine of Chaldea and Egypt.

The Kabala describes creation as having been accomplished by means of ten emanations. Earlier than this all was without form and void.

Before proceeding with this Kabalistical explanation it is advisable to explain that universally considered there is but One Principle, but One Law, but One Truth, and but One Agent. This thought is expressed beautifully by the four-fold sphinx. It has the paws of a lion, symbolizing the One Principle—energy; the wings of an eagle expressing the One Law—sex; the body of a bull signifying the One Agent—form; and the head of a man typifying the One Truth—reality.

The Kabalists called the state prior to creation Ain Soph Aur, meaning the limitless light. It represents a condition when nothing existed but the all pervading nonatomic spirit, potential but unmanifest.

Then comes emanation, creation. The first of these emanations is Kether, or Crown. It is merely motion, vibration. Coincident with this a partnership is formed. The nonatomic, diffusive spirit is polarized into more active portions and less active portions. These are related to each other as positive and negative. Deity is no longer homogeneous, but has become male and female. Here we have the godhead of the kabalists, similar to the godhead of the world’s most popular religions. The kabala calls it Kether, Chocmah, and Binah, rendered Crown, Wisdom, and Love, or in terms of Hermetic philosophy, Life, Light, and Love—the God Who is a trinity, yet is one.

This triune godhead, according to the ancient teaching, is the spiritual sun of the universe from which flows the so-called solar ray. The latter contains within it the potency of all that is, all that has been, and all that ever possibly can be. It is not to be confused with the rays of the physical sun, for it is spiritual and mental as well as physical. The more slowly moving portions of this ray, the negative portions, interact with one another to produce the grosser forms of substance such as the ether of space that cushions the sun and planets and those still less active forms with which we are

more familiar as matter. The more active moving portions of the ray, the more active portions of this universal energy, we term spirit. This positive, finer, more subtle energy inheres in matter of every grade and order as the instigator of life and motion.

From the first trinity of the Sephiroth, known to western students as Life, Light, and Love, are evolved seven more specialized emanations which constitute the Seven Active Principles of Nature. This is brought about through the Solar Ray being refracted from seven sub-centers around the spiritual sun. These form the seven states of angelic life from which issue all the life-entities of our universe. Each of these seven states corresponds to one of the seven planets. The kabalists hold that each is presided over by an archangel, or as modern astrologers state, each represents a family of planetary life. Thus the planetary family corresponding to the Sun is said to be ruled over by the archangel Michael, that corresponding to Mercury by Raphael, that corresponding to Venus by Anael, that corresponding to the Moon by Gabriel, that corresponding to Saturn by Cassiel, that corresponding to Jupiter by Zachariel, and the family corresponding to Mars by Samael.

Now the spiritual potencies that constitute the egos of all things never were created, never had a beginning, never can be destroyed. The law of conservation of energy forbids such beginning and such destruction. But they did have a point of differentiation from which they departed on their present cyclic journey, and this point of departure was within the spiritual vortex of one of the planetary families. Each ego, therefore, partakes of the attributes of one of the seven planetary families, and this may be said to constitute the character of its genius. That is, the internal nature, or individuality, of each human being corresponds to one of the planets, and this correspondence is never entirely effaced during the whole stretch of time that constitutes the soul's cycle of experience.

The two souls which embrace all the states of consciousness of the ego, partake of the planetary quality of the ego. Not only so, but they carry with them the impress of their birth-place, or environment in which differentiation took place. Thus the universe is divided into four states of life—fire, air, water, and earth—and each soul proceeds from one of these four states which are represented by the fiery, airy, watery, and earthy signs of the zodiac. It is this affinity for a certain state of life that shapes the general trend of the soul's impulses.

Furthermore, each state of life has three degrees of emanation. Thus Aries constitutes the first, Leo the second, and Sagittarius the third degree of emanation of the fiery state of life. Gemini is the first, Libra the second, and Aquarius the third degree of emanation of the airy state of life. Cancer is the first, Scorpio the second, and Pisces the third degree of emanation of the watery state of life. Taurus is the first, Virgo the second, and Capricorn the third degree of emanation of the earthy state of life. Each soul, therefore, by reason of the environment in which the differentiation of the ego occurred, also may be said to belong to a certain degree of emanation.

The motives and impulses of a soul belonging to the fiery state of life are found to be shaped largely by inspiration and enthusiasm; those belonging to the airy state of life

by intellect and aspiration; those belonging to the watery state of life by sensation and emotion; and those belonging to the earthy state of life by application and practicality. If, at the same time a soul belongs to the first degree of emanation he will act from his own feelings, ideas, and inward yearnings; if he belongs to the second degree of emanation he will act to a greater extent from the motive of what other people think and advise; and if he belongs to the third degree of emanation his acts will be very largely determined by the ideas and admonitions received from others.

It is now apparent that the doctrine of signatures revolves around three chief factors which are termed Character of Genius, State of Life, and Degree of Emanation. Much as we indicate the parentage of a man by saying he belongs to Bourbon stock, so we may designate the lineage of a soul by saying it belongs to the planetary family of Mars. As we indicate the country of a man's birth by saying he was born in England, so we may indicate the broad environment of a soul's origin by saying he belongs to the Fiery state. And as the city of a person's birth might be London, so the more local environment of a soul's origin might be the First Degree of Emanation. London is in England, and the First Degree of Emanation of the Fiery State is Aries. By the use of such terms we are able to designate the parentage and birth-place of a soul just as we are able by other more familiar terms to designate a person's physical parentage and place of birth.

When accurately determined the ancestry and place of birth of an individual gives considerable information as to what may be expected of him. Likewise the planetary family and celestial environment of a soul's origin is some index to its abilities and possibilities. That is, while not complete data upon which to predict the actions of an individual or a soul, they have a real value as determining factors.

They are not complete data because after birth each individual and each soul undergoes a series of experiences. These greatly modify the qualities with which the individual or the soul is born. Subsequent environment is constantly changing the character, constantly adding new factors, constantly giving new viewpoints. Yet an Englishman born in London will not react to the same set of experiences in the same way that a North American Indian reacts to them. They will not modify the character in the same way, nor will the same viewpoint be developed from them. Ancestry and birth environment are not all to be considered in reference to character. Neither are later environment and experience to be considered all. Both the later environment and the ancestry together with the birth environment must be considered. The birth chart reveals the result of the interaction of both these factors up to the time the soul is born in human form. The Doctrine of Signatures, therefore, considers the influence of ancestry, birth environment, and subsequent experiences upon the soul, as revealed by the birth chart, and as indicating both Character and Fortune.

After its differentiation the soul-monad in its cyclic journey passes through innumerable states and phases of existence, adding new characteristics and qualities, as a traveler acquires new customs and idioms of speech without effacing the marks of birth-place and parentage. One traveler, however, is attracted to certain customs while being repelled by usages that are attractive to other travelers. Likewise each

soul on its long journey is attracted more strongly to certain forms of life, and finds more complete expression through them, while souls of different origin are attracted strongly to, and find more complete expression through, other life forms. The soul belonging to the planetary family of Mars, for instance, whenever it finds itself in a Saturnine environment expresses itself only with greatest difficulty, and the Venusian soul feels little affinity for the regal surroundings and majestic qualities of the sun.

The soul is a traveler, and as such is ever collecting and disbursing. Its baggage at any given time represents its original equipment and its collections, minus its disbursements. That is, the soul in its journey constantly attracts and repulses forms. By virtue of its original polarity it shuns some things and embraces others, the sum total of its experiences and original equipment constituting the quality of the soul at any given point in its journey.

It may be, and often is, so surrounded by baggage attracted enroute that it is difficult to perceive its original characteristics, but these nonetheless exist. Such inherent attributes by which we recognize its degree of emanation, its state of life, and the character of its genius, in other words its attractive and repulsive power, we may call its original signature.

The Doctrine of Signatures, however, is not confined to entities; for species, genera, races, families, kingdoms, all have group signatures. This means that the members of a group all vibrate in some particular respect to a common vibratory rate or its multiple. They are sympathetically united to, and thus said to be ruled by, the energies of some planet or zodiacal sign. In this circumstance we find the greatest practical application of the Doctrine.

Yet when we are informed that peppers, mustard, nettle, thistle, onions, and horseradish are plants ruled by the sign Aries we are not to conclude that the individual entities of all onions, peppers, etc., had their origin in the fiery state of life, first degree of emanation; for the individual entities may have had widely varied origins in the celestial spaces. Some may have sprung from each of the several states, degrees, and families; for in its pilgrimage from mineral to man the entity traverses the whole ascending scale of life. The soul that now occupies the regal body of man was once incarnated in each of the progressive steps—some allowance being made for different requirements—from the lowly crystal atom through the various evolutionary forms up to his now exalted state. He has in turn occupied species ruled by all the various families, states, and degrees of emanation.

What is meant is that the species onion, as a whole, is ruled by, and vibrates to the keynote of, the fiery sign Aries. The impersonal soul's temporary need for expression has attracted it to this group of plants, and its original signature is largely obscured by the general vibratory rate of the species as a whole. The original signature is there were we but acute enough to perceive it; for undoubtedly plants of any species possess differences and individuality. But in our relation to them the group vibration is far more marked than their differences one from another; and in the

case of plants ruled by Aries we expect them to be hot and irritating.

Applying the same thought to peoples, when we say that the English are ruled by Aries, we know that as a rule an Englishman will violently resent injury. But the individuals comprising the English nation have their own birth charts which indicate the celestial origin, the temperament, the abilities, and fortunes of each. Turning to animals, wolves likewise are ruled by Aries, and while some are quite different from others, yet all display the martial temperament. And still lower in the evolutionary scale we find among minerals, and possessing the characteristic qualities, brimstone also ruled by Aries.

Thus we find in each kingdom of life groups of entities that vibrate to the keynote of each of the zodiacal signs. To illustrate further let us consider the sign Taurus: In the mineral kingdom Taurus rules white coral, alabaster, all common white opaque stones, and the gem agate. In the vegetable kingdom it rules flax, larkspur, lilies, moss, spinach, myrtle, gourds, dandelion, daisies, columbine, colts-foot, plantain, and beets. In the animal kingdom Taurus rules those commonly known as bovine; the ox, cow, buffalo, yak, etc. Man, as a family, is ruled by Aquarius, but nations and towns have a distinct rulership. Thus the Irish people are ruled by Taurus, as are the cities of Dublin, Leipsic, St. Louis, Palermo, Parma, Mantua, and Rhodes. In like manner occupations, localities, physiological functions, anatomical parts, diseases, colors, tones, and various other classifications of things all have their signatures.

All nature, we find, is divided into seven distinct families, each family containing a membership on all planes and in each sphere of life. Further, the affinities of each family have a vibratory range that is not closely restricted, some members harmonizing more closely with the higher rates, and some members harmonizing more closely with the lower rates, of vibration within the range of the families affinities. Thus within the families groups are divided both by State of Life, and by Degree of Emanation. The planetary family of Mars, for instance, has affinities for two zodiacal signs. Aries belongs to the fiery state of life, first degree of emanation, while Scorpio belongs to the watery state of life, second degree of emanation.

Observation has shown that the influence of entities and groups upon each other very largely depends upon their vibratory rates, which in turn depend upon their signatures. Thus entities and groups belonging to the same planetary family have a vibratory quality similar to other members of the same family, although the plane occupied determines the octave from which the emanations proceed. In a similar manner there is a like vibratory quality between things ruled by the same zodiacal sign. Things ruled by the same planetary family, or by the same zodiacal sign, usually harmonize well. When the ruling signs are different but the celestial state is the same, as in the case of Taurus and Virgo, there is also pronounced harmony. Between things ruled by complementary states, that is, between fire and air, and between earth and water, there is a weak harmony. But between things ruled by contradictory states—between fire and water, and between air and earth—the vibrations are antagonistic and mutually destructive. These facts have an important bearing upon every phase of life.

Before indicating in detail just how everything we contact influences our lives for good or ill, and just how we have the power in great measure to control the influence of things over us by intelligently selecting our environment, let us for a moment consider that what is commonly called good and evil are but other names for harmony and discord.

Scarcely two people give these terms the same interpretation; for they are ever considered in relation to the ambitions and desires of the person using them, or are applied to other things the importance of which varies widely in the estimation of different people. Thus the thief, successful in his robbery, thinks this is good because it harmonizes with his desire for wealth. An honest man calls the act evil, because it is discordant to his idea of social responsibility. Again, a shower that is looked upon as good by agriculturists, may be called evil by the fashionable lady with whose house party it interferes. In the first instance it harmonized with the farmer's interest, in the second it was discordant to the house party. The rain was the same, but the thing influenced by it was different. Good and evil are terms that imply a relation to some definite entity. Insofar as an influence is harmonious to the entity it is called good, and insofar as it is discordant to the entity it is called evil. There is no good or evil aside from harmony and discord.

These entities which are influenced in a manner said to be good or evil are infinite in number and compose the universe. That is, the universe is composed of an infinite number of entities and groups of entities. They are all interacting and interdependent; everything, great and small, near and distant, has some influence, powerful or weak, upon every other thing in the universe. Whether the influence exerted by one thing upon another is good or evil depends upon the mutual harmony or mutual discord.

Better to understand the influence of things upon each other we should bear in mind not only that the law of gravitation is active between all objects in the universe, but that modern science demonstrates that all things radiate energy. Radium is the classical example of such radiation, but in a like manner, though much less pronounced, all substance is sending forth vibratory waves that can be detected at considerable distance by delicate scientific instruments. Aside from the controversy of the part the subject plays in diagnosing by the Electronic Reactions of Abrams, the Abrams method demonstrates conclusively that everything has a vibration to which it is keyed, and that these vibrations are radiated and can be detected at a distance. A number of experimenters have made marked improvements upon the original Abrams method, and have produced machines of great delicacy and accuracy in intercepting and interpreting the vibratory rates that all things radiate.

Were it not for energy radiated by objects and persons which in some manner leaves an impress upon all things coming close to them it seems unlikely that psychometry would be possible. Even sight depends, not upon the vibrations radiated by objects, but upon vibrations reflected from them. Such vibrations have an influence upon the human eye, different objects having a different influence. This difference in influence is due to diversity both in intensity and in form.

This leads to a very important consideration; for the intensity of influence tends to increase with the proximity of the object radiating it. It is true that things having the same vibratory rate that chance to vibrate synchronously—that is, the crest of the wave of one set of vibrations coinciding in time with the crest of the wave of the other set—are capable of influencing each other at great distances. A person changing his rate of vibration by raising or lowering it through altering his mood can illustrate this principle. In this manner he can get in rapport with people or things exceedingly remote, and having tuned in on their vibrations these may have greater influence upon him than other things with as great vibratory intensity close at hand. But aside from this factor of rapport the vibratory rates of things close at hand have a greater influence than the vibratory rates of similar things more distant. Likewise, even when rapport is established, a weaker vibration close at hand has as much influence as a stronger one radiated at a greater distance. To make practical application of this simply means the recognition that man is more influenced by the vibratory rates of things in his immediate environment than by those of somewhat similar nature more remote.

The manner in which man is thus influenced by the objects in his immediate environment is easily understood as soon as the general organization and makeup of his astral body, and its relation to the physical body are known.

The astral body, which is the mold of the physical body, is composed of astral substance organized by states of consciousness. The original planetary family, state of celestial life, and degree of emanation of a soul endow it with certain attractive and repulsive qualities. In the course of its involution to the mineral state, and its evolution from the mineral state to man these attractive and repulsive qualities attract it to incarnate in a great number of forms, in which it has a wide variety of experiences. Each experience affects the consciousness and is recorded as a mode of motion in the astral body. Thus the total experiences of a soul in its pilgrimage are recorded in the astral body. Through the law of affinity these energies within the astral body tend to unite where there is likeness and tend to segregate where there is unlikeness. Thus definite centers of energy are formed, each corresponding in its general vibratory rate to planetary influences, and other more general areas of the astral body are organized having vibrations corresponding to the zodiacal signs. Birth into human form, then, does not take place until the positions of the planets and signs—within certain limits—correspond to the vibratory organization of the astral body of the child to be born.

At birth the centers of energy already formed in the past through states of consciousness accompanying experiences are but intensified and given greater fixity. A person's character, as all must admit, is the sum total of all his past and present mental states. That is, they are the sum total of the states of consciousness organized as centers of energy within his astral form. These centers of energy are the mental factors both of the objective and the unconscious mind which determine the person's conduct. As the positions of the planets in the birth chart map these centers of energy, they constitute an accurate map of the character.

This map indicates with great accuracy, as shown by planetary positions, the general types of experience of the soul in its past. It indicates, by the prominence of the planets, the amount of the acquaintance the soul has had with experiences of each of the general types. It shows, by the aspects between the planets, the extent to which experiences of one type have been associated in the past with experiences of other types; and the extent to which these associations were harmonious or discordant. Furthermore, as the kind and amount of experiences attracted depend upon the original polarity of the soul when it started on its cyclic pilgrimage, if the map can rightly be interpreted, it should show the original signature of the soul, that is, the planetary family, the state of celestial life, and the degree of emanation, to which it belongs.

In its practical application, however, I believe great caution should be used in making positive assertions as to this, because the soul in incarnating has a fairly wide margin of vibratory rates within which incarnation is possible. That is, even as we must allow orbs of influence when considering aspects, so we must allow orbs of influence when considering the relation of the origin of the soul to the positions of the planets at birth. Thus a soul having its origin in the fiery state would tend when born in human form to have the sun in the birth chart in a fiery sign. But we may suppose in certain cases instead of the sun being in a fiery sign that there would be several other planets in fiery signs, and these planets strong in the birth chart. A soul belonging to a certain planetary family would certainly have this planet unusually prominent in the birth chart, and usually it would readily be picked as the most powerful planet in the chart, and consequently as the ruling planet. But we may suppose in a certain chart that while this planet is very powerful that there are other planets that seem quite as powerful, one of which might mistakenly be chosen as the true ruler of the chart. The experiences of a soul since its differentiation have been adding energies to its finer forms, and furthermore, the varied and unique requirements in the development of some souls to fit them for their work in the cosmic scheme of things is such as often to obscure the original equipment with which they started on their great cyclic journey.

We are quite justified in saying of a person in whose chart Jupiter is the dominant planet that he belongs to the planetary family of Jupiter. At the same time, due to the limitations that govern incarnation, if another planet, or more than one other planet, seems almost as strong, we cannot be positive that the soul did not have its origin in the family of this other planet. If the sun in a person's chart is in the sign Sagittarius we are quite justified in saying the individual belongs to the fiery state of life and the third degree of emanation. But if at the same time the moon, for instance, is rising in the sign Taurus, it might make it difficult to tell whether the soul had its origin in the fiery state, third degree, or in the earthy state and first degree of emanation ruled by Taurus.

This uncertainty which occasionally may arise need not seem discouraging; for in every known science, including physics, chemistry, and mathematics, we meet with problems no less disconcerting. Yet while the birth chart may not in our present state of knowledge tell us all about the parentage of the soul and its original environment

in every instance, it does indicate infallibly the intensity, the kind, and the interrelations of the mental factors which comprise the character and determine the fortune.

It is these centers of energy within the astral form that give ability and that attract to the person the various events of his life. By the law of affinity like attracts like, and whatever vibrations and qualities reside, or are stimulated into activity, in the astral form attract corresponding conditions in the environment. A discordant vibratory center which in the past has been formed in association with procuring food and shelter will attract an environment that will make the procuring of these things, that is, the acquisition of wealth, most difficult. Such a center of energy would be indicated by Saturn afflicted in the Second House of the birth chart. Harmonious centers of energy as shown by the birth chart are actual forces within the astral body that attract an environment favorable to the department of life with which the center is shown to be associated. Thus fortune and misfortune, opportunity and lack of it, success and failure, are the results of centers of energy in the astral form which are infallibly shown in the birth chart. The birth chart gives the Astrological Signature in all its details.

It follows from these considerations that any modification of the centers of energy in the astral form make a corresponding change in the fortune. To the extent, then, that man can intelligently change the centers of energy within his astral form is he the master of his own destiny and free from blind fatality. These centers of energy with which he is born that are mapped by the birth chart are actually changed by three distinct factors.

As the planets move forward in the zodiac after a child's birth they make new aspects to their original positions in the birth chart and new aspects among themselves. These aspects thus formed store up energy that later is released by the cyclic motion of the heavens. These progressed positions of the planets, as they are called, stimulate and release energies in the astral form in directions and at times shown by the progressed aspects. Such releases of energy can be modified by the other factors to be considered, and their influence controlled by the selection of an environment suitable to their working out as indicated or in which they cannot work out as indicated. One factor, then, that changes the centers of energy in the astral body is the influence of the planets. This factor is fully discussed in Section 2 of Course 10, *Progressing the Horoscope*.

Another factor that changes the centers of energy within the astral body is the factor that originally organized them. That is, states of consciousness, or thought. How thought may be used to recondition the thought-cells of the astral body and thus bring about any desired change of fortune is explained in detail in Course 9, *Mental Alchemy*.

The third factor, and the one with which we here are more concerned, is the power of the objects in the environment to stimulate and modify by their radiations the centers of energy within the astral body and thus affect the life and destiny.

As previously explained each object and certain groups of objects, in fact, everything we contact from dense rock to human thought, is radiating energy. The type of energy radiated is determined by the astrological signature. In other words, everything vibrates in a key that corresponds to one of the celestial influences, and if this key is known its influence upon any other person or thing whose key is known can be predicted. The classical example of this power of vibration is the ability of a fiddler to fiddle a bridge down if he finds its key.

Now, within the astral body of man are centers of energy, some more prominent in some persons and some more prominent in other persons, that correspond to each of the various keys. When a person comes in contact with an object its vibrations stimulate a sympathetic response from the center of energy within the astral body that vibrates to its key. As everything we contact has a key of vibration, and radiates energy, each tends to stimulate centers of energy within the astral form. Every thing we contact gives additional activity to the center of energy mapped in the birth chart by the planet or sign ruling the object. If we know the astrological signature of things, then, we are aware of the particular center of energy in our astral forms that each stimulates into activity, and we may select such objects for our customary environment as will stimulate only those centers that we desire should become more active.

Some of these centers of energy are decidedly harmonious, and other centers are decidedly discordant, as shown by the aspects between the planets in the birth chart. Furthermore, some of them influence one department of life and others influence other departments of life, as shown by the house positions of the planets in the birth chart. To associate with the things that stimulate the discordant centers of energy gives these discordant centers additional power. The centers of energy within the astral form are modified in the direction of strengthening the discord, and the result is bound to be that added misfortune will enter the life. But to associate with the things that stimulate the harmonious centers of energy gives these harmonious centers additional power. Because the harmonious centers are so active they attract a more harmonious set of conditions into the life, which by their presence keep at a distance the events that the discordant centers otherwise would attract, and at the same time act positively to bring good fortune.

By selecting those centers of energy in the astral form that the birth chart shows are associated harmoniously with certain ambitions, and selecting the various objects and conditions of the environment that will add energy to these particular centers, it is possible to so change the power of these centers that they will act in a marked and positive manner to attract the object of the ambition. This is a practical application of the Law of Astrological Signatures the importance of which can hardly be over estimated.

Among the things that observation shows have a pronounced effect in changing the centers of energy within the astral form of persons closely associated with them are colors, tones, numbers, and names. Colors and tones have a vibration that in one case is visible and in the other case is audible. Names and numbers in themselves are

abstract ideas, but when they enter the mind they give rise to definite images which radiate energy through thought-waves. The thought-waves vary with the name or number, and thus a name associated with a person, or a house number or telephone number repeatedly thought about in connection with him by other persons, keeps him bombarded with vibrations corresponding in rate to the astrological signature of the name or number. These vibrations change the centers of energy within his astral body in a definite way, and bring about a change in his thoughts and in his fortune. The influence of tones, colors, names, and numbers are treated in detail in Course 6, *The Sacred Tarot*.

Localities also have their particular astrological signatures, their specific vibrations which have the power to change the centers of energy within the astral form and thus influence the life and destiny. The rulership of the various kinds of localities is given in Chapter 5, Course 8, *Horary Astrology*. Even the flowers with which we associate have considerable influence, and gems which are worn have a great influence over the life. The signatures of certain typical flowers, the signatures of various gems, and the signature of letters, numbers, colors, and tones are briefly given in Chapter 6, Course 10-1, *Delineating the Horoscope*.

A knowledge of astrological signatures is of utmost importance in healing; for a treatment that one responds to, or a medicine that is good for one person, may have an opposite effect when applied to another person suffering with the same complaint. Methods of treatment each have their own signature, and are especially effective when applied to patients of similar signature. Herbs and other remedies likewise each have a specific vibration, and the effect of their use depends upon the harmony or discord of corresponding centers of energy in the astral body of the person to whom administered. A remedy ruled by a sign or planet stimulates the section of the body corresponding to it in signature, and has a powerful effect when applied to it. But if this section of the body is shown in the birth chart to have a discordant vibration it but increases the discord. A disease may successfully be treated by fighting and overcoming its vibrations by the use of a remedy that is the vibratory antidote. This is on the principle that water quenches fire. Or it may be treated by applying to the afflicted part a remedy ruled by the celestial influence in the birth chart that makes the strongest harmonious aspect to the part afflicted. By thus strengthening the part where the affliction occurs with additional harmony the disease, which is an inharmonious condition, can no longer manifest. These, however, are considerations that are discussed in Course 16, *Stellar Healing*.

Perhaps there is no department of life in which the doctrine of signatures plays a more important part than in our association with others. The centers of energy within the astral body of each person are radiating energy. Some of these centers radiate harmonious energy and some of them radiate discordant energy. Thus when we come in close contact with another person our astral bodies receive the impact of these vibrations, and our centers of energy are greatly stimulated. But the manner in which they are stimulated depends, in great measure, not merely upon the harmony of these centers considered separately, but upon the natural harmony or discord that obtains

between the centers of energy in one person's astral body as related to the centers of energy in the astral body of the other person. A comparison of birth charts indicates quickly just how one person will affect another if they become closely associated, and in just what department of life, and how, the harmony or discord will manifest.

For harmony in marriage the first consideration is that the etheric vibrations, as shown chiefly by the First House and the Moon should be similar. If markedly dissimilar their energies will not fuse, they will not get in complete rapport, and both will experience a constant feeling of unrest and dissatisfaction. The next consideration should be that both belong to the same planetary family, or at least that the mental trend should be enough alike that they have interests in common. Finally, if both belong to the same state of life, or to complementary states, as shown by the sun signs, it enables them to understand each other's viewpoint, leading to compatibility. This subject is treated in detail in Chapters 6 and 7, Course 10-1, *Delineating the Horoscope*.

Another department of life over which the doctrine of signatures has a profound influence is business and the acquisition of wealth. Each person has within his astral body a center of energy, as shown by his birth chart, that vibrates more strongly to some natural source of wealth than do the other centers. In other words, things of a certain type attract to him wealth that he could not hope to attract in association with other things. Therefore, to the extent he associates with things that correspond in nature to his most harmonious center of energy will he attract wealth, and to the extent he associates with the things that correspond to the most discordant center of energy in his astral body will he meet financial misfortune.

The astrological signature of a person indicates the type of ability he has. He should capitalize on this ability by following a business, trade, or profession where it is called into play. But if he would succeed to his utmost, in the use of this ability he should find an avenue of its expression in which he is constantly brought in contact with the things corresponding to the most harmonious center in his astral body; for they are his natural sources of wealth.

The doctrine of signatures in its practical application has a ramification as wide as the interests of man. It pervades, and has an important bearing in, the most unexpected quarters. The student of the occult will meet it at every step. Only through a knowledge of this doctrine, as here most briefly outlined, can man live to his highest, accomplish most for himself and for others, and become of utmost service to universal society.

Chapter 7

Serial No. 20
Original Copyright 1928
Elbert Benjamine

Copyright
Church of Light
August 2002

Facts and Fancies about Reincarnation

Part 1

Chapter 7

Facts and Fancies About Reincarnation, Part 1

OVER the Occident has swept from dreamy Oriental skies, during the past forty-five years, a balmy breeze of metaphysical speculation laden with the aroma of the choicest flowers of eastern thought. Upon the West it has had a salutary influence, warming the chill winds that blow so constantly from the icebergs of the practical that they threaten to force upon us a frigid climate of materialism.

The more spiritual inhabitants of the Occident were quick to recognize the advantages to be derived from the East, and opened wide the windows of their souls to the genial influx, absorbing often without discrimination all that the aromatic zephyrs wafted to their shores. Unfortunately, the flowers of Oriental thought are not all friendly to the human race; for amid the wholesome varieties whose perfumes become an invigorating tonic to the spiritual nature are to be found others noxious, whose noisome odors poison and atrophy the soul. Another efflorescence, the subject of this lesson, scarce less deadly in character, has a most fascinating fragrance that intoxicates as a subtle stimulus. Its effect is to interest in things spiritual, to give high ideals and lofty aspirations; but at the same time to dim the spiritual sight and confuse the mind. It numbs the senses of the soul by refuting their evidence, and sinks the intellect into a state of dull apathy where, rather than make the effort to acquire knowledge at first hand, it is content blindly to accept the statements of others.

So thoroughly has western occultism become intoxicated with this insidious teaching of human reincarnation and karma that one scarcely can open a book upon occult subjects without finding some reference to it within a few pages, its verity being taken as a matter of course. Occult periodicals teem with references to it, and one seldom mentions a phenomenon in which occult forces play a part without being called upon to explain its relation to reincarnation. Upon the shelves of our public libraries are volumes written to prove its truth, but strangely enough, we find little there analyzing it or criticizing it. The student upon his first approach to occult science is impressed generally with the notion that he must accept unquestioningly the dogma of human reincarnation as the foundation of truth if he is to accept any part of occult teachings. So fully has this subtle doctrine permeated western esoterics that few have the hardihood to express their opinions if these are contrary to the popular current. It is so firmly entrenched that anyone daring to present the opposite side of

the question is, if possible, immediately squelched, discredited, and made an object of discountenance and suspicion.

Now, I am convinced it is a most dangerous omen when people permit themselves to be so dominated by any new idea, religious or political, that they fear to hear it criticized. It is an augur of approaching mental slavery. Prohibiting critical investigation has been the method employed through countless ages by religious and political autocracies, and where successful has never failed effectually to block the path of mental and spiritual progress. Error must ever be hedged and protected by a wall of prejudice and intolerance, but truth is strong enough to withstand in the open the assault of mental conflict.

Before saying more, that my position may not be misinterpreted, I may mention that among those I esteem highly are students who make human reincarnation the groundwork of their belief. Others equally esteemed are steeped in the tenets of the various orthodox sects. Nevertheless, these people are intellectual, and they are clever in applying occult forces and in discerning occult truths that do not happen to conflict with their religious preconceptions. These good friends are morally worthy, possess high ideals, and are prompted by the best of motives.

Then again, there undoubtedly have been Christian Mystics who have believed devoutly in vicarious atonement, and there have been Oriental Mystics accepting reincarnation, who have been of unparalleled virtue and goodness. So today there are many worthy persons in both classes. And it is not my desire in issuing this lesson to wound the sensibilities of these who hold to ideas at variance with my own, or to imply, upon their part, lack of intelligence. I do, however, feel in duty bound to exercise the prerogative necessary to mental freedom; the right of honest disagreement between scientific investigators.

It has been well said that it is easier to rescue truth from error than from confusion. Science and philosophy have found it no difficult task to overthrow falsity once there is something tangible to grasp. But a hazy chimera presents no secure hold for the reason. Could the tenets of human reincarnation be sharply defined it could be grappled straightway and its strength proved. But there is nothing definite about it; for in scarcely two schools are the same things taught, and those advocating it most persistently do not agree in its essential details.

The number of incarnations in human form necessary are given by Mr. Sinnett, who was the first to publish anything regarding the appointed number of reincarnations, as not less than 686, and normally not far short of 800, but varying within narrow limits. One strong school in America teaches that two or three incarnations are all that are necessary, and various other centers teaching reincarnation range between these figures.

As to the time elapsing between incarnations we find in Mr. Sinnett's Esoteric Buddhism that rebirth in less than 1500 years is spoken of as almost impossible. But a prominent school in France, whose teachings are gaining ground in America, teaches it not to be uncommon for one to reincarnate in the offspring of his own child and thus

be his own grandparent. The teachings fluctuate between these extremes, the most generally accepted in America at present being perhaps that about 500 years elapses between rebirths.

The precise effect of karma also is the subject of much discussion, some leaders of the old school holding that the evil wrought in one life returns only in a general way in a future life, while many of the newer teachers insist on a specific reaction of the good or evil—that a murderer will be murdered in a future life by his former victim, etc.

In addition to this indefiniteness, which makes plausible explanations easy because almost anything may happen in so wide a range of possibilities, there are woven about these doctrines, by the morbid imaginations of semi-lucid mystics who pose as teachers and thus find their way into print, such fantastic fabrics of illusion as were never dreamed of by that most erudite founder of Theosophy, H.P. Blavatsky, who was instrumental in introducing reincarnation to the West. Lacking definite information concerning the theories they are taught, the minds of many students become filled with hazy and ill-defined notions. Such phantasy thinking conduces to a negativeness in which they become unwittingly easily influenced by unseen malign forces.

Because it has received so much publicity, the investigator, at the beginning of his studies is usually impressed with the idea that reincarnation is accepted unquestionably by all occultists at the present day who have progressed far along the path, and that it has been the universal belief of all notable reformers, philosophers, and initiates of the past.

As a single example, from innumerable instances that might be cited, of the method by which the beginner in occult studies is impressed that everyone, not only of the present day, but also in the past, who has been noted for wisdom has embraced the doctrine of human reincarnation, it is commonly and stoutly asserted that the doctrine is taught in the Bible, and by the Master, Jesus.

Now it is a current saying, based on the controversies of some two hundred Christian Sects, that anything can be proved upon Biblical authority. But to believe that a considerable part of the earth's inhabitants have studied the Bible for nineteen hundred years without discerning that human reincarnation is one of its fundamental and important teachings, if that teaching is really there, oversteps the bounds of average credulity.

It is cited commonly, in support of the contention that reincarnation is taught in the Bible, that Jesus answered Nicodemus—John 3:3—saying:

“3. Verily, verily, I say unto thee, Except a man be born again, he cannot see the kingdom of God.”

Those who quote this in favor of the doctrine of human reincarnation fail, however, to mention the verses that follow this answer:

“4. Nicodemus saith unto Him, How can a man be born when he is old? Can he enter the second time into his mother's womb, and be born?

“5. Jesus answered, Verily, verily, I say unto thee, Except a man be born of water and

of the Spirit, he cannot enter into the kingdom of God.

“6. That which is born of the flesh is flesh; and that which is born of the spirit is spirit.

“7. Marvel not that I say unto thee, Ye must be born again.

“8. The wind bloweth where it listeth, and thou hearest the sound thereof, but canst not tell whence it cometh, and whither it goeth: so is every one that is born of the Spirit.”

Jesus tells Nicodemus, as plainly as possible, that he must have a spiritual birth. Certainly He could not be explaining the doctrine of human reincarnation in such language. And if He even believed in it He certainly failed in his mission as a teacher. He made his doctrines of Love your Neighbor, and Do unto others as You would have them Do unto You, so plain that they were understood by the most ignorant and by the most innocent, as well as by the learned. But if He had ideas on human reincarnation He expressed them so poorly that the greatest scholars in the world during nineteen hundred years failed to discover them.

Another attempt to warp a plain Biblical statement into such form that it appears to uphold a pernicious doctrine is the citation in regard to the transfiguration in Math. 17:12,13:

But I say unto you, that Elias is come already, and they knew him not, but have done unto him whatsoever they listed. Likewise also shall the Son of Man suffer of them.

Then the disciples understood that he spake unto them of John the Baptist.

The obvious thought here conveyed is that John the Baptist carried out the ideas of Elias; for Elias and Moses appeared at the transfiguration talking to Jesus. Yet if Elias had incarnated as John the Baptist, he would now be John the Baptist, and no longer be Elias or appear as Elias. John the Baptist had already been beheaded; and if Elias and John the Baptist were one, John the Baptist being the last incarnation would have appeared at the transfiguration, not as Elias, but as John. As Elias, according to the narrative, was the one to appear, that is proof positive that Elias retained his individuality as Elias and had not reincarnated as John.

As a matter of fact, the personal investigations of an increasing number of Western Initiates, including the author and many others who have undergone special training necessary for such research, all go to disprove the theory of human reincarnation. At no time in its history has The Brotherhood of Light held to this doctrine. Further, among the independent thinkers scattered over the West—those astrologers, psychics, and occultists who do not bow to statements based merely upon authority—there is a rapidly diminishing number adhering to it. Even in India, the home of its birth, it is far from a universal belief, and is stoutly denied by many learned Hindu Initiates.

It should be borne in mind that there is a vast difference between the doctrine of reincarnation and that of human reincarnation. Reincarnation as applied to the soul in its evolution through various progressive forms from mineral up to man, has been almost a universal tenet in the occult schools, and reference to it may be found in the

sacred and philosophical writings of all ages. From this fact confusion has arisen; for the human reincarnation school has construed every reference to reincarnation made by any writer of consequence to mean human reincarnation, which is an entirely different doctrine, and strenuously denied by Western Initiates.

Human reincarnation implies that once incarnated as man and gaining self-consciousness in the human state, the soul must repeatedly return and animate other human bodies. Most ancient schools of occultism, including The Brotherhood of Light, believe in reincarnation through various progressive species, but they deny the doctrine of human reincarnation.

That it is not taught by Western Initiates is evidenced by the writings of H. P. Blavatsky who introduced human reincarnation to America. According to her own testimony, "I first worked under the Egyptian part of the African section and later under the Indian section."

While writing *Isis Unveiled* she worked largely under the direction of Western Initiates, and in various places in the original edition of that work stoutly denies human reincarnation. *Isis Unveiled*, Vol. I, p. 351, reads:

Reincarnation, i.e., the appearance of the same individual, or rather his astral monad, twice on the same planet, is not a rule in nature; it is an exception, like the teratological phenomena of a two-headed infant.

Again, she says that when it does occur the designs of nature have been interfered with and she must make another effort, but—

If reason has been so far developed as to become active and discriminative, there is no reincarnation on this earth, for the three parts of the triune man have been united together, and he is capable of running the race.

Those are precisely the views held by Western Initiates and it was not until removing her headquarters to India and coming directly in contact with Hindu teachers that H.P.B. finally accepted the doctrine of human reincarnation. Ample testimony of this is to be found in *Old Diary Leaves*, by H. C. Olcott, President-founder of the Theosophical Society, who was the constant companion and co-worker of H.P.B. during the time she was writing *Isis Unveiled*. Mr. Olcott says:

I believe she wrote then as she did later, exactly according to her lights, and that she was just as sincere in denying reincarnation in 1876—1878 as she was in affirming it after 1882. H.P.B. revisited Simla without me in 1881, and the two friends above mentioned (Mr. Sinnett and Mr. A. C. Hume) received in due time from the Masters the Reincarnation theory. Mr. Sinnett expounded it in Fragments No. 4 (Theosophist, Vol. IV, No. 1, October, 1882), where he laid the basis of the doctrine of Terrestrial Reincarnation.

This was seven years after the founding of the Theosophical Society and six years after the date of Mr. Olcott's conversation in New York with a Mahatma, in which reincarnation was convincingly denied. I do not doubt, therefore, that H.P.B. was

sincere; for while working under the Western Initiates she denied reincarnation, but after her removal to India her mediumistic nature, which was remarkably pronounced, absorbed and became enamored with the doctrine by which she then was environed. The dogmas of her later associates, whose minds had been trained for magic, invaded her mentality despite her previous training.

Returning to the occult student's first impressions; he is informed that a large portion of the globe's inhabitants believe in human reincarnation. This is sadly true, even as in Galileo's day most of the people, including the learned, believed the world flat. In fact, the multitude in times past have mostly been outrageously wrong. And there is no assurance that at the present day they constitute a competent jury to pass a verdict upon truth.

Neither is it wise to place reliance upon the claims to knowledge of others; for history is a chronicle of mistaken authority. The only safe plan is to keep the mind open until such time as one can evolve the necessary faculties to prove truth at first hand, keeping in mind that the mediumistic tendencies of the human race are such that whatever political, religious, or moral ideas are held by a few dominant minds are usually accepted by the rest without criticism or analysis. Thus nations are subject to waves for war, for peace, for reform, and for various other things, and few stop to consider how they are carried along on the mental tide without adequate reason. They are possessed of a new set of ideas, often made plausible by the flimsiest arguments, that instantly blot out their former convictions.

Such an argument in favor of reincarnation is the appeal to the principle of justice, a principle firmly seated within the human breast. Man is reluctant to believe the Creator unjust, and ardently seeks some method of reconciling the apparent injustices perpetrated by nature. At first glance human reincarnation seems to solve the problem of these inequalities of life. But a closer scrutiny reveals that it has completely failed to give a reasonable solution as does a belief in the whims and caprices of the Jewish Jehovah.

In the first place, if we use these inequalities as material for argument, their value must be ascertained. If they possess real value the inequalities are real, but if their value is indeterminate, so also must be the inequalities.

Now the materialist stoutly affirms that health, wealth, honor, intellect, etc., which form the apparent inequalities of life, are of real value. The occultist, on the other hand, maintains that the real man is spiritual and immortal, that external experiences have no value in themselves, but are the means through which real values for the soul may be created. That is, an experience may be made the means of spiritual progress, but this value lies not in the experience, but in the soul's attitude toward it. Consequently, as even the worst calamities may be made a means of soul progression, these also may be made valuable.

Thus it is a matter of common observation that hardships, trials, and sorrows are more readily turned into values of progress than the so-called good fortunes. Few ever turn their faces toward the rising sun of spirituality until they have drained the

cup of adversity to the dregs. The successful man, all too often, is too absorbed by business cares, the wealthy woman by social ambitions or pleasures, the man of science in his work, to care for higher things. And so, not infrequently, those materially fortunate are spiritually cursed.

If we admit that events in themselves possess value we should incline to the view that the severest and most painful experiences have the greatest value, and that the Scriptures are correct in implying that whomsoever the Lord loveth He chastiseth. From this viewpoint we are compelled to draw the conclusion that material advantages are the worst punishment inflicted by divine justice; for scarcely shall a rich man enter into the kingdom of heaven. This completely reverses the popular conception of karma, and would indicate that the prosperous man is now paying by his prosperity for some heinous crime committed in a past life.

But with Socrates, Epicretus, Aurelius, and a host of other thinkers, I am unwilling to admit the value of events in themselves. I hold that good may be derived from any event of life by utilizing it for progress, in which case the value lies not in the event, but in the soul's attitude. So, what is used by one soul for progress is by another permitted to become a hindrance, no two probably needing the same experiences to develop their latent possibilities, nor would they make the same progress under the same circumstances. Let us not forget that the spiritual geniuses of the past have had their soul powers forged in the furnace of material affliction. To them adversity proved a great blessing. From this it might be thought that for good deeds one should be rewarded in the next life by the direst of circumstances and be made the subject of severest persecutions. But all souls might not respond alike to such vigorous treatment. No doubt there are some weak ones who need the tender hot-house care of material blessings, though these seem at a disadvantage and seldom make a thrifty spiritual growth.

Viewed from the physical plane, we now see that the good consists of material and objective advantages, but that viewed from the plane of spirit the good consists of such subjective and spiritual advantages as are usually found in deadly conflict with advantages material. These two ideas of good antagonize. One cannot at the same time worship God and Mammon. They are just as opposite as the sun viewed from the earth, and the earth viewed from the sun. As a consequence of this dual viewpoint, the spiritual philosopher might accuse the Creator of injustice if he were born in easy circumstances, while the materialist might bewail his fate if born in humble surroundings. From this it must be plain that the popular conception of Karmic Law—reward and punishment meted out in terms of material advantages—is purely and completely a materialistic doctrine.

Returning now to a logical standpoint: All must admit that viewing it from the angle of soul progression we are unable to say, in any particular case, which are the good events and which the evil; for an event that is utilized by one soul may prove a hindrance to another. An event at one period of life may produce an opposite effect than if experienced at a different time. It will be seen, then, that any just system of reward must be based upon the momentary needs of the soul. And who shall say, at

any given time, what experiences will advance the soul furthest in the long run and help it evolve its latent attributes? The experiences of life meet the transitory and constantly shifting requirements of the soul, but the apparent inequalities of this life—which of itself is but the tick of the second hand on the watch timing the soul's infinite flight—these inequalities, I affirm, are indeterminate.

Another purely materialistic conception is the idea that nowhere in the vastness of the boundless universe can justice be meted out except on this speck of dust called earth. Millions of worlds crowd space, larger and grander than ours; electromagnetic, astral, and spiritual worlds, as well as those material. Planes interpenetrate planes, all swarming with intelligent life. The world of matter is concrete to our physical senses, but not so in reality. The electrons of matter are comparable—relative to their size in proportion to their distances—to the planets of our solar system. Electromagnetic, astral, and spiritual worlds are as real and tangible to the senses of their denizens as is the earth to man. In fact, as is the testimony of the many exalted souls who temporarily freed from the body have visited that glorious realm, the spiritual world is a world of increased consciousness.

So, too, the astral spheres surrounding the earth are fully as actual as the material world. There the sensations of pleasure and pain are far more intense than those in the physical. Then why should the physical world be the only place where man can expiate his errors? The experiences of seers, prophets, and initiates testify that in the spheres interior to the physical man has every opportunity for atonement and purification, and every facility for progress. That the doctrine of Karma as taught finds a following at all seems to me to be due to the difficulty many have, even as they cannot imagine a country with different customs, of conceiving any reality beyond their immediate experience.

Then again, a system of morals based upon doing good for reward, either in this life or the next, is at heart a system of selfishness. And to hold that the earth is the only place where divine justice can be administered is materialistic. Yes! It is worse than materialistic; for materialism at least offers the encouragement of oblivion after death. But human reincarnation blights all hope by dooming to innumerable lives—with all their agonies and heartaches, amid worldly conditions that already have become to the pure in heart a hell of avarice, selfishness, sensuality, and carnal desire—in human form.

What, then, may we consider the cause of the apparent inequalities of life? They are the result of the quality and nature of each soul harmonizing with or antagonizing its environment.

It attracts to itself an environment corresponding in vibratory rate to the thought-cells present in the astral body with which it has clothed itself. These thought-cells have been organized by its various experiences in lower forms of life. Experiences of a certain type impress their influence upon the sensitive astral form as a definite organization of energy. This organization of energy persists in the astral form when it is attracted to and becomes incarnated in a higher species of life and tends to attract it

to experiences of a similar type. If the experiences have been inharmonious, it tends by vibratory affinity to attract other discordant experiences; but if the experiences were harmonious, it tends to attract other harmonious experiences of the same type.

The soul, in its involution through higher worlds, and its evolution through life-forms from mineral to man, attracted to itself experiences of a given kind because of its original polarity—its original quality of vibration. This original attractive and repellent quality arose at the differentiation of the soul as the result of cosmic need. That is, there was the need for a soul of definite qualities in the universal scheme of things, and this universal need, this void to be filled, through the agency of its angelic parents, gave the soul its basic trend.

The influence of the thought-cells organized by experience is beautifully illustrated in astrology. The planets are not the cause of a person's condition in life. They merely correspond to the thought-cells in his astral form. These thought-cells, and their organization within his finer bodies, are his character. His character, therefore, because of the strong and weak, harmonious and discordant desires of its thought-cells, attracts to him the conditions and events of his life.

To be sure, these conditions and events are shown in the astrological birth chart, but only because a child is not born until its vibrations correspond with the vibratory rates received upon the earth from the planets. After birth the planets send him energies that have an influence upon his actions, just as the weather and other factors of his physical environment also have an influence upon his actions. But it is really the activities of thought-cells within his astral form that attract conditions and events, the positions of the planets, by their stations and aspects, mapping these activities in the astral body. If they are harmonious, they denote prosperity, but if discordant, they signify adversity.

The fortune of a person, then, is the affect of the environment thus attracted reacting upon the character. And a character that is a martyr in one age, in another might be an object of adoration. A tyrant born at an opportune time and place might rise to the throne, while in a different environment might as quickly mount the scaffold.

Human reincarnation would have us believe the martyr suffered torture because of sins in some past life, and the successful tyrant was given the power to scourge him to the flames because of good done in some remote incarnation. But the very good fortune of the tyrant in this life leads to actions, as material fortune often does, that will make him an object of commiseration in the future. I am loath to think the spiritual giants who have left their footprints on the sands of time have endured the suffering which has been their common heritage in expiation of past misdeeds; or that wealthy parasites, living in luxury upon the very heart's blood of the poor, are thus being rewarded for beneficence in ages gone.

Instead, I must adopt the old Hermetic teaching that, even as children on earth have physical parents, so do souls at their differentiation, before their descent into matter, have angelic parents. These angelic parents are not the creators of souls; but by their parenthood offer the conditions for souls to enter the grand cycle of necessity.

Souls, then, are differentiated by angelic parents in response to a definite universal need, and each is sent out to be educated to perform a required function in universal affairs. Its inherent character, persisting potentially from the moment of its differentiated existence as an entity, and determined by the universal need that called it into differentiated existence, endows it with definite attractive and repulsive qualities. Because of this basic polarity which it acquired at the moment of differentiation, during its cyclic journey down through spiritual and astral realms, and then evolving up through various forms from mineral to man, it is attracted more strongly to certain phases of life than to others. It is the qualities thus developed in lower impersonal forms, persisting as thought-cells within the astral body, that tend to attract events and environment of corresponding quality, harmony or discord, when the soul finally incarnates as man.

Now, a little observation will show that the object of Nature in life is diversity of expression, not identical expression. The requirements of universal life need souls of various qualities, even as civilization requires men and women adapted to many trades and professions. All men are not fitted to be artists, or musicians; and it is well that they are not, for the world needs those skilled in mechanics and those who produce food. Neither have souls the same destiny. All are essential in the cosmic scheme, and find their greatest joy in doing their appointed tasks. Blessed are they when they have found their work! And who shall say what is great and what is small in this universal scheme of things, or whom are the important ones? Should the hand criticize the foot for lack of equal dexterity, or the eye be envious of the ear, or the heart feel it has been unjustly treated because it is not given the work of the lungs?

Souls differ as do the trees in the forest, not alone in magnitude, but as to their ultimate goal. Mature trees represent the kind of seed planted plus the environment since planting. A human represents the inherent nature of the soul plus its experiences while involving and while ascending through various forms from mineral up to man. But no environment will make a fir tree grow from an acorn, nor a soul springing from the planetary family of Saturn into an aggressive warrior. Oaks, firs, cedars, and fruit trees, each have an economic value. It would be difficult to say which is of most importance. Each species also differs in the size and quality of individuals. So also souls springing from the same family, state of spiritual life, and degree of emanation, differ one from another. Not only may they have different angelic parents, but their experiences previous to human incarnation may widely differ. Consequently, when they arrive at the human stage of their pilgrimage their educational needs, in order to round out their latent qualifications for universal usefulness, are very different.

The character at birth is the result of the soul's past experiences reacting on its inherent quality, just as the character of a horse or a dog is likewise the result of past incarnations in still lower forms. That a man must have had innumerable human incarnations because he has a brilliant intellect is tantamount to saying a race horse must have had innumerable incarnations as a horse—at times being a wild horse, a farm horse, a dray horse, a buggy horse,—etc. in order to be a race horse. Or must we

say that a setter must have passed incarnations as a mongrel, a terrier, a hound, a coach dog, etc.? Not so! The soul never incarnates in the same species twice. It is ever drawn to a species higher in the scale of evolution. It is a dog but once, and whether a cur or a life-saving New Foundland depends upon its transitory need for experience. A horse will be a horse but once, but whether a plug or a driver will depend upon its incidental polarity, and has nothing whatever to do with its sins or good deeds to other horses in past lives.

Likewise, the soul inhabits the physical form of man but once; and whether as a Bushman or a college professor depends upon its transitory need for expression. Then it passes to a higher form in the scale of evolution, which in this case is a spiritual form. To say that each man needs all possible experiences and all kinds of human lives is to assume that Nature's aim is identity of expression. But Nature's aim, as a glance around must assure us, is specialization. This principle of division of labor and specialization of parts, as well as the development of individualism, is glaringly apparent in all her work.

Nor is the disparity between races of mankind so great as was formerly thought. The science of language has in later years made this plain. Even the Australian Bushman, when given the same educational advantages, is found to rival his European brother in attainment; although, of course, following the law of specialization, each race more readily becomes proficient in certain lines. But among human beings there are not, as among animals and birds and plants, different families, different genera, and different species. All belong to a single species—Homo Sapiens—the various sub-species, or races, being due, as sub-species usually are, to the affect of local environment.

Certainly, the savagery practiced in modern warfare by civilized nations cannot be surpassed by the aborigines of any land. The love of pillage is just as strong in the breasts of our millionaires as in those of the lowly savage. To be sure, the average savage follows a stricter code of morals than that to be found in our populous centers of civilization. And it should be remembered that intellect is no mark of spirituality; for the intellectual geniuses have all too often been the scourges of mankind.

At first glance it would seem that the savage labored under a great disadvantage; but when we consider that responsibility can only be measured by opportunity, and that the savage usually makes as much of his opportunities as the civilized man, if not more, it alters our conception. For karma, if just, must deal lightly with those who err through ignorance, while punishing severely those who know the right and deliberately forsake it for the wrong. Yet where knowledge of spiritual things is concerned, the savage usually has the best of it; for living close to Nature he draws from her the knowledge of a spiritual life and frequently communes with the dead, while civilized man, having his inner senses blunted by artificial living, scoffs at all his dollars cannot buy.

The savage, therefore, when he passes to the life after physical death will have but a few foolish notions and fetishes to forget. But the civilized man will be encumbered

by a thousand false scientific and religious teachings, as well as the fetish of his egotism. He usually is so sure nothing can lie beyond his preconceptions that he will free himself from them only with great difficulty.

But what narrow vision is it that would single out from the illimitable chain of existences that forms the cycle of the soul, this particular link of destiny as the only one needing consideration in the light of divine justice? Is the horse that is whipped, or the dog that is starved and beaten, or the deer wounded in the chase, so tortured because of sins committed in the past? If we look about us we find that suffering is Nature's means of furthering evolution; for suffering is the common heritage of life as we observe it. The rose grows thorns and the cactus develops spines to escape the pain inflicted by foraging beasts. Man builds a new machine to escape the suffering of arduous toil. We all have suffered in the lower kingdoms. To single out what a man suffers here, or what he gains here, from what he has gained in the past, and what lies before him in the superb vistas of the future, is to try to judge the size and splendor of a mountain range by looking at a single pebble.

Those who die young grow to maturity and are given all the opportunities for progress in the astral world. The mission of external life is to develop self-consciousness, and that once attained there is ample opportunity in higher spheres for further development. Whatever is necessary for the development and culture of man can be found there. A savage or a child can be taught there quite as readily as here.

It may be asked, then, of what use is external life if its lessons can be learned elsewhere. It is a necessary experience for the realization of self-consciousness. But even as an animal species is one link in the evolutionary chain, and the soul incarnating in it passes at death to the next higher form regardless of whether it lived in Africa or America, whether it lived a few days, or for years, or whether it was permitted all the experiences common to the species or not; so man at death passes on in his evolution, even though on earth much restricted. And he will find, to recompense him for loss of opportunity on earth, other advantages on the next plane.

If a man's miseries are due to karma resulting from sin, in his first incarnation when he had no evil karma he must have had all opportunities, all happiness, all blessings. It is surprising under such conditions that he should ever have sinned and brought the vengeance of suffering upon his head. Apparently everyone is sinking deeper in the mire of sin, for suffering is everywhere prevalent. And if we could not escape sin when we were free from malignant karma, how can we expect to live blameless lives with the weight of it now like millstones about our necks?

If we explain human suffering and lack of opportunity by referring it to the just action of karma, we are then called upon to explain the justice of the equally great suffering and inequalities of the animal world. When man is born into human form the first time he has had no moral karma, for like the animals he has been previously irresponsible. But animals suffer in spite of their lack of karma, and animals of the same species have unequal opportunities. It is only when man attains

self-consciousness and becomes morally responsible that he can make good or evil karma. Therefore, as in his first appearance on earth he had previously been an irresponsible agent, he could have had no evil karma. His condition then must have been determined by something besides karma. What this is that determined man's condition in his first incarnation reincarnationists do not tell us. But certainly it is preposterous to suppose that all men in their first incarnation are born with the same or equal characters and opportunities, in equal environments, and undergo equal suffering. Nowhere in Nature do we observe any such equal condition. Is it not more probable then, that the same factors that determine an animal's condition of life also determined man's?

Even could it be shown that all people in their first incarnation had equal opportunities and equal happiness, there would yet remain to be explained the great injustice that gives to one person a character at his first human incarnation—before the intervention of karma—that enables him to triumph over evil and avoid generating much evil karma; while giving to another a weak and feeble character that has not the power to resist evil, and thus accumulates a terrific karmic burden. Before the intervention of this karma the individual could not have been responsible for the kind of character he possessed. But if characters were equal and opportunities were equal, experiences would be equal, and we would not witness the apparent inequalities that we daily observe. So, after all, that a soul is endowed with a weak character before attaining responsibility would seem as great an injustice as that of being given poor opportunities.

The justice of difference in character which, to account for the differences to be observed in lives, must be admitted if it be held that advantages are meted out justly, can only be explained by the obvious fact that there is need for various kinds of souls who undergo different experiences. Karma plays no part as a moral agent until moral responsibility is attained. Man is ushered into life once without such karma, then, and subject to the very inequalities karma was invented to explain. Numerous lives only increase the suffering, for suffering is common to physical life, none being entirely free from it. Karma serves no real purpose and removes the hope of being free from this suffering to a remote future. To justify the suffering of one life, reincarnationists have substituted equally unjust suffering through many hundred lives. Unjust, because in nearly all cases the one punished is entirely ignorant of why he is suffering. It is as if a man were to whip a grown dog for offenses committed when he was a puppy.

Karma has no power to force man back upon earth. Nature does not reverse her operations. The soul on the ascending arc of evolution cannot reincarnate in a lower form, nor can it thwart the purpose of the life-wave by repeatedly reincarnating in any one species of life. The life-wave carries man irresistibly to the next stage, which is above the physical. Karma really embraces the astral organizations which we have built into our astral bodies previous to and during earthly life. These, by the law of magnetic affinity, after death attract us to conditions corresponding to their vibratory rates and compel us to work out our redemption from evil face to face with the motive

prompting every earthly deed, with conscience presiding as the judge.

The factors that determine man's condition in life when born into human form, are the original polarity of the soul, plus the various thought-cells organized in the astral form through his experiences in the lower forms of life through which he has evolved. His condition at any time during human life is determined by the organizations of energy in his astral form at birth, plus those added by the various thoughts and deeds up to the time considered. Likewise, his condition immediately after death is determined by the thought-cells organized in his astral body up to the time of death. As morality or lack of it is most effective during human life in power to give these thought-cells special desires, atonement is not a matter of vengeance. It is a purification preparatory to a higher phase of life in which, if there is suffering, there is full knowledge of what caused it. We find, therefore, that human reincarnation as usually taught is illogical, unjust, purely speculative, hope destroying, and completely materialistic.

It is an orthodox teaching of the Orient; and orthodox beliefs of both East and West were formulated in a period when men knew almost nothing about how Nature operates. How Nature is actually observed to perform, the Universal Law of Compensation, and the true significance of pleasure and pain are explained in Course 19, *Organic Alchemy*.

Chapter 8

Serial No. 21
Original Copyright 1928
Elbert Benjamine

Copyright
Church of Light
August 2002

Facts and Fancies about Reincarnation

Part 2

Chapter 8

Facts and Fancies About Reincarnation, Part 2

ALL the evidence put forward as proof of human reincarnation, insofar as it has come to my attention, is, I feel confident, but a misinterpretation of actual facts. I have no occasion to question the honesty of the witnesses. They without doubt report what is seen and what is felt as it seems to them. But as these experiences are invariably of a psychic nature, they must be interpreted in the light of what is known to be the conditions imposed upon psychically received information. When so interpreted they prove, not human reincarnation, but certain laws governing psychic phenomena.

As an example from many: An elderly lady and her companion were traveling through the state of Minnesota when the engine broke down and the train could not move for several hours. Although she had never been in the state before, she felt an intimate sense of familiarity with her environment. Looking out of the window she saw a large old house, and as she looked she felt she had at one time lived in it. So familiar with it did she feel that she described the interior arrangement of the rooms and other details to her companion. Finding that the train would not move for some time, they left it and went to the house and asked permission to go through it. Everything was arranged just as described.

Subsequently, this lady came in touch with the doctrine of human reincarnation. On the strength of her experience she grasped the doctrine readily and lost no opportunity to tell her story as a verification of it, stoutly affirming she remembered living in the house in a previous incarnation. Finally, a friend took the trouble to look up the history of the section where the house was located, and found that it had been settled at a date much later than the lady's birth, and that there had been no houses in that section previous to a time when the lady who had the experience was full grown in the present life. Therefore, although familiar with the interior of the house, and feeling sure she had lived in it in a previous life, she could not have done so because the house was not there until long after her present birth.

I could fill a large volume with the experiences of those who feel certain they remember past lives, in which factors are present that when looked up historically have proved beyond any doubt that the experiences as described could not have taken place.

This remembering of past lives is on a par with reading the “akashic records.” It is a similar experience and under the same laws. Therefore, without in any manner wishing to question the sincerity of either, but using them merely as examples with which to illustrate the utter fallibility of psychically received information when it has any bearing upon established religious conviction, I may be pardoned, I hope, for mentioning Dr. Rudolph Steiner and Mr. Leadbeater.

These two men, Dr. Steiner as the head of the Anthroposophical Society and Mr. Leadbeater as a Theosophical leader, together with a lady to be mentioned shortly, are perhaps the most influential exponents of the theory of human reincarnation in the world today. All three are believed by their followers to be gifted with wonderfully accurate psychic powers. Yet these very psychic powers, depended upon to verify the theory of human reincarnation, when actually put to a test which later came within the scope of historical verification failed miserably.

Dr. Steiner, reading the “akashic records” finds the discrepancy between the genealogies of Jesus as given in the gospels of Matthew and Luke is due to the fact that there was not one Jesus but two. The evidence, as summed up by the editor of *The Occult Review*, is:

Surely the obvious and only tenable conclusion we can arrive at is that through some method or other the records of the Zohar found their way into Dr. Steiner’s brain.

In other words, instead of the infallible reading of the “akashic records,” Dr. Steiner was merely reading a tradition embodied in the Zohar, and probably having no basis whatever in fact.

Mr. Leadbeater, through his seership, was able to write the *Lives of Ulysses*, but it has turned out there is reliable historical evidence that his chronology is wrong, and ample evidence that the names he gives to his characters, instead of being read from the “akashic records,” have been taken clairvoyantly or otherwise from a modern writer. In regard to him the editor of *The Occult Review* concludes:

With the latter, however, there is the suggestion or suspicion of tinkering with earlier historical records and putting them in a new setting with a view to establishing or defending certain reincarnationist theories, with which history, by a violent abuse of chronological facts, is made to square. Here, of course, space does not permit of extensive comment, but the writer quoted is notably sympathetic both to human reincarnation and to Theosophy. For a full discussion of the reading of the “akashic records” by Dr. Steiner and Mr. Leadbeater I must refer the reader to “Notes of the Month,” and two articles, all appearing in *The Occult Review* for January, 1923 (Wm. Rider and Son, London).

I might go on to show how another Theosophical leader and world-renowned exponent of human reincarnation, for a long period claimed to remember she had been Cleopatra in a past reincarnation, but has lately decided she was not. I might take up, one by one, the statements of prominent persons regarding their past lives and give these statements the benefit of analysis. But not only is this too much like

criticizing people, but I am convinced that in most cases they are quite sincere in their belief, and that this sincerity springs from actual psychic experiences which have been misinterpreted.

In the first place, due to astral substance inter-penetrating and surrounding all, retaining whatever vibrations are imparted to it, every idea ever held by man and every thought having passed through his mind, persist in the astral. All the world's events of the past have left their impress as vibrations in the astral substance associated with this earth. A person naturally sensitive, or one having cultivated the lucidic senses, who comes into rapport with the astral vibrations recording a past event sees that event as if it were taking place before his eyes. Just as a psychometrist upon touching a letter written by someone years before has all the thoughts and sensations that the person had while writing the letter, so a sensitive person who comes into rapport with an astral record feels as if he were actually witnessing or taking part in the recorded event.

Unfortunately for the infallibility of thus reading the "akashic records," there is always the human equation of the sensitive. Not only will any idea that is strongly dominant in the mind of the sensitive tend to warp the whole reading to support this idea, but a person in the subjective condition usually present while reading the "akashic records" is just in the right condition to be susceptible to suggestion. Just as a hypnotized subject, if told he is king, will carry out the impression to the smallest detail, thinking of a surprising number of things to make it realistic, so a sensitive, if given a single suggestion when in a subjective state, will weave about the central idea wonderful phantasies that all seem to bear a logical relation one to the other.

For instance, it is a common occurrence in our astrological classes, from which no one is barred, for some person in the audience, when a birth chart is placed on the blackboard, to commence telling all about the past life of the individual whose chart is up for discussion. If allowed to do so, half an hour will be consumed in telling the past lives in great detail, and just what events led up to the person being born with the kind of a horoscope he has. The whole thing is painted with a realism that is quite convincing. Now, one would think that a person psychic enough to relate so many details of past lives—about which no tests of accuracy can be made—would also be able to relate a few details about the present life. But when called upon to tell the events of the present life also, there is a strange silence, or else events are given that when the identity of the owner of the birth chart is made known can quickly be proved not to have taken place.

A person giving such a reading from a birth chart is under the influence of suggestion. He is dominated by a central idea—that of reincarnation—and for every discordant aspect he sees in the birth chart his imagination supplies him, quite vividly to be sure, with some sin in a past life. And if his fancy is still further freed under the influence of this self-applied suggestion, he will bring in elementals who are attached to the unfortunate, or the dweller on the threshold, and sundry other things that he feels have become associated with the victim in a past life.

There is also the person, growing in number and popularity, who without a horoscope or other guide than your presence, gives a dramatic recital of one or more of your past lives. Ask him what happened to you a thousand years ago and he will glibly tell you. Ask him what happened yesterday or a year ago and he cannot tell. These people are not dishonest. They believe what they say. But they are no more responsible than if hypnotized by a hypnotist and told by him that they could read the previous lives of persons. In the hypnotic state they would supply the information required whether it exists in actuality or not. As it is, they supply the information required because they have induced a self-hypnotic state while acquiring their lucidity, or psychic ability, and at the same time they have so strongly suggested human reincarnation to themselves while in this state that it has come to exercise a control over all their psychic perceptions; as much so as if the control had been brought about by the suggestion of a hypnotic operator.

But aside from these people who find it so easy to relate events of the past lives, and so difficult to discern those of the present one, there are others who have psychic experiences that are not due to self-hypnosis, yet usually are interpreted as proofs of human reincarnation. In the case related of the lady who felt she had lived in the house and was familiar with all its details, it is unlikely she had ever visited the place while out of her body in sleep. It is more probable that, becoming partially lucid, the condition of rapport was established between herself and the astral counterpart of the house. She really psychometrized the house, and no doubt, if she had tried she could thus have followed the astral record of the house back to the time it was built, and witnessed many scenes in its history. In a similar manner, a psychometrist upon touching a pebble is able to see and feel its history and relate it as if he had been an eye-witness to the geological changes that brought the pebble to its present form and station. He does this through his ability sympathetically to vibrate to the records persisting in the astral substance associated with the object. He feels as if he had been right there at the time the event transpired, and unless familiar with the laws governing psychometry might very well believe he actually witnessed the occurrence in a previous life.

In fact, it is quite natural to consider any psychic experience as an example of a revived memory. Things seen clairvoyantly or in sleep are not seen with the physical eyes, things heard clairaudiently are not heard with the physical ears, and things felt psychometrically are not felt with the physical sense of touch. They are perceived by the corresponding senses of the astral body. These perceptions are recognized by the unconscious mind, and may or may not rise up into the region of objective consciousness. In reality they exist in the unconscious mind precisely as does the memory of a physical experience. They are subject to all the laws of memory. To rise into objective consciousness there must be some association between the psychic experience and some thought already present in the objective mind, unless the person is in the subjective state as when hypnotized or under the control of a disembodied entity, in which case he is perceiving what the operator desires him to perceive. We do not remember past events except when there is a link between what is already present in the objective mind and what we remember. This link of association may be

very slight, but it is none the less present. Neither is a psychic experience recognized to have taken place except there is a similar link of association between it and what is already present in the objective mind.

Unlike objective experiences, which are first recorded in objective consciousness and then imparting vibrations to the soul, reside there as memory, psychic experiences impart vibrations to the unconscious mind first. Later they may or may not, as the case may be, transmit motion to the physical brain in such a manner that the experiences are recognized objectively. If they do so, a psychic experience may be recognized almost at the instant it is experienced. On the other hand, the objective mind may be so occupied with other things that the experience resides in the unconscious a long time before there are lines of association between it and what is in the objective mind strong enough for it to be objectively recognized. But in any case, it first is memory. It is not to be wondered, then, that so frequently what is beheld or felt psychically should seem to be something remembered from the past.

I have spoken only of psychometry in connection with physical things. But there is another form of psychometry that is quite common. Every person who has lived and died has left the record of his experiences in the astral substance associated with this planet. Even as similar positions of the planets in the birth charts of two living persons tend, if the persons are brought together, to establish a close rapport between them, so persons who have lived and died leave a vibratory record in the astral substance that readily is attracted by a living person who has a similar birth chart. That is, by the law of resonance, one is very apt to attract and form the conditions of rapport with the astral record of a person who in life had a similar birth chart. Most persons, not being sensitive enough, are unconscious of such experiences. But one partially or wholly lucid, under these conditions will undergo a semi-transfer of identity, and will live in memory the experiences that the person whose record is thus contacted actually had. They are the actual experiences of a person who lived and died, but they are not the experiences of the psychic in a former life.

Further, the actual experiences of a person while out of the body during sleep reside as memories in the astral brain, and when some line of association is set up that causes some of them to be remembered they are often mistaken for experiences of a past life. During sleep, man's consciousness resides in the astral body, and it is quite common for the astral body to leave the physical body and travel to such regions as its strongest desires attract it to. Thus those interested in certain lines of thought may be attracted during sleep to schools in the astral world where these subjects are taught. Usually these experiences are not remembered on waking, or are greatly distorted in their transmission through the physical brain, although proper training will enable them to be brought back more completely. But in physical life, when confronted with some fact or doctrine or experience, there may be a sudden feeling that it has been encountered before, and that it is all quite familiar. This may be true, but it was not in a past life. It was encountered while out of the body in sleep, in this one. In fact, comparison with the known conditions of the world in the past frequently proves that the knowledge or experience with which one feels thus familiar without having

contacted it physically in this life, could not possibly have been gained in a past life; for the factors involved are of too modern origin.

The facilities for movement and perception are so much greater on the astral plane, that people usually meet there before meeting on the physical plane. Of course, such meetings are seldom remembered on waking. Yet when two persons meet in the physical there may be a feeling they have met before, and it is quite easy to jump to the conclusion that there was friendship or enmity in a past life. As a matter of fact, which a little psychoanalysis will often reveal, they have actually met on the astral plane during sleep.

Geniuses and prodigies also are sometimes cited as indications of human reincarnation. But to one familiar with astrology the fact that they exhibit precocity or unusual ability cannot be related to previous human experiences of their own. They are related to previous human endeavors, it is true, but it is to those recorded in the astral substance surrounding the planet, and to disembodied human beings who have labored along the same lines. That this is the true interpretation, rather than the human reincarnation one, is evident in the fact that in the birth chart of genius those planetary positions are always most pronounced that indicate the ability to contact the inner plane, and draw directly from its records and its inhabitants. In such cases the planet Neptune is always prominent in the chart, giving the sensitiveness of nervous organization that enables them to contact the vibrations from the astral world. This sensitiveness to the astral world gives rise to the temperamental idiosyncrasies of such people. In their highest work they enter into a state of abstraction that partly shuts from their mind the external world. Thus, although they may not be conscious of the source of their inspiration, they come directly into contact with that portion of the astral world, and with discarnate entities, which are sympathetic with the work in hand.

Aptitude for any branch of learning, whether genius is present or not, is indicated by the configurations of the planets in the birth chart. These configurations of the planets map the thought-cells in the astral form at birth. Such thought-cells have been formed by the experiences of the soul previous to birth in human form. They were formed because the original quality of the soul attracted it during the course of its evolution to these experiences, which are necessary to its development, that it may fulfill its own particular function in the cosmic structure. Because there is need of workmen of different types in universal construction, souls differ in original quality, and pass through different experiences. Some, like oaks, grow slowly and thrive in certain environments; others, like the fir, grow swiftly and rejoice in a different atmosphere.

All must admit that the first human incarnation was determined by the original quality of the soul, plus the various experiences which constituted its need for expression when born into human life. To account for the later difference in souls, it is necessary to assume they differed in their first incarnation either in character or in opportunity, or that it is but a matter of more numerous incarnations. If it is but a matter of more numerous incarnations that causes the difference between people,

then we must believe all people are alike, except some are older than others, in which case both effort and karma become useless factors. But if people differed either in character or opportunity in their first human incarnation, then we have an example of a condition not caused by karma just such as karma was invented to explain. In any alternative, the introduction of the theory of karma is redundant.

Neither does heredity alone—the heredity genes of modern science—explain the diverse mental, moral, and physical qualities of children of the same parents. The thoughts and feelings of the parents at the moment of union have a great influence upon the quality of the soul then attracted. A child born from a love union is very different from one born from a union of the same parents in which one at the time was actuated by inflamed passion and the other was filled with loathing and disgust. Such differences in children, as well as the contributing factors, are revealed by their birth charts, but it has nothing whatever to do with human reincarnation.

Nor is the observation that certain types of intelligence and character recur at given intervals indicative of human reincarnation. One might as well say that all persons born between March 22nd and April 21st are reincarnated Romans, because they exhibit war-like tendencies.

At regular intervals certain planetary configurations recur. The most perfect of these cycles is called the Neros. Thus about every 600 years the sun, moon, and naked-eye planets occupy the same relative positions. It is possible, then, for persons to be born with birth charts practically the same as others who lived 600 years before. Of course, the plane from which the mental forces are received, ruled by the precessional cycle during which the equinox is about 2,156 years in each sign, and the avenue into which the efforts will be directed, ruled by planetary sections of about 308 years, will be different. But in a general way, it is quite possible for characters and history apparently to repeat. Yet, if the same players do appear time after time on the stage of life to act the same parts, they have failed to profit by former mistakes and are making no progress. They are going round and round, like squirrels in a cage, without getting anywhere. It is from this wheel of material rebirth that the Oriental devotee seeks to free himself and enter nirvana, another realm in which there is no progress, and, most pleasing to the Oriental mind, no effort.

But in all Nature, I defy anyone to point out one single instance of such stagnation. Eternal Progression is the anthem of creative life, applicable alike to material atoms, to human souls, to planets and starry systems, and to angelic hierarchies. All Nature moves in a spiral. The life-wave carries the soul irresistibly upward. It cannot stop, it cannot retrace its steps. Souls may appear to be going backward, even as planets appear to retrograde, but when viewed from a greater height, neither soul nor planet in reality is retrogressive. The utmost that might be accomplished toward thwarting Nature's purpose of eternal progression would be through defiance of her laws to bring about self-destruction. Such, according to an old tradition, is the fate of self-willed black magicians.

Nature's capacity is not so limited that she need force man back again to earth for

experience. Nor need she pass all souls through the same experiences, nor give one soul the same experience again. Her resources are boundless, and she ever seeks variety in her expression. No two souls are being fitted for the same place in cosmic work, and as a consequence no two souls have exactly the same experience. To one who has the eye to see Nature about him, how clearly she strives for diversity!

Now there is a peculiar thing about those who believe they remember their former lives. Ninety-nine percent of them, at least, remember when they were celebrities of some sort. Apparently numerous incarnations have helped them not at all; for they are now mediocre. Indeed, they seem to have retrogressed.

I have met reincarnated Napoleons who knew nothing of military tactics. I have met great philosophers of the past who in the present life are confined in thought to the narrowest sectarianism. Those who were once high priests of Egypt, now know nothing of the ancient mysteries. An authoress of considerable note remembers when she was Mary Magdalene, but is quite ignorant of certain customs of the time, and in a later book expresses doubt if there ever was such a person as Jesus.

Another peculiar thing about these revived memories is that a soul in reincarnating seems capable of much division. The general favorites are: Napoleon, Joan of Arc, Daniel of lion den fame, and Alexander the Great. There are others almost as popular, but in almost any community of size where reincarnation is much taught, there will be found one or more of each of these. Several of each walk the streets of Los Angeles.

I believe there are two distinct reasons why usually, though not always, past incarnations that are remembered are those of important personages. The first reason is egotism combined with autosuggestion. In all of us is the latent desire to be heroic. We desire to be someone of note. In remembering past incarnations a person is in a psychic condition, and the unconscious desire to be someone great acts as a suggestion to the imagination, which fulfills the expectation by bringing into consciousness such apparent memories. The same factors operate in the case of the more ignorant and less progressive spirit mediums, who feel sure they are controlled only by great personages, or even by the Master Jesus Himself.

The other reason is that those who have been notable persons in the past have had potent minds or have lived strenuous lives, and thus have left a more powerful record in the astral substance surrounding the planet. The vibrations they have left are therefore more easily contacted, and it is quite natural that a person who is partially lucid should get into rapport with these astral records of notable persons and thus remember them, rather than that they should contact the records left by less potent people.

I have watched with considerable interest the kindly effort of reincarnationist friends to read my own past lives. On one occasion, when I had been studying Egyptian matters, and felt I had contacted Egyptian teachers, I was given much information concerning my Egyptian incarnations. On another occasion, after studying along an entirely different line, I was told of incarnations that seemed to dovetail with the

nature of my researches. Other lines of thought on my part brought to light other incarnations. Except in Egyptian matters, in which they know there is a permanent interest, my friends were unaware on these occasions what I had been studying. Apart from the fact that some of these various incarnations overlap, thus making some of them at least impossible, I have reason to believe that my studies had attracted to me records, and also entities, and that these well intentioned friends had given me a psychometric reading of what I had attracted.

Having now, I trust, shown that the various evidences put forward as proof of human reincarnation are in reality misinterpretations of psychic phenomena and thus capable of a better explanation, it is time to inquire how and why the doctrine came to be so widely accepted. Certainly it is not an occult doctrine, for occult doctrines and esoteric teachings in the past were reserved for the initiated few. The seething masses were ever fed the husks of truth. And about human reincarnation there has been no secrecy at any time. It was proclaimed from the housetops. It is a sacerdotal dogma.

As such it was put forward by the priesthood of the Orient for the very same purpose that other dogmas have been foisted upon the public by the priesthood of the West.

This is not a tirade against the teaching of any great soul or Master, but merely a rehearsal of the usual fate of a truly spiritual doctrine. The teaching is given out by some inspired teacher as a message then most needful. It attracts a following and gains in impetus. But as its influence spreads it attracts to it a dominant priesthood, or is appropriated by the priesthood already in power. The priesthood have ever held it to be their prerogative to be the custodians of the mysteries. And for a time they may be unselfish in their enthusiasm. But the time comes when they or their descendants find the temporal power and advantage of their position is of greater importance to them than keeping their doctrines pure. Consequently, to keep in power and to obtain subservience from the masses, such dogmas are formulated and incorporated into their creeds as they think will best serve this end. Finally, the real spiritual ideas are lost to the priesthood, and the whole religious system becomes a machine to further their own material ambitions.

Of course, people under the yoke of oppression and surrounded by injustice, have a tendency to rebel. So it becomes the aim of the priesthood to formulate and teach some doctrine that will make the populace content in their misery.

One common device to this end is the teaching that the priest is the sole interpreter of the divine will, and that the ruling power—usually hand in glove with the priesthood—is appointed by Deity, and therefore to rebel against him is to rebel against Deity. In Japan, the Mikado is a direct descendant from the sun, and his word is the word of Deity. The chief hierophant of the Buddhist Church, the Taley Lama, is said to be a reincarnation of Buddha. He is, therefore, quite as infallible as the Pope in Rome. We in the West also have the divine right of kings to rule, and “the King can do no wrong.” These doctrines when believed by the populace make it possible for king and priest to live in luxury, while the people live in abject poverty.

More potent still as a doctrine to keep the populace in subjugation, is the teaching that

obedience to priest and ruling authority will bring rewards after death, and that rebellion against them, will bring after death punishment. The Japanese soldier fights fearlessly and dies willingly for his ruler, because he believes that such a death brings the greatest possible rewards in the “beyond.” Moslemism carries this idea to its psychological climax. It pictures alluring females, pillage and rich plunder, ease and pleasure, for the brave soldier who gives his life for his faith—that his ruler may live in luxury and power. That which the ruler has in this life is promised as a reward after death to those who faithfully serve him here.

In Christendom there has been injected into one of the finest teachings ever given to man an element that appeals to the most selfish instincts. We have here, instead of the original many mansions in “my Father’s home,” a heaven of gold and power and music as a reward for those who obey priestly dictates. And for those who deny the priestly interpretation we have the burning pits of hell. But, in addition, we also have another dogma resting on no greater authority likewise than its appeal as a psychological factor. It is vicarious atonement. It is the alluring appeal used by confidence men the world over: to get something for nothing. “Believe and be saved,” instead of “do and be saved.”

In the West every step civilization has taken has been opposed by the priesthood. Realizing that every discovery of science is a blow to their power, for an enlightened people will not stand oppression, they have done their utmost to impede progress. Thus it is that even today many scientific facts are loudly denounced, because they conflict with religious dogmas. Death bed conversions still promise salvation; and still the priesthood reap a rich material reward from those who would buy their way into heaven.

Yet, for keeping a populace servile and preventing discontent and insurrection, no other doctrine ever formulated has been so successful as the dogma of karma and human reincarnation.

The Caste System is the natural and obvious result of a belief in human reincarnation. Thus it is said in reincarnation countries that woman incurs the penalty of being born into female form because of sins previously committed, otherwise she had been born a man. And to treat a woman with respect is to interfere with karma and consequently be in danger of creating bad karma for oneself. So strong is this feeling, that in some places a man will not rescue his mother from drowning if to do so he must touch her. Karma permits him to extend a pole to her if one be handy; otherwise, she must drown.

Those born in the highest caste are supposed to have lived extraordinarily good lives to be thus rewarded, and so have a right to lord it over the next lower caste. Those born in the lower castes are supposed to have committed grave offenses in past lives, and so merit all the misery they endure. Thus it would be as unjust to alleviate their suffering as it would be to permit a criminal to escape the sentence imposed on him by legal authority. Furthermore, the lower castes, believing their sufferings but their just dues, permit the upper castes to prey upon and oppress them; for to retaliate

would make more evil karma.

Of course the priests, as sole interpreters of the Deific will, retain the authority to say just what actions incur good karma and just what actions incur evil karma. Consequently, by teaching that evil karma results from the actions they oppose, and that good karma results from the actions they commend, they have a lever by which they can cause the populace at all times to do their will.

It is true that ideas reincarnate. In this sense reincarnation is a fact; but human reincarnation is an inversion of this reality. The thought of some man of faith and vision is contacted by other men who carry out the original idea even though the one who first thought it has passed on. Great ideas thus reincarnate time after time. Further, a Hermetic tradition holds that there are certain exceptions that prove the rule. Still-born children and congenital idiots, it is taught, having actually never fully incarnated in human form, may reincarnate.

Karma, too, has an actual part to play in existence; but in a very different manner from that taught by human reincarnationists. These base their doctrine on two ideas that are fast becoming obsolete in all civilized countries. One is the old Jewish code of an eye for an eye and a tooth for a tooth. Criminal punishment, to be sure, up to the present time the world over, has been based largely upon vengeance. Because the criminal had violated a man-made code, it was proposed to make him suffer. A few hundred years ago in the most advanced countries even a petty theft was punished with long imprisonment or death. Later it was recognized that the punishment should be commensurate with the seriousness of the crime. And this seems to be the idea of the reincarnationists as applied to karma.

But it is fast coming to be recognized that people commit crimes, and that people sin, for one reason only, and that is through ignorance. Had the criminal a full realization of the manner in which his acts against society react on his own character, had he the vision to see the full consequence of his misdirected energy, he would commit no crime. In fact, crime more often than not arises from the entirely false notion that one person may truly gain at the expense of another. Otherwise it arises through lack of self control, which again is ignorance; the ignorance of how properly to control the thoughts and actions.

Society is beginning to recognize this, and as a result we hear less about punishment. The idea of vengeance, or even of payment to society for transgressions, is gradually being abandoned and in its place we hear more about reeducation. Instead of punishing criminals, of getting even with them, they are merely restrained, and this for the protection of society. When it is deemed they no longer are a menace to society, that they have been reeducated to a point where they will not endanger others, it is more and more the practice to parole or pardon them.

Neither do I find Nature seeking vengeance. Those who transgress her laws, it is true, suffer. But when they gain sufficient insight that they obey her laws, suffering no longer serves a purpose. Primitive man no doubt suffered with the cold, but when he learned how to start and maintain a fire his need to suffer with the cold was less; for he

had learned how to adapt himself to an environmental influence. So also, now that man has arrived at the stage of his evolution where efforts for the welfare of others are the prime necessity for further progress, such efforts adapting him to present and future environmental influence, he needs no further punishment for transgression. Instead, he needs to be taught the advantage of working persistently for the advancement of all.

The other obsolete idea is that the important adjustments in Nature are the result of the intervention of superphysical intelligences. It was once thought that volcanoes only erupted when the god in the mountain was angry. And now we have the Lords of Karma who seem to be the administrators of karmic law, much as Jehovah was once envisioned on a throne meting out justice here and granting favors there.

There is, as I said, some truth in the idea of karma; for every act and every thought adds energy to the astral body, and these energies, both here and hereafter, determine the environment and events attracted. Furthermore, every act and every thought are recorded in the astral substance about the planet. At death the soul passes through this thought world of its own creation, faces these records, and passes judgment on its own acts. Unless it has built up, by a refined life and unselfish endeavor while still on earth, a dominant spiritual vibratory rate, it will be compelled, through the law of resonance, which supplants gravitation, to live on lower astral levels until by appropriate thoughts and acts it has spiritualized its dominant vibration. Then it will move to a higher inner-plane level. Karma, it will thus be seen, is really the influence of the thought-cells within the finer form as these have been organized by the mental attitude toward experiences. It has no power to force the human soul back to a life upon the earth.

Fearing that the truth about these things may be learned by the people, and thus upset priestly assumption to knowledge by revealing a conscious progressive life after death instead of either human reincarnation or a dreamy and purposeless nirvana, the priesthood of the East have endeavored to discourage investigation by formulating the doctrine of “shells,” warning against elementaries, and attributing all communications from loved ones who have passed on to depraved earth-bound spirits. In the West, that their pretensions to knowledge might not be shown to rest on ignorance, the priesthood have quite as strenuously opposed investigation of the life after physical death, attributing all communications from the “beyond” to devils.

As a further example of priestly machination, we learn from *The Inner Life*, by Leadbeater, that the head of the Eastern hierarchy is one of the few remaining Lords of the Flame who came down from Venus nearly eighteen million years ago, and that the two masters who inaugurated the T. S. will become the temporal as well as the spiritual leaders of the Sixth root race. It is plain what power would be placed in the hands of the priests, were these doctrines widely accepted. And from the effort made to pave the way I should not be surprised if an attempt soon were made to palm off on the West a fake avatar (this was written and published December, 1917).

For earnest Theosophical students the world over I have the utmost love and respect.

But this Eastern hierarchy proclaims that the one thing that the West most needs is the teaching of reincarnation and karma. Yet such a belief devitalizes effort and causes social evils to be considered as just and inevitable. Instead, it seems to me, the West and East alike need the teaching that where man wills, the gods themselves are powerless. Inharmonies of some kind will exist as long as the planets form inharmonious aspects, but the discord need not manifest in its present manner. By wise education abolish the injustice of man to man, by wise attention to hygiene, dispose of sickness, do away with the evils of poverty and wealth, and Fate and Karma, aided by all the planets in the sky, are powerless to reproduce them. We need no teaching of servility to evil and injustice. What is needed is the teaching of man's divine birthright.

Heartsick, I have listened to professed teachers of occultism seriously inform their classes that owing to present world conditions, it would be impossible for them to develop their inner faculties in this life, and that all they could hope to do would be to try to bring back a consciousness in the next, that would spur them to such effort. What an incentive for souls after death to linger about the earth, bound to it by desire and the false hope of reincarnating! I have known promising occultists whose inner consciousness and soul faculties were already partly awakened, to be discouraged by such advice and cease making an effort. People come to our classroom in ill health, and boast they are making no effort to cure their infirmities, because to do so would be to interfere with their karma. And the one thing that causes us more correspondence than any other in the mail-order part of our work is the idea so many people have, that their hard lot in life is due to a just karma, and either that it is not worthwhile trying to change conditions, or that it would not be right to overcome their wretchedness. I know hundreds of people personally and through correspondence, whom the dogmas of karma and human reincarnation have unfitted for useful and efficient lives through inducing negativeness and stifling effort.

Here in the West we have made greater strides in civilization, because we have been able to free ourselves more fully from priestly dogmas. But in the East the dogmas of karma and human reincarnation have such a hold on the people that they have sunk into physical and mental apathy. The condition of the people where these dogmas are accepted proves this to be true.

I have shown, I believe, that all the so-called proofs of human reincarnation rest upon misinterpretations of psychic phenomena. I have indicated the source of its origin to be a crafty priesthood; who continue to use it as their most effective means of keeping in power and commanding servility from the populace.

It blights the hope of a conscious spiritual life by teaching that the earth is the only place where experience may be had, and that the ultimate haven is nirvana. This is essentially a materialistic doctrine, for it narrows the mind to earthly things. It makes universal brotherhood impossible because it teaches each is already receiving his just dues. Thus it quenches the unselfish impulses of the soul to assist others. The soul sinks in despair at the thought of innumerable births to come amid all the sordid surroundings of earthly life. It is a dogma that stifles initiative, makes for servility to

tyrants, is materialistic, and in my opinion, the most pernicious doctrine ever accepted by a human mind.

Human reincarnation is an orthodox teaching of the Orient. Because of modern discoveries, no one any longer believes in the other ideas about Nature held by those who lived in the period when the orthodox beliefs of both East and West were formulated. The workings of God's Great Evolutionary Plan as observed in the operations of Nature, and the Universal Moral Code, are explained in Course 19, *Organic Alchemy*.

Chapter 9

Serial No. 1
Original Copyright 1928
Elbert Benjamine

Copyright
Church of Light
August 2002

The Ritual of Egyptian Initiation

Chapter 9

The Ritual of Egyptian Initiation

THE Western World is fast becoming aware that beneath the allegories and unconvincing verbiage of the sacred books there lies concealed a primitive secret doctrine, that behind apparently meaningless religious usages and pious jugglery there is a substance of sound psychological practice, that even outside the consecrated precincts of the Church—notably in Freemasonry and kindred fraternities—there are rites and ceremonies which convey by their symbolism fragments of knowledge concerning the history and destiny of the soul. Convinced of this, many worthy students are now endeavoring to raise the veil that so long has shrouded the mysteries of antiquity, hoping to solve the sacred allegories and correctly to interpret the symbolism of modern fraternities. To assist these in their research, I here propose to describe in detail the various steps, explaining the esoteric significance of each, of the ritual of initiation as conducted anciently in Egypt.

Not that the ceremonies and elaborate rites of the Samothracian Mysteries, those of Eleusis and Bacchus in Greece, and the Saturnalia of Rome, as well as the ritual of modern Freemasons, lack in mystical significance do I select Egypt, but because without exception these latter derived their procedure from the Mysteries of Ancient Egypt. Thus by interpreting these rites at their common source, even though they have been sometimes obscured by later transformations, we shall be able to perceive the fundamental concepts that underlie them all.

In this work we are fortunate in having a treatise, not entirely inaccessible to modern readers, that gives a detailed description of the Egyptian Mysteries. Iamblichus, a noted scholar and Neo-Platonist who lived in the first half of the fourth century, wrote a work upon the Egyptian Mysteries in which he portrays the principal steps and trials imposed upon the candidate during initiation. This description was translated into the French by P. Christian, and has been drawn upon freely for information by the more eminent students of the tarot, as it contains a complete description of the Egyptian tarot. In 1901 it was translated from French into English by my good friend Genevieve Stebbins, who has given me permission to make use of her translation in this lesson and in Course 6, *The Sacred Tarot*.

I, therefore, shall follow accurately the trials to which the Egyptian candidate for initiation was subjected, as described by Iamblichus, and shall endeavor at each step

also to explain what originally was intended to be conveyed to the mind of the candidate. Such trials in some form, handed down from this remote period, persist today, as witnessed by the hazing of newcomers at school, and the riding of the goat in our lodges.

But why should tests of fitness for initiation be called riding the goat? This revolves about the significance of the five-pointed star which from antiquity has been employed as the symbol of man. The star placed with one point up has the significance of intelligence ruling the four elementary kingdoms, reason dominating the instincts of the flesh. It is thus the Grecian Hygeia, used by the Pythagoreans as the symbol of health. Now, in the zodiac the head of man, organ of intelligence, is ruled by Aries, pictured among the constellations as the Ram. In sacred works, consequently, to designate that the creative forces are directed by intelligence, it is common to refer to this circumstance as the lamb, and is so mentioned by St. John.

The five-pointed star when inverted, however, signifies man standing on his head; reason dominated by lust, passion, and selfishness; and is thus emblematical of chaos, the pit, black magic, and the devil. Zodiacally the home sign of Saturn, the origin of our Satan, is Capricorn, pictured in the firmament by a goat. The goat, whose beard forms the downward point, whose ears form the two lateral points and whose horns form the two upward points of a five-pointed star, therefore, as well as the inverted five-pointed star, is a symbol of black magic and evil. St. John refers to this inverted star as a falling star named wormwood. It will also now be apparent why the separation of the good and the evil should be referred to in the Scripture as dividing the sheep from the goats. The goat is the symbol of evil, and riding the goat signifies that temptations have been vanquished, the devil overcome, and the animal instincts sublimated into spiritual assets.

In the course of initiation, past or present, the candidate comes into the possession of new knowledge and new powers that alike are capable of either use or abuse, the proper application of which requires a high moral standard. To become master of the occult sciences, which ancient religious law forbade to be placed in writing, requires a strong intellect. The practice of white magic demands fortitude, persistence, self-confidence, and courage. Therefore, to prove the candidate's mental, moral, and physical fitness to receive the Hermetic Secret Doctrine, the strength of these qualities were, and are, subjected to test.

The primary object of all ancient Mysteries, however, and by far the most important use of the initiatory ritual, was to impress indelibly upon the mirror of his consciousness, by means of never-to-be-forgotten experiences, the past history, present opportunities, and future destiny of the soul. During the course of his travail there was also often another result attained. The stimulus received by his psychic faculties frequently opened the senses of the soul to visions of transcendental realms, and awakened the dormant powers of his divine self to new potency.

It is true that in some of the Mysteries the birth, crucifixion, interment, and resurrection of the sun were celebrated. But the initiate recognized in the sun's

annual pilgrimage a direct analogy to the experiences of the soul in its cyclic journey. Likewise, in some, certain experiences of the soul were given preeminence. Thus the ecstatic reunion of the soul with its divine source gave rise to the Bacchic frenzies; the orgies originally representing the reunion of separated souls, the wine being emblematical of the mixture of masculine and feminine magnetism.

Now it is common knowledge that the classic nations, as well as other people of antiquity, believed in the doctrine that the soul once existed in a spiritual state of Edenic purity, was tempted to undergo involution into material form for the sake of experience, and must ultimately win its way back to paradisiacal bliss. While recognizing that sex symbols were a prominent feature in the Mysteries, and that sex doctrines were an important revelation, yet most commentators have preferred to omit them, either through ignorance of their true function, or for fear of shocking the modern sense of propriety. These sex doctrines of the ancient Mysteries are not what is currently termed sex practices, being neither devoted to sex magic nor to celibacy. They are doctrines of the true and pure relationship of marriage, such as today would be approved by our most eminent physicians and psychologists.

All life and activity being the result of polarity, the history and the mission of the soul can only be comprehended in association with its sexual activities. Now the ancient Secret Doctrine is very emphatic that in the beginning the ego is androgynous. After its differentiation, corresponding to birth, as it involves down from the celestial realm to the highest state of the spiritual world it develops a soul sphere—a sphere of consciousness organized in celestial substance. But to contact still coarser substance such as spiritual substance, astral substance, and physical substance, these energies become polarized into two separate channels of flow, into two organizations of consciousness, into two souls. This is the separation of the Twin Souls; who are over-shadowed and energized by one ego, yet each develops individual consciousness.

This separation is beautifully described in the Bible as Eve taken from the original Adam, who had been created in the image of God: “Male and Female created he them.” Yet after the descent into material conditions and partaking of the evolutionary tree—gaining a knowledge of good and evil—to become as gods, as the Bible states it, they must also partake of the Tree of Life.

This tree of life is the reunion of the separated male and female souls. This is portrayed in the Greek ritual as Dionysus, slain and dismembered, after which the parts are collected and reunited in a new birth. In Egypt, Osiris is portrayed as murdered and the fourteen dismembered parts (each soul possessing a septenary constitution) sent floating down the Nile (the current of involutory life) finally to be cast upon the muddy banks of the Delta (the material world). But faithful Isis (Nature) gathers together these fragments and breathing upon them the breath of life they become reunited and Osiris is born anew, never again to die. These allegories symbolically picture the drama of the soul’s descent from the celestial state, the separation of twin souls in the highest realm of the spiritual world, who after a time Nature again brings together, breathes upon them the breath of love, uniting them,

and by their united strength they become immortal.

Now, in the description of the trials with which Iamblichus has furnished us, the Sphinx of Gizeh served as the entrance to subterranean vaults in which the initiation was conducted. From between the forward limbs corridors closed by a secret door ran to crypts beneath the Great Pyramid.

As in modern fraternities, before the candidate was admitted to participate in the trials he must be selected by unanimous vote. Then he must give himself unreservedly into the hands of his guides and place implicit confidence in them, obeying their commands without asking questions. If we bear in mind that the whole ritual symbolically depicts the cycle of the soul, we perceive that this represents the faith that the soul should have in the wisdom and beneficence of Deity, and the obedience it should manifest to Nature's laws. The ego is called from an undifferentiated state by the unanimous demand for souls to be fitted for specific work in the cosmic scheme of things. During the earlier portion of their initiation into the mysteries of life, these souls do not know the why or wherefore of the suffering they endure; but if they place implicit faith in the guidance of their spiritual tendencies, at last they will see the light shine through the darkness, and following this, will be led into the glorious sunshine of Self-Conscious Immortality.

At a distance from the Sphinx the neophyte's eyes are bandaged, and he is led to its foot an unknown distance, where a door of bronze opens to admit him and then closes without noise. Bronze is an alloy of tin, ruled by Jupiter, and copper, ruled by Venus. Venus is the planet of love, and Jupiter in addition to being the planet of beneficence, through his rulership of the sign Sagittarius, the sign of the higher mind, is in one of his aspects considered the planet of wisdom. Bronze, therefore, represents not only a union of a male and a female potency, but also a fusion of love and wisdom. Now, the bandaged eyes of the neophyte represent the unconscious condition of the pure, diffusive spirit before its differentiation as an ego. The journey of the neophyte to the foot of the Sphinx represents the indrawing of this spirit potency to the celestial matrix of the ego's angelic parents. Its projection on the toilsome journey of involution and evolution, through the intense vibrations of wisdom and love of its angelic progenitors, is signified by the neophyte silently passing through the door of bronze.

The Sphinx, into which the neophyte enters, is a synthetic representation of all the energies in the zodiac, being composed in its unconventionalized form of the emblems of the four quadrants of the heavens—a lion, an eagle, a man, and a bull. It thus symbolizes a cycle, and because time is measured by the sun's passage through this cycle, it also signifies the passage of time. For the ego time was not prior to its differentiation.

Next, the neophyte is led down a spiral stairway of 22 steps and through a second bronze door which when closed so harmonizes with the wall of the circular chamber into which it opens as to be undetectable. He is halted upon the verge of an abyss and commanded to cross his arms upon his breast and remain motionless. In the heavens,

the solstitial colure and the equinoctial colure make a cross, the original of the swastika cross. This heavenly cross, due to the revolution of the earth on its axis, apparently moves around the heavens each day from east to west, and due to the procession of the equinoxes moves through the constellations also from east to west, though slowly, and is thus symbolized by the swastika with its points turned to the left, this being the emblem of evolution. The swastika with its points turned to the right is the emblem of involution.

The spiral stairway of 22 steps symbolizes the involutory descent through the embryonic celestial state of the seraphs, the door being the passage into the paradisiacal worlds of the cherubs, where for the first time vibrations of love and wisdom, represented by the door of bronze, begin to disturb the tranquil innocence of the ego. Twenty-two steps are emblematical of the zodiacal circle of 12 signs and the chain of 10 planets which exert their influence upon the soul, and upon all Nature, throughout all states, from the highest to the lowest. The soul's spiral pathway through each plane of existence is thus influenced by them. The candidate's crossed arms signify progress.

The candidate now halted upon the abyss, represents that state in which a rib was being removed from Adam for the creation of Eve. The abyss represents the grosser worlds into which the ego cannot descend; upon which it directly can have no influence. Its vibrations are too fine to affect substance coarser than that of the paradisiacal world, or upper realm of spirit, represented by the circular chamber in which the neophyte now stands. But during its descent through the seraphic realms it has evolved a soul sphere, or organization of consciousness, containing both male and female potencies. That it may transmit motion to grosser substance, this soul sphere polarizes its motion and divides into two organizations of consciousness, into two souls related to each other as male and female; the Adam and Eve of each deific ego.

While the candidate stands motionless upon the verge of the abyss, the two guardians who have accompanied him take from an altar, and dress in, white linen robes. One wears a girdle of silver and a mask representing the head of a bull, the other wears a belt of gold and a mask representing a lion's head. The robes of white symbolize purity, of linen, typify strength. Gold is sacred to the sun, and the lion's head is the sign Leo in which the sun exerts its greatest power. Silver is sacred to the moon, and the sign where the moon has its best influence is Taurus, symbolized by the head of the bull. Thus do the two guardians, in a most spectacular manner, represent the masculine and feminine portions of the ego's soul sphere.

The Thesmothete, as the guardian is called, representing Pi-Rhe, genius of the sun, stands at the neophyte's right, while the Thesmothete dressed as Pi-Ish, genius of the moon, stands at his left. Suddenly, with a great noise, a trap door descends in front of the neophyte, and at the same time the bandage is snatched from his eyes and he beholds the two figures, one on either side. Standing thus he represents the ego at the moment of parturition when the twin souls are born. The shock of their separation is denoted by the noise, and as Adam and Eve they stand by his side.

Then, from out of the abyss, only half of its body visible, rises a horrible mechanical spectre holding in its hands a huge scythe which, barely missing him, sweeps past the neophyte's neck seven times. This spectre is the symbol of death. The scythe represents the changes which time brings. Only the upper half of the spectre is visible, to designate that the higher qualities of the soul alone survive the changes of time. The seven sweeps of the scythe, weapon of death, indicate that the soul both in involution and in evolution passes through conditions ruled by each of the seven planets.

Now, according to kabalistical doctrine, before the creation of the universe there existed the all-diffusive spirit, called Ain Soph Aur. From this the universe came into manifestation by means of ten emanations, the first of which, called Kether, or crown, signifies motion, and corresponds in human affairs to the ego. The next two emanations are Chocmah and Binah, wisdom and intelligence, which involve the idea of polarity and correspond to the positive and negative souls at the moment of their separation. From this godhead, Kether, Chocmah, and Binah, the universe evolves by means of seven other emanations, or impulses; and according to the law of correspondences, the soul also builds its microcosmic universe about itself by similar means, the seven-fold constitution of man being evolved, as was indicated, by passing through environmental influences ruled by each of the seven planets, a circumstance symbolized by the seven sweeps of the death-dealing scythe, evolution being accomplished only after the separation of the souls, by means of successive lives and deaths.

After the enactment of this drama, the Thesmothetes lead the neophyte to the door of a small dark tunnel, giving him a lamp with which to light his way. The lamp represents the inner promptings of the ego which if listened to will direct the soul aright. He is now left to his own devices to indicate that the twin souls each go their separate ways. The tunnel is so small that to enter it he must proceed on hands and knees, and to indicate that once the cycle of necessity has been entered there is no return except through following out Nature's plan, the door immediately shuts behind him. This tunnel dips more and more downward as he follows it until finally it ends abruptly at the brink of a crater formed like an inverted cone. The tunnel symbolizes the descent of the soul through the spiritual realm, and the inverted cone, the sides of which are polished to reflect the light of his lamp even as in the astral world the astral light is seen, represents the astral world. Down the side of this cone he observes an iron ladder of 78 rungs, and finding no other method of advance open, he descends it. At the bottom of the ladder, he observes when he arrives there, a yawning well. Therefore, to find a way out he starts to ascend, looking carefully for a means of egress. Climbing seven steps upward he notices a crevice in the rocks just large enough to admit his body, and through this he squeezes, to find himself at the foot of an ascending spiral stairway.

The ladder is of iron to indicate that after leaving the spiritual realm the soul has entered a realm of force, a realm where animal tendencies as well as those higher are present, where the planet Mars has full sway. To indicate that during this period of its

journey the soul is only a rudimental form, at no time can the neophyte assume the upright position, the position of the truly human. The 78 rungs of the astral ladder represent the influences that exert their power over the descending soul: the 12 zodiacal signs, the 10 planets, the 12 mundane houses and the denizens of the 4 astral kingdoms, the 36 decanates of the zodiac, and the 4 quadrants of the zodiacal circle.

The bottom rung of the ladder represents that point where the involving soul can go no lower, the point where it contacts the mineral realm and first incarnates in objective form. The 7 upward steps represent the 7 states of its evolution from mineral to man. In this seventh state the soul has behind it those experiences which have given it a complex astral organization, which enables it to be attracted to a human mother. The travail at its birth into human form is represented by the neophyte when he painfully squeezes through the narrow cleft in the rocks.

Now, from the beginning of its cyclic journey until it is born as a human being there are just 108 steps—22 prior to the separation of the male soul from the female soul, 78 involutory steps through the astral realm, 7 steps from mineral to man, and an 8th step representing birth into the human form, symbolized by passing through the crevice in the rock. These 108 steps correspond to the 108 tablets of the more complete Egyptian tarot. The set of 78 cards commonly known constitute the exoteric set such as was revealed to all who succeeded in passing the trials here described. But initiates know that at an advanced stage, after undergoing soul purification, and being admitted to the rites of the inner sanctuary, the neophyte was instructed in the use of an esoteric set, consisting of 22 Astro-Masonic symbols, and that at a still higher point in initiation there was revealed to him a septenary of Kabalistical Pictographs, sealed with an 8th, thus constituting in all 108 tablets, completing the Deific number 9 (1+8=9).

Now, for all ordinary purposes the exoteric set of 78 tablets, which constitutes the common Egyptian tarot, is quite adequate. These are reproduced in Brotherhood of Light tarot cards. And here also, I believe, I should designate where the tablets of the esoteric set are accurately described. In ancient times these were kept most secret, but that they might not be lost to coming generations, they have been fully described and commented on in a book unfortunately now out of print, but which is possessed by many students throughout the world. This book is *Light of Egypt*, Vol. No. II, by T.H. Burgoyne. It presents this ancient esoteric set under the caption THE TABLETS OF AETH. The first 22 are the Astro-Masonic symbols referred to. Next is given a vision of the 10 great kabalistical powers, or angels, of the universe. The first 7 of these, as given under, VISION, are the 7 Kabalistical Pictographs referred to. But that this esoteric set may also be used separately as explanatory both of the kabala and of the 33 degrees of Freemasonry, there is added an eighth, ninth, and tenth pictograph, which were not included in the complete Egyptian set of 108 tablets. The seal, which is the seal of the earth, however, is given, a seal that is dual yet is one, the obverse and reverse view being represented on one tablet.

After the neophyte has passed through the cleft, symbolizing his expulsion into the world of human activities through the sacred yoni, he ascends the spiral stairway of

22 steps and halts before the entrance to the sanctuary. These 22 steps, symbolical of the influence upon human life of the 12 signs and 10 planets, signify his experiences under their influence from birth to the time that he seeks occult initiation. A grating of bronze—symbol of love and wisdom—bars his progress, but a magus, called a Pastophore, opens the gate and welcomes him in. Thus always is there a master ready to assist and instruct the neophyte who, in love and in devotion to sacred science, has successfully passed the early ordeals.

The neophyte now finds himself in a long gallery sustained by sculptured caryatides representing 24 sphinxes, 12 on either side. In each space between two sphinxes the wall is covered with a frescoed painting, these 22 pictures being lighted by a line of 11 lamps that extends between the two rows of figures.

A sphinx, representing the four quadrants of heaven, symbolizes any cycle of time, and as here arranged they designate the 24 hours of the day, as well as the 24 elders of the Apocalypse. The 22 frescoed paintings picture the 22 Major Arcana of the tarot, the symbolism of which at this time is explained to the neophyte and by him committed to memory. The eleven lamps are crystal sphinxes in each of which burns an asbestos wick at the surface of a sacred oil, each lamp being supported by a bronze tripod.

The flame of the lamp represents the ego, a living, brilliant, changeless spark of Deity. The asbestos wick which ever feeds the flame yet is never consumed, represents the immortal soul feeding the ego with the results of its experiences. These experiences, gained through cycles of time as symbolized by the form of the sphinx, and in objective realms as indicated by the crystalline structure of the lamp, are typified by the oil. The transparent quality of the lamp suggests that matter offers no barrier to the sight of the initiate. The tripod, upon which the lamp rests, an alloy of a positive and a negative metal, presents the symbolic aspect of two interlaced trines. The negative trine symbolizes involution, and the positive trine evolution, together constituting the support of the soul and making possible its conscious immortal existence.

One of the lamps is set slightly apart from the other ten and represents the final synthesis of the others, symbolizing also the point from which the neophyte departs to undergo further perils. The 22 frescoed pictures each correspond to one of the 12 zodiacal signs or 10 planets and constitute an esoteric interpretation of their attributes and functions. The 22nd picture corresponds to the unknown; but each of the other 21 correspond either to one of man's seven physical senses, to one of his seven psychic senses, or to one section of his seven-fold constitution. Each is also related to one of the 21 branches of occult science that the neophyte is called upon to master before he can aspire to adeptship. Taken as a whole—as shown in detail in Course 6, *The Sacred Tarot*—they constitute a science of the will and an absolute religious doctrine, and each corresponds to a definite step in the neophyte's occult advancement. The 10 lamps represent the numerical decade as well as the ten emanations of the Sephiroth of the Kabala, and together with the 22 pictured Major Arcana point to the 32 paths of wisdom. With the final lamp, or 33rd symbol, they

constitute the exoteric view of the same set of universal principles the esoteric side of which is set forth in the 33 TABLETS OF AETH previously mentioned. They, therefore, represent the original ideas from which the 33 chapters of the kabalistical book, Sephir Yetzirah, and the 33 degrees of modern Freemasonry, were derived.

The neophyte is permitted to remain in this Gallery of the Arcanum under the instruction of his master until he has thoroughly familiarized himself with all the symbols and their interpretations. This symbolizes all that he may hope to attain from the physical world.

To progress farther on the path, the soul must temporarily leave the physical world and soar into other realms where ascended souls will conduct its initiation on the inner planes. To reach the spiritual plane, either while still connected with the physical body or after death, the soul must pass through the four kingdoms of the astral world. To symbolize this journey, the neophyte leaves the Gallery of the Arcana. First, to represent his travel through the realm of the gnomes he passes through a tunnel. At the end of this tunnel, to represent the realm of salamanders, he is confronted with a roaring fire through which he must go if he would not retreat. This fire is really not so great as it at first appears, and he passes through it without injury, but no sooner has he passed it than it is replenished by unseen hands to make his return impossible. Thus he realizes an important truth; that in occultism he who places his hand to the plow and then turns back is lost. Next, as representing the influence of the undines, he is compelled to wade through a stagnant lake the water of which rises to his chin, but by going on tiptoe he manages to reach the opposite shore, and climbs dripping and cold upon a platform which he sees in front of a closed door.

This door is of bronze, and is divided laterally by a column on which is sculptured the head of a lion having in its mouth a ring figuring a serpent biting its own tail. The ring in the form of a serpent symbolizes eternity, and the lion symbolizes courage. Courage, therefore, he is made aware, should sustain his efforts throughout eternity. To open the door he grasps the ring, and as it resists he uses both hands. But no sooner does he get a firm grip upon it than the platform beneath his feet drops from under him and leaves him suspended in air, in the realm of the sylphs. The trap beneath his feet rises again promptly, and he passes through the door which now opens to permit his entrance. This bronze door symbolizes love and wisdom. It is divided into a right, or positive, half, and a left, or negative, half; the dividing column, placed where positive and negative forces join, symbolizing the tree of life that confers immortality. The sign Leo is natural ruler of love affairs. The lion's head, however, as Leo is ruled by the sun, also typifies the male element, while the circle in its mouth typifies the female element. The symbol as a whole, therefore, represents the complete and harmonious fusion of the sexes, actuated by love. Thus is conveyed to the neophyte's mind the thought that the door of the sanctuary opens only in the union of two harmonious souls inspired by love and guided by wisdom. Not by one alone can the spiritual heights be scaled, but through the mighty movement within the finer substances of space caused by the soul union of both.

The neophyte thus having triumphed over the tests by earth, fire, water, and air,

representing his passage through the astral kingdoms, is now met by 12 Necores. These men typify the translated souls of those who once lived upon the earth and who belong to each of the 12 zodiacal signs. They blindfold his eyes, to signify the dullness of the real spiritual perceptions until higher initiation is attained, and lead him to a crypt beneath the pyramid where the college of the magi awaits him. This crypt symbolizes the spiritual world which he now ritualistically has entered. The pyramid above is a symbol of the earth which he has abandoned, and being directly above this crypt indicates the exact correspondence between the physical world and the world spiritual, between that which is above and that which is below.

The walls of this crypt are sculptured with the pictures of the 48 constellations that represent the influence and spiritual significance of the 12 zodiacal signs and the 36 zodiacal decanates. There are also pictured representations of the 7 planetary angels, and the 360 genii of the degrees of the zodiac, through which the sun passes in one year. Beneath each of these pictures is an explanation which can only be read by those possessing the key, this key being that of Spiritual Astrology, which is treated in complete detail in Course 7, *Spiritual Astrology*. At each of the four angles of the crypt stands a bronze statue posed upon a triangular column, one having the head of a man, one the head of a bull, one the head of a lion, and one the head of an eagle. These figures denote—as each is posed on a trine—the four zodiacal triplicities. Each head bears a cross—symbol of union of forces and of earth—upon which is a light, as if engendered by the union and representing the divine fire that permeates and vivifies earth.

The dome of the vault contains a golden rose of five petals. The rose, because it is harbinger of spring, represents renewed life. Five is the number of man, and gold is the metal sacred to spirit. This entire symbol represents those who have attained spiritual regeneration. From the rose are suspended seven lamps, each having three branches. The three branches signify the three great divisions of occultism: astrology, alchemy, and magic. Each of these is divided into 7 distinct subjects, the 21 branches signifying the 21 branches of occult science which the neophyte is called upon to master and which illuminate the mind of the adept.

Below this rose sits the Hierophant. He is dressed in purple, sacred to Jupiter, the planet governing the higher mind, indicating that he is master of the sacred sciences. His forehead is girt with a circle of gold to indicate that his mind is fully cognizant of spiritual things. From this band arise seven stars, indicating that he is in possession of the seven states of consciousness that are the heritage of the perfect man. He occupies a silver throne. This metal is sacred to woman, and indicates that he is not ignorant of woman's share in the attainment of spiritual victory. The throne is placed upon a raised platform, and thus indicates the exalted position which his knowledge and efforts have conferred upon him.

To indicate their purity, the other Magi are dressed in white. And to indicate that they also have the spiritual light, there is a band of gold about each brow. At right and left of the Hierophant they are arranged in triple semicircles, there being three semicircles on the Hierophant's right and three on his left, so that he occupies the

central, or seventh, point between the two triads. The triad on the left is negative, and represents an equal development of body, intellect, and soul in woman. The triad on the right is positive, and represents an equal development of body, intellect, and soul in man. Thus the Hierophant, himself masculine yet occupying a throne of silver, by his unique position symbolizes the meeting and blending of the very highest type of man and woman.

In the rear, under a purple canopy, symbolical of beneficent Nature as she overshadows all, is a colossal statue of Isis. It is composed of an alloy of lead, tin, iron, gold, copper, mercury, and silver; each being a metal ruled by one of the seven planets and thus symbolizing one of the seven active principles that pervade all nature. The statue wears a triangular diadem of silver, with an aigrette of 12 rays, and upon her breast is a golden rose in the centre of a golden cross. The arms are extended in front in such a manner as to form an equilateral triangle with the forehead at the apex. From each of the open fingers streams toward the earth a golden ray.

The rose upon the golden cross symbolizes the united transmutation of positive and negative energies from a lower range of action to a higher scale of vibration. The ten golden rays typify the chain of ten planets through which Nature molds the destiny of all things. The silver aigrette of 12 rays represents the 12 zodiacal signs that act as sounding boards from which the vibrations of the planets are reverberated. The equilateral triangle of silver signifies woman who has proportionally developed her body, intellect and soul. The triangle from which flow the golden rays indicates man who has cultivated in a harmonious manner his body, intellect and soul. Thus their point at the top of the forehead of Isis denotes that Nature's crowning glory is the reunion of two such perfectly developed people.

Before the Hierophant is a table upon which rests a planisphere, and it is here, before the assembled college, that the neophyte, whose eyes are now unbandaged, is required to demonstrate his knowledge of astrology by erecting and delineating a birth chart, calculating the progressed positions and passing judgment upon the events that have taken place in some person's life, and the times when these events have taken place. In order to check the accuracy of his delineations, the chart of some person known to members of the college is selected, but its identity is kept secret from the neophyte. He is expected to portray the temperament of the person, to select the channels of activity into which the life has chiefly been turned, to designate what departments of life are fortunate and what are unfortunate, and to select the times and natures of the principal events that have transpired in his life. Also he is expected to know something of all the other six branches of astrology.

After his knowledge of astrology has been thoroughly tested, he is required to demonstrate his knowledge of the tarot. He must be familiar with the meaning of each of the Major Arcana in each of the three worlds as well as the divinatory significance. He must know the vibratory influence of names, numbers, colors, tones and flowers, and must have some knowledge of the talismanic properties of gems. And he must know how a particular name, number, or other vibratory influence will affect a certain person, as revealed by comparing it with the birth chart. Finally, he is

required to lay out and correctly read a tarot spread, thus demonstrating his ability to use these tablets as divinatory instruments.

After these tests of his knowledge, he is required to take an oath, similar in its wording to that administered in modern Freemasonry, never to reveal the sacred sciences or other portions of the mysteries. Then he is required to take a second oath, vowing himself to submission and obedience to the Hierophant. This second oath represents the pledge the initiate makes to himself to obey always the voice of his conscience. At this point a terrible noise is heard and an artificial tempest is produced during which the Magi point their swords at his breast and accuse him of past crimes, typifying the day of judgment when the soul will be called upon to render an account of its deeds done while in the flesh. Next, two Necores, each carrying a cup of wine, approach and offer the cups to him. Then the startled candidate is told that one of the cups is quite harmless but that the other contains a deadly poison. Reminding him of the oath he has just taken to obey, the Hierophant commands the neophyte to make a choice of, and immediately to drink, the contents of one of the cups.

The harmless cup symbolizes love and virtue; the poison cup, passion and vice. Each soul is confronted with the trial of this choice, and only by obeying the Voice of the Silence can it safely be passed. If, in spite of his oath of submission, the neophyte refuses to obey, he is informed that the initiation is broken and he is confined to a dungeon for seven months and then allowed a second trial. If he thus fails at the first test he may never rise higher in the ranks of the Magi, though he may gain freedom later by successfully passing the test. In such a case he represents a weak and wavering soul who fears to obey the dictates of his inner self. The neophyte's only hope of escaping extinction is to pass the ordeal, though once failing he does not have the opportunities that would have been open to him had he taken the decisive step at once. The laws of the Magi compel him to pass the trial or perish in the dungeon cell.

Thus the soul, by virtue of moral integrity and aspiration, is represented as triumphing over the barriers that confine it to lower spiritual states. His blindfolded entrance to the crypt indicates his entrance into the first state of the spiritual world; the tests of his astrological and his kabalistical skill take him symbolically into the second spiritual state; his first oath conducts him into the third spiritual state; his second oath leads him into the fourth spiritual state; the trial of the cups gives him entrance into the fifth spiritual state; and now, to represent the sixth spiritual state, he is led into a neighboring hall which is furnished luxuriously to convey the impression of a royal nuptial chamber.

His clothing is removed by attendants, indicating that all grossness has been purged away. He is dressed in white linen to symbolize the strength of purity. An exquisite repast is enjoyed while his ears are refreshed by strains of rapturous music, emblematical of the higher states of ecstasy and the music of the spheres. As he finishes the refreshments, curtains are drawn aside, revealing to him beautiful young women dancing. To conceal their identity, even as the body hides the soul, they wear masks attached at the brow by a circle of gold, typical of intellectual illumination. They are scantily clad in a gauzy veil spangled with golden bees, the veil indicating

how slight is the obstruction that bars man from realization, and the golden bees signifying the divine creative essence in its most spiritual aspect, and further, that the veil may be penetrated only by the industrious; for the slothful soul will never penetrate the spiritual states. Across each girl's shoulders is thrown a filmy scarf, symbolizing the spiritual raiment formed by exalted aspiration and devotion to truth; and each carries a garland of flowers, indicative of innocence, joy and supreme happiness.

Delightful perfumes fill the air, and the neophyte approaches the dancers. After a time two of their number throw their garlands about him, encircling him with a chain of roses, while the others flee. These two girls continue to dance about him, shaking their garlands by turn as if to provoke his choice. The chain of roses represents the binding power of love.

If the neophyte dares to violate the sanctity of the mysteries he is in actual danger, but if he continues to conduct himself with propriety the Magi come to congratulate him upon passing the last of the trials, and confer upon him the title of Zelator. This final act in the initiation symbolizes the reunion of twin souls, which takes place upon the boundary of the sixth and seventh spiritual states. While conveying the idea that all passion must be evolved upward into pure unsullied love before this state can be reached, and that this sacred union must not be profaned with violence or carnal desire, it at the same time, by the two girls dancing about the neophyte, symbolizes the original trinity that existed before the separation of the sexes—ego, male soul, and female soul. It should be noticed that this scene is very different from that representing the separation; for that was a region of hideous monsters and dim consciousness; while this is a place of joyous beauty, ecstatic sensations, and vivid perceptions. By this union the soul is represented as passing into the seventh spiritual state together with its long missing mate, and can no longer be considered human, for it has now attained to the state of angelhood; immortality is no longer a possibility, but an assured fact.

Lastly, to impress upon the new Zelator the fate of those who follow the inversive path, he is led in the midst of 12 Necores, representing the zodiacal signs, into the opening of a cavern. Here a pale, uncertain light reveals to him a pit in which a sphinx is tearing the effigy of a human form. So, according to tradition, will the cycles surely destroy those who lose their immortality by following the fateful road of selfishness and black magic. Thus ends the ritual of Egyptian initiation, portraying, as it does, the cycle of the soul.

Book 3

Copyright
Church of Light
August 2002

Spiritual Alchemy

Chapter 1

Serial No. 49
Original Copyright 1931
Elbert Benjamine

Copyright
Church of Light
August 2002

Doctrine of Spiritual Alchemy

Chapter 1

The Doctrine of Spiritual Alchemy

FROM antiquity we have inherited definite traditions concerning magic, astrology, and alchemy. The magic of the ancients, now termed variously Mental Science, Christian Science, Metaphysical Science, and New Thought, is today being used with satisfactory results by many esteemed people. Astrology is the foundation upon which has been erected in the course of time the modern science of astronomy. As astrology, furthermore, it is helping an ever-widening circle of humanity to overcome the difficulties offered by life. Like magic and astrology, alchemy was laughed at by the schoolman until the twentieth century gave indisputable proof of transmutation in his own laboratory. Transmutation and the flying machine, as the older generation well remembers, were the two standing jokes. Anyone interested in either was supposed to be ridiculously credulous. But transmutation can now be produced at will by our chemists, magic under another name is gaining in popularity, and astrology is being verified by thousands every day. It is time, therefore, that someone should seriously set forth a clear exposition of what the ancient alchemists really thought and taught.

The learning of the ancients, in so far as it existed outside secret occult orders, was collected in the Alexandrian Library. This library was begun by Ptolemy I in the third century B.C., and was added to in great measure by Ptolemy II. With the ascendancy of Christianity no pains were spared to destroy every record, monument, or scroll of more ancient times, either in the fear that it would contradict the Bible, or in the belief that it was pagan. The second Library in the Serapeum was completely destroyed when the Christians sacked that temple in 390 A.D. The main library also disappeared under persistent hostile influences, the Mohammedans, when they gained the power, finishing the work of destruction commenced earlier by the Christians.

Libraries elsewhere met a similar fate at the hands of Christian bigots and Mohammedan fanatics. But though the libraries were destroyed, the statuary wrecked, and the evidence of ancient culture largely erased, not all of the scrolls were consigned to the flames. Some found their way to secret, safe sanctuary in the heart of the Arabian Desert.

From thence, at a later date, mathematics, magic, astrology, and alchemy found their

way to Europe. The word Alchemy, therefore, is Arabic, being derived from “al,” the, and “kimia,” hidden, or occult. To the Arabians alchemy was the science of hidden properties and essences. It dealt with the occult attributes of things.

It is nevertheless linked up through association with the art of transmutation; for a long line of alchemical experimenters sought to change base metals into gold. In addition they sought the philosopher’s stone, the elixir of life, and the accomplishment of the great work.

The sciences, brought to Europe by Arabian scholars, were not universally welcomed. Certain monks, like Placidus de Titus, expounder of the semi-arc system of directing, were fortunate enough to be allowed to delve deeply into astrology. Magic, of course, was widely frowned upon. Friar Roger Bacon and certain others made notable discoveries while conducting alchemical experiments. But all such delving into nature’s mysteries was commonly considered to be a matter that depended upon trafficking with the devil. Inside the sacred precincts of the Church it was occasionally permitted, but any delving by outsiders met quick disapproval of the ecclesiastics.

It was not an age of free speech. It was an age of terrorism to anyone guilty of discovering some fact at variance with the teachings of established religion. Spiritual truths could not openly be proclaimed. If they were to be conveyed to another, a secret code must be used to escape the accusation of heresy. Otherwise, the torture chamber awaited.

The Language of Symbolism

—Not all alchemists, however, were interested in searching out the origin, history, and destiny of the human soul. Some there were who sought to make gold that might be exchanged for coin of the realm. Those that found this secret felt an obligation to society. They knew that should the process be learned by unscrupulous persons it might well upset the economic relations of the world and enable knaves and criminals, through vast wealth easily acquired, to rule and oppress more honest men. Against this they must guard by keeping the method a secret.

Because they were secretive about a matter of such tremendous importance to the selfish ambitions of others they were often sadly persecuted. Some were murdered by villains in the expectation that the recipe for making gold would be found about their persons or concealed in their lodgings. Others were hailed before feudal lords and potentates with the demand that they make gold. Refusing this, they were imprisoned and promised freedom only at the price of the secret process. Not a few were tortured, and some were killed, in the effort to compel them to perform transmutations or to reveal how it was done. Take it all in all, whatever they may have gained through the possession of alchemical knowledge they well paid for in lack of peace and comfort. For they have been hounded from place to place no less than the traditional Wandering Jew.

They lived in an age antedating science. No terminology as yet existed for expressing many of their ideas in ordinary language. Words were coined, therefore, to meet the demands of the occasion. Thus it came about, as a little reading of the alchemical works left by them makes obvious, that the same thing was called by a different name by different alchemists. This at first sight is very confusing. But it need not remain so, for in common language we have different words, called synonyms, to express the same idea. What we must do to understand their writings is to determine the basic idea that may be expressed by a variety of these synonyms.

They wished to conceal their knowledge from the vulgar and to reveal it to the worthy. It often served to protect them from the designing to talk, write, and act as if mentally unsound. They needed a code to convey information, and such a code came to them ready at hand from the same source as came the science of alchemy. Astrology and alchemy arrived in Europe together. A language that was applicable to one was likewise applicable to the other. Astrology teaches that everything on earth has its correspondence in the sky, and everything in the sky has its correspondence on earth. This is the key to alchemical synonyms.

A thing on earth is ruled by a planet or sign in the sky. This planet or sign rules other things on the earth having the same vibratory quality. The principle or quality or spiritual bias designated by an alchemist may be called by the name of any one of the various familiar objects ruled by the same astrological influence. Thus did the alchemists write and talk and think in the language of celestial correspondence.

Different Kinds of Alchemy

—There is a great similarity to be found in the language used and in the methods of procedure advocated by alchemists living in different centuries and in different lands. One who delves into the rare and musty tomes still extant concerning the Hermetic Art, as it was called by these sages, can not fail to be struck by the parallel methods of those who obviously sought different ends.

A sifting of their writings reveals that some wanted mineral gold with which to buy leisure, comfort, and luxury, and with which, perhaps, to help the poor. Some, however, had no thought of this, but labored to transmute bodily fluids and forces into magnetic power with which to perform wonders. Knowing nothing of the Yogis, they yet desired to do the things the Yogis are reputed to do. Some worked solely with the vegetable kingdom, some with animals, and still others sought to establish an ecstatic rapport with the source of all life, light, and love to the end of transmuting the gross trials of life into golden spiritual treasures.

Process Always the Same

—In spite of the wide variety of ends sought, the principles followed and the

succession of steps must be the same in all transmutation. A process carried out on one plane gives the same result as when carried out on another plane, except that the result as well as the process is on a different level. The tones C, G, and E sounded in combination on one instrument, and in one octave, give a resultant chord that is similar to C, G, and E sounded in combination in another octave on the same instrument, in the same octave on a different kind of instrument, or in another octave on another instrument. The same combination of tone vibrations produces a similar result whatever the instrument or whatever the octave, but it may be on a different vibratory plane. Likewise, the combination of alchemical elements by means of similar processes gives the same result if carried out in the mineral kingdom, in the world of vegetation, in the mental economy of man, or in the realm of spiritual potencies. The only real difference is that the result as well as the operation is on a different plane.

To state the matter mathematically, let us call certain definite things on one plane, A, B, C, and X. Then the things on any other plane having the same astrological (astral) vibration, or rulership, let us call A', B', C', and X'. A' has the same astrological vibration as A, B' the same as B, C' the same as C, and X' the same as X. Then if A plus B plus C equal X, it follows that A' plus B' plus C' must equal X'.

What the things are on one plane that correspond to definite things on another plane may be determined through their astrological rulership. Everything in existence on any plane vibrates in its inner (alchemical) nature to some astrological tone.

Spiritual Transmutation

—In Course 9, *Mental Alchemy*, I have considered the mental plane, and show how to bring about those mental transmutations that conduce to material happiness and success. But now it is the spiritual plane that interests us. The word spirit comes to us from the Latin, “spirare,” meaning, to breathe. It connotes the breath of life. As used here it signifies the inmost principle. Spiritual Alchemy, therefore, is concerned with the most interior plane. It works to transmute that which is commonly gross into spiritual gold.

Now what can spiritual gold be? This we must find out by applying the law of correspondences.

It is said that gold is the most perfect of all metals. Therefore, spiritual gold, as applied to man, must be the most perfect part of his constitution. Gold is extremely malleable and ductile. Consequently we must seek a human principle that adapts itself to numerous states and conditions. Gold is practicably indestructible, so that which we seek in man must be eternal. Gold is not tarnished, nor is it readily attacked by other chemical elements. Let us then explore human existence for an unchangeable element that remains pure and resists the acids of criticism and the fire of affliction. Gold is a precious metal that is used as a standard of value. What is the standard of value in man?

This auriferous principle can not be the body; for the body is neither changeless nor durable, but easily corroded by external influences. It can not be the soul; for the soul is affected by all that man contacts. The most characteristic thing about the soul (the sum total of experiences that persist as mind) is its ceaseless change and movement.

The Ego, however, answers all requirements. What the Sun is to astrology, and gold to economics and industry, the ego is to individual man.

It is an imperishable spark of Deity. It is malleable; for it adapts itself to the requirement of every form of life through which the soul in its journey passes. It is ductile; for its vital rays reach out to energize the soul wherever the soul may sojourn. It is not tarnished by contact with external life, nor does it deteriorate when exposed to the acids of criticism or the fires of affliction. It is man's most precious possession. It is the standard, likewise, of the value of human life; for in so much as the ego expresses itself through the character the noble qualities are made manifest and the man attains true greatness.

The ego, undoubtedly, then, is spiritual gold. Yet as the ego already exists, a spiritual potency supplying energy to the soul as the Sun supplies light to the Moon, what need is there for transmutation?

Reading the works of the alchemists we find that there are two kinds of gold. There is natural gold, and there is transmuted gold. And these alchemists assert that the transmuted gold is far finer than that found in a natural state. Furthermore, they maintain that it takes gold to make gold, and that some natural gold must be supplied before transmutation is possible.

The ego, according to Hermetic tradition, is unable to contact the physical plane directly. During its involution it descends only as far as the boundary of the sixth and seventh state of the spiritual world. From thence it sends the dual souls on the further journey to contact external conditions, and adapts itself to the astral and physical planes by the rays of vitality that it sends to the souls.

These souls experiencing life on the external plane may raise the vibrations of their mental states to a point where energy is communicated not only to the astral plane, but also to the spiritual level. Such vibratory rates, experienced by an individual, affect spiritual substance, and may build up a spiritual body. This spiritual body is composed of the substance of the plane occupied by the ego. Like the ego it is relatively imperishable, and it partakes in great measure of the other qualities of the ego. It is not natural gold, but transmuted gold.

This imperishable spiritual body persists after the second death, which takes place in the astral realm. In this transmuted gold of the spiritual alchemist the soul must finally function if it is to survive. It is finer and more valuable than the ego because, while the ego is imperishable, such a golden form provides for the persistence of self-consciousness. Immortality of a kind is already assured to the ego, but by the addition of this transmuted gold it acquires a value it did not have before. It has acquired the priceless treasure of Self-Conscious-Immortality.

The Metals of Spiritual Alchemy

—The material alchemist works with the common minerals, such as copper, lead, tin, and iron, in the endeavor to change them into a metal more valuable. The mental alchemist follows similar principles; but the elements with which he works are his thoughts. He seeks to flux them one against the other, reduce them in the astral light, and recombine them in a mental gold that will attract to him ability, wealth, power and success. The spiritual alchemist goes a step still further. In fact, he takes the highest step possible to embodied man. He uses as his metals the various experiences of life. If some are not at hand that are necessary for this transmutation he seeks them out. He purifies them, fluxes them in proper proportion, dissolves them in the spiritual light by the aid of a reverberatory furnace, and if the resultant transmutation is successful he comes into possession of a golden chariot in which his soul may wing its heavenly flight through boundless time and eternity.

The Reverberatory Furnace

—One of the most essential features of the laboratory of any chemist or alchemist is some means of increasing the vibratory rate of the materials upon which he works. On the material plane when the vibratory rate of the molecules of matter is increased the object is said to be gaining in temperature. That is, heat is an increase in the vibratory rate of matter. If the heat be increased still further until the object glows, and thus emits light, the molecules have reached an intensity of vibration that enables them to affect a substance interior to matter; for light is not a vibration of matter, but an electromagnetic movement.

If an electromagnetic rate is greatly increased, in a like manner energy is imparted to the substance next interior to it. Astral substance is thus set in motion and effects are produced on the astral plane. This is the plane of substance in which memory resides. It is the plane occupied by the unconscious mind while embodied, and by the soul immediately after death. By our thoughts we build on the astral plane.

If the vibratory rate of our thoughts is still further increased, these motions in astral substance, following the same general process, reach an intensity in which they impart their motion to the plane next interior to them. As a bar of iron when it reaches a certain temperature emits light, which is an effect in a substance inferior to matter, so a man's thoughts when sufficiently raised in their vibratory rate, impart motion to the substance next interior to the astral. By these thoughts, or mental attitudes that have their vibration intensified in a marked manner, man can build upon the spiritual plane.

By them he can construct a spiritual body in which to function after death without a preparatory sojourn on the astral plane. Commonly after death man continues his

progress on the astral plane for a long time while he gradually acquires the ability to raise his consciousness to an intensity that enables it to build up a spiritual body. But the spiritual alchemist expects to skip this extensive astral sojourn. While yet on earth he does the work that most accomplish only long after death. He builds his spiritual body while yet occupying the physical form.

The mere raising of the vibratory rate does not result in transmutation. It does enable the substance of an interior plane to be affected. Thoughts sufficiently intensified do affect spiritual substance, but they may or may not build an immortal spiritual body. A form to be immortal must have a high degree of perfection. All its parts must be there. They must be there in proper proportions. But transmutation is not possible without, in addition to the proper ingredients that have been fully purified and present in the right amounts, there being a marked increase in vibration. Proper fluxing the materials assists in making it possible to raise their vibrations. But in addition to this, heat must be applied to the substances.

Some kind of furnace is essential to both the chemist and the alchemist. A reverberatory furnace enables the metallurgist to obtain the heat necessary to melt his ores. Such a furnace is equally valuable to the alchemist. By its means very high temperatures are produced. On the mental plane, of course, it is a mental reverberatory furnace. The necessary vibration, or heat, is produced by controlling the feelings that accompany the thoughts. As molecular motion is the vibratory agent of the furnace on the physical plane, so the feeling of pleasure or pain is the vibratory agent used by the mental alchemist to control the conditions on the astral plane.

The spiritual alchemist, who operates on the experiences of life, follows a similar plan. He uses, to control and determine effects on the spiritual plane, not merely pleasure and pain, but still higher and more interior vibratory rates known as aspiration and inspiration.

This reverberatory furnace of the spiritual alchemist has a heat, or energy, or vibration, of a very definite kind. To be sure, it is feeling, but a feeling that arises from unusual spiritual perception. This spiritual perception embraces the all of life. It recognizes the universe as an organic whole, moving toward intelligible ends. It views itself as one unit of the cosmic plan. And the desire arises to assist in the great universal work of progress. An insatiable longing is present to use every faculty and power to advance the welfare of all. A relation is established between the soul and the universe. It is felt that nothing, not even life itself, is quite so important as contributing something to the general good.

It is a feeling, but it derives from the spiritual plane. It enters into rapport with the divine in nature. There is a higher state of consciousness. The heart overflows with a zealous religious devotion to cosmic prosperity.

This reverberatory furnace of the spiritual alchemist is fed by an outpouring of love. Nothing raises the vibrations as quickly as love. It is the love of the oxygen of the air for the carbon in the fuel that gives the material furnace its intensity. Love operates on various planes. But only unselfish love affects spiritual substance.

Any exalted and unselfish love has this power. The love of a mother for her babe, of a man for his mate, or a welfare worker for her charges may have this exalted and unselfish quality. More often, however, these are too mixed with the coarser rates derived from ambition, possession, or passion to affect spiritual substance. But the love of God and His works when devoutly felt lifts the soul above all that is sordid. A higher state of consciousness is experienced. The adoration of Deity, and the thirsting to be of utmost service in his scheme of things, provides the spiritual alchemist with a furnace that may ever be relied upon.

The Laboratory

—In the writings of nearly all alchemists there appears a reference to the place of gold in nature. It is one of their cardinal doctrines. Eireanaeus Philalethes states it more clearly and concisely than most. He says:

All metallic seed is the seed of gold; for gold is the intention of nature in regard to all metals. If the base metals are not gold, it is only through some accidental hindrance; they are all potentially gold.

The alchemists thus consider gold the climax of metallic evolution. Souls undergoing their journey through the Cycle of Necessity when they first incarnate in the metallic realm enter the lowest and basest form. By means of their experiences in this lower metal they acquire the ability, when this metal runs its life course, of attracting to themselves and incarnating in, the form of a more complex, or higher, metal.

When a metal decomposes and releases its astral counterpart, this counterpart undergoes a period of assimilation of its experiences. In due time it is carried along by the life-wave to a new metallic incarnation, this time entering a metal a step higher in the scale of evolution. Its experiences in lower, or less complex, forms give it the ability to function in a form of higher construction. This process continues, according to the alchemists, until at last it reaches the highest and most perfect metal. It becomes incarnated in gold.

Gold is the highest form or principle possible to any particular realm. And because all souls are evolving, on the plane they occupy, toward its highest state, it is, as Philalethes says, “the intention of nature in regard to all metals.” If they have not yet reached this highest state, or condition, it is because they have not yet had sufficient experience to mold about themselves a golden form. This is an “accidental hindrance; they are all potentially gold.”

The same thought, encompassing a vastly wider scope was stated by a Hermetic Master: “Every immortal soul is the seed of a universe.”

In this he has gone even above the plane of spiritual alchemy; for he is dealing with the alchemy of the angelic state. Having accomplished the Great Work, he was looking to the plane next above his own level, and imparting his conception of what

he there saw to one still below who was struggling yet with the problems of spiritual transmutation.

All souls are the seed of spiritual gold. They are undergoing those experiences, slowly or rapidly, by which ultimately they will be able to build about themselves a perfect spiritual form. It is the intention of nature that they become immortal, and unless some untoward circumstances arise, ultimately they will arrive at that exalted state. Their experiences with life may as yet all be base metal, and mostly dross at that. Nevertheless, there is a grain of pure gold within. It is the eternal ego. In due time, under the slow process of nature, all will be changed into gold.

But the spiritual alchemist does not wish to await the slow and ponderous workings of unaided nature. The fact that in centuries to come she will ultimately convert all his metals into gold is interesting philosophically and scientifically, but it does not satisfy his present ambition. He has no desire to await a long process by which additional experiences may be had on the astral plane and through which these and earthly experiences may be more fully assimilated. If he is to have an immortal spiritual body, why wait perhaps countless eons? Instead of permitting nature to do it all in her deliberate way, why not help her? Why not accelerate the process and by intelligently directed effort build up this immortal form so that he may have it now? This is what the spiritual alchemist determines to do.

He, like other alchemists, must have a laboratory in which to labor. The laboratory of any alchemist is determined largely by the kind of work at hand. The material alchemist must have a place where he may keep his furnace, cupels, chemical reagents, retorts, crucibles, test tubes, fluxes, and the metals upon which he experiments. But the spiritual alchemist needs a more comprehensive laboratory. The metals with which he works are the experiences of life. His materials he collects from the whole domain of nature. These he converts to his uses in the laboratory of his own soul.

Salt, Mercury, and Sulphur

—Not because I shall refer to them thus in these lessons, but because they appear in the writings of nearly all alchemists, some explanation should be made of salt, mercury, and sulphur.

It is a cardinal principle laid down by all that these three are the elementary constituents of everything.

The most familiar example of crystallization is that of salt. When Lot's wife, as related in the Bible, looked back, she crystallized. So does anyone who becomes so attached to present objects and conditions that he does not look ahead in the direction of progress. Salt is extensively used. Because of its recognized state of crystallization it becomes a universal symbol of the physical. The physical body is the salt of the alchemist.

Of things that burn with great heat, sulphur is widely recognized. Lakes of fire and brimstone are alluded to from the pulpit. Sulphur, because of its association with intense heat, becomes the symbol of fire. Within all life there is a spark of the divine fire. This eternal spark of Deity that furnishes the energy to impel the soul ever onward in its toilsome journey through the vastness of life is well represented by a more than common fire. The indwelling spirit is the sulphur of the alchemist.

No wonder the alchemists must conceal under universal symbols their ideas from the church; for they believed and taught that not only man but everything possessed of life has not merely a body but a spirit and a soul. The function of this evolving soul is to penetrate the realm of form and gather those experiences that ultimately becomes love and wisdom. Quicksilver penetrates quickly where water will not go. It may be strained through a chamois-skin bag. Of amazing activity, its globules run hither and thither, and actually gather up, or amalgamate with, precious metals. It is like the intellect in its activity and power of acquisition. Mercury is a universal symbol. To the alchemist, when mentioned in relation to salt and sulphur, it signifies the soul.

The First Matter

—Schoolmen well could laugh at the alchemical doctrine of the first matter so long as the various elements of chemistry remained indivisible. Now, however, they know that the ancient alchemists were right; for all the so-called elements are composed of positive electric charges, called positrons, and negative electric charges, called electrons, which are positive and negative concentrations of the universal field, commonly called ether.

The nucleus of an atom embraces one or more proton, which is a combination of positrons and electrons having one more positron than electron, and thus carrying a positive electric charge. The nucleus of an atom may also embrace one or more neutrons, which is a combination of an equal number of positrons and electrons, and is thus electrically neutral.

Around the nucleus, to balance the positive charge on each proton, revolve as many electrons as there are protons in the nucleus. The number of protons in the nucleus is the element's atomic number. Uranium, the heaviest natural element, has 92 protons. Remove 4 of these and the result is radium, which has 88 protons. From uranium remove 10 protons, or from radium remove 6 protons, and the result is lead, which has 82 protons. From uranium remove 13 protons, or from lead remove 3 protons, and the result is gold, which has 79 protons. From gold remove 53 protons and the result is iron, which has 26 protons. From iron remove 25 protons and the result is hydrogen, which has only one proton, and is the lightest chemical element.

The usual approach of the alchemist to the problem of transmutation, however, was not the attempt to knock protons from an atom having more than the desired metal. Instead, the attempt was made to build up the precious metal by bringing together, under proper circumstances, other metals that would furnish electrons and protons in

proper number and under such conditions that these protons and electrons would enter into combination in the numerical proportions of the desired metal. If gold was desired it was necessary to furnish 79 protons and 79 electrons. Although not all the electrons and protons of metals thus brought to the combination might enter into the final product, enough must be available that would enter into the process to build up the necessary 79 pairs.

But merely bringing together silver and lead and tin and other ingredients does not produce gold. The proper ingredients must be present in certain proportions, it is true. But before being transformed into gold they must be reduced to a state which makes recombination of the protons and electrons possible. This is called reducing them to the first matter. The energy used in the process is variously called the universal solvent, the alcahest, the sophic fire, the supreme secret of alchemy, azoth, and the Water of Pythia.

In metallic alchemy the first matter is, of course, field, commonly called ether. And the force applied must be of an electromagnetic nature. It must be an energy which is capable temporarily of overcoming the affinity of the positrons and electrons for each other. These building blocks of the atom must be freed from their present attractions so that they may recombine in a different arrangement.

In spiritual alchemy we are dealing with something still more recondite. We are dealing with spiritual elements. They therefore must be reduced to their spiritual components. That is, a force must be applied that so overcomes their previous internal attachments that they are free to recombine in a different arrangement. This energy, for want of a better name, we term the spiritual light.

To better illustrate what I mean, let us have recourse to simple mathematics. Let us suppose, for example, that the transcendent gold for which we seek is represented by the number 1. The alchemist, then, let us say, has at hand only fractions, representing the other elements from which synthetically he hopes to produce gold. After much research and study he may decide that there are three fractions in his possession that if properly combined will give him the desired gold.

Let us assume these three fractions, representing metals, are $\frac{1}{2}$, $\frac{1}{3}$, and $\frac{1}{6}$. Each of these fractions is a distinct numerical element, differing from the other two. Try as we may we find it impossible to combine them, while they still express their individuality, into one element. Merely to add them as they stand is to produce only a mechanical mixture. Thus do metals, if added together without being first reduced to the first matter, united, not in transmutation, but in an alloy.

But if we reduce these three fractions to their first matter, to a common denominator, they may be added together to give a new and distinct individuality. That is, they may be transmuted. Thus reduced $\frac{1}{2}$ becomes $\frac{6}{12}$, $\frac{1}{3}$ becomes $\frac{4}{12}$, and $\frac{1}{6}$ becomes $\frac{2}{12}$. Now added together their sum is $\frac{12}{12}$. This is no longer spoken of as a fraction, but is the integer, number 1. Here the number 12 is the universal solvent. The alcahest on the mental plane is the astral light. On the spiritual plane it is the spiritual light. As in this instance we reduced to twelfths, so in like manner the alchemist operating on any

plane seeks to reduce his metals by using the common denominator, or Water of Pythia, of that plane.

The Philosopher's Stone

—The chief ends sought by alchemists in various ages and climes were four in number: 1. To perform transmutation. 2. To obtain the philosopher's stone. 3. To find the elixir of life. 4. To accomplish the great work.

The philosopher's stone, according to repute, is a stone that has the power of transforming all it touches into gold.

As the gold we seek is spiritual permanence, and the base metals upon which we operate are the experiences of life as they are gathered day after day, our philosopher's stone, as spiritual alchemists, must be something that touching any experience of life can transform it into a permanent spiritual treasure. It must be capable of giving it the quality that is necessary for it to persist as a component of the immortal spiritual body on the plane yet above the astral.

One thing there is that is changeless. That is gold. One thing there is also that touching other things makes them partake of its all-enduring quality. When truth is pressed against them, the eternal principles expressed by things are revealed, and thus are objects and forces transformed through the process of spiritual understanding, from base objects or experiences into the gold of their underlying spiritual nature.

“The Truth That Sets You Free” is the touchstone of alchemy. But as an intellectual process only it has no freeing power. The truth of any object, experience or force embraces a full comprehension of its various relations. Truth is correct knowledge. This correct knowledge embraces a comprehension of the relation of the thing to all other entities and forces. It embraces a correct knowledge of the relation of the thing to God, to man, and to the universe. It reveals its true spiritual significance in the life of man.

Such truth is a freeing and transmuting power, for when the spiritual relations are completely realized there is more than an intellectual perception. There is also present an emotion, a feeling of the stupendous privilege of life, and deep gratitude for its glorious opportunities. When correct knowledge is fully realized within there springs into existence as a component part of it, as the things inevitably conditioned by its presence, a deep aspiration, and an unutterable longing and determination, for a higher and better method of living. This Truth is the Philosopher's Stone.

The Elixir Vitae

—The fountain of eternal youth has been sought in many lands. The alchemists,

instead of exploring the earth in the hope of finding it ready prepared by nature, undertook its manufacture. They diligently worked to prepare a fluid which they styled the elixir of life, in which to bathe and indefinitely prolong both youth and existence. With the philosopher's stone they would change other metals into gold. But to be able to enjoy this gold they must have life. To reap its advantages in fullness, old age must be defeated and death defied. Therefore, to perpetually rejuvenate themselves, they must prepare this most precious elixir.

It was the policy of these alchemists, whatever they sought, to follow closely, though striving to accelerate, the processes of nature. Watching her, they could only decide that life wherever found springs into existence through the interaction of positive and negative potencies. Where sex is not there is no life.

The life of each atom of matter depends upon love. For instance, the sum of the components in the helium nucleus, or alpha particle, is 4.0332 mass units, yet the actual mass of helium is only 4.0027 units. Thus considerable of the mass of the components is converted into binding (love) energy. The binding energy of such an alpha particle is 28,000,000 electron volts. And it is the binding (love) energy released in the fission or in the synthesis of certain atoms that is the source of so-called atomic energy.

Mineral crystals are sensitive to poison, grow, and reproduce themselves. They are made up of atoms. These crystals continue their lives until, through age or other polarizing forces, the love of the atoms for one another is overcome. When such attractions cease the crystal disintegrates.

In the vegetable kingdom, also, the power of growth and duration depends upon the strength of the attraction between the cells, and their love for the nutritive materials carried to them by circulating fluids.

All life, thought, and activity are the result of sex. Sex expresses itself as movement, as fire, as passion, as enthusiasm, and as exalted unselfish love. It is convertible. It may be base and ignoble, or it may ascend to the very throne of Divinity. But wherever there is life there is some form of love.

The alchemist, then, perceiving that life is dependent on love concludes that spiritual life must depend on a spiritual love, and that immortal life must depend on an immortal love. And what so quickly can restore youth as love? Even the surgeons endeavoring to restore youth and prolong physical existence by transplanting tissues, utilize in a material way this principle; for they use the glands associated with love. The problem of the spiritual alchemist who seeks the coveted elixir thus becomes clear cut and definite. Life depends on love, and immortal life in a spiritual realm depends on an enduring spiritual love. It is this love that he seeks to find.

The Great Work

—Many think that the possession of the fruit of the great work comes by chance, that

it comes without much effort, or that it is given by nature to the unworthy.

My own observation of life convinces me that this is a pernicious fallacy. The very few whom I have known who came into its possession certainly well merited any blessing that life could offer. Invariably they had accomplished some important task for the welfare of society. Through their interest in, and concern for, the advancement of others they had blended the finer emotional elements within themselves into the precious elixir of life. They already had quaffed the immortal fluid.

The alchemist, also must have been convinced that it comes only as a result of some special effort. Otherwise they would not have called it a work, but a recreation.

This great work, about which so much has been written, is the reunion of twin souls in the spiritual realm. As such it is the highest result of spiritual alchemy, because after thus united their potencies expand and they move from the highest level of the spiritual plane to angelic vistas that are beyond the imagination of embodied man. The union that results from the accomplishment of the great work is more than a fusion of the spiritual bodies that already have been constructed by each. It is a permanent union of souls.

No such fusion, even of spiritual bodies, can take place until there are spiritual bodies to fuse. How can there be any recognition of a spiritual union by those who as yet have not expanded their consciousness sufficiently to contact the spiritual plane? The greatest truth may, by its very greatness, be the most potent snare when misunderstood. Feeling an intense attraction for another, it is easy to imagine the soul-mate has been found. Most such affinities are merely the result of magnetic attraction.

The great work can only take place when an active soul is capable of functioning in a well-constructed spiritual body. Few people have as yet such active souls, or such fully formed spiritual bodies. When such a spiritual body has been constructed by an active soul, there is no need to wander about looking for the soul-mate; for by virtue of this spiritual activity alone they are bound to be attracted one to the other. Therefore, let those who long for the soul-mate learn that mere wishing and seeking will never suffice; for it is an accomplishment requiring the utmost spiritual effort. Let them remember that alchemists call this reunion of twin souls the Great Work. The first step in its accomplishment is to build up the spirituality. This is the task of spiritual alchemy.

Chapter 2

Serial No. 50
Original Copyright 1931
Elbert Benjamine

Copyright
Church of Light
August 2002

The Seven Spiritual Metals

Chapter 2

The Seven Spiritual Metals

THE conception of life held by the spiritual alchemist is quite different from that ordinarily held by the man of affairs. The events that spring into existence as the result of his contact with external environment are viewed from an entirely different angle. Instead of being considered in reference to their value as factors contributing to physical survival and physical gratification, they are scanned from the height of their cosmic relations. Their worth is estimated by the measure in which they further the development of the soul and are of assistance in cosmic welfare.

Through illustration let us draw this line of demarcation clearly: From the material point of view, for instance, a man is considered to be unusually lucky when he inherits a fortune. It is common to speak of a man as highly successful when he has obtained eminence in the political field. And a man who builds up a large and prosperous business is deemed one to be envied.

View of the Spiritual Alchemist

—But the spiritual alchemist jumps to no such hasty conclusions. He realizes that if we are ever to appraise anything justly we must delve deep beneath the surface of appearances. Things are often not what they seem at first glance. After all, environment and circumstances are effective only as the individual responds to them. The good and the evil reside not in events and external conditions, but in the effect they have upon the individual. The development of character is more important than physical gratification. Therefore, before saying of any event that it is fortunate or unfortunate the spiritual alchemist first looks to the more important factor, which is its effect upon the character, its contribution to the growth of the soul.

A material fortune may be used as an aid to soul progress, but observation inclines to the belief that more often than not it is a spiritual hindrance, therefore alchemically a misfortune. A high political station sometimes engenders bigotry, pride and arrogance, and is then alchemically a failure. And so prosperous a business as to keep the attention absorbed by worldly affairs to the exclusion of intellectual and spiritual interests, reveals to the alchemist a condition that excites pity rather than envy.

Not, it should be clearly understood, that the spiritual alchemist believes wealth, business, political station, or other worldly affairs evil. To him events, worldly affairs, or other interests are neither good nor evil, fortunate nor unfortunate, in themselves. They become good or evil only through their influence on soul culture. But quite often the things mentioned become unfortunate in individual cases because they are permitted to impair the development of the soul and hamper its progress.

The Cosmic Man

—The spiritual alchemist conceives the universe to be an immense organic structure, or cosmic man. He perceives that individual souls are evolving from lower to higher states, and entering into rapport with the whole cosmic scheme. He apprehends that a like process is going on in it, and that the universe also is evolving and eternally unfolding its infinite possibilities of expression.

In tune with the pulsating heart of nature, an inner conviction floods his consciousness that every immortal soul plays a part and has its function in this glorious scheme of creation. It is a living conscious cell within the body of Infinite Man. Expanding its consciousness, as for the moment he has done, it may even partake of the greater consciousness of the all. Thus the ineffable plan unfolds before him. Each immortal soul perpetually expands the domain of its consciousness and continually increases the power of its control over environment. The separate evolving units thread together to give more complex expression to universal consciousness and power. As a man becomes stronger when the separate cells of his body gain in vigor, so the expansion in power and more complete cooperation of souls, lend increase of consciousness and power to the Cosmic Man.

Man on earth needs the separate cells of his body and the separate thoughts of his mind. Each has a real and important function to play in his economy. If any are missing, or if they are present but attempt to do the work of others, or fail to do the work assigned to them, the man, as well as the cells, suffers. Grasping, by his peculiar rapport with the inner planes of life, the relation of parts to the whole in the universal scheme, the spiritual alchemist perceives that likewise every immortal soul has its place and somewhat important function. Universal intelligence depends for expression on the sum of separate intelligences, even as man depends for mental expression on his separate thoughts. Not only does man need God, but stupendous thought though it be, there is need of God for man.

Now within the physical body of man, due to his life processes, there are secretions that to avoid disease must be eliminated. Within the domain of his mentality are thoughts that must be expunged to avoid intellectual decay and moral dissolution. We may be sure, therefore, that like conditions exist in the cosmic man.

But most of the physical subjects and physical entities embraced within man's empire work for the welfare of their liege and lord and obey his commands. These harmonious, constructive atoms of physical and psychical life within man's

constitution are the bulwark of his strength; and realizing this he cherishes, supports and encourages them, happy to have them make their homes permanently with him. Thus also, the spiritual alchemist believes, the Universal Creator cherishes, supports and encourages those who assist His work, and takes pains that they shall not perish and that no real harms shall come to them.

Other entities within the scope of man's dominion there are that on almost every occasion stir up dissention and strife. These disobedient, disloyal and disintegrative subjects he finds it necessary to discipline; or if they become too arrogant, and thus threaten the whole estate, they must be deported or completely destroyed. The surgeon's knife may be the only recourse to save the life. And in the wider realm of cosmic affairs, the spiritual alchemist perceives rebellious souls, which like Lucifer would usurp the supreme authority to themselves and make selfish gratification the highest law. These, he feels sure, are not permitted to endure in their wayward course. Their continued existence depends upon a change of attitude. Only those persist that have some value as constructive workers in carrying out the Divine Plan.

This peculiar, pervading, insistent consciousness attained through spiritual alchemy reveals, in a manner not to be denied by anyone having the experience, that the Universal Mind has formulated a plan for, and commenced the erection of, the Universal Structure. It informs him in terms of deep conviction that to oppose the advancement of this cosmic plan is to throw himself athwart the tides of universal life with the surety that if the course is not altered they will carry the soul into the realms of extinction. Yet it assures him also of a tremendous immortal career if he becomes a constructive part of the eternal plan. Uniting with Deity, he partakes through association with deific work of the perpetually expanding life and consciousness of the infinite.

Thus it is that the spiritual alchemist painstakingly scans the universe in the effort to discern the ineffable plan. He carefully studies himself, and assays all his qualities and opportunities, to the end that he may find just where in the cosmic work he can be of greatest service. To be of the greatest possible service in furthering God's Evolutionary Plan becomes the absorbing aim of his life.

Thus it is that he walks among men, seeming not different greatly from others, yet taking in regard to most things a diametrically opposite view. For while ordinary men reflect upon every act, motive and event in terms of their being advantageous or inimical to material success, he regards all these things from a cosmic standpoint, as constructive or destructive factors in universal life.

Instead of seeking life eternal from the desire merely to persist in consciousness, he aspires to immortality because he realizes that he may become a valuable workman in the manifestation of the infinite plan. He is a willing laborer under the direction of the Universal Mind and his loss would be keenly felt by the progressive legions. He struggles spiritually to endure, not for himself alone, but to add his energy and strength to those cohorts that favor immortality for mankind and that strive to uphold law and order throughout the universe.

Believing that the progress of Deity depends upon the progress of the various souls and entities embraced in the structure of the Universal Man, he considers his own intellectual and spiritual development the training to become a workman of greater skill and value. It is his duty to advance toward perfection, his duty to God above, to innumerable degrees of life below, and to mankind as a whole. Every act of his life is examined, not for its material effect, but for its influence as furthering his soul development and the cause of human progress. Every spiritual victory redounds not merely to his own credit, but places in his hands new powers that he may use to benefit his fellowman. Thus life itself is reduced to the spiritual first matter and its component parts evaluated by their fitness or unfitness to enter into the composition of transmuted spiritual gold.

The Soul Has Infinite Possibilities

—Millions of experiments carried out in various universities relative to extrasensory perception prove that the unconscious mind, or soul, is able to gain information from the past, in the present, from the minds of others, and from the future, in a manner that is contrary to physical laws. The academic scientists who have carried out innumerable experiments with extrasensory perception hold that from this faculty apparently no secret of nature nor any information in the universe can be hidden. Any knowledge desired, whatever it may be, of past, present, or future, seems to lie within the range of its acquirement. And after the dissolution of the physical, the freedom from its restrictions permit the soul more freely to use extrasensory perception. But even as on earth, where restrictions are greater, it there requires training to be able to get certain information and it requires training to understand the information contacted. Thus there is no implication that physical death gives the soul more wisdom than it had while on earth. But the indications are clear that the possibilities of gaining knowledge after life on earth is done are infinitely greater.

The experiments in various universities with mechanically released dice prove the non-physical power of the mind to move physical objects and to bring about desired physical conditions. This power, called psychokinesis, when effectively brought into play, eliminates the laborious physical processes commonly required to build something, or to bring about certain results. And the academic scientists who have been experimenting with it say that so far as is known there are no limits to what can be accomplished through this non-physical power of the mind. This does not imply that merely because it loses its physical body the soul then can move wherever it wishes and build whatever it desires. But because the restrictions of the physical body to exercising psychokinetic power are removed, its possibilities of accomplishment after physical death are infinitely expanded.

Thus do the experiments in our universities relative to extrasensory perception and psychokinesis indicate that after physical dissolution the possibilities of gaining knowledge, and the possibilities of accomplishment, are infinitely increased; and that, therefore, if the soul so desires, and will put forth the effort, it can move forward

continuously to become a more effective workman in the realization of God's Great Plan.

The Components of Gold

—To make gold not only must all the materials of which it is composed be present, but before the transmutation is perfected all must be there in proper proportions. If we apply the law of correspondences it brings the conclusion that there are seven of these necessary factors. Seven colors of the solar spectrum combine to produce white light. Seven tones of the scale combine in the production of music. Seven planets constitute the septenary scale of astrological influences. And thus, as seven is present in those things expressing perfection of form, even in the septenary constitution of man, we may safely conclude it enters into the composition of gold.

Man, the climax and point of departure of animate forms on earth, contains within himself the attributes of all life lower in the scale of being. Gold, the climax of the mineral kingdom, and its point of departure to a higher kingdom, likewise, contains within itself the qualities and attributes of all the other metals. These qualities, even as all shades of color are contained in the seven prismatic rays, are grouped in the seven typical metals that most strongly vibrate in unison each with one of the seven planets of our solar system.

To enumerate: Gold itself vibrates to the Sun. Silver vibrates to the Moon. Mercury, as made reference to in alchemical works is of two kinds, the metallic Mercury and philosophical Mercury. The philosophical Mercury symbolizes the soul within, but the Mercury with which we are here concerned is somewhat more external. It vibrates to the planet Mercury. Copper vibrates to Venus. Iron vibrates to Mars. Tin vibrates Jupiter. And Lead vibrates to Saturn. Within these seven are the qualities developed by all metals, the qualities that enter into the composition of gold. Therefore, if they are combined in proper proportion, and properly acted upon alchemically, the product is transmuted gold.

Following the same steps, but using the metals of spiritual alchemy, we are sure to get the same results on the spiritual plane. These metals of spiritual alchemy are the various experiences of life. All, according to type, fall into one of several natural divisions. That is, the white light of life's combined experiences may readily be separated by the prism of astrological correspondences into seven distinct groups, or colors. But before there can be the real white light we are considering there must be present the rays of all seven colors. Before there can be transmuted gold, there first must be brought together all seven of the essential metals. Likewise, we may be sure, before there can be spiritual gold, there must be the seven types of experience with life.

These seven metals, or groups of experiences, must be collected. They can not properly be used in just any quantity, but only in certain proportions. They must be purified and separated from their dross. To lower their fusing point they must be

properly combined, or fluxed, one against another. Then, to reduce to the first matter or spiritual substance, the heat of the reverberatory furnace of their cosmic usefulness should be applied. If these steps are all followed the experiences flow together to form an organized spiritual form, complete in all its functions, an immortal body, which is the sought for spiritual gold.

Therefore, as all seven spiritual metals are necessary in the exalted process, and as all must be raised in vibratory rate by the action of the reverberatory furnace, let us consider separately the nature and relation to cosmic welfare of each:

Lead

—The first metal to be studied, because the most base of all, and therefore the most difficult to reduce to spiritual first matter and transmute, is lead. It is under the dominion of the planet Saturn. We deal, consequently, with all those motives, thoughts, feelings and experiences that are brought into the life and prompted by this most malefic of the planets.

As a mineral lead is heavy, dull and morose; and the planet Saturn brings to the life heavy responsibilities, dull plodding labor and a melancholy disposition. It is a metal of extreme malleability, and in life is noted for diplomacy. It quickly tarnishes; incites, that is to petty ignoble actions; and stands as a synonym for great specific gravity, or selfishness.

A major portion of the diseases, sorrows, losses, obstacles, restrictions, poverty and disappointments in the world are due to its influence. Under the most favorable conditions it brings gain; gain as the result of painful planning and plodding perseverance; intellectual supremacy through ample reflection and careful thought; and worldly station through subtlety, craftiness, cunning and unusual foresight.

Without this lead in his constitution man would be destitute of caution; would act without considering the result, would buy without thought of the cost, and would make no provision for the future. He would be headstrong and rash, governed entirely by momentary impulses, and incapable of forming logical conclusions. In spiritual alchemy also it is most important; for the sorrows it brings tend to chasten the soul and may effectively be used to eliminate the dross of sensuality.

Before being reduced to its first matter or purified the typical leaden viewpoint of life is made lucid in the much repeated formula that self-preservation is nature's first law. It is the idea of self-interest; and to be sure, self-interest on any plane is essential to survival; for without desire for life and progress the soul soon succumbs to disintegrative force. But this is only a partial statement of the more complete law of life. That is, it is only mental lead, still dominated by the thought that all may sink if I may swim.

The more complete law takes recognition of the interdependence of all life and the effect of mental attitudes on character. When life is viewed from the standpoint of

spiritual lead the formula is that my only excuse for existence, and my only hope of survival in spiritual realms, is my value to cosmic society and the service I render to others.

This means that from the alchemical standpoint selfishness always defeats its own ends; for as we strive to aggrandize self at the expense of society the power of the soul dwindles and we attain less in spirituality. But when we labor for the welfare of the whole cosmic structure with no thought of our individual interests except in so far as they are essential qualifications for efficiency in unselfish work, we really gain; for we are adding values to the only real and permanent part of ourselves; to our characters.

Lead will be lead, and selfishness will be selfishness, and the only way to convince Saturn that he is wrong is to convince him that selfishness does not pay. Let him think as is commonly taught, that if he is uncharitable here he will be dealt with harshly in the after life and he will loosen the strings of his purse. Give him to understand that if he does good here on earth he will be rewarded by a soft berth in heaven, or that whatever acts he performs for or against others will be performed for or against him in a future incarnation, and he is shrewd enough to perceive the selfish advantage of doing good upon the earth. Such appeals are made directly to the lead in man.

The spiritual alchemist also operates upon this mental lead, but in a different fashion. Man is selfish only through ignorance; for in his narrow mind persists the idea that it is possible for one to gain some real advantage at the expense of another. Nothing is farther from the truth; and the attempt to do so invariably results in loss greater than the apparent gain.

To deprive another unjustly of money does not necessarily weaken him; for if he takes the correct mental attitude toward this loss, what he gains in fortitude may more than recompense him for his material inconvenience. This depends upon the person. But one thing is as certain as the rising and the setting of the sun. It is that such an unjust act reacts upon the character of the doer and impairs the vitality of his soul. Just as Saturn in a birth-chart afflicting the luminaries impairs the physical vitality, repetition of such acts will cause chronic diseases that waste the spiritual tissues as certainly as tuberculosis destroys the body. Every selfish act of life means bartering immortal gold for sodden material lead; for material riches and advantages dishonestly gained weigh down the soul and impair its progress, even as lead carried about the person hampers physical action.

To act selfishly, when viewed by the torch of knowledge, is really to act directly contrary to self-interest; for the real self-interest can not but place a greater value upon character, which may become an immortal asset, than upon the ephemeral gain of material things that last but a matter of days. To act unselfishly, when internal relations are considered, is to act in the direction of greatest self-interest for it builds up the eternal qualities that persist when all earthly wealth has decomposed into the star-dust from which it came.

Thus selfishness and unselfishness to the spiritual alchemist become synonyms for

ignorance and wisdom; for each really defeats its own purpose. We can not act selfishly without injuring self, nor can we act truly in an unselfish manner without benefiting self. Lead is lead, and to dissolve lead in the spiritual light we must place it in the reverberatory furnace of its cosmic relations. By appealing to selfishness it then becomes convinced of its folly and perceives that golden unselfishness far outweighs in value the leaden advantages of physical life.

Tin

—Tin is a metal of silvery-white color, malleable, ductile, and offering considerable resistance to the corrosive action of acids. It is under the dominion of the planet Jupiter, and has a low melting point. It corresponds in human life to such pure and noble moral sentiments as are of snow-white luster. True nobility of impulse itself is incorruptible, but quickly bends in malleable charity to assist a fallen brother. Its sympathies are drawn in filaments of mercy to the downtrodden and oppressed; and its dignity and reserve are melted at the sight of suffering.

Tin, or Jupiter, is the major benefic, bringing to man health, wealth and affluence. This gain comes without effort, or as the result of favor inspired by good deeds. It is far removed from all that is sordid and harsh, indicating instead good cheer, genial warmth and generosity.

Without tin, or Jupiter, the life of man would be stern and severe. There would be little inclination to assist others, little thought for anything save self. There would be no religion, and no charitable institutions, no paternal kindness, and no mercy. Lead demands payments with usury. Iron demands “an eye for an eye and a tooth for a tooth”. But tin rises to a higher law that permits it to return good for evil. Its thought in life is to live and let live. It aspires to extend the helping hand to all mankind and lift them up through sheer nobility of purpose.

We might be led to think that tin, being such a magnanimous metal, is already in a state bordering on spiritual gold, but as a matter of fact it is somewhat destructive, and also contains much dross that must be purged away in the fires of affliction. Those who pass through life without enduring the sorrows of lead, never knowing poverty and illness, ever being cared and provided for, have not the plodding steadfastness necessary for real spiritual attainment. Those who are guarded from all dangers, hedged in by protecting influences, never knowing the strife that comes from iron, have not the aggressiveness, initiative and daring courage to wrestle with the dweller on the threshold and wage a war of conquest against the angel of eternal death.

Tin is proof against the acids of envy and the inroads of remorse; but can not withstand the heat of dissipation. It is a wondrous and virtuous metal; but virtue being misapplied becomes a vice. It is a less difficult thing to give, than to know how to give wisely. To assist others to persist in idleness by unwise giving is as great an error as selfishly to withhold help from the deserving. When a hard struggle to secure

bare necessities is a requisite to enable a man to find his own powers, it is a misdemeanor to furnish those necessities gratis. To encourage dissolute habits by furnishing the wherewithall to gratify them is to become a party to the fault. To give well requires as great sagacity as to acquire the wealth to give.

To act with true generosity is a far more complex matter than is commonly recognized. To be really merciful is not merely to gratify the physical needs of others for food and shelter. It includes more than caring for the sick and providing material education. It necessitates a comprehension of the soul needs of the individual and the satisfying of those needs. It embraces the spiritual meaning of not to spare the rod and spoil the child. Tin must abundantly be present in the storehouse of the spiritual alchemist; but after he combines it with the other metals, before it enters into the composition of transmuted gold it must be resolved in the spiritual light to its first matter.

To apply properly the heat of the reverberatory furnace he must have the spiritual discernment to foresee the result of his action upon the character of the individual before he extends his hand in help. He must know what assistance the soul needs, and render first aid to the immortal part of man, using material means to accomplish a spiritual purpose.

When tin is too largely present it brings an attitude of "I am better than thou"; a feeling of righteous pride and belief that good befalls through some inherent superiority. The evils it encourages are luxurious living, love of display, and an excess of generosity.

Iron

—Both lead and tin are soft metals, yielding readily to pressure from the outside. Mercury ordinarily is a fluid; and copper, silver and gold, while having a hardness greater than tin and lead, are not unyielding. Iron, however, is a hard, severe metal capable of great resistance.

It is harsh and gray, with a forceful character; but turns to an angry red when exposed to the attacking influence of the elements. Under the heat of affliction it gives way slowly, having a high melting point; and when so heated and suddenly cooled is distinguished for developing a temper. With the temper so aroused it is decidedly self-willed, and can not be forced to deviate permanently from the course or form it has chosen to assume. So great is this aggressive determination that it may be brought to a state of temper where if bent from its original shape it instantly returns to it, as observed in springs, the instant the compelling pressure is removed.

Iron, or Mars, is the minor malefic, furnishing man with energy, courage, resistance, aggressiveness and forcefulness. Other metals are good electric conductors; though of course, lead is too miserly to permit an electric current to flow through its domain without niggardly opposition. But iron has the distinction of itself, either

permanently or temporarily, becoming magnetic. It thus exhibits an independence and force not possessed by other metals.

Its great resistance and headlong impetuosity fit it preeminently to become both a tool in the hands of a worker and a weapon in the hands of a warrior. In fact, it may safely be said that all work and all conquest depend upon the amount of iron present; for if iron is lacking there will be insufficient energy for any worth while accomplishment. Without it any combination of other metals is weak and vacillating and altogether too pliable to serve purposes other than to be molded by such objects as they contact. Consequently, it is very important in spiritual alchemy that there be plenty of iron in the metallic fusion. Yet we can not use iron in its common corrupted state. First the rust must be removed and cast aside.

Iron in character represents the selfish and animal propensities and the destructive and constructive faculties. Without iron man would be a constant slave to fear and anxiety; he would lack the ability to struggle to attain his purpose, and be in a state of perpetual dread. It commonly manifests in life as intense desire. But as action is ever in the direction of the strongest desire, the effort should never be made to kill desires, but to divert them into channels that are individually constructive and that work for the welfare of all.

No great thing was ever accomplished without enthusiasm, and where iron is not, neither is there enthusiasm. Survival depends not merely upon lead, or caution, but also upon iron; upon the ability to dare and fight and struggle and resist outside influences. Even temper is a most valuable asset, when well controlled; for it permits of an elastic rebound. A man with this kind of temper can never be kept down; for he rises as soon as he falls. He no more accepts defeat as final than does the steel spring when it is flexed.

Iron is valuable alike for destruction and construction. But to be useful in spiritual alchemy it must be reduced to its first matter in spiritual substance. It must be used not merely as a weapon of physical defense, but to destroy the pernicious and licentious thoughts that menace the soul. It must be used to tear down and destroy such forms of belief and such social conditions as threaten the spiritual life of society; and tempered to a sword of finest steel it must be turned against the legions of darkness that infest the lower astral realms. Placed in the reverberatory furnace, from time to time, it must then be forged into an implement of construction. Positive, aggressive spiritual thoughts must dominate the soul, must labor to spread the light of truth, must incite to persistent effort in behalf of society, and must become true constructive instruments in the erection of the edifice of the cosmos.

Copper

—Copper is a metal of reddish color; soft, pliable, yielding, and a good conductor of heat and electricity. It is even a better conductor of electric force than iron, but is incapable of retaining that force and itself becoming energetic. Iron is a harsh,

forceful metal, but copper is mild and gentle. It presents a pleasing comparison to lead, being bright, cheerful and happy; while lead is somber, gray, sullen, reserved and frowning. Like tin, copper exhibits most pronounced virtues when associated with other metals. It is truly the metal of union, for it is always more contented when alloyed with another. It thus entirely lacks that independence of character that distinguishes iron, and must ever have a stronger companion upon which to lean. As a component of bronze it is of great value in the arts.

Copper, or Venus, is the minor benefic, furnishing man with compassion, affection, refinement, and a love of the artistic and beautiful. It lends a pleasing aspect to every metal with which it associates; in human life bringing friendship, mirthfulness, amiability and conjugality. It is especially useful in brazing, that is, strengthening the union between other metals or between their parts. Similarly it exerts itself in society to draw people into harmonious companionship. It is the metal of love, presenting, when uncorrupted, the bright and cheery aspect of good will; very unlike the hard gray tone of iron which normally is cold and cruel and when exposed to the elements becomes a dull passionate red. Copper, however, while less easily tarnished and sullied than iron, is readily affected by acids of various sorts. When so attacked it degenerates into the vile verdigris of jealousy; a slimy green corruption that soils wherever it touches.

In this impure state it is a rank poison which may be used as a paint on boats to destroy barnacles, as the diseases it engenders spread in the dissolution of the barnacles of society. Or, as paris green, it is sprinkled on growing vines to kill the insects that infest them. The parasites among the human race also fall victims to its virulence. It was this noisome poison, the product of corrupted copper, that resulted in the downfall of Rome. The paris green of luxury and licentiousness ate into her vitals and poisoned her soul, and she fell through weakness, her vitality so sapped by this noxious impure copper that she was left an easy prey to outside foes.

Copper, in spiritual alchemy, represents experiences with love, sympathy and affection. The world would be a harsh, bleak land without the refining influence of copper. There would be no appreciation of beauty, no knowledge of harmony; none of the softer shading of life that soothe the sting of adversity. There might be the joviality characteristic of tin, but ties of love and affection would be lacking. There might be strenuous action and fiery passion springing from iron, but no grace in those movements, and only selfishness at the base of desire. Without copper the world would be the scene of perpetual conflict, of strife without surcease; for it is the metal of peace. It is the only direct antidote for a surplus of lead; for in so far as love is present selfishness departs. Its peculiar property is that of giving strength and endurance and life to other metals, such as bronze, which is an alloy with tin, and to brass, which is an alloy with zinc.

In alchemical combinations also it lends itself to permanence, and a magical ring or an amulet of metal to retain its potencies must not only contain gold and silver, but a small portion of copper. It is the love element which retains the magical force and binds the gold and silver in permanent union, permitting the interaction of magnetic

forces between them. The organs of the body retain their life and perform their functions only so long as organic copper unites the separate cells that compose them and binds new cells to the old to replace those decomposed by iron; disintegrated by rust. There can be no complete and permanent union on any plane unless copper is present as the binding material. Transmuted gold is produced from a union of other metals.

The importance of copper can not be overestimated in spiritual alchemy. While impure it can not be reduced to the first matter; for the spiritual light finds no point of contact with copper that is corrupted. But when pure it resolves, with almost no heat from the reverberatory furnace, into the spiritual state. In this condition it readily enters into union with other spiritualized metals, and never fails to add to their utility. It is very easy to mistake other elements for pure copper, and the spiritual alchemist must take unusual pains to secure it undefiled and in ample volume thoroughly to bind together the other metals. But when once obtained, many of his difficulties are over, for it is not difficult to transmute.

Mercury

—Mercury is notable among the metals in that at ordinary temperatures it is a fluid the particles of which are set in rapid movement by the least outside influence. The fleetness of its drops as well as the swiftness of the planet, is well symbolized by the wings on the feet of this ancient messenger of the gods. A little quicksilver spilled in the laboratory and its drops are everywhere, elusive, quick moving, and of brilliant silver-white luster.

Mercury is the planet of the mind, and mercury is a metal of wonderful penetration. Its particles readily find egress through substances that are impervious to other metals. It may be strained through buckskin, or even through a chamois-skin bag, and the minutely divided particles will again immediately unite; even as man's thoughts penetrate the inmost recesses of nature and after their separate work of exploration collect again to become a conviction. The perceptions of man are many diverse beads of quicksilver which when brought together unite in a single shining concept. It is the most unstable of our metals, and volatilizes at a very low heat into white vaporous fumes. Similarly are man's thoughts quickly accelerated by the fires of enthusiasm, to soar aloft into more tenuous realms, leaving the dull cares of earth behind. Thus also, under the heat of impassioned idealism, do they rise to the altitude of eloquence.

Mercury is a volatile, changeable, fickle, persuasive metal. Being liquid, it conforms to every surface upon which it rests, and readily adapts itself to every circumstance of life. Nor does it stop with mere conformity to contour, but has the peculiar property of forming amalgams with other metals. So blended it takes upon itself the properties and qualities of whatsoever metal with which united. So also is the mind of man colored and influenced by its contact with the external world. Its trend at any given

moment is governed by its transitional contacts, which operate upon it through the well known laws of association.

Mercury has a wonderful power to reflect light; and for this reason is used as a coating for mirrors. The mind, likewise, has the power of reflecting, mirroring on its surface the image of all it perceives in its contact with the world.

When heated, our metal is converted into a white gas which has a number of uses in common chemistry; almost as many as have thoughts inspired by zealous enthusiasm in the chemistry of the cosmos. But these fumes when breathed produce in the human organism a peculiar blackening of the gums, called salivation; accompanied by the falling out of the teeth. The teeth and bony structure of the body come under the dominion of lead. They correspond to that which is practical. The mind, or mercury dominated by religious enthusiasm, or by mystical zeal, sometimes becomes feverish and the thoughts volatilize into imaginative vaporings. These mental fumes attack the social structure and result in loss of practicality. Man should not forget that so long as there is a physical body to nourish he has need of teeth with which to masticate physical food. To inhale the fickle fumes of imagination in too great quantity is to get too far from earth; is to become an invalid and a burden to society through speculative salivation. That is, when he loses sight of the practical, he becomes a romantic visionary, lacking teeth with which to attack the essential problems of everyday life.

The reflective powers of mercury are utilized in medicine to eliminate the impurities from body, just as they are used mentally to purify the mind. I refer to the purgative, calomel, which is a compound of mercury and chlorine. Chlorine is an acid which readily attacks all metals. Mercury in combination with chlorine partakes of its nature and attacks and eliminates from the system whatever it directly contacts.

Calomel is the purgative most prevalently used by physicians of the old allopathic school of medicine, and is the method almost exclusively employed by the old school scientists. On the mental plane it is the power of destructive criticism. More progressive investigators have arrived at the conclusion that in many cases it does more harm than good, injecting a deadlier poison than the one it removes. This is true in science as well as in medicine; for the criticisms often do not discriminate between the refuse that should be removed from the physical and mental constitution and those valuable tissues upon which life itself depends.

The spiritual alchemist utilizes both the penetrative, or perceptive, qualities of mercury, and the reflective attributes. He learns the nature, purity, and value of other metals by associating them with mercury. Amalgams with other metals are not impurities. But all perishable elements, those not grounded in the very truth of things, are impurities. Mercury may readily be dissolved into the first matter in the reverberatory furnace; but it first must be freed from impurities.

Silver

—Silver is a bright, white metal that, although readily attacked by certain acids, does not tarnish under ordinary conditions. It is one of the so-called precious metals, and as such is used for currency among civilized nations. In the human body it is represented by the nutritive functions. Both in society and in the life of the individual, gold supplies the vitality and silver furnishes the food for subsistence. Nations rely upon gold as the bulwark of their financial structure; but silver is the medium of exchange with which homes are supplied with food, and which keeps the wheels of industry turning.

This metal is ruled by the Moon. In spiritual alchemy it is the domestic impulses and the experiences with parenthood. These experiences when properly purified need but little heat from the reverberatory furnace to reduce them to the spiritual first matter. They then become, indeed, the nutrition of the soul. Children, to be sure, require watchful care: but responsibilities have a way of developing the ability successfully to bear them. But the chief value of alchemical silver is in the awakening of tender affections that are untinged with self-interest. Parental love is one of the most potent agencies known for displacing selfishness with devotion to the welfare of another. It thus gives a foretaste of the blessed after-life commonly spoken of as heaven.

As silver is very negative, that is, plastic and yielding, too much of it impairs initiative and hinders transmutation. Yet is unusually durable, as witness its use in coinage; for it corresponds to imperishable factors that persist even into the life to come. Parenthood and the home are not merely institutions of earth, but correspond to spiritual verities. Domestic life is something more than just a social expedient. It is the material shadow of conditions on the spiritual plane that hold the most glorious possibilities.

In addition to being receptive and a good conductor of heat and electricity, silver has a markedly pleasing resonance. This resonance is exemplified in the lives of those who expand parental love to embrace some larger section of the human race. These beneficent individuals respond to and vibrate in unison with pulsations emanating from the spiritual plane. This kind of silver readily enters into the composition of transmuted gold.

Gold

—Gold is a bright glittering metal of imperishable nature. It is unattacked by any single acid and is unaffected in its quality by fire. These unusual qualities are its mark of distinction, and we search for them throughout the material realm and in the character of man to find that which is capable of being converted into gold. We may be sure that whatever partakes of these qualities, and only such things, therefore, as

are immortal and imperishable, may become a permanent part of the body of spiritual man, and thus be transmuted into gold.

Gold is ruled by the Sun, and thus represents also the vital principle of all life. It is the central, governing authority, the foundation of the financial structure of society, and the source of power both in physical and in spiritual man. The natural gold in the human constitution is the ego, imperishable and as pure as pristine sunlight. But there is another gold that is not the ego, yet that partakes of its enduring nature. This is not the material gold that some strive to make in the chemical shops of the earth. It is a spiritual gold, that is, a gold like unto the ego in its spirituality and continuance. It is even possible to convert, through proper purification, combination and heating, every event of life into this most precious metal. It is possible to use every experience as spiritual metal that enters into the building up of a spiritual form. This immortal body is the transmuted spiritual gold.

Chapter 3

Serial No. 51
Original Copyright 1931
Elbert Benjamine

Copyright
Church of Light
August 2002

Purifying the Metals

Chapter 3

Purifying the Metals

TO become a spiritual alchemist one must take a very different view of life from that held by the rest of the world. Life and all its experiences must be considered from the inner plane of realities; for realities alone can be raised in intensity of vibration to the plane of spiritual substance and there persist as portions of the immortal spiritual body.

The attachment to appearances must forever be severed. When seen from this higher plane the things upon which more worldly people dote, and for which they ceaselessly toil and struggle, are recognized to be but the dross of life that must be skimmed from the various molten metals of experience and cast into the waste of perishable debris. These very things that men set their hearts upon, when more closely scrutinized, are observed, to be but the scum that rises to the surface of life's purer metals when they are melted by the fires of the reverberatory furnace of their cosmic relations. This refuse must be skimmed from the pure and transcendent values that lie beneath it and cast to one side; but the metals themselves, thus recognized and separated from the dross, should be preserved with the utmost care as priceless spiritual possessions.

Every experience of life from the cradle to the grave; yea, and every experience of the life to come when the soul shall have passed through the river of physical dissolution, is composed of two parts, real metal and corruptible dross. And it is possible with each experience to separate the dross and the real metal and operate upon either and entirely neglect the other. The vast majority of mankind preserve only the dross and unwittingly discard the part of real value. Consequently, their possessions tarnish, or if placed in the fiery furnace of cosmic usefulness turn to ashes, perishing and leaving them poor, indeed. But the spiritual alchemist carefully and patiently searches each experience of life as it comes to him for the bead of real metal that is sure to be hidden amid the rubbish and debris of its external effects.

Oft-times this rarer portion is but a glowing speck imbedded in a mass of confused impurities. Nevertheless, it is well worth the effort of its recovery. Each grain of unsullied metal added to the priceless collection of years, is so much that will never be lost and never be taken away; for it finally will be converted into an ineffable and glorious effulgence, called by the learned, spiritual gold.

Real Metal Distinguished From Dross

—As students of spiritual alchemy let us now learn to discriminate between real metal and dross. The real metal is the underlying reality of each experience, that is, its effect upon the soul; while the dross is the apparent condition, the material effect, which is the cloak of seeming with which every reality in existence is clothed.

All too often, for instance, we speak of a man as if he were merely an entity of flesh and blood, while in reality he is soul and spirit, and the physical body is but the garment of manifestation which covers the character. We commonly say that the man is sick when in reality it is only his body that is ill; and thus we confuse the dross with the real metal. It is true that a man may be sick; for his soul may be corroded with the rusty scales of lust, prostrated with the lead poison of greed, corrupted with the verdigris of sensuality, or tarnished with the impure tin of self-indulgence; but to these it is less common to refer. Men walk through life apparently the image of bodily health, yet with souls that truly fester. But so blinded to reality are most people that they can see only the perishable covering that hides such conditions as inwardly exist.

So long as we consider a man fortunate or unfortunate without appraising the effect of events and conditions upon his soul, we are mistaking dross for the pure metal; for the dross relates to external life, and the true metal only concerns the soul.

When we accept it as possible for one man to be injured by another, we are accepting appearances for reality; for no one is injured in his real nature except by his own permission. But if I take the attitude of a spiritual alchemist I realize that another may torture my body, or place me in prison; yet he can not injure me thereby unless in my ignorance I mistake my body for my real self. I realize that the soul is the only true self, and that it is impossible for anyone to in any way affect my soul except through my own consent.

Thus it is that either in wisdom or in ignorance we give the unspoken nod of our approval to every event that constitutes a real metal of life; that has any influence upon the soul; for the event itself has no power to affect the soul except through the attitude of the soul toward it. The same event happening to two persons may readily be considered from diametrical standpoints, and thus, because viewed from different planes, have exactly the opposite effect on the inner self of one from that which it exerts on the other.

For instance, the inheritance of a fortune may lead one person to a life of ease, luxury and licentiousness; while leading another into a life devoted to welfare work, charity and philanthropic endeavor. The effect on the soul of one is exactly the opposite of the effect on the soul of the other. It is not the inheritance that causes these effects, it is the attitude toward the inheritance. And thus it is with all events; it is not the things

which happen that affect us, but only our mental attitude toward those things.

The spiritual alchemist goes even a step further than this: He believes that it is only when we confuse our bodies and material possessions with our true selves that we become the slaves of circumstance. Freedom from the bondage of environment depends upon our recognition of the distinction between our real selves and real obligations and the external form and the responsibilities that some seek to assume, but which in truth belong to Nature.

I do not mean that man can always control the events of the external world. He can do this to a limited degree, and he should strive to increase his ability to overcome such external restrictions as are imposed by environment. But there are many events far beyond the power of any individual to control. There are events that affect whole communities, whole nations, whole worlds, and even whole starry systems. These events, by compelling adaptation to altered environment, have an effect upon the physical bodies and the actions of the members of a group. No man can imitate Joshua of old, and command the Sun to stand still, with any reasonable hope of being obeyed.

In spite of any effort of our most ardent metaphysician the succession of the seasons will continue. And what wisdom providence displays in making it impossible for us to tamper with the movements of the planets in their orbits! What would happen to our solar system if it could easily be deranged by the monkey-like curiosity of certain prevalent individuals who just can't let the dial of a radio or the engine of an auto alone?

But man is not responsible for the movements of the stars. He is not even as yet responsible for the cyclones that at times sweep sections of the earth. Collectively, man is coming to be responsible for the effects of wind and flood and earthquake, because he is learning how to build to prevent their causing great havoc. Yet even here no one man has more than a limited control. Somewhat he may influence others toward proper building, and he may build properly himself; but he can not compel the inhabitants of a region often devastated to take adequate care of themselves. Nor beyond the limit of his ability to alter their peril is he in any way responsible. Man is not responsible for anything beyond the power of his control.

Spiritual Freedom

—It is the recognition of the difference between real metal and the dross of life, and of the difference between his own responsibilities and the responsibilities that rightfully belong to Nature, that permits, in the true sense, of the spiritual alchemist being the most free of all men.

Following his reasoning, let us recognize that I am responsible for only such conditions as lie within the range of my ability to alter. There are other intelligences in the universe than myself, and it is presumptuous for me to assume the obligation of

their acts, other than in so far as I have an influence over them. If, for example, the nation of which I am a citizen conducts its affairs in a particular way, I am answerable for this so far as I have a national influence. Or if the guiding intelligence of the world, or the influence of energies reaching the earth from the planets temporarily inharmonious to each other, brings drought, crop shortage and pestilence, the responsibility rests with the intelligence or forces superior to man. Certain limitations are imposed upon my physical domain. Beyond my power to overcome them it is an impertinence for me to assume these duties of more advanced beings. Yet because I do have it within my power, and because this is a duty really belonging to me, through forming a proper attitude toward events I can completely be free from the bonds of environment; for it is only through my attitude toward it that any condition or event can in the slightest influence or affect me.

An unjust judge, it is true, can deprive me of all my property; but he has injured me only in as much as I have identified myself with my property. If, instead of discovering the real metal of the event, I mistake the dross, the material thing, the property, for the thing of value, and attach great importance to it, I am greatly injured; for I have striven to retain dross and it has been wrenched from me by violence. But this injury was perpetrated not by the unjust judge, but by myself. It resulted from my ignorance in supposing that I might be injured by another; and from mistaking dross for a thing of permanent value.

Instead of thus suffering injury, had I sought the real metal, I should have found that it can not be appropriated by another. My material possessions can be retained but a few years at best, and then are discarded; for they can not follow me beyond the tomb. But my most valuable possessions—the metal of each experience gained through my attitude toward it—are not so transitory. They persist as factors in the consciousness that determine character; and character, as well as the mental attitudes forming it, leaps the abyss of death to a land where blossom the fairer flowers of eternal spring.

Man all too commonly identifies himself with external things. He fails to perceive that these are the ores of life that yield only dross unless some special effort be made to recover the true metal within. At times he attracts to himself honor among men, at other times he may have wealth, health, a wife, children, and pleasure. But such ores are of no greater real value than when he is despised among men, or when he loses money, is ill, is separated from his wife, estranged from children and is beset with pain.

Each of these experiences is an ore, or impure metal, composed of both dross and precious mineral. But appraising it from the standpoint of its external effect in each case he retains only the dross and permits the permanent wealth to pass from his possession. It is only when he perceives the effect upon character, and strives for an attitude that makes each event increase the power of the soul, that he discards the dross and recovers priceless metal.

He has not, it is true, the power to determine, beyond certain limits, the kind of ore brought to him. He can acquire, if he tries, ores that contain all of the seven essential

metals. And he can get them in ample volume to furnish the metals in quantity enough to flux with each other and complete the transmutation. But whether these ores from which metals may be extracted are pleasing or severe, whether they are easily worked or are extremely refractory, is only to a measure within his power. Thus being beyond his power, they are likewise beyond the scope of his responsibility. The manner in which the raw materials are furnished is mostly the responsibility of Nature. It is his responsibility to work all the ores she provides, and not grumble at their quality.

When he assumes he knows more than Nature, and remonstrates because he thinks she should have brought him ores of a different texture, he is playing a role for which he is fitted neither by experience nor by intelligence. Nature is the boss alchemist, and he may be sure she knows her business. But because he can not control the prerogatives of Nature does not make him a slave. It is only when he tries to do the work that rightfully belongs to her that he is under compulsion. For the only thing that can possibly affect him, that is, affect his real self, is his attitude toward these ores of experience Nature brings. And as it is within his power completely and at all times to control and direct his attitude, whenever he desires he can be completely free.

Alchemical Tools

—Nature not only furnishes him with the impure metals, or at least makes it possible for him to mine these ores, but it is her duty to furnish him the tools of work. These tools are named capacity and ability, and include the power to attract or repel opportunity.

Nature has plans of her own that are sensed only by the most advanced of men. She is building a cosmic edifice; and in this tremendous enterprise of construction she must employ workmen of every variety of talent. Not having them ready made, like any good executive, she undertakes to develop them. But as each has a somewhat different duty to perform in the universal enterprise, the training to fill these positions correspondingly varies. The training of one is not the training of another, because each must be skilled in a different function.

Thus it is when we arrive at this stage of our education known as the life of man, that there is a vast difference in the tools with which we are supplied. One man has Uranus, Saturn and Mars prominent in his birth-chart, with Mars receiving harmonious aspects from Mercury, Uranus and other planets. Not only has he a capacity for mathematics and engineering, but he has unusual mechanical skill, and makes a success of vast projects requiring the use of intricate machinery. His Mars thought-cells use their psychokinetic power, which is increased by his association with Mars environments, to bring good fortune into his life.

His neighbor has Uranus, Saturn and Mars equally prominent in his birth-chart, but Mars receiving discordant aspects from various planets. He also has unusual mechanical skill, but as the Mars thought-cells use their psychokinetic power to

bring misfortune into his life, and associating with Mars environments increase their psychokinetic power, whenever he is much about machinery he suffers physical accident, and whenever he attempts a large construction project, fire, or flood, or financial depression comes along just in time to wreck the venture. So-called good luck and bad luck are not fortuitous. So-called good luck is due to the psychokinetic power of harmonious thought-cells in the finer form, and so-called bad luck is due to the psychokinetic power of discordant thought-cells in the finer form.

Still another man has Mars weak in his chart and making no aspects, and has neither the ability nor the inclination to build even a chicken crate. In Nature's school these men are undergoing different training.

Opportunities for physical accomplishment are presented to some, and not to others. And thus we might take up all the various combinations of circumstances that are beyond man's control. For such detailed analysis you may turn to the lessons on astrology and mental alchemy. Here I desire only to point out that people at birth are not equal in ability, nor throughout life are opportunities equally distributed. No more so than a musician should receive the same education as an accountant. For all individuals are undergoing training in Nature's school. The lessons given at any time differ with the progress made in developing the talents necessary for the individual successfully to fill the job for which he is being fitted. The makeup of our astral bodies at the time of birth is the result of the training we have undergone in impersonal lives before birth. We have developed to a point where we have certain capacities and abilities. These are tools we have earned. Furthermore, from time to time, as the result of the stimulation of the thought-cells in our astral bodies, through the movements of planets subsequent to birth, other tools are placed in our possession. They are those accentuated forces that attract or repel opportunities.

Now this outfit with which we are born, as indicated by the birth-chart, and the additions to it, as indicated by the progressed aspects, are given to us by Nature, because they are just what we need at this particular stage in our schooling.

Nature does not compel us to keep the various implements in the imperfect condition with which they come to us. She is quite willing that we should remodel, sharpen, or otherwise perfect, these tools. If we can do so it indicates that we are ready for those of better design. But those she gives us, that is, the astral organization mapped by the birth-chart and progressed aspects, are such as she deems we most need until we attain the skill to make them better. Thus the capacities, abilities and the tendency to attract opportunities with which we are born are not our responsibility, but that of Nature. When we complain of them we merely air our ignorance; for Nature knows better than we what we need to fit us as competent specialists in her vast workshop. We are not under obligation for our birth-chart, or for the tools it lists, but we are most importantly responsible for perfecting these tools and for the use we make of them.

It is common, I know, for people to deplore both lack of material possessions and lack of opportunity. But when we do this we are vacating our seats, where we sit as pupils at the feet of Nature, and attempting to become the instructors, and tell her how

to run the universe. The ores of life, the experiences that have as yet not been separated into dross and pure metal, are only loaned to us by Nature. Material possessions, fame, family, friends, and all that worldly men set their hearts upon, do not belong to us; nor can we retain them more than a limited time. They belong to Nature, and it is her privilege and her wisdom to give and to take away. So also with opportunities. They belong to her, and she issues them to us temporarily only as we can use them in our schooling, and then they are withdrawn to the inscrutable storeroom of a vanished past.

Our tools, however, she permits us to keep. They are the reward of our progress. Some we have at birth. They are capacities, abilities, and the power to attract events and opportunities. If we have used these properly they assume a more perfect form and function, and are built into our finer bodies as implements of increasingly superior design. And as in this more splendid model the workmanship is largely our own, they do not belong to Nature, but to us, and we are allowed to keep them; for Nature, in her wisdom, takes from us only the things that belong to her.

We come into this life well equipped for the lessons we next must learn. We are given, or have acquired in impersonal lives, the necessary tools. Life, at the direction of Nature, delivers to us certain impure metals in the form of experiences. Within limits, we have the power to acquire better tools, and to gain possession of ores more to our liking. We have the power, that is, to modify the makeup of the astral body as mapped by the birth-chart, and to annul influences shown by progressed aspects, or initiate other influences of importance not so shown, by which we change the type and quality of events.

Nature thus permits us, in addition to those otherwise furnished, through unusual industry and intelligence, to acquire other tools and other metals. These are the rewards of exceptional merit; the result of changes deliberately planned and persistently carried out in the development of character.

Other than these that are acquired as a reward for special effort and fine craftsmanship, Nature is responsible for both ores and tools, that is, for both experiences and abilities. Yet exercising these abilities upon whatever experiences Nature sees fit to deliver, using the tools we have upon the ores presented, we can extract from each a metal of purity and brilliant luster. When obtained, like our tools when well cared for, the pure metal is never taken away; it belongs to us as a priceless possession. This obligation is not that of Nature; the responsibility of extracting pure metal from each event of life is solely our own.

Let us, therefore, that the metal may be retained, discuss how in each case it may be separated from the dross.

Purifying Lead

—As lead is the most difficult of all the metals to separate from the dross, let us

consider it first. It is not an easy thing to endure poverty. Nor do I suggest that we should make no effort to overcome physical want. On the contrary, we should exercise our ingenuity and our initiative to attain to comfortable circumstances, not merely for our own pleasure, but because normally we can render greater service to society when so situated.

Yet if the grinding heel of scarcity crowds us against the financial wall, let us not moan and wail. Dearth, however much it may inconvenience the physical body, is incapable of affecting the soul. It can injure us only when we take a wrong attitude toward it.

Furthermore, the very fact that we are beset by this wolf of want indicates that Nature in her wisdom has provided it for the lesson it carries. We need this particular schooling, or she would have given us some different problem to solve. To the spiritual alchemist poverty is not an affliction, it is the ore of lead, given him by Nature to develop his character. If he shirks the lesson he is still in its presence. The more he dreads it the harder it is for him to bear. But if he learns the lesson here required he alleviates his condition on the physical plane, and gains a valuable spiritual possession. Physically this lesson is at all times, and without complaining, to do the very best he can with what he has. Spiritually, it is that both poverty and wealth are alike in offering opportunity to create values for the soul.

Another ore of lead takes the form of heavy responsibilities. More is required of him than he feels it is possible for him to do. The feeling persists that the weight of the world is resting on his shoulders. But does he become discouraged? Not if he is a spiritual alchemist. However heavy the burdens may be, if he bears them as resolutely as he can, and does not falter in the trying, he knows he has done his part. Maintaining such an attitude, and using his intelligence to discriminate between necessary and useless burdens, they commonly melt like thawing ice, and relieve him of their crushing weight. Should they really be too huge to carry, he realizes, however, that they do not all belong to him; for he is responsible only for what he can do. Even should they crush him they cannot affect his soul. If he has done his best, that is as much as Nature requires.

These burdensome responsibilities, heavy work, drudgery and physical hardship are supplied to him by Nature because they are his present need to continue his schooling. He is being fitted, you may be sure, for a task in cosmic affairs that requires such experiences to prepare him for it. They offer him exceptional opportunity to develop persistence, self-reliance and optimism.

Long, dreary, depressing spells of illness are also impure lead. They are not pleasant, and are not to be sought. A part of the lesson Nature here seeks to teach, no doubt, is how to avoid them. No pains should be spared to shun them, and thus demonstrate that to us they are unnecessary subjects in the curriculum of life. But when they do come, in spite of all our efforts to skip them, we may as well recognize that our future universal fitness requires that we master these disagreeable lessons. There is a right way to act in sickness; quite as much so as in health, and it is our task to find this way

and apply it. To become disheartened and blue affords no help, it merely assures that we shall be given more of the same leaden exercise. Not until we face such conditions with patience, hope and fortitude, have we gained the mastery. Realizing this, we discard the dross and retain the metal in its purer form.

Still another kind of lead is death. Every moment of life should contribute as a preparation for this event. In addition to the effort to build, by proper states of consciousness toward the various experiences of life, a complete spiritual body, the preparation should also include gaining knowledge, acquiring ability, reorganizing more harmoniously the thought-cells, and elevating the dominant vibratory rate. Nothing experienced or learned—as hypnotic experiments prove—is ever forgotten by the soul, or unconscious mind. Ability is know-how, and it can be adapted to doing things after life on earth is done. The thought-cell organization of the inner-plane form determines, while on earth and after passing to the next life, the fortune or misfortune of the conditions attracted. And the dominant vibratory rate determines, both while on earth and after life on earth is done, the inner-plane level on which the soul functions.

But whether death comes early or late is only slightly our affair, being largely a responsibility of Nature. To fear death is to become a slave to the desire for life. It is to be miserable, and make less glorious the time allowed us here. Nature knows how long we should remain in this lower class of her instruction. In her wisdom she will see to it we are given opportunity to develop the talents we need for cosmic construction. If we are ready for a different classroom than that afforded by the physical world, why should we mourn at our promotion, or weep at our departure?

Death, it is true, is an ignoble defeat when met with fear and shrinking; but it is a grand victory when faced with the knowledge and courage that it is preferable to a life of slavery to error and fear. The lessons it affords are courage, faith and cheerfulness. Coupled with the conviction that even this grim reaper has no power to alter the soul, they separate the worthless, and retain for spiritual use, this otherwise distasteful metal in its finest form.

Purifying Tin

—It is quite as difficult successfully to withstand undue prosperity as it is to contend with adversity. To be sure, prosperity is more pleasing to the physical senses; but if wrongfully viewed it is equally distressing to the soul. All too easily does wealth engender arrogance and pride. All too often it is taken as the symbol of some inherent superiority. Far too frequently does it permit time and energy to be spent in ways that are spiritually unprofitable. The dross is taken for the metal, and proves as great a hindrance to transmutation as does either corrupted lead or rusty scales of iron.

Yet the spiritual alchemist takes a far different view of tin than those who quote from the Bible that hardly shall a rich man enter the kingdom of heaven. He looks upon wealth as merely another ore of life. It is neither good nor bad, but a responsibility to

be as energetically shouldered as those of lead and iron. It becomes good or bad for the soul only through retaining the tin or the dross. If the pure metal be discarded, if the opportunity to use it for the good of all is permitted to pass, there is nothing to transmute. Material opulence can not be transported to the spiritual realm. But if wealth is used for the betterment of the race, instead of for reveling in luxury, the dross is discarded and the pure tin retained. Not only does this permanently affect the soul, but in such a manner that its substance is easily transmuted on the spiritual plane.

Nature has provided us with tools, such tools as we require. These are abilities, including those qualities mapped in the birth-chart that tend to attract or repel wealth; and those relations mapped by progressed aspects that at times bring opportunities to acquire riches, or that at other times result in financial loss. It is Nature's part to furnish us with tools, but it is our part to use the tools she places in our hands to the best possible advantage.

If among the tools thus inherited we have the power to gain treasure, we are quite as accountable for the use we make of it as we are of the use we make of poverty and loss. The Bible parable of the men given for use a different number of talents is not without alchemical significance. We are responsible in proportion to our endowments. Riches are not to be shunned. They are to be made use of for the benefit of all. If a man is gifted as a writer, it is his privilege to use that tool for human uplift. If he is a structural engineer, civilization has need of bridges and tunnels. Likewise, if he has financial ability, he should use it to the utmost; but use it to advance the interests of mankind.

If losses come he should not wail and moan; for these also are ores for his furnace. He has not been injured by the departure of dollars and cents, except as he identifies himself with lucre. Neither is he really benefitted by the possession of more than a competence. But he can be truly benefitted by either loss or affluence if he but recognizes that their real value lies in his attitude toward them. If, like the holy beggars of the East, he shrinks from making money but permits others to support him, he becomes indigent also in his soul. If he gains money merely to feed his vanity and as an aid to riotous living, it is a detriment. But if he has money and uses it for truly philanthropic purposes, he has proved his skill in the use of one of Nature's tools, and from this ore of tin, known by the name of material wealth, he has extracted a pure metal that helps to glorify his soul.

Purifying Iron

—Iron is brought to some people in much larger quantities than to others. Some people have a predilection to cuts, burns, accidents, losses by fire and robbery, and to arousing the ire of others. Iron also is attracted in its more constructive ores, such as following the mechanical, engineering or building trades, or in association, either as operator or patient, with surgery. But of this we may be sure, that whenever the ores

of iron are present in large lots, the cosmic fitness of the individual to whom the iron comes requires these experiences for its proper development.

Iron is one of the most necessary metals to complete the transmutation, for without it the other metals become dead and lifeless; but it is only valuable when pure and separated from dross. Lust and anger are both expressions of iron in a state of decay and corruption. Unrelenting effort in behalf of some high cause, and undeviating activity and determination in the face of great obstacles and unfair opposition, are forms of iron that have been well purified.

When others strive to injure us, it is only because of their ignorance. If they possessed understanding they would know that in treating us unjustly they were in reality not injuring us, but only injuring their own souls. Another can not truly injure us, except with our own permission. If, when another speaks harshly to us, or criticizes us, or becomes angry with us, we also become angry, or speak harshly, or become resentful, we are injured. But we have then injured ourselves. But if we cast aside anger and thoughts of vengeance, and think and act justly, though firmly, with a clear comprehension of the effect of our attitude and actions on the welfare of society as a whole, we have freed the metal from dross and come into possession of pure iron.

We should, of course, exercise caution to avoid accidents and to prevent becoming involved in acts of violence. Yet if in spite of due precaution we are in an automobile accident, are held up by a bandit, or a surgical operation becomes necessary, there is a right way for us to conduct ourselves under these circumstances. We can make an effort to prevent undue agitation. Calmness and tranquility are lessons of great value that may be learned from experiences with iron. We do not need to quail; for courage in trying circumstances is a purer form of iron. The material loss, or the pain, has no effect upon the soul except as the soul accepts it. Therefore, each such violent condition may be viewed as a test of our fitness to handle this metal. Instead of spending either time or energy thinking about the pain or loss of injustice, we can immediately plan what constructive activity lies open to us. By diverting our energy to building, or overcoming, or remedying, to the fullest extent that the situation permits, we ignore the seeming, get rid of the dross, and supply ourselves with iron in an unadulterated state fit for final transmutation.

Tolerance is another lesson to be learned from iron. We think, without doubt, that we are right and others who differ in opinion are wrong. We perceive only our own viewpoint clearly, and because iron is abundantly present we become highly enthusiastic. Such enthusiasm is a very fine grade of iron ore, but it must be freed completely from dross before it acquires much value. We must recognize that the experiences of other people give them different viewpoints. Their conceptions are the natural outgrowth of the things that have come under their observation. And as they have not had the same opportunities that we have had, it is impossible for them to see things from the identical angle that we do. We must not, therefore, blame them for their opposition to ideas that to us seem inevitable. They can not help rejecting those ideas. It may be possible, or it may not, to educate them to our point of view; but at least we always owe it to ourselves to avoid any feeling of irritation at their lack of

comprehension. We owe it to our own souls not to interfere unduly with their opinions and actions. The exercise of such wide tolerance purifies the iron and prepares it for transmutation.

Should lightning strike, or a fire burn down our property, or money be taken from us at the point of a gun, we have an ore of iron from which may be extracted pure values. Being knocked down, financially, emotionally, or literally, calls for neither weeping nor complaint, but for as quickly as possible getting to our feet and doing the best thing we can think of about it. Lawsuits, the opposition of others, and persecution because of our stand in regard to the things we feel have spiritual value, all bring opportunity to gain iron and to purify it.

We can be just, even to enemies. We can strive valiantly to overcome opposition without desiring the injury of those pitted against us. If their injury becomes a necessity in order that a wider and more important section of society may survive, we may approach the task as a surgeon who sympathizes with a patient performs an operation. He feels no enmity toward the part removed. Instead, he is actuated by the desire to help the patient. Thus does severity, as an ore of iron, when exercised without malice, but with a view to the improvement of conditions, become purified and suitable for spiritual construction.

Purifying Copper

—What are we to do when someone whom we love refuses to reciprocate? How are we to act when our husband or our wife grows cold and spurns our caresses? When another and newer face comes along and entices away the one, the tendrils of whose affections have wrapped themselves firmly about our heart, what course of conduct and thought lies open to us? How shall we purify such agonizing copper?

However much we may delude ourselves into that belief, the object of our affection nevertheless is not a spiritual possession. If he or she is the soul-mate, that spiritual relationship will take care of itself when we have built a sufficiently active and conscious spiritual body through complete transmutation of the metals of experience to the spiritual plane. But the physical body of the one loved, and the affectional interests of this one so far as the earthly plane is concerned, are but another form of copper dross.

Friend, lover, husband, and wife, all have their own lives to lead. We may again be united in the beyond, who knows? But while on earth each has the working out of his own destiny, each has the ores of the various metals to collect for himself, each must lead the existence that seems to him most alluring. When we endeavor by force or subterfuge to bind others to us who wish to depart, we are through injustice to them really injuring ourselves. When we grieve and sorrow over their departure, we are retaining a corrosion that eats into the vitals of all that it contacts. This helps us neither here nor hereafter.

It is always permissible, if we can do so without injury to another, to endeavor to win the friendship or love of the one we hold dear. A husband or a wife is a weakling who permits another to steal the love of the mate without making an effort to retain that love. But love is never retained by force, nor by complaining, nor by finding fault, nor by any other disagreeable activity. It is either held through the exercise of lovable qualities, or it is lost. Anxiety, and fear of the loss, but make the loss more certain. And in spite of all effort the loss may come.

If this comes to pass, we may be sure that it is because we have not yet learned to handle copper adequately. Nature has provided us with this particular experience because from it we can learn a needed lesson. When love prospers and affection rejoices, we can permit them to inspire us to noble things. And when love is unrequited, or the affections of a dear one go astray, or the one closest to our heart is violently wrenched away by the angel of death, we still can gain and purify the ores of copper. We do not need to restrain the actions of the other, nor do we need to embrace and maintain sorrow. There are others worthy of love. The birds of the woodland, the pets of the household, the flowers that grow by the side of the path, all welcome and respond to love. What has been taken away was perishable, was dross, and could only at best have been retained a short time. But love itself, as an emotion of solicitude for the welfare of another, or as engendering a tenderness toward all, may be retained permanently as a metal of great purity.

Purifying Mercury

—Our thought processes furnish us with the ores of mercury, and commonly they are in a state of considerable contamination. Few of us there are but at times make mistakes. We forget some appointment and suffer embarrassment because of it. We perhaps permit ourselves to be short-changed when making a purchase, and feel aggrieved when we discover it. In addressing a letter we may forget to write the city, or we may reverse the street number in such a way that the letter fails to reach its destination, much to our annoyance. A name with which we are perfectly familiar, at the moment we need it most, slips our memory. We fail to make a memorandum of something we are sure to want to refer to in the future. Carelessly we destroy the receipt of a purchase before examining it thoroughly, and when we find it is defective we can not exchange it because we have nothing with which to prove when and where bought. Thus, because of trains of thought in the unconscious mind that temporarily grasp the reins governing our actions, little errors, and sometimes more serious ones, that are not beyond the limit of our abilities to avoid, creep into our lives.

These errors, as well as more efficient mental activity, are ores of mercury. Usually they are very much defiled, not because essentially they are dross, but because we make them so. The impurity arises from the feeling of chagrin, annoyance, irritation, despondency or other disagreeable emotion that is associated with them. All such emotions are proof that we have identified the material effect as the real; while in

truth the real and valuable part of the experience is the attitude of the soul toward it. There is a right way to act when an error has been committed as well as when error has been avoided. The right way, which is also the right way under other circumstances, is to spend no time or energy feeling discomfited by the error, but to think only what is best to do under the circumstances. A man can think constructively under any circumstance, and error in particular calls for constructive activity. To realize that a mistake is not important, but that it is important to take a constructive attitude toward all events, is to free the metal from dross and provide mercury in a purity that insures spiritual transmutation.

Purifying Silver

—Because of their need of us, and our solicitude for their welfare, it is difficult for us to realize that our children are not our own personal property. In reality they belong to Nature, and are being fitted, each in its own way, to become a workman with special abilities and duties, in the cosmic plan. It is our privilege to assist them in this development, and to do what we can to advance their welfare. But we should not assume to be so omniscient that we know what experiences they need, or how they should think at any given time. If their ideas differ from our own, no doubt that is part of their necessary schooling. And if they are taken away from us, it is because they are needed elsewhere, and we need the lesson of their loss.

Furthermore, while no effort should be spared to promote harmony in the home, yet if discord does come it is but another form of silver. The soul need be disconcerted neither by external domestic turmoil nor by the loss nor actions of children. When it realizes that its responsibilities are no greater than its abilities, and looks upon the events of the home as opportunities to learn sympathy, understanding, and non-attachment to that which is transitory, it comes into possession of silver in its purest form.

Purifying Gold

—Wherever power and leadership are exercised there is opportunity to secure spiritual gold. If another, who appears to have no greater ability, is given a better position, there is no cause for pain. Appointment and preferment come to some, as does leadership and prominence. If it is denied to us we should feel no self-pity; for there is a right way to act when honors are denied, or when a position is lost, or leadership is denied, as well as when these things are granted. They also are ores of gold; and offer opportunity to build gold into the character. Let us, therefore, accept whatever position life compels us to take as our present need for experience. Let us not cease to strive for a higher post, yet feel grateful for such influence as lies within our power to use. Without complaint, let us utilize whatever power we have for human betterment, and thus purify our gold to a state that encourages transmutation.

Chapter 4

Serial No. 52
Original Copyright 1930
Elbert Benjamine

Copyright
Church of Light
August 2002

Transmutation

Chapter 4

Transmutation

TRANSMUTATION is always suggested by any mention of alchemy. The mind at once pictures thoughtful men with lettered parchment and quaint books at hand on which are to be seen strange symbols. They are surrounded by retorts of peculiar design, furnaces, cupels, test-tubes, filters, and outlandish chemical containers. Such is the setting once furnished by material alchemy. And material alchemy may still be practiced, although with better tools. But such alchemy is for gain of material possessions; while the one with which we are here concerned is to change transient mental force into a permanent spiritual body capable of exercising true spiritual power.

To indicate how spiritual alchemy differs from other forms of this Hermetic Art, let us take as example some event of life. Success, for instance, when viewed from the material plane is something greatly to be prized. But to the mental alchemist it may be something of immense value, or something that had better be left alone, depending entirely upon how it affects the organization of the astral body.

If it is accompanied with violent feelings of discord that set up antagonisms between different thought-cells in the astral body, the mental alchemist considers it a misfortune; for he knows that these mental inharmonies will later attract into the life other physical events of greater disadvantage than such advantages as the success has now gained. If, however, the success is associated with harmonious mental states, the mental alchemist considers it beneficial; for he knows that the mental harmonies thus organized in the astral body will later attract still further gain. But as even a loss may be so viewed mentally as to engender harmonious mental states, and thus later attract gain through the psychokinetic power of the thought-cells set in motion; he does not look upon the success itself as good, or the loss as evil. Either may be made a source of mental harmony or mental discord, a source of future physical and mental gain or loss. Therefore, to him, the important thing is not the event, but the attitude toward the event as affecting the mental organization of the individual.

To the spiritual alchemist, likewise, it is not the event that is good or evil, but the attitude toward it. Events are also the materials with which he works; they are his metals. But instead of considering their effect upon the mental organization in reference to its power to attract other events in the future, he considers their effect

upon the soul. He views them not as affecting the material fortune, but as affecting those elements of character that not merely persist beyond the tomb, but that may be given a vibratory rate intense enough to affect spiritual substance and through union with other high-rate energies derived from experience, build up an immortal spiritual form.

Mental Force

—It is easy to perceive that each experience has an effect upon our physical lives. It also has an effect upon our mental makeup. When we become aware of it, our consciousness receives additional energy. By its likeness to other mental factors, or entering the mind coincident with them, and by its association with the feeling of pleasure or pain, it is built into the mental organization as a definite energy persisting in the astral body. As such an energy it has a power of attraction toward external conditions and events that correspond in vibratory rate to it. That is, it exercises an attractive power toward events that have the same quality and the same harmony or discord.

Each such experience is also an additional factor of information which may be so organized into the mentality as to increase the ability to think. The ability to think depends upon the number of separate experiences, including those mental and emotional as well as the merely physical, that have entered the consciousness, and upon the way they are organized. Upon the ability to think depends the mental force.

A thought is a set of motions within the astral brain. If these motions, or vibratory frequencies, are transmitted through electromagnetism to the substance of the physical brain, the thought rises from the unconscious into the region of objectivity. The individual is then objectively conscious of a thought that may have been present for either a long or a short time in his unconscious without his being aware of it. Or if there is a sensation coming from the physical world, the rates of the physical brain it sets in motion are transmitted through electromagnetism to the astral brain where they are registered and compared with other rates of motion set up by previous experiences. Such a comparison when it rises into objective consciousness through its motions being transmitted to the physical brain, is said to be a definite perception.

Every thought is thus composed of numerous factors, each factor being definite motions set up by previous experiences that persist in the astral form. These experiences may have been with the physical world, or may have been derived in great measure from mental processes; for thinking itself is an experience. But from whatever immediate source derived, a thought is a complex organization of modes of motion derived from experience that co-operate because of their association.

They are not isolated units, but complex organizations of motion. The wider the experiences, the more material for thought there is at hand; but to utilize this material requires practice in properly organizing the various motions in the astral body into systematic groups. It is not sufficient to have innumerable physical experiences if

you would possess mental force. You must also cultivate the ability to organize them by means of mental processes into clear cut ideas.

Yet as every experience of life adds new motions to the astral form, and these motions when definitely organized into thought become the source of mental force, it follows that every experience of whatever nature may be made a mental asset that adds the energy of its motions to the mentality. But whether an experience becomes a constructive factor in the mentality, or a destructive factor, depends entirely upon the mental attitude toward it. If it is viewed only as a source of pain, or as something merely interfering with the desires, it sets up discordant and disintegrative vibrations in the astral body that tend to attract material misfortune. But if it is welcomed as a step in progress, and the pleasant features sought out, it sets up harmonious and integrative vibrations in the finer form that tend to attract material fortune. To transmute otherwise discordant mental elements into those that are harmonious and beneficial is the work of the mental alchemist; for every experience of life, by using the proper process may be made to add energy to the mental organization in a way that increases the mental force.

This force at any given time depends upon the vividness and intensity of the thought. The vividness depends upon the ability of the thinker to separate the factors of which the thought is composed from other mental elements not concerned in it. This is accomplished through concentration. The intensity, however, depends upon the number of separate mental factors utilized, the energy contained in each, and the completeness with which they are joined to act as a single organization of thought energy.

Thus it is that mental force results from utilizing the experiences of life as integrative factors in the process of building clear cut mental pictures. If such a force is to result in physical phenomena, or in any way to operate directly upon physical substance, it must be vitalized with electromagnetic energy. Electromagnetic energy also may impart motion to the substance of the astral form, and so strengthen the astral force; but electromagnetic energy is not necessary for thought to act upon the entities of the astral plane, or to act upon the astral brains of those yet on the physical plane and influence them in their actions.

Spiritual Power

—It should now be clear that mental force has no more to do with motives than physical strength. Morals play only minor roles in either; and on the astral plane as well as on the physical plane an entity may exert great mental pressure, even though actuated by evil motives. Thought is a force that may be used either for good or evil, and is a potent weapon of black magic as well as a healing balm ministered by brethren of the light. It may be used to destroy the soul, or to build up and vitalize a crystal raiment in the region of eternal day.

As thought, however, its duration is limited, unless its vibrations are raised above the

astral plane. The astral is more enduring than the physical, but it too must pass away. There comes a time when the planetary cycles dissolve the astral world, as well as the physical. And under the influx of planetary forces the form of man, as it persists on the astral plane after death, at its appointed time crumbles into dissolution. And when this second death shall come, thoughts and consciousness, objects and individuals, occupying the astral plane dissipate as vanish the mists of morning before the rising sun.

Is this then the end? Not so, unless the life has been sordid and the soul bound to lower realms by selfish aims. Normally, in the course of the life in the astral realm after physical death, there is a continuation of varied experiences. Opportunity is afforded for the development of spiritual qualities that perhaps had only begun to germinate while on earth. And after a time, through the processes of growth, the attitude is developed that constitutes the aim of our spiritual alchemists. Thus there is no extinction of thought or of consciousness; for these have raised their vibrations sufficiently to affect the more enduring spiritual substance. The thought organization, and therefore the consciousness, has been transferred to, and persists in, the substance of the spiritual world.

The spiritual alchemist, however, does not wait for a long schooling in the lands of the beyond. Through the processes of his art he builds up now, while still on this earth, a virile spiritual body organized by harmoniously associated spiritual thoughts. And because the more interior the plane from which an energy emanates, provided it can find a point of contact for communicating its motions, the more potent it becomes, the spiritual alchemist exerts a truly wonderful influence in the world. Sainly men have ever performed, and apparently without effort, things that to others seem miraculous. Their thoughts are not merely the force of mental factors existing on the astral plane, but are finer and more potent energies of a still interior plane. This is the difference between mental force and spiritual power.

The Metals Must Be Pure

—But before mental force can be transmuted into spiritual power, its metals must be carefully purified. The dross, which is the effect of an experience considered from the external plane, must be separated from the pure metal, which is its effect upon the soul. The first task then, in the practice of spiritual alchemy, is carefully to analyze every event and circumstance of life as it presents itself. This separates the dross from the metal. The metal is finally purified by taking a proper attitude toward the experience and acting resolutely upon it. However carefully metal and dross are separated by mental analysis, it takes action to get rid of the dross.

Success and failure, health and sickness, wealth and poverty, triumph and defeat, love and disappointment, life and death, friendship and enmity, all are conditions that may come into the life and have an effect upon the soul. This effect is the real metal. And under each of these circumstances there is a proper mental attitude and a proper

course of actions that separate dross from real metal and discard every impurity.

To be egotistical in success or discouraged by failure, to use health for selfish aims or to bemoan illness, to live in undue luxury or to become embittered by poverty, to be tyrannical in victory or to cower in defeat, to be licentious in love or disheartened by its loss, to desire life above honor or to fear death, to value friends above integrity or to stoop to sordid acts to injure enemies; all these attitudes and acts keep the metals of which they are composed in a state of impurity that effectually prevents transmutation.

But to be modest in success and undaunted by failure, to use health to work for all and to be patient in illness, to be charitable with wealth and kind in poverty, to be magnanimous in victory and unhumiliated by defeat, to be pure in love and strong in its loss, to be useful in life and fearless in death, to be honorable with friends and just to enemies; all these mental attitudes and the acts springing from them, remove the dross and impurities and present the metals composing them in a state of purity that offers no resistance to transmutation. Each is potentially gold, and when thus purified is a pure mental force that readily may be converted into spiritual power.

It should be understood, however, that merely bringing either physical metals or the corresponding experiences of life together in proper proportion does not insure that they will melt and properly fuse. Their correct proportion only greatly reduces their melting point and facilitates their fusion. But to bring about the proper fusion, as explained in chapter 1, they must be heated in a reverberatory furnace. And as there explained, the most effective reverberatory furnace that can be used by the spiritual alchemist is fed by unselfish love.

It is the dominant vibratory rate of the individual which determines the inner-plane level on which his soul functions. And any thought or experience which tends to raise the individual's dominant vibratory rate helps feed the reverberatory furnace necessary for transmutation. The dominant vibratory rate is little influenced by knowledge. But it is powerfully influenced by emotion.

Thoughts, feelings and actions which spring from a desire to help others, rather than gain some profit for self, are fine fuel for the reverberatory furnace. Such constructive efforts and the emotional states accompanying them generate some of the highest vibratory rates known to human life. And those who live by the universal moral code—*A Soul Is Completely Moral When It Is Contributing Its Utmost To Universal Welfare*—most consistently furnish fuel for the reverberatory furnace; because not just a few of their thoughts, feelings and actions are motivated by the desire to benefit others, but because they persistently hold this feeling. Further explanation of just how the reverberatory furnace works is set forth in Chapter 4, of Course 17, *Cosmic Alchemy*.

Seven Metals Must Be Present

—Yet however pure the metals, no complete transmutation is possible unless all seven are at hand in ample quantity. Without a heart, representing the Sun and untransmuted gold, the physical body of man can not function. Without a skeletal structure, representing Saturn and lead, a material organism suggests the resistance of a jelly-fish. Without a venous system, representing Venus and copper, higher forms of life can not function on the external plane. Nor do they function energetically without an arterial system, representing Jupiter and tin. A nervous system, represented by Mercury both as planet and metal, is essential to any worth-while thinking on the material plane. A muscular system, representing Mars and iron, is essential for such physical movement as enables man to work. And all organisms on earth depend upon a fluidic system, represented by the Moon and silver, for growth and the replacement of worn out tissues. So likewise, if man is to have transmuted gold, the ingredients of which it is composed must all be there. A spiritual body is not a fit vehicle for the soul if some of its essential organs are wanting. To provide these there must be adequate experiences of all seven types.

The wonderful results sometimes produced by holy men and regarded as miracles by the multitude are not the workings of the tremendous will and mental intensity so pleasing to writers of occult fiction. While true that yogis, fakirs and magicians produce startling phenomena by concentration, and by utilizing astral energies through frenzied intensity; the more worth-while results spring from a still interior plane. Real adepts and truly saintly men produce even more remarkable and useful conditions with very little exertion upon their part. Their spiritual bodies are so thoroughly organized and built up that the slightest desire fully realized within imparts motions to the astral form from the spiritual body. These energies, because inaugurated from a higher plane, impart a tremendous force to astral substance, which acts through electromagnetism upon physical substance immediately to bring about the desired result.

But to exert such spiritual power upon the physical and astral planes is not the chief aim of the spiritual alchemist. He works also to transmute all the experiences of life into a glorious and immortal spiritual form. And to build up such a form, all the elements must be present in proper proportion.

Even as a sound and vigorous physical body requires that all the organs and parts be present, so also a sound and vigorous spiritual body may not be constructed with certain types of experience missing. It is a common thing to hear people express pity for a person deprived of arms or a leg, nor do we expect much efficiency from such a cripple. Let us also feel pity in at least equal measure for the man or woman in whose life those experiences are lacking that develop courage and executive ability.

Or suppose an individual has had experiences that develop parental affections and domestic fidelity, but has missed those that develop combativeness. Nature may

have neglected to furnish him with iron at this particular point in his cyclic journey; but he should realize that without it complete transmutation is impossible. Therefore, with this knowledge, he should determine to possess iron, to develop courage and initiative, and thus to gain the metal which as yet he lacks.

If there has been a shortage of copper in the life, there will have been few experiences to call out the affections and the love of the beautiful. Realizing this, an effort should be made to supply the deficiency. The attention should systematically be directed to the artistic. If it seems unwise to permit the affections to be drawn out by any particular individual, then some work may be selected in which affection may be amply expressed toward mankind as a whole. No environment is so destitute but that it offers opportunity for expressing affection and beauty. Thus in any situation the spiritual alchemist can gain the copper so necessary for the completion of his work.

For that matter, the ores of all the metals are ready at hand and we have but to reach out and take them. But we all too often become contented with some ores to the neglect of others. Thus do our lives become lop-sided. There may be plenty of experiences with tin, with the acquisition of wealth and its distribution, but almost none with silver, or family life. There may be plenty with iron, or strife, and almost none at all with the responsibilities that constitute the ores of lead. We may even become elevated to power, and thus acquire untransmuted gold, without gaining any adequate amount of those intellectual processes from which is derived mercury. But we need not remain devoid of any essential ingredient; for there is always opportunity to acquire them. They are the seven types of experiences that enter into any well-rounded life; all of which are essential to build up a perfect spiritual body, which is the ultimate object of transmutation.

Fluxing the Metals

—Not only should the metals be acquired and purified in ample quantity, but the best results are obtained when there is a definite relation between the volumes placed in life's crucible. Silver should equal iron, copper should equal lead, and tin should equal mercury. In these proportions they constitute the natural fluxes of each other, and they more readily raise their vibrations to an intensity affecting the spiritual plane.

The examples we have of the power of two minerals to heighten their vibrations when together, or to lower their melting point when thus fluxed, are multitudinous. All, I am sure, have witnessed the effect of pouring water on quicklime. The temperature is raised until much of the water passes off as steam. Or if baking soda is added to sour milk in the making of biscuits, minerals that were liquid increase their vibratory rates until they become gaseous, giving a lightness to the bread. But if there is too much sour milk in proportion to the soda, or too much soda in proportion to the sour milk, then it is not a satisfactory flux, and the resulting bread is unpalatable.

The aim in the use of such combinations is to have just enough of the acid to balance

the alkali, just enough of the positive to balance the negative. And this principle is constantly applied in the smelting of ores.

Many ores that come to a smelting plant are so refractory that they defy the heat of the hottest furnace. But these same ores, mixed with a proper flux, that is, with an equal weight of an ore of opposite polarity, are easily melted. Quartz, for instance, is unusually resistant to heat. Dolomite, also, is very refractory. But pulverize them both and mix together so that the amount of acid in the quartz has the same weight as the amount of alkali in the dolomite, and the ores melt at a low temperature, and permit the metals they may contain to flow into a molten mass at the bottom, from whence to be drawn off into molds.

Utilizing this principle of polarity, adding positive ores to those negative, until they just balance, is the chief secret in smelting. It is likewise an important factor in spiritual alchemy. In smelting, if either positive or negative element greatly predominates, the ore refuses to melt, even though great heat is applied. And in spiritual alchemy, if one metal is greatly in excess of its polar opposite, there is difficulty in raising the vibratory rates properly, and even so, some essential part of the sought for product will be missing.

Therefore, in the processes of spiritual alchemy, it is well to give due regard to this principle of flux; and care should be taken when it is apparent that there is beginning to be an excess of some particular metal, even though thoroughly purified, that a similar amount of the metal of opposite polarity be sought out, purified, and added to the transmuting composition.

To recognize the proper flux for each alchemical metal, although there are other methods of determination, the one most convenient is to use the test of astrological correspondences. Take the solar system as our model. The Sun is the center, about which revolve three minor planets and three major planets. The Sun, representing gold, needs no flux. Its vibrations can be raised to those of transmuted gold merely through the use of power for spiritual purposes. On one side of gold we find lead, tin and iron; Saturn, Jupiter and Mars. On the other side we find copper, mercury and silver; Venus, Mercury and the Moon. Saturn is a masculine planet and must be balanced by the feminine Venus, that is, copper and lead should be present in equal volume. Jupiter is a masculine planet and must be balanced by Mercury, which essentially is neither male nor female, but convertible. Thus tin should equal in volume the amount of mercury. Mars is a masculine planet and must be balanced by the feminine Moon. Iron and silver should be acquired in like amounts. Any excess of positive metal over negative metal, or any predominance of negative over positive, offers resistance to raising the vibratory rate, and consequently hinders transmutation.

Transmuting Lead

—Heavy responsibilities, drudgery, monotonous labor, financial loss, financial gain

through careful planning, system applied to effort, disappointments, prolonged sickness, delays, obstacles, persistence, patience, sorrows, restrictions, and death are some of the more common forms of lead.

Because of their dull and heavy nature the ores of lead are not hard to classify. But because selfishness is so strongly entrenched in human nature they one and all are difficult to purify. Yet they may be purified by careful reflection upon their uses in the building of character and regarding them in such a way that each will be seen as an opportunity to build something specific and valuable into the soul.

But even when so purified, and the dross of appearances completely removed, they have a low vibratory rate. Furthermore, in some lives there tends to be an excess of lead. As a consequence, in order to melt it, or dissolve in the spiritual light, an adequate flux becomes necessary. This flux is furnished by an equivalent amount of copper.

Heavy work and responsibility should be balanced by amusements and relaxation. Sickness and sorrows should find solace in love and affection. Obstacles and restrictions should be displaced from the mind by periods given over to social intercourse. Loss and death should find compensation in friendship. These provide the opposite polarity which overcomes the resistance of lead to transmutation. Therefore, whenever the alchemist has on hand a superabundance of lead, let him energetically cultivate the affections, compassion, refinement and sympathy.

When lead is pure, material motives give place to those more spiritual. Yet even so, the thought of spiritual gain to the self is apt to linger. So long as lead is unfluxed with copper its vibratory rates are difficult to raise. They are sufficiently intense to impart motion to the substance of the astral plane, and thus add energy to thought force, but they are not fine enough to affect spiritual substance. Yet by mixing lead with an equivalent amount of copper the vibratory rates of both are heightened, and when the heat of the reverberatory furnace is applied transmutation readily takes place. Only when the rate is raised sufficiently to affect spiritual substance can lead become a component of the spiritual body. Only then does it become an ingredient of the imperishable spiritual gold.

Now if asked why spiritual lead and spiritual copper when combined in equal quantities have an intensity of vibration that imparts organized modes of motion from astral substance to spiritual substance and thus builds up certain necessary structures in the spiritual body, it must be answered that it is through the same principle that enables a metallurgist to reduce an acid mineral when united to an alkaline mineral to a molten state from the solid form with a temperature that would not perceptibly affect either alone. In the molten state both minerals have attained to a markedly different molecular vibration, and their glow indicates there has been set up in the electromagnetic field, a finer than material substance, intense vibratory rates that previously had no existence.

But to insure the transmutation of lead it should be treated with the heat of the reverberatory furnace. That is, in addition to purifying each leaden experience by

considering it as an opportunity for the soul to develop its latent powers, each should be considered in reference to its value in universal progression. Each weight and each responsibility has an effect upon the soul, and it has an effect upon the progress of the race. Enthusiasm for universal welfare, and the use of each leaden experience as a factor that in some manner benefits the whole, adds the necessary element of feeling. The emotions that arise from such devotion to carrying out the divine plan add the heat that completes the transmutation.

Transmuting Tin

—Genial warmth, financial gain, religion, philosophy, patronage, full feeding, joviality, favors received and granted, conceit, impure blood, sports, wealth, optimism, and a hearty constitution are common forms, or ores, of tin.

Tin, because it normally has a rather high vibratory rate, is not difficult to transmute. It must be purified, of course, by a discernment of the effect of each circumstance on the soul, and by taking advantage of each to accomplish something for the advancement of the inward character. Religious aspirations, actions of good will, devotion to charity, the reverence of the mighty works of Deity, all have a vibratory rate sufficiently intense to require very little acceleration to complete their transmutation.

Yet at times there is an excess of tin that should be fluxed with an adequate amount of mercury. Good fortune and opulence should never be divorced from the exercise of intelligence. Religious aspirations fail to attain their objective unless guided by reason. Unless there is plenty of mercury also, devotion readily becomes fanaticism. The good that one might do, for want of efficient direction, may flow into channels of destruction. Wealth gives opportunity for dissipation, but mercury reveals its folly.

Whether rich or poor, a city dweller or a rural resident, or in any other circumstance of life, there is always opportunity to gather and purify mercury. Every condition that confronts you is a problem to be solved. There is a right way to meet each event of life, and the effort adequately to solve these problems is a fruitful source of alchemical mercury. Therefore, if nature has brought you tin in abundance, see to it that you gain an equal amount of mercury. Analyze closely your own actions, learn to discriminate between the true and the false, exercise resolutely your intelligence in all matters that you do, or that come to your hand. Thus do you acquire the proper flux for an excess of tin.

But even in the exercise of beneficence, the effect upon the soul alone should not limit the viewpoint. There is a wider vision that perceives the effect, even of acts of charity and of endowments to so-called worthy causes, upon the progress and development of a larger society.

The effect upon the soul when separated from the external effect of appearances purifies the tin; but when it is used also as a means to further universal construction,

to aid society in its advancement, the reverberatory heat is applied that completes its transmutation.

Transmuting Iron

—Accidents, fires, antagonisms, initiative, constructive effort, fighting for the right, courage, energy, activity, mechanical trends, strong desires and passions, acute illnesses and operations, lavish expenditures, law suits and enmities are some of the common kinds of iron.

Iron, while one of the most useful metals, unless fluxed with an equal amount of silver, determinedly resists being dissolved in the spiritual light. It has a coarse, though violent, vibration, that communicates strong energies to astral substance, but fails to make an impression on the finer substance of the spiritual world. It is one of the most potent sources of mental force, but unless properly fluxed affords almost no spiritual power.

Should there, therefore, be something of an excess of the events furnishing iron, there should be a resolute attempt to acquire an equivalent amount of silver. Effort should be made to establish and enjoy a home. Interest should be taken in providing food, not merely for yourself, but for others. Shelter and raiment should acquire a larger importance. And if there are no children, dependents should be acquired, cherished and painstakingly cared for.

No matter how impoverished the circumstances, no matter how restricted the circle of acquaintanceship, there is always opportunity to acquire adequate silver. The parental instinct can find expression in the solicitude of a child for its dog. A hermit in his mountain cabin can look to the welfare of the squirrels and birds. Deer will come, in time, to eat from his hand. Even the flowers in our cultivated gardens are responsive to the tender thoughts and ministrations of those who lovingly supply their wants. Everywhere can be found dependents, not forgetting the needy poor and the otherwise helpless among humanity.

The housewife who prepares and serves to her family two or three meals a day, is collecting silver. So is the man of the house who toils at office, factory or farm with the thought in mind of being a good provider. If his thoughts are on what money will buy for himself, or on the attainment of honor, he is not acquiring silver. But if his attention is much engrossed by supplying the needs of his family, if on his return from work he brings food or clothing, or suggests that they be ordered by others, he is adding silver to his alchemical supply.

In addition to being purified, by separation from the dross of the external effect of violent, aggressive and constructive activities, and fluxing with an equivalent amount of silver, iron, like lead, needs considerable heat from the reverberatory furnace. Its vibrations, as they are acquired on the physical plane, are little adapted to imparting motions to anything finer than astral substance. Therefore, not only the

effect on the soul, but the effect on society at large of all such activities should be kept in mind. Not merely the attitude, what does war do to my soul? but also the attitude, what does war do to mankind? should be a foremost consideration.

Machinery, industrial development, the erection of huge manufacturing plants, because they lighten or increase my physical burdens, and because they restrict or expand my periods of leisure from irksome employment and thus influence the time I can devote to other things, have an influence upon the development of my soul. What that influence is depends, of course, entirely upon my attitude toward these situations. I can gain in soul advancement or retrogress under any of the conditions met in modern industrial life. Recognizing this, and making gain from each experience, is to purify the metal and get rid of the dross. But if I am to complete the transmutation, in addition to purifying and fluxing with silver, I must also try to perceive the effect of each event on the progress of universal society. And I must fervently bend my energies to directing all such activities into channels of universal good. Such zeal to assist constructively in universal progression furnishes the heat with which to finish the transmutation of iron.

Transmuting Copper

—The gain or loss of husband or wife, the relation with friends, love affairs and scandal, social advancement or disgrace, jealousy, beauty, artistic appreciation, amiability, conjugality, mirthfulness and the expression of the affections are some of the more common kinds of copper.

Copper, like tin, when once purified is one of the easiest of metals to transmute. It has about it an inherent warmth that raises its vibrations to a point where with very little additional heat they communicate their motions to spiritual substance. Love is convertible. It is desire, passion, attraction, affection, fire, enthusiasm, God. It ever exerts a molding influence upon the form, whether that form is physical, astral, or spiritual. It is the attractive force that manifests throughout nature, and that holds the form together. To live there must be a desire for life, although this desire may reside almost exclusively in the unconscious mind. People sometimes say they no longer desire to live, but unless the desire to live was stronger than the desire not to live they would die. Either an individual or a race that fails to love life strongly soon perishes. Likewise, the love for a spiritual life and the things of the spiritual plane are requisite for continued spiritual existence. But aside from this, the vibrations of love, when unselfish, tend to affect spiritual substance and build up the spiritual body.

Nevertheless, as with other good things, there can easily be an excess of copper. It manifests chiefly as a tendency to seek the line of least resistance. Disagreeable duties are shirked. Problems are avoided rather than faced. Hard work of all kinds is avoided, and there is a tendency to spend too much of the life pleasure seeking rather than in the accomplishment of worthy enterprise. Joy and amusement have their place, but such excess of copper, before there can be constructed a complete spiritual

body on the inner plane, must be balanced and fluxed with an adequate amount of lead.

Lead is not hard to find. It may be had in quantity anywhere. There is always work to be done by those with the will to do it, especially hard, disagreeable, and monotonous work. Yet it is a great affliction to the soul to be born and raised with a silver spoon in its mouth, waited on hand and foot, always with someone else to face the difficulties and shoulder the burdens. It is a great affliction unless it comes to realize the necessity of acquiring a suitable flux of lead, and refuses to be thus weakened through over sheltering. Even a plant, if it is to grow hardy and strong, must learn to endure the hardships of rugged existence. So also, if it is to have a powerful spiritual body, the soul with an unusual amount of copper must be fortified with a flux of lead.

Wherever men live, there await responsibilities and burdens. Anyone can see them, although not all are eager to shoulder them. Hardship, privation and unremitting toil for the sake of others is an ample flux for excessive copper. And the copper itself is quickly converted into spiritual values and thoroughly transmuted when its effect, in each instance, as affecting the progress of the cosmic whole, is realized and considerately planned.

Transmuting Mercury

—Intellectual activities, educational advantages, teaching, writing, travel, contacts with literature, clerical mistakes, errors in contracts, mathematical work, accountancy, stenography, and acting as agent of another are the more common ores of mercury.

It is a metal of unusual variability and restlessness, and a most essential factor in the handling of other metals. Unless it is present, even lead is frustrated; for plotting and scheming, either constructive or destructive, comes to naught unless carried out intelligently. Iron needs it also; for combat and building alike depend for effectiveness upon intelligence. Nor can we live in a truly religious manner, or otherwise cultivate tin properly, without the exercise of reason. The gold of power, the silver of domestic responsibility, and the copper of worth-while friendships, alike are made more valuable by the presence of the mental keenness of mercury.

An over supply of this most adaptable of the metals is possible only through lack of an equal amount of its natural flux. We can not have too much intelligence, nor can we overdo the exercise of reason, except when we allow them to monopolize the life to the exclusion of other metals, and especially tin. Unless adequate tin is present, intellect readily assumes to itself a surety and infallibility that is not borne out by a record of its past performance. It becomes arrogant in the belief that it alone is capable of rightly directing the conduct of men, and of solving the problems of the universe.

This attitude, which material science has often held, unduly narrows the vision to the

scope of the physical world alone, and denies that which can not directly be apprehended by the five senses. But because of this narrow vision, science is compelled every decade or so to shift its platform to embrace conditions that previously had been ignored or denied. When intellect presumes too much, or whenever there is excessive mental activity, before the mercury will transmute it becomes necessary to supply an equivalent flux of tin.

This tin may be had anywhere, and opportunities for its gathering are presented to each individual every day. A smile of kindness is not beyond the accomplishment of the most erudite man of science. A story that will evoke a laugh can readily be picked up and passed on, although remembering and telling it is an art to be cultivated. Prayer, now and then, even though silently uttered, costs little in the way of effort; and to pass the time of day with either a street sweeper or a banker is not a great price for tin. And as the financial means permit there should be gestures of more concrete munificence.

Finally, when properly fluxed with tin, the metal should be treated in the reverberatory furnace. To provide this heat, each gain in knowledge, and each mental advancement should be felt to be additional equipment which there is strong desire to use in the interests of universal progression.

Transmuting Silver

—Domestic relations, the home, children and other members of the family, dependents in general, food, shelter and the various commodities that make life endurable furnish those experiences that are the commonest forms of silver.

Where such contacts evoke tender emotions and the desire to nourish and protect weaker individuals, they are transmuted with little further effort. But such as come grudgingly, or that engender resentment, need careful purifying and treatment. In any event, the addition of an equivalent amount of iron hastens the process and gives the product a well balanced composition.

Not only is iron everywhere present, but more often than not it is forced upon us by others. It should never be obtained with a sense of enmity or hatred, but with the sense of firmly standing for that which is most beneficial to all. To permit others to impose upon us unduly not merely weakens our power of resistance, but through building up the habit of taking advantage of people, actually injures the character of the person doing the imposing. Yet in energetically struggling to advance those causes that are for universal welfare, in protecting the weak, and in repelling invasion, neither anger nor the desire for destruction should actuate the person, but instead there should be present an energetic determination merely to establish conditions that are for the betterment of society. This furnishes an ample flux for silver.

In the reverberatory furnace, the home life and the domestic relations throughout,

should be recognized as steps in the plan of universal construction. Parenthood here should be perceived as the shadow of a still wider and more potent influence having for object the care and development of others.

Transmuting Gold

—Honor, position, station, employment, authority or lack of it, leadership, power, egotism, credit, the relation to boss or employer, and political efforts are the more common contacts of life that furnish those experiences that may be classified as untransmuted gold.

These do not require to be fluxed with other metals, but they do need to be purified with unusual care. Furthermore, whatever station of power and authority is attained in life, whether humble or exalted, carries with it some opportunity of influence for cosmic advancement. Even loss of employment or discredit injures the soul only when there is an error in viewpoint. Yet because of such experiences a better understanding may be had of the needs of others in similar circumstances. Some opportunity to exercise an influence for the betterment of human life is ever present, and when grasped and such power as at hand is exercised, gold is quickly transmuted, and together with the other six transmuted metals completes the building of an imperishable and perfect spiritual form.

Chapter 5

Serial No. 53
Original Copyright 1931
Elbert Benjamine

Copyright
Church of Light
August 2002

Higher Consciousness

Chapter 5

Higher Consciousness

THE transmuted gold of the spiritual alchemist is nothing less than a complete spiritual body, built by proper states of consciousness toward the various experiences of life. These experiences are the ores, or unpurified metals. To build a perfect spiritual body, in which the soul can function immortally, all seven types of metals, or experiences must be collected. They must be thoroughly purified by discarding the dross of appearances and retaining for use only the effect upon the character. Then they are properly fluxed, one against another, and each treated with an adequate heat for the reverberatory furnace of their relation to cosmic welfare. In all these processes the mental attitude toward the things which happen is the important factor, and if at each state it is properly maintained, there results a body imperishable, a form of spiritual gold.

Because, therefore, this factor of consciousness is so all-essential in the work of the spiritual alchemist, it warrants a discussion of its various details.

Intelligence, Substance, Motion

—At start we must get rid of the notion that inanimate objects are wholly devoid of consciousness. Consciousness is everywhere present in degree, as are also motion and substance. The universe consists of this trinity, and where all three are not present there is no existence. Wherever there is substance there is also motion, in fact, a last analysis shows that a given substance is a particular kind of motion. A solid has one kind of molecular motion, a liquid has another molecular motion, and a gas has still a third molecular motion. Also the atoms within the molecules of one type of matter have motions that differ from those of atoms of a different type of matter; and the electrons and protons of one kind of atom move relative to each other in different combinations than do the electrons and protons in another kind of atom. Going still further, astral substance in one kind of motion is a particular kind of thought; in another kind of motion it gives the appearance of an object. Spiritual substance, also, has motion, and may through its motion express either thought, or such conditions as are more related to form.

Yet form itself, whether expressed in spiritual substance, in astral substance, or in

dense matter, also has some intelligence. That is, unless intelligence is inherent in substance it springs from nothing. But as we have had no experience of anything springing into existence from nothing we can not accept this. The other alternative is that intelligence inheres in substance and expresses itself only when substance moves in a particular way, just as form is such a particular movement of substance. But after all, while one particular form or one particular type of intelligence expresses substance moving in some particular way, we have had no experience of substance without some kind of form, and experiments carried out by scientific men warrant us in inferring that there is intelligence in some degree present also.

Bearing this out, the experiments of Professor Bose prove that minerals are alive and may be poisoned, or put to sleep, or even killed. A degree of intelligence below the mineral may be too faint for us to discern at present. But just as finer instruments have detected substances smaller than the atom, so finer instruments have detected intelligence in some degree in substances long considered non-intelligent. At present the instruments of material science are not delicate enough to detect substances finer than field or intelligences simpler than those of the mineral. Yet this does not indicate that the limit of refinement of substance or simplification of intelligence has been reached. It merely indicates the present boundary of man's skill in making instruments of great delicacy.

We are unable to say of something that this is motion and not substance; or of something else that this is substance and not motion; for we have no experience of the two apart. Likewise, while the intelligence of a thing may be more difficult to discover, such investigations as have been made show that as more delicate apparatus is devised the frontier of intelligence recedes. That which was once considered dead matter now is shown to exhibit all the responses of life. Where does intelligence start, and where does it leave off? The line of demarcation can not be pointed out. However obscure it may appear, our experience indicates that some degree of intelligence is present in all substance; for given the right conditions it expresses itself.

If we observe nature closely we are soon convinced of an orderly procession of changes that lead by gradual steps to more complex expressions of life and mentality. Such a system could not result by chance. And we can trace intelligence from such cosmic expression down to a feather-edge, even as we can trace the substance of the universe to atoms, and these to positrons and electrons sheared out of field. Here we lose sight of matter, nor do we perceive it again until its electrical components join out in abysmal space and give rise to the cosmic ray. Yet before so joining to produce the star-dust of which the material universe is composed, our logic convinces us there was form and motion of some kind. Thus also, experiments with psychical phenomena must soon convince any open-minded investigator that there is some degree of intelligence always ready to express itself whenever there is an organism capable of permitting such expression.

Chemical Consciousness

—This intelligence displays itself through the activities of the minerals of which the earth is composed. They possess a discernable discrimination. Their chemical changes are not fortuitous, but governed by the same broad law that determines the alliances between members of the human race. Man is drawn to certain companions, and repelled from others. The atoms of matter exhibit similar preferences. And as a man, when he meets someone toward whom there is an unusually vigorous attraction, forsakes previous companions to join forces with the new ardor, so also does an atom forsake the group to which it has been attached and form a more durable partnership with another atom that especially entices it.

Invariably, man's actions are in the direction of his strongest desires. These desires in man are more complex than those of an atom; but an atom also moves in response to the same general law, and its actions are always in the direction of the strongest attraction. Man has had wide experience with different forms and conditions of life through which he has developed an extensive range of consciousness; and he has a brain, or specialized instrument, through which he can express his consciousness, utilizing mental pictures and symbols as thought. The atom has had very limited experience, and it possesses no specialized instrument of consciousness. Such consciousness as it has is retained as modes of motion, resulting from its experiences, in the astral substance associated with it. Nevertheless, its movements, such as they are, result from the feeling, which in higher life we call pleasure and pain, that is experienced when in proximity to various other atoms.

This consciousness of attraction and repulsion felt by atoms induces them to join in the formation of molecules. Then a colony of molecules may combine in a particular way to form the body through which an impersonal soul that has graduated from the stages of atomic consciousness can express itself. Such a colony dominated by a sovereign intelligence is called a crystal.

Crystals that are composed of a given kind of molecules tend always to assume the same shape. Just as some men are small and some are large, yet retain the human outline, so also crystals of a certain mineral may be small or large, but tend ever to the same form. Each is occupied by an impersonal soul with a consciousness far more extensive than that of an atom. Such a soul, if enough evolved through the mineral kingdom to do so, may attract about itself a body of singular brilliancy. This we call a gem.

The subjective intelligence of a gem has considerable scope; and is sensitive enough to be keenly alive to the personal magnetism of a person wearing it, to astral currents from the planets, and to approaching conditions that it sense from the astral plane before they manifest externally. Gems are not the only talismans, and the influence of some talismans is due rather to strong vibratory rates that they emanate, rather than to sensitive intelligence. Yet such a gem, when worn by a person whose most

harmonious vibratory rates are of the same frequency as the vibratory rates of the gem, not only strengthens the power of the person to attract good fortune, but perceiving by its interior sensitiveness the approach of conditions beneficial or the reverse, it is able to impress the wearer to take actions that are of the utmost benefit. It thus exercises a power as a talismanic gem.

The possibilities of mineral life are restricted, but we find very definite things that there must be learned. Assimilation and secretion as found in organic life depend upon the power of discrimination as exercised by atoms. This selective action, which is commonly recognized in chemical changes and in the formative processes of crystallization, is the chief manifestation of life and intelligence in the mineral realm. And because of its importance to higher life, we are safe in saying the primary function of life in the mineral kingdom is to confer that form of intelligence known as SELECTIVITY.

Now the astral brain of man has a scope of consciousness of great breadth, and it is possible to raise or lower its frequencies to that it enters into rapport with the astral consciousness of other entities. When a point of contact is established between the entity and man's astral brain, the rates of motion in the consciousness of the entity communicate themselves to man and he becomes aware of such consciousness as is possessed by the entity. This awareness will commonly be entirely subjective, but through practice it can be brought up into the region of full objective consciousness. The proper rapport, or contact, is formed by steadily focusing the attention upon the object, and through the imagination entering into its life and form. By the exercise of keen sensitiveness one can then become objectively aware of the feelings and experiences of the entity then contacted.

In this manner it is possible to select a gem or mineral and by focusing the attention on it to establish a point of contact. Of course it is necessary to shut out all thoughts and impressions except those that are received from the mineral. But when successful there will be an awareness of the full consciousness of the mineral, its attraction and repulsions will be felt, and it is possible to trace its history back through eons of time. This is called experiencing mineral consciousness.

Next above the mineral realm we have the vegetable kingdom. When the experiences in the mineral kingdom have been sufficiently extensive to organize an astral body of ample complexity the impersonal soul builds about itself a simple cell. Then, as the result of experiences in single cell life, as astral organization becomes still better organized, each experience adding its energy to the astral form, until it is capable of dominating a whole colony of cells. Thus to its own consciousness, in a measure it adds the consciousness of every atom, molecule, and cell of what is now a multi-celled plant. By virtue of the more highly organized activity of its astral form it exercises a controlling power over them, and has a distinct kind of consciousness not possessed by minerals.

This consciousness does not confine itself to feelings of attraction and repulsion, pleasure and pain, but extends itself to a type of perception which expresses itself as

intelligent ability to adapt itself to changing environment. Thus a growing plant often deviates markedly from its common form and shape to be able to get the proper amount of sunlight. Nor do the tendrils of a vine reach out blindly in all directions, but possess a consciousness of the direction in which there is a crevice in which they can secure a firm hold; and they reach to the crevice instead of in the opposite direction. Some insectivorous varieties such as the sundew, butterwort and pitcher-plant even devise means to ensnare insects and prey upon them displaying an acute degree of sensitiveness and a certain subjective cunning to accomplish their ends. This quality of sensing the conditions present in the environment is the chief manifestation of intelligence in the vegetable world. Because of its importance in still higher forms of life we are warranted in the belief that the primary function of life in the vegetable kingdom is to develop that form of intelligence known as SENSITIVENESS.

As with a mineral, also with a plant, it is possible to direct the attention fixedly upon it and through pantomime, or imagining to be in its place, to enter into full possession of its subjective life and consciousness. All the various moods felt by the plant may be felt, and these moods may become so impressive that as they rise from the astral brain into objective consciousness they translate themselves by means of definite words and sentences as if the vegetable actually talked in the accustomed language of the human race. Of course, the speech really arises from the habit of the person's unconscious mind to express its feeling in thoughts. This is called experiencing organic consciousness.

Such ability to enter into rapport with cell-life has a still more practical application in diagnosing the conditions that exist within the human body. Through the same method it is possible to form a point of contact with the consciousness of certain cells, or enter into the consciousness of a particular organ of the human form. Such experiments are more easily performed upon oneself, although the same method may be employed to learn the conditions affecting another. Through the powers of the imagination, visualizing identity with the part, the vibratory rates are raised or lowered until there is felt that particular sympathetic relation that permits the feelings of the organ or part to be received by the astral brain and raised into objective cognition.

By entering into the consciousness of the various organs, the seats of physical inharmony quickly becomes painfully apparent. Often this inharmony is really the call of the cell-life in some particular region for some requisite element, or for the elimination of superfluous material. The desires of the cell-life, in such instances, indicate what is required to establish normal condition. The consciousness not only feels what is wrong, but prescribes the proper remedy. This is called CHEMICAL CONSCIOUSNESS.

Such a state of higher consciousness is not difficult to cultivate to a stage of great utility. Only the trained occultist, to be sure, is able to analyze conditions in detail; but almost anyone with a little practice can learn just what kind of food the system requires at a given time. But to do this, the habit of eating only certain foods at certain

times must be discontinued. Hunger should actually be felt before eating. Then, for a few minutes, the body should be relaxed and the mind centered inwardly with the expectation that the astral brain will find out just what elements the system requires and what foods will supply them. Then the mind should be permitted to meander dreamily over various articles of diet; and those may confidently be selected toward which there is a strong spontaneous attraction arising from the inner consciousness.

In this manner it is not difficult to learn to select such foods as will supply the very elements the system requires for perfect health. If the system requires acids, the desire for certainly fruits will arise from the astral brain into the consciousness, and if the system requires alkali or protein there will be an inclination, or hunger for such articles of diet as contain it.

The consciousness of the cell-life or the needs of a given organ is perceived by the astral brain in proportion as its attention is centered on it; but the astral brain may not be able to impart more of this consciousness to the physical brain than merely impress it with the desire for the particular food. More detailed perceptions require greater training. But when the food enters the thoughts there is felt an assurance that it is the correct one.

If the astral brain is thus relied upon to furnish information, it soon develops the ability to direct the attention to the proper things. Even animals, as is well known, in the natural state, obeying their inner impressions, have the ability to search out remedies for many of their ailments. But if, instead of following such impressions, people yield to artificial desires for food and drink these artificial desires gain dominion over those arising from the more interior consciousness and there is a conflict of impressions. Then, as ever, action follows the strongest desires. Yet it is not difficult for most people to acquire chemical consciousness to a very useful degree if they will but follow their inner impressions rather than the demands of habit, artificial pleasures, and convention.

Vegetative Consciousness

—As is well known, cut flowers when worn by some persons keep their vitality for a long time, but when worn by others they fade and almost immediately die. Such sensitiveness is also shown by pearls, which lose their luster when worn by people whose magnetism is unsympathetic to them. Because of this, those who possess valuable pearls often make it a practice periodically to turn them over to be worn by another whose temperament is especially harmonious to them. This keeps them alive, and restores their original brilliance.

Growing plants and flowers also thrive under the care of persons of certain temperaments. The aura of such persons imparts life-giving strength to them, while the same treatment given by a person of the opposite magnetic temperament causes them to wither and die. Thus it is that some people can transplant vegetables with very little care as to weather conditions; and if the plant shows signs of pining they

talk to it kindly, telling it to brace up, and it responds and immediately begins to thrive. Yet others, taking every precaution and care, find it difficult to get plants to grow.

Vegetation is not only sympathetic to auric emanations, but readily responds to the suggestions of those in vibratory sympathy with it. A plant does not reason about the matter, but through the rapport established with it, feels the urge, and grows as this internal feeling prompts. Luther Burbank made constant application of this method in the improvement of plants; and such suggestions systematically applied by other gardeners who have the sympathy of their plants, are able to bring about pronounced changes in the nature and form of growing vegetation.

People also thrive more when in association with those of harmonious magnetic temperament. Some are more sensitive than others to such influences, and detect the quality and many salient facts about both people and objects merely through being brought within the sphere of their auras. This sensitiveness may be cultivated to a point of high accuracy and real utility by making it a practice to analyze the first impressions felt when for the first time in the presence of objects or persons, and later checking the accuracy of these impressions. Because sensitiveness to environmental conditions is first highly developed in the vegetable kingdom, the exercise of this ability to sense facts about things from their auras is called VEGETATIVE CONSCIOUSNESS.

Psychic Consciousness

—In this vegetative consciousness the medium that carries the vibrations is electromagnetism, and as a rule such impressions are obtained only when within close physical proximity to the object. That is, the impressions are received chiefly from its electromagnetic body. But by carrying the experiments to a finer degree of sensitiveness the impressions perceived are those from the astral form of the person or thing. In this case distance plays no considerable part; for if the conditions of rapport are present between the astral bodies, or if the senses of the astral form are properly focused, accurate impressions may be received from a thousand miles as easily as from a few feet. Furthermore, the impressions are not confined to beings of the physical plane, but extend to entities that have no material form, but exist solely on the astral plane of life. In all such cases the awareness is first present in the astral brain, from whence, through the medium of electromagnetic motions, it is raised into the region of objective consciousness. The exercise of this ability to sense the quality and presence of astral beings is called PSYCHIC CONSCIOUSNESS.

Simple Consciousness

—The range of consciousness common to plants is greatly extended in animals. Animals are more conscious of their bodies, and in more or less degree have the

ability to adapt means to an end. The higher forms of animals are just as aware of their bodies and the objects of their environment as is man. They see, hear, feel, taste and smell much as man does. They also possibly reason to a limited extent. A dog or a horse seems to learn some things through observation. But the most pronounced characteristic of animal life is INSTINCT.

A carrier pigeon will wing its way home straightway from an immense distance with no perceptible guides as to the direction in which it should fly. A horse will find its way in a storm under conditions that render the five senses valueless, or on a desert will find water that baffles the efforts of man to locate. The oriole builds a hanging nest of woven fabric. The bee builds a cell so economically perfect that an error in higher mathematical tables was discovered through calculating the angle of a cell that would theoretical require the least material and finding that this theoretical angle was not exactly that used by the bee. The great German mathematician, Koenig, found the bee slightly wrong. But an eminent Scotch mathematician, MacLauren, working with different tables at a later date found the bee exactly right. Carrying his investigation further, he found that the work of Koenig was correct, but that the tables available to Koenig, which were commonly used in higher mathematical work, were imperfect. Thus did the bee correct the table of logarithms.

Bears and badgers fatten in the autumn and then self-hypnotize themselves and spend the long winter months, while food is scarce, in trance-like sleep. Waterfowl seek the reaches of the Arctic seas to rear their broods in summer, then wing their way unerringly to warmer climes at the approach of winter. Trackless uncharted regions are crossed, they fly much at night, and young birds often precede their parents, yet they do not lose their way.

The exercise of such instinct is made possible through the raising into objective consciousness of information perceived by the astral brain. The perceptive powers of the astral form have a much vaster range than those of the physical, and thus become a more competent guide to action. In the case of animals, because reason has not been developed, the exercise of instinct is largely confined to such conditions as have habitually confronted the race. Thus, because of its wider perceptive powers, under usual conditions instinct is more efficient than the reason of man. But, because the astral brain has had little experience meeting other than certain kinds of problems, when unusual problems are presented the instinct of the animal often leads it astray. In spite of the range of its perceptions, the habitual method of meeting conditions is too strong to be radically changed.

Men also receive the promptings of their astral brains. But their instincts need not be so restricted by habit as those of the animals, because man has become accustomed to using reason to adapt himself to new and strange conditions. The more vast scope of information afforded by the perceptions of the astral brain gives this astral brain superior material for a process analogous to reasoning. Usually man's instincts are atrophied, but they may be cultivated to a high degree of usefulness and accuracy by listening to their promptings. Properly cultivated they are a better guide to action than reason. Because they are frequently accompanied by thought processes which

may intrude into the objective mind in the form of words and sentences, in man instinct is often called THE VOICE OF THE SILENCE. It is the most obvious factor associated with SIMPLE CONSCIOUSNESS.

It is also possible for man to place himself in rapport with some animal. In this state there is a temporary blending of the identities, and the astral form of the animal imparts its rates of motion to the astral form of the man in such a way that he experiences all its feelings, desires and instincts. He is conscious of its limbs and organs just as if, for the time being, they were his own.

When such a rapport is established with either a plant or an animal it is also possible, through the power of the imagination, to organize lines of electromagnetic communication through which the vital strength may be drawn. In this manner the physical vitality, called vegetable magnetism or animal magnetism, may be obtained from other forms of life. Hermits and recluses unconsciously often draw thus upon the life forms by which they are surrounded so that they require almost no food to live. People of abnormal temperaments also sometimes thus drain the vitality from other people, usually being unconscious of the process, except that they feel so much better after being in the society of others. The yogis understand this process and make use of it to draw electromagnetic energy from plants and trees, to be converted into higher modes of motion, which enable them to do the most amazing things.

Animals have a certain capacity for devising the means to attain an end, but in general seem incapable of considering themselves as distinct creatures unique from the rest of the universe. It would seem that they are unable to consider their own mental states as objects to be thought about; nor do they commonly make use of conceptions. Conceptions imply the use of symbols as counters of thought. The impressions animals receive no doubt are superimposed, and there is little doubt but that they recognize similar attributes in all trees, in all stones, and in all other animals. But they do not give this quality an abstract name and mentally refer to it by this collective symbol. The ability to do this, to analyze one's own mental processes, and to communicate the results of such introspection by means of language, indicate the presence of self-consciousness. Because all normal men possess this ability, we are safe in assuming that the chief function of life in the human form is to confer SELF-CONSCIOUSNESS.

Rational Consciousness

—Because they have self-consciousness, and thus the power to reason, most persons permit the other forms of consciousness to atrophy. They so thoroughly rely upon the reports of the five physical senses, that they neither heed nor recognize the reports of the various psychic senses. They so completely rely upon the bringing together in objective consciousness of the reports of the physical senses that they take no cognizance of the bringing together of these reports in a more perfect mental process by the astral brain. Already this process has been mentioned in relation to instinct and

the voice of the silence. It is the instinct of animals reinforced by the reason of man; but this reasoning draws its information from both planes of life, and because it takes place in the astral brain its processes are almost instantaneous. Such reasoning carried out by the astral brain and then brought up into the region of objective consciousness is a surer guide to action than the limited perceptions and ponderous process of the physical brain. It is called INTUITION.

Carrying intuition into the realms of the soul and ego, those religiously inclined often become enthused with the idea that they are saved. This inward conviction is so strongly realized that henceforth they can not doubt for a single instant that they are immortal. The experience usually follows deep meditation upon such matters accompanied by a state of mind that permits the astral brain to impart its convictions to the physical consciousness.

More often than not this deep unalterable conviction of immortality is covered by a cloak of sacerdotal rubbish. Whatever the religion of the individual, it has usually been so thoroughly impressed upon his astral brain by suggestions during childhood that all information coming from the inner plane is colored and warped by it. The ideas impressed upon the astral brain by early religious training stand as censors at the gate of his objective consciousness, and will only permit such perceptions and knowledge to pass as clothe themselves in the garments of these earlier convictions.

But underneath all this there is a very sound reality. By turning the attention resolutely to the soul and ego, shutting out the sensations and thoughts of the external world, it is possible to train the intuition upon these things and gain knowledge of the preceding, and the after, life. The intuition, reasoning from an infinitely broader field of perceptions of both external and internal conditions, and being more efficient in its processes than conscious reasoning, is able, unless too greatly hampered by the power of images received in early religious training, to report accurately upon the truth of things.

The truth is realized within that the spirit is eternal and that the soul is a real and immortal entity. The conviction is so certain that not a grain of external evidence is required. In fact, the trained intuition can be relied upon in this as in other things; for if always whenever the intuition is active its reports and conclusions have proved on investigation to be true, we have every inducement to trust it also in this most important thing. This is not a very difficult state of consciousness to attain, and when once felt, and the assurance of the reality comes flooding in upon the soul, there is never afterwards any doubt concerning life after death or of the soul's perpetual progression. Because this state of consciousness comes only to rational beings, the inward realization and overwhelming conviction of the eternal nature of the spirit and the reality and immortality of the soul are called RATIONAL CONSCIOUSNESS.

Cosmic Consciousness

—Even as man is a conscious being, so also is the universe. It is not an automaton, but an organization guided by intelligence.

It is true that each cell in man's body has a consciousness all its own. So also the various entities comprising the cells, as it were, of the cosmos have an individual consciousness. But man's consciousness is not merely the collective consciousness of the cells comprising his body. On the other hand, these cells have been collected into a complex organism so that man can express the consciousness which is his soul. And we may be sure, likewise, that the soul of the universe is not merely a collection of all the separate individual souls of its parts, but that all these separate souls are organized into the vast and complex organism, a corner only of which we can see, to permit the expression of that deific consciousness which we call God.

There is, however, a relation between the consciousness of a cell in his body and the consciousness of a man, through which he influences the conduct of the cell. This interrelation by which man's astral intelligence guides the cell-life in the various processes and functions of the body is usually below the threshold of objective consciousness. Nevertheless, as is demonstrated by the effect of suggestion and emotion on these functions, the activities of assimilation, circulation, nutrition and secretion are thus directed by the unconscious mind.

Furthermore, there is also an interchange of consciousness between certain cells and organs and other cells and organs, as may be inferred from sympathetic symptoms. Through this interchange of consciousness a pressure or inflammation in one part of the body may set up a disturbance or inflammation in another and distant part of the body to which sympathetically related. Or, under more severe conditions, the whole body may respond adversely to a discord arising from the discomfort of a single organ.

Now let us consider man in relation to the cosmic whole. He is one particular kind of cell-life in the body of Deity. Other entities are cells of a different kind, or if still more complex in function, like our solar system, they may be deemed organs in the anatomy of the Cosmic Man.

Each cell, however, in the body of man has its own particular work to perform. No other cell can perform its function quite as well as it can. So, likewise, each person has some particular work in the cosmic scheme of things to do, and he can carry out this activity to better advantage than can any other soul. To be sure he is being educated for the performance of this special function, and every experience he has ever had has been attracted to him as an essential and needed part of this education.

Now no single step in this process of education advances the soul more than that in which it becomes aware of its proper relation to other entities, and aware of its real work in cosmic construction. This step may be taken by establishing a rapport with

universal life and consciousness.

It has already been explained how, by raising or lowering the vibratory rates through using the imagination to identify oneself with another entity, it is possible to enter into the consciousness of a mineral, a plant, or an animal. One may also, by a similar process, enter into the collective consciousness of an audience. This is what the inspirational speaker does. He stands before an audience, places himself in sympathetic vibration with it, and then gives back to the people not merely the thoughts of their conscious minds, but also the ideas held by their astral brains. Because he collects, in one consciousness, facts and conclusions drawn from many minds, he is sometimes able to give them facts and ideas not one of them had been aware of before. So too, in times of national stress, people in general, as well as those psychic, unwittingly enter somewhat into the wider consciousness of the nation, and feel the same things and think the same thoughts, as others from whom distantly separated. And this same principle of entering into the collective consciousness of a group, extended to the whole group of intelligences embraced in the universe, enables one to enter into the consciousness of the entities comprising the separate parts of the cosmos.

Such a rapport is usually attained through holding the thought, *My Soul is One with the Universe*. This thought, if held persistently under deep concentration, and with the imagination used to “feel” the universal consciousness, leads the soul to the realization of its oneness with all other atoms of life, enables it to discern its work in the universal plan, and reveals to it many fundamental truths regarding the operation of nature’s laws. These experiences are usually of very short duration and accompanied by an ecstatic state in which there is a feeling of great joy, happiness, peace, and contentment, for which reason it is often spoken of as the peace that passeth understanding.

Plotinus, speaking of this higher consciousness said: “Knowledge has three degrees; opinion, science, illumination. The means of instrument of the first is sense; of the second dialectic; of the third intuition. To the last I subordinate reason. It is absolute knowledge founded on the identity of the mind knowing with the object known.”

Such consciousness is formed through the astral brain of man entering into a sympathetic relation with the collective astral consciousness of all other entities. This state which brings to man the realization of the soul’s oneness with the universe, and also the realization of the divine origin of the ego, is called COSMIC CONSCIOUSNESS.

Divine Consciousness

—Consciousness, however, is not limited in its extent to physical and astral planes. Thought organizations of the astral plane may be raised in vibratory rate sufficiently to transmit their energy to, and persist in, spiritual substance. The circumstances under which they do this have been thoroughly discussed in the preceding chapters of

this course. Furthermore, if these thought organizations are to form the mentality of a soul functioning on the spiritual plane, they must attract about themselves a suitable body of spiritual substance. To gain the experiences of life in proper quantity and proportion, to purify, flux and transmute them, and thus build up an immortal spiritual body in which the consciousness can dwell and function, is the object of spiritual alchemy.

When thus the consciousness has been extended in range to embrace entities and thoughts existing on the spiritual plane there is a still more vast field of information and source of energy available to the soul. Such a spiritual source of information and such spiritual energy is only accessible to those of the highest true spirituality; for others have not yet advanced far enough in spiritual alchemy to have spiritual forms from which to draw. They as yet have only astral bodies, or only fragments of spiritual bodies built up; and will complete the building during their residence on the astral plane after physical death. But the most advanced of the race, although they may never have heard of spiritual alchemy, have nevertheless practiced it, and have well organized spiritual bodies. And to a certain extent they are able to bring the perceptions, energies, and consciousness of the spiritual plane of life, through the medium of astral vibrations, into the region of objective consciousness. This results in ILLUMINATION. It is sometimes called CHRIST CONSCIOUSNESS, but a more precise term is DIVINE CONSCIOUSNESS.

History records many instances of those who have attained this highest of all states of consciousness attainable by embodied man. Among them may be mentioned: Apollonius Tyanaeus, Guatama Buddha, Dante, Walt Whitman, Mohammed, Francis Bacon, Jacob Boehme, Las Casas, Jesus the Nazarene, Paul, Balzac, Wm. Blake, Edward Carpenter, John Yepes, Socrates, Swedenborg, Thoreau, Emerson and Plotinus.

Plotinus, who lived in the third century A.D. says of it:

“You ask how we can know the infinite? I answer, not by reason. It is the office of reason to distinguish and define. The infinite, therefore, can not be ranked among its objects. You can only apprehend the infinite by a faculty superior to reason, by entering into a state in which the divine essence is communicated to you. This is ecstasy. It is the liberation of your mind from its finite consciousness. Like only can apprehend like; when you thus cease to be finite, you become one with the infinite. In the reduction of your soul to its simplest self, its divine essence, you realize this union, this identity.

“But this sublime condition is not of permanent duration. It is only now and then we can enjoy this elevation (mercifully made possible for us) above the limits of the body and the world. I myself have but realized it three times as yet, and Porphyry hitherto not once. All that tends to purify and elevate the mind will assist you in this attainment, and facilitate the approach and recurrence of these happy intervals.”

A certain degree of illumination also may accompany cosmic consciousness, and commonly does so, but it is an illumination springing from the astral rather than from the spiritual plane. But in the illumination of Divine Consciousness, the ego,

occupying as it does the spiritual plane of life, is able to communicate the perceptions and conceptions of the spiritual brain to the brain of the physical body.

Only one who has, through the processes of spiritual alchemy, built up a sound and vigorous spiritual body can experience Divine Consciousness. This imperishable form functions on the same plane, and is occupied by, the ego; and because the ego is at all times connected, by the rays of vitality it sends them, with both its soul-monads, when either of them has evolved far enough to experience Divine Consciousness, it can become aware of the existence and whereabouts of the soul-mate. And because the substance of the spiritual and astral bodies contain, as modes of motion, a complete record of the experiences of the soul, in this state of consciousness it is possible to trace backwards and remember any and all of the experiences of the soul since its first differentiation.

Because the spiritual body is occupied by the ego, when the perceptions and conceptions of the spiritual brain are raised into the region of objective consciousness it is common to say that the ego is incarnated in the physical brain. Not that the consciousness is at all times flooded by the spiritual light in the ecstasy of intense illumination; but sufficient communication is maintained between the spiritual brain and the physical brain, so that the activities of life are directed from the spiritual plane. This perfect and continuous rapport between the soul and the ego is the object the adept strives to attain.

Because his information is derived from the spiritual plane, where the range of his perceptions is immensely extended, and where he contacts exalted intelligences of vast wisdom, he becomes conscious of Divine Intention, and clearly perceives his own function in the Divine Plan, and just what he can do at any given time to further cosmic construction.

The spiritual alchemist, therefore, who is able to attain a somewhat continuous Divine Consciousness, not only has built for himself on the inner plane of life an immortal spiritual body in which he will consciously function after the passing of both the physical and the astral body, but he also is so thoroughly in contact with the spiritual plane of life that his actions are at all times directed by Divine Guidance, and his efforts at all times are in the direction that provide the greatest benefit for all.

Book 4

Copyright
Church of Light
August 2002

Ancient Masonry

Chapter 1

Serial No. 6
Original Copyright 1938
Elbert Benjamine

Copyright
Church of Light
August 2002

Ancient Masonry Introduction

Chapter 1

Ancient Masonry Introduction

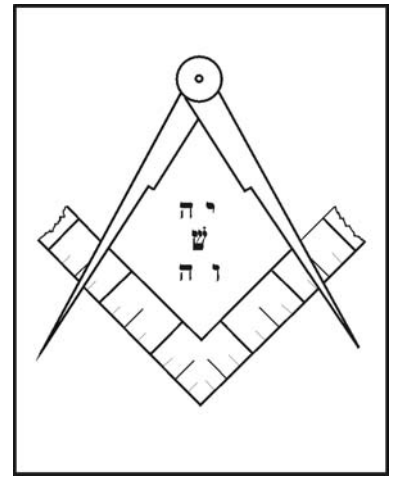

OR MANY YEARS it has been my desire to place before students a concise exposition of those occult principles which form the framework about which are woven the symbolism and ritual of Modern Freemasonry.

The antiquity of its venerable emblems is unquestionable, and it is now generally accepted by Freemasons and occult students alike, that they conceal mystic verities. These rites and pictorial representations that have seemed significant to an important nucleus in the social system of every ancient nation boasting even a degree of civilization, are so widely disseminated that their remnants may be found in remote Tartary and Tibet, among the almond-eyed children of the Flowery Kingdom and Japan, on the slopes of the snow-capped Himalayas, beside the turbid Ganges, amid the desert sands that cover the buried cities of Gobi, and by the revered Tigris and Euphrates. They are found also at the foot of Caucasian passes, by the shores of the Red Sea, in the fertile valley of the Nile, and amid the ruins of classic Greece and Rome, ancient Gaul and primitive Ireland and, crossing the restless expanse where the wide Atlantic rolls, we confront the same hoary emblems in Peru, in the Mississippi Valley, and in the Yucatan.

Certainly the most enlightened inhabitants of our globe, even in what we are egotistic enough to call the barbaric ages, did not spend so much time and energy elaborating and preserving a will-o'-the-wisp devoid of meaning and significance! This divine symbolic language, which has successfully weathered the cataclysms of nature, that has been preserved though all else contemporary crumbled into ruins and returned to the dust from whence it came; the very memory of whose originators is lost in the dim night of time; which of all the childhood possessions of the human race, alone has escaped the Lethean waters of oblivion; though subsequently it may have degenerated into empty soulless forms, hieroglyphics uninterpretable; it is preposterous to suppose had no substance in truth, no foundation in fact, no correspondence in the starlit realms of Urania.

The Ancient Secret Doctrine, now preserved in the symbolic forms of Masonry, gave to the old pagodas of China their peculiar shape. It commanded the erection of the eight-voled tower of Babel on Shinar's plain, prompted the laborious building of the pyramids in Egypt and Mexico, constituted the motive force that scattered huge lithic monuments over the fair face of Europe, and bade the construction of elaborate temples that yet remain but partly discovered amid the tangled vegetation of the American tropics. Consequently, whatever our opinion of the truth or falsity of its tenets, we cannot doubt that it conveyed ideas of moment to the minds of our remote forefathers.

Through the varied web of human history, woven from the odds and ends of half-forgotten traditions, runs an unbroken strand of gold. Nations have risen and fallen, empires have been welded and severed again, continents have been lifted and then submerged; yet through all time since man has made his home upon this mundane sphere, the golden thread of Masonic Symbolism has stretched unsevered through the warp and woof of racial destiny. There have been periods when the glittering strand has almost been lost to view amid the coarser fabric woven by statecraft and priestcraft; but ever it reappeared, scintillating in the foreground of evolutionary progress. Again and again has it strengthened the tone of human moral fiber in times of national decadence, again and again has it constituted the power behind the throne, a lifeline at critical periods to which a superior few could cling and struggle for racial advancement; working silently, secretly, yet effectively.

Modern savants may, or may not, according to the bias of their minds, place confidence in the verity of the esoteric teachings held by the most spiritual of our early progenitors, such as are elaborated and preserved in symbolic rites and hieroglyphics; but no student worthy of the name will fail to investigate ideas which, perhaps more than any others, have shaped the course of man's intellectual and spiritual development, and have ever constituted the mold of his noblest endeavors.

He who would become the possessor of true knowledge must never rest content with theories only, but must be able to prove or disprove them in nature's laboratory. And where a set of ideas has been held by a number of men, or such ideas have exerted an important influence in mundane affairs, if he proves them erroneous his task is but partly completed; for he has yet to ascertain why those opinions were held, why they seemed plausible to others, and in what proportions the false and the true are intermingled. It is most difficult for men to formulate a conception that has not some slight foundation of fact upon which to rest.

Masonic symbolism being the garment worn by a doctrine which has exerted so powerful an influence in human affairs, a mantle still preserved by Freemasons—an organization whose motive is lofty and whose practical endeavors are far-reaching and beneficent—it behooves all students of philosophy and religion to investigate these ancient forms and tenets, to trace them to their original source, and finally, to compare them with Mother Nature.

Yet not until we know the meaning attached to these symbols by the originators are we capable of testing their truth or falsity. And not until we have placed them under the microscope of the soul, and illuminated them by the sunlight of reason and the x-ray of intuition—making at the same time careful comparisons with Nature—are we warranted in passing judgment upon the truth or falsity of the Secret Doctrine they clothe.

A much repeated, and too oft unheeded admonition in Masonry is: “Study the Book of Nature brother, it bears the stamp of Deity.”

Such wise council is alone sufficient to mark the integrity of the august body in whose ritual it appears, making a wide distinction between its underlying principles and those of many another religious or social body. These others all too often curtail original investigation, and cramp and shackle their members by imposing a belief in some individual, or company of them, who poses as the special interpreter of the Will of Deity.

Yet in times past, as the history of his activities amply proves, the Masonic Brother has had to pay dearly for the privilege of being Free to build the edifice of his soul conformable to the dictates of his reason and the promptings of his conscience. His option of being a Freemason has sometimes been purchased with his life’s blood; for the oppressors of humanity have ever feared and hated those whom they could neither cajole nor bribe into servility, and who resisted all temptation knowingly to become enlisted in an unjust cause.

If Masonic Symbolism is of such paramount importance, the casual thinker will ask, why is it that others have not ere now drunk at the fountain of its enlightenment and offered the cup of its virtues to the whole parched world.

In a measure this has been done, but in a measure only. The labors of Albert Pike are of great value, and those of such worthies as Oliver and Mackey should not be slighted. But the investigator who would discover the conceptions originally underlying Masonry and make them public is confronted with peculiarly obstinate difficulties. Chief among these obstacles is the circumstance that only one having developed his psychic senses and thus able to read from the scroll preserved in the astral light can trace the origin of these prehistoric emblems. And having traced them to their source, their meaning will still remain opaque, or at best but translucent, unless by virtue of having passed his Initiation in the astral spaces, he is firmly grounded in the fundamental principles of the Mission of the Soul.

Once he has discovered their meaning, his difficulties are not yet ended; for the ignorance and prejudice of his race may make their exposition inadvisable. Some church may be in power with whose pet tenets his revelations of Nature’s mysteries may conflict, and thus precipitate upon his head the wrath of the clergy. Yet again, he may be hemmed in by obligations that prevent him from revealing what he has learned, or, as happened to one member of the Brotherhood of Light who was also a high degree Freemason—Brother Henry Melville, in the publication of his valuable masonic work, “Veritas,” he may be uncomprehended and misunderstood.

The writer of the present series of lessons has cultivated his soul faculties and speaks from the vantage ground of Initiation. Free from his body he has sent his soul through the wide spaces in search of the precious jewels of wisdom, seldom returning without some treasure; and he has studied the Tablets of Aeth, and read from the records of racial memory preserved in the astral light. In these Masonic lessons, however, he claims no originality. He is merely acting as amanuensis, writing down, and imperfectly, facts that are the common property of the venerable order of which he has the honor at present to be the president on this external panel. Not only so, but it is through the permission of the body, The Brotherhood of Light, that he is able to speak, and by them he is limited within what is considered the bounds of discretion.

This work will not be rejected, as was that of Melville, because the time now is ripe for it. Yet it must not be considered the last word upon the subject, as the time even now restricts and curtails what it is wise to place before the public.

In preparing these lessons, there has been some hesitancy as to the best method to employ to convey the basic truths incorporated in Masonry to the mind of the student, and at the same time not seem presumptuously to be treading upon ground held inviolable by the Masonic Fraternity. It is far from the purpose of the author to reveal any secrets of the Brethren to the outside world, or to attempt any so-called exposé of the methods used in their lodgerooms. Whatever the faults of individual members may be, I have a genuine respect for the Order, and brand as travesties the accusations of their enemies; for if true to their principles, there can be no more exalted souls upon this planet than are to be found among Freemasons.

Let it be understood, therefore, that I am not trying to teach Modern Freemasonry. I am teaching Ancient Masonry, upon which all the rites and usages of Modern Freemasonry rest. My object in no wise includes revealing such matters as Modern Freemasons desire should remain secret. Instead, it is to expound the occult principles and spiritual ideas originally associated with Masonic symbols, usages, and gestures, in such a manner that the public will understand these all-important doctrines; and to enable the Modern Freemason instantly to perceive the esoteric and spiritual significance, not only of his symbols, but of everything he does in the lodgeroom.

With this in view, I have selected a little book that is not so recent in its usages as to enable an unworthy person to gain entrance to a modern working Masonic Lodge and successfully pass himself off as a high-degree Mason; yet which is nonetheless Masonic in character. It is to be found in public libraries and upon the shelves of important book stores. It is entitled *Richardson's Masonic Monitor*, and was used for guidance by members of the Fraternity a generation or two ago, containing as it does a detailed description of the rites of initiation into the different degrees of the Fraternity, and picturing some of the ancient emblems of the Lodge.

As this work is easily accessible to the reading public, I deem it will be considered no breach of propriety to cite as a textbook to those who would sufficiently familiarize themselves with Masonic ritual, and I have taken the liberty to use it as a background for these lessons. This will serve a double purpose: First, it will enable us consistently to follow the symbolism of Modern Freemasonry and draw our comparisons between it and Ancient Masonry in a manner intelligible to students; the Masonic Brethren in particular. Secondly, it will enable me to check my work and keep it within the bounds and reasonable limits of what I consider wise to make public, and what I feel confident the Masonic Brethren will have no reason for desiring me to keep secret.

As I have said, my object is to teach Ancient Masonry, not Modern Freemasonry. And I trust in no case to trespass upon the private property of the Modern Fraternity. If, unwittingly, I do overstep the bounds, I plead as my excuse the desire to give those capable of appreciating and using them, truths of utmost importance to humanity, potent for good, vital to human uplift. And I implicitly rely upon the broad mantle of charity, which the Masonic Brethren are more ready to extend than others, to cover any transgression.

The First Masons

—The first problem that naturally confronts us in our present quest is: Who were the original Masons?

Here etymology comes to the rescue. The old Sumerians who lived in the valley of the Euphrates, and who were succeeded by the Semites, the fusion between the two producing the famed Chaldeans, used the word “imga” meaning wise, holy, and learned, to denote their wisest sages, priests and philosophers. The Semites, who succeeded the older race, transformed the word “imga” into “mag” to suit their articulation. From this root-word, “mag” belonging to the Assyrian branch of the great Semitic race, has come to us through various transformations the words: Mason, Magic, and Imagination. Therefore, in whatever era of the dim prehistoric past the first Masons lived, it follows from the very meaning of the word that they were the wisest, holiest, most revered of men.

A mason now is considered to be a builder—one who constructs. Likewise were those Wise Men of the East; but in their work the sound of neither hammer nor saw was heard; for they were mental builders. Their labor was construction wrought by the imagery of thought, as the word imagination, coming from the same root as does the word mason, clearly implies. Magic is the skillful use of the imaginative faculty, and the original Masons undoubtedly were magicians. The Magi of Egypt, Chaldea, and even more ancient times unquestionably were Masons.

The Masonic Temple

—Having determined that the original Masons were the Magi, and that they were mental builders, let us inquire into the nature of the edifice upon which these wisest of all men bestowed so much constructive effort. Tradition informs us that the Masonic Brethren labored in the erection of Solomon's Temple. Sol is the Latin name of the Sun-God, Phoebus. Om is the Hindu name of Deity. On is the Sun-God of Heliopolis, Egypt. And while combining these words from different languages undoubtedly is far-fetched, yet nevertheless, as will be shown in detail later, Sol-Om-On certainly represents the Grand Master of the Universe, whose most fitting symbol is the majestic and all-commanding Sun, from Whom comes all Life, Love, Energy, and Power. The Masonic Temple thus is the mansion of the Sun; the universe itself; a spangled canopy of blue, so situated and so arranged as to prove the most suitable lodgeroom for the initiation of the candidate: the Human Soul.

But how? We are led to inquire, could anybody of men, howsoever wise, work to build the jeweled mansion of the Sun, seeing that the very stars shining at their birth sang before the dawn of life upon the earth, and will join in the funeral requiem when the world is cold and gray, wrapped in the icy mantle of death? Certainly no earthly hands ever placed those blazing diamonds in the sky.

In what manner, then, could the early Masons have assisted in the construction of the Temple? Now remembering that Mason and Imagination are derived from the same root-word, a little light begins to dawn upon our perplexity. The early Mason was not a worker in stone, but a mental builder, in whose work Imagination played the most important part.

With the first glimmer of intelligence, man's mind, elevating itself above those of lower forms of life, must have been attracted to celestial phenomena. He watched the blazing orb of day peep over the eastern rim of the world, then soaring upward traverse the azure arch, and later sink, declining into the darkening west. He learned that night followed day, and that day followed night; necessity teaching him to start his labors with the rising Sun, and to seek shelter at the approach of night. Thus became he an observer of time.

Still wider experience brought the conviction that there was an orderly succession of the seasons. The rains of winter were followed by the droughts of summer. Cold followed heat, and heat followed cold. To the huntsman these were periods when game was scarce or plentiful, and he must learn to obtain enough food in the times of abundance to nourish him during those of famine. And how eagerly he looked forward to the return of the more fruitful days, and thus he became an observer of seasons.

As a herdsman, our early forefather watched the shortening and the lengthening of the days; and when the Sun in its annual pilgrimage entered a certain cluster of stars, he knew from experience that the green grass soon would be starting on the mountain side, and he drove his flocks from the valley to those more luxurious pastures. So, also, the farmer learned to till the ground and sow his grain when certain stars rose with the morning sun. The time of harvest was at hand when certain other groups were seen, and winter's bleak scarcity was heralded by the wending southward of the orb of day. Thus, early man became the astronomer, his sustenance depending in great measure upon his ability to interpret, upon climate and the denizens of the earth, the effects of celestial phenomena.

Having seen what powerful influences were exerted by the heavenly bodies upon all things external to himself, it was only natural that those studiously inclined should wish to ascertain their influence upon man himself. As a general rule, it was found that people born in the spring, just after the days and nights became of equal length, were more energetic and had more initiative than people born at some other times of the year. People born with the same group of stars rising upon the horizon were observed to possess characteristics in common. Likewise, the portion of the heavens occupied by the Moon was found to influence the brain capacity. From these observations, covering immense periods of time, whose aim was to ascertain the relation existing between man and the stars, arose the sublime science of Astrology. Astronomy was studied, and observations were carefully and systematically recorded, only as factors in determining the effects of celestial influence upon man. And as a factor necessary in the study of astronomy, there was developed the science of Mathematics.

Astrology Also is a Sacred Science

—Astrology was not studied merely as a means whereby man might profit materially, but as a Sacred Science. The material universe, even as man's physical body is his material expression, was considered to be the manifestation of an All-Wise Intelligence. Man manifests his will through acts; so were the heavenly motions thought to be manifestations of the Will of Deity.

As year rolled into year, and century into century, a class of men developed who were peculiarly fitted by natural endowments to pursue the study of the starry heavens and formulate the result of their observations of celestial and mundane phenomena into a scientific system. These were the Magi, the original Masons. Just as at the same time a distinct military class separated itself from the mass of the people by virtue of their superior physical prowess, their love of power, their aggressiveness and disregard of all save might, and became the temporal rulers of the people—the Kings and their immediate associates—so, by virtue of their superior mental and spiritual endowments, the Masons, as a class, separated from the populace and became the sages, philosophers, scientists, the spiritual advisers and priests; dictators in matters religious.

And as persistent culture developed mighty warriors, so the rigid discipline from childhood to which the priests were subjected developed mental and spiritual giants whose keen minds and lucid soul faculties penetrated the innermost recesses of nature. These Masons early perceived a sympathetic relation existing between the organism of man and the fiery points in the firmament above, a definite correspondence between certain sections of Solomon's Temple and the human body. They found that there are certain principles pervading nature that express themselves in the influence of the stars, on the earth, in the sea, in the air, and in the body of man.

Slowly, by degrees, and with infinite patience, these correspondences were sought out between the things representing a given principle on the earth and that portion of the celestial sphere having the same influence. As these correspondences were ascertained it became the duty of the Mason to inscribe them in the sky, that their meaning might not be lost to future generations.

In this work of building the Temple of the Sun, his imagination played an important part. With it he wove fanciful pictures among the stars; for often the actual outlines of the constellations bears no resemblance to the animals or objects they are designed to represent. They do, however, invariably signify an influence in mundane affairs well denoted by the things so pictured. To be more precise, the signs of the zodiac and the decanates of the zodiac, of the same names as the constellations have such influences; for the constellations but picture the various reactions of sections of the zodiac. Thus, gem by gem, that which was found imbedded in the soul of man had its corresponding jewel added to the dome above; the whole being formulated by the early Masons into the famed Science of the Soul and the Stars.

How King Solomon's Temple Was Built.

—Astrology was studied not merely for its material profit, but also as a religion. The early Mason cast about for an explanation of the visible universe. In his experience he had found no higher type of active agent than the mind. It was the one thing in his experience that could voluntarily create. The mind of man could build a house in imagination, then cause its construction of wood and stone. Yet what was finite mind? It was an invisible, intangible cause about which he could only think in abstract terms; an unknowable director of human actions.

Having found each visible portion of man, each organ and each physical function, to have a correspondence in the sky, what was more natural than to conclude that there must also be a correspondence to his invisible estate! And as finite mind is the most potent of all agents to create below, it logically follows that Infinite Mind is the most potent creative agent in the whole universe. Carrying this line of reasoning a step further, he was forced to conclude that as man is composed of an invisible mind and a visible body, so God likewise has an invisible and a visible domain; the invisible portion being Infinite Mind and the visible portion being the Material Universe, infinite both in extent and in complexity.

Being convinced that the universe, including man, is the result of creative design, it became the endeavor of the Magi to fathom its purport, or at least so much of it as relates to man, that he might conform his life and efforts harmoniously to that purpose. Man's actions are symbolic of his will and purpose. Thus was it legitimate to conclude that God's Will is revealed in the movements of nature to those who have sufficient penetration to grasp the meaning of their symbology.

Therefore, the early Masons sought out the correspondences in nature, and built their pictured symbols into the sky, as the Temple of Solomon, Grand Architect of the Universe. And this grand edifice, erected by the Ancient Masons; is of most perfect design, revealing as it does to the discerning, the Will of Deity; for what wiser thing could man do than to imitate the building of this ancient structure, and build for his own indwelling soul a mansion as perfect in its proportions, and as harmonious in its arrangements, as the Temple of King Solomon!

In time the Mason, as a priest, became only an interpreter of the ideas symbolically built into the Temple by his wiser forefathers. The word "religion" is derived from the Latin "re" (back), and "ligare" (to bind), and means literally, to bind back. This, then, became the work of later Masons: to collect truths discovered in times past and bind them together in such a manner that they might be preserved for future generations. These truths, in their symbolic form, are found woven more or less into all important religion the world has ever known. The earliest religions were purely astronomical, and it is safe to say that every important religion that ever has been entertained by the mind of man has had an astrological foundation.

Man's body is not the real man, nor is the material universe God. The real man is the invisible controlling ego, and God is the invisible and unknowable Infinite Mind that directs and controls the mighty Cosmos. The Ancient Masons ever sought to find a fitting symbol to represent each principle and function of nature, and to build it into the Temple. What more fitting symbol could be found to represent the Infinite Ego, the true King, than the glorious orb of day!

Sol, therefore, was elected as the symbol of the controlling power of the universe—Deity—it being recognized by those of inner vision that the physical orb was but the external covering for the grander and more ethereal Spiritual Sun Who stands exactly in the same relation to the Solar System as does the human ego to its body. Thus originated Solar Worship, one of the most ancient forms of religion.

To the mind of the Ancient Mason, the physical Sun, the center of our system, from which the earth receives the requisite grade of force necessary for every terrestrial manifestation of power, organic and inorganic, vital and physical; was but the emblem of the Spiritual Sun which exerts that degree of celestial energy, which in matter becomes occult force, and in man becomes Will and Mental Power.

Why Two Pillars Were Erected

—The studious mind cannot fail to perceive all nature to be divided into attributes: the one positive, the other negative; the one active, the other receptive. Polarity, or Sex, is the One Great Law of the Universe. This One Law manifests as centrifugal and centripetal forces, as repulsion and attraction as spirit and matter. Life in all its infinitely varied forms is but the interaction between positive and negative forces, there being no life apart from sex. Where sex manifests in greatest perfection, there life most abounds. The fire seen when the flint strikes steel is sexual energy; so is the heat of vegetable life. Passion is the prime mover of the animal kingdom. Man destitute of virility soon succumbs. Man's and woman's possibilities, according to the teachings of the Ancient Masons, when harmoniously united are only limited by their sexual powers, and the ability to control and wisely direct them.

The Ancient Masons, realizing that life depends upon these two attributes, wisely erected two columns in the porch of the Temple; one on either side of the great Eastern Gateway. The pillar on the right is called in Hebrew; Jachin; meaning, "He that Strengthens." And it is the Royal Sun returning from the right, or southern, declination, and rising through the eastern horizon that brings renewed strength after the winter season.

The pillar on the left is called, Boaz; meaning, "Source of Strength." It represents the passive and inert north. It is the left side of the Gateway of the rising Sun, which attracts the Sun northward. Truly, the feminine in nature by its attractive power is the Source of Strength, Boaz; and the ever-active masculine, Jachin, seeking that source of strength becomes the Strengthened.

Tracing backward the history of man's religious beliefs, we find interwoven with solar worship, sex worship, which in its original conception was pure, being the recognition of the mighty power of sex as the most sacred attribute of Deity—Creative Ability.

Serpent worship, another important ancient religion arose from sex worship and solar worship, the serpent being considered sacred to the Sun, and revered on account of its reproductive significance. Solar religion, Sex worship, and Serpent worship, thus had their foundations directly in Astrology.

The builders of Solomon's Temple, ever seeking to embody their discoveries of natural principles in most appropriate symbology, turned to the sky for some object whose quality was pronouncedly virile, creative, fecundative, and masculine. The Sun thus became the symbol of masculine creative energy, the Father of the Universe. And the Moon, typifying the feminine, fructifying principle, became the nourishing Mother. Further, it will be found today, even as then, in starry science, that the Sun is the source of all power, and the Moon is the Mother of its manifestation.

The Masculine Symbol

—Turning to the earth, it was found that the Sun exerts its greatest power when its rays fall vertically. Thus, in choosing some common implement of labor by which to express this masculine creative energy implied by the vertical Sun, the Plumb was selected as the embodiment of that idea. Therefore is the Masonic Plumb the symbol of the masculine principle in nature; the vertical line being used as an abbreviation of the same symbol.

The Feminine Symbol

—The plumb and vertical line having been chosen to represent the positive element, it was natural that the level and horizontal line should be chosen as the most suitable emblems of the passive, negative, inert principle.

The Symbol of Union

—The earth being considered as the womb of nature; the point where the masculine, electric rays of the Sun are embraced by the feminine, magnetic, rays of the Moon; it was represented by the union of the vertical line and the horizontal line; by a cross.

Astrological Significance of the Square

—The angle at which the rays of the Sun, Moon and Planets meet were found to have an influence upon life and mundane affairs. Thus in astrological calculations it is necessary to measure and record these angles. And it is found that two different sets of measurements must be taken.

The first set is measured entirely in the plane of the Ecliptic, regardless of the latitude of the orbs. In this manner, the Celestial Longitudes of the heavenly bodies are found. With the exception of “Parallel of Declination,” those most potent influences upon mundane life for good and evil called in astrological terminology “Aspects,” are due to the angles formed by the difference in longitude between the orbs. So, as these angles are measured entirely within one plane, the Ancient Masons, seeking to indicate this measurement, selected Euclid’s Square.

The square, being an instrument suited to the measurement of plane surfaces, embodies the idea of a vertical line, or positive force, meeting a horizontal line, or negative force at an angle which is measured in a single plane. And in practical astrology this is the first step, for the zodiacal positions of the Sun, Moon and planets are found, and their aspects calculated, as if they all moved in the plane of the Ecliptic. Strange as it may seem to the uninitiated, with but one exception, it is these aspects, disregarding latitude, that are found potent in the affairs of life.

Astrological Significance of the Compass

—But as a matter of fact, the Sun, Moon and planets do not move in the same plane, but describe orbits that are inclined to one another. To trace such curved orbits and measure their inclination to each other, another implement is required—the Compass. Owing to the fact that the planes of their orbits are at an inclination to each other, the Sun, Moon and planets at different points in their journeys form different angles to the Celestial Equator. This angle at any given time is called the planet’s Declination. Orbs having the same Declination either north or south of the Celestial Equator form an aspect called “Parallel of Declination,” and are found to Intensify the influence of each other, and thus exert a very powerful influence in the affairs of life.

The Compass, being an instrument used to draw circles, embodies the idea of a male force meeting a female force at an angle, this angle being measured in different planes. The right hand of man is the executive, so the right leg of the compass was taken to signify the positive force. The left hand of man is receptive, so the left leg of the compass was taken to represent a negative force. Thus when the compass is seen with the right leg superimposed at their juncture, it indicates masculine supremacy; while when the left leg is uppermost, the feminine principle is shown to be dominant.

Each year, the Sun apparently performs a pilgrimage through the 360 degrees of the zodiac, and in longer or shorter periods the Moon and planets make a similar journey. At the same time, owing to the obliquity of the Ecliptic when considering the Sun, and to the angle of inclination of their orbits when considering the planets—the various inclinations of their orbits to one another that I have just mentioned, and

particularly their inclination to the plane of the earth's equator—the vertical rays of these orbs form a spiral path upon the surface of the earth. Thus as the earth turns upon its axis each day, one day following another, the Sun apparently moves north in summer and south in winter, its vertical rays falling each day a little north or a little south of their former path. This is the cause of the Seasons.

Where the Ritual Places Emphasis

—Early in this lesson I traced the word Mason back to the early inhabitants of the valley of the Tigris and Euphrates, yet the world wide dissemination of the doctrines taught by Ancient Masonry makes it certain that these teachings had their origin in times still more remote. Expressed in forms which convince they were but modifications of an identical original, they were fully developed at the very beginning of the seven ancient centers of civilization—Egypt, India, Crete, Peru, Mexico, China and, as I have indicated, Chaldea.

We may be sure, therefore, that these ideas had their origin in a single region of dispersal. And as there is ample scientific evidence now that both Atlantis and Mu—the former in the Atlantic and the latter in the Pacific—once had an existence, there is little reason to doubt that these ancient continents each was inhabited, as legend holds, by several races, one of which had reached a high degree of scientific knowledge and spiritual attainment. Thus from a still more ancient region which became submerged beneath the waves, was the Secret Doctrine embodied in Ancient Masonry carried by the colonists from that land before it sank, to other shores. And when the old continent of Atlantis, which perhaps in turn had derived much of its insight from the Pacific land of Mu, finally sank, its spiritual ideas already were thriftily growing in each of the mentioned seven centers of civilization where colonists had planted them.

The four chief tenets of these spiritual doctrines were embodied in huge monuments of stone that yet, because succeeding peoples have been powerless to destroy them, are to be found in numbers in many important areas of the globe. More details of the spiritual wisdom were set forth in those symbolical pictographs which we call the constellations, traced by the Ancient Masons in the sky. Still further explanations, also in the language of symbolical pictograph, were traced upon plates, and come down to us through Egypt in the Egyptian tarot cards. Many of the doctrines also found their way as allegorical stories in the various sacred books of the world; and many also, as this series of lessons will make certain, were preserved in the ritual and symbolism of later Masonry.

The explanations traced by the Ancient Masons on the tarot cards and in the constellations among the stars set forth at great length how the signs and planets influence human life and destiny. They give practical instructions in a wide variety of matters, and place emphasis on things different than those given most attention in Masonry.

The Ancient Masonic ritual and its symbols, while acknowledging that the planets in their courses have an influence on human life, and that knowledge is an essential to human progress—two of the chief doctrines preserved in the monuments of stone—more strongly emphasize the other two of the outstanding doctrines preserved in the huge lithic monuments they left. Throughout, the attention is called to assurances that life persists after the dissolution of the physical, and instructions are given in much detail relative to building a spiritual form for happy and successful survival, not merely on the astral plane, but in realms still higher which are truly spiritual.

And throughout there is persistent emphasis on love and the domestic relation as instruments through which the highest, noblest and most spiritual qualities possible to mankind can be developed; qualities which build the spiritual body and insure harmonious and self-conscious immortality.

Astrological Significance of United Square and Compass

—Now the word Spiral and the word Spirit are both derived from the Latin word “spira,” meaning, to breathe. The spiral, indeed, is the breath of life. From this spiral motion of the orbs, which, as I previously indicated, causes the succession of the seasons and the various results which follow, comes forth all terrestrial life manifestations. The spiral return of the Sun in spring banishes the ice and snow of winter and germinates the dormant seeds of vegetation. Later it warms them with its genial rays into luxuriant foliage, grains and fruits, and these in turn become the support of higher forms of life.

In Ancient Masonry this union of zodiacal motion and declination was symbolized by the union of the compass and the square. And to indicate the germination of physical life generated by this motion an additional symbol was placed in the center between them. A serpent in the form of the letter S was originally used; typifying the generative act. Later, the third Hebrew letter, Gimel, was used with the same significance. This letter is the hieroglyph for the zodiacal sign Libra. Its symbolical meaning is exemplified in the third Arcanum of the Egyptian Tarot. This picture represents a pregnant woman. The Sun is surrounding her head, the Moon is at her feet, and there are twelve stars that represent the twelve zodiacal signs that rule over the processes of gestation. By its form, the symbol of the sign Libra also suggests union resulting in pregnancy. At the present time, the English equivalent of the Hebrew, Gimel, the letter G, is placed in the center of the joined compass and square.

Remembering that the Ancient Masons, building the Temple of Solomon, erected it as a model for the building of the human tenement, and that each truth represented above has its corresponding truth relating to man and his possibilities, we now search for the terrestrial meaning of the joined compass and square.

The square placed below is typical of the purely physical union of the sexes. In astrology, the inharmonious aspects each constitute a portion of the square, or angle of 90 degrees—Semi-Square, Square, Sesqui-Square, and Double Square, or Opposition—and the right angle has been used from time immemorial as the symbol of discord and strife. It becomes a fitting emblem, therefore, of man and woman when united from purely selfish and carnal motives; and it thus represents the result of the ignorance so prevalent in the present-day matrimonial system.

The compass placed above is typical of that higher union of souls in which reciprocal love is the chief factor, and in which thought of gain forms no part. The angle formed by the male and female portions of the compass is less than a right angle, and should approximate 60 degrees, the astrological sextile. The benefic astrological aspects each constitute a portion of the sextile—Semi-Sextile, Sextile, and Double Sextile or Trine. The sextile is used to denote harmony and joy. It is a fitting symbol of the union of those rare individuals “whom God hath joined together.”

The Letter G, typifies the Generation of offspring as the result of physical union. But in order that these progeny shall be endowed with soundness of body and mind, and thus become a blessing to their parents and the human race, the Ancient Masons taught that there must be a higher union in addition to the physical, as indicated by the compass above; and the Spiritual as well as Physical Laws must be obeyed.

The union of the compass and the square form a diamond, the hardest and most precious of stones. With the G in the center, it is the diamond in the rough. When ground and polished it becomes the priceless jewel of the soul. Only by removing the G does it become a diamond without blemish. The God within then becomes manifest, a condition symbolically represented by the Hebrew letters Jod-He-Vau-He within the compass and square.

“Search then,” said the Ancient Masons, “to remove the G, that the diamond may be clear and reflect the light of the Divine Sun in the full glory of the Holy Shekinah.” This perfect condition is fittingly symbolized in Ancient Masonry by the Hebrew letter Shin in the compass and square and between the positive and the negative halves of the Divine Word. Shin, corresponding to the Twenty-first Egyptian Tarot, indicates the completion of the Great Work, the full realization of the Holy Shekinah on all three planes of being.

“Yet remember,” said the Ancient Masons, “that before the polished jewel there must be the stone in the rough, nor reject it because of the G. Accept it as it is found, but seek ye to learn the laws of workmanship governing its transformation from an unsightly pebble into a shining gem.”

Chapter 2

Serial No. 7
Original Copyright 1938
Elbert Benjamine

Copyright
Church of Light
August 2002

Entered Apprentice and the Planets

Chapter 2

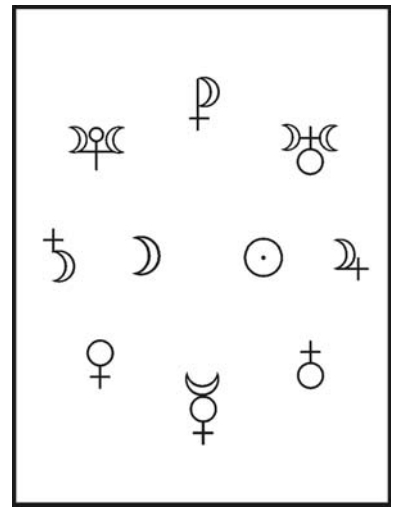

Entered Apprentice and the Planets



HE ANCIENT MASONS, ever striving to solve the mysteries of God and man, seeking to peer beneath the veil of the Virgin Isis, working to wrest from nature the secrets of life and immortality; labored long and diligently in the construction of the royal temple of the sun. The blazing gems of heaven were made the subjects of wearisome observation and study. And as their toil and research was gradually rewarded by establishing definite correspondences between the orbs above and objects below, link after link was added to that majestic chain which binds to men on the one hand terrestrial life entire, and on the other serves to unite with his soul the radiant stars.

Unlike the brilliants of apparently immovable station, it was found that a few of the heavenly bodies rapidly change their relative positions. At a much later date they were named planets, meaning wanderers. These wandering orbs, with the exception of the newly discovered Pluto, all keep within the boundary of a path some 18 degrees in width that encircles the celestial sphere. Furthermore, each has an influence and an individuality of its own. Yet this influence, observation disclosed, is greatly modified by the particular section of the starry highway in which the nomad chances to be found.

Keep penetrative minds, as time moved on, discovered that the pathway of the moving orbs has twelve natural divisions, each division coloring in its own peculiar way, the power of the planet within its bounds. The attributes and qualities of each of these twelve divisions, the Ancient Masons carefully noted, and then set to work to find among terrestrial things such objects as embody the same principles and properties. When these were found, it became the Mason's task to inlay with gems of light, each in its appointed space, the designs of these objects in the firmament above. Thus it is that while the groups of stars in the constellations often bear no resemblance whatever to the animals and other objects pictured among them, yet so enduring was the imaginative construction of a bygone time, that today there is presented to our eyes the same accurate symbolic picture of celestial influences, which whisper in our ears the same divine messages, having the same purport, as in the day when flourished at its zenith, the famed Chaldean lore.

In this manner, the belt through which the planets perform their luminous pilgrimage became the abode of starry-formed denizens, mostly animals. And although, due to the slow precession of the equinoxes, the unequally spaced constellations no longer cover, each in its appointed order, the regularly spaced zodiacal signs, yet as monumental proof of how well the Masons builded, today each pictured celestial object stands in relation to the section of the zodiac it was then used to represent as a perfect symbol of its influence. These twelve zodiacal signs are twelve letters in the divine alphabet. They are the consonants used in the language of the stars.

The vowels, ten in number, are the planets. This may seem strange to those conversant with modern opinion that the ancients, having no optical instruments, could have known only those planets visible to the unaided eye. It must seem they could not have known of Uranus, Neptune and Pluto. Yet at least the attributes of these three wayward planets are presented in their mythology in clear cut and unmistakable terms. The modern astrologer, after painstaking study of Neptune, Uranus and Pluto, writes down their attributes; and these attributes, experimentally demonstrated, are in detail just such as are ascribed to the mythological characters Uranus, Neptune and Pluto. This, I am sure, is more than mere coincidence.

New Planets Usher in New Periods in World Affairs

—Perhaps, also, beyond the orbit of Pluto,—which marks the present day frontier, lie other yet to be discovered orbs. When they are discovered, provided they exist, our observation of the affairs of the world coincident with the finding of Uranus, Neptune and Pluto, suggests that each will usher in a new era in the progress of the world.

Uranus, the planet of invention and of independence, was discovered in 1781, and may rightly be said to have ushered in the machine Period, and the Period of republics. It was then that the looms of England rapidly transformed her from an agricultural into an industrial nation. Engines of all kinds came into use, one invention following another. Still later electricity added its power to this Period of manufacture.

In 1782, the Peace of Versailles and Paris granted independent existence to the United States. This set a precedent to be followed by most of the countries of the New World. The Republican form of government came to be a dominant factor in all the Western Hemisphere.

Neptune was discovered in 1846, ushering in the Period of oil and gas; which prepared the way for our present industrial system and our present means of locomotion. Also it brought into the world a new religious conception; that of modern spiritualism. Before the Fox Sisters and their rappings, in 1848, similar phenomena were recognized, but they were called witchcraft and deemed the work of the devil. Modern spiritualism had its birth in 1848, and gave to the world scientific proof that the soul survives the dissolution of the body.

Also in 1848, there were revolutions in France, Germany, Italy and Austria-Hungary. And gold was discovered in California, which opened up a quite new section of the world.

The Period of oil also ushered in a new method of financing business, the method by which many individuals could pool their resources. Instead of individual enterprise, and partnerships, with their limited ability to raise capital, Corporations, composed of share holders, came to be the dominant factor in the business and industrial world.

And then on March 13, 1930, only a few months after the collapse of the stock market in 1929 and the commencement of the greatest financial depression the world has ever known, the discovery of the planet Pluto was officially announced. This then started the Pluto Period.

Kidnapping came to be the most lucrative crime, and large scale racketeering, bred of prohibition days, reached its zenith. The New Deal thrust itself into politics, the sit-down strike pervaded industry, and the whole world became divided into two camps, one dominated by militant and predatory dictators and the other a defensive cooperation of democracies.

As to the influence of the discoveries of these planets on astrological practice; it is true that after the Period ruled by a planet began, environmental conditions made its influence in the lives of individuals far more important than previously. Yet the work of the Church of Light Research Department on the charts of those who lived before the Periods of each of the upper-octave planets began, shows conclusively that, despite astrological ignorance of their existence, these planets were then profoundly affecting people's lives through such conditions as already were at hand.

Astrologers are not omniscient, no more so than are chemists. At the turn of this century chemistry had only atoms and molecules. Then it found within the atom the electron and the proton, and became satisfied it had all the building blocks. But this family of two had expanded by 1938 to embrace no less than six fundamental particles within the atom. Yet the world would have been vastly poorer had it been without chemists in 1900.

Astrology, like chemistry, is a progressive science; and it is as foolish for astrologers now to claim they know all about astrology, as it would be for chemists to insist there is no more to learn about chemistry. Nevertheless, both even in their present state are practical and highly useful sciences.

Ten Constitutes a Chain of Planets

—However many planets there may be, the Ancient Masons held that ten completes one chain, and that of these ten only seven are completely active at one time, the other three to the extent seven are energetic, being latent. As one of these active potencies grows dormant, its octave expression takes up the work and becomes more active. Thus when the influence of Uranus becomes more pronounced in human life, its octave expression, Mercury—for both Mercury and Uranus express through intellectual powers—waned in influence. As man becomes capable of receiving the subtle infiltrations of ideal love from utopian Neptune, he cares that much less for the Venus kind. And as he expands his domestic interests to a protective care for all the members of society under the influence of Pluto, he cares not less for his own home and children, but this Moon influence loses its restrictions and is held in abeyance sufficiently to permit its upper-octave to express.

An alphabet of twelve consonants and ten vowels, however, was not sufficient for the purposes of the sages. Their researches pointed to the fact that the power and trend of any celestial group or orb upon human life depends upon its position relative to other groups or orbs at that time. To express such relations, and to calculate such positions, past, present, and future, the science of mathematics was developed. This made necessary the use of numbers.

Whether these numerals be represented, as in the Chaldean, Hebrew, and Coptic, by giving each letter of the alphabet a numerical value, or by using separate characters as did the Romans and at a still later date the Arabians, the effect is to add to those expressed alone by letters another distinct set of ideas. The twenty-two letters of the ancient alphabet added to the ten characters expressing number gives the complete set of thirty-two primitive ideas—thirty-two kinds of material with which they worked—used by the Ancient Masons.

Origin of Symbols for Planets, Signs and Numerals

—After having carefully ascertained the nature and qualities of each of the twenty-two heavenly potencies, having also ascertained its terrestrial correspondence, and having quarried the latter and transported it to become a panel in the vault of Solomon's Temple, there to look down with immortal vision upon countless generations of humanity, the next step was to condense, or abbreviate, the image pictured above, that it could with convenience and celerity be used in writing. In this later work the emblems were not chosen arbitrarily, but with great care that the brief notation should express clearly by its symbolic import both the individuality and the influence of the heavenly orb or zodiacal sign.

Quite naturally, the disc was chosen to represent the sun. Not less easily mistaken, the crescent was selected to signify the moon. And the earth, where solar forces and lunar rays meet and cross, was designated by a cross. Nothing easily mistaken here, even a thousand generations hence! The attributes symbolized by the sun, moon, and earth, are present also, in diverse combinations, in the other planets. So to indicate the latter, the disc, the crescent, and the cross, are combined in manners appropriate to indicate the attributes of each. Such an arrangement could not be misunderstood in its import by anyone in any age who should be familiar with planetary influence.

In designating the signs of the zodiac, the same method was employed. That is, as the disc so well pictures the sun, and a crescent, the moon; each zodiacal sign has a definite picture among the constellations, and it was sought to so abridge this picture that it could quickly and easily be written, and at the same time suggest the picture of which it is the abbreviation.

The numerals were also developed after a somewhat similar manner, but as there are different systems in existence the exact method must be traced in the language of the people employing them. Thus the Roman numerals were evolved from simple marks, or tallies, of the same number as the objects to be counted. Later on X, representing two paths crossing at a harmonious angle, and so signifying man and woman joined in marriage, was taken to signify ten. Man and woman together, like the number ten, it was considered, closed and completed the cycle. The number of mankind as a whole has always been considered in sacred science to be ten. The V of Roman notation was obtained by dividing the X into two equal portions, symbolizing man or woman alone. Man from time immemorial has been designated by the number five.

The Arabic numerals, developed at a much later date, at a time when Arabia was the scientific center of the world, are more abstract in character, and include certain advanced scientific observations relating to cell division which were used rather arbitrarily, which can yet be traced. This will be discussed more in detail in Chapter 4.

The symbols that commonly are employed to designate the planets, the zodiacal signs, and the numerals, are each replete with meanings known only to the initiated. These meanings relate to mundane life and endeavor. But the Ancient Masons did not rest here; they were not content to confine their researches to this world. They also extended their investigations to the spirit zones, to the homes of the dead, and to the activities of the discarnate as well as the incarnate human soul. As a result they found that astrological principles have a meaning in other than earthly realms and that they have a relation both here and hereafter to the development of the powers of the soul. Thus the zodiacal signs, planets, and numerals came to have an esoteric, as well as a common, significance; and this esoteric meaning, instead of being available to all, was conveyed only to those deemed worthy, by means of carefully selected symbols.

Origin of the Thirty-Three Degrees of Masonry

—In fact, the policy of the Ancient Masons was to mark every discovery of importance relative to the development of human character and the attainment of immortality with an appropriate symbol. Thus if the symbol should be perpetuated the discovery would not be lost, even though generations unable to read it passed; for to nature's initiates a symbol is both a diagram and a description of the fact it was selected to represent. Though a universal symbol, such as the Ancient Masons employed, should be lost to sight for a thousand years, the first keen student of Nature's laws to stumble upon it would be able to comprehend its meaning as well as those who used it first. The study of Ancient Masonry, then, becomes a study of such universal symbols.

In addition, therefore, to the common symbols employed for signs, planets, and numbers, the esoteric interpretation of each was engraved on a separate tablet. In Egypt these thirty-two tablets were called, from "Tar," meaning Path, and "Ro," meaning Royal, the Tarot, or Royal Path of Life. Each of these tablets relates to a distinct potency of the human soul, and to one of the essential steps that the neophyte must take to reach the climax of human possibilities and become the exalted adept, heir elect of the angels, who may realize while yet in the flesh his Self-Conscious Immortality.

To denote that all thirty-two steps had been ascended, that all human victories had been won, it was common to add a thirty-third symbol, the seal of the adept, Master of Destinies. The oldest philosophical treatise to be found in the Hebrew language, the Sephir Yetzirah, or Book of Formation, contains thirty-three paragraphs, each descriptive after the code system of the kabala of one of the thirty-three tablets of the tarot. And as a commentary to it, also in kabalistical code, is another ancient Hebrew treatise, the Thirty-Two Paths of Wisdom, containing thirty-two paragraphs which are each an exposition of one of the steps to be taken on the Royal Path of Life.

Then again, although expanded at a later date, the alphabets of the then western nations, Chaldea, Arabia, and Greece, were originally composed of twenty-two characters. Likewise the Hebrew, and the Coptic of Egypt, derived from Chaldean sources, were alphabets having twenty-two characters. And it is believed that these early alphabets of twenty-two letters were derived from the tablets symbolizing the esoteric significance of the heavenly influences, each being a conventionalized abbreviation of the significance of one of the twelve zodiacal signs or one of the ten planets.

I believe enough now has been said to show that there is no chance in the circumstance that there are thirty-three degrees in Ancient Masonry. Each of the first thirty-two degrees is founded upon one of the thirty-two most important principles in nature, the thirty-third degree being a seal showing that earth's mission has been accomplished. Each degree in its ritual, therefore, is also an elaboration of one of the tablets of the tarot. It is one important step in the progress of the soul, a step that to be correctly taken must correspond in its nature to one of the ten numerals, to one of the ten planets, or to one of the twelve zodiacal signs.

Why Symbols Were Used

—As Masonry is a study of symbols, let us now get a clearer conception of their nature. A symbol is that which stands for something. Material objects cannot be present in our minds, therefore when we think of them we substitute our impressions concerning them. Such impressions as enable us to distinguish one thing from another become symbols by which we recognize them. Thus if we think of a dog, or of a star, the image of a dog or a star may present itself to our minds. This image is a symbol.

But it is only when we give the dog or star a name that we are able really to think about it; for complex thinking is impossible apart from language. Language is composed of a special class of symbols. These symbols are usually arbitrary, that is, they require special education to recognize them. They are thus in a different group—although there is no hard and fast line of demarcation—from universal symbols. Universal symbols, such as those employed in Ancient Masonry, are those that so conform to man's customary experience with nature that their import may be recognized by any studious mind.

Thus, according to the philologists, when primitive man felt an emotion he accompanied it with a gesture or a sound. Then through repetition of the emotion and its accompanying expression, the sound or gesture came to be associated in the mind as representing a distinct emotion. A cry became the symbol of pain, laughter the symbol of mirth; and because of the wide application of these symbols—everywhere in our experience finding laughter representing mirth and a cry representing suffering—we may consider these typical universal symbols. But the terms commonly used in the arts and sciences, having been coined merely as conveniences, and adopted through usage, are much more arbitrary.

As ideas can only be communicated from one mind to another by means of symbols, these are employed to an extent even by creatures lower in life's scale than man. Thus in the animal kingdom, a mother may not see danger to her young, but if she hears it cry she recognizes the symbol as one of distress, and rushes to its rescue. Birds, such as the raven and the jay, post sentinels, and when a lookout sees an intruder approaching a warning call is recognized by the whole flock, and conduces to their safety. So also the barnyard aristocrat, proud chanticleer, announces the approach of

day with a warning call; or on other occasions imparts the information to his admiring harem, by affectionate clucks, that he has found a choice morsel; nor is one of these symbols apt to be mistaken for the other. In the human species a smile certainly is a symbol of amity and a frown a symbol of displeasure. And while there are places where people do not kiss, I am inclined to believe that the ebony maiden of darkest Africa would recognize the kiss as a symbol of love quite as readily as would the latest debutante whose polished manners grace the most exclusive circles of effete society.

As thought is impossible without the use of symbols, it will be seen that the study of symbolism is the study of the counters of thought. The study of Masonic Symbolism, then, becomes the study of the thoughts and ideas of the ancient Master Minds as expressed by them in the language of universal symbolism. Well knowing the transitory nature of arbitrary language, the words of one generation often having an opposite meaning in the next, these sages spoke and wrote in a language the words of which never change their import, thus preserving their thoughts in their original purity for all time. They discerned truly that so long as human minds abide upon this terrestrial globe there will be some, from time to time, who will discard arbitrary methods of interpretation and turn to nature for the clew. These, and these only, are able to read the message of the Ancient Masons as it was first taught in the secret schools of long, long ago.

The Entered Apprentice Lodge

—In reading this message, then, let us commence at the beginning, at the Entered Apprentice degree. An apprentice is one whose services are rendered that he may gain knowledge through experience. As the object of all ancient mysteries was to impart information about the origin, proper culture, and final destiny of the human soul, it will be seen that an Entered Apprentice is a candidate for soul knowledge. He typifies any man or woman who resolutely sets his foot upon the path leading to the spiritual height of complete initiation.

Now in opening a lodge of Entered Apprentices there must be present one Past Master and at least six apprentices. What, then, does this mean?

The room in which these seven assemble is said to represent a ground plan of King Solomon's Temple. King Sol, as we have noticed, is the sun, and his temple is in the arching sky. The ground plan, of course, refers to the earth, with the walls of heaven coming down on all sides to meet it at the horizon. And those who gather here, the various apprentices on the lodge of life, occupy physical bodies and are subject to material laws.

In the Grand Lodge above, the sun, as Past Master, together with the six lower-octave planets, form the seven types of celestial power, all of which must be present that life on earth may find complete expression; for each exerts an influence peculiar to itself and necessary for the fullness of life's expression. Sunlight is not complete unless it contains the seven rays of the solar spectrum, nor is the musical gamut as it should be unless there are seven tones within the octave. Thus also, a little study of astrology will demonstrate, there are seven lower-octave planets the influences from which are felt by every living being. Together they tend to mould the course of each human life, and so, after a manner, constitute the initiators of all.

In the heavens, then, the seven Masons required to open an Entered Apprentice lodge are the seven lower-octave planets. And according to the laws by which the Ancient Masons worked—which are also the famed laws of the Medes and Persians—that which is above has an exact correspondence to that which is below, and Solomon's Temple was actually constructed to serve as a model after the design of which each apprentice should strive to erect his own physical tenement. Consequently, as there are seven chief planets in the heavens above, there must be, and are, exact correspondences to these in man's domain. These embrace man's seven-fold constitution.

We have before us, then, the problem, though not a difficult one, of ascertaining the office in the lodgeroom corresponding to each of man's seven chief components. Such a problem is most easily approached by first studying the correspondence between the sections of man's constitution and celestial influences, and the correspondences between the officers of the lodge and celestial influences; and then, from this knowledge, arriving at the correspondences and their meaning between the officers and the sections of man's domain. This method of approach may best be started by gaining some knowledge of the influences of the various planets.

The sun is symbolized by its disc, in which appears, like a nucleus, a dot. It is the source of all life, even as the simple cell in which appears a nucleus is the source, or parent, of all organic life. This solar disc containing a nucleus typifies the vital, creative, positive, controlling attributes in nature. The vibrations of the sun are electric, and they rule the vital force in man. It may be considered the father of all within the solar system.

The moon is symbolized by its familiar crescent. It is the power that fructifies, nourishes, and rules the magnetic life currents. It represents the moulding, formative attributes of the astral world. The moon gives form to all life, her vibrations are magnetic, and she may be considered as the mother of all manifestation within the solar system.

The earth is symbolized by a cross. It is the place where active forces meet and cross one another. Negative and mediumistic, it has no power of its own, being but the matrix in which other forces develop. Electric and magnetic forces often meet here at cross purposes; therefore, in a sense, it signifies by its abrupt angles, discord, as well as stagnation and inertia.

In natal astrology we find that the sun actually rules the individuality, the moon the mentality, and the ascendant the personality. That is, in actual astrological practice the sun is considered as ruling the ego, or spirit, the moon as ruling the mind, or soul, and the ascendant, or cross, as ruling the body. Thus the disc becomes symbol of the spirit, the crescent the symbol of the soul, and the cross the symbol of the body. And the symbols of all the other planets are formed from these three, joined in such combinations as accurately to portray the observed influence of these planets in the manner in which they express physical, mental, and spiritual qualities.

Origin of Saturn's Symbol

—Saturn is symbolized by the crescent of the soul surmounted by the cross of matter. This signifies that the emotions, aspirations, and ideals, are made subservient to material and self centered ambitions. Temporal power is the motive, and all the feelings are repressed that action may result solely from deliberate consideration after due time for meditation. In natal astrology we find that individuals dominated by Saturn are careful, deliberate, subtle, cautious, prudent, and practical. Their chief characteristic is the persistence with which they labor for their own selfish interests. The cross above, typifying forces in antagonism, expresses the thought that all things are subject to change, that all terrestrial life ends in death, and that the tomb is the leveler of all earthly rank and distinction. Thus the cross above the crescent became the scythe held in the hands of Old Father Time. This is but one of the ancient conceptions relating to the planet Saturn as the orb of old age and dissolution.

Saturn is the planet expressing that one of the seven principles of nature the qualities of which are coldness, contraction, and concreteness. He corresponds to the Blue ray of the solar spectrum and has rule over the bones, teeth, and spleen in the human body. This should give us the clue to his correspondence both in the lodgeroom and in the human constitution. The physical body is the most gross and concrete section of man's constitution. The treasurer in the lodge well typifies the acquisitiveness of Saturn, as does his place in the lodge, which is north of the Master, in a region, therefore, of coldness, misery, and death. As the treasurer and the physical body (although no one planet can be said to rule the physical body of man) both correspond to the planet Saturn, we are justified in concluding that the treasurer, in the initiation of the soul, represents man's material form.

Origin of Jupiter's Symbol

Jupiter is symbolized by the cross of matter surmounted by the crescent of soul. This is just the reverse of the Saturnine emblem, so we need not be surprised that in practical astrology Jupiter expresses qualities the antithesis of those expressed by Saturn. Feeling preponderates, and gives rise to genial warmth, noble aspirations, generosity, expansion, and good will toward all. Those dominated by Jupiter often

became philanthropists, or take an active part in work having for its object social welfare and moral uplift. Lovers of fair play and benevolence, it is their constant delight to make others happy. The magnanimity of the Greek Jove and the Scandinavian Thor, and the Jupiter quality of giving, are well expressed as arising from soul emotion by the dominant crescent.

Jupiter is the planet expressing that one of the seven principles of nature the qualities of which are warmth, expansion, and geniality. He corresponds to the Purple ray of the solar spectrum and has rule over the liver and the arterial system of the body. This should give us the clue to his correspondences. Warmth and geniality as felt by others are largely due to the radiations of personal magnetism, and these as well as the strength of the will upon the physical plane, depend upon the strength of the etheric body, or aura. This etheric form of man vitalizes the physical body, and during life is inseparable from it. By its impressions from the outside world are registered on the consciousness. Jupiter corresponds well (although astrologically the planet Uranus has specific rulership over it) to this etheric body, and also to the secretary of the apprentice lodge, who sits at the south of the Master, in a region of warmth and radiation. Consequently, in the initiation of the soul, the secretary represents the etheric form of man.

Origin of Venus' Symbol

—Venus is symbolized by the circle of spirit surmounting the cross of matter. It indicates inspiration which expresses itself as blind love and art. Grace, exquisiteness, and beauty in all its forms are typified; but the soul being absent, impulse preponderates, and there is submission to more positive natures. Lovers of society, innocent and refined, the natives of Venus are mirthful, pleasure seeking, and convivial; but because reason is absent, they possess little moral power. Aphrodite, springing from the ocean foam, expresses her lightness and grace.

Venus is the planet expressing that one of the seven principles of nature the qualities of which are lightness, joy, mirthfulness, and clinging affection. She corresponds to the Yellow ray of the solar spectrum, and has rule over the internal sex functions and the venus system of the body. The readiness with which she yields to impulse and desire without thought of consequences or moral reflection, acting upon the strongest momentary whim, establishes her correspondence with (although astrologically it is specifically ruled by Neptune) the astral body of man. This astral form is easily separated from the physical body, is molded in its shape and texture by the desires, and blindly obeying the will of the intelligence controlling it, is peculiarly susceptible to suggestion.

Now if correspondences are strictly observed, the point of sunrise being positive, those Masons sitting in the east always represent masculine potencies. As the place of sunset is negative, those Masons sitting in the west must represent feminine potencies. Furthermore, as the south is the region from which the sun comes to overcome the evil powers of winter in the spring of the year, and as the blighting cold comes from the north as the sun moves southward in autumn, those Masons sitting in the south represent benefic influences, and those sitting in the north represent malefic influences.

Venus is both a benefic and a feminine potency; therefore she represents a position in the lodgeroom both south and west. A diagram of the lodgeroom of Entered Apprentices shows that the Senior Warden sits in the West, and the Junior Deacon sits south of him. The Junior Deacon, then, who sits both south and west represents Venus, and because Venus corresponds to the astral body, the Junior Deacon also corresponds to man's astral form.

Origin of Mars' Symbol

—Mars is symbolized by the circle of spirit surmounted by the cross of matter. He is just the reverse of Venus, and expresses matter overpowering spirit as a force for destruction. Instead of love we find passion, instead of grace we find strength, instead of art we find war. There is nothing submissive about Mars. He will dominate or die.

Strife is his joy, and conquest his religion. His desires are insatiable, and he knows no right but might. Those dominated by Mars are selfish, aggressive, cruel, and will brook no interference from anyone. Their selfishness, however, is very different from that of Saturn; for they are lavish of their substance, it being used chiefly as a means to gratify their passions and appetites. Vulcan is the planet Mars in its most constructive aspect.

Mars is the planet expressing that one of the seven principles of nature the qualities of which are combativeness, aggression, fiery impulse, and passion. He corresponds to the Red ray of the solar spectrum and has rule over the muscles, sinews, and external sexual organs of the human body. His inflammable passions, cruel selfishness, and coarse appetites (although no one planet can be said astrologically to rule it), establish his correspondence with man's animal soul. This animal soul is very necessary to man so long as he must struggle for survival on the physical plane, but while it makes a good slave it makes also a tyrannical master. It is the demon within that each must conquer through a transmutation of its energies. As Mars is positive and malefic, his position is represented in the lodgeroom by the east and north. In the

Apprentice lodgeroom it is the Senior Deacon who sits in the eastern portion of the room and to the north of the Master. That he is not so far north as the Treasurer indicates the recognition that in astrology Mars has less power for evil than Saturn. The Senior Deacon corresponds to Mars, and likewise represents the animal soul of man.

Origin of Mercury's Symbol

Mercury is symbolized by the crescent of soul, surmounting the circle of spirit, and—this surmounting the cross of matter. This indicates that soul and spirit have triumphed over sensation. It conveys the thought that wisdom has been garnered in both physical and superphysical realms, and that this has resulted in an equilibrium between the practical and the ideal, that the aspirations have been realized through the union of inspiration and concrete experience. The natives of Mercury live and move largely on the mental plane. They are studious, seekers of knowledge, finding delight in science, conversation, and literature. Mercury is the messenger of the gods.

Mercury is the planet expressing that one of the seven principles of nature the qualities of which are restless activity, intellectuality, volatileness, and changeableness. He corresponds to the Violet ray of the solar spectrum, and has rule over the tongue, brain, and nervous system of the human body. The brain and nervous system are the most refined of man's physical structures, and the spiritual body is the most refined of all his possessions. Likewise, similar to the intelligence which Mercury rules, it is but little developed in the majority. Its delicate structure is only built up by man's intense unselfish emotions, his love for others, and his soul's longing for, and effort to gain, esoteric wisdom. The spiritual body corresponds (although astrologically it is specifically ruled by Pluto) to Mercury. Mercury is convertible in sex, also in its nature through its associations, although easily made benefic. To represent the convertibility of sex the Junior Warden sits in the lodgeroom midway between east and west, and to denote that Mercury should be benefic he sits in the south. The Junior Warden corresponds to Mercury, and also to the spiritual body of man's domain.

Origin of the Moon's Symbol

—The Moon is symbolized by the crescent of soul. This signifies the dominance of the plastic, emotional, and enfolding qualities. She is the mother who clothes the ideals of her more positive lord. She is the mould of all that was, that is, or that ever will be, expressing the formative powers of the astral world. Those dominated by the Moon are mediumistic and greatly influenced by their surroundings. They are changeable, submissive, and inoffensive. Luna is the goddess Isis.

The Moon is the planet expressing that one of the seven principles of nature the qualities of which are purely magnetic and formative. She corresponds to the Green ray of the Solar spectrum, and has rule over the breasts, stomach, and fluidic system of the body. The Moon is feminine in nature, tending to be kind and gentle. She thus corresponds (although no one planet can be said specifically to rule) to the divine soul of man's multiple constitution. The divine soul is the good genius, from which spring noble impulses and unselfish aspirations. It is the inner voice of the conscience, the guardian angel whose admonitions when heard and heeded will not fail to direct the steps aright. A potency so feminine is rightly symbolized in the Apprentice lodgeroom by the west, where sits the Senior Warden facing the Master. The Senior Warden, therefore, represents the divine soul of man.

Origin of the Sun's Symbol

—The Sun is symbolized by the disc of spirit within which is a dot, or nucleus. Even as all physical life has its origin in a single cell, so the circle within which is a dot indicates limitless powers and possibilities. Power, dominion, vitality, strength, and radiant energy are represented. The Sun is the father of all life, the source of all energy, the controlling potency of our solar system. Those dominated by his influence are proud, majestic, combative, discreet, magnanimous, self-confident, kind, and benign. The Sun is the Egyptian Osiris.

The Sun is the planet expressing that one of the seven principles of nature the qualities of which are power and royal dignity. He corresponds to the Orange ray of the solar spectrum, and has rule over the heart of man. His central controlling station establishes his correspondence with the ego (which astrologically he also rules) of man's septenary constitution. That is, the ego in man's universe is the eternal controlling spirit power. The controlling power in the Apprentice lodgeroom is the Worshipful Master, who sits in the positive region of the rising Sun and rules the lodge. Therefore, the Worshipful Master corresponds to the ego in man's hermetic constitution.

Why Seven Must Be Present to Open an Apprentice Lodgeroom

It should now be plain why a lodge of Apprentices can only be opened when one Past Master and six Apprentices are present. The lodgeroom being a ground plan of Solomon's Temple indicates the material plane where all receive their first human initiation—where they encounter the tests and trials of everyday life. And as man is a seven-fold creature, being incomplete and incompetent when any of the seven are absent, so the lodgeroom, typifying man on the physical plane also is incomplete and incompetent unless the seven officers are all present.

To be capable of successful endeavor it is quite as necessary that man shall be possessed of his seven constituent factors as it is that to function successfully on the physical plane his chief physical organs—heart, brain, stomach, lungs, etc.—shall be present. Such is the information the Ancient Masons sought to convey by their tradition that the Apprentice lodgeroom may be opened only by a Past Master—for the ego is the oldest member of man's constitution—and six Apprentices.

Though they have no part to play in the work of the Apprentice Lodge, there are three other planets as follows:

Origin of Uranus' Symbol

—Uranus is symbolized by two crescents joined by the cross of matter surmounting the circle of spirit. This indicates two souls in union dominating the sensations of the flesh. Spirit is beneath, however, showing that the union is of body and mind, and not of spirit. The union is not that of soul mates, therefore they are not able to reach the highest spiritual states. Nevertheless, there is penetration, intuition, and occult insight. Those dominated by Uranus are independent, inventive, and lovers of occult science. The form of the symbol conveys the idea of a union not made in heaven, and Uranus in his influence over life is notorious for estrangement. Uranian people seek the true counterpart, yet when their keen intuitions impress them of a mistaken choice, they break the bond asunder. Uranus rules the etheric body of man.

Origin of Neptune's Symbol

—Neptune is symbolized by two crescents joined by the cross of matter which is surmounted by the circle of spirit. This indicates soul-mates occupying one blended astral form and controlled by one ego which is common to both. Neptune, the octave of Venus, typifies the realization of the highest love, which alone gives united souls the power to soar into the highest celestial realms. Those dominated by Neptune are idealistic, psychic, and given to mystical investigation. They seek fair utopia, and when inspired by love are capable of rising to the pinnacle of human genius and attainment. Neptune rules the astral body of man.

Origin of Pluto's Symbol

—Not only the 1939 NAUTICAL ALMANAC, from which the ephemerides makers obtain their astrological data, but other scientific works have adopted the symbol for Pluto THE CHURCH OF LIGHT has been using. Van Nostrand's Scientific Encyclopedia, copyright 1938, has this to say: "The name Pluto was selected for the new planet and the first two letters of the name, combined in monogram form are used as the symbol of the planet."

The influence of the planet is either the highest or the lowest of any, and tends to divide the qualities of the animal soul from those of the divine soul; groups each striving for supremacy. The symbol represents the cross of earth below, which is significant of the materialistic trend of the planet's lower influence. Above is the lunar crescent of soul.

But it is not such a crescent as is used in forming the symbols of Mercury, Jupiter, Saturn, Uranus and Neptune. These crescents, like that of the Moon, are open. Yet while this upper part of the symbol of Pluto is clearly a crescent, its union with the cross of matter is such as completely to close one side, and make it also resemble an imperfect circle. Or to state it another way: the upper significance of the symbol is to portray the transition, or change, of the soul to a higher form of expression, which is more nearly that of the circle of spirit. Pluto rules the spiritual body of man.

The Charter Under Which a Lodge Must Act

—Now we are informed that a lodge of Entered Apprentices can act only under a charter, or warrant, from the Grand Lodge. Man, therefore, as a copy of the Apprentice Lodge with its seven members, also must act under a warrant, or charter, from the Grand Lodge of the solar system. This warrant, or chart of birth, is a map of the soul's need for expression, and outlines unerringly the course it should follow. This chart(er) indicates just the work the candidate must perform to make progress and receive initiation within the lodge of life.

It is only when man becomes familiar with the chart and conforms his life and efforts to its mandates that he is able to escape the disapproval, and the consequent pain and suffering, from the Grand Stellar Lodge. It is only when he conforms his life to the music of the spheres as sounded at his birth, and either avoids the discords then sounded, or transmutes them into harmonies, that he lives to his best and reaches the highest degree of soul initiation.

Chapter 3

Serial No. 8
Original Copyright 1938
Elbert Benjamine

Copyright
Church of Light
August 2002

Entered Apprentice and the Signs

Chapter 3

Entered Apprentice and the Signs

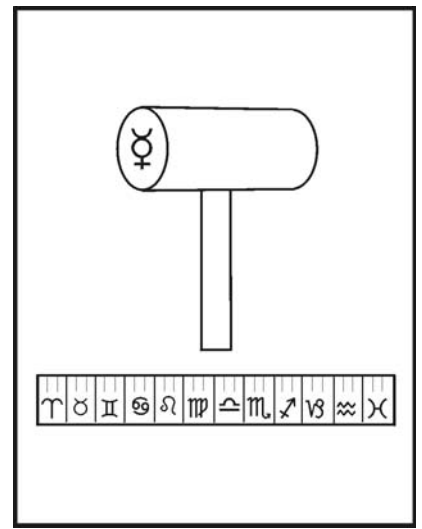

THE Entered Apprentice lodge represents a ground plan of the temple of the sun, it must relate chiefly to physical functions and the physical plane of life. One of the objects early brought to the attention of the candidate, not merely in the Entered Apprentice degree, but also in those higher, is the common gavel. What, then, did the common gavel signify to the Original Masons?

Tradition informs us that the ancients summed up the whole of existence, past, present, and future, in one word. This ineffable name, in the Bible translated as Jehovah, was expressed in Hebrew by the four letters, Jod-He-Vau-He. Elsewhere a sphinx of four-fold form was used to express the same idea. Rendered into English it signifies that there is but One Principle, but One Law, but One agent, and but One Word. The One Principle is symbolized by the form of the common gavel.

This common gavel, which is the first implement used in a Masonic lodge, derived its form astrologically by removing one of the four bars that divide the universe into four quadrants by the cross formed from the intersection of the equinoctial colure with the solstitial colure. The removal of one arm of the cross leaves the ancient Tau Cross, which has been used universally as the sign of the linga, which is revered today by hundreds of millions in India alone with no thought of shame; for it is the symbol of masculine virility.

The gavel, inherited from a past that placed no shame on man's body and its holy natural functions, due to its form, is the symbol of the Universal Creative Principle; the supreme attribute of Deity. Its form, it is true, is phallic; but merely because the ancient sages used the physical object the import of which is most easily recognized to represent universal principles. This gavel is the sledge with which Vulcan shaped the instruments of war. It is likewise the mighty hammer with which Thor forged his powerful thunderbolts. To be more explicit, every force and movement in the universe contains the expression of this One Principle.

That such is the case might be illustrated by analyzing any movement or energy with which we are familiar. A few examples will probably suffice for our purpose. But to understand the One Universal Principle, symbolized by the form of the common gavel, we must recognize the One Universal Law. This great cosmic law, that governs every conceivable action, is the Law of Sex.

As I look about me in search of examples, the first thing I observe is the fire in the grate that warms my room. Now chemistry teaches me that relative to each other atoms are sexed. These atoms that exhibit the widest difference in polarity, are more strongly sexed; experience the strongest attraction toward each other. Where opportunity is favorable the result of this attraction is the marriage between atoms. If the difference in sex is small, but little attraction is manifested, and the result of this chemical marriage, as the old alchemists would call it, is a feeble offspring. But if the difference in sex is great, as in the case between the oxygen in the atmosphere and the carbon fuel in my grate, the attraction is violent, and the product of the union is energetic. The heat and light radiated by the fire in front of me, according to the alchemist's view, is but the energy radiated by the intensity of the sexual combination of atoms of carbon with atoms of oxygen.

If next I contemplate my own actions, I discern them also to be the result of Chemical Marriages. Muscular movement is due to the combustion of fuel within the body of an animal. Furthermore, actions not chemical are quite as much due to the law of sex. The earth is held in its orbit about the sun, which I see through my window, by the equilibrium of masculine centrifugal force and feminine centripetal force. And every mechanical force may in like manner be shown to result from the union, or tendency toward union, of a positive and a negative factor.

Etheric energies, of which electricity is the best recognized example, are so commonly regarded as the interaction of positive and negative forces that extensive comment would be superfluous. Everyone is aware that it is the attraction of the feminine polarity for the masculine polarity that causes the electric current to speed along the wires, perhaps performing much work on the way. And mental action also, as a perusal of Course 5, *Esoteric Psychology* reveals, is quite as much due to the attraction and union of factors of different polarity within the mind. All mechanical force, all chemical activity, all etheric energy, and all mental effort; in fact, all action in the universe, is due to sex.

Now the modern reader is all too apt to narrow the meaning of the word sex, and limit it to the more obvious examples. But it was the object of the Ancient Masons to discover the comparatively few principles that pervade all nature, yet manifest in diverse forms. Sex, to them, then, was a principle that pertains to inanimate objects, as well as to those animate. It divides the universe into two qualities, one positive and controlling, and the other negative and receptive. The positive, controlling, creative half of the universe is symbolized by the form of the common gavel.

Of course, nothing is created in the sense that something is made from nothing. Substance of some kind, energy of some form, and intelligence in some degree, have always existed (see Course 3, *Spiritual Alchemy*). The exercise of the creative attribute on the part of man, then, is the utilization of energies already in existence. It is the turning of them into different channels of expression.

Not only is energy universal, but the ancient Masters taught that intelligence is universal also. When Camille Flammarion, after a half century of psychic research, says that intelligence is always present wherever there is an organism through which it can express, he states the same general idea. Anyone, I believe, who has much experience with psychic phenomena in its various phases will concur in this, that if the means be at hand through which intelligence may readily express, there is always an intelligent force present to take advantage of the opportunity. That is, intelligence, like substance and energy, is a universal attribute.

The Source of Will Power

—The one universal principle, or energy, when directed by intelligence, becomes Will. Man's only source of will power lies in his ability to receive energy and then persistently direct it into channels of his own choosing. Lower species of animals also transmit universal energies. But they have a texture and organization that permits only the less complex vibrations to express through them; while man, whose substance is more refined and highly organized, receives, utilizes and again projects in manners of his own selection, finer and more potent rates of energy.

Man thus is capable of transmitting the one universal principle in a manner of which lower animals are incapable. Man also uses a gavel in his work of building. He uses it with force and directs it intelligently to the accomplishment of a predetermined purpose. The gavel, then, while by its form typical of virility and creative energy, has come to have an added significance. It signifies that energy is directed by intelligence. And as energy directed by intelligence persistently to a predetermined end is will, the gavel has come to be recognized by its use as the symbol of the human will.

If we are in doubt as to the relation between the significance of the form of the gavel as indicating sexual virility, and the significance of its use as indicating will, a little observation will reveal the association. Those animals, for instance, that in the full vigor of their sexual life are energetic, alert, and combative, when altered by man become dull, listless, lazy, and cowardly. The bull is the lord and protector of his herd, while the steer is a lazy coward. The stallion is high spirited and independent, while the gelding is meek and submissive. The cock energetically scratches to provide food for this flock, while the capon cares for nothing but ease. And if we look to the most attractive and the most successful among our human acquaintances, we find they are without exception markedly feminine women and strongly masculine men.

The gavel being the first implement of Masonry indicates that the Ancient Masons believed the first thing the candidate should do is to cultivate his will power. In fact, the continued use of the gavel even in the higher lodges indicates their opinion that the culture and use of the will is necessary on all planes of existence. How, then, may the will be cultivated?

We often hear the remark that a certain person could do a specific thing if he but willed to do so. This no doubt is sometimes true, but as it is often the case that the person is notoriously weak and wavering in will, how can he exercise that which he does not possess? It is as great a fallacy to think that all men can use their wills successfully, as it is to think that all men can, without previous practice or experience, play a good game of golf. To play a decent game of golf requires long and arduous practice; and to use the will successfully requires at least as persistent training.

This brings us back to the one universal principle symbolized by the form of the gavel. Energy is universal. It is present in the sunshine we feel, in the food we eat, in the air we breathe, and as still finer currents that radiated from the stars flow through our astral bodies. That we may be energetic, physically, mentally, or spiritually, requires that we tap some existing source of energy and adapt it to our needs. The energy used in spiritual activity, quite as much as that used in physical effort, requires that we first receive energy from some outside source. One cannot exercise a spiritual force unless one has at hand a supply of energy of such refinement as to be spiritual.

Electrical Source of Energy to be Used by the Will

—The first thing, then, in the exercise of will power is to have at hand an adequate supply of energy. The kind of energy consumed in the exercise of will on the physical plane is etheric (electric) energy. It is the kind of energy that constitutes the nerve currents, the kind that is recognized as personal magnetism. The source of this electric energy—and how the physical cells, acting as miniature batteries—generate it, is explained in full detail in Course 5, *Esoteric Psychology*, Chapter 9. It is present, associated with the human body in normal quantities in all healthy persons. Well sexed persons have an abundant supply of it, but under sexed persons are deficient in it; for the former are recognized to be magnetic, while the latter are always deficient in personal magnetism, that is, in etheric energy. A normal healthy sexual nature, as the gavel suggests, seems to be requisite for a normal supply of etheric energy.

The amount of this energy may be greatly increased, and the amount thus available for the use of the will greatly augmented, by tension exercises and by rhythmic breathing. Rhythmic breathing, while the mind is firmly fixed on indrawing and utilizing the imponderable forces from the atmosphere, is the method most commonly employed to supply the requisite amount of etheric energy for unusual efforts of the will. It was the method employed by the Ancient Masons, and has for

centuries been thus employed by the Hindu Yogis. The latter term the invisible electromagnetic energy so obtained, prana. Instead of being subtracted from the atmosphere, in reality it is chiefly generated in the nervous system. But from whatever source it is obtained, or whatever the method employed to secure it, man can only exercise will power on the physical plane when supplied with it, on the same principle that a motor will only run when supplied with electricity.

There is still another important consideration in connection with this etheric energy. It has a wide range of vibratory rates. Some are of high frequency and very fine and powerful, and some are of low frequency, coarse and of less power. And like other energies, the higher the frequency, that is, the finer they are, the more powerful they become. This seems to be a general law, that the higher an energy is in rate of vibration, the more powerful it is, providing its energy is properly utilized.

This brings us to another observation of the old Magi. They held that in strict ratio and proportion to the refinement of substance is it vitalized by spirit. That is, the more refined an organism, the higher the frequency of vibrations it will transmit. And as the higher rates of energy are more powerful, the more refined the organism, the more capable it becomes to exercise a powerful influence on other organisms and things. In other words, other things being equal, the higher refined organism is capable of exercising a stronger will power than one more gross.

Intelligence, like energy, being a universal attribute, we perceive why it is that often persons of small cranial capacity have more intelligence than those of larger capacity. Their whole physical make-up is finer, and more complex in texture; hence they are capable of receiving and transmitting finer forces than those less refined. Fine rates of energy, true spiritual powers, can find no point of contact in a gross body. Therefore, for spiritual power, and also for will power, there should be a progressive refinement of the body.

The Proper Culture of the Will

—The mere transmission of energy, even if refined, however, does not constitute will power. Will power, as indicated by the use of the gavel, is energy directed persistently to some purpose.

How then can we develop will power? How can we develop the first implement of a Mason? Only by practice. There is no other way. One learns to play golf or tennis by keeping doggedly at it, and one develops will power in the same way. In the first place, to avoid discouragement, one should never attempt doing something until careful reflection has shown that it is both possible and advisable. But once having come to a decision to do something, it should be carried through to complete accomplishment in spite of all obstacles. This system should be tried at first on the inconsequential things, as one in golf first tries the easier strokes. Little by little, the plan should be enlarged to embrace larger undertakings, until finally the exercise of a powerful will becomes a permanent habit in the life.

Such a development of the will is, therefore, according to the ancient sages, the first implement of a Mason. Any person will find such an implement most useful. But to one who intends to practice magic it is quite indispensable. All the asceticism, self-torture, harsh discipline, and self-mortification of the oriental fakirs and certain of the yogis has for its sole object the building up of an inflexible will. Once a thing is decided upon it is always carried through in spite of obstacles, pain, or sorrow. Yet a useful and normal life affords quite as much opportunity for rigid will development.

The habit and mood of inflexible will in time becomes so impressed upon the astral organization, or unconscious mind, that all energies are focused to the accomplishment of the desired result. Therefore, in the practice of magic, when a thought is formulated and projected by such a person, all the etheric energy available is concentrated in the projection of the thought, and the astral form of the person continues, even after the matter is no longer present in objective consciousness, to utilize every effort to bring the formulated event to pass.

Nothing worth while, either in magic or in more prosaic endeavor, can be accomplished without the development of a strong will. In this development, as we have seen, there are three factors. There must be an energy supply. Such energy is available to the naturally virile person who practices dynamic breathing for the purpose of generating etheric energy. This energy supply must be of high frequency. That it may be so the body is refined through careful diet, through high aspirations, and through the cultivation of pure and lofty emotions.

This energy must be directed with an inflexible purpose. Such inflexibility may be gained through practice with the normal affairs of life. To use the methods of oriental ascetics is to develop the will at the expense of the divine soul. The divine soul is built up by the nobler impulses and finer emotions. To crush all feeling from the life is to starve and perhaps destroy the immortal part of one's nature. Cold intellect alone is not high enough in vibration to penetrate the higher spiritual realms. The animal soul, like any animal, yields to firm treatment, but if treated harshly it either becomes savage and vengeful, or loses all heart and becomes a quailing coward. It should be transmuted until all its energies are utilized by the divine soul, not beaten or slain. People, animals, and the animal soul of man, all respond to kind yet firm treatment.

Every man, according to the Ancient Masons, has a definite constructive work in the world. When this work is discerned, the culture of his will requires the absolute adherence to carefully weighed resolutions that have been formed irrespective of impulse and momentary desire, having for their end progress toward the One Great Aim of the individual's life; and the vitalization of the organism with energy sufficient in quality and quantity to carry out the dictates of these resolutions.

Significance of the 12-inch Gauge and the 24-inch Rule

—Now in Modern Masonry, as well as in that more ancient, we find closely associated with the common gavel the 12-inch gauge and the 24-inch rule. The factors that gauge the tone quality of the forces reaching man and expressing through his organism are the twelve zodiacal signs. They are the chief gauges of his life, character, and efforts. The sign the sun is in at birth is the gauge of his individuality, the sign the moon is in at birth is the gauge of his mentality, and the sign on the ascendant at his birth is the gauge of his personality. They gauge his thoughts, his speech, his actions, and the events which enter his life. They gauge the strength and the harmony of the influence of such planets as may be within their bounds.

But the particular department of life influenced by each zodiacal sign, by each section of the twelve-inch gauge, must be ascertained by the application of the 24-inch rule. This rule embraces the 24 hours of the day. All the zodiacal signs rise, culminate, and set, within the limit of this 24-inch rule. Only by determining the time of an event, or of a birth only by applying the 24-inch rule—can the astrological influences affecting it be learned. Furthermore, this rule of 24 sections measures out to man the time when each of the important events of his life will take place; for each 24-hour cycle after birth, according to the most approved astrological practice, actually releases forces that bring to pass the major events that transpire during the corresponding year of life.

The 24-inch rule, then, is the 24-hour day, during which the signs of the zodiac, bearing with them all the planets, rise and set. By its proper use as a time measuring instrument the exact position of all the signs and planets at any moment of time may be known. Such a chart, erected for the moment of birth, is the best possible road map to a successful life, and to the goal of complete initiation.

As to the 12-inch gauge, each section is one of the consonants of celestial language. The observations of the Ancient Masons convinced them that Solomon's Temple was actually divided into twelve such equal sections. They consequently sought for those things on earth, and within their own bodies, that vibrate to the same tone quality as each of these signs. Having selected some familiar object on earth that best summarized the influence of a zodiacal sign on human life, they traced the outlines of this object in its appropriate place among the stars. And then, at a later date, to express the same thing quickly in writing, the object's form was merely greatly abbreviated and conventionalized. Let us, therefore, trace this process with each section of the 12-inch gauge.

Origin of the Aries Symbol

In the Ram the Ancient Masons discerned the primitive fighting instinct, the desire for leadership, the headstrong aggressiveness, the fiery temper, and the impetuosity, that they observed in people born when Aries is the ruling sign. These people are ambitious, intrepid, despotic, often quarrelsome, pugnacious, and passionate. Yet in their work of construction or destruction they are noted for creative power and original thought, always using their brains in all they do. The Ram also is combative, and uses its head in offensive work. Thus the Ram, typical of the influence of Aries, which rules the head of man, was given first place in the arch of Solomon's Temple. To denote the Ram in writing they used a conventional form of the face of a sheep surmounted by its curling horns.

Origin of the Taurus Symbol

—Those born under the influence of the sign Taurus are careful, plodding, and self-reliant. They are quiet and thoughtful, patiently awaiting for plans to mature. Remarkable for endurance, industry, and application, they sometimes become sullen and reserved. They are virile, with strong procreative instincts, are slow to anger, yet when once aroused are furious and violent; are warm friends and relentless foes. The sages of old noted similar qualities in the Bull, a similarity that can be observed also today, and they chose the Bull to occupy second place among the starry constellations in the sky. The Bull is remarkable for the strength of his neck, and the sign Taurus is found to rule the neck and throat of man. The Bull was denoted in writing by the conventionalized face of a bull with the two horns readily recognized.

Origin of the Gemini Symbol

—Duality is the most marked characteristic of those born under the third division of the zodiac. They have both intuition and reason well developed, are fond of all kinds of knowledge, are restless, changeable, energetic, enterprising, and good teachers. They are dexterous and quickly acquire skill with their hands, often following more than one occupation at the same time. Their chief difficulty is to concentrate their energies long enough in one channel to make it a great success. This marked duality led the ancients to picture the sign Gemini in the sky as the Twins, Castor and Pollux. Gemini rules the hands and arms in the body of man, and to express the Twins quickly in writing two perpendicular marks were used.

Origin of the Cancer Symbol

People born under the sign Cancer are tenacious, sensitive to their surroundings, retiring, timid, and desirous of carrying out their own ideas in their own way. They are mediumistic, possess good reflective powers, and are true conservers of force. In these things they are like the crab, and further, when the sun in its annual journey enters this first of the watery signs it starts back toward the south from the north, suggesting the backward method of locomotion common to the crab. So the Crab, influenced by the tides and the moon as are Cancer people by their moods, was selected to represent the sign Cancer. Water is the mother and nourisher that carries food to the united sperm and germ enabling them to grow. The sign Cancer also rules the home and family, the sperm and germ moving toward union well showing the foundation of domestic ties. Cancer rules the breasts and stomach of man. And to represent this chief of the domestic signs quickly in writing, the Wise Ones used the claws of the crab as emblems of the two cells moving toward each other.

Origin of the Leo Symbol

—Those born under the sign Leo are marked for their courage, for the strength of the physical constitution, and for recuperative power. They are honest, fearless, magnanimous, generous to their friends, impulsive, passionate, faithful, sympathetic, and ambitious. They are lovers of their offspring and will defend them regardless of cost; are majestic, proud, and become natural rulers of others. Their ideas are usually on a large scale, seldom stooping to pettiness or meanness. These qualities were also discerned in the lion, therefore, the Masons of Old traced a lion in the sky to mark the fifth division of the zodiac. Leo, ruler of the heart in man, is the sign ruled by the sun, which is typical of creative power. And because the deadly cobra has the power of raising itself and expanding its hood in fancied resemblance to the procreative organ, it was, and is, venerated in many countries of the world as sacred to the sun. Therefore, to represent the sign briefly, in writing, the cobra, much conventionalized, was used.

Origin of the Virgo Symbol

—Virgo people are thoughtful, serious, contemplative, modest, ingenious, careful, cautious, and industrious. They often become scholars and scientists, repositories of information, with the ability to assimilate experience in such a way as to yield a rich harvest of knowledge. They are thus always ready to suggest improvements in existing methods. To the Ancient Masons, the human body is the womb of the universe, from which after its period of gestation, through the travail of death, the son

of God is born into the spiritual world. Death to them was but the freeing of the soul from the restricting envelope of matter, a passing from darkness into light. This is the mystery of the immaculate conception: Man, as the uterus of Isis, is impregnated with the Holy Spirit, to develop within himself Christ Consciousness. When this mystical atonement is made he can truly say: "I and the Father are One." In the sky this thought is depicted as a gleaner, immaculate and pure. She holds in her hands two ears of wheat, typifying the harvest of love and wisdom which constitutes the mission of the soul gestating in human form. This harvest well expresses the discriminative function of the bowels, that part of the human anatomy ruled by Virgo, and also the discriminative powers of Virgo people. It was expressed hieroglyphically by a sheaf of wheat.

Origin of the Libra Symbol

—Those who are ruled by the sign Libra are lovers of peace and harmony, are amiable, even tempered, affectionate, sympathetic, and inclined toward marriage. They are fond of art, refined pleasures, and amusements, dislike unclean work intensely, have a deep love of justice, and feel the need of a companion to share their lot in life. For a moment they are easily carried away by their emotions, but quickly regain their balance. This mental equilibrium, and the instinct for justice, was pictured in the sky by the Scales. Libra rules the veins, the internal sexual organs, and the reproductive fluids in man. It is the sign of marriage, and was represented in writing briefly by the union of a feminine, or crooked, line, with a masculine, or straight, line.

Origin of the Scorpio Symbol

—Those born under the sign Scorpio have strong sexual desires and possess an inexhaustible fund of ideas. They are thoughtful, contemplative, ingenious, scientific; and where others are concerned can be cold, calculating, unsympathetic, deceitful, and cruel. Suspicious, determined, secretive, energetic, shrewd, they possess fine mechanical ability, and often have a strong life-giving magnetism that enables them to become successful healers as well as good surgeons. The intensity of the sexual nature, the subtlety, cruelty, fighting instincts, and underhanded methods by which they attack opponents, suggested to the minds of the Ancient Masons the Scorpion, whose chief weapon of offense is the least suspected part of his anatomy, at the end of his tail. Scorpio rules the external sexual organs in the anatomy of man. Like Virgo people, those ruled by Scorpio are harvesters of knowledge, but unlike Virgo people, whose sheaf of wheat is closed at the bottom to indicate conservation, the sheaf denoting Scorpio is left open at the bottom to indicate wasteful expenditure of precious energy. And to indicate the retaliating pangs of remorse for such loss, as well as to suggest the Scorpion, in denoting the sign briefly in writing the sheaf of wheat was provided with a scorpion's tail.

Origin of the Sagittarius Symbol

—The Centaur, half animal and half man, was chosen by the Sages of Old to picture in the sky the sign Sagittarius. It well represents the dual nature of those born under this sign; for their animal propensities are strong, yet they are also well supplied with the higher, nobler, more generous impulses. The body and legs of a horse indicate restlessness, physical activity, and migratory tendencies; while the upper and human part indicates conservatism, self control, and executive ability. They are free, energetic, ambitious of worldly position, are loyal, patriotic, and charitable to others. Their love of hunting and all outdoor sports is shown by the full drawn bow, which also expresses retribution; for Sagittarius people are quick to fight for the rights of others. They are prompt and decisive in action, can command others, are frank and candid, and when they speak their remarks go straight to the mark like an arrow to the bull's eye. Sagittarius rules the thighs, which are the seat of man's locomotion. To write the sign quickly, the arrow from the archer's bow was used.

Origin of the Capricorn Symbol

—Those born under the sign Capricorn are quiet, thoughtful, reserved, serious, economical, prudent, cautious, good reasoners, decidedly practical, and ambitious of wealth and position. They are born diplomats, and quick to see and use the weaknesses of others for their own advantage. Thus as a goat ascends a mountain, taking advantage of every possible foothold, so these people climb to their ambitions by grasping every possible opportunity, great or small, to advance themselves. Suppliantly they bow to the reigning authority, seeking by sundry and devious ways to gain the good will of others, that they may partake in power, much as the goat must bend his knees and devise many a clever method to crop the foliage among the precipitous rocks of his upland pastures. These people are patient and persistent, and by concentrated effort and skillful maneuvering butt their way through, or climb their way around, all but insurmountable obstacles. In the body of man Capricorn rules the knees. It is pictured in the sky as the Goat. And to write it quickly a twisted devious line was used, twisted to suggest the spiraled horns of the goat, but in its pattern a still better representation of the circuitous path by which goats and people reach the heights of material ambition.

Origin of the Aquarius Symbol

The chief characteristics of those born under the sign Aquarius are the predominance of humanitarian instincts and the desire for a scientific verification of all theories. This intellectual trend is represented by the Man of the zodiac, while the sympathies and emotions that bind him to his fellowman are pictured by water flowing from the urn. It is the baptismal urn, the water representing the pure emotions that prompt man to reform and lead a new life. These people are kind, amiable, witty, fond of refinement and society, and are keen students of human nature. As Leo is symbolized hieroglyphically by one serpent, Aquarius, where Reason and Intuition balance, where man and woman have learned the significance of sex, have partaken of the tree of knowledge of good and evil, was anciently symbolized by two serpents moving in opposite directions. Aquarius rules the legs of man. It is written briefly as two wavy lines, a conventionalized form for the two serpents, and also suggesting the water that flows from the Waterbearer's urn.

Origin of the Pisces Symbol

—Pisces people are amiable, very sympathetic, kind, neat, and particular, yet are often timid and lacking in self-confidence. They are greatly influenced by their environment, are restless, emotional, highly imaginative, and capable of high intellectual development. In their ideals they are utopian. They long for universal brotherhood, for the highest expression of love, and for peace on earth good will to men. Sensitive, mediumistic, capable of psychic lucidity, romantic and lovers of mystery, they are apt to become too negative and dreamy to practice their ideals. They take an interest in psychic investigation, have a strong desire for the ideal in marriage, and when this ideal is not realized become restless and discontented. Pisces rules the feet of man. Fish, due to their reproductive ability, are ancient symbols of sex, and water is the symbol of the emotions. To represent the ideal love and marriage for which Pisces people long—that union referred to in the Bible as the tree of life and in the Kabala as the Holy Shekinah, or perfect way of nuptials—the Ancient Masons placed in the sky two fish and united them by a cord of love. To write the sign quickly they used two crescents, symbolizing two souls, likewise united by a connecting line.

Significance of the Signs in the E.

A. Degree

Now having defined the 12-inch gauge, let us revert to the first implement of a Mason, the common gavel. In the Entered Apprentice lodge the Master gives one rap with his gavel. The Master, as has previously been explained, represents the human ego. The gavel represents the human will. The table, against which the gavel is struck, is a plane surface, and thus represents a plane, any plane, of existence upon which the soul may sojourn. One blow on the table, of course, represents the first plane, that is, the physical plane. Two raps signify the second plane, that is, the astral realm. Three raps indicate the third or spiritual plane. But in the E. A. degree but one rap is necessary, because the mysteries of this degree all pertain primarily to the physical plane. In fact, if we are to be able to check our information concerning other planes of existence adequately, we must first thoroughly understand all the laws and facts, in so far as possible, relative to the physical plane. How can we understand higher mathematics unless we first learn to add, subtract, multiply, and divide? Therefore, the Ancient Masons insisted that the candidate should, before investigating higher realms, thoroughly understand his physical functions and the physical plane of life.

As soon as the lodge is opened, the Master asks the Junior Warden, representing the planet Mercury, if all are E. A. Masons in the South. The South is the place where all the planets reach their highest position. He then asks the Senior Warden, representing the Moon, if all are E. A. Masons in the West. The West is where all the planets sink from sight beneath the horizon. Having been answered in the affirmative, he, representing the Sun, then vouches for those in the East. The east is where all the planets rise into view. But the North is left unmentioned, for to us of the northern hemisphere there are no planets to our north. The North, where water freezes, is the symbol of crystallization and of strictly material motives. These latter are left unmentioned, for material achievement based on purely material motives, has no part to play in soul advancement.

The Junior Deacon, representing the planet Venus, is next called up to the Master, and gives a sign by which he may be identified. It is quite fitting that Venus, the planet of love and affection, should be the one to give this sign. It consists of placing the open fingers of the right hand upon the open fingers of the left hand.

Venus, in astrology, rules the sign Libra, the sign that governs both marriage and open enemies. Therefore, it is quite fitting also that the Master should appoint Venus, the Junior Deacon, to station outside the door, the Tyler with drawn sword. This door is the barrier between the seeming and the real, the exoteric appearances and the esoteric verity. Venus, the planet of love, affection, and marriage, knocks three times

on the inside of this door, signifying the esoteric and real knowledge concerning marriage as applied to all three planes. The Tyler, symbolizing man's thoughts, then answers by three knocks on the outside of the door, signifying those exoteric and unworthy opinions about marriage on all three planes that guard the real truth from the uninitiated.

Finally, the Junior Deacon knocks once and is answered by one rap, indicating that in the Entered Apprentice degree the candidate is expected to master the laws governing physical marriage only. That the study of such laws, and the attempt to apply them in the production of a nobler race of mankind, as well as the attempt to apply them in the elevation of the soul to higher states of spiritual attainment, was one of the chief objects of the Ancient Masons in the E.A. degree is plainly shown by the sign given by the Junior Deacon to the Master. Five is, and as far back as such things can be traced always has been, the symbol of man or woman alone. The five fingers of the right hand represent man, the five of the left hand represent woman. The right and the left hand joined, in universal symbolism, represents the marriage of man and woman.

Contrast of Ancient Masonry Teachings With Those of Present Day Orient

—However moderns may regard marriage, the Ancient Sages attached no sense of shame, immorality, or degradation to it. They looked upon it as one of life's noblest privileges, and by deep study sought to learn how through it better offspring might be brought into the world; how the noblest sentiments possible to man might be strengthened, how life might be prolonged, disease avoided, and a greater amount of happiness brought into the world.

If we are to believe tradition they in a measure succeeded in all these things. The Bible gives repeated accounts of man living far beyond the allotted three score and ten years. But irrespective of the literal veracity of these stories, the Ancient Sages believed that their lives were prolonged and that they attained higher powers through their understanding of love in the sacred precincts of marriage.

Nowhere are these teachings and beliefs more plain to discern than in Ancient Masonry. But let no one be led astray by the thought that any so-called sex practices were taught. Neither was asceticism and celibacy taught. The Sages of Chaldea, the Priesthood of Egypt, and the Ancient Masons, were married people. They believed in marriage, believed it was a holy and sacred institution, believed in purity, in kindness, in love. In India, it is true, asceticism developed, and also sex-magic such as is found among the Tantrics today. But I find no hint of such extremes in Ancient Masonry.

Dozens of sects flourish today throughout America teaching suppression of the love nature. Other dozens of sects, usually as sworn-to-secrecy inner circles of cults, teach sex practices as the means of gaining supernormal powers. If the teachings of the Ancient Masons, as revealed by their symbolism, are true, both these ideas are a delusion and a snare. In fact, it is my belief that if those doctrines were permitted full public discussion they would soon have no adherents, because the medical profession alone would present such an array of actual pathological cases caused by such ideas that it would discourage others. Such beliefs thrive on secrecy.

If I may be pardoned for mentioning personal observations, I may say that I have been in occult work since 1898, and have contacted, directly or indirectly, most of the cults, colonies, and beliefs of any consequence throughout the world. In that time I have known of centers and colonies devoted to some special sex practices, but while I have known of many cases of physical and mental derangement to result, up to the present day I have not known of a single person that has been in any way benefitted. Also, I have known of many centers and cults that teach repression, and while I have observed much psychism to result from this, it has always been an unreliable and often obnoxious form of psychism.

Such personal remarks are relevant because to explain Ancient Masonry it is impossible to avoid reference to sex; and a plain statement may prevent hasty conclusions. The teachings of Ancient Masonry in such regards are very simple, very plain, and such that they would be endorsed by medical men of high standing, quite coincide with the legal requirements of our land, and set a high moral code. Their doctrines relative to sex are concerned with marriage, and teach man not to starve his animal nature, but to transmute the animal into the divine. They teach man how he can cease being a brute and become an angel.

Oriental doctrines which are in all essential respects the very opposite of those of Ancient Masonry are prevalent today. First of all, they advocate that the individual shall eat only the most negative of foods. Yet his ability to control himself and to exercise will power, depends upon, not the volume of electricity generated in his body and nervous systems, but upon its voltage, or potential. As explained fully in Course 5, *Esoteric Psychology*, Chapter 9, it is the protein molecules of the body which are able to release the high-frequency energy of the lightning which fixed the nitrogen that plant life took from the soil. And most people cannot thus release high potential enough or in any manner develop high voltage in the gray matter of their brains, while living on the negative foods advocated in this Oriental training.

The action of the endocrine secretions of the gonads on the nervous system is to cause it to generate electrical charges in greater volume. Celibacy, therefore, tends to have the effect of charging the individual with much surplus electromagnetic, or etheric energy.

Rhythmic breathing also is advocated, and exercises prescribed which tend to generate still greater excesses of etheric energy.

Thus sex repression and dynamic breathing are employed to generate a great excess of etheric energy which floods the system; but, because of the diet and the practices in meditation, no ability to control this low potential etheric excess is developed. On the contrary, the dreamy fantasy kind of thinking called meditation is cultivated, which breaks down whatever power the individual already had to direct his thoughts concisely and clearly into channels of control.

As a perusal of Course 5, *Esoteric Psychology*, Chapter 9 will make plain, control of one's thoughts or control of one's body depends upon being able to mobilize in the brain cells used for such control, an electrical energy not merely strong enough to gain recognition, but with a potential sufficiently high that it can overcome, and displace, other electrical energies which compete with it.

If the brain cells employed for control can not acquire a higher electrical potential than potentials generated in other regions of the body—in the sympathetic nervous system, for instance—it can not control, but is controlled by, these electrical energies thus elsewhere generated. Yet the various meditations and concentrations employed in the Oriental teachings mentioned, have as a direct result the discouragement of positive clear cut intellectual thinking, and they break down the power of the brain to generate electrical energies high enough in voltage to exercise control. Instead the control comes from the sympathetic nervous system.

Etheric energy, having a velocity when in motion approximately that of light, is the bridge between the physical world and the astral world. According to Einstein's General Theory of Relativity, no material thing can have a velocity greater than light. Therefore, that which has a velocity greater than about 186,284 miles per second no longer belongs to the physical, but is an object on the astral plane.

And an excess of this boundary line etheric energy makes it easy for motions from the physical plane to be communicated to the astral plane, or for motions on the astral plane to be communicated to the physical. The excess of etheric energy developed by breathing and sex repression, therefore, is favorable for enabling astral entities, either in the flesh or on the astral plane, to contact the individual and use him and his electrical forces to produce phenomena, to impress him with their wishes, or to exert an influence upon others at a distance.

But the training has been careful to discourage, both by the negative diet and the mental exercises, the development of ability on the part of the individual to use these etheric energies he generates. The whole system is designed to develop volumes of low potential electrical energy such as most readily can be used by a distant Mahatma in the flesh, or by some astral entity, in spite of any attempted resistance on the part of the poor dupe thus trained; when he realizes that he is being controlled for purposes about which he knows nothing.

Instead of the opposite process, which the Ancient Masons taught, in which pains are taken to develop Intellect and Will, so that the individual always may be master of himself, this Oriental training furnishes plastic individuals quite incapable of directing their own forces, but who generate great quantities of etheric energy which can, and is, used, whether or not there is consent, by cunning and dominant minds working from the inner plane for their own selfish purposes.

Chapter 4

Serial No. 9
Original Copyright 1938
Elbert Benjamine

Copyright
Church of Light
August 2002

Numbers and Opening the Lodge

Chapter 4

Numbers and Opening the Lodge



MODERN FREEMASONRY is the traditional remnants of Ancient Masonry. It retains the older forms of the ritual imperfectly; yet in spite of the modifying influence of time, and the alterations that are inevitably the outcome of passing through countless generations, it still presents to our vision the essential elements of truth as they were found when first gleaned from the starlit realms of Urania.

Following the modern ritual we learn that the Master—representing, as we have found, the sun in the solar system and the ego of man—ascertains that all present are E.A. Masons, and thus duly qualified for the work to be done. He next instructs the Junior Deacon—representing the planet Venus, and the astral body of man—to have the lodge properly tyled, or guarded; and then commands the brethren to be clothed, to don their aprons and jewels.

Within the astral body of man, corresponding to the Junior Deacon, reside thought-cells, the mental elements of which embrace all the experiences the soul has had. These mental elements, built into thought-cells and thought structures, constitute his unconscious mind. All his external perceptions, actions, and thoughts are recorded here, and when raised into the region of objective consciousness constitute memory. And there are other trains of thought, and perceptions relating to the astral world, also here residing that never reach the level of objective consciousness. The astral body, therefore, is the great reservoir of consciousness.

The Important Duty of the Tyler

—The duty of the Tyler is said to be to keep off all cowans and eavesdroppers, and to see that none pass and repass except such as are duly qualified and have permission from the Master. This Tyler represents objective consciousness, chiefly the reason, that guards the threshold of the mind and determines what thoughts shall, and what thoughts shall not, be allowed entrance to man's domain. Reason only becomes alert to its duties when there is a determination on the part of the unconscious mind, in other words a strong desire, that it shall do so. Such desire, as explained in detail in Course 5, *Esoteric Psychology*, Chapter 4, arises from the astral form, the Junior Deacon.

Very few people realize how very important this work of the Tyler is. As the thought-cells which comprise the unconscious mind, or character, are derived from experiences and the thinking that is done about them, it is the Tyler who determines what is added to the character and what alterations in the character are made.

These thought-cells, constituting the membership of the unconscious mind, in turn determine what the individual does, and what events are attracted into his life. It is only when certain groups of them acquire unusual additional energy that events of a specific nature come to pass. And not only do these thought-cells, which are thought formed, determine when the events in his life come to pass, but they also determine to what extent these events are such as he desires, or such as he deems to be misfortunes.

Thus is it, that the only way man can change his destiny, and make it better than it otherwise would be, is through cultivating appropriate thoughts and emotions, which implies that he must be able effectively to guard his domain and prevent the entrance of those thoughts and emotions which he has decided are inimical to the life and fortune which he desires to attain.

But effectively to tyle his lodge, to prevent the eavesdroppers and cowans, which are the unworthy thoughts and inharmonious attitudes toward life, from entering his constitution, requires much more than merely desiring to prevent their entrance. They have a most insistent way of forcing themselves on the attention of consciousness, and to prevent them from so doing requires a proper technique and much practice. In fact, it is one of the most difficult and important tasks which man is called upon to undertake.

One first, of course should determine just which thoughts are worthy of entrance to his constitution, or lodgeroom, and then keep alert to note the approach of those which it has been decided should be excluded.

That which gains the attention of objective consciousness must do so through the use of electric energies generated within the body, chiefly by the nervous system. How these energies are generated is explained in Course 5, *Esoteric Psychology*, Chapter 9. And there also is explained that the thoughts which hold the attention, and thus shoulder all other thoughts from the consciousness, are those which can command the highest electrical potential. Thus if an individual is to predetermine the kind of thoughts which are to gain the attention of his objective consciousness and consequently enter his lodgeroom, the gray thought-cells of his brain must be able to command a higher voltage of electric energy than can be commanded by the thought-cells of his unconscious mind which have insistent desires, and higher than those generated by other portions of his body, such as by portions of his sympathetic nervous system.

Constant training to use his brain thus to control his thoughts is essential to this work of guarding the lodgeroom. But in spite of such Conditioning of the brain cells to develop high potential electricity and direct it into channels of control, various factors may lower the output of electrical energy upon the part of his body in such a way as to make thought control difficult. These things he should understand.

Overwork may lead to physical exhaustion. And physical exhaustion normally is accompanied by a decrease in the amount of electrical energy available for the use of control. That is, vitality is electrical in nature, and lowered vitality indicates a low generation of electrical forces.

High tensions of the nervous system, on the other hand, or over stimulation of any kind, such as through the release of adrenalin in the blood stream in response to a real or imagined emergency, may so increase the voltage of the nerves other than the brain that these are able to dictate to the brain and control the thinking.

Also, especially when they receive great volumes of astral energy from the planets forming progressed aspects, certain groups of thought-cells within the unconscious mind may be able to impart their energy so strongly through the ether to the brain or nervous system, as temporarily to dominate the mind. Their desires, or the images which they project on the objective consciousness, may be able to generate so much electrical potential as to hold the attention in spite of previous resolves that they shall not.

And the thoughts of others, incarnate or discarnate, through impinging powerfully upon the unconscious mind, and through etheric forces imparting energies to the brain or nervous system, may become insistent or at times almost obsessive, in the same way.

Under such conditions one should not become introspective, but have something outside of oneself, something which in itself is very pleasant, to think about. The consciousness then should be extended to this thing—not directed to how it causes one to feel. This will result in the energies being radiated outward toward that which is the object of attention. Under this process, unless the electrical power has been permitted to get too low, any thought or emotion—eavesdropper or cowan—can be excluded.

These eavesdroppers and cowans that should thus be kept from the lodgeroom, or human constitution, are all unworthy thoughts and inharmonious attitudes toward life. Only thoughts that are constructive in quality, and emotions that are harmonious, are duly qualified, and only to such does the Master, the human ego, if he performs his duties properly, grant permission to enter.

When the brethren don their aprons and jewels they consistently represent the Grand Man of the skies. The apron indicates them to be virile and in full possession of their natural functions. The jewels show them to be in full possession of their mental and moral faculties, even as the jewels, the plumb, the level, and the square were shown in chapter 1 to be the methods by which the mandates of Deity are carried out. Each congregated Mason, then, when so clothed, as well as the lodge as a whole, represents both the Temple of King Solomon, the home of the glorious orb of day, and the mansion of the indwelling human ego.

Function of the Junior Deacon

—When the brethren are clothed the Worshipful Master asks the Junior Deacon—Venus, and the astral body—his place in the lodge and his business. The Junior Deacon answers that his function is to wait on the Worshipful Master and Wardens, act as their proxy in the active duties of the lodge, and take care of the door.

As the astral body functions there, it is quite evident why it should be placed in charge of the door to the inner recesses of man's constitution. As a matter of fact, the astral body does have charge, not merely of what enters the mind, but through its direction of the involuntary functions of the body, also of what enters the physical makeup. The astral governs the whole human constitution, physical and mental, in regard to what shall enter it.

The Worshipful Master and the Wardens, as has been explained, represent the human ego, the divine soul, and the spiritual body—the trinity that survives even after the second death on the astral plane. It seems, then, that the Ancient Masons considered it the duty of the astral body to serve this higher trinity of man's constitution. That is, instead of serving the animal soul, or pandering to the physical senses, as it so commonly does, it was thought that the astral form should serve and act as proxy for

the noble, immortal part of man, and thus assist in the work of successful initiation. Likewise in the Grand Man of the skies, and in the individual birth-chart, we find Venus, the planet of love, the most useful assistant to the Sun, the Moon, and Mercury; for love is the refining influence, and lies at the foundation of all true progress.

Function of the Senior Deacon

—The Senior Deacon's place in the lodge being ascertained, the Master asks him his duties there. The Senior Deacon—Mars, and the animal soul—replies that he must wait on the Worshipful Master and Wardens, act as their proxy in the active duties of the lodge, attend to the preparation and introduction of candidates, and welcome and clothe all visiting brethren. The proper function of the animal soul, as well as that of the astral body, is to serve the higher trinity of man. Some would have it that the animal soul should be killed; but the Ancient Masons clearly held that it has a very useful function in man's constitution, and that instead of ruling the lodge, as it sometimes does, and instead of being chained and crushed, or killed as some advocate, it should be taught to serve man's immortal nature.

Certainly the animal soul prepares the candidate for its human initiation; for the soul evolving upward through mineral, vegetable, and animal is under the dominance of it and builds it up through struggle and strife. The animal soul thus developed gives the initiative to work for that which is still higher, until finally the soul is introduced through the animal kingdom, which is the preparatory stage next below, to the human plane of existence.

The welcoming and clothing of visiting brethren refers to the circumstance that while man occupies a physical body he must subsist to an extent on other forms of organic life. Man's animal soul and physical requirements demand the co-operation of these cosmic brethren, and they are welcomed as food to build up the physique of man. This organic life is itself undergoing a cycle of development, evolving toward greater perfection. But this ruthless sacrifice is not without compensation; for while these entities form the conditions necessary for the progress of the human soul, they are given additional opportunities for progression. They partake, by their association, of the qualities and experiences of the organisms they inhabit temporarily, and thus are hastened in their evolutionary development.

Function of the Secretary

—The Secretary's place in the lodge being ascertained, he is required to explain his duties there. He replies that he must observe the Worshipful Master's will and pleasure, record the proceedings of the lodge, transmit a copy of the same to the Grand Lodge if required; receive all moneys and money bills from the hands of the brethren, pay them over to the Treasurer, and take receipts for the same. The

Secretary—Jupiter, and the etheric body—should ever be ready to obey the commands of the Master, or ego. It is also the etheric body that transmits all states of consciousness from the physical to the astral form. The record of every experience of life, every thought, every sensation, every emotion, is retained in the astral body as modes of motion in astral substance. It is the etheric part of man's constitution that makes this record. And when anything thus recorded—a memory, a resolve, or an emotion—is to be brought up into the region of objective consciousness and expressed either in thought or physical action, it is through electricity (ether vibrations) that the energies constituting the astral record are transmitted to the physical, and thus to the Grand Lodge, or universe, by which man is surrounded.

The moneys and money bills represent values, and the only values in life are our attitudes toward events. Our attitude toward any given event may be constructive or destructive, and thus according to the mental attitude taken, each event is recorded in the astral body either as a credit or debit. And as every thought and emotion is accompanied by a change in the physical body, these values, either as assets or as liabilities, are actually turned over to the Treasurer, or physical body. The physical body then gives a receipt for these harmonies and discords; for in turn the condition of the physical body reacts upon the nerve currents and other portions of the etheric form.

Function of the Treasurer

—The Treasurer's place in the lodge being ascertained, he is requested by the Master to tell his duties there. His duty is to observe the Worshipful Master's will and pleasure; receive all moneys and money bills from the hands of the Secretary, keep a just and true account of the same, and pay them out by order of the Worshipful Master and the consent of the brethren. Of course the Treasurer—Saturn, and the physical body—should serve the will and pleasure of the ego. Likewise the chemical and other changes that occur in the physical body as accompaniments of all thoughts and emotions constitute a true account of the harmonies and discords—the moneys and money bills—transmitted by the etheric body. These values so received are then paid out, that is, they are transformed into mental and physical actions; for all actions depend upon what has first been received from the environment. They should be paid out, that is, action should be taken, only on orders from the ego and with the consent of the brethren. In fact, action to be effective, must have the support of all the various portions of man's complex constitution.

Function of the Junior Warden

—The business of the Junior Warden—Mercury, and the spiritual body—is said to be observing time, calling the craft from labor to refreshment, watching them through this period that they may not give way to intemperance and excess, and calling them at the right time, that the Worshipful Master may have honor, and that they may have profit and pleasure.

Man's most vital refreshment is the period of sleep. As explained in detail in Course 5, *Esoteric Psychology*, Chapter 9, the cells of the gray matter of the brain are the most effective batteries of the body. And like any electric battery if the circuit is kept closed, as it is by thinking, it tends to run down. But if, before the battery is dead, the circuit is broken, as it is in sleep, the battery recharges itself. Furthermore, in sleep the soul carries on exploration in the inner plane. And if the spiritual body has had proper growth, it will guard the consciousness from entering lower astral realms where dwell excess and dissipation; and at the proper time it will cause the consciousness, to whatever region extended, to return to the physical, and awaken to commence another day of activity on the material plane.

Function of the Senior Warden

—The duties of the Senior Warden are to assist the Worshipful Master in opening his lodge, to take care of the implements and jewels that none may be lost, to pay the craft their wages if any be due; and to see that none go away dissatisfied. The Senior Warden—Moon and divine soul—does assist the ego in its work, even as the moon assists the sun in bringing forth life on earth, or as in a birth-chart she assists him in governing the life forces. As the seat of the higher, imperishable consciousness, the divine soul has charge of the jewels and implements, that is, of man's mental and moral faculties and natural functions. Some have taught that man would be more perfect without some of his natural functions, but if the still small voice of the divine soul be heeded, she will direct that none should be misplaced or lost. The divine soul also recognizes, if its admonitions be but heeded, that there are physical necessities and spiritual necessities. It is thus able to mete out just compensation unto all, permitting no part of man's constitution to be neglected, or underpaid, but rendering unto Caesar the things that are Caesar's, and unto God the things that are God's.

Function of the Master

—The duties of the Master in the lodge are to open and adorn it and to set the craft to work with good and wholesome instructions, or to cause it to be done. As the sun is the center and controlling power of the solar system, so the ego is the inward source of power, and should be the controlling power of man. It should direct all his efforts. Through devout aspirations its promptings may be recognized. The Master adorns the lodge as the sun adorns the day, and the temple of man is glorified only when dominated by, and under the instructions of, the indwelling spiritual ego.

The Lodge Opens

—After the duties of the seven officers in the lodge have been stated the Master gives three raps with his gavel, indicating that the will is to be exercised on all three planes. He then states that in opening the lodge he forbids the use of all profane language, or any disorderly conduct whereby peace and harmony may be interrupted.

Language refers not only to man's utterances but also to his thoughts. The temple in which he dwells must not be profaned by vicious thoughts or unseemly fantasies. Constructive work in the human edifice demands only pure and elevated thinking. In this edifice there are many workmen—organs, cells, and thought-cells. Little progress can be made if there is antagonism between them. Disorderly conduct upon the part of one of these is like a small rebellion. All must perform their tasks in harmony, and in obedience to the true Master, the deific ego.

The Master, declaring it his will and pleasure that a lodge of E.A. Masons be opened for the dispatch of business asks the Senior Warden to communicate his pleasure to the Junior Warden, who gives three raps with his gavel and communicates the will of the Master to the brethren. This signifies that the dictates of the ego are transmitted through the divine soul to the spiritual body, and from thence, through the medium of astral vibrations to other sections of man's constitution. In a similar manner natal astrology teaches that the influence of the sun, ruling the individuality, is transmitted to the moon, ruling the mentality, and thence to find expression is directed by Mercury, the messenger of the gods.

The Sign of Distress

—Next, the signs of this degree are attended to. They consist of right angles, horizontals, and perpendiculars. The horizontal sign is made at the level of the neck, that part of man ruled by the feminine planet Venus, the planet of love. It is a quick horizontal motion from left to right with the five fingers open. These five open fingers indicate humanity, and the horizontal line that section of it represented by woman. At the same time as this motion, the left hand drops vertically at the side, giving the perpendicular sign. This perpendicular sign with the five open fingers represents man. The hand is then at the level of the region of the body ruled by the masculine planet Mars, the planet of desire and strife.

The horizontal and perpendicular signs thus given simultaneously indicate woman's pure and unsullied affections, represented by Venus; which have been violated by man's inconsiderate passions, represented by Mars. The result is that woman, instead of embracing, shrinks from him, as pantomimed by the due-guard or horizontal motion.

That there may be no mistaking the teachings of this degree that the nuptial union is recognized as commonly abused, it is still further portrayed in terms of universal symbolism by the right angle. This is made by holding open the left hand and crossing the palm of it with the open palm of the right hand at right angles. Here the lower, or negative, five fingers represent woman, and the superimposed, or dominant, five represent man. In astrology all the discordant aspects are portions, or multiples, of right angles. The right angle, therefore, is the universal symbol of discord; and the two hands are crossed at this angle to indicate the all too prevalent discord arising out of the nuptial union. To still further emphasize the significance of the sign, in the E.A. degree it is termed the sign of distress. This sign of distress is called the first sign of a Mason.

It would seem from this, that the Ancient Masons placed much importance upon the relations between husband and wife. Such relations might be considered, by the unthinking, to be not merely a matter which good taste forbids should be discussed; but of so little moment in the more important effort of soul development as to entirely unwarrant being given so much attention. But the Ancient Masons knew that soul development consists of transforming existing mental factors, and adding new constructive mental factors to the astral and spiritual bodies. The development of the soul to a state of Self-Conscious Immortality is the work of the Masonic candidate; and his building is not fictitious. He builds with thoughts which are vitalized by emotion. And not only does his marital partner stimulate the thoughts with which he builds, in a considerable measure, but the emotions aroused through their association build these thoughts into his finer bodies, either as harmonious, or as discordant, thought-cells.

A thought to be effective, from a magical standpoint, must be clear cut and strongly energized. The carrying power of a thought and the amount of work it can accomplish depend upon the energy associated with it. A thought which is associated with any emotion whatever has considerable ability to perform work. It has, as one might say, horsepower. A thought associated with a very strong emotion has a very high horsepower. Ordinarily, strong emotions habitually aroused are those of the nuptial relations. That is, whether man is aware of it or not, in this relation he is giving his thoughts a tremendous energy to go forth and accomplish, either constructively or destructively.

Under such circumstances, however, we have not one set of thoughts and emotions, but two. And because the astral bodies at this time tend to become fused, whatever thoughts and emotions are held by one finds unusually ready access to the astral body of the other. In other words, not only are the dynamic powers of thought raised to the highest degree, but due to their vibratory proximity, each is particularly open to receive the thoughts of the other. Thus the thoughts held at this time, more than any other thoughts that may be held—the emotions of intense religious fervor being next in dynamic strength—tend, because of their unusual dynamic strength, to build their harmonies or discords both into the astral body of the thinker and into the astral body of the other.

The Ancient Masons were well versed in magic; and here is a very real and extremely potent form of magic that husband and wife constantly, and usually unwittingly, practice on each other. If this relation, therefore, be discordant, the participating parties are practicing upon each other a very destructive form of magic. For that which is attracted from the outside world is determined by the activities of the thought-cells built into the astral form. If discordant thoughts are built into the astral body, discordant events will be attracted. Disease, financial failure, and all the evils that may befall man, may very well be attracted if through the years he forces his attentions upon an unwilling and loathing wife. Is it to be wondered, then, that the symbol of such an unfortunate state of affairs should, by the Ancient Masons, be called the sign of distress?

The laws of the land may demand that husband and wife must yield even unwillingly to the desire of the other. But such yielding, if thought has any power to heal or injure, if such a thing as mental magic exists, must inevitably bring to both a train of physical woes. And because the soul itself is built by states of consciousness—is, in fact, the sum total of the states of consciousness organized in the finer forms—such relations have a powerful influence over the soul's progress. If degrading thoughts, thoughts of loathing, thoughts that are associated in any manner with decidedly strong inharmonious emotions, are being engendered by oneself, or being received from another through such close association, the power of the soul for progress is lessened.

To remedy a fault, it must first be recognized to exist. The first sign of a Mason, therefore, is a recognition of the state and the cause of distress.

These signs being given, the Master, Senior Warden, and Junior Warden, each give one rap with the gavel; indicating that there is complete unity of the higher trinity of man's constitution in exercising the will to overcome the problems of the physical plane. The Master then declares the lodge open.

In Course 2, *Astrological Signatures*, Chapter 2, I have explained at length the Written Law and the Oral Law. The Oral Law in general is traditional knowledge, and as applied to individual man is his knowledge of natural law. The Written Law is that law written in the stars; it is in general, astronomy, and as applied to individual man is the various vibrations that reach him from celestial sources as mapped by his birth-chart and progressed chart. I mention these two laws here because both are a part of any correct Masonic lodge.

Having declared the lodge open, the Master reads from a book, representing the Oral Law, the following passages:

“Behold how good and pleasant it is for the brethren to dwell together in unity! It is like the precious ointment upon the head that ran down upon the beard, even Aaron's beard, that went down to the skirts of his garments; as the dew of Hermon, as the dew that descended upon the mountain of Zion, for there the Lord commanded the blessing, evermore. Amen. So mote it be.”

This passage following immediately after the sign of distress, which calls the attention to the cause of a great amount of misery and failure in the world, is evidently intended to call the attention to the great benefits that may be derived from harmony in marriage. And right here is a good place to emphasize that I do not find in Ancient Masonry any teaching which upholds the tendency repeatedly to divorce simply because for some reason the ideals are not at once realized. I do find that the Ancient Masons emphasized the importance of selecting a mate that is physically, mentally, and spiritually harmonious, when entering into marriage. That is, marriage was considered to be worthy of careful thought, and not to be entered into haphazard. But once the marriage took place, it seems to have been their belief that no stone should be left unturned by either to make it a successful, constructive, and harmonious union.

While there is a higher phase of marriage to be striven for, as will be noticed in detail later, the Ancient Masons did not view the physical relations between husband and wife as something abhorrent. On the contrary, while recognizing the existence of still higher phases, they taught that even the physical relation within moderation could be made an instrument of soul growth and physical construction.

In this doctrine sensualism played no part. For it was with the unconscious magic exercised by the participating parties that they were concerned, and not with physical gratification. These Ancient Masons were Master Magicians, and they recognized that even the physical relation between husband and wife, in addition to being the means by which superior offspring could be brought into the world, might also be the

means for the highest form of white magic. A thought associated with the emotion of love is the most powerful constructive agent known. The more intense the emotion the greater the volume of constructive energy with which the thought is empowered. And where there is perfect agreement and sympathy between the two, the united thoughts are energized manifold.

That such ideal conditions might obtain, according to this ancient teaching, it is first necessary that there be the utmost harmony of desire and sympathy of understanding. Little acts of consideration and kindness in the daily life prepare for this. Both should have their energies aroused to the highest degree, and both should find complete expression. And above all, each should feel toward the other the loftiest, kindest, and most sympathetic emotions. The rapport established through mutual desires, fuses the astral bodies, and as the thoughts and feelings are all harmonious, hence constructive, each builds in himself, and in the other, thought-cells in the astral form that are constructive. And because the emotions are so intense, these constructive energies are given a powerful dynamic force, entering permanently into the makeup of the astral and spiritual bodies of each, thus becoming powerful harmonious thought structures that build up the soul's power for progression, and tend to attract harmonious conditions, hence success, in the environment.

At a further stage a still higher union is advisable because the power of a thought depends not merely upon the volume of energy with which it is energized, but also upon the quality of the energy. Physical relations, although they may be emotionally spiritualized and refined to a degree, yet usually retain enough of physical desire to lower their vibratory rate. They have not, therefore, the power to produce results in the physical world, nor the power to affect the constitution of the spiritual body, that strong emotions have that spring from a still loftier plane. However, it is evident—judging from the vast literature on psychoanalysis that has recently come into existence, and the cure of so many patients by releasing their repressions—most without some training, are not ready for regeneration.

Such a harmonious marriage as has been suggested in the ritual is first referred to as ointment—which is the symbol of sanctity—being upon the head. In other words, in such a holy union the thoughts—for the head is where thinking is done—are lifted up to God and sanctified. The beard is typically an emblem of masculinity, and the priestly robe, or garment, is purposely feminine. Its enfolding form suggests woman. Aaron typifies those who have consecrated their lives to higher service, who know the law, and who enter into marriage with the object of endeavoring to assist each other evolve their divine attributes. The ointment running down upon both the beard and the skirts of the garment symbolizes the opening of the doors of the inner spaces upon such a man and woman.

The next comparison is to the dew of Hermon that descended upon the mountain of Zion. Water is the symbol of the emotions, air is the symbol of aspiration, fire is the symbol of creative energy, and earth is the symbol of practical results. Dew is the product of heat—creative energy—acting upon water—the emotions. Carried up by the air—aspirations—it is finally precipitated on the mountain of Zion; that is, yields

the very highest practical results. This dew that falls on Zion, therefore, indicates those unusual spiritual energies that are only contacted when intense love enables the soul to soar to the heights; and even as mountains are the highest portions of the earth, these energies enable work of the highest type for the benefit of mankind to be accomplished.

The ideas meant to be conveyed by the verses quoted were given in the 7th, and further explained in the 14th degree. In this system of degrees of Ancient Masonry the 7th degree revealed the mysteries of generation, the 14th degree revealed the mysteries of regeneration, and the 21st degree revealed the mysteries of the great work. David, no doubt was a high degree Mason.

Therefore, we need not be surprised to find the original of these verses to be the 133rd—1 plus 3 plus 3 equals 7—Psalm. This Psalm is The Song of Degrees, being the 14th song. The number 7 in the Hermetic System of Names and Numbers (see Course 6, *The Sacred Tarot*), relates to perfect physical union, and the number 14 to complete regeneration, as revealed by the Major Arcana of the tarot.

After the recital of the 133rd Psalm as a prayer, the Master raps once with his gavel, indicating that the will must dominate the first, or physical, plane; whereupon the members are seated.

And now, before taking up the work of a lodge after it has been opened, let us complete our brief survey of the 32 primitive ideas that form the counters of universal language by considering the numerals.

Origin of Arabic Numerals

—The Arabic numerals which we commonly employ bear a rough correspondence to cell division after the union of sperm and germ. If this resemblance is more than accidental, it may be questioned how those who originated them, without the aid of a microscope, could know about cell division. The same query arises in reference to their knowledge of the attributes of the planets Uranus, Neptune and Pluto, in the absence of telescopes. They had ESP (Extra-Sensory Perception) well enough developed accurately to describe the influence of these planets, as we now find through research. This being the case, there is no inconsistency involved in believing they might have known, through ESP, of cell division and many other things.

The fertilized cell is itself unity. But a cell possesses polarity, possesses a positive and a negative portion, this constitutes a duality; even as a duality results from the first cell division.

Now in all things possessing life there is a trinity; substance, energy, intelligence. The cell itself may well be represented by a circle; for the circle is the most perfect form, containing within its circumference the greatest possible area within a boundary of a given length. The trinity may be expressed diagrammatically by a triangle inscribed within the half circle representing the dominant polarity. Thus if

the sperm is represented, instead of the fertilized cell, the triangle will be found in the positive, or light half; while if the germ is represented, the triangle will be found in the shaded, or negative, half. Reproduction is thus seen to be the union of a positive trinity, the sperm, with a negative trinity, the germ. Where the two trines have their point of contact gives the 7th factor, 7 being perfection of form. But at this point of contact a new trinity, the offspring, is developed, which may be expressed diagrammatically as three trines, or the number 9, the highest digit, the perfect number. The new trinity of substance, energy, and intelligence may then separate itself from its parents to commence an independent cycle or existence. This cycle, or orbit, is expressed by a cypher, which enclosing the whole group as a unity, adds the thought of a new era to the whole unity, giving the number 10.

I shall not go further into these symbolic diagrams, nor shall I try to trace in detail, for they have been greatly conventionalized, the axial divisions and other processes of cell development that may have suggested to the unconscious minds of the Arabian Sages the numerals we now use. Instead I shall now consider the functions of the numbers themselves:

One

—The number One expresses the absolute, and suggests infinite possibilities. It is that from which all proceed, which contains all, and to which all finally return. It is evidently a synthesis; for nothing can be imagined not composed of parts. It represents the universal principle, the creative intelligence of Deity, that force which is the motive power of the universe and in man becomes intellect and will. In science it is the law of conservation of energy. In the macrocosm it indicates unlimited potentiality, in man it indicates relative potentiality.

Two

—The number Two expresses polarity. It suggests night and day, inhalation and exhalation, heat and cold. The most evident of all things is duality, even truth being dual, esoteric and exoteric, the real and the appearance. Two represents the universal law of sex; attraction and repulsion, love and hate, centripetal force and centrifugal force. In science it is the law that every action is accompanied by an equal and opposite reaction. In the macrocosm it is the positive and the negative; and in man it is represented by reason and intuition, and by his differentiation into the polar opposites, man and woman.

Three

—The number Three expresses the union of polar opposites. It is the reaction between forces generating vibration and change. It represents the universal agent, action, or word, and is typical of fecundity. It is the union of forces that is the basis of all life and motion. There is no such thing as freedom from change; for all existence is in motion. In science three represents the laws of dynamics, those that pertain to the generation and control of energy. In the macrocosm it is action, and in humanity it is generation.

Four

—The number Four expresses the result of action, the fruit of two interacting forces. It thus represents the practical, the concrete, that which has form and substance; hence is typical of the universal truth of reality. In science it represents the laws of statics, those that pertain to bodies at rest or in equilibrium. In the macrocosm it is the result of action; and in man it is the offspring of experience.

Five

—The number Five unites the first four digits, or principles, into a harmonious unity, and thus explains the apparent contradictions in nature. The One Principle, One Law, One Agent, and One Truth do not contradict each other, but imply each other's existence. These four factors are pictured in the sky by the four animals that symbolize the four quadrants of the zodiac. All were synthesized as a fifth in the ancient four fold sphinx; which explains all nature to converge in man. Man has passed through the four elemental realms of life, has triumphed over all submundane degrees of existence, and by virtue of his spiritual supremacy gained their allegiance as obedient servitors. Man, symbolized by five, maintains his health when his magnetic forces are radiated equally by each of the five main points of projection: the hands, feet, and head. In man, and as composed of one and four, it represents the realization that is the outcome of intelligently directed willpower. In the macrocosm, and as composed of two and three, it signifies polarity in action.

Six

—The number Six signifies two actions: two times three. But as such it does not represent forces in equilibrium, but forces in a state of vacillation, in a state of action and reaction. It is thus typical of virtue that may be misapplied. As such it signifies weakness and indecision, hesitancy and timidity. As composed of two and four it signifies the realization of polarity. As composed of one and five it represents man dominated by the will of another. In the macrocosm six is force uncontrolled, and in man it is temptation.

Seven

—The number Seven as composed of three and four expresses action and realization, and is thus the number of completion of form. Things on the physical plane which have perfection of form are constituted of three active elements and four passive, or formative elements. Seven as composed of two and five signifies man having within his power the law of polarity. As composed of one and six, it signifies indecision overcome, and hitherto uncontrolled forces dominated by intelligent will. As composed of twice three plus one it denotes body, soul, and spirit, united to body, soul, and spirit, guided by intelligence and controlled by will. In the macrocosm it indicates the seven principles of nature, and in man those whom, “God hath joined together,” as well as the dominion of intelligence over action, hence victory over temptation.

Eight

—The number Eight as composed of two fours expresses two opposite realizations, hence equilibrium, crystallization, stagnation, and possibly death. It is thus the antithesis of progress. It is ultra-conservatism. As composed of three and five it represents man succumbing to action. As composed of two and six it signifies temptation polarized. As consisting of seven and one it denotes the victory over intelligence and will. In the macrocosm eight is the number of inertia, in man it is the number of justice, and also the number of dissolution.

Nine

—The number Nine is the Deific number. It is the highest digit, and has many unusual properties. Thus it may be multiplied by any number and the digits repeatedly added together will give 9 as their sum. All numbers above 9, in their last analysis, consist of a root number to which multiples of nine have been added, this root number being always the sum of the digits repeatedly added together. Because of its extraordinary properties, nine was held sacred by the ancients, and is the key by which all their cryptic cycles may be unlocked. As composed of five and four it signifies man realizing all that earth can teach. As consisting of three and six it indicates temptation overcome by action. As composed of two and seven it indicates intuition and reason added to perfectly united body, soul, and spirit with body, soul, and spirit. As being one and eight it signifies that inertia has been overcome by intelligently directed will. In the macrocosm it signifies, by being three times three, action on all three planes, and in man it becomes the number of wisdom.

Ten

—The number Ten expresses the same as number one, except that a cypher, symbolizing a complete cycle, has been added. It therefore shows that one round of experience has been completed, and that another cycle of experience is being commenced. Vibrations on the inner plane repeat their chief characteristics in decaves, instead of in octaves. One shows infinite possibilities only, nine shows that all the possibilities of one plane have been experienced, and ten indicates the transition to a new plane where other possibilities await. Ten, then, in the macrocosm indicates the commencement of a new cycle, and in man, as composed of two fives, it indicates man and woman together, humanity at large.

Chapter 5

Serial No. 10
Original Copyright 1938
Elbert Benjamine

Copyright
Church of Light
August 2002

Initiating a Member

Chapter 5

Initiating a Member



SINCE THE DAY when the spiritual children of the Golden Age, wandering in an earthly paradise were instructed in the arcane laws of life by visitants from celestial worlds, even down to present-day orthodoxy with its fantastic and misunderstood ritual, the Mysteries have been conducted in every land and clime. Their primary object has ever been the same: to impress upon the soul the vital truths of man's past history and future destiny. Their rightful purpose is to enlighten the participant concerning his divine source, the nature of his deific attributes and potentialities, the sublime angelic goal toward which he struggles, and the manner in which he best can hasten his journey to the heights, and thus, no longer bound and shackled by sense and environment, come into full possession of his spiritual heritage.

The ease with which a thing can be remembered depends upon its associations and the vividness of its impression; a psychological law that ever has been made use of to implant important truths indelibly in the mind of the candidate. In the first place, the difficulty of obtaining permission to undergo initiation conveys the impression that something of tremendous importance is to be revealed in the Mysteries, an impression subsequently strengthened by the administration of terrible vows and the acceptance of solemn obligations. Then, with the initiation under way, the situations are so intense, often terrifying, that their impress is left graven unerasably upon the tablets of the memory. Thus did the ancients as well as moderns perpetuate their ideas in never-to-be-forgotten symbolism.

Those whose physical natures were dominant and whose inner perceptions were yet latent had this symbolism seared on their minds with such vividness as easily to be recalled and meditated upon at will. Thus the meaning would filter through from the inner spaces as their soul powers slowly unfolded. To others, of a more sensitive nature, the stress of the trials, and the mystery surrounding the ritual, frequently produced a psychic awakening in which there was true illumination. In this higher consciousness the full meaning and spiritual purport of each symbol was clearly recognized, and their more acute perceptions opened to them new worlds and a realm of undreamed of possibilities.

Now Modern Masonry, no less than Ancient Masonry, explains by its symbolic ritual that the soul descended from a spiritual Eden into material conditions of toil and suffering for the sake of experience. Only through experience are Love, Wisdom, and Self-Consciousness acquired; and only through the conscious application of love, guided by wisdom, is the soul able to win its way homeward again to realms of infinite light, a self-conscious, immortal being. There, in full possession of matured Wisdom and realized Love, it becomes an Angel of the Blest, a Deific Being, the arbiter and creator of a future universe. Such is the glorious destiny of man as taught by seers and sages and as revealed by the ritual of Ancient Masonry.

Each Soul Is Responsible for Its Own Destiny

—Though man is now a pilgrim in a vale of tears, far from his native land, besieged by perils and hampered by a thousand difficulties, the road to redemption lies straight ahead. Not salvation by the sacrifice of others! Not a vicarious atonement! Not by the blood of the innocent! No! Such is not the message of Ancient Masonry handed down through a million generations. Instead, it teaches the sacrifice of man's animal nature on the altar of love's devotion, the consecration of the lamb, or creative principle, to a nobler purpose; to the purpose of building an enduring temple for King Sol, the indwelling Ego. Such sacrifices alone enable man to atone for past mistakes, and thus attain salvation, a salvation which frees him from blind fatality and the restrictions of matter.

Ancient Masonry teaches that each soul is a responsible entity working out its own deliverance from a voluntary and purposeful incarceration in matter. Freedom can be obtained only through knowledge of the laws of nature, and conformity in thought and deed to them. It is the exemplification of these laws relating to the development of the body, intellect, and soul, that constitutes the paramount message of Ancient Masonry to the Twentieth Century world. Those who in the long forgotten past learned in the Mysteries who and what man really is, and the sublime height to which he may attain, bethought themselves of other souls that in the future would attempt to climb the same rugged path their feet had trod. When they gained one victory after another in the struggle for mastery, finally attaining freedom, they therefore left an outline of the work to be done, of methods to be used in surmounting obstacles, of laws to be obeyed in order to triumph. This outline of incomparable value is the ritual of Masonry.

The candidate seeking admittance is called upon to state that his desire for the rites of initiation is entirely voluntary, free from compulsion, and actuated by a favorable opinion of the institution. Now in the Bible story, the serpent in the Garden of Eden represents the wisdom which tempts the soul to leave its spiritual paradise and descend into matter. The soul realizes that only through partaking of the fruit of good

and evil, partaking of material experiences, can it develop self-consciousness. This fruit of its experiences in relative conditions brings to it life, wisdom, and love. The candidate, therefore, by his statement of voluntary choice, indicates that the soul, when entering the Cycle of Necessity which constitutes its initiation, is not under compulsion, but acts through the desire to reap the benefit of material incarnation.

Furthermore, the soul entering upon this cyclic pilgrimage, must abide by the laws of nature, even though at times this means toil and suffering. Such is indicated by the candidate's declaration that he promises to conform to all the ancient and established usages and customs of the Fraternity.

The black and white balls used in balloting to determine if the candidate is acceptable represent the soul's experiences in material environment preceding its birth into human form; for before the human state is reached the unconscious mind must traverse the whole scale of life from mineral upward, subjecting each in turn. Through the dual powers of attraction, represented by white balls, and repulsion, represented by black balls, it evolves through all the lower forms of life, in each progressive organism annexing to its domain the attributes and functions inherent to that state. Consequently, in the supreme form of man the scale of life is complete, and he has within his own constitution all types of life, forms, powers, and functions, expressed upon the planet earth, and likewise the germs of every state in the infinite realms above.

Having conquered all states below the human, by the law of affinity he is drawn into the fiery vortex of his parents during their union. The particular soul whose need for expression most closely corresponds to the polarity and spiritual state of the parents becomes magnetically attached to the ovum of the mother. One or more black balls among the white ones indicates the affinity at the time considered is insufficient to make incarnation possible; but if the ballot is clear, it indicates that no strong repulsive forces are present, and that conception takes place.

The ballot boxes are passed by the two Deacons, representing Venus and Mars, the planets of love and passion, of attraction and repulsion. It is the vibrations of love and passion that attract the soul to its future parents. The ballot box is passed three times to indicate that the vibrations making conception possible may spring from one or more of three distinct planes. When vibrations from one plane preponderate a soul of a very different character is attracted than if the vibrations are chiefly those of another plane.

If the union is purely physical, the interplay of animal magnetism attracts a soul whose need for expression is largely physical. If in the union there is love based on mutual admiration, trust, esteem, and kindred mental qualities, a higher type of entity will be drawn into the magnetic current. And should there be marked harmony between the parents on all three planes, engendering soul love as well as magnetic

affinity and mutual mental interests, the conditions will be fulfilled for bringing into the world the highest type of mental and moral genius, endowed with a physique capable of sustaining him in his untiring efforts for the benefit of mankind. From such unions have sprung the noble philosophers, the inspired reformers, and the truly great men of all times.

Significance of the Manner in Which the Candidate Is Clothed

—When the candidate has been accepted he is led into a small room adjoining the main lodge, where he is prepared by the Senior Deacon for his entrance into the lodgeroom proper. This small room, or ante-chamber, represents the womb of woman, where each soul ushered into mundane existence is prepared for its final earthly initiation. During the period of gestation the fetus briefly passes through the various stages that correspond to the lower forms of life by which it has ascended to its present estate, lastly, of course, having passed through and subjected the realms of animal life. As the Senior Deacon represents the animal soul, the organization of which in the animal kingdom paved the way to incarnation in human form, we find him rightly chosen as the one to prepare the candidate for human experience, to lead him symbolically through the avenue of physical birth into the realm of self-consciousness.

The animal soul, corresponding to the Senior Deacon, supervises the various automatic functions of the body. Thus it is that the heart beats, the lungs breathe, and the processes of digestion, assimilation, and secretion are carried on, largely independent of conscious thought and direction. When conception takes place, it is also the animal soul that directs the building of the embryo, the clothing with a material form the soul soon to see in human form the light of day. Therefore, in the ante-chamber of the lodge, first making him remove all his garments but his shirt, the candidate is clothed by the Senior Deacon.

Covering the upper portion of his body, and thus representing the astral form in which the soul functions just before incarnation, the shirt is not removed. The astral form, whether in or out of matter, covers the soul through all the various transformations by which it scales the cyclic rounds of evolutionary life on earth.

His lower garments are removed, and in their stead he is clad in red flannel drawers. Flannel is made from the wool of sheep, and is therefore under the dominion of the astrological sign Aries. Aries is the sign of creative energy, and when the Ancient Masons wished to denote virility, they used as symbol a sheep, a ram, a lamb, or some garment made from them. Aries rules the head of man, and thus signifies mental creative energy as well as that physical, but in this instance the color is red, denoting blood, lust, and carnal desires; the physical aspect of the planet Mars. The shirt,

which the candidate still wears, indicates that the soul has not evolved high enough to be free from its astral body. It is still bound and limited by an astral raiment largely organized by the grosser desires and impulses of the animal realms through which it has just ascended; the red drawers indicating animal passion and the use of creative energy for sensual gratification.

To represent the soul's inability to see and comprehend either physical facts or spiritual truths when first born into human form, the candidate is blindfolded. This condition is also typical of the masses of humanity who have no knowledge either of physical science or of esoteric wisdom. They grope through life swayed by every wind that blows, accepting as fact the assertions of others who pose as repositories of wisdom, yet who are as destitute of the true light as they themselves.

Such understanding as they have is negative, based upon the authority of others. This is symbolized by the left, or negative foot alone being unshod, free for action, while the right is hampered by a shoe made from the skin of an animal. Right understanding is as yet restricted by, immersed in, the animal propensities. In this stage of development, as well as at birth, man's emotions and aspirations spring from material motives. This is shown by the candidate's left breast being bare. Furthermore, man's works at this stage are executed upon the physical plane. This is signified by one arm being hampered by clothing, while the left, or negative arm, to be free to work, is left bare.

Now the ego, or spiritual potentiality, is incapable of descending into material conditions, which the soul alone can enter; but at all times there is a faint vibratory line of communication between the two. Thus the soul is vitalized and sustained, receiving energy from the ego to enable it ever to struggle upward. This line of rapport, by which the soul at all times is connected with the ego, is represented by the cable-tow.

This cable-tow is placed around the neck and left arm of the candidate. The neck is ruled by Venus, the planet of love. The cable-tow placed around the neck, therefore, points to the power of affection to strengthen the line of communication between the soul and ego. The arm is the agent of service, and the cable-tow around the left arm indicates the paramount value, as an agent for strengthening the bond between soul and ego, of being of greatest possible service to others on the physical plane. The power of love to lead the soul from the lower to the higher is further emphasized; for it is the duty of the Junior Deacon, representing Venus, the planet of love, to lead the candidate to the door of the lodge.

As the candidate enters the lodge, the Senior Deacon, representing Mars, the planet of strife, presses a compass in a painful manner against his naked left breast. The mother's love for her unborn child conducts it up to the period of parturition, where stern and cruel Mars takes charge of affairs. In so far as the higher laws of life have been violated by passion and sensualism, in that much does the offspring inherit a body and mind tortured by emotions and desires that conflict with those laws. It is

only when man's desires are not contrary to the spiritual laws of his being that he is able to escape misery and suffering, sickness and failure, and the thousand and one ills to which the flesh is heir. The higher laws are represented by the compass, and the purely physical desires and emotions that sometimes conflict with these laws to cause suffering are symbolized by the left breast.

Inside the lodge the candidate kneels while a prayer to the Father of the universe is offered asking that his life may be consecrated to service, and that wisdom may come to him. When asked in whom he places his trust, he answers: "In God." It is only when the neophyte consecrates his life to Deity and places his faith in divine providence that he may expect the assistance of unseen helpers who will conduct his initiation and will lead him to the light. Man's inward yearning for something higher than the purely physical, his devout aspirations and unselfish resolutions, are prayers that ascend to the upper spheres and attract forces and intelligences that unknown to himself lead him to the fulfillment of his hopes. It has been truly said that nothing is impossible to a good and determined man; for faith is the avenue to the soul world.

The candidate is led three times around the room while the Master reads the 133rd Psalm, which has already been explained. This indicates that man must evolve through three planes: the physical, the astral and the spiritual. The Junior Warden represents the spiritual body. Therefore, to convey the thought that on the third, or spiritual plane, man functions in a spiritual body, the candidate is halted in front of the Junior Warden. Furthermore, as the Senior Warden represents the divine soul, and the Master represents the ego, both of which are also present on the spiritual plane, he is next led to the Senior Warden and finally, as representing the most interior of all, to the Master.

The Master demands to know from whence he comes and whither he travels. To which he replies that he comes from the west and travels to the east in search of light. The answer is entirely correct; for the west, astrologically considered, is feminine, and thus symbolizes matter, while the east is masculine, and symbolizes spirit. The soul involved from spirit into matter, but is now on the ascending arc, evolving from matter to spirit. It therefore is traveling eastward, toward the source of light, toward spirituality.

The First Step Toward the Light

—Spirituality, however, is not gained by haphazard effort. Its attainment requires systematic endeavor based upon a full understanding of just what is sought and the various steps by which it may be reached. The candidate, therefore, is next instructed in the proper manner of approaching the east. He is taken back to the west, or material plane, and caused to advance by one upright regular step, to the first step, his feet forming the right angle of an oblong square, his body erect at the altar.

This oblong square is made by the candidate stepping forward with his left foot and drawing the heel of the right foot into the hollow of it, making the feet stand at right angles. The feet symbolize understanding, and thus placed represent the union of male and female. The upright body symbolizes will. The first step toward the light, therefore, according to the Ancient Masons, is the will to understand the mysteries of generation. This symbolic attitude implies that man should always keep his desires and passions under the control of a resolute will. He should never be inconsiderate of the finer feelings and delicate sensitiveness of woman, should never force unwelcome attentions upon her, but permit her to abide her own pleasure; for in forming the oblong square it is the left, or feminine foot, that makes the first advance.

The teachings of the Ancient Masons in this respect, as revealed by symbolism, seem to be this: They regarded marriage as a sacred institution, in which man and woman should assist each other through arousing tender and sympathetic emotions, noble aspirations, and spiritual ideals. Undue aggressiveness on the part of either is sure to defeat this end, because love is not subject to demand, but must be won. The man who forces attentions upon a woman, even though she be his wife, quickly turns affection into disgust and love into loathing. Nor should the woman who, as soon as the legal knot is tied, ceases to put forth an effort to retain the love and admiration of her husband, expect to arouse in him those higher feelings and emotions that give to marriage its constructive power.

Love thrives upon kindness and tender consideration. Little attentions, thoughtfulness for the welfare of the other, and sympathetic understanding, tend to sustain the warmth of affection between man and wife. Unless the desire for marriage is mutual there is no fusion of the magnetic forces, and the energies set in motion by one, meeting with no energies of opposite polarity with which to blend, act as unbalanced forces that set up discords within the astral constitution. But when desires are mutual, and the energies aroused are of approximately equal intensity, finding complete expression by each, there is a fusion of forces that sets up harmonies within the astral constitution, and these have great constructive power.

Perhaps it should be emphasized, as the symbolism indicates such emphasis, that both should find complete expression if the energies set in motion are to conduce to health, happiness, and attainment. But such emphasis may be found in much detail in the works on psychoanalysis in which the pathological condition that may arise from such lack of expression is termed the incompleteness complex. The advantage of marriage, from a purely physical standpoint, may also be left to the vital statisticians; who show that spinsters are much more subject to disease than married women, and that bachelors are markedly less long lived than married men.

That magnetic forces, then, may act constructively, and not destructively, it is necessary that there should be kindred feelings which establish a rapport between husband and wife. Through this rapport there is an exchange of energies, and a complete blend that causes the forces to act, not divergently, but in unison. This principle—that there must be unity of desires, unity of thought, and unity of emotions—according to Ancient Masonry, is important not alone on the physical plane of endeavor, but also on the plane of purely mental union and the plane of purely spiritual marriage.

Aside from this unity, the grade of feeling aroused is the important thing. Like attracts like. If thoughts are high, if the heart is filled with pure love and sacred devotion, if the soul outpours in tender blessings, invisible energies are attracted of like quality. They are attracted at such times even more readily than at any other; because when the soul is aroused to great intensity it contacts more fully the inner worlds. The intensity that has the power to contact the astral and draw a soul and provide for its incarnation is an intensity that at the time places the person directly in touch with astral forces. If the thoughts be evil, evil energies are attracted; but if the thoughts be noble, and the aspirations lofty, the higher spheres are contacted and the energies attracted are spiritually constructive.

Jachin and Boaz are United by Electromagnetic Boundary-Line Energy

—The two pillars, Jachin and Boaz, one at the right and the other at the left of the great Eastern Gateway, divide the zodiac, even as the earth is divided into two polarities. Extending from one polarity on the earth to the other are lines of force, constituting a magnetic field, which exerts the commonly observed influence upon the needle of a compass.

Likewise between Jachin and Boaz, when they are considered as the inner plane and the outer plane—as well as between man and woman—there are lines of force and exchanges of energy. And the character of these energies—their trend and rate of vibration—are pronouncedly influenced by the relations between husband and wife, as set forth to the candidate in the symbolism of his FIRST STEP TOWARD THE LIGHT.

Whether or not Einstein's General Theory of Relativity is correct in other particulars need not here concern us. But according to that theory, and according to theories of other scientists, the ordinary ideas about time, space and gravitation are applicable to things which move with the more commonly observed velocities; but when the velocity of light is approached, the classical laws of gravitation no longer apply, space no longer has the relations commonly assigned to it, and time slows down.

In reference to time having different characteristics on the inner plane (the structure and vibrations of which are fully explained in Course 1, *Laws of Occultism*), on April 25 of this year (1938) experiments were described to the National Academy of Science at Washington, which are supposed to prove the reality of the ether (which we term the BOUNDARY-LINE SUBSTANCE) and to verify the assumption of Einstein's Theory of Relativity that time slows down as high velocities are acquired. The experiments were conducted by Dr. Herbert E. Ives. To quote from the report:

The newest (experiment), concerning one of the great mysteries of science, involved timing events in a vacuum tube. It showed that a moving clock keeps slower time than one standing still. It gave an inkling to the nature of 'ether' as probably a sea of energy, stationary and filling all known space.

In considering the realms of Jachin and Boaz it should be kept in mind that time relations, conditions affecting space, and the influence of gravitation which so commonly limit activity on the outer plane of Boaz, do not thus limit activity and the range of perception and consciousness on the inner plane of Jachin; and that the only communication which can be established between the two planes is through utilizing the BOUNDARY-LINE ENERGY which has a velocity similar to that of light.

As the soul of man is an organization on the inner plane, while man is on the earth he can affect it in any way only through utilizing the boundary-line energy. This boundary-line energy is generated by the cells of the physical body. These constitute miniature electric batteries, of which the nerve cells are most potent. It is utilized as the nerve currents which direct the physical activity, and as the energy which enables all types of objective thinking. Through this boundary-line energy thought and states of consciousness experienced on the physical plane build the structure of the soul on the inner plane.

Emotion of any kind is due to the presence of an unusual amount of this boundary-line electrical energy in the nervous system. It is this excess of boundary-line energy which enables certain experiences of life so powerfully to impress themselves upon the unconscious mind (which occupies the inner plane) that they form complexes, fixations, or other mental difficulties. And it is through an excess of this boundary-line energy that the inner plane is consciously contacted either negatively or positively; negatively if the potential is low, and positively if the potential is high and thus subject to the individual's control.

As in affectional relations of any type there is also generated an excess of this boundary-line energy, the thoughts and emotions then present in the mind, or during the period in which electromagnetic forces are present in unusual volume, have a tremendous power to cross from the plane of Boaz to the plane of Jachin and do work there. That is, they then, because of the volume of boundary-line energy available for their use, become powerful agents to build or destroy.

They enable the level of the astral plane to be contacted which corresponds to the thoughts with which they are charged at the time. And not only does this enable the intelligence of this level to be contacted, but there is indrawn, to feed the soul, substance of that vibratory level.

Nutrition on the Inner Plane

—On the physical plane we partake of food by eating. About 72 percent of all protoplasm, however, is oxygen, a large portion of which is partaken of through breathing. We partake of food through breathing quite as truly as through eating; and as a relative measure of the importance of the two methods of food gaining it is known that we can go without eating or drinking considerable time, but can only survive a short time without breathing. On the higher astral, and on the spiritual plane, man no longer must eat organic substance to live, he no longer eats his fellows—for even plants are his lowly kin. In these higher realms he is nourished entirely through a process similar to breathing.

Furthermore, even while yet occupying a physical body, his astral body to some extent, and his spiritual body entirely, is nourished by a process similar to breathing. Every mental state adds its energies to the astral body. Every mental state also has an attractive power. Deep thought, or depressive thoughts, cause a person on the physical plane markedly to lessen his breathing. Surprise, good news, or excitement causes a person to take a deep breath, or to breathe deeply. Acting on principles not dissimilar, every emotion, every mental state, affects the breathing on the inner plane. It affects it not merely as to quantity, but also as to quality. The refinement of the substance built into the astral body depends upon the refinement of the thoughts and feelings. And it is only when the feelings and emotions are up to a certain refinement that they can influence spiritual substance in any way. But if the emotions are intense, and at the same time lofty, tender, and unselfish, as they are when true refined love is in the ascendant, they cause a respiration of spiritual substance. They contact this inner plane and draw to the spiritual body spiritual nourishment which builds up and strengthens it. Lofty, noble, tender, aspiring emotions build up the spiritual form by supplying it with spiritual food.

Possessing an understanding of the mysteries of generation, and keeping his desires under the control of a resolute will, the next step of the candidate symbolizes wedlock. It is made before the altar, to indicate that of all the acts possible to man, this is the most holy, sacred, and ennobling, when actuated by love, and its inner laws are obeyed. It is then that the inner spaces open and the germs of divine power are contacted. This is the mystery of the Holy Shekinah, so carefully guarded by the Jewish Kabalists. The candidate steps off with his right foot, and kneels on his left knee, the knees forming right angles. This position gives the appearance of a hollow square, or room, above which the body is virtually perpendicular. He then places his left hand, palm up, under the Holy Bible, and his right hand on the compass and square that are on the Bible. In this position he is required to take the oath.

The Bible is the “Oral Law,” the compass and square symbolize the “Written Law,” and the position of his hands symbolize union. His attitude before the altar signifies his willingness to sacrifice his lower nature to the higher self. Symbolically, he thus swears strictly to obey both the spiritual laws and the physical laws of generation; and in token of his sincerity he is required to kiss the book twice.

As the result of obedience to these laws, and the realization of the higher love, his soul aspires to wisdom and awakens to a knowledge of higher truths. This aspiration and knowledge draw to him those who are able further to enlighten him. To indicate this, the brethren clap their hands and stamp their feet on the floor, whereupon the bandage drops from his eyes. The clapping of hands signifies the work of those who strive to spread the light, the stamping of feet signifies their understanding, and the bandage dropping from the eyes indicates the illumination that results from noble sentiments inspired by pure love.

When love has removed the scales from his eyes the candidate perceives Three Great Lights which are revealed by Three Lesser Lights. The Three Great Lights of Masonry, so the Master explains to him, are the Holy Bible, the Square, and the Compass. The Bible, or Oral Law, contains in its symbolism the knowledge gained by investigating nature’s laws in the remote past. The Compass and Square, or written Law, represent the actual forces of nature. The square relates to the physical world, to the realm of effects, and the compass relates to the inner planes, the realm of causes. Together they embrace all natural law, and exemplify the Hermetic Axiom: “As it is above, so it is below.”

The Three Lesser Lights of Masonry are three burning tapers placed on candlesticks, standing in a triangular group. They typify man’s reason, his physical senses, and his psychic senses. Man perceives with his physical senses the physical universe. With his psychic senses he perceives the inner worlds. With his reason he gathers together the separate strands of experience, outer and inner, and thus gains knowledge of both exoteric and esoteric law. He can both read the records left in books by men, and read the records left in the astral world, as well as make independent investigation.

In the universal temple the three greater lights are the Sun, Moon, and Venus; and the three lesser lights are their corresponding qualities of Life, Light, and Love, that give purpose to existence, serve as beacons to light the pilgrim on his lonely way, and beckon him encouragingly to struggle ever upward.

The grip of an E.A. Mason is a pressure of the thumb at the base of the other’s index finger. In palmistry the thumb denotes power of will. The base of the first finger is ruled by the planet Jupiter, as are also the phrenological faculties of veneration, benevolence, hope, spirituality, and those impulses that spring from generosity and the feeling of good fellowship. When, then, the Master says, “I now present you my right hand in token of friendship and brotherly love,” he indicates the paramount importance of unselfishness and good will in spiritual attainment. The grip symbolizes the will to be kind and benevolent. Its name is Boaz, and in naming it the word is halved, the candidate saying the letters “B-O,” and the Master saying, “A-Z.”

Boaz is the left hand pillar of the porch of Solomon's Temple. In the cosmic lodge it typifies the southern half of the ecliptic; for when the sun enters this half the nights are longer than the days and winter gains victory over summer. In humanity, Boaz represents the formative powers of woman; in the individual man it represents his left side and his negative attributes. Even as man and woman each contain within themselves both positive and negative qualities, so each half of the ecliptic contains a positive and a negative season, the two being divided by the solstice. Thus the signs Libra, Scorpio, and Sagittarius, belong to B-O, and Capricorn, Aquarius, and Pisces, to A-Z.

Around the Zodiac Through Boaz and Jachin

—Now as the sun, typifying the soul, reaches the sixth sign, which is an earthy sign, or six pots of stone, it turns, by means of the vineyard, water into wine. Wine is symbolic of the creative energy of the Lamb, but as the sun is in the sign of the Virgin and at the commencement of the feminine season, it here must symbolize the creative function particularly of woman. The cross upon which the sun is crucified is that where summer and winter meet, the cross of Libra where the sun crosses the celestial equator. By this crucifixion the sun is drawn down into the signs of winter, even as the soul is drawn from a spiritual state into matter, thus entering the region of Boaz. Consequently, the wine pressed in autumn from the grape, and the blood flowing from wounds of a crucified sun as his forces wane, both express the redemptive power of woman's creative periods which make possible the weaving of a material garment, or shroud, for the incarnating soul.

The sun reaches its lowest point, or place of the soul's birth into matter, at the time it enters the earthy sign Capricorn, thus being born in the manger of the goat. Capricorn is ruled by the planet Saturn, therefore, he is persecuted by the ruler of the country, by Herod. Egypt is the land of darkness and privation, and this is the time of year marked by dearth and famine, hence the sun flees into Egypt. Nevertheless, the twelfth day after birth at Christmas, the sun may be perceived to be gaining in power. This twelfth day is called the Epiphany, meaning appearance; and so we learn that the Christos, when twelve years old, put in an appearance at the temple and manifested his true character. During the remainder of his youth, due to the clouds that obscure the sky at this time of year, although gradually conquering this region of sin as he moves northward, he is lost to view.

By the Hermetic System of Astrology, one day's movement in the sky measures out the influence for one year in the life of man. The sun's movement through the 30 degrees of Capricorn equals thirty years of life—thirty years of age before it enters the sign of the Man, Aquarius. From the urn of Aquarius flow forth the baptismal rains of winter that melt the snow and ice and purify the earth; and as soon as the sun is thirty degrees of age, the baptism takes place. Furthermore, as soon as he has left

the sign of Satan behind him—the sign Capricorn—we find him tempted, but saying; “Get thee behind me Satan.” In Aquarius, the sign of wisdom, of knowledge of good and evil, his true work begins. The emotions—shown by the water from the Aquarian urn—lifts his soul to a spiritual baptism, and the Holy Ghost descends in the form of a dove, sacred to Venus the planet of love, and lights upon him.

As the result of wisdom and inspiration, intuition and reason, the personal love engendered in Aquarius expands as the sun moves northward toward the region of Jachin, or spirit, until it becomes the teaching of brotherly love, or love for all mankind, the utopian ideal of the sign Pisces. From this sign of the fish, then, he draws his disciples to become anglers of men.

After delivering to the world his spiritual message, as indicated by light predominating over darkness, the days being longer than the nights while the sun is in the northern half of the zodiac, the sun again approaches the autumnal cross to enter Boaz. Judas is there, represented by the sign of death, Scorpio, thirty degrees—thirty pieces of silver—from the cross of Libra. After the crucifixion the sun descends into the tomb of Capricorn, the lowest point in its cycle, where it enters this earthy sign. At this point, which is the winter solstice, the sun in so far as north and south movement is concerned apparently is stationary. But after three days in the tomb, the stone is rolled away by the angel of the Lord—the angle of the Law—in this case the southern angle of the ecliptic. His ascension into the spiritual region of Jachin, into the summer zodiacal signs, takes place on Easter, which is the first Sunday after the First Full Moon after the sun crosses the vernal equinox.

Man immersed in frigid materialism has as little genial warmth as the sun after it dies on the autumnal cross. To be rejuvenated he must experience a higher love, a higher union, even as the sun is resurrected and rejuvenated on the rosy cross of the vernal equinox. Union, like that of the autumnal equinox, may result in death and destruction, the icy selfishness of winter; or, like that of the vernal cross, bring warmth, affection, and the blush of dawn of a new era. The sun, resurrected by the virile powers of the Lamb, or Aries, typifies the soul drawn by pure affections from material winter into Jachin, the realm of spirituality. The true ascension does not take place in the case of the sun, however, without the assistance of the moon, for Easter depends upon Full Moon. Likewise, the noblest efforts and highest ideals of man depend upon the refining influence of woman, and he ascends into the truly spiritual realms only with her co-operation.

As to the word Boaz, we find in the tarot that the letter “B” is “The Gate to the Sanctuary,” and the letter “O” is “The Lightning Struck Tower.” The former pictures a woman at the gate to the holy of holies, and the latter indicates the destructive use of the creative forces. The letter “A” is “The Magus,” typical of intelligence and will; and the letter “Z” is “The Chariot of Triumph,” illustrating victory over temptation and sovereignty of mind over matter.

The letters thus represent the progress of the sun through the negative half of the year, first descending into darkness, and later ascending in triumph over it. They also sign-board the way by which the discerning may triumph over physical limitations and reach spiritual illumination.

Significance of the Lamb-Skin Apron

—The candidate is told that the lamb-skin apron has been worn by the great men of earth; and as typifying the virility that must sustain all worthy effort this is undoubtedly true. It is said to be more ancient than the Golden Fleece or the Roman Eagle, and more honorable than the Star and Garter. The Golden Fleece is symbol of the sun's virile powers in the sign of the Ram. The Roman Eagle is symbol of the sun's fruitfulness in the sign Scorpio; for the eagle is one symbol used for this zodiacal sign of sex. The five-pointed star typifies intelligent man. The garter, upon which the Star and Garter order is founded, was originally a girder used by women at their creative periods. The order thus honors woman's power to mold the destiny of the human race, and consecrates itself to use its creative energies intelligently.

The shape of the apron is a square surmounted by a triangle. The lower portion is the passive square, Boaz, typifying the four elemental realms, the four lower sections of man's constitution, the formative powers of woman, and matter as distinct from spirit. The trine above, with its point tapering toward heaven, symbolizes the active Jachin, typical of the higher trinity of man's constitution, the creative attribute of man, spirit as distinct from matter, and the divine fire of heaven.

The strings of the apron tied about the candidate's waist, the region ruled by the sign Libra; corresponding to the autumnal cross, divides his body into two halves as the zodiac is divided by the equinoctial colure. The portion of the body below the waist is ruled by those signs in which the sun is found in winter. The body also naturally is divided into right and left halves, this dividing line corresponding to the solstitial colure, which divides both Jachin and Boaz into positive and negative portions. The apron strings crossing this vertical division divide the body into four sections. The candidate thus accurately represents the universe above divided into the four quadrants that give rise to the four seasons. The apron, a trine above and a square below, or a full complement of seven, symbolizes the seven planets which move ceaselessly through the four quadrants of heaven. The point of the apron, representing the sun, is worn exactly over the solar, or sun, plexus.

In this degree, typical of the material plane of effort, the square only covers the region of Scorpio. This indicates that the creative energy is expended on the physical plane. The rapport between body, soul, and spirit, therefore, is imperfect, and the higher trinity of man's constitution has but little influence over the lower quaternary. The raising of the creative forces to a higher plane of expression, the process of

regeneration, is indicated by turning up one corner of the apron. To indicate that the forces have been so completely spiritualized that the lower quaternary is completely controlled and directed by the higher trinity, the flap of the apron is permitted to fall down over the square. This signifies that the ego manifests completely through the body.

The Candidate Tries to Borrow Money

—In concluding the initiation the candidate is asked for a piece of money, or for something metallic. As he has nothing of the kind with him he tries, but in vain, to borrow. Money represents value, but to the soul the thing of value is wisdom. Knowledge is earned through experience. Man is born into the world in ignorance, and by his own efforts he must earn wisdom. He cannot borrow wisdom from another nor can another learn his lessons for him. Experiences on the physical plane are of various kinds, and even as metal is of more value than common earth, so are certain experiences, symbolized by metal, of higher quality and greater value than others. These finer experiences, though still of the physical plane, are not to be slighted, for they are necessary steps in progression.

By the same symbol is also conveyed the information that knowledge of the higher mysteries can never be purchased for material considerations. The candidate's effort to purchase his way into initiation fails, as it must always fail; for the real truths of nature are revealed only to the worthy, and without price.

“Knock and it will be opened unto you.”

Chapter 6

Serial No. 11
Original Copyright 1938
Elbert Benjamine

Copyright
Church of Light
August 2002

Fellowcraft

Chapter 6

Fellowcraft

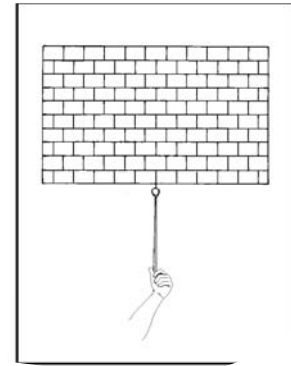

THE RITUAL of Freemasonry is a symbolic exposition of man's functions and possibilities. It illustrates the correspondence between the macrocosm and the microcosm at the important points in the soul's cyclic journey, and thus serves as a road map to spiritual attainment. We find, therefore, that the Entered Apprentice degree treats of man on the physical plane. The Master Mason's degree treats of man on the spiritual plane of existence. And the Fellowcraft degree, which we are now considering, treats of man in association with the astral plane.

Now upon the physical plane man has a seven-fold constitution. But at the death of the physical body both the physical form and the etheric body are lost. Physical substance and etheric substance, as most physicists now agree due to experiments conducted in the effort to prove or disprove Einstein's Theory of Relativity, cannot have a velocity greater than that of light, which in a vacuum is 186,271 miles per second. And astral substance cannot have a velocity less than that of light. That is, velocities in the ether approximating that of light are the Boundary-Line between the two planes of existence. And as the physical body and the etheric body cannot exist on the astral plane, which is the region where the soul functions immediately after death until it has evolved sufficiently to pass to the spiritual plane, man on the astral plane has a five-fold constitution.

Those parts of man corresponding to the Treasurer and the Secretary, even when man functions voluntarily on the astral plane before death, are left behind. Consequently we find that a lodge of Fellowcraft Masons may be opened by five officers; a Master, two Wardens, and two Deacons. And, instead of being a ground plan of King Solomon's Temple, the F.C. lodgeroom is said to represent a middle chamber of the temple; that is, it corresponds to the middle, or astral plane.

The password of the Fellowcraft degree is Shibboleth. This word means plenty, and refers to the abundance and high vibratory rate of etheric energy generated in the human nervous system by those striving to attain regeneration. This super-vitalization is a great aid to one who desires to pass from the physical body and travel consciously on the astral plane without a break in consciousness. In fact, so essential was it considered by the Ancient Masons that no one is permitted to remain

in the F.C. lodge who has not, in some measure, accomplished this; that is, who has not the proper password. To state it plainly, generation in the physical sense pertains solely to the physical plane, and when man reaches the astral, either through the avenue of death, or through voluntary sojourn while yet possessing a physical body, marriage becomes a higher, yet less specialized, fusion.

The Masonic ritual states that this pass was instituted in remembrance of a quarrel between a Jewish judge and the Ephraimites, that resulted in a battle. The Ephraimites were routed, and guards were placed along the River Jordan that they might not pass. All passing the river were required to pronounce the name Shibboleth. The Ephraimites, being of another tribe, were unable to pronounce it thus, saying Sibboleth, which revealed their identity, and they were slain to the number of forty and two thousand.

According to the Hermetic System of Names and Numbers (see Course 6, *The Sacred Tarot*), the fifth Hebrew letter, which was omitted from the password by the Ephraimites, denotes the feminine principle in nature, and applied to humanity it denotes woman. Its omission from the word signifying the process of regeneration typifies those who attempt regeneration while living lives that are isolated from the opposite sex.

Let no one think that the Ancient Masons taught there is any danger in a chaste life. Chastity, under normal circumstances is quite consonant with physical health and physical balance; for nature has adequately provided for such a contingency. In fact, when nature is not violently tampered with she usually keeps her children from disaster.

But there are those who make great virtue of the celibate life. Numerous sects today quote scriptural passages to prove that wonderful advantages result from sex repression, in spite of the very obvious circumstance that those making such claims, as well as their followers, have not made any great attainment, and usually have the psychic faculties opened in a way that gives erroneous visions and distorted notions. One of the favorite quotations is from I John; 4;9: "Whosoever is born of God doth not commit sin; for his seed remaineth in him; and he cannot sin, because he is born of God."

A reading of the passage in the Bible preceding this one shows that the seed referred to is the seed of righteousness implanted by the Son of God. But this, and other passages, are misconstrued to mean that in some way man is greatly benefited and spiritualized by never losing his physical seed. There is undoubtedly a great amount of nonsense afloat in regard to this.

Among other things, it is quite commonly taught that the seed is reabsorbed into the blood stream and thus confers magnetic strength and psychic power. Yet a fuller knowledge of the nature of the seed indicates that such absorption does not take place, and that if it did it would be a detriment to the physical body. The spermatozoon, which is the male seed, for instance, is to all intents and purposes a flagellate cell. That is, it is an independent one-celled organism provided with a

whip-like tail by which it lashes itself through whatever fluid it is in. If such a cell should enter the blood stream it would be, while it still lived, a parasite; as much a parasite as the protozoon microbes—certain ones of which cause malaria and sleeping sickness—which it greatly resembles. It is very doubtful, however, that the seed does thus enter the blood. At least it does not unless forcibly retained; for nature has her safety valves, and under normal conditions the seed when so abundant as to cause danger passes from the body with other secretions.

It is quite likely that the basis of this notion lies in a misunderstanding. For the glands associated with the seed, the gonads, have been found by physiologists to be the most important of all agents for restoring youthfulness and vigor of body and mind. Gland transplantation, in many cases, has produced marvelous results in this respect. Both old men and old women have been restored, at least for a time, to youth, vigor, and the functions of earlier life. But this regenerating substance is the endocrine secretion—which enters the blood stream under any sexual excitement, and does not pass from the body in sexual union—and not the seed.

Therefore, let those who wish to retain youth and vigor study how to keep their various glands, particularly the gonads, from wearing out; and how to keep these glands vigorous and healthful, and they will be on the way to an actual accomplishment of that which some imagine may be attained through mere retention of the physical seed. The teachings of the Ancient Masons, while making no mention of endocrine glands, are such as to indicate that they had studied and mastered methods of preserving and strengthening these glands, and thus not only lived in full vigor to a greater age than people live today, but also arrived at a much greater spiritual power.

Forced Celibacy

—Before turning from the subject of forced celibacy still another fallacy should be mentioned. It is often stated that because the sex fluids contain the very quintessence of life that their loss results in great depletion, and that their retention leads to great vitality and power. Now there is no denying that excess in this direction is devitalizing. Nevertheless we must bear in mind that nature has provided for the expenditure of a normal amount of energy in reproduction. That is, a normal quantity of such fluids are manufactured by the body, and if not used in reproduction will find a way to leave the body. Also, man has normal muscular strength and normal mental strength.

It might be supposed that if man did not use up his muscular energy in exercise that he would retain his strength. But the facts are that if he fails to take the normal amount of physical exercise, not only his body weakens and his health fails, but his mental powers deteriorate also. And it might be thought that if man did not exercise his mind that it would be strong and vigorous; but lack of exercise weakens the mind. And as the sexual function is an essential portion of man's constitution, we can hardly help drawing the conclusion that prohibiting sexual expression is bound to weaken the sexual nature and that this in turn will react upon the body and mind in a manner to lessen their vigor.

This is not a brief in favor of indulgence. It is an attempt to explain the real nature of regeneration, in which physical union is no longer necessary, as taught by the Ancient Masons. But before being able to understand regeneration we must know something about generation. A whole school of psychoanalytic doctors have sprung into existence and have a widespread practice today, because they are able to correct and heal thousands of cases of serious maladies caused by repressed sex desires. Freudian literature is now known to almost everyone. And the first step in the treatment of those afflicted through repression is to get them to recognize that there is nothing ungodly in normal sexual desire and expression.

There is, however, according to the teachings of the Ancient Masons, a higher expression of sex than the physical. Regeneration is the sublimation of desires into aspirations. Physical unions are no longer necessary because there is a higher, finer, magnetic union that satisfies. Desires are not repressed, they are transmuted. No effort is made to retain the sexual fluids, because, to a great extent the energy that previously was consumed in their manufacture now is used in the manufacture of etheric energy. In other words, instead of forcing a condition upon the physical, there is no longer a desire for physical expression because the energies are expressing themselves in a more refined manner.

When the thoughts enthusiastically turn to a higher, better, more spiritual mode of expressing the love nature, there need be no concern about the physical; for the energies go where the thoughts are directed. Under such circumstances, the physical will take care of itself, and no attention need be given to it.

In regeneration, as taught by the Ancient Masons, lust, passion, and carnal desire are entirely unknown, having been transmuted into a higher expression. Sexual union as commonly recognized has no existence, but has become blended gradually into a glorious, harmonious, transcendent, responsive reverberation of soul to soul. Man, as we know, has an etheric body, an astral body, and a spiritual body. Regenerate union may relate to any one, or to all three, of these finer bodies. It may be but the harmonious blending and mutual exchange of magnetism between husband and wife, an interchange of vital energy beneficial to health and accompanied by exalted feelings. It may mean the complete fusion of their astral bodies in a symphony of concord, strengthening their mental ability, and arousing their psychic perceptions. It may consist of a blending of their spiritual bodies that unless their spiritual

faculties are very acute they will fail to comprehend; a blend that is realized as a sense of sweet peace and moral uplift when they are in each other's company. Or it may be all three of these. It is not, however, on any plane, a union of sexual organs; it is a complete blend. At least in so far as I am able to interpret it, this is the regeneration of Ancient Masonry.

The Ephraimites, who are stated to be a stubborn, rebellious people, represent those who through asceticism crush out the finer qualities, and renounce association with, or thought of, the opposite sex. The Jordan is the boundary between the physical and the higher astral plane—the region of earth-bound spirits—which those who have crushed out the feminine part of themselves are unable to cross.

The 42,000 who perished—4 plus 2 equal 6, and 6 represents forces in a state of unbalance—signify not only those unbalanced through asceticism, but because 6 is also the number of Venus, the love planet, it applies to those who are unwise in union. This unbalance of energy is the cause of immeasurable misery; for one of the psychological laws of great importance relating to physical and to higher unions alike, is that there must be a balance in intensity, and complete expression by both. Lack of complete expression by one results in the release of mental forces lacking in proper stability and equilibrium, and the one failing completely to express develops the symptoms well known to psychoanalysis as the incompleteness complex, which may result in a variety of troubles. It would seem that the 42,000 who perished are mentioned as a warning that the best results, either on the physical or on higher planes, are obtained when there is complete co-operation.

**The River Jordan Is the Dense
Etheric-Astral Belt
Separating the Physical from the
Upper Astral**

—Velocities which are less than those approximating that of light belong to the physical plane. Velocities which are in excess of those approximating light belong to the astral plane. But the velocities of etheric substance, such as radiations, light and electromagnetic waves belong to a transition region. And energy from one plane (bank of the Jordan) can be transmitted to the other plane (other bank of the Jordan) only through first communicating its motions to this belt of etheric rates having approximately the velocity of light.

Vibrations of the ether may be of comparatively low-frequency or high-frequency. Vibrations of physical substance can be produced of far higher frequency than the lower frequencies of electromagnetic waves. Likewise, etheric vibrations can be produced which are far higher than the more commonly encountered astral frequencies (not to be confused with velocities). But most of the etheric frequencies set in motion by thoughts are on the animal level of existence, and thus communicate their energies to the level of the astral plane which contains animals, other intelligences, and discarnate human beings whose motives and feelings are those common to animals.

Shrewdness, intelligence and knowledge, or lack of them, is no gauge of the vibratory level of a person or creature on earth, or of a person or creature in the astral realm. Some of the brainiest men of earth are the greatest scoundrels. And animals which have an intelligence no greater than limited instinct, survive on the astral plane after their physical deaths, and occupy the vibratory level corresponding to their feelings and motives.

In other words, intelligent human beings dominated by the animal propensities, regardless of their cunning, may still be beasts of prey in their basic vibratory rate, and when they pass to the next life occupy a vibratory level on which beasts of prey also are to be encountered. Not that they necessarily associate with such beasts; but they and the beasts occupy the same stratum, even as men and beasts are both to be encountered on the earth.

On earth the struggle for survival is so intense, that a large portion of the thoughts of men, and a large portion of their emotions and feelings, relate to the animal level of existence. Only a portion of the thoughts of humanity are accompanied by feelings of tenderness, are actuated by willing self-sacrifice for the welfare of another, are charged with noble sentiment, or lift the soul in aspiration, and thus set up etheric vibrations on a higher-than-animal level. And only etheric vibrations of a higher-than-animal level can impart their motions, and thus make the contact with, an astral level above that where animals and discarnate souls with animal-like propensities reside.

Thus it is about the earth there is a dense belt of etheric energy the vibrations of which have been set in motion by the feelings of animals, and the thoughts and feelings of men when they were actuated by animal propensities. Most of these men have a far higher basic vibratory rate, and when they pass from earth life consequently will move to a much higher level. But their temporary bursts of passion, their momentary greeds, and their transitory periods of base selfishness, radiate etheric vibrations on a corresponding low vibratory level.

And astral entities that permanently reside, due to their basic vibratory rates, on a similar vibratory level, find it easy to use the energies of this dense etheric belt to influence those still on earth who become negative.

As this Lower-Pluto astral realm, where motives are still those of the beasts, possesses velocities exceeding those of light; space, time and gravitation do not restrict as they do on earth. Consequently ESP (Extra Sensory Perception) can be exercised on this level. More spiritual types of information can be acquired only on more spiritual levels of the astral world. Yet information of value, especially that relating to the affairs of earth, can be acquired in the Lower-Pluto realm.

However, this dense belt, where lower astral levels and the etheric energies derived from the animal thoughts of men and the emotions of animals so closely blend as to make it difficult to determine just where the astral begins and the ether leaves off, is a poor place to tarry. Many of the denizens of this River Jordan are dangerous.

Consequently either in contacting the inner planes through EXTENSION OF CONSCIOUSNESS, or in ASTRAL TRAVEL, it is wise quickly to pass through this etheric-lower-astral belt. To do this, the etheric vibrations at the time must be of sufficient potential to carry the consciousness through to the astral plane, and of a vibratory frequency higher than this River Jordan Belt. One who has developed sufficient electrical potential and a high vibratory rate—can pronounce the password, Shibboleth—can pop through this belt so swiftly as not to notice it is there, just as one can turn the dial on a radio from one program, past a frequency over which one knows a disagreeable program is being broadcast, and to a desirable program with no perceptible interference.

Preparing the Candidate

—In preparing the candidate for initiation into the Fellowcraft degree, all his clothing is removed except his shirt. This is symbolical of the astral raiment in which the soul functions after it leaves the physical body. He is then provided with a pair of woolen drawers, still typifying creative energy, but as they are no longer red they indicate that he has overcome and transmuted his purely animal and physical desires. Instead of his left breast being bare, his right is now bared, indicating that instead of selfish and physical desires and emotions he is actuated by unselfish aspirations.

The right foot and right arm are bare, showing by the former that he has arrived at right understanding, and by the latter that his present work is largely upon the positive, or astral, plane. His left foot and left arm are yet clad, indicating that he is yet hampered both in understanding and in execution by physical requirements. And the right eye is blindfolded to signify that he is yet unable to perceive higher truths, while the left eye is uncovered to show that through experience he has learned properly to view the things of the physical world.

The candidate approaches his new initiation by giving two knocks upon the door of the lodge, which signifies his intention to seek admittance to the second, or astral, plane. This rapping is called the Alarm, and arouses the brethren within. Such a neophyte attempting to enter the astral plane not only arouses those friendly to his visit, but also may arouse certain classes of astral beings who have a violent antipathy

to man. There is, therefore, cause for alarm, both to the neophyte and to his brethren and teachers on the inner plane, when he attempts first to enter voluntarily the astral realms. In addition to the positive electrical potential and high vibratory rate assured by the password, his only other sure protection is to possess a soul radiating unselfishness; one purified of sensuality and grossness. Against such a purified soul the fiends of hell may rage in vain.

At this point he must give the password. This password, Shibboleth, indicates that he at least has made some progress in regeneration. He is then called upon to enter the lodge—the astral plane—in the name of the Lord (law). That is, he is asked to enter it in obedience to the various laws governing voluntary travel on the astral plane. As he enters the room the angle of a square is pressed against his naked right breast. The square is the symbol of physical union, and the right breast of spiritual aspirations. This signifies that the candidate at this stage, while aspiring to regeneration, has not yet discarded more physical union. He realizes that his physical organism has adapted itself to its present mode of life over a long period of habit forming, on his own part, and on the part of innumerable ancestors from whom his physical body is inherited. To suspend or suppress any natural function is a violent shock to the astral body that will usually react unfavorably on the physical body also. The animal soul is not to be destroyed, but transformed, and this is usually a gradual process of training.

Eastern mystics say to kill out desire, but they really mean its transmutation, not its death. Desire is one of the finest steeds, but it is yet wild and unbroken. A horse can be killed with a knife. So may desire be slain with the will. A horse can be tethered, starved, and beaten. Desire can be treated likewise. It is true that an unbroken mount may unseat and if unchecked even destroy his rider. But if ridden with skill, curbed and guided, the rider will travel many, many times as far as a man without a mount.

If the animal part of man is fought, starved, and otherwise mistreated, it will not have the strength to carry the soul to higher realms. But if treated kindly, yet firmly, its wildness will disappear, and it will become gentle. It will then be desire no longer, but aspiration, the trusty mount of the soul. Had desire been killed there would have been no aspiration, for they are one and the same in different stages of development.

Entering the astral plane with the square against the right breast is quite different from entering the physical world with the point of the compass pressing against the left breast, as in the E.A. degree. The latter is called Torture; for it indicates that the physical desires, symbolized by the left breast, must be made subservient to the law of higher union, in order that birth on the physical plane may be accomplished under the best of circumstances.

Entering the Astral Plane

—Entering the lodgeroom the Fellowcraft candidate is led twice around the room, indicating that he has evolved through one plane, the physical, and is now evolving on the next, or astral plane. He is then led first to the Junior Warden (spiritual body), then to the Senior Warden (divine soul), and finally to the Worshipful Master (ego). This is to indicate the members of the higher trinity of his constitution which influence his progress on the astral plane. While being conducted around the room, representing his astral evolution as mentioned, the Master reads the following passages, which consist of the seventh and eighth verses of the seventh chapter of Amos: “Thus he shewed me; and behold, the Lord stood upon a wall made by a plumbline, with a plumbline in his hand. And the Lord said unto me, Amos, what seest thou? And I said a plumbline. Then said the Lord, Behold, I will set a plumbline in the midst of my people Israel. I will not again pass them by anymore.”

The number 7—this is the seventh chapter of Amos—as applied to human life signifies the perfect nuptial union; and the number 8 signifies death. The word Lord, here, as elsewhere, is interpreted by initiates to mean Law. The wall, by its horizontal position, symbolizes the feminine principle. This principle is here signified to be a foundation and a protection. The plumbline, by its position, signifies the masculine principle. The hand signifies human work. That the Lord will not pass by them anymore, indicates that the law is changeless. Israel signifies a chosen people. Therefore, these verses as here applied may be interpreted as the changeless law that love lies at the foundation of all, and that those who are chosen to defy death work in accordance to this law.

The candidate is next led to the west—the material plane—and instructed to approach the east, the place of light—the spiritual plane, by advancing upon two upright steps to the second step. The first step has been explained in the E.A. degree to symbolize the will to understand the mysteries of generation. The oblong square of that degree is made by the heel of the right foot being placed in the hollow of the left foot. This is the first step. The two steps are taken by stepping off first with the left foot and then with the right and bringing the heel of the left foot into the hollow of the right. On the astral the feminine, emotional, becomes the more positive in its effects. That is, woman more naturally acts from the subjective, or astral plane; and man more naturally from the physical. The left foot within the hollow of the right, then, indicates the will—shown by the standing position—to understand the mysteries of regeneration.

The candidate now kneels on his right knee before the altar, making his left knee form a square. The left arm is held horizontal as far as the elbow, the forearm vertical to it making another square. The elbow also rests upon a square. He is required to take the oath of a F.C. Mason in this position. In this degree the right knee is suppliant, indicating the subservience of masculine forces to feminine upon the astral plane;

being the reverse of the symbol of the E.A. degree. The left arm forming the upper square denotes that the feminine, or subjective, forces are employed in execution upon the astral plane. The square supporting the arm that symbolizes execution imparts the information that its strength at this stage of initiation is sustained by physical co-operation.

After the oath has been taken the Bible is kissed twice. This indicates willingness to abide by the laws of union on both planes as taught to him by his instructors. The moment of transition from the physical to the astral plane is signified by the bandage being lowered until it covers both eyes. This typifies the momentary unconsciousness that takes place as the astral body separates itself from the physical. The magnetic union that assists in generating the force necessary for this volitional transition is shown by the brethren forming on the square. They stretch forth their hands to assist the new brother, as a token of the service rendered by union, and also to represent the unseen helpers who respond to the devout aspirations of the worthy neophyte who obeys the law of progress. Then the Master says, "And God said, Let there be light, and there was light." Whereupon the bandage is snatched from the candidate's eyes and the brethren give the grand shock as in the E.A. degree, the meaning of which has previously been given. Thus is the soul in "search of more light" awakened to the new truths of a different plane of existence.

The candidate's attention is next called to the fact that in the E.A. degree, or on the physical plane, both points of the compass are beneath the square, while in the present degree one point of the compass is elevated above the square as they lie upon the altar. He is also informed that while he now possesses more light upon Masonry, he yet remains in darkness regarding one material point. This conveys the idea that he has partly removed the shackles of sense and seeming by obedience to the laws of both generation and regeneration, but has not yet entirely freed himself from material limitations.

The one point of the compass beneath the square symbolizes that the higher laws of union are yet in a measure subservient to demands for physical expression. The one point of the compass above the square indicates that the neophyte has partially overcome the physical impulses and made them obedient to the laws of regenerate union. This is typical of the transitional stage between the purely physical life and the truly spiritual life. It represents a stage of growth in the candidate's development, usually of long duration, in which the demands of both natures must be heeded, and physical requirements gradually eliminated by being transmuted into those spiritual. These symbols of the present state of his unfoldment are upon the altar, indicating that he should approach the mysteries of his creative nature in a reverent manner, and make them the altar of his most devout prayers and unselfish aspirations.

Strengthening the Rapport Between the Soul and the Ego

—To represent the strengthening of the rapport between the soul and the ego, due to living a life of greater spirituality, the cable-tow in the F.C. degree is placed twice around the neck. This is the region ruled by the planet of love. No longer is the cable-tow passed under the arm as in the E.A. degree, and it is passed twice around instead of once. The higher love, and its importance in spiritual progress is thus emphasized.

Significance of Grips and Passwords

—The sign of a F.C. Mason is made by taking hold of the left breast with the right hand as though to tear a piece out of it, then the hand is drawn with the fingers partly closed, quickly to the right and dropped to the side. The breast is the seat of emotion, and the right breast indicates the higher aspirations and longings. The left breast symbolizes the more physical emotions; and as the region of the heart, ruled by the sun, is also the center of vital life.

The hand grasping the left breast as if to convey a portion of it to the right breast, signifies that the material emotions are to be transmuted into those more spiritual, and that the life is to be transferred to a higher plane. The hand dropping perpendicular at the side indicates that the creative life is to be raised to the region of the breast. In the E.A. degree the sign is made from the pharyngeal plexus, the seat of amative desires, the region ruled by Venus; and the hands are open to indicate repulsion. In the F.C. degree, however, the sign is made at the cardiacal plexus, the seat of emotion; and the hand is partly closed, indicating an attractive force that binds man and woman more securely together. It is thus representative of the attraction between man and woman resulting from congeniality in temperament and the harmonies aroused through sympathetic emotional response, rather than the attraction of a more physical nature.

In giving the due-guard the left arm is raised until that part between the shoulder and the elbow is horizontal, and the forearm is vertical to it. It symbolizes the union of husband and wife upon the astral plane. The horizontal part typifies woman, the vertical represents man; and the elevated position indicates them on a plane above the physical. It being the left arm indicates it is the negative, or astral plane. The sign and due-guard are given together to symbolize that the raising of the energies from the plane of generation to the plane of regeneration results in union in the astral realm.

The name of the pass-grip of a F.C. Mason is Shibboleth. It is given in the following manner: The right hands are clasped as in shaking hands, and each presses his thumb between the base of the first and second fingers of the other's hand. The thumb in palmistry denotes will. The first finger is ruled by Jupiter, and governs the feeling of fellowship. The second finger is ruled by Saturn, and has dominion over labor and secrecy. In giving this grip the Master says, "I now present you with my right hand in token of brotherly love and confidence." The pressure of the will finger is made between the finger of brotherly love and the finger of caution, thus denoting the will to be both benevolent and silent.

The real grip of a F.C. Mason is made in shaking hands by pressing the thumb on the base of the second finger where it joins the hand. The thumb is crooked in such a manner as to stick the nail into the joint of the other. As the second finger is the Saturn finger, the grip signifies; the will to labor diligently and in silence. The pressure of the thumb nail is symbolical of the painfulness of the endeavors that lead to any worthwhile realization. "Sloth is the eighth deadly sin," and the Masons of all ages have realized the paramount value of work; and as their ideas often differed widely from those held by a reigning authority who had power to deprive them of life and liberty, discretion imposed silence.

The name of the grip is Jachin. Jachin is the right pillar of Solomon's Temple, and in the cosmic lodge signifies the Northern half of the ecliptic. While the sun passes through this half of its annual cycle the days are longer than the nights, producing the genial warmth of summer. In humanity Jachin represents the virile powers of man, and in the individual the positive and executive attributes. Its more specific significance is phallic, typifying the creative principle. As every plane of existence is negative to the plane interior to it, the physical world being moulded by the astral, the astral may be termed the world of Jachin, that is, the world of creative action.

When the grip has been given, the Worshipful Master says, "Arise, brother Jachin, from a square to a perpendicular; go and salute the Junior and the Senior Wardens, and convince them you have been regularly passed into the degree of Fellowcraft." This speech intimates both the method of transit, and the passage, from the physical plane, Boaz, to the astral plane, Jachin. From the square, or co-operation, by which the force is generated, to the perpendicular, or attribute by which it is positively directed, the neophyte ascends to the astral, or region of Jachin. This brings him more closely in touch with his spiritual body and divine soul, which are symbolized by the two wardens.

The candidate is told that at the building of Solomon's Temple the workmen were distinguished by the manner in which they wore their aprons. Then an apron is tied on him in a fashion to denote that he belongs to the F.C. degree. The significance and correspondence of the apron were given in chapter 5. It is tied on in the same manner in the F.C. degree as in the E.A. degree, except that one corner is turned up and tucked under the apron strings. As the square covering the Libra-Scorpio region typifies

their purely physical functions, a portion of this square being raised in the form of a triangle indicates a partial transmutation has taken place. It thus symbolizes that to enter the F.C. degree it is assumed that a portion of the physical energies have been transmuted into etheric energies of such refinement that they are potent to affect results on the astral plane.

The Master then says, “As you are now dressed, it is necessary you should have the tools to work with.” Thereupon, the candidate is presented with a plumb, a square, and a level. The significance of these tools has been previously explained, and it only remains to be added that they are here presented to the F.C. in exemplification of the Hermetic Axiom: “As it is below, so it is above, as on the earth, so in the sky;” indicating that progress on the astral is made by methods analogous to those employed on the physical plane.

Thus at death man passes to the astral plane, permanently leaving behind him the physical body and the etheric body, which correspond to the planets Saturn and Jupiter, and in the lodge to the Treasurer and Secretary. The physical body and etheric body then gradually disintegrate, and man functions on the astral plane with a five-fold constitution.

I have already mentioned two dangerous extremes that the Ancient Masons warn against: forced celibacy in the hope of gaining selfish ends, and sex practices for selfish aims. Either extreme, according to these Ancient Masonic teachings, is dangerous; and as bearing this out, we find that practically all the mystical manias of history have arisen among forced celibates, or were accompanied by orgies of licentiousness. Where love and marriage are given their rightful place there is little danger of fanaticism.

Jewels and Check-Words

—Therefore, to admonish the neophyte not to jump to hasty conclusions in regard to these and other matters, the Entered Apprentice was given three jewels: A listening ear, a silent tongue, and a faithful heart. The listening ear indicates that strict attention should be paid to all instructions from within as well as to those from without. The silent tongue signifies that the voice of the silence may be heard only when external thoughts and sensations are inhibited. The faithful heart reveals that there should be strict obedience to the mandates received from within, and perseverance and discipline in its execution.

These three jewels have correspondences above and below. Thus in natal astrology an individual's mental capacity is gauged by the moon; and the moon also rules the quality of receptivity, which is symbolized by the listening ear. It corresponds to the divine soul, from whence proceeds the voice of the silence. In natal astrology the mental expression, the inactivity of which is symbolized by the silent tongue, is ruled by Mercury. Mercury rules speech, and corresponds to the spiritual body. The sun in natal astrology indicates the individuality, and rules the heart of man. It corresponds to the ego. True faith is from the inner recesses, and a faithful heart results when the actions are governed by the ego.

The Entered Apprentice was also given two check-words and a new name. The first is called the Grand Master's check-word. It is TRUTH. Thus before accepting any practice or accepting any doctrine, the Mason should exhaust every means to prove its verity. This check against error is as indispensable to the adept as to the acolyte, to the Grand Master as to the E.A. Hence it is called the Grand Master's check-word.

The second word is UNION. This emphasizes the importance of co-operation between husband and wife. Such intelligent co-operation is a check against fanaticism.

The new name assigned the E.A. is CAUTION. Caution is most necessary; for impatience and hasty conclusions in regard to the use of the forces revealed by Masonic Symbolism is very dangerous. Strength lies in Union; but unwise union leads to disaster. To leave the physical and "travel in foreign countries" opens the door to knowledge, but to depart without due preparation may mean inability to return. Hence while the candidate still is concerned with the physical plane he is given the name Caution.

In the Fellowcraft degree also, the candidate is given three precious jewels. They are Faith, Hope, and Charity. Faith to follow unhesitatingly the dictates of the inner voice. Hope to buoy up the soul during its period of anguish while in spiritual travail. Charity towards those who perceive not the light and struggle yet in outer darkness.

When the F.C. has finished the first stage of his initiation, as outlined, he is led back to the outer room to be reinvested with his clothing, even as he returns to his physical raiment after his first pilgrimage into the spheres of the astral.

Lights, Points and Dedications

—The ritual states that there are three lights in the lodge; one in the east, one in the west, and one in the south; but that being a true representation of King Solomon's Temple there is none in the north. This means that the sun rises in the east, culminates in the south, and sets in the west; at which stations it can be plainly seen. But when it is at the nadir, or northern point, at midnight, it is hidden from view, and consequently no light is apparent in the north of the lodge.

It is asked to whom the Ancient Masons dedicated their lodges. The answer is given, “to King Solomon.” But Modern Masons dedicate their lodges to St. John the Baptist and to St. John the Evangelist, “Because they were the two most eminent Christian patrons of Masonry, and since their time, in every well regulated and governed lodge, there has been a certain point within the circle, which circle is bounded on the east and west by two perpendicular parallel lines, representing the anniversary of John the Baptist and John the Evangelist, who were perfect parallels, as well in Masonry as in Christianity; on the vertex of which rests the Book of the Holy Scriptures supporting Jacob’s ladder, which is said to reach the watery clouds; and passing round the circle, we naturally touch on both these perpendicular parallel lines, as well as the Book of the Holy Scriptures; and while a Mason keeps himself thus circumscribed, he can not materially err.”

Masonry applies the correspondences existing between the soul and the stars. In astrology the heavens are measured in three different planes. The Mundane Houses correspond to the physical realm, and to the E.A. degree of Masonry. The Zodiacal Signs correspond to the astral plane, and to the F.C. degree of Masonry. And the Constellations correspond to the spiritual world, for, like the Master Mason’s degree, their realm of influence pertains strictly to man’s spiritual nature.

The point within the circle is the world upon which we live, which is bounded by the circle of the zodiac. The two parallel lines are formed by the solstitial colure, cutting the zodiacal circle at opposite points; one point being where the sun reaches its greatest northern declination, and the other point being where the sun reaches its greatest southern declination. When the sun is at either of these two points and rises or sets, these lines are east and west from the observer, and actually bound by lines running north and south, what may be seen of the zodiacal circle. The sun reaches one of these lines when it passes into the watery sign Cancer on the 22nd of June. That is, the Son of God is immersed in a watery sign on that day, and two days later, June 24th, is the day given by the Church to St. John the Baptist.

Evangel, means to bring good news; and after the sun has gone to its extreme southern point, giving the least light and heat of any time in the year, it is certainly good news when he is observed to turn back to be resurrected from his wintry tomb. He reaches this latter line on December 23rd, and soon thereafter is seen moving north again, bringing the tidings of another period of warmth and growth. Therefore, even as the opposite point, where he first begins to submerge, was dedicated to St. John the Baptist, so this point, where he begins to emerge, is dedicated to St. John the Evangelist; and the day given to St. John the Evangelist by the Church is four days after this line is crossed, or the 27th of December.

These two points, because easily determined by observation, are important points in all Masonic reckoning, and are thus also the supports of the Oral Law which has its foundation in astro-traditions. Hence the Bible, symbol of the Oral Law, rests upon them. And above the Bible, reaching to the watery clouds is Jacob's ladder. This ladder symbolizes the involutory descent and evolutionary ascent of the soul, each rung being a form of life in which it lives, yet ever within the zodiacal circle and under the influence of planetary forces. The watery clouds above, that is, water and air, symbolize the emotions and aspirations that have led the soul upward on its toilsome ascent.

The two lines where the solstitial colure cuts the ecliptic, are perpendicular to this zodiacal circle, and the sun cannot travel around the zodiac without touching both; nor can it do so without making an impress upon the Oral Law. Neither can man travel the orbit of his life without being influenced by the astrological energies bounded by these lines, nor without, if he is a Mason, coming in contact with the Oral Law as handed down by the Magi from the past. And he who can conform his efforts to the boundary of his possibilities as shown by the stars, and adapt his life to the Oral Law as handed down by the sages, will be as free from error and the chain of blind fatality, as it is possible for man to be. No truer guide exists than that circumscribed by the zodiac as mapped in the jeweled canopy of heaven.



Chapter 7

Serial No. 12
Original Copyright 1939
Elbert Benjamine

Copyright
Church of Light
August 2002

Lodge Emblems

Chapter 7

Lodge Emblems



THE EMBLEMS of Masonry, no less than the pictured starry constellations, the designs of the tarot cards, and the allegorical stories of the world's sacred books, bespeak an ancient language whose terms are intelligible to peoples widely separated both in space and time. It is the language of the unconscious mind, the language even to a small degree understood by the creatures of the wild as well as by man, the language which derives from common associations, and which, therefore, is the language of dreams.

In this peculiar transmission of ideas it is assumed that people have had certain experiences in common, and that, therefore, the Law of Association will readily suggest to them the outstanding qualities of things seen or heard. It is assumed that people the world over who have had any experience with horses are familiar with the idea that horses commonly are used to carry riders to their destination. This association of ideas is then made use of to suggest by means of a horse that which carries man to his goal. Horses thus become the symbol of thoughts, and especially of thoughts which are expressed, and thus is derived part of the symbol of Sagittarius, which is natural ruler of the house of expressed thought in a chart of birth.

That which is seen and experienced in dreams is not without significance. All of it—except that which consists of witnessing some actual event, past, present or future—is a portrayal to the consciousness in this language of symbolism, which derived its terms from Association of experiences and ideas, of something of significance to the mind of the individual.

But the significance of the symbolism of dreams is far more complicated than the symbolism we here consider, not because the meaning of the symbols is more difficult to discern, but because in the dream state we are more or less conscious of the astral plane in which there are new properties present as if it embraced still another dimension.

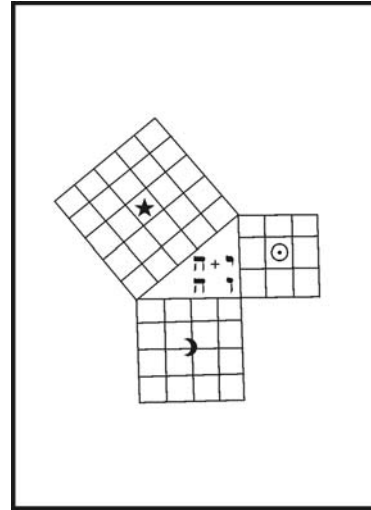

In dreams, for instance, there are images derived from sensory stimuli, there are fantasy images induced by desire, and desire may cause condensation or expansion of the symbolism. On the astral plane, and in dreams, not only objects, but people's thoughts may be seen as definite images. And occurrences that happen on various astral levels may be witnessed, as contrasted with events on a single level that may be witnessed on the earth.

But this is only the beginning of the possible multitude of things that it is possible to see in sleep, or on the astral plane; for, due to the lack of restriction of time, space and gravitation, it is possible to witness one's own past experiences and thoughts, and one's probability line of future experiences and thoughts as if they were realities in the now, and to witness other people's past experiences and thoughts, and their probability lines of future experiences and thoughts as if they were happening in the now.

Thus the problem confronting us in discerning the significance of things seen in sleep or on the astral plane, is not so much that of interpreting the symbolism, as it is in untangling the past and future from the present, discriminating that which is merely a thought from that which represents an occurrence involving individuals, and in otherwise unscrambling images and impressions and giving each its proper place. The infant taken on a drive through a great city has the same difficulty. But with experience and training the infant grows to recognize the relative value and significance of its impressions. And man also, in due course of time if he trains himself diligently, can while still on the physical plane, learn properly to appraise what he sees in dreams, and what he sees without dreaming on the astral plane.

The Masonic Lodgeroom

—It is said that the Masonic lodgeroom is as long as from east to west; as wide as from north to south; as high as from the surface of the earth to the highest heaven; and as deep as from the surface of the earth to the earth's center. Only one thing has such dimensions. That thing is the universe as mapped by the Mundane Houses of a horoscope. Therefore, the lodgeroom is the universe considered from the point on the earth where the candidate stands (see Course 2, *Astrological Signatures*, Chapter 3).

From east to west is considered the length, and north and south the width, because the planets in their orbits about this celestial lodge move fewer degrees north and south than they move east and west. The limit of their movement by declination—the north and south movement—is less than 60 degrees; but they move through the zodiac, and also by their diurnal travel about the earth from east to west, the entire circle of 360 degrees. The third dimension of a horoscope is always considered to reach from the center of the earth beneath the observer's feet to the zenith directly over his head. From the standpoint of astrology it would be difficult to give a better definition of the dimensions of the stellar universe than this one formulated by the Ancient Masons.

The Three Pillars

It is further asserted that there are three columns, or pillars, that support the lodge. These are the equinoctial colure, the solstitial colure, and the meridian. They are the support of the lodge because the lodge is the vault of heaven and all calculations relating to it are referred to one or more of these three lines, or pillars. Thus the celestial longitude of a stellar body is always calculated as so many degrees, or hours, from one end of the equinoctial colure, which is called the first point of Aries. Celestial latitude is reckoned as so many degrees north or south of the ecliptic; the ecliptic being a circle passing over both ends of the equinoctial colure, and also over both ends of the solstitial colure; the latter line, or pillar, being necessary to determine the plane of the ecliptic. Yet astronomical calculations to be of value on the earth must not stop with defining the position of a celestial body in terms of latitude and longitude, but must designate the position with reference to a given spot on the earth. This third necessary element is calculated from the third Masonic pillar, the meridian. Thus if we say a planet is 12 degrees of Sagittarius, has 3 degrees south latitude, and that 9 degrees of Sagittarius is on the meridian, its position is completely defined. Without these three elements precise definition of celestial positions is impossible. Therefore, the Meridian, the Solstitial Colure, and the Equinoctial Colure, are truly the supports of the celestial lodge.

When the sun rests upon the equinoctial colure the days and nights are equal, masculine and feminine forces are united by the colure in equilibrium, as pictured in the zodiac by the Scales of Libra, the zodiacal sign of marriage. And because proper marriage is considered a constructive function, the Ancient Masons named the pillar Wisdom.

When the sun rests upon the top, or northern end, of the solstitial colure, the days are longest and the masculine forces are dominant; when it rests upon the bottom, or southern end of the solstitial colure, the nights are longest and feminine forces are dominant. Because that man is strongest who is dominantly masculine, and that woman is strongest who is dominantly feminine, the Ancient Masons named this pillar Strength.

When the sun rests upon the meridian it is noon and there is the maximum sunshine for that day. This light makes more plainly visible the innumerable beauties of nature. Because of this the Ancient Masons named this pillar Beauty.

Furthermore, to make the identity of the lodge unmistakable, Masons assert that it has a clouded canopy, or starry decked heaven, where all good Masons hope to arrive.

The Northeast Corner

—Any complete map of this lodgeroom divides it into the Mundane Houses commonly employed in erecting a birth-chart. Such a map, or birth-chart, has the directions well defined, each house ruling certain departments of life. The First House of the celestial map, the place where the sun is each day at dawn when it awakens the sleepy world into a fresh period of activity, in natal astrology rules birth. This house of birth is the northeast portion of the birth-chart. Therefore, in absolute conformity to astrological correspondences, when the candidate for the E.A. degree, that is, the candidate for initiation on the physical plane, has been reinvested with his clothing he is placed in the northeast corner of the lodgeroom and caused to stand upright like a man. He represents the soul that has evolved far enough to be born into human form. He also, by his position in the house of birth, indicates that through the knowledge imparted to him in initiation, he has been reborn and is now ready to commence a new life. Even as the sun after its daily birth ascends to a vertical position, so does the candidate stand upright like a man, by his position indicating the will to strive for higher things.

Not only is the First House, or northeast corner, of a celestial chart, the house of birth of man, but it marks the birth, or commencement, of each new enterprise. This explains why, “The first stone in every Masonic edifice is, or ought to be, placed at the northeast corner, that being the place where an E.A. Mason receives his first instructions to build his future Masonic edifice upon.”

No Metal Tool Was Heard

—In the building of the original Masonic edifice, Solomon’s Temple, the sound of ax, hammer, or other tool of metal, was not heard: “All the stones were hewed, squared, and numbered in the quarries where they were raised; all the timbers felled and prepared in the forests of Lebanon, and carried down to Joppa on floats, and taken thence up to Jerusalem, and set up with wooden malls, prepared for that purpose; which, when complete, every part thereof fitted with the exact nicety, that it had more resemblance of the handiworkmanship of the Supreme Architect of the universe, than of human hands.”

Because inorganic substances possess the lowest degree of life expressed on the earth they symbolize human experiences that are viewed solely from the standpoint of material loss or gain. But organic substances, possessing a higher degree of life, and a more complex organization, symbolize human experiences that are viewed from the standpoint of spiritual alchemy, from the standpoint of their effect upon character. Tools composed of inorganic substance, then, represent such mental activities as are concerned with the physical welfare; and an edifice built with metallic tools signifies an environment that has been constructed through selfish ambition. Such an edifice is bound, sooner or later, to fall into decay.

But the temple built upon true spiritual principles, built upon a recognition that the important function of each experience is its effect upon the character, does not decay; but becomes a glorious and permanent habitation for the immortal soul. Nor is this entirely figurative; for it is the attitude toward events, and the motive behind actions, that determine whether states of consciousness are evolved of sufficient intensity, and of such polarity that they combine, to affect spiritual substances. Only mental factors of proper intensity affect the spiritual body and have power to organize it as a vehicle for the immortal soul (see Course 3, *Spiritual Alchemy*, Chapter 4).

Because thoughts prompted by material motives have not intensity of vibration sufficient to affect the spiritual body, in the construction of Solomon's Temple, the spiritual body, the sound of no metal tool—thoughts based upon purely material motives—was heard. And the malls of wood were specially prepared because it takes special preparation and training to give the thoughts the viewpoint and spirituality that they may be used to build up the spiritual body.

The stones indicate the external experiences of mankind. They were hewed, squared, and numbered in the quarries where they were raised. That is, they were classified as the various sciences. The timbers, being of organic substance, represent the experiences of life that organize the character. They have their origin in the forests of Lebanon, the material plane. But they are floated by the emotional reactions toward them to Joppa, the astral plane. And from thence—if fit for the purpose, if of sufficient spirituality—up to Jerusalem, the spiritual plane.

And the spiritual body of man—organized by constructive thoughts that are largely motivated by the desire to benefit society, yet based upon a wide variety of experiences that are viewed as opportunities to build character—because it corresponds in its various parts to the universe—is a microcosm—resembles, therefore, the handiwork of Deity.

Three Movable Jewels

—Now the three movable jewels of a lodge are, the rough ashlar, the perfect ashlar, and the trestleboard. The rough ashlar represents man's character unmodified by spiritual aspirations and occult training. The perfect ashlar represents man's character after it has been perfected by applying the keen chisel of discrimination, driven by the hammer of will and intellect; and after it has been polished by persistent aspirations to be of greatest possible service to mankind. It thus becomes fit to be used in the construction of the permanent, or spiritual, human edifice.

The trestleboard is man's consciousness, where the soul drafts the plans for the actions of life.

Ornaments

—The ornaments of the lodge are: the checkered pavement, or mosaic; the blazing star in its center; and the indented tassel, or beautiful tessellated border that surrounds the pavement.

The blazing star has five points, and is thus the symbol of man. The one point above the other four indicates that man's head is uppermost, that his intellect has dominion over the four elementary realms, and should have dominion over the instincts of the flesh. In the heavens above, this Masonic star is Polaris, the Pole Star, which, because apparently it is the only point in the sky that does not move—for it represents the extension of the earth's axis—has throughout the ages been the emblem of that other thing which changes not, Truth. "Upon this rock will I build my church." Had it actually been founded on this rock the church need not have changed. The King, Cepheus—a word meaning rock—among the constellations, rests his foot on the Polar Star, which is a part of the constellation. This—Truth—is not merely the Rock of Ages, but it is also, "The rock that is higher than I," a recognition not merely of the permanence of truth, but that it is the highest religion. Therefore, when it is said that this star should appear conspicuously in the conduct of every Mason, we are informed that a conspicuous feature of Masonic conduct is adherence to Truth.

About this star, which on earth represents man and in the sky represents Polaris, is a mosaic of black and white checks. The movement of the planets through the zodiac causes their rays to converge to form squares, trines, sextiles, semi-squares, and other geometrical figures. The influence of some of these is harmonious, corresponding to the white checks. The influence of others is discordant, corresponding to the black checks. These checks, therefore, considered as planetary influences converging on man's astral body in regular geometrical patterns, attract to

man, through stimulating certain unconscious trains of thought, periods of good fortune and periods of adverse fortune. That is, they well represent not only the geometrical designs of the birth-chart, which predisposes him to certain experiences, but they also represent the progressed aspects which add energy and thus bring certain types of events to him at times that may be predetermined.

The recognition of these influences, symbolized by the checkered pavements, is important; but of still more importance is the advice given, that brethren may walk together upon this pavement without stumbling. In other words, adverse planetary influences cannot be avoided, but it is quite possible to avoid the adverse events that are threatened by planetary positions; and because mental vibrations may be reinforced by emotion, and because planetary influence operates through stimulating discordant mental states, that which can be used to engender specific constructive emotions may be used to annul adverse planetary influence. The Ancient Masons counseled, for this purpose, harmonies engendered through close cooperation.

Chalk, Charcoal and Clay

—The next thought requires some preliminary explanation. Life in association with the earth is embraced in seven stages, the seventh stage of consciousness summing up the other six and providing a point of transition to higher spheres. The incarnating soul first undergoes experiences in the mineral realm, then a cycle of experience on the astral plane where the mineral experiences are reorganized to fit it for vegetable life. It then incarnates repeatedly in the vegetable kingdom; following which it undergoes another cycle in the astral, gestating these experiences before incarnating as an animal. The fifth stage is its various incarnations in the animal kingdom; the sixth being a cycle in the astral realm where it synthesizes these experiences to a point where human incarnation is possible.

Now when the Senior Warden (corresponding to the soul) in the E.A. degree is asked whom he served, he answers, “My Master,” meaning, the ego. When asked how long, he replies, “Six days.” These six days are the six states through which the soul serves the ego, the six states from the mineral up to the point where human incarnation is possible. It thus represents the labors of the impersonal soul, impelled by the ego, to reach the human plane and thus come into possession of self-consciousness.

To the question with what he served him he replies, with Freedom, Fervency, and Zeal, and that these are present in Chalk, Charcoal, and Clay. That is, charcoal, which is used for fuel, is a symbol of fire, and hence of the fervency of creative energy. Clay is igneous rock that has been eroded by ice, and thus represents the union of fire and water, male and female principles, and it is stated that nothing is more zealous than clay to bring forth. Chalk is chiefly composed of the minute shells of Foraminifera,

being deposited in the shallow water of the sea. It is thus of animal origin, and well symbolizes the offspring, or life, resulting from the union of male and female principles. And in addition, its common use as a means of facilitating expression suggests the freedom with which the soul, in its evolutionary ascent, expressed itself through incarnating in one form of life after another.

When the state of man is reached, from the lowest human state up to the perfect man, or adept, there is another series of seven states. These states are indicated in the F.C. degree where it is said that the Masons working on Solomon's Temple wrought six days, but on the seventh day they rested. That is, in perfecting the human temple, seven states of consciousness are developed (see Course 3, *Spiritual Alchemy*, Chapter 5 for detailed discussion of these states of consciousness). The ego only becomes incarnated and the man perfect when the seventh state of manhood is reached. He is then a Master Mason, has developed seven states of consciousness, and is at the point of transition where he is ready to function on the spiritual plane of life.

Furthermore, in the spiritual realms there is still another series of seven states by which man passes from spiritual life into angelic form. These are also each marked by a definite development of consciousness. In the seventh state of the spiritual world, due to the permanent union of the two souls that are the expression of one divine ego, the angelic form is attained and the next step is transition to the celestial sphere.

The Red Sea

—The statement is made that the lodgeroom is situated due east and west, not only because it is a model of Solomon's Temple, but also because Moses, after conducting the Children of Israel through the Red Sea, by divine command, erected a tabernacle to God, and placed it due east and west, which was to commemorate to the latest posterity that miraculous east wind that wrought their mighty deliverance.

Now red is the color ruled by the planet Mars, and a sea typifies the emotions. The Red Sea, therefore, symbolizes a condition of sensuality. Sensations, by those who listen to the dictates of the divine soul, are utilized to build a fit tabernacle to God; but to those less worthy they become a snare, and such persons are flooded and drowned in the sea of their own animal propensities. Wind symbolizes aspirations, and the east is the region of light. Therefore, the candidate is informed that through aspiration for spiritual wisdom he may cross the sea of sensuality dry shod, but that those who foolishly enter this sea with unworthy motives are doomed to destruction.

Dimensions and Ornaments of the Columns

—In the F.C. degree we also have a complete description of the two columns, Jachin and Boaz. On the earth Jachin is the region of heat and warmth, the South; but because it is summer when the sun is in the northern half of the zodiac, Jachin in the sky is the northern section of the zodiac. Likewise, Boaz, on earth is the region of cold, the North; but in the sky represents the southern half of the zodiac; for it is coldest when the sun is so situated. These columns are said to be eighteen cubits high, twelve in circumference, and four in diameter; they are adorned with two large chapiters, one on each, and, so the description continues, these chapiters are ornamented with net-work, lily-work, and pomegranates.

That is, the Ancient Masons, as do modern astrologers, considered the zodiac as a belt about the heavens extending 9 degrees each side of the sun's apparent annual path, or 18 degrees high. As there are twelve signs in the zodiacal belt, they are 12 in circumference. The belt is further divided into four quadrants, each quadrant representing the station of the sun during one of the four seasons. It is thus 4 in diameter. And the two halves of the zodiac, representing the sun's station during summer and winter, show Jachin and Boaz united.

These pillars, or sections of the zodiac, are surmounted and adorned by the various stary constellations, the northern constellations forming one chapter, and the southern constellations forming another. These constellations, as any star map will show, are a net-work of lines connecting various stars. Their exalted and spiritual meaning can only be read by those of pure heart, symbolized by the lily; and as indicated by the pomegranate, which is mostly seeds, their interpretations are the seeds of all valuable esoteric knowledge. In human life these two chapiters signify those crowning attributes by which true men and true women differ. The net-work signifies the noble ties that bind together man and woman, the lily-work the purity of their relations, and the pomegranates the fruitfulness of their endeavors on all planes of action when thus united by an exalted love.

The Globes on the Columns

—On these columns are two globes, one on each. They are balls containing on their convex surfaces all the maps and charts of the celestial and terrestrial bodies. In composition they are molten, or cast, brass; and were cast on the banks of the River Jordan, in clay ground between Succoth and Zaradatha, where King Solomon ordered these and all other holy vessels to be cast. They were four inches, or a hand's breadth, thick, and were cast hollow the better to withstand inundations and conflagrations. They were the Archives of Masonry, and contained the constitution, rolls, and records.

The two globes are the celestial sphere, or globe mapping the constellations, and the terrestrial sphere, or globe mapping the earth. For astrological purposes it is necessary to map the heavens at any instant of time in reference to any specific point on the surface of the earth. The latitude and longitude of birth must be known before a birth-chart may be erected, and the longitude and declination of the planets must be calculated. The former data are obtained from a map of the earth, or terrestrial globe, and the latter data are obtained from a map of the heavens, or the celestial globe. The whole of Masonry, as well as the whole of human life, is contained within these two spheres; for they symbolize astrology. They are Archives of Masonry in which the records are kept written in the divine language of celestial correspondence.

The River Jordan represents the boundary between the physical world and the astral world; between Succoth and Zaradatha. On the banks of the River these globes were cast; and because the various planetary energies that stimulate man converge, or unite, on the earth at the point where he stands; that is, the astral vibrations from both heaven and earth meet where he stands to influence him, these spheres are said to be cast in clay-ground; the latter being the symbol of united forces. These forces that converge in man's astral body are from the heaven and from the earth, thus being positive and negative like brass which is a union of two metals, and they are ever on the move, fluxing like the molten brass to which they are compared.

The celestial globe is divided into four quadrants, and by the law of correspondence the terrestrial globe has also four natural quadrants.

They are thus four in thickness. And to indicate that they have an influence over man's life and destiny they are said to be a hand's breadth in thickness. The hand is not only the symbol of work done, of the executive attribute, but because of its five fingers it also symbolizes man. The inundations and conflagrations which threaten these precious maps, which threaten this knowledge of the religion of sky and earth, which alone constitutes the true constitution, rolls and records of Ancient Masonry, are the unreasoning emotions and violent passions of man.

The Long Winding Staircase

—The long winding Masonic stairway, which it is said has three, five, seven, or more steps, refers to the annual journey of the sun. At the winter solstice, for three days before its birth on Christmas, the sun is stationary, moving neither north or south. Then as there are 365 days in a year, and only 360 degrees in the sun's annual cycle, it was customary in ancient times to cross off five days after Christmas. These days were given over to a festival in honor of the sun's birth in the manger of the Goat, Capricorn. And because the sun is then in the sign ruled by Saturn, the festival period was called the Saturnalia. Following these five days, there were yet another seven

days before the epiphany, on which the new born sun was said to first put in an appearance; just as Jesus was said to be twelve years of age before appearing in learned discussion. These seven days, or Masonic steps, in practical magic, are of great importance; for at this time of the year the magnetic forces are peculiarly susceptible and plastic to the will of man.

In human life, according to numerology, the three steps symbolize marriage, the five steps represent intelligence, or enlightenment, and the seven steps the perfect union of body, soul, and spirit with body, soul, and spirit to triumph over physical limitations.

In the F.C. Degree the candidate is admitted into the middle chamber of the temple for the sake of the letter G. G in Ancient Masonry stands for generation, and this ceremony indicates that because the candidate has mastered the mysteries of generation, he is now ready for initiation into the mysteries of regeneration.

Emblems of the Master Mason's degree are of two kinds. Those of the first class are: The Bee-Hive, the Book of Constitutions guarded by the Tyler's sword which points at a naked Heart, the All-Seeing Eye, the Anchor, the Ark, the Forty-Seventh Problem of Euclid, the Hour-Glass, the Scythe, and the Three Steps on the Master's Carpet.

Bee-Hive

—The Bee-Hive is a triple emblem. The hive proper denotes man's physical body. The honeycomb signifies that which is interior to the physical, the astral body. And the honey is symbolical of the spiritual body, which is composed of the choicest nectars and aromas of earthly experience. The bee, which makes the honey, is symbol of industry and creative energy. Both its warlike spirit and its constructive ability indicate that it is ruled by the planet Mars. It thus typifies constructive ability, not merely to multiply the species, but through taking a constructive attitude toward all events of life to gather material experiences and build up the physical form and the astral body to a higher state of perfection, and to incorporate the finer essences, the higher emotions, into the spiritual body of man. As the bee exercises industry and prudence in gathering honey while it may, storing it for use during the long winter, so should man industriously gather experiences, and through a constructive attitude toward them store them properly to serve as spiritual nourishment when the summer of physical life is supplanted by the icy winter of death.

Book of Constitutions

—The Book of the Constitutions symbolizes the Oral Law. The Sword is but an inverted cross; and history proclaims that those who have most ardently adored the cross have been those who most readily took up the sword. Perhaps it was the realization that this would be the case that inspired the great teacher of Peace on Earth to say, “I came not to send peace, but a sword.” As a cross is the symbol of matter, so also is a sword, with the added implication of dire affliction. It thus becomes also a menace and a threat of retribution. As the Tyler is man’s objective consciousness, or reason, his sword guarding the Book of Constitutions represents the consciousness that any violation of the Oral Law will be followed by unfailing punishment.

The All-Seeing Eye

—The All-Seeing Eye typifies the omniscience of Deity, and the limitless powers of the soul to gain knowledge. It also conveys the thought that though there are times when all is dark and dreary for the neophyte, yet he is ever watched over by friendly unseen intelligences, who but await opportunity to convey to him words of comfort and wisdom.

The Anchor

—The Anchor combines in its form the solar circle of spirit, the cross of earth, and the lunar crescent of soul. The ring above, indicates that the body and soul, represented by the cross and crescent, are under the dominion and control of the ego. The crescent and the circle are united by the cross, indicating spirit and soul united in one physical form.

The Anchor thus also symbolizes the Lost Word, Jod-He-Vau-He, which embraces all possibilities within the universe. The circle represents the positive divine fire, the one principle, the creative Jod, or alchemical sulphur. The crescent signifies the receptive plastic water, the feminine He, the alchemical mercury, the universal law of sex. The cross of the anchor represents the union of the two, the Vau, the manifestation of the divine Word, alchemical salt. The figure as a whole represents the product of the union, the final He, the whole divine truth, alchemical azoth. That is, the universe as it now exists is the result of evolution brought about by the union of positive and negative forces; and by correspondence the evolution of the human soul may be facilitated by the application of the truths concerning cooperation.

The Ark

—To explain the symbolism of the Ark we must refer to the biblical version of Noah's experiences. Noah, the central figure of the story, represents the central figure of our solar system, and in the human constitution the ego. The Ark was built in three stories, corresponding celestially to Mundane Houses, Zodiacal Signs, and Starry Constellations; in man to the physical body, the astral body, and the spiritual body, in which the ego functions.

Besides his own family, which is represented in the heavens by the various planets, and in man by his component parts, Noah took into the Ark specimens of every living thing upon the earth. The latter are depicted in the heavens by the numerous objects and animals that make up the starry constellations, and are represented in man by the various vestigial structures and animal traits that he has inherited from the lower forms of life that are his physical ancestors.

The ego, clouded by the emotions of the physical body, cannot manifest its full glory; nor when the winter rains set in can the sun, hidden by clouds, be seen. These represent the flood. The rains, representing sensualism, shot through with the lightning of passion, tend to destroy all life. But those that dedicate their lives to some noble and unselfish work are safe from sensualism, and even as the sun reappears after triumphing over the storms of winter, they arrive triumphantly at a safe haven. The sensual waters, after a time, are assuaged by the wind of higher aspirations, the gentle zephyrs of spring. The raven, bird of ill omen, is sacred to the planet Saturn, the ruler of the sign Capricorn, through which the sun passes when the winter rains are most severe. It is sent out, but returns not. Selfishness and craft, denoted by this Saturnine bird, will bring no good tidings to the ego, nor will such motives bring rest and content amid the swirling waters of desire. Like the raven, they pass to and fro over the tides of sensation, ever seeking, but not finding, rest and shelter.

The dove is sacred to Venus, the planet of love, the planet ruling the spring sign Taurus. It is sent out once over the turbulent waters of sensation, signifying the action of love upon the plane of generation. But no tidings of much worth are brought to the ego. In the heavens this represents the first action of the sun in spring drying the earth. The second going forth of the dove is the action of love on the plane of regeneration. This brings the tidings of future tranquility and peace, as symbolized by the olive leaf. It also represents in the heavens the growing verdure of spring, under the warmth of the sun. The third time the dove is sent forth represents the accomplishment of the full mission, the complete transmutation of sensations into spiritual emotions. The sun transformed the season of rain into a season of gorgeous bloom.

The golden egg of Braham, the oriental type of the ark, is said to have burst. The shells formed continents, the white became the oceans, and the yolk produced, first vegetable life, then animal life, and finally man. This is the egg of the Orphic Mysteries from which the sun bursts with power to triplicate himself. It is really the earth, functioning as the womb of the universe, from which will be born, after its period of gestation, the divine man. Even Noah was imprisoned nine months in the Ark before the tops of the mountains could be seen. Each human soul is ushered into physical life after such a nine months imprisonment. Furthermore, after birth, the body of man becomes the ark in which human life develops; and only at death is it freed from this prison that tosses on the tide of turbulent desire, to enter a brighter world of infinitely more glorious possibilities. The Ark, therefore, will be seen in its various aspects as the symbol of Gestation.

The Forty-Seventh Problem of Euclid

—One of the most important symbols of Masonry is the Forty-Seventh Problem of Euclid. The principles illustrated by it form the foundation of numbers, geometry, and mathematical symbolism. It represents perfectly the Tetragrammaton and the operation of divine law. It is the problem of the right angle triangle. The three sides represent the divine trinity, and the trine as a whole represents the unity of God. The perpendicular line forming one side of the triangle is the Masonic Plumb, corresponding kabalistically to the masculine letter Jod, also to Osiris of Egypt, and to God the Father.

Now nature manifests herself in every septenary by means of three active principles, and four passive forms. The vertical side is consequently divided into three parts representing the three active principles. The number three expresses action, and these three divisions correspond to the three strongest positions of the sun; on the Ascendant, on the Mid-heaven, and on the Descendant. It also corresponds in astrology to the three qualities and the three degrees of emanation, into which the zodiacal signs are divided. Likewise it corresponds to the three active portions of the human constitution; the ego, the divine soul, and the animal soul.

The horizontal side of the triangle is the Masonic Level, corresponding kabalistically to the feminine letter He, also to Isis of Egypt, and to the Virgin Mary of later times. It is divided into four sections to designate the four forms by which the three active principles always manifest. All material things have four relative states—three dimensions and position—and express the active qualities of attraction, repulsion, and motion. The attractive power is represented by gravitation. The repulsive power is illustrated by the cohesion which enables it by repelling other substances to keep its own identity without yielding to their gravitational attraction and fusing with them into a homogeneous mass. Motion is denoted by the change of relative position of every object in the universe.

The number four expresses realization, and corresponds astrologically to the four quadrants of the heavens, and to the four triplicities into which the zodiac is divided. In man it corresponds to the four forms of his constitution; spiritual body, astral body, etheric body, and physical form.

The union of 3 with 4, of a plumb with a level, gives us a Masonic Square of 7, which, properly interpreted reveals the Lost Word of the Master. To become that word, however, it must relinquish the square aspect, and be transformed into two interlaced trines having as a common center the 7th point. As the triangle is presented, however, the third factor of the figure is the meeting point of the 3 and 4, of Sun and Moon, of active and passive, of Jod and He. This right angle is the key to the solution of Euclid's problem, even as it is the symbol of the solution of man's. Astrologically it is the meeting point of planetary energies on the earth, corresponding to the Vau of the word, to the Overshadowing Intelligence of Egypt, to the Holy Ghost of Christianity, to vibration in the natural world, and in human life to union.

Mathematical evolution means the multiplication of a number by itself. The evolution of man is accomplished through the union of the 3 principles with the 4 elements. Their multiplication gives the number of the signs of the zodiac through which the impersonal soul must successively pass, and their union produces 7, the number of component parts of man's constitution.

Evolve the side 3, and the side 4—that is, multiply each by itself—and the sum of these two is equal to the evolution of the third side. This third side, the evolution of which results from the evolution of principles and elements, has the number 5, the symbol of man. This demonstrates, according to the Ancient Hermetic System of Numbers, the evolution of man.

This hypotenuse is the fourth factor of the figure, the product of the union of masculine and feminine forces. It represents, therefore, the climax of evolution on the physical plane. The area of the figure is 6, signifying temptation. This leads to the union of 3 and 4 to evolve man, symbolized by 5, who possesses a 7-fold constitution. The hypotenuse corresponds to the life resulting from the union of solar and lunar rays upon the earth. It also corresponds in man to intellect, kabalistically to the final He of the divine word, to the Egyptian Horus, and in modern religion to the Son of God.

The figure of the 47th problem of Euclid (see illustration at front of chapter) therefore, by its three sides, representing man's principles, and his forms, expresses the cycle of life. This cycle indicates the struggle by the area, 6, which must express through the sides, the sum of which is 12, the number of the zodiacal signs under the influence of which all evolution expresses. By adding together the evolved sides—each side multiplied by itself—we have the number 50, typifying the number

of steps that lead man to adeptship, that evolve man into superman. It is said that Moses was able successfully to take 49 of these steps, but failing in the last he was denied entrance into the promised land. He could see this land of plenty, he had the wisdom to see this final step, but was unable to take it. This, perhaps, was not so much the fault of Moses as that of the times in which he lived.

Incense

—Incense, which is used at times in Masonic rites, has a practical use in ceremonial magic. All magical work comes under definite planetary vibration, and the forces brought into play also, if the ceremony is to be successful, should come under similar planetary influences. Astral beings, and unseen intelligences of all kinds, degrees, and grades, which sometimes are invoked in magical work, correspond likewise to definite planetary rulership. The nature of the work at hand being ascertained, and its astrological correspondences determined, that incense is used having a like astrological rulership. Its function is dual. Primarily, because odors are the most ethereal of material substances, they tend strongly to stimulate the nervous system. Such stimulation causes the generation of electrical energies which tend to strengthen and build up the etheric forces. Secondarily, if chosen with due respect to their astrological vibrations, they act as agents by which man is more easily placed in rapport with invisible entities having astrological vibrations similar to those of the incense.

Symbolically considered, incense represents man's thoughts, and the pot in which it burns represents his body. The fires of passion, or those of aspiration, kindle our thoughts. These, in turn, become burnt offerings either to our lower or to our higher nature. If man's thoughts are kindly and noble they tend to build up his spiritual body; but if they are ignoble and selfish they rise no higher than the astral plane and there distort and disfigure the astral body. When Abel, corresponding astrologically to the moon, and in man to the divine soul, sacrificed his animal passions and creative desires upon the altar, they became an acceptable sacrifice unto the Law. But Cain, corresponding astrologically to Mars, and in man to the animal soul, hoped to propitiate the Law by offers of the fruits of the earth, by offering to buy his way with material things. But the Law of spiritual construction accepts only the highest thoughts and aspirations. These, which incense symbolizes, become a "sweet savor" which build for the ego the spiritual form.

The Scythe

—This is the emblem of the planet Saturn, the ruler of old age and dissolution. It thus symbolizes the harvest of earthly endeavors and the end of life; announcing that the purpose of life is the production of spiritual food. Whatsoever is sown will be reaped, the tares as well as the wheat. The crescent blade symbolizes the soul, the handle represents the material body. The function of the soul thus expresses as a means of garnering the harvest of experience in matter. The soul moves on, harvesting as it goes, the end of one life being the beginning of another. Death forces the expiation of every evil, adjusts all apparent inequalities, and in the spheres of the disembodied the keen blade becomes the sword of conscience. Death is the great leveler.

Chapter 8

Serial No. 13
Original Copyright 1939
Elbert Benjamine

Copyright
Church of Light
August 2002

Master Mason

Chapter 8

Master Mason



THE MASTER MASON'S lodge represents the sanctum sanctorum of King Solomon's Temple. That is, it is the inmost, or spiritual plane of the cosmic edifice. Such a lodge, it is said, is composed of three Master Masons—The Master, the Senior Warden, and the Junior Warden—typifying in the constitution of man the ego, the divine soul, and the spiritual body. It will thus be recognized that the Master Mason's lodge typifies existence in the spiritual world.

In the spiritual world the ego and divine soul function in a spiritual body; and the other four factors of man's constitution have been lost. At the death of the physical body both the material form and the etheric form gradually disintegrate. The soul then lives upon the astral plane and functions in an astral body. After its cycle of existence on the astral plane—undergoing first, if gross or materially minded, a period of purification in the lower astral regions corresponding to the purgatory of Roman Catholicism—occurs the second death, in which the astral body and such of the animal soul as had not been transmuted into divine soul, disintegrate; permitting the soul to live unfettered in the spiritual body on the spiritual plane.

The candidate for this degree is prepared by being stripped naked and then furnished with a pair of drawers reaching just above the hips. His drawer legs are both rolled above his knees, and his shirt is slipped down about his body, partly covered by his drawers, the sleeves and collar dangling behind over his waistband. His eyes are bandaged and a cable tow is wound three times around his body.

Both feet and both arms are left bare to indicate that both the understanding and the ability to work are unimpaired on the astral plane and on the spiritual plane. The shirt, symbolizing the astral body, though largely discarded, still clings to the candidate. This indicates that while yet in a physical body he may travel on the spiritual plane in the spiritual body, but that there must also be a connection with the astral body, that through it the connection with the physical may not be entirely severed. That is, a portion of the astral body must be used to preserve communication between the spiritual and the physical.

The woolen drawers are no longer red; for the animal part of man has been lost; yet the presence of this woolen underwear still serves to draw the attention to the importance of creative energy even on the spiritual plane. The candidate is blindfolded; for he is first represented as so newly arrived from the astral plane as to be unable to see things spiritual. Yet he has lost two-thirds of his clothing to indicate the loss of his outer forms. The cable-tow is wound around him, in the region ruled by the sign Libra, three times. Taurus is an earthly sign, and more typical of earthly love; but Libra, the day sign of Venus, typifies the more spiritualized love; such a love as triples the bond between soul and ego.

Tubal-Cain

—The candidate desiring to enter the Master's lodge must knock three times; signifying his desire to enter the third, or spiritual plane. The pass word is Tubal-Cain.

Now Cain, according to the Bible, was a murderer; hence symbolizes Mars in its destructive aspect. But Tubal-Cain was an instructor of every artificer in brass and iron; was versed in the constructive use of iron, or Mars, and of brass, which is two metals in union. Cain thus represents the sex sign Scorpio in the aspect pictured by the deadly scorpion; while Tubal-Cain represents the sign in the aspect pictured by the eagle. And as the eagle is the highest flyer among the birds, so Tubal-Cain is the symbol of that complete regenerate marriage by which, according to the doctrine of the Ancient Masons, spiritual realms may be contacted.

As the candidate is permitted to enter, the two extreme points of a compass are pressed against his naked right and left breasts, indicating the subjugation of all the lower desires as well as the nobler aspirations to the spiritual laws, as signified by the compass, that govern regenerate union. He is then led around the room three times in the direction the Sun travels, and as he passes the Junior Warden, the Senior Warden, and the Master, they give him each during the first time around one rap, during the second time around two raps, and during the third time around three raps. This is to indicate that each of his three higher components—spiritual body, divine soul, and ego—have had an influence over him during his progress on the physical plane, on the astral plane, and on the spiritual plane.

Preparation for Life on the Spiritual Plane

—While he thus travels about the room the Master reads from the Bible the first seven verses of the twelfth chapter of Ecclesiastes:

Remember now thy Creator in the days of thy youth, while the evil days come not, nor the years draw nigh, when thou shalt say, I have no pleasure in them; while the sun, or moon, or the stars be not darkened; nor the clouds return after the rain; in the day when the keepers of the house shall tremble, and the strong men shall bow themselves, and the grinders cease, because they are few, and those that look out of the windows be darkened, and the doors shall be shut in the streets, when the sound of the grinding is low, and he shall rise up at the voice of the bird, and all the daughters of music shall be brought low: Also when they shall be afraid of that which is high, and fears shall all be in the way, and the almond tree shall flourish, and the grasshoppers shall be a burden, and desire shall fail; because man goeth to his long home, and the mourners go about the streets: Or ever the silver cord be loosed, or the golden bowl be broken at the fountain, or the wheel broken at the cistern. Then shall the dust return to the earth as it was; and the spirit shall return unto God, who gave it.

This whole passage is an exhortation to the candidate to prepare to abide in the spiritual world, pointing out the transitory and unsatisfactory nature of all things below the plane of spirit. The number 12 is the number of sacrifice, the number indicating the end of the cycle of life, the completion of the zodiacal wheel. This twelfth chapter then, quite consistently, warns that the physical must inevitably end and that there should be a sacrifice of the lower nature. The vital forces, symbolized by the sun, the mental forces, symbolized by the moon, and the powers of perception, symbolized by the stars, should be sacrificed to higher things in youth before the years of sterility approach, while the natural forces are undimmed by clouds of emotional storm. The grinders, of course, are the planets which move over the zodiac as millers in this mill of the gods; and when their ability to vivify man's body ceases, the windows of his soul are darkened, and the doors of his speech close, the vibrations cease their harmony, or music, and he passes as a bird might fly, in his astral body to the astral plane.

In the astral world the memory pictures of his good deeds and his bad deeds are with him, and he that has been guilty of wrong-doing must atone. Hence the fears, and the elements of destruction symbolized by grasshoppers. But the good deeds shall be a joy. Such are symbolized by the almond tree, which, like Aaron's staff that budded, is a symbol of creative power.

The silver cord is the magnetic thread connecting the spiritual body with the astral body. The golden bowl is the vital forces animating the candidate, which become broken at the fountain from which they spring, and the wheel is the birth-chart which is broken at the cistern of emotional expression. Then does the physical return to the physical and the spiritual return to the spiritual.

This all recalls to the candidate the inevitableness of death, and admonishes him to prepare while yet in the flesh, through purification and the sacrifice of his lower nature, for life on the higher plane; also suggesting that such preparation is quite as necessary for one who before death expects to travel on spiritual planes.

Next, the candidate is led to the west, representing the material plane; and is instructed how to approach the east, the place of light, representing the spiritual plane, by advancing upon three upright regular steps, to the third step in Masonry, his feet forming a square, his body erect. This is accomplished by first stepping off with the left foot and bringing the heel of the right into it, signifying the understanding of generation; and then stepping off with the right foot and bringing the heel of the left into it, signifying the understanding of regeneration; and finally stepping off with the left foot and bringing up the other so that the heels are together with the feet at right angles, signifying the understanding of spiritual union. That is, these three steps indicate that the candidate has mastered the knowledge of generation, regeneration, and the great work.

He then kneels before the altar on both naked knees and raises both hands to heaven with the arms bent. This is called the hailing sign. The kneeling position, both knees being bent, signifies obedience upon the part of both to the admonitions of the higher self, and the uplifted bent arms that they join in work upon the higher planes. In this degree both points of the compass are shown above the square, indicating that through obedience to the spiritual laws governing generation and regeneration the candidate has freed himself from the limitations imposed upon him by his physical and astral bodies. At this point, as in other degrees, the bandage is removed from his eyes, signifying here that he perceives clearly the things of the spiritual plane.

The sign of a Master Mason is given by raising both arms as in the hailing sign, letting them fall, and saying, "Is there no help for the widow's son?"

The widow's son is the divine soul of man, who has long been separated from his Father in Heaven, the ego, and dependent upon mother nature. The two hands represent the two divine souls of one ego, and the bent arms signify their desire for reunion. The hands falling to the region of Scorpio, as well as the spoken sentence, indicate the despair of reaching spiritual heights through mere physical means. The dieuard of the degree shows where the hope lies. It is made by drawing the right hand, palm down, from left to right across the abdomen in the region ruled by the sign Libra and letting it fall to the side. Libra, as well as Scorpio, is a sex sign, but being an airy sign it symbolizes unselfish love and spiritual union.

The pass-grip of a Master Mason is given by pressing the thumb of the right hand between the joints of the second and third fingers where they join the hand. The pressure is between the finger ruled in palmistry by Saturn, symbolizing the earth, and the Sun, symbolizing spirit. It thus betokens desire to transmute and refine. Its name is Tubal-Cain, signifying regeneration accomplished; and the word is given in three syllables—Tu-Bal-Cain—to denote that the work has been accomplished on all three planes.

The apron, in this degree, is worn with the triangle down over the square. This indicates that spiritual energies have completely permeated the creative forces, and that the ego has come into full control of the physical form of man.

The Trowel is Especially Significant

—The working tools of a Master Mason embrace all the implements of masonry; but particular attention is given to the trowel. The trowel in form is a triangle surmounted by a plumb, representing the higher trinity of man's constitution—ego, divine soul, and spiritual body—receiving and utilizing the divine fire of creative energy. Its significance is that of another symbol, the trine in the center of which is the Hebrew letter, Jod. It is an implement used in joining stones to form a single structure, and is thus symbolical of creative energy used to bind together in consciousness the various experiences of life that build the temple of man.

In the Master's degree, however, which has to do with the spiritual plane, the trowel has an added significance. It signifies the use of creative energies to bind together permanently twin souls. This inseparable union, which according to the ancient doctrine insures joint immortality, takes place on the boundary of the sixth and seventh states of the spiritual world. Henceforth the two divine souls occupy but one spiritual body. These two and the one body they occupy form the triangle of the trowel. The ego which is common to both is signified by the handle. The triangle, in this aspect, thus represents the Lost Word recovered, as elaborated in the death, burial, and resurrection of the Grand Master, Hiram Abiff.

The Tragedy of Hiram Abiff Represents the Cyclic Journey of the Soul

—This tradition informs us that at the building of Solomon's Temple there were present three Grand Masters: King Solomon, as instigator of the work, is symbolical of the sun in the sky and the ego of man's constitution. Hiram, King of Tyre, furnished the wood; the mental experiences, or perceptions. He typifies the spiritual body of man, the planet Mercury in the finished macrocosmic structure and, as the most earthly of the three, the mundane angles where the rays of sun and moon meet. Hiram Abiff was the widow's son, employed by King Solomon because he was a cunning artificer, a skillful worker in all kinds of metals, stones, timber, and cloth, and engraving upon them. He, of course, symbolizes the divine soul. Thus the ego instigates the work, the body furnishes the materials, or experiences, and the soul truly builds them into a fitting temple.

“It was the usual custom of the Grand Master, Hiram Abiff, every day at high twelve when the craft went from labor to refreshment, to enter into the sanctorum, or holy of holies, and offer up his adoration to the ever-living God and draw out his plans and designs on his trestleboard for the craft to pursue their labor.” The craft are the celestial bodies that are more readily seen at night; for as midday is the period of maximum sunshine the heavenly bodies are then more difficult to see, and may be said to be at refreshment.

Now if we turn for a moment to the Kabala, we find that the holy of holies, called by them the Shekinah, is the place where the devoted retire for communion with higher powers. This Shekinah on earth, by them, also represents a spiritual union of man and woman, a union represented in the sky by the joining of the sun and moon, that is, new moon. And as our narrative relates to the temple of the sun, his holy of holies, his own sign, the sanctum sanctorum of the sun is the sign ruled by it, Leo. Our story starts, then, at noon, with a new moon in the first degree of the sign Leo. Hiram Abiff, symbolizing the divine soul of man, is represented by the moon.

Fifteen (this is the number of Satan and of black magic) Fellow Craft conspired to extort the Master’s word from Hiram Abiff, and in case of refusal to kill him. Twelve, representing the twelve zodiacal signs, repented and confessed; but three, representing the three visible angles—Midheaven, Descendant and Ascendant—carried out the crime.

The names of the three ruffians that committed the crime were Jubela, Jubelo, and Jubelum. Now in the Bible Jubal is mentioned as the father of all such as handle the harp and organ. This refers unmistakably to the sign Leo, which rules the house of pleasures and entertainment of all kind in a natural birth-chart. Hence we start the story at the beginning of the sign Leo. In the same passage, but not of significance to this story, the three other signs that each rule one of the four quadrants of the heavens also are mentioned. Thus Jabal was the father of such as dwell in tents and have cattle. This refers to Taurus. Tubal-Cain was an instructor of every artificer in brass and iron. This denotes, as previously mentioned, the sign Scorpio. And Enoch, the perfect man, represents the Man of the zodiac, Aquarius.

Jubel, it is quite clear, is the sign of the sun. The designation of the three ruffians is shown by the suffix. The meaning of the letters used as suffixes to Jubel may be had by referring to Course 6, *The Sacred Tarot*, the Hermetic System of Names and Numbers. The letter A corresponds to the planet Mercury, and to the attribute of will. The letter O corresponds to the planet Mars, and the attribute of destruction. The letter U corresponds to the planet Venus, and to pliability. The letter M corresponds to the zodiacal sign Aries, signifying transition through death to birth in a new life.

The sun and moon are represented in conjunction in the midheaven in the first degree of the sun’s home sign, Leo; and evidently in some manner the Master’s Word, which the villains try to obtain, refers to the most spiritual union thus symbolized.

Jubela, so the story goes, is stationed at the southern gate of the temple, or at the midheaven. He grabs the Grand Master and handles him roughly, demanding that he give the password. Hiram replies that if he will wait until the temple is completed and the Grand Lodge assembles at Jerusalem, and he is found worthy, it will be given to him.

Now the “a” as a suffix to Jubel signifies will, in this case the will to obtain the knowledge that confers immortality. The moon is with the sun, indicating that the soul has not yet separated from its divine ego, nor from its counterpart. Nevertheless, there is the will for conscious immortality. But it is only through experiences with external life that the spiritual form of man can be constructed, and only when this form has been completed that the permanent union of the divine counterparts can take place. And this constitutes the Master’s Word as applied to the spiritual plane.

Not receiving the word, Jubela strikes the Master a blow across the throat with a twenty-four inch gauge. The twenty-four inch gauge represents the twenty-four hours of the day, hence the diurnal cycle of the sun. The throat is ruled by Venus, the planet of love. Hence the blow on the throat signifies the rupture of the ties of love by time; the separation of the twin souls at the moment of their involutory descent from the spiritual world to gain experience. In the more personal sense, it signifies the effects of time to alienate the affections of the husband and wife when the sacred rites of love are violated.

The Master rapidly retreats toward the west gate, the Descendant, which is guarded by Jubelo. Thus is the moon, as it separates from the sun, carried by the diurnal rotation of the earth immediately to the western horizon, or Descendant. And thus also is the soul, in its involutory descent before its first material incarnation, rapidly carried down to the place where it enters the physical realm. So too, the man or woman who violates the sanctity of love tends quickly to sink into the darkness of materialism.

Jubelo—representing the destructive tendency of Mars, the destructive tendencies of unwise unions; for the western horizon in astrology is the place of partnerships and unions, as well as of strife—gives the Master a blow across the breast with a square. This square, while symbol of inharmonious union, also represents the first quarter of the moon as it separates from the sun, and is a destructive astrological aspect. It typifies the soul joined, at last, to a material body. In a more personal sense it indicates inharmonious relations which injure the aspirations, these being symbolized by the breasts.

The Master then goes to the east gate which is guarded by Jubelum. This signifies that the moon, separating from the sun the while, is next carried by the diurnal motion of the earth from the western horizon, where it sinks, to the eastern horizon, where it rises. In relation to the progress of the soul, the period during which the moon is beneath the horizon, and invisible, represents its evolution through the various material forms of life below that of man. The east gate, where the moon rises into view, symbolizes the state where the soul rises from the purely material and incarnates in the intellectual being called man. Applied to humanity at large, this indicates the desire for more knowledge.

Jubelum strikes the Master upon the forehead with a gavel, whereupon the Master falls dead. This signifies that the moon arriving at her second quarter, receives the maximum force of the sun's rays, and is at the furthest point from her heavenly spouse. After this time, according to astrology, vital and magnetic forces begin to decrease, or die. This signifies also that the soul, arriving at the state of manhood in its evolutionary ascent, is tempted by, and becomes a slave to, sensations. The pure unsullied intuitions of the soul as to proper conduct are slain by the use of reason and an unbending will (the gavel). As applied to humanity at large, this indicates that having departed from the true source of light, yet seeking knowledge, it often falls into one of two destructive extremes: dissipation, or the complete annihilation of the emotions and sentiments through the use of an unbending will. Either deadens the soul to things spiritual.

Now the Grand Master having been killed, is carried out the east gate and buried with rubbish at low twelve. We have three thoughts here. The moon at full passes above the horizon. Twilight obscures it, and as it is waning, instead of growing brighter it grows dimmer, is covered with rubbish. This burial is at low twelve, because at midnight the sun having reached the lowest point in its daily cycle, the moon has reached the highest point overhead, and exactly at low twelve (midnight) descends toward the horizon, descends into the grave. In the soul's progress its first efforts to learn the truth lead it to become buried in the various theories of materialists or the innumerable uncritical fantasies of mysticism, both of which are still further covered with the dust of prejudice. As applied to humanity at large, it represents man and woman seeking light, but blinded by false teaching and covered with the rubbish of illusory doctrines.

The Grand Master is carried at low twelve in a westerly direction, and there buried in a grave on the brow of Mount Moria; the ruffians hurrying, as the Master already begins to smell. That is, the moon after midnight of its full does travel to the west and sink in her grave below the western horizon. The reference to the smell signifies that she has begun to decrease in light, or decompose.

Mount Moria is the region of sacrifice. But it should be remembered that Abraham was finally commanded by the Lord (Law) not to sacrifice his son, not to sacrifice the human qualities as is done in asceticism; but to sacrifice only the Ram, or creative energies, on the altar of his devotion. The soul all too often, slain by false reasoning and covered with dogmatic debris, sinks into the west of materialism, and sacrifices

its spirituality on the mountain of material ambition. This spiritual decay is indicated by selfish thoughts. As applied to mankind as a whole, man and woman may be misled by false doctrines and fall into destructive practices or into morbid asceticism, thus to be buried on the mountain of sensual desire, or in the tomb of vain and foolish sacrifices. The vibrations of sensualism and those of asceticism alike are offensive odors to the spiritual senses.

The Grand Master is buried in a grave six feet due east and west, and six feet perpendicular. The grave is marked by a sprig of cassia. This grave, or lowest point in the daily journey of the moon, is the nadir. The grave is as long, therefore, as from the eastern horizon to the western horizon. That is, the moon is invisible while in six mundane houses, or feet. It is buried as deep as from the midheaven to the nadir. That is, six mundane houses, or feet, deep. And it is marked by a sprig of cassia because cassia, always being green, symbolizes immortality. It thus promises resurrection.

This resurrection of the human soul is symbolized in the heavens by the moon being raised through the diurnal rotation of the earth on its axis from the nadir through six houses to the midheaven. All above the horizon symbolizes the spiritual realm, and all below the horizon symbolizes the physical realm. Therefore, the six houses, or feet, east and west symbolize the boundary between the spiritual and physical planes. This boundary marks the region of struggle that precedes the entering of the ego into full control of the physical form, which takes place when the seventh state of manhood, or adeptship, is reached.

Applied to humanity at large, the six feet east and west typify the material horizon, and the struggle to obtain the physical necessities of life and at the same time encourage the spiritual nature. The six feet perpendicular represent the six states of the soul world which the soul must traverse before it can permanently be united to its missing mate. Applied to humanity as a whole it represents the antagonism between the sexes, their misunderstandings of one another, and the temptation to yield to the dictates of the senses. This significance of the number six was given in chapter 4.

The sprig of cassia, in each case offers the hope of redemption through the rejuvenating action of the creative principle. Fire, in the days of the Ancient Masons, was used as a symbol of the sun; and the wood that fed the fire also was considered a creative symbol. Cassia being ever verdant, adds the thought of perpetual youth and life to the symbol of the creative principle signified by its wood.

After the murder of Hiram Abiff the three ruffians try to get a passage to Ethiopia; but they only get as far as Joppa, symbolizing the astral realm. Ethiopia is the land of darkness lying to the south of Jerusalem. While the sun is in Leo and the moon is making this symbolic cycle, the sun moves southward, and the points where he rises, culminates, and sets—the three ruffians—also travel southward. These ruffians are discovered by a wayfaring man—the sign Pisces, which rules the feet of man and is the sign of imprisonment—for the full moon, when the sun is in Leo takes place in Aquarius, and the moon immediately passes into Pisces.

The soul also, in its pilgrimage, may try to escape from the penalty of its folly by seeking oblivion in death, but only reaches the astral realm, where it is imprisoned and must give an accounting in full to the ego, its King Solomon, for its crime. And mankind may seek a like oblivion for itself in the doctrines of materialism; but the absurdities of such a course are quickly revealed by those psychic investigations ruled by the sign Pisces, and it must finally be brought before the throne of spiritual enlightenment.

Hiram Abiff was discovered missing at low six, when as usual King Solomon came up to the temple. He found all in confusion, no plans having been laid out on the trestle-board for the craft to follow. At full moon, which is the period we have been considering, the moon sinks below the horizon, and is discovered missing, and the sun, Solomon, rises in full sight, at 6 a.m. The light of the planets wanes and becomes confused, owing to daylight. The soul of man, reaching the sixth state of manhood, or cosmic consciousness, realizes it is separated from the ego, and that until they become again united its work is not directed from the spiritual plane; the work is not properly laid out. Applied to humanity, man and woman having arrived at a state of antagonism are able to form no efficient plans because of lack of co-operation.

Twelve Fellow Craft Masons, the twelve zodiacal signs, are sent to hunt for Hiram. Three, taking a westerly course—that is, setting—get news from the wayfaring man, Pisces. Finally one of them sitting down to rest on the brow of Mount Moria, the horizon, discovers the sprig of cassia, at the point of union of night and day. This promises the coming resurrection, for the moon will rise again, as will the soul that sinks into the grave. At this point, also, are discovered the three assassins, or visible angles. The three Fellow Craft that discover the assassins, represent the three zodiacal signs through which the moon moves from full to last quarter. They report the discovery to King Solomon, the sun, who sends another to look, that is, the sun during the moon's journey around the cycle has moved forward a sign, so the moon to reach it must, in addition to the twelve, move also through this sign.

When the body is uncovered, an offensive smell arises. The moon is still decreasing, or decomposing, in light. A search is made for the Master's Word, but nothing is found except a faint resemblance to the letter G marked on the left breast. The letter G found on the body is not recognized as a key to the Master's Word; for being on the left breast it signifies generation impelled by material motives. Yet while not the Word itself the discerning will not fail to note that it is the key to the word. The three signs by which the body is discovered represent the explorations of the soul on all three planes. Applied to humanity at large, it signifies material, mental, and spiritual effort.

The Master, finding the Word lost, repeats three times the Master's sign and the words; "O Lord, my God, is there no help for the widow's son?" Unless the word, to which Generation is the lost key, be recovered, there is little help on any of the three planes for the soul, nor as applied to humanity is there much hope of greatly improving the condition of the world.

Twelve Fellow Craft, zodiacal signs, are summoned to go with Solomon, the sun, to raise Hiram Abiff, the moon. They form a circle around the grave—the zodiacal signs form a circle—and the Master offers up a lengthy prayer the purport of which is a plea for immortality. The Master then directs that the body be raised by the E.A. grip, Boaz; but the skin cleaves from the flesh and it cannot be thus raised. Immortality cannot be attained by the application of mere physical methods; for the body is not the man, no more so than the skin is the whole body. It is next proposed to raise the body with the F.C. grip, Jachin; but it cannot be done because the flesh cleaves from the bone. The soul is not assured of immortality when it can work on the astral plane; for the astral body is not the whole man, no more so than the flesh is the whole body.

Finding the grip of the two lower degrees inadequate, the Master raises the candidate for the Master's degree, who represents Hiram Abiff, with the Master Mason's grip, upon the five points of fellowship, uttering in his ear the Word Mah-Hah-Bone, used as a substitute for the lost Master's Word.

This Master's grip is called the Lion's grip, because it is typical of the sun's action in the sign Leo where it exercises its most virile power. It is made in shaking hands by sticking the finger nails of each of the fingers into the joint of the other's wrist where it joins the hand. The five fingers of one hand represent woman, and the five fingers of the other hand represent man. As all portions ruled by the various planets thus come in contact, it represents complete fusion, soul infiltration of soul. Such is the powerful influence of the Sun in the love sign Leo, by which the Moon is again united to it; denoting the eternal union of twin souls through which their united immortality becomes assured. It is called Mah-Hah-Bone, because the word, signifying marrow of the bone, denotes a more complete fusion than that of the physical, symbolized by the skin; or of the astral, symbolized by the flesh; or even of spiritual bodies, symbolized by the bone. It refers to the complete and permanent soul union between natural counterparts, soul of soul, heart of hearts.

The raising on the five points of fellowship is accomplished by taking the candidate, who represents Hiram Abiff, by the Master's grip and lifting him by bracing the right foot against him. When raised, the Master's right foot is inside his right foot, the inside of the Master's knee is against his, the Master's breast against his breast, and their left hands are on each other's backs, each putting the mouth to the ear of the other, in which position alone the Master's word may be given.

In this manner the fullness of the reunion between sun and moon is designated. Being together, both receive the five points, that is, the same aspects from the other five planets. The three attempts at raising account for the three signs through which the moon passes from its last quarter to reach new moon, which is its union with the sun. By this time the sun, having started at the first of Leo, has reached the 28th degree of the sign. According to the Hermetic System of Names and Numbers (see Course 6, *The Sacred Tarot*), 2 plus 8 equals 10, which is the number of man and woman, that is, the union of two 5's, or the five points of fellowship.

The soul also, having taken its cyclic pilgrimage from spirit into matter and from matter back to spirit again, not only arrives at its original state of exaltation in the spiritual world, but the ego, having gained wisdom and love through its soul's experiences, has passed to still higher spheres, and the soul uniting with it is raised to these regions. Applied to humanity as a whole, through the reestablishment of harmonious relations between man and woman, and their united efforts, the misery that has resulted from their strife is banished, and they become efficient agents for building up a better world.

The union of foot to foot (Pisces) represents mutual understanding, which is essential to united effort. It further refers to united effort in spiritual science and psychical research, because these are ruled by the sign Pisces.

The union of knee to knee (Capricorn) typifies the value of mutual service. In this manner co-operation yields the best results. It also indicates that there is united effort in regard to material attainment, for this too is ruled by the sign Capricorn.

Breast to breast (Cancer) signifies that if best results are to be obtained there must be unity of aspiration. It also indicates that the magnetism of each should nourish and sustain the other, and that there should be unity in the home, for these things are ruled by the sign Cancer.

The left hand to the back (Leo) of the other shows that each should work in a physical way to strengthen and support the other. Each should support by his mental endeavors, ruled by Gemini, the ambitions, ruled by Leo, of the other.

Lastly, there should be complete and mutual exchange of confidences between husband and wife, such as is denoted by mouth to ear (Taurus). And the lips should offer encouragement to the other, and both should fulfill their financial obligations, these being ruled by Taurus.

How the Five Points of Fellowship Do Their Work

—The number five is the number of Jupiter, the planet of religion. And if the resurrection of the soul, Hiram Abiff, is to take it through the astral realm—the upper regions of which commonly are called the spiritual realm, but are not, as although their vibratory rates are high, the velocities are still those which pertain to astral substance—there must be great devotion, not to piety or any special orthodox belief, but to true religion.

Velocities of substance below that approximating light define the substance as physical in nature, and thus as belonging to the material plane. But when velocities are attained greater than that of light, that defines the substance moved as no longer physical, but as belonging to the inner realms. The planetary vibrations that affect human life and destiny, the thoughts of man, and the unconscious minds, not only of men, but of all other creatures, persist in substance having a velocity greater than the Boundary-Line etheric energy, of which light, radiation and electricity are well known manifestations. That is, they occupy the astral plane, and are not restricted by the limitations imposed upon purely physical existence.

Things, by the mere circumstance of their physical existence, also have astral counterparts in the astral realm; and all life-forms on earth, when the physical is destroyed, tend to persist for some time as astral life-forms in the inner realm. Good and bad, high and low, vicious and saintly; people continue existence after physical death on the astral plane.

But although there are fewer limitations to existence on the astral plane than on the physical, it too has its own restrictions. Life there is not everlasting. Planetary currents and the cycles which affect astral life in time cause the dissolution of the astral form, more slowly, to be sure, than the physical is caused to disintegrate, but none the less surely. Immortality is not static, but depends on eternal progression.

When velocities still higher than those which astral substance can attain are reached, new properties are at hand, and that which is affected is spiritual substance. But while all life-forms on earth have an astral counterpart in which they survive for a time after physical dissolution, none has a spiritual body until that form is built, either from the material plane before death of the physical body, or from the astral plane, where time and opportunity also are present, before the second death dissolves the astral form.

If the individual is to continue to survive he must construct, by the quality of his aspirations, thoughts and feelings, a body in which he can function on the plane of velocities still higher than the astral, the real spiritual plane.

While the range of vibratory rates on one plane often greatly overlaps those of another plane; for molecular vibrations may be more rapid than some vibrations in the Boundary-Line etheric substance; nevertheless, vibratory rates of a particular kind can be used to affect substance on a still higher plane. That is, much as the molecular vibrations of a piece of iron when they become sufficiently rapid through heating, impart energy to etheric substance which we recognize as light, or an electric light filament glows, so aspirations based on definite motives, love of the less selfish kind, and certain combinations of thoughts which act as a flux one with the other, affect spiritual substance directly. That is, the vibrations imparted to astral substance by these mental states have the property of affecting spiritual substance which has velocities that astral substance cannot reach.

And in the Master Mason's degree particular stress is placed upon the higher types of love thus to affect spiritual substance and build a spiritual form. Yet true religion in its practice, although not so easily, also can be utilized for this purpose. This, however, implies much knowledge of Spiritual Alchemy (explained in detail in Course 3, *Spiritual Alchemy*), determined practice in thought control, and devotion to Universal Welfare.

The individual, regardless of his physical environment, who resolutely directs all the acts of his life, including his thoughts and emotions, to those things which after due thought he believes are in the interest of society as a whole, by so doing is being raised on the five points of fellowship. He is gaining in understanding (Pisces), co-operating in attaining (Capricorn) practical benefits for mankind, developing exalted aspirations (Cancer), strengthening (Leo) his will, and mentally exchanging confidences and receiving (Taurus) encouragement from those still further along the path who impress him from the inner plane.

In fact, to be truly a Master Mason implies that through diligent practice one has learned how at all times to maintain a constructive attitude, and to keep the thoughts directed to the accomplishment of those purposes which are of greatest assistance to mankind. It implies that one has so conditioned his emotional nature that anger, fear, hatred, grief, disappointment and jealousy are never felt; and that instead there is at all times, and toward all persons, a feeling of benevolent kindness, which may nevertheless be strict and firm; and that one has acquired the ability to feel, with no great effort exalted love and tender affection.

Mastership, according to Ancient Masonry, thus is seen to be a very different thing from the popular conception that to be a Master one must retire from the world and devote the time to meditation and so-called spiritual practices. In fact, true spiritual practices are now seen to rest upon man's contact with others. It is impossible to acquire spirituality or true Mastership through selfish seeking. Instead, they come only as the result of pronounced effort to assist others.

It is not primarily to gain spirituality that the Master learns to develop a steady, positive and rather high electrical potential, through which he is able to shut from his consciousness thoughts of others or thoughts of his own which he has decided are not constructive, and through which he is able to maintain control of his emotions. He learns to do this, and to extend his consciousness to the inner plane and there acquire information not to be had through other channels, because these abilities enable him to help the people he contacts.

When, depends upon individual circumstances. But one who thus develops the other requisites of a true Master Mason, will not too long have to wait for union with the soul of his soul. For now it will be apparent that the whole tragedy of Hiram Abiff, and his later resurrection, are meant to symbolize the soul's separation from its divine counterpart, its separate journey through the cycle of involution and evolution, and its final attainment of an immortal life through reunion with its lost mate.

In Egyptian tradition Osiris is dismembered, but the fourteen pieces representing the fourteen days from full moon to new moon, are collected and reunited by Isis. The ashes of Hiram, however, are represented as having been buried under the sanctum sanctorum, and a monument erected over them figuring a virgin weeping over a broken column, with a book before her, in her right hand a sprig of cassia, in her left hand an urn; Time standing behind her, with his hands infolded in the ringlets of her hair.

The virgin is Isis weeping over the slain Osiris, her lost mate, signified by the broken column. That immortality be assured, as suggested by the cassia, it becomes necessary under the law, signified by the book, that reunion take place. This has not yet occurred, for the urn, symbol of affections, is still empty. Hair is ruled by the planet Venus, and until the reunion takes place her affections bind her to the realms where time is master. Applied to humanity at large this ensemble signifies the destruction of the better impulses of the soul through the abuse of the creative energies.

The involution of the soul into matter and its evolution back to spirit, is symbolized astrologically by the Sun's journey through the zodiac, as related in chapter 5. But the separation of the two halves of the divine soul and their subsequent reunion after the pilgrimage of zodiacal cycles is symbolized astrologically by the separation of the sun and moon, and their ultimate reunion. It may be thought that the Ancient Masons were somewhat arbitrary in enacting the scene with the sun in Leo, but not so in fact; for in practical magic, at which they were adepts, operations of an electric and repellent nature are more successful if initiated at noon of the day of the first new moon after the sun enters Leo. On the other hand, as any astrologer readily understands, operations of an attractive and magnetic nature are more successful if initiated at midnight of the day of the first full moon after the sun enters Capricorn.

As Isis of Egypt searched for the fourteen fragments of Osiris, and as the moon decreases for fourteen days between full moon and new moon, so we need not be surprised to find it related that Hiram Abiff remained fourteen days in his grave before being resurrected.

In the individual horoscope the tragedy of Hiram corresponds to the revolution of psychic forces within the astral body of man from month to month and from year to year. It is the magical cycle of the soul as measured from one transit of the moon over the radical place of the sun to another such transit; and this is the exact measure of psychic power received by the individual from month to month. It has a most important practical application, for soul powers are found to have their periods of ebb and flood, there being times when it is possible, and there being times when it is not possible, to establish the essential conditions necessary for the successful practice of high magic. This phase of the matter is explained in detail in *Award Manuscript 13*.

Chapter 9

Serial No. 14
Original Copyright 1939
Elbert Benjamine

Copyright
Church of Light
August 2002

Mark Master Mason

Chapter 9

Mark Master Mason

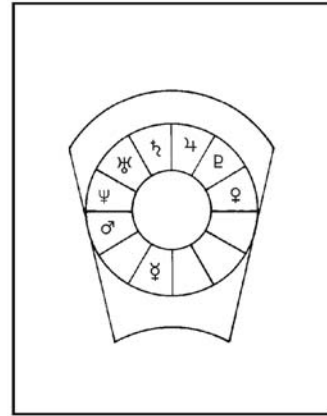

THE FOURTH DEGREE of Masonry, to be consistent with the science of numbers which associates four with Realization, relates to the realization and utilization of the powers and functions conferred by the first three degrees. Thus does the fourth Major Arcanum of the tarot (see Course 6, *The Sacred Tarot*, Chapter 4) become a commentary, in the language of symbolical pictograph, on the Mark Master degree of Ancient Masonry.

The divine Tetragrammaton of the kabalists summarizes all potencies in a word of four letters. Astrologically, all celestial influences are synthesized in the four-fold form of the sphinx. And in Ancient Masonry the whole of essential Masonic doctrines are compressed within the first four degrees; additional degrees being merely an elaboration of what in its essence may be found in Entered Apprentice, Fellowcraft, Master Mason and Mark Master degrees; Mark Master denoting that the soul has reached maturity and is at the period of its fruition.

To open the Mark Master lodge eight officers are necessary and ten usually are present, corresponding to the seven planets of man's seven-fold constitution, plus the three upper-octave orbs, or overseers. Uranus, Neptune and Pluto are truly overseers in the sense that when injustice and tyranny become rampant on earth, the factors within the unconscious minds of men take a hand and bring, through revolution, a change; and in the sense that it is through utilizing the high-frequency electromagnetic radiations of the nervous system which are ruled by these planets that ESP and other inner plane activities of the soul can effectively be directed, and through which the inner plane intelligence of man can reach and effectively direct the physical brain. Uranus prominent in the birth-chart gives facility in using the Inspirational System of mental activity, Neptune prominent in the birth-chart gives facility in using Feeling ESP, and Pluto prominent in the birth-chart gives facility in employing the Inner Plane System of mental activity. Through these upper-octave faculties man can acquire information and power to direct his own life and destiny which can be acquired in no other way.

The Junior Overseer is located at the South Gate, to indicate the illumination given by the type of Intellectual ESP conferred by the electromagnetic radiations of the nervous system ruled by Uranus; even as at noon, which is the Sun's south point, the illumination is greatest.

The Senior Overseer is placed at the West Gate, to indicate the receptive quality given by the electro-magnetic field of the nervous system ruled by Neptune, which makes of it a receiving set to pick up, radio fashion, the astral vibrations radiated by objects, thoughts and conditions.

The Master Overseer is stationed at the East Gate, to indicate the new life, the conscious inner plane life, bestowed by the highest of all electromagnetic radiations of the nervous system, ruled by Pluto, which when properly active in the individual life can be compared to a rising sun revivifying a slumbering world.

The candidate is represented as having passed initiation on all three planes and returned to his body. Four raps signify the accomplishment resulting from this action on three planes, and the cable-tow is wound four times around his body to represent his realization of the complete union between soul and ego. To indicate that after his travels upon the higher planes he has now returned to physical life, the Senior Warden reads the following passage of Scripture: "Then he brought me back the way of the gate of the outward sanctuary, which looketh toward the East, and it was shut, and the Lord said unto me: Son of man, mark well," etc.

The Mark Master's sign, the Heave-over, is made by interlacing the fingers of both hands, holding them down in front opposite the right hip and then bringing them to the left side of the neck as if to throw a weight over the left shoulder. The E.A. degree, represented by the First Major Arcanum of the tarot, corresponds to the planet Mercury. The F.C. degree, represented by the Second Major Arcanum, corresponds to the sign Virgo. The Master Mason degree, represented by the Third Major Arcanum of the tarot, corresponds to the sign Libra. The Mark Master degree, represented by the Fourth Major Arcanum, corresponds to the sign Scorpio; thus this Heave-over, alluding to the rejection of the Keystone, refers to the sign Scorpio.

The ten locked fingers represent the union of man and woman, and the front of the right hip symbolizes the constructive power of Scorpio, which by most is discarded, or used negatively in Venusian pleasures as indicated by the left side of the neck.

The Keystone of Psychic Development is Proper Electrification

—Any control of the thoughts and emotions, by which alone the character and the fortune attracted into the life can be improved, ESP or inner plane work of any kind accomplished, or domestic felicity advanced, depends upon proper electrification; and proper electrification is closely related to the activities of the region ruled by Scorpio, which symbolically are thrown on the rubbish heap in the heave-over.

Love as a mental condition is very real. But to feel love there must be appropriate electrical energies in the nervous system. While we occupy physical bodies we feel with the nerves, and that which gives rise to the feeling is the electric charges which they generate and whose impulses flow to some central station in the brain.

Love is of various kinds and on various levels of expression. The feeling of affection for children, for instance, seems to depend much upon the electrical energies generated through the secretions of the back pituitary gland; and the more refined type of love seems linked with the electrical energies generated through the secretions of the thyroid glands. But for the sake of this illustration let us consider the more common phase of attraction between the sexes.

Man and wife may mentally and spiritually love each other devotedly, but the feeling of physical attraction commonly is subject to wax and wane. Loyalty, devotion and willingness to self-sacrifice may well be constant; but the more physical attraction and responsiveness are largely dependent upon the electrical condition at the time. In spite of willing to do so, neither can have any real passion, or even strong feeling of physical attraction toward the other, if through overwork, illness, or too much sex indulgence, that one is electrically depleted. Feeling depends upon the electrical energies present, and if these are absent and cannot be generated, the feeling cannot be coaxed or willed into existence.

While other glands are involved in lesser degree, it is chiefly the function of the secretions of the gonad glands to develop in the nervous system those particular electrical energies which give the feeling of physical attraction toward the love object. When the high-tension electrical energies are expended there is a lowering of potential, and the feeling which persists, due to the strong lower potential electrical energies present, is of different quality. If harmonious, it may sustain a tender love which is far above mere passion. If the thoughts at the time have been conditioned to consider all expression of sex sinful, or if for a variety of reasons there is inharmony or thoughts of defilement, the low potential electrical energies present will bring and sustain a feeling of degradation. But in any case the violent expenditure of electrical energies which have been generated largely through the action of the secretions of the gonads on the nervous system, for the time being markedly lowers the electrical potential.

Depending upon the health of the individual, the activity of his gonad glands and other factors, in a shorter or longer time the electrical potential due to gonad activity normally rises to a point where it exerts considerable tension; in other words, to a point in which the feeling of physical attraction for the loved one again is quite strong.

Now electrical energy in the nervous system is capable of being diverted, much as the electrical currents flowing over the ordinary power lines are; and those generated through the action of the secretions of the gonads on the nervous system are not only capable of being diverted into different systems of mental activity, but also are capable of being stepped up or stepped down markedly in voltage. They, therefore, are capable of quite a wide range of use to give additional power to the electrical energies developed by the action of other endocrine glands.

It might seem from this that a celibate life is of decided advantage in that it provides electrical energies of high voltage and power which can be used for the production of psychic phenomena, for building up vitality, to use in cerebral thinking, or for such other purposes as require energy. And this is the general idea behind the Oriental training which decrees that a neophyte must renounce marriage and live a celibate life. But here we are confronted with three factors which are subject to a widely variable personal equation.

1. The electrical power normally generated in the nervous system through the action of the gonad secretions by a person who has Mars inconspicuous in his birth-chart and Venus in conjunction with Saturn is but a small fraction of the electrical power generated by the action of these secretions by a person who has Mars conjunction Venus and both very prominent in his birth-chart. Those who do creative work of any kind have active gonad secretions; and it is likely that some creative artists generate daily, in spite of marital excess, more electrical energy of this kind than most other people do even when they live celibate lives.

2. Ordinarily a gland, muscle or nerve which is called upon to do no work tends to reduce its activity, perhaps even atrophy. While under normal conditions of abstinence no such deterioration is likely to take place, the question remains whether or not gonad secretion which is given no opportunity to function normally will continue as well to assist in the development of electrical power in the nervous system as if not too frequently it were called into normal play.

3. The electrical power that can be handled successfully by the nervous system when generated, varies markedly with different persons; and anyone can only handle so much successfully. When the lighting system in your home gets an overload of electric current, there is a fuse which melts and cuts the current off so it will not burn down the house. Now some people put a one cent piece, which will not melt, in the fuse box when a fuse has been blown, and because while they have it there no unusually heavy electrical load is present, no damage occurs. But when an unusually heavy current comes in under such circumstances, there is usually a fire or other

catastrophe. And the individual who normally generates much electrical power under the influence of the secretions of his gonad glands, and who through trying to awaken his kundalini or by rhythmic breathing intensifies this current, and at the same times lives a life of enforced celibacy, suffers much damage. He generates more electricity than he can handle and it causes disaster.

That which is related to sex becomes a very delicate subject of discussion, too delicate to go into the details as the importance of the matter warrants. Yet the individual who employs everyday common sense, instead of being led astray by fantastic mysticism or by the opposite extreme, sensualism, will solve its problems without much difficulty. He can do this more readily than anyone can lay down hard and fast rules for him, because he is in a position to observe the actual effect in terms of the volume and potential of electrical energy present as the result of variations in conduct.

Not only do hard and fast rules that work for one person often fail to work well for another, but usually there is a periodic variation of gonad activity during the month, which differs widely in intensity with different persons, so that at one period even though the thoughts are turned exclusively to cerebral pursuits, the electrical power present may be far more than at another period even when the thoughts are not especially guarded.

The condition of electrification to be sought, and to which the sex activity or lack of sex activity may contribute or from which it may detract, is that in which there is not so much electrical power within the nervous system as to place the individual under a strain of pressure, but in which there is ample to do whatever work is at the time required of it. And of course it is understood that this sex factor is only one of a number of things which may assist or detract from thus acquiring the proper electrical power.

Emotion cannot be felt in the absence of electrical energies, and to sustain a Mood there must be available adequate electrical power which can be used for this purpose. Yet, because there is so much nonsense written and talked about sex and the kundalini, I believe I should again emphasize that while electrical energies generated through the action of the gonad secretions are capable of being diverted into widely different channels, or sublimated so that their voltage and trend support noble aspirations and the highest phases of love, it is quite possible to develop more electrical power than can be diverted, or used in a constructive way.

The second sign is made by dropping the right hand again to the region of Scorpio, clenching the last two fingers, and leaving the thumb and first two fingers open. It refers to the method of carrying the keystone, represents the male trinity, and indicates symbolically this process of proper electrification.

The hand is next raised to the right ear and the open thumb and two fingers passed with a circular motion about the ear. This signifies that after proper electrification the electromagnetic energies are used to reinforce astral vibrations which enable the individual to exercise Intellectual ESP and thus receive information from the inner plane. The ear indicates the reception of such information.

The hand is then dropped partially down, the palm open and in a horizontal position, and the left is lifted up and brought down edgewise upon the wrist of the right. This alludes to the penalty of having both the ear and the right hand cut off, meaning that if the wages are not properly received, that is, if they are received negatively instead of through ESP, that the ability to receive anything of value, or to execute anything meritorious, will be cut off.

The Keystone of Attainment is Proper Cooperation Between Husband and Wife

—The third sign is made by extending the right arm in front with the hand clenched except the thumb and two fingers. It indicates the method of receiving wages, and the importance of positive virility. The keystone which the builders rejected is neither oblong nor square, but is composed of both straight and curved—masculine and feminine—lines. It is taken successively by the candidate to the three overseers, who note its singular beauty and form, but finally reject it because it has not the mark of any craft upon it.

It was formed by Hiram Abiff, the divine soul, to be the keystone of the temple; but upon his death was lost, and when later rediscovered and presented to the overseers it was not recognized, but was cast out among the rubbish. It has the mark of no particular craft upon it because it belongs to all souls, and each must be found worthy before he can place his astrological signature upon it. In its highest aspect it is the union of soul mates by which they are enabled to receive the wages of immortality.

On planes less high the keystone refers to proper union, the knowledge of which, as indicated in reference to electrification, for ages has been lost to mankind, and now rediscovered is in danger of being rejected by the overseers; that is by the occultists, mystics and spiritual aspirants; as was the case in the past.

But before the temple is completed a search is made by the Craft for the missing keystone; for the temple cannot be finished without it. It is found amid the rubbish and brought to the Master, who reprimands the overseers, and reads the following passage from the Scripture, which clearly designates its nature: “To him that overcometh will I give to eat of the hidden manna, and I will give him a white stone, and in the stone a new name written, which no man knoweth, saving him that receiveth it.” That is, by united regeneration man becomes renewed, or given a new name, even as by soul union man becomes man no longer, but an angel.

The keystone is said to be 4 x 6 inches dimensions, representing 24 hours, or the circumference of united night and day. About its circumference is a circle of 8 letters, given as H-T-W-S-S-T-K-S, the initials of Hiram Tyrian, Widow's Son, sent to King Solomon. This refers to the return of the divine soul to its source, and may be rendered: He That Was Slain Soars to Kindred Spirit. In humanity it also refers to regeneration supplanting generation.

Within this circle of letters every Mark Mason must place his own private mark, which, of course, is his astrological signature. Thus the 8 letters represent the 8 planets—in addition to Sun and Moon, that are not planets and signify masculine and feminine—which circle the heavens daily.

The Keystone as Applied to Natal Astrology

—Thus is indicated that one diurnal rotation of the earth measures out to man the astrological energies to be released during one year of life, and that this is the keystone of timing and indicating the major events which are attracted into an individual's life.

The progressed aspects calculated by this day-year system are not merely symbolic; for that which is symbolic only may reveal information of value, but it does not exert a definite and positive force such as progressed aspects do.

Horary astrology certainly to a large extent is only symbolic, and by its aid information of value may be acquired. But horary astrology is a method of divination and thus in a different category than natal astrology, which I am convinced maps actual energies which have an impact upon the person whose birth-chart and progressed aspects are under consideration. No doubt, as there are many methods of divination by using cards and numbers, there are various systems of astrological divination which can be used, even in connection with the birth-chart, through which considerable information can be obtained about that which will happen to the individual in the future. Having tried some of these methods out, I feel confident such is the case. But I am even more firmly convinced that the progressed aspects employed in the Hermetic System are something more than divinatory clues, and actually map invisible forces radiated by the planets which have a definite effect upon man.

I have progressed the charts of many people who knew nothing about astrology and asked them how they felt in reference to various matters as compared to the way they felt about the same matters at other periods in their lives. I have found invariably that at the time a certain strong progressed aspect was operative that the trend of their thoughts and their feelings about the things represented by the houses of their charts affected by the aspect had changed markedly in the direction indicated by the progressed aspect.

Almost any astrologer of experience upon learning of the outstanding conditions and events in another person's life, yet without knowing the birth-chart, can correctly tell the person that a certain specified planet is being heavily aspected by progression at the time. Each planet has its own characteristic manner of affecting events. I have witnessed this picking of the planet responsible for an event, before the birth-chart has been seen or the progressed aspects calculated, innumerable times, and later verified when the progressed aspects were worked out.

On many occasions I have had students, who had not taken the trouble to work up their progressions, or who as yet did not know how to do so, remark that they felt the vibrations of Mars, or Venus, or Uranus, or Saturn; and on working up the progressed aspects I have found that there actually was a progressed aspect to the mentioned planet then operative. And students who know they are coming under a progressed aspect, and keep on the lookout to discern when they first feel it, sometimes feel it distinctly when it is a full one degree from perfect, and sometimes feel it only when within half a degree or less from perfect. Many students report that they always can feel the distinctive influence of any of the planets when it is making a strong progressed aspect. They can name the planet to which they are thus most strongly responding.

More evidence could be cited to indicate that the day-year progressed aspects at the time they are operative exert a well defined and plainly felt force upon the individual. But as many who read this can feel what planet is making a strong progressed aspect in their charts, when they have for a time neglected to look up their progressions, let us consider how that which takes place in one day after birth can spread its influence over $365\frac{1}{4}$ days of life.

Now I realize that when I again mention Einstein and Relativity that many will feel I am treading upon highly debatable ground. And in so far as Einstein's General Theory of Relativity is concerned, which deals with curved space in relation to gravitation this is true. But in regard to Einstein's Special Theory of Relativity, which was first propounded in 1905, and whose implications alone, I believe, explain the action of progressed aspects, extension of consciousness, ESP and inner plane properties in general, it has now become almost unanimously accepted by those best qualified to prove or disprove it. To quote from an article by H.P. Robertson, Ph.D., Professor of Mathematical Physics, Princeton University, which appeared in the June, 1939, issue of Scientific American Magazine:

In view of these developments one may say that at present the special theory of relativity is one of the most thoroughly accepted and most firmly established doctrines of modern physics. It has permeated the fields of mechanics, electromagnetism (including optics) and atomic physics; while it may appear desirable to have further direct checks on the validity of its mechanical aspects, a deviation from the predicted effects would constitute a most puzzling—and, at least temporarily, distressing—jolt for modern physics.

An essential factor in the special theory of relativity, which has now become so completely accepted in scientific circles, is the inter-relationship between velocity and time. It is held that there is no such thing as absolute time, but that as velocity increases, time slows down, until, at the velocity of light time comes to a standstill. Conversely, as time speeds up, velocity slows down until at the time speed with which we are familiar, objects tend to move at the velocity physical things are observed to do.

Nor is this just a theory, as the experiments of Dr. Herbert E. Ives, mentioned in chapter 5, demonstrate. He reported that observing the Doppler shift in an oncoming hydrogen beam, and at the same time the shift due to the recession of the same beam, shows that, as relativity predicts, a moving clock keeps slower time than one standing still.

If at the velocity of light time stands still, within a single moment of such slow time an infinite number of events could happen. And in a realm, or condition, where velocities were not so great as light, but are greater than that of ordinary physical objects, a large number of events can happen in a single moment of this slower time. In our dreams, for instance, and to some people when they are on the verge of dying, there are numerous experiences which in ordinary time would require days or years, compressed into a few minutes of the slower time of this borderline state of consciousness.

When our consciousness moves from this borderline realm where velocities are far greater than those of physical life, to the realm of physical existence where velocities are much slower, the events which in our dream took but a few moments to happen, spread out in this faster time of normal life to occupy a period which seems to us days, or months or years.

To take another illustration, suppose we walked from Los Angeles to San Francisco at the rate of 25 miles per day, and pass through 30 towns on the way. At this velocity it would take us 18 days to see the 30 towns. But by airplane we can make the trip in 3 hours, seeing the 30 towns. That is, in three hours' movement at airplane velocities we can see as many towns as in 18 days at walking velocities. The amount of experience to be had in a given interval of time—3 hours, for instance—is relative to the velocity with which such events are passed.

According to relativity, as velocities increase there is a definite slowing down of time, the exact amount being determined by the Lorentz transformation. Similarly, as velocities slow down there is a definite speeding up of time, the exact amount being determined by the Lorentz transformation.

We have already seen that a dream, or near death state of consciousness may have a velocity, in so far as the number of events witnessed within a few moments of this slower time of the boundary-line state, such that these same events happening on the physical plane would require days or months to take place. That is, in the boundary-line region between the physical world and the realm having velocities

greater than that of light, time so slows down that when brought up into physical consciousness it is similar to bringing all the things witnessed in a 3 hour airplane flight from Los Angeles to San Francisco up into a consciousness that knows no faster velocities than walking, in which time is speedier and movement proportionally slower, so that it requires 18 days for the same amount of experience.

Material science has now proved that the nerve currents are electrical in nature and that man has an electromagnetic form. Electromagnetic waves when radiated move with the velocity of light; but electric currents traveling over wires or over nerves move much slower. In other words, in man's electromagnetic form are velocities greater than those of ordinary physical substance, but which are not as great as the 186,173 miles per second that light travels.

From what already has been said it will be apparent that if a clock slows down relative to the velocity it acquires, as consciousness attains higher and higher velocities it will be able to have more and more experiences within the space of four minutes of this slowed down time. At a certain velocity, which is well within the limit of what can be expected to occur in man's electromagnetic form, the ratio of the number of experiences in four minutes of slower time, to the number of experiences in the faster time of external life, would be $365\frac{1}{4}$ to 1.

Bear in mind that in the one interval of the slower time of the high velocity region as many events can transpire (remember the airplane trip to San Francisco) as in $365\frac{1}{4}$ similar intervals (remember the walking trip to San Francisco) of the faster time of the ordinary objective world. The slower the time, the more numerous the events that can happen in any given interval, but as time is speeded up to the tempo of ordinary physical existence, it takes more intervals of this physical time to accommodate a given number of experiences.

In case the ratio between the electromagnetic region of man's body and his physical were $365\frac{1}{4}$ to one, the occurrences that took place in a little less than four minutes of this slower boundary-line time, when expressed in the faster time of the external world would occupy a duration of twenty-four hours, and what took place in 24 hours in the time of the boundary region, when externalized on the physical plane would take $365\frac{1}{4}$ days of the ordinary faster time; that is, what took place in one day in the boundary region, when externalized would take place in one year of the faster physical time.

Under such circumstances, just as a dream occupying less than four minutes when brought into objective consciousness may represent a whole day of physical existence, so changes brought about in a portion of the finer body at a certain velocity level, by planetary movement during one day, when transformed into the faster time of objective existence, occupy $365\frac{1}{4}$ days, or one year of this faster objective time. This represents the time-velocity transformation of energies released by the day-year progressions.

I am confident that the forces thus released by day-year progressions are no more symbolic than is the radiation of high-velocity particles from radioactive matter which takes place in the laboratory of the physicist, and to measure the mass of which he must apply the same relativity transformation I have indicated. These radiations are invisible to the unaided physical eye, but even as do planetary forces, they are capable of producing powerful effects on man.

Wages and the Astral World

—At the building of the Temple it was the custom of the craft to assemble at the sixth hour of the sixth day of the week to receive their wages. The members of the lodge, therefore, march two and two to the window where they are paid. As the sixth day is Friday, ruled by Venus, and the sixth planetary hour of Friday is the hour of Mars, they typify these two planets, corresponding to the astral body and animal soul of man. The attraction of these two planets for one another is greater than that between other planets, and it is in the astral world while man possesses an astral body and an animal soul that he receives the reward of his deeds upon earth. The wages are paid by the Senior Warden, or divine soul, who gives each worthy craft a penny. When the candidate puts his hand through the lattice window, it is held fast and the order given to cut it off. This signifies that the soul may incur the penalty of being held captive in the astral world by not knowing how to receive wages, not being able to raise the vibrations of Venus and Mars to the spiritual plane, as typified by the circular coin. The hand being cut off symbolizes that the result is a loss of executive power.

The pass grip is made by grasping the fingers as though to assist another, and refers to the assistance given to each other by the workmen as they climbed the steep banks of the river Joppa when bringing timber from Lebanon. It symbolizes the mutual assistance that may be given in reaching the astral plane, Joppa. Joppa, therefore, is the password.

The true grip is made by passing from the passgrip to the Mark Master's grip, which is given by locking the little fingers of the right hand, turning the backs of the hands together and touching the thumbs. It is called Siroc, or Mark Well; symbolizing that the lower passions and desires have all been conquered and that the spiritual bodies unite in a mutual use of the will. The little finger is ruled by Mercury, emblem of the spiritual body, and the thumbs signify will. The neophyte should Mark Well, therefore, that as he climbs the height of occultism all passion will have gradually to be overcome to enable the soul to direct its will without the aid of passional excitement.

The candidate is received into the Mark Master degree upon the edge of the indenting chisel. This represents vivid formulation of the object to be attained and the constant application of the will to that attainment. He is finally instructed how to receive his wages, and receives a penny. At this the others murmur and throw their coins upon the floor, protesting that one inexperienced should not receive the same wages as an

accomplished workman. But the justice of so paying is supported by a passage of Scripture, and the craft are at last satisfied. Thus in life some must toil long and laboriously to become worthy of receiving a spiritual reward, while others make attainment almost immediately, which apparently is an injustice. But time and opportunity, in the course of divine providence, are meted out to all, and only the foolish question divine justice.

A brother in asking a favor pledges his Mark, and so resembles Hiram Abiff, the divine soul, who seeks sustenance from Solomon, the ego, in order to accomplish his destiny. The divine soul receives succor only as it pledges its immortal nature to work in harmony with the universal will. It is symbolized by the Moon seeking the beneficence of the Sun's rays. For a similar reason, a brother receiving a pledge and granting a favor is like King Solomon, who was renowned for his beneficence. He resembles the Sun which sheds its rays upon the Moon, and he is like the ego which sustains and inspires the soul.

5. Past Master Degree

—A Master Mason cannot preside over a Master Mason Lodge until he has taken the Past Master degree. It has to do with man's intellectual and religious qualifications, and much light is shed upon it by the Fifth Major Arcanum of the tarot, to which it corresponds. This Arcanum, ruled by the planet Jupiter, represents the hierophant, prince of occult science, who by his knowledge and goodness is enabled to exercise authority and command obedience. Man rules over the four elements of nature by virtue of his intellect. This is expressed by the number five.

The Past Master Lodge is opened by the same officers, and the lodgeroom is the same, as in the E.A. degree. It typifies man in his normal physical state. The only difference is that they all wear hats. This symbolizes their knowledge concerning union; for the head in the hat astrologically represents the sun and moon conjoined.

The step is made by placing the heel of the right foot against the toe of the left to form a right angle. It symbolizes mental union. The first sign is made by placing the thumb of the clenched right hand to the lips, and means the Will to keep Silent regarding knowledge that would prove dangerous to others. The dieuard is made by drawing the right hand from the left side of the neck down diagonally across the breast. It signifies the transference of negative affections into positive aspirations.

The grip of a Past Master is made by first taking the Lion's grip, and then as they say, "from grip to span," slipping their right hands so as to catch each other by the wrist, grasping each other by the right elbow with the left hand. It refers to the interplay of forces between those who have lived together a spiritual life and understand the inner laws.

The other feature of this degree is the abdication of the Master in favor of the candidate. The candidate attempts to conduct the Lodge, but is made the target of witty remarks, the Lodge breaking up in confusion. It is meant to teach the folly of attempting prematurely to control the inhabitants of the astral realm. The elementals that the neophyte attempts to force into his service will turn and rend him unless he has undergone the necessary preparatory training.

6. Most Excellent Master Degree

“—When the Temple of Jerusalem was finished, those who had proved themselves worthy by their virtue, skill, and fidelity, were installed as Most Excellent Masters.” This degree is founded upon the Sixth Major Arcanum of the tarot, ruled by Venus and pictured as Temptation. The degree represents the trials surmounted, as indicated by the significance of the Scripture read by the Master: “He that hath clean hands, and a pure heart; who hath not lifted up his soul unto vanity, nor swore deceitfully. He shall receive the blessings from the Lord,” etc.

In opening the Lodge the brethren gather round the altar and kneel on the left knee with their arms crossed and holding hands so that each gives his right hand brother his left hand and his left hand brother his right hand. When the scriptural reading is over they lift their hands up and down six times while the Master counts: “One, Two, Three; One, Two, Three.” This is called balancing, and refers to the wavering of the soul between good and evil, and to the extreme tendencies that produce disastrous reactions. This also signifies the sexes in antagonism, as well as loss of equilibrium. The crossed arms represent inversion, but more particularly the cross-roads where the neophyte must decide whether he will follow the path of black magic or the path of magic that is white.

After balancing, the brethren lift their hands, now free, above their heads rolling up their eyes in an attitude of astonishment. This indicates that they have been confronted by temptation. They then turn to the right extending their arms, afterwards permitting them to fall nerveless at their sides. It indicates they have yielded to temptation. This sign is said to represent the Queen of Sheba on first viewing Solomon’s Temple. It really indicates that man progresses by alternately yielding to and struggling with his animal desires, and that not without repeated effort is the final victory won.

The candidate is received into this degree upon the keystone, which as applied to man is the fundamentals of sex. The password is Raboni, signifying to overcome. The sign is made by placing the two hands, one on each breast, the fingers meeting at the center, and jerking them apart violently. It refers to antagonism that may arise between man and woman, and to triumph over temptation of a sexual nature by the aid of the aspirations. The grip is given by grasping the other’s hand and pressing with the thumb the base of the third finger where it joins the hand. This is the Sun

finger of palmistry, and presides over worldly honors. The grip signifies the Will to resist the temptation to use psychic powers for temporal advantage. As the candidate receives the grip the Master places the inside of his right foot inside the candidate's right foot and whispers the word, Raboni. This symbolizes that the candidate must understand the necessity for resisting temptation.

Next, an arch is brought out supported by two pillars, Jachin and Boaz, each about five feet high. It consists of ten blocks, five on either side, with a mortice between for the reception of the keystone. The keystone, symbol of union, is placed into the arch between the five blocks representing man and the five symbolizing woman; and is driven down by six raps of the gavel, indicating the use of the Will in overcoming the temptation to abuse the sacred function denoted by the keystone.

The brethren then march around and hang their jewels, sashes, aprons, etc., on the arch to denote their willingness to make sacrifices that the marriage relation may be perfect. The ark, which has been carried around by four brethren, is then brought forward and placed on the altar and a pot of incense is placed on the ark. The symbol of the ark, as well as that of incense, was explained in chapter 7. The four brethren carrying it typify the four quadrants of the heavens, and thus represent a cycle of time in which sought for results are realized.

In closing the Most Excellent Master Lodge, all kneel around the altar while the Master reads out of the Bible, then they balance six times, arise and balance six more, and give the signs from this degree downward to indicate complete mastery of the knowledge received in the past, and that they have finally overcome all indecision, and have surmounted all temptation by obedience to the Law.

8. Royal Master Degree

—This degree corresponds to the sign Capricorn, and to the Eighth Major Arcanum of the tarot, the significance of which is Justice and Equilibrium.

At the building of the Temple, King Solomon, Hiram, King of Tyre, and Hiram Abiff decided to award the most skillful and faithful of the Master Masons by imparting to them the Omnific Word. But they took a solemn oath not to impart the Word until the completion of the Temple, and then only when all three were present. As this Omnific word is the immortal union of soul-mates, it is at once apparent that it can only be imparted in the presence of the ego, divine soul, and spiritual body; for if the divine soul, corresponding to Hiram Abiff, be slain, its union with its mate is impossible. Furthermore, it can only be imparted at the completion of the Temple; for man must have completed the construction of his spiritual body before this permanent union can take place.

The candidate impersonates Adoniram, a worthy Master, who symbolizes the twin soul of Hiram Abiff. As Hiram is leaving his sanctuary he is accosted by Adoniram who asks him at what time he shall receive the Omnific Word. Hiram answers: "My worthy friend, it is uncertain when, or whether, you will receive it at all; for the Omnific Word cannot be given until the Temple is completed, and then only by the free consent of the three Grand Masters." Adoniram then asks how he can expect to receive it if one of the three should be removed by death. Hiram answers by tapping the floor three times with his foot, saying: "When I die, they will bury it there."

Thus is imparted the knowledge that in case one of the twin souls sins against his immortal nature and sinks into the Lower-Pluto realm, Pluto ruling the eighth birth-chart house, it will be long ere the other receives the Word. Yet all things being possible in the accomplishment of divine justice, a new monad is budded to take the place of the prodigal, and is sent on its pilgrimage through the three planes alluded to by the taps on the floor. Thus the word is buried between the three planes, but will be recovered at the end of the new monad's cycle of involution and evolution. Justice will finally be meted out unto all.

The Master, representing Hiram Abiff, tapping the floor three times asks the candidate, "Do you know about this?" The candidate replies, referring to the Omnific Word of soul union, "I know something about it." He is then asked what he knows about it, and replies that he knows something of the beginning of it, at the same time tapping the floor three times with his toe. That is, as impersonating one of the twin souls, he knows they were together at the beginning of the cyclic pilgrimage. Asked what was the beginning he answers that it is Alpha, and that the end is Omega. And truly the separation of the twin souls is the beginning of their career, and the reunion is the end of the cycle in which manhood is attained. The next cycle is that of the angel.

Separation and reunion closes the great orbit of the Cycle of Necessity. Reunion is the tree of life, the reward of the faithful, as indicated by the Master reading from the Bible the following: "And behold, I come quickly; and my reward is with me, to give every man according as his work shall be. I am Alpha and Omega, the beginning and the end, the first and the last. Blessed are they that do his commandments, that they may have a right to the tree of life, and may enter in at the gate of the city."

The grip of this degree is given by each taking his left wrist with his right hand, and with his left hand taking hold of the other's right wrist, forming a square seat. It typifies inertia and stability resulting from forces in equilibrium. The Word is given by letting the left hand fall to the side, placing the right toe to the other's right heel, making a triangle, and saying, "Alas, poor Hiram!" This indicates dissolution, and refers to the disintegration of the wicked by the Lower-Pluto forces. The feet forming the triangle refer to understanding that the three parts of man's spiritual being must be present before union of soul mates is possible. The dieugard is made by placing the forefinger of the right hand to the lips. It enjoins silence concerning such sacred things in the presence of the profane.

Chapter 10

Serial No. 15
Original Copyright 1939
Elbert Benjamine

Copyright
Church of Light
August 2002

Royal Arch

Chapter 10

Royal Arch

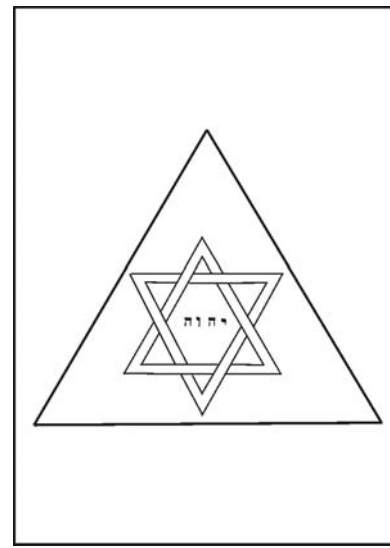

HE PHYSICALLY perfect man, or adept, possesses and is master of seven physical senses, seven psychic senses, and seven states of consciousness. The number seven, denoting the complete gamut of physical life, indicates readiness for transition to a new octave of endeavor. The number of action and completion of form, astrologically it corresponds to Sagittarius; and is explained in symbolical pictograph by the Seventh Major Arcanum of the tarot, which represents the triumph over all temptations and obstacles of the physically perfect man. Upon this tarot arcanum is founded the ancient degree of the Royal Arch.

In its initiatory ritual the candidate is caused symbolically to recapitulate man's involution, and his evolution up to the state of perfect physical manhood. As the result of this perfection, or adeptship, among other priceless treasures obtained, he is given the Omnific Word.

This initiation, to represent that on every plane the soul is vitalized by its ego and functions through some kind of form—there being a trinity of ego, soul and body always present—can only take place when there are three candidates to undergo the ceremony at the same time. To indicate that these three elements of man's constitution are never entirely separated, and that during the Cycle of Necessity through the seven realms to the one where the candidate now functions there has been a constant strengthening of the bond between them, and the unfoldment of seven states of consciousness, the three candidates are tied along a single rope which is wrapped seven times around the body of each.

The Chapter represents the Tabernacle erected near the ruins of the Temple. It is an oblong square divided into separate compartments by four veils. Its square form represents the physical plane where initiation is first conducted.

Significance of the Banners and Three Times Three

—The banner of the guard at the outer veil is blue, the color of the planet Saturn, and of the selfishness which must be overcome at the first step. The banner of the guard of the second veil is purple, the color of the planet Jupiter, and of the love of wealth and worldly station, which must be triumphed over at the second step. The banner of the guard of the third veil is scarlet, the color of the planet Mars, and of the hate and passion that must be left behind if the sanctuary is to be reached. The banner of the guard of the fourth, or inner veil is white, the color of the planet Uranus. This indicates that all the experiences of life, represented by the various planetary colors, must be purified and fluxed by the methods of spiritual alchemy and then combined, as the prismatic colors combine, to form the white light of spiritual gold before final adeptship is attained. These four veils also represent the four elemental kingdoms—gnomes, undines, salamanders and sylphs—which the adept of the physical plane is called upon to master.

It is asked how a Royal Arch Mason is known. The answer is that it is by three times three. This symbolizes that he possesses knowledge of the three trines of the soul's pilgrimage. The first trine, with its apex above indicating where the twin souls separated, represents by its separating sides the divergent lines followed in involution by the male and the female monads. Its base represents the mineral realm where the two souls are farthest apart. The second trine starts with the mineral as the base line and the human state of life as the point where the two sides converge. This indicates that it is possible, though only one far spiritually advanced could recognize it if it did take place, for the twin souls to meet as human beings on the physical plane. The third trine has its base in human life, and its apex in the seventh spiritual state where soul-mates are permanently united.

In opening the Chapter all kneel about the altar on their right knees in the form of a circle. The circle represents spirit, and the attitude denotes the willingness to dedicate their services unreservedly to it.

This circle is called a living arch, and is symbolical of the lives through which the soul passes in its cycle of necessity. The High Priest reads from the Bible, then each crosses his arms and gives his left hand to his left-hand companion, as token of the trials and temptations that must be surmounted. They then balance three times three with their arms, permitting them to rise and fall in three series of three, with a pause between each series, indicating the three trines of life: involution to mineral, evolution to man, and final evolution from man to angel. The password, Raboni, signifies to overcome, and indicates the determination to overcome all barriers to spiritual progress.

Because the higher trinity of man's being must be present before soul-union can take place, and because it is the product of the united effort of the ego and its two monads, the Omnific Royal Arch Word can only be given in groups of three. Each of the three companions—the three representing ego and two monads—takes his brother on the left by the right wrist with his right hand, and with his left hand grasps the left wrist of his brother on the right. To indicate the three as functioning in the mineral realm of life they place their three right feet together in the form of a triangle. Their left hands form a trine in the middle region, to indicate the three functioning on the astral plane. And their right hands form a trine above their heads to typify the three functioning on the spiritual plane of life.

They then balance three times three and bring the right hand down upon the left, signifying victory over temptation through wisdom, indicated by the number nine (see Course 6, *The Sacred Tarot*, Chapter 7), in the union of positive (right-hand) and negative (left-hand) forces. Their right hands are next raised above their heads as they give at low breath the word: Jah-buh-lun, Je-ho-vah, G-O-D. Low breath has reference to the spiritual impulse that propelled the monads upon their cyclic journey. The Omnific Word is syllabled and pronounced alternately so that each of the three speak all nine syllables, or altogether twenty-seven. These twenty-seven syllables represent the twenty-seven days it takes the moon to pass through the circle of zodiacal signs and return to its original starting point. This symbolizes the soul's journey from its differentiation back to the spiritual state.

The three candidates personate the three Most Excellent Masters who, at the destruction of Jerusalem, were carried captive into Babylon where they remained seventy years until liberated by Cyrus, King of Persia. They then returned over a rugged road to assist in rebuilding the Temple. Now the number ten represents a complete cycle (see Course 6, *The Sacred Tarot*, Chapter 7) of experience. Multiplied by seven to become seventy it indicates successive cycles during which the perfection of form is attained. This climax of evolution on the material plane, the perfect physical form, is man, who possesses a seven-fold constitution. Thus does the soul, descending into the Babylon of matter, become a captive of sense and seeming. It is only liberated when perfect physical manhood is reached and work is ready to be started in the reconstruction of its physical temple.

The candidates are permitted to enter the Chapter, representing the material world, through a living arch. This is formed by the brethren standing in two lines facing each other, each locking fingers with the brother opposite. It typifies the forms of life through which the soul passes in its cyclic journey, and to represent the struggles in each of these lives the candidates are kneaded by the brothers' knuckles. This punishment is so hard as often to prostrate them on the floor, indicating the dissolution of one form before another is attracted.

The end of the ritual that portrays involution finds the candidates confronted by a burning bush. This is the divine creative fire, by the energy of which the soul ascends through the various forms of physical life, finally to rebuild its spiritual temple, a miniature structure patterned in detail after the universal temple. The destruction of the temple signifies here the fall of spirit, or the involution of the soul into matter. This is brought out by reading the account given in the 26th Chapter of Chronicles, and throwing the candidates on the floor and binding them amid much confusion, and carrying them out into the preparation room. A few minutes later, to indicate that the evolutionary journey has commenced, they are released and told that Cyrus, King of Persia, has issued a proclamation to build another temple at Jerusalem.

The Living Arch

—The living arch by which the candidates enter the Chapter is symbolical of the elemental life-forms passed through before the soul incarnates for the first time on the physical plane.

To represent successive existences in the mineral realm of earth the candidates again pass through the living arch. Then, to typify the experiences of the impersonal soul in the astral realm after it has passed through the mineral states of life, they are led over a rugged road around the room and back again to the living arch.

The next time through the living arch—the second time after the destruction of the temple, but the third time through—they are treated more harshly. This indicates that in passing through repeated incarnations in the vegetable kingdom of life the soul awakens to greater sensitiveness, becomes more aware of external conditions. Then again the candidates are led over a rugged road, indicating the period between vegetable and animal existence spent in the astral realm where experiences in the vegetable realm are thoroughly assimilated. To show the completion of this cycle of astral existence they are led around the room to still again confront the living arch.

The third time through the arch since destruction of the temple—the fourth and last time in all—they are treated still more roughly. This denotes in the animal kingdom through which the soul evolves that sensitiveness, consciousness, and suffering become more intense. Then once more they are led over the rugged road, this time to indicate the period of assimilation in the astral realm after completing evolution through the animal forms, and before the soul is competent to incarnate in a human body. They are then led on around the room, but as the living arch composed of numerous brethren indicates a series of lives, and as the soul incarnates but once in the human form, they this time are not confronted by the living arch, but now are in sight of the ruins of the old temple, near the outer veil of the tabernacle. This tabernacle is the body of man, the last dwelling of the soul in physical form before the reconstruction of its spiritual temple.

To conquer the realm of gnomes and pass the veil of Saturn into the first apartment requires unselfishness. The password is “I am that I am.” It is said to refer to Moses who was sent by “I AM” to the Children of Israel. This means that the ego, which sends the monad into physical life for the sake of experiencing good and evil that it may reconstruct the spiritual temple, is eternal spirit, enduring forever through time without beginning and time without end. It is the realization of this divine relationship to the ego that first prompts the soul to true unselfishness.

To conquer the realm of undines and pass the veil of Jupiter requires knowledge and sacrifice. The passwords are Shem, Ham, and Japhet. The sign is to cast a rod upon the ground and pick it up again by the end. This indicates that a knowledge of magic is necessary to the adept, and also that the creative energy, typified by the rod, to be of greatest service, must be given a spiral (spiritual) form and made to serve a living purpose, as indicated by the serpent. This sign also refers to the fourth chapter of Exodus: “And the Lord said unto Moses, what is in thy hand? And he said a rod. And the Lord said, Cast it on the ground, and he cast it and it became a serpent.”

Noah, of course, personifies the sun. His three sons—the three important visible stations of the sun—are the Ascendant, the Midheaven, and the Descendant. Ham, who beholds the nakedness of his father, the sun, as the latter rises and ascends to the midheaven, growing in illumination, represents the Ascendant. But when the sun reaches the Midheaven its illumination begins to diminish, and as it moves forward the Midheaven and Descendant, corresponding to Japhet and Shem, seem to move backward toward him, finally covering him with the garment of night. Ham, symbolizing the sun rising in the sign Scorpio, indicated by Noah’s drunkenness, uncovers the sun after he has yielded to base desire. This represents indulgence and degeneration. He therefore does not receive the parental blessing bestowed upon the other two, who show base desire on the wane, and who are ashamed of depravity. These three passwords, to be understood, imply a knowledge of astrology. To be used in overcoming the realm of the undines they imply that the candidate no longer delights in satisfying base desires, but through his knowledge of generation has become master of his desires.

To conquer the realm of salamanders and pass the veil of Mars into the third apartment requires purity and strength. The passwords are Shem, Japhet, and Adoniram, and the sign is made by thrusting the hand into the bosom and again drawing it out. This sign is said to refer to the fourth chapter of Exodus: “And the Lord said unto Moses, put now thine hand into thy bosom; and he put his hand into his bosom; and when he took it out, behold his hand was leprous as snow.” In the passwords here Adoniram, typifying the soul-mate of Hiram Abiff, is substituted for Ham who belongs to the realm of external desires. Adoniram indicates the sun rising in the sign Taurus, the sign of regeneration, instead of in Scorpio. This reference

indicates that the candidate is expected to understand spiritual astrology as well as the more physical branches. And it signifies that at this stage of his initiation, regenerate union must entirely supersede generation. The sign indicates the powers that may be exercised by the adept in high magic. It also warns of the frightful penalty that those must pay who fall into the snare of sex magic.

To conquer the realm of sylphs and pass the veil of Uranus into the inmost compartment where adeptship is finally attained requires great self mastery and wisdom. The passwords are Haggai, Joshua, and Zerubbabel. These characters were holy men who came into possession of wonderful powers through the consecration of their lives to the work of God. Only such others, therefore, as likewise consecrate their energies to the performance of the divine will, and strive to assist the progressive evolution of creation, can ever arrive at true adeptship.

The sign is made by holding out a tumbler of water and pouring a little on the floor. This is said to refer to the fourth chapter of Exodus: "And it shall come to pass, if they will not believe in the two former signs, thou shalt take the water of the river and pour it upon the dry land; and the water shall become blood upon the dry land." Thus is signified that when properly understood the creative periods of woman are a source of occult power. Alchemy, as well as astrology and magic must be mastered by the would-be adept. At the point of progression now considered, the grosser energies are transmuted to build up electro-magnetic power. The form of the finer bodies, as symbolized by the earth, is subject to the molding influence of the passions and aspirations. The sign, consequently, refers to the transmutation of the emotions, symbolized by the water, into living active energies.

To pass the inner veil it is also necessary for the candidate to present the signet of Truth of Zerubbabel. This is a triangular piece of metal with the name Zerubbabel engraved upon it. Zerubbabel was the chosen of the Lord. In other words, he understood and conformed to the Law. He was present at the building of the first temple and his hand saw the completion of the new one.

Now the trine represents the ego and its twin souls, the metal signifying their most valuable experiences on the physical plane. Zerubbabel being present at the beginning signifies that the differentiation of the twin souls was under law. His being present at the completion of the new temple signifies that the reunion of twin souls is likewise under law. The signet of Truth, therefore, is that the ego and twin souls stand in relation to each other as Life, Light, and Love. Furthermore, those who, like Zerubbabel, understand and obey nature's laws, interiorly recognize the truth, even when external evidence is lacking to substantiate it, that the twin souls of one ego must join to build the new temple of the angelic form.

When they have passed the inner veil the candidates arrive at that portion of the Chapter where they are ready to take the final initiation that confers upon them adeptship on the physical plane. They consequently are examined by the brethren and declared eligible and "just such men as are wanted in building the temple." Asked what work they will undertake, they reply that they will undertake any service,

however servile or dangerous. All aspirants to adeptship are given a work, more often than not bringing hardships and the condemnation of the ignorant, and sometimes making them outcasts and subjects of persecution. The neophyte's future progress depends upon the manner in which he accomplishes that which has been given him to do. If he shirks it because of its arduous nature, or because it lends to unpopularity, or because it interferes with worldly interests, he is barred from further initiation.

Next the candidates are directed to go to the northeast corner of the old temple and remove the rubbish preparatory to starting the new building. The northeast is the portion of the mundane sphere where the sun rises in spring at the renewal of the year after it crosses the equinox. It is the point where its regeneration commences. The candidates are furnished, one with a crowbar, typical of the plumb, and the masculine in nature; one with a shovel, in form representing the sun of spirit penetrating the square of matter; and the other with a pick, symbolizing the plumb, or vertical line of the sun's rays, uniting with the moon, or crescent of soul. The crowbar thus symbolizes the ego. The shovel symbolizes the ego sending a ray of itself, the soul, into matter. The pick symbolizes that the result is union of ego and soul. In other words, the product of the soul's experiences in material environment is self-consciousness.

After digging awhile in the rubbish of dogmatic science and religious superstition, the candidates find a ring, typical of their evolving spiritual insight, by which they pull up a keystone of an arch disclosing an entrance to a vault below. This keystone is the one wrought by Hiram Abiff. It signifies, as elsewhere explained, that the key to soul power is union between harmoniously wedded man and woman, and that the key to occult science is the knowledge of astrology.

One of the candidates agrees to descend into the vault. This vault represents the lowest grade of adeptship where treasures of knowledge are concealed. A rope is wound seven times around his body, to typify his possession of the seven states of consciousness, and he is lowered by a companion into the vault. Here he finds three small trying squares which prove to be the jewels of the Ancient Grand Masters, King Solomon, Hiram, King of Tyre, and Hiram Abiff.

First Step Toward Adeptship

—These trying squares typify the three planes of adeptship, each having three grades, that are discovered by the worthy neophyte. These on the physical plane are the scientific grade, the lucidic grade and the grade of soul consciousness. In natal astrology they represent the birth-chart, progressed aspects, and cycles, each of which is triune, and taken together as the Hermetic System of Natal Astrology, comprise a perfect system. The birth-chart embraces zodiacal signs, planets and mundane houses, related to each other as spirit, soul and body. Progressions consist of major progressions, minor progressions and transits, related to each other in the

same manner. Cycles likewise correspond to man's triune nature, being divided into solar revolutions, lunar revolutions and planetary periods. These three try squares where humanity is concerned signify man and woman united in a common work; functioning on all three planes of life. The recognition of these jewels is the first step toward actual adeptship.

After the discovery of the jewels—the discovery of the methods by which knowledge may be tried and its value proved so that if it is found of correct proportions it may be used as a stone in building the temple—one of the candidates is again lowered into the vault. During this event the sun is at meridian height, and its illuminating rays enable him to discover a small box standing on a pedestal. The light and heat from the sun at this time are so intense that he raises his hand and draws it briskly across his forehead, then drops it again to his side. This is the dieugard of the Royal Arch degree.

The sun is represented as at its strongest position, typical of the virility which if utilized to furnish electromagnetic vibrations that can be used in Intellectual ESP, may result in illumination, signified by the dieugard. The dieugard further refers to the fact that when such illumination is present, the attention has become so absorbed in exploring regions of the inner plane and acquiring from it information of value, that the individual for the time being is quite blinded to all that happens in the physical world.

Ark of the Covenant

—The box discovered by the neophyte through his exercise of Intellectual ESP is removed to the external world and examined. The High Priest pronounces it to be the Ark of the Covenant of God.

This Ark is a miniature representation of the universe and contains a condensed copy of both the Oral Law and the Written Law. The square form of the base, as described in the Scripture and in Ancient Masonry, symbolizes the world of matter and the physical body of man. The coffer above the base typifies man's soul and the astral world. The mercy seat which is over the coffer represents man's ego and the spiritual world. These three main divisions of the Ark are the same as the three worlds mentioned in the Kabala. They are: Asiah, the world of action, or physical world; Yetsirah, the world of formation, or astral realm; and Briah, the world of creation, or spiritual realm. Alchemically these main divisions are Salt, Mercury, and Sulphur. Astrologically they are Mundane Houses, Planets, and Zodiacal Signs. Still above the realms mentioned is the Angelic world, the world of Emanation, or Atziluth of the Kabala, represented in alchemy by Azoth, and in astrology by starry constellations. In the Ark of the Covenant it is present as the overshadowing wings of the Cherubims.

Upon the Ark and around it, to represent the zodiac, is a crown of gold. At each corner of the square base is a ring, two on one side and two on the other. Through the two rings on one side, to represent the pillar Jachin there is run a carrying stave; and through the two rings on the other side another stave to represent Boaz is run. Thus is this representation of the universe divided into masculine and feminine, as the zodiac is divided by summer and winter signs into north and south. Each ring with the pole through it has the elements of the number ten. So do astrologers divide the zodiac into spaces of ten degrees each, calling these important sections decanates. Each such decanate is ruled by a planet. Likewise the nine decanates of each quarter are presided over by one of the symbolical forms of the sphinx, that is, by the Bull, Lion, Eagle, or Man. The planetary rulers of the decanates of a quadrant, together with the ruler of the quadrant as a whole—for the symbolical forms of the sphinx are governed by Venus, Sun, Pluto, and Uranus—gives ten planetary rulers to each quarter of the heavens. These are symbolized by the four rings with the poles through them.

The two cherubims are in the two ends of the Mercy Seat, or realm of spirit. They are placed facing each other with their wings covering the Mercy Seat and meeting over it. They represent the highest mystery of man's being, the meeting of soul-mates in the realm of spirit. This attainment of angelhood is the climax of spiritual life, and is symbolized by the meeting of the overshadowing wings. The cherubims represent the angelic progenitors of the human race and the purified souls of previous rounds of humanity who through the union of the two monads have attained to angelhood. It was from this realm of life that Moses was instructed, as revealed by the twenty-fifth chapter of Exodus: "And there I will meet thee, and I will commune with thee from above the Mercy seat, from between the two cherubims which are upon the ark of the testimony, of all things which I will give thee in commandment unto the Children of Israel."

Within the Ark are four emblems: the rod of Aaron that budded, the cup that contains the manna, the tablets of the Law, and the manna contained in the cup. It is these four emblems, slightly altered, that today constitute the four suits of the tarot, and somewhat further altered are pictured as the four suits of common playing cards.

The rod of Aaron in the tarot has become the scepter of power, the clubs of common playing cards. It expresses creative force, the source of human energy; represents the executive attribute, and signifies virility. Astrologically it corresponds to the fiery signs of the zodiac.

The cup by its form represents reception, the feminine in nature. It remains unaltered in the tarot, and not less expresses the emotional nature of the watery signs of the zodiac when represented in modern playing cards by hearts.

The tablets of the Law have been supplanted in the tarot by the sword of retribution by which infringement of the Law is punished. These in common playing cards have given way to spades; the spade, a symbol of toil, being likewise an emblem of affliction. The tablets of the Law were joined to express the union of positive and negative forces, a thought preserved by the form of the cross in both the spade and the sword. Astrologically the tablets symbolize the earthy signs of the zodiac.

The manna held by the cup symbolizes the fruit of the union of positive and negative forces. What this fruit may be depends upon the forces united, but the product is considered as of value. Manna was of value at the time of its use. Money is of value, and the suit of pentacles of the tarot pictures this thought by coins. Intelligence is of even greater value; therefore, upon each coin, as symbol of intelligence, is depicted a five-point star. But in modern times diamonds came to be considered as of more value than silver or gold, and we consequently find diamonds pictured on the playing cards. Astrologically the manna symbolizes the airy signs of the zodiac.

These four emblems represent the four great universal principles everywhere and at all times operative. On every plane positive and negative forces unite in the production of new conditions. Man and woman unite physically in the production of children, they unite in regeneration to accomplish the Great Work, and twin souls unite to become the angel.

The High Priest of the Chapter looking into the Ark discovers the long lost book of the law and says: "You now see that the world is indebted to Masonry for the preservation of this sacred volume. Had it not been for the wisdom and precaution of our Ancient Brethren, this, the only remaining copy of the Law, would have been destroyed at the destruction of Jerusalem."

This is undoubtedly true; for had not the Ancient Masons taken the precaution to conceal their wisdom in the allegories of the various Scriptures, it would have been destroyed by religious fanaticism. And with even greater cunning, and in a manner more easily interpreted because less covered with irrelevant rubbish, they concealed their wisdom, yet perpetuated it with certainty, by engraving it on plates and giving these into the hands of ignorant persons as a means of gambling. They capitalized a popular vice and made it serve a good end; for although the Church has ever been suspicious of playing cards, they have been perpetuated and in the Egyptian Tarot we today possess an accurate copy of the Oral Law as it was understood of old.

Upon finding the manna in the Ark the High Priest says: "Companions, we read in the book of the law, that he that overcometh, will I give to eat of the hidden manna." He then gives each of the candidates a piece of the manna as a token that they have triumphed over their animal natures. Next he finds a stick with some buds upon it, which he proclaims is the rod of Aaron. Then he takes from the Ark four pieces of

paper which he places together so as to show a key to the ineffable characters of this degree. Needless to say these pieces of paper represent the scroll of heaven divided into four quadrants, and the characters, which may be translated in terms of the alphabet of any language, are the signs of the zodiac and the planets; for each planet and each sign corresponds to one letter of the alphabet.

By this correspondence between the common alphabet and the alphabet of the skies the vibratory influence of any name may be determined. And through the correspondence of the starry alphabet to numbers, tones, and colors the vibratory influences of these also are known. Then as the thought-cells within the astral body of man mapped in the birth-chart by the corresponding sign or planet pick up, radio fashion, the astral vibrations radiated by name, tone, number or color, and influence the individual's life and destiny accordingly, it is but a matter of comparing it with the birth-chart and progressed aspects to determine the precise influence on the individual of any name, tone, number or color with which there is close association. Those whose vibrations are similar to discordant thought-cells in his astral body increase the power of such thought-cells to attract disaster. On the other hand, those whose vibrations are similar to harmonious thought-cells (see Course 6, *The Sacred Tarot* for details) give added power to attract events which are fortunate.

The Lost Word Recovered

When the Ark is first found the three trying squares, which are the jewels of the three ancient Grand Masters, cover the names of Deity written in three different languages. This proves to be the lost Master Mason's Word which becomes the Grand Omnific Arch Word. It is written in three languages to indicate its application on all three planes of life. Its correct pronunciation is Jod-He-Vau-He but this is not revealed to the candidate until the ineffable degrees are reached, and he is then sworn not to pronounce it more than once in his life. As the word refers to marriage this vow signifies that promiscuity is not countenanced; for high magic depends for its success upon absolute purity. The Master Mason's Word, so long lost, and recovered as Jod-He-Vau-He, denotes that in every sphere and on every plane the spiral of life depends upon the interaction of positive and negative forces.

This Word applied on the plane of generation relates to bringing perfect children into the world. The Ancient Masons believed that children should not be the result of chance, but that they should be religiously prepared for. In the first place a time was selected for union that would bring the child into the world when the planetary influences were favorable to the qualities and fortune it was desired he should have. Then for a period of not less than a lunar month before union great temperance in all directions was exercised that both might be exceedingly virile and capable of great intensity. During this preparatory period the mind was kept lofty and as spiritual as possible through reading and devotional exercises. Also, during this period, the qualities to be possessed by the child were daily and vividly formulated and held in

the mind by both, these qualities having been agreed upon. Then during the time of union these qualities were again held in the imaginations of both. The Ancients held that under these conditions, if there was true love between the husband and wife and their energies blended harmoniously, that the child would be conceived who when born would possess the abilities and tendencies so formulated.

On the plane of regeneration the Master's Word relates to the blending of etheric and astral energies by which work is accomplished on the astral plane. Such blending of forces between man and wife only takes place when the energies have been raised to a higher vibratory frequency than that accompanying purely physical desire. Physical desire gives way to the mood of tender affection. And while caresses may assist to bring about the rapport between them, physical contact is not necessary, and they may be thousands of miles apart. Nor are any particular organs concerned in this higher union. It is a complete fusion of the finer forces and a blending of the astral bodies. There is an exchange of energy, a complete sympathy and a mutual understanding without the necessity of the spoken word, an entire absence of selfishness, the mind being lifted to new heights where the soul pants and longs for all that is spiritual and good, and pours itself out in blessings upon others. In this ecstatic union the participants are incapable of any thought that is base or gross or worldly. And because of the exalted vibratory state which they temporarily occupy, their minds are capable both of receiving priceless information from the inner realm and of creating conditions on the astral plane that later will externalize on earth for the benefit of all.

In its highest application the Master's Word becomes the Omnific Word, the union of soul-mates to become the angel.

The grand sign of the Royal Arch degree is made by locking the fingers of both hands together and carrying them to the top of the head, the palms upward. The interlocking hands refer to the union of man and woman. Being carried to the top of the head indicates regenerate union. The palms up signifies the expectation of receiving divine illumination as the result.

The initiation passed, the candidate is crowned by the High Priest. This indicates the natural right and ability of one to rule who has surmounted the trials, received divine illumination, and entered the most exterior grade of adeptship.

In this Royal Arch degree, which we have been considering, the construction of the temple is not attempted. The rubbish is removed and the site of the new temple is purified. During this work the key to the lowest arch of adeptship is discovered. This teaches that those who would entertain celestial visitors must purify themselves and thus have the temple a fit place to receive such exalted beings. When the candidate enters the vault by the light of virile illumination both the Oral Law and the Written Law are discovered and the Master's Word is received. Thus in the seventh degree the Lost Word is recovered. By the law of numbers, then, in the fourteenth degree it should be applied to the reconstruction of the temple, that is, given the correct pronunciation. And the twenty-first degree should see the temple erected.

The particular symbol of the Royal Arch degree is the two interlaced equilateral triangles in the center of which are two clasped hands, one a man's and the other a woman's. It is a symbolical representation of the Lost Master's Word. It means the marriage of man possessing an equally developed body, intellect, and soul with a woman possessing a proportionally developed body, intellect, and soul, by which they evolve the highest potencies of their spiritual and mental natures.

This symbol has a significance not unrelated to the symbol of the password Shibboleth of the F.C. degree. The latter is represented by a sheaf of wheat near a water-ford. The water-ford signifies the emotional nature by which the transition from generation to regeneration is accomplished, and the suspended sheaf of wheat represents the excellent harvest of new powers that are attained when the emotions are lifted to a higher plane of action.

9. Select Master Degree

—The Select Master degree is based upon the Ninth Major Arcanum of the tarot, corresponding to Aquarius, which is emblematical of Wisdom gained through experience. It is the emblem of Prudence.

At the building of Solomon's Temple it was feared that should the Children of Israel continue to disobey the Law, the temple would be destroyed by their enemies, and the knowledge of the arts and sciences, as well as that of the Oral Law, and of the models of the temple, would be lost. To prevent such priceless knowledge being lost to the human race, a secret vault was built leading from King Solomon's most retired apartment, or the most interior realm, in a westerly, or material, direction, and ending beneath the Sanctum Sanctorum. It was divided into nine separate arches, or grades, the ninth, or lowest, being a place for holding grand council, and to contain an exact copy of all in the Sanctum Sanctorum above.

This ninth arch represents the most external plane of adeptship, in which, by the Law of Correspondences, the candidate who has reached this state of wisdom recognizes that his constitution contains an exact copy of all that is in the sky above. The vault was built by 24 workmen, representing the diurnal rotation of the earth during 24 hours. This rotation progresses the horoscope and builds the various events into the life. The time for work was from 9 to 12 P.M. At that time the sun was entirely hidden from view, sinking to the lowest portion of the chart and passing from the house of pleasure through that part of the horoscope that rules hidden treasure, mystery, secret things, and the end of all undertakings.

The particular symbol of this degree represents three triangular tables arranged in a row. At each corner of a table is a lighted candle, and in the center a triangular plate of gold. Each table represents one of the three planes, and the three candles of each table represent the light shed by the three grades of adeptship belonging to each plane. The triangle of gold is the symbol of man's higher trinity seeking the golden light of wisdom.

The candidate to this degree is made to enact the part of Izabud, a friend of King Solomon, who through an oversight of the latter, and over zealousness on his own part, entered the ninth arch, and for so doing was condemned to death. He pleads for clemency, but is informed that only three can be employed in each arch, the number being already full. In the work of the adept, it is the higher trinity of his constitution that governs, the lower section having no voice in his doings; therefore, it is represented that only three workmen are able to work in each arch, or grade, of wisdom.

Finally it is decided to execute the guard Ahishar, who was asleep at his post and allowed Izabud to pass unchallenged, and to permit Izabud to live and fill his place. This drama impresses upon the candidate the necessity of prudence, that undue haste in matters of soul development is fraught with peril, and that when found worthy he will be admitted to the inner secrets. Should he, however, stumble unwittingly upon dangerous knowledge, he must never reveal it to the unworthy, and once initiated into its secrets he must ever be awake to his obligations and to his higher self; otherwise he will be found unworthy of such trust and will deserve the fate of Ahishar.

10. Super Excellent Master Degree

—The Super Excellent Master degree is based upon the Tenth Major Arcanum of the tarot, presided over by the planet Uranus. This Arcanum is called the Wheel of Destiny, and depicts sudden alterations of fortune.

The degree centers around Zedekiah, the last king of Israel, who is suddenly set upon with innumerable forces by Nebuchadnezzar. They first take the city, then the temple; and pursuing the king into the plains of Jerico whither he had fled by way of the gate which is by the king's garden between two walls, they capture and carry him to Babylon. In the prison of Babylon his thumbs are cut off, his eyes put out, and his body bound in fetters of brass. As a penalty for perjury he is carried captive into a strange land.

In the macrocosm the sun, bounded on either side by the wall of the northern and southern signs, is assailed by the forces of winter and flees through the gate of the autumnal equinox. He is carried captive into the winter signs, where his strength of will, symbolized by the thumbs, is cut off. His light is dimmed—put out—and his body is bound in the icy fetters between Libra and Sagittarius, these signs ruling the metals copper and tin, of which bronze is composed.

In this manner is indicated the fate of those who are weak enough to misuse their powers; for the Bible states Zedekiah did evil in the sight of the Lord, and as a consequence the temple was destroyed. Nebuchadnezzar typifies the forces of evil that beset the neophyte who disobeys the Law. And even when he deserts the temple and attempts by way of the astral world to flee through the gateway of death, bounded by the two external sheaths, or bodies, that encompass the garden of his desires, he is

yet pursued by the legions of Lower-Pluto, made their captive, and carried into iniquitous realms. His will is destroyed, symbolized by the loss of thumbs, his spiritual sight is put out, and he is bound to the nether regions by the fetters of his gross desires. Such is the fate of those disobedient to the admonitions of their higher selves.

11. Heroine of Jerico

—This degree is based upon the Eleventh Major Arcanum of the tarot, which is a pictorial representation of occult forces and feminine power. It corresponds to the planet Neptune.

The Heroine of Jerico was a woman who protected two spies sent from Israel.

She hid them from the King of Jerico by covering them over with stalks of flax. Flax is a symbol of strength. They made their escape by permitting her to let down a cord through the window; for her house was upon the wall of the city. The house of Neptune is Pisces and is on the wall, or equinoctial colure, dividing summer and winter. By means of the feminine powers of Neptune, the sun and moon, typified by the two spies, make their escape from the city of winter into the region of summer.

The sign of this degree is made by the candidate, who may be the wife of a Royal Arch Mason. She imitates the scarlet line let down for the escape of the spies. Taking a red handkerchief, she places one corner of it in her mouth and lets it hang down in front of her, crossing her hands on her breast over it. The red handkerchief is symbolical of woman's creative periods, which, did she but know it, are the source of her greatest strength. They constitute the index of her magical possibilities, and have been recognized in all ages as a source of occult power. The crossed hands upon the breast signify the use or abuse of the power according to good or evil inspiration.

The word is given by the man placing his right foot inside the lady's foot, his toe to her heel, denoting mutual understanding. He puts his right hand on her shoulder and says, "My life"; to which she replies by putting her right hand on his shoulder—the hands on each other's shoulders symbolizing mutual aid—and saying as she bends forward, "For yours." He then puts his left hand on her shoulder and says, "If ye utter not"; to which she replies by placing her left hand on his shoulder and saying, "This is our business." This is a symbol of mutual reception. Then he whispers the word Rahab. Thus is symbolized by these various actions the interdependence of man and woman for progress.

The brother then says, "It is very dark tonight." The candidate answers, "Yes, but not so dark but that I can see." He then asks, "What can you see?" She answers, "A scarlet line." Then she says, "Because it saved my life in the hour of danger." All of which refers to the life giving powers of woman.

Chapter 11

Serial No. 16
Original Copyright 1939
Elbert Benjamine

Copyright
Church of Light
August 2002

Degrees of the Cross

Chapter 11

Degrees of the Cross

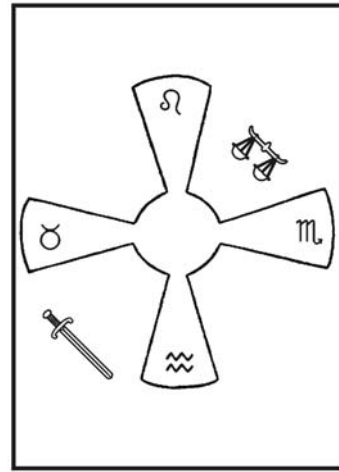

THE SIX DEGREES from the Heroine of Jerico to the Ineffable Degrees, as given in Richardson's Monitor of Freemasonry, are each based upon the Thirteenth Major Arcanum of the tarot, which pictures the transition from one life to another through death. They correspond thus to the zodiacal sign Aries; for the sun each year expires on the autumnal cross of Libra and is resurrected in spring on the vernal cross of Aries. One of the chief characteristics of this sign Aries is a warring disposition, therefore its cross is more frequently represented by a sword, the inversion of the cross of peace. This prepares us, consequently, to find in the ritual symbolizing the transition from one cycle to another through Aries, not only the emblem of the cross, but also much military display.

Whether we cross the etheric Boundary-Line symbolically referred to as the River Jordan through death, or temporarily through Extension of Consciousness, we function in a region where, because velocities are greater than 186,284 miles per second, time, gravitation and space take on entirely new characteristics, and the chief motive power is thought. Therefore before considering the rituals associated with the degrees of the cross which imply the individual moves to the inner plane, we should examine in some detail these characteristics of the realm where he will function.

Time on the Inner Plane

—What is implied by the different order of time to be found on the astral plane is illustrated by the report of the Zenith Foundation after thirty weeks of research into the gigantic mass of data on little-known mental powers, made available through the co-operation of its millions of radio listeners, from whom it received and tabulated over a quarter of a million pieces of mail in the winter of 1937-38.

Authentic personal experiences indicate that time is not a factor in telepathic communication. Possession of the ability to visualize in detail events which have not happened, a phenomenon science calls precognition, seems but slightly less rare than telepathy itself.

Now a point is a cross-section of a line, a line is a cross-section of a plane, and a plane is a cross-section of a solid. It must follow, therefore, that a solid object is a cross-section of four-dimensional existence, if existence has four dimensions. And certainly we cannot define an object's position completely unless we include time.

Thus in defining the position of an object it is not enough to say it is on the eighth floor of a building located at Second and Hill Streets, Los Angeles. That defines its position in three dimensions. But if the definition is to be complete it must contain the year, month, day and minute. When this fourth-dimensional position is added, then its place in the space-time continuum is completely defined. Furthermore, any solid whose position is thus specifically defined is a cross-section of its existence in time, that is, of the dimension extending from its past into its future.

One of the fundamentals of relativity is that there is no such thing as absolute time. Time, as indicated in chapter 9 in connection with the space-time conditions that express in the day-year progressed aspects in natal astrology, is relative.

The time of our clocks, for instance, is correlated to the velocity of the earth's rotation on its axis. But when, through some means, our consciousness is able to move more speedily to distant points on the earth's surface, we are able to apprehend events in our Now which, relative to a time correlated to the velocity of the earth's rotation, are in the past or in the future. By radio, for instance, on a Thursday evening here in Los Angeles, we can hear broadcasts of news of what is happening in Europe on Friday morning; and we can hear at 1:00 o'clock Thursday morning, a Hawaiian band playing in Honolulu at 10:30 o'clock Wednesday evening.

The soul, or unconscious mind of the individual, is the organization in finer than physical substance of the sum total of his past experiences. Its own particular movement through the dimension designated as time is called its World-Line. Each entity has its own world-line. And all back of the Now point in each world-line is fixed in time, or the fourth dimension; in other words, the past cannot be changed. Furthermore, the trend of world-lines can be projected into the future. But only in so far as the future is perfectly predetermined and not altered through the intervention of intelligent initiative.

When attention is turned from the physical world to the happenings of the inner plane, where velocities are greater than that of light, consciousness becomes more or less aware of what is happening there. And one of the characteristics of inner-plane consciousness is that in addition to observing happenings in their Now, it can move forward or backward along their world-lines. This it can do by virtue of its velocity, which compared to the velocities of physical life is as much greater, and as effective in altering the relation of time, as radio waves are in comparison to the turning of the earth on its axis. Thus is the inner plane observer able to view what took place in the

past as if he were witnessing it in the Now, and able to observe what probably will take place in the future as if it were taking place in the Now. To the extent his faculties are cultivated thus to look along world-lines, his ESP enables him to see in all its details any event that took place in the past, and any event that, unless there is intervention by intelligent initiative, will take place in the future.

Distance on the Inner Plane

—The Zenith Foundation reported after digesting the results of its comprehensive tests: “That distance and space are not factors in telepathic communications seems definitely indicated by careful analysis of test returns by geographical divisions.”

According to relativity, anything moving with 90% the velocity of light shortens to half its length, and at the velocity of light loses all its length. Now as an object cannot have a minus length, that is, a length which is less than nothing, when its velocities are greater than the Boundary-Line energies where it loses all its length, this matter of length ceases to have significance; for the object then has moved into an order of relations where the common conception of distance no longer obtains.

Yet vibrations are space-time relationships. Vibrations have amplitude and frequency, which means that there are a given number of vibrations within a specified interval of time and that each wave occupies a certain space, or if not of ordinary Boundary-Line wave structure, of that which corresponds to space.

And when, through attaining velocities in excess of 186,284 miles per second, an object exists on the inner plane, where distance cannot be measured in terms of physical length, there is still distance of a new order, the distance between vibratory rates. On the inner plane distances are as vast as on the external plane, even though there are no longer such space relations as we are familiar with on the physical plane. Physical space vanishes, and gives place to a space which is measured solely in terms of vibratory difference.

This means that on the inner plane two people are as close together when one is in Los Angeles and the other is in Hongkong as they are if both are in the same room in Los Angeles, provided their vibrations remain the same when one is in Hongkong as when both are in the same room in Los Angeles. This also means that on the inner plane two people in the same room may be at a vast distance from each other, so far apart that it is almost impossible for one to contact the other.

Gravitation on the Inner Plane

—According to relativity supported by many experiments with projectiles shot from radio-active matter, projectiles which at times attain tremendous velocities, not only do objects shorten as they acquire higher velocities but they also acquire mass, so that at the velocity of light their resistance to change of motion due to mass becomes infinitely great.

Yet just as it is impossible to have a length which is less than nothing, so also is it impossible to have a mass greater than infinity. Consequently, when velocities greater than those of the Boundary-Line energies are attained, and due to this high velocity something exists on the inner plane, gravitation no longer has an influence over it, nor can physical things influence it in any way. The attraction of gravitation has lost its significance, and attraction of an entirely different order takes its place. This new order of attraction is the affinity of its dominant vibratory rate for a level of inner plane existence of a similar vibratory rate.

Up and down on the physical earth are directions away from or toward the gravitational center of the earth. But up and down on the inner plane are vibratory rates which are higher or which are lower than those of the level where, because of dominant vibratory rates, something habitually exists. Thus it takes effort, the effort temporarily to increase or decrease the dominant vibratory rate, to move away from the astral level where one commonly functions. The basic vibratory level, which may be compared to the carrying wave of radio, attracts everything else having a similar dominant vibratory rate to it very much as gravitation attracts physical objects to each other. But instead of merely pulling down when an intelligence temporarily has raised its dominant rate above that of its normal level, it also pulls up with equal force when the dominant rate temporarily has been lowered by the intelligence below its normal level.

Knights of Three Kings

—It is said that at the dedication of the temple Solomon invited all the Eastern Royalty to attend and assist in the ceremonies. And it so happened that two of the kings were at war. These two kings represent the summer and winter halves of the zodiac, and are spoken of as Eastern because it is the Eastern point of union that is considered. Solomon attempted to reconcile them, but to no avail. Finally he invited them into a small apartment of the temple, locked the door, and informed them that they would be kept in darkness with nothing to eat but bread and water until they would agree to live in peace. Solomon went to the chamber on two consecutive days without receiving a favorable reply, but on the third day he was informed that they had agreed. He then advanced toward them holding a lighted candle in each hand saying: “If you can agree in the dark you can in the light.”

Now at the winter solstice the sun sheds least light upon the northern hemisphere of the earth, the home of the Ancient Masons. From the winter solstice to the vernal equinox, through three zodiacal signs, Sol struggles to bring winter and summer together. This is the rainy season of the year during which the earth is in darkness due to obscuring clouds. It is the time when famine pinches hardest; for the food garnered the previous autumn has been exhausted during the tedious barren winter. The frugal fare of bread and water refers to this dearth of food and the prevalent rains.

The sign of the degree is to hold out the arms from the body to form a cross, with a candle in each hand. The outstretched arms form the vernal cross, and the two candidates represent the sun and moon in opposition as stationed at Easter, or the resurrection; for this only takes place after the full moon after the sun has crossed the vernal equinox. Agreeing in the light refers to the reconciliation of winter and summer and the passing of the sun into the light of the summer signs, when the days become longer than the nights. As the two kings kept each other from the light, so man and woman in antagonism keep each other in spiritual darkness. The watch-word is Agreed.

Knights of the Red Cross

—This degree originally was called The Order of the Knights of the East, signifying the spiritual illumination of those who willingly sacrifice themselves on the cross of expiation. Astrologically it refers to the rising vernal sun. Later it was changed in Palestine to Knights of the Red Cross, representing the cross of the physical plane rather than that spiritual, and as such symbolizing the effort to administer to the physical ills of humanity, to alleviate suffering, save life, and protect the weak.

The sword, an inverted cross, plays an important role in this degree as do various military maneuvers. The knights count themselves into two equal divisions which stand facing each other to represent the signs of winter and summer, the two halves of the zodiac. In fact, most ancient peoples had years of six months, a custom still followed by the Jews. The sacred Year of the Jews is from the vernal equinox to the autumnal equinox and their Civil Year is from Libra to Aries. The knights go through sword play to indicate the struggle between the two opposing forces and then communicate the Jewish Pass, which is given with three cuts over an arch of steel. The three cuts represent the three months of struggle as the sun comes forth from the tomb of winter, and is also symbolical of united action on all three planes of life.

The arch of steel is made by crossing the swords at the level of the waist line, or Libra, symbolizing the autumnal equinox. Each brother steps forward with the left foot and with the free hand seizes the opposite brother by the shoulder to signify union, and in this position they alternately pronounce the passwords. The Jewish passwords Judah and Benjamin symbolize the two signs in which the sun exerts its greatest power, Leo and Aries. Jacob said of Judah: “Judah is a Lion’s whelp, from the prey my son art thou gone up. He stooped down, he crouched as a lion,” referring in an unmistakable

manner to the sign of the Lion. The wolf equally with the ram is sacred to Aries, denoting its fiercest aspect. Jacob said: "Benjamin shall rave as a wolf, in the morning he shall devour the prey, and at night divide the spoils." These Jewish passwords symbolize the home and exaltation of the sun, and are pronounced over the equinoctial cross to indicate the reign of summer and the predominance of masculine forces.

The Persian Pass is given under an arch of steel. The swords are crossed at the level of the head to represent the vernal equinox, Aries being the sign ruling the head. Under this arch the words are given alternately by each. The words are the names of the Persian governors who for a time contended against permitting the temple to be built. They were Tetnai and Shetharboznai. As alien rulers they represent the sun's detriment and fall, Aquarius and Libra, and the triumph of winter over summer, feminine forces over masculine. They are pronounced below the vernal cross to indicate the sun's weakness when in these signs.

The Red Cross Word is communicated by giving three cuts and then drawing the sword back as if to stab the companion of the opposite division to the heart, the word "Veritas" being spoken by one, and the other answering, "Right." The four signs presiding as rulers of the four quadrants of the zodiac symbolize the One Principle, the One Law, the One Agent, and the One Truth that united sum up all possibilities. The Lion, or Leo, sign of the heart in which the sun exerts its dominant power symbolizes the One Principle. The opposite sign of the zodiac, Aquarius, representing the perfection of intelligence, symbolizes the One Truth. The Red Cross Word, Veritas, means Truth. The Red Cross Sign refers to Leo, and both sign and word symbolize the action of the sun at opposite points in the zodiac; in Leo, the sign of its rulership, and in Aquarius, the sign of its detriment. It emphasizes the truth that man rises to his greatest potency when inspired by his affections. The three cuts typify the three signs of each quarter presided over by each of the emblems, Lion and Man, and to the three planes where truth and affection may be applied.

The sign, grip, and word of a Red Cross Knight are given by first clashing the swords together to denote a struggle between opposing forces, between life and death. Then the thumb and forefinger of the left hand are placed to the lips in the attitude of one blowing a blast on a horn, signifying the trumpet of resurrection sounding the triumph over death. Finally three cuts are made to signify the three signs through which the sun passes from its tomb of winter to the cross of spring, and the fingers of the free hands are interlaced to indicate that it is through union that the triumph will be attained, the union of the sun and moon, of man and woman. In this position, with the swords crossed level with the head, or Aries, the word Libertas is pronounced and the opposing brother acknowledges it to be right. Libertas means liberty. Resurrection is the freeing of the soul from earthly bondage. The powers of the sun are freed by the moon on Easter after passing the vernal cross. Man's occult powers are liberated by woman, their mutual efforts lifting them out of the winter of materialism.

The Chamber of the Order of the Red Cross is divided into two apartments by a veil. The apartments represent the two halves of the zodiac and the veil symbolizes the equinoctial colure. The Council being opened, the companions sit in a semi-circle to represent the signs of one half of the zodiac. They each take their hats and toss them on the floor to symbolize union to be lacking, the positive and negative forces separated. They represent the sun. They place their elbows on their knees and bow forward with their heads resting on and supported by their right hands, this dejected attitude being meant to typify the weakness of the sun in the winter signs and the weakness of man to resist the forces of evil when apart from woman. The Prelate then reads at length how after the death of Cyrus, King of Persia, the Children of Israel were interrupted in the building of the temple by their adversaries on the other side of the river. The river, or dividing line, represents the equinoctial colure, and the adversaries represent the forces of winter. A new King, Darius, having ascended to the throne of Persia—that is, the sun having entered another winter sign—Zerubbabel decides to make a journey to the new king and remind him of his promise to send back to Jerusalem all the holy vessels remaining in Babylon. These holy vessels are the planets remaining in the winter signs of the zodiac, and in man represent his divine potentialities which are hidden and hampered by his material inclinations.

The candidate now personates Zerubbabel and takes his obligations kneeling at the altar on his left knee, his right hand grasping the hilt of his sword and his left hand resting on the Bible, square and compass, on which are two swords crossed at right angles. His attitude signifies not only his willingness to abide by the higher and lower laws represented by compass, square, and Bible, but denotes by the crossed swords his determination to conduct an actual warfare against the forces of evil and death. Then the candidate in his travels comes to a bridge which he is told separates the Jewish from the Persian nation. It is the equinox, which he passes by giving three cuts and the Jewish Pass, indicating the fall of the sun from the summer solstice through the sign of its greatest strength across the autumnal equinox of Libra through the three first winter signs. Its entry into Capricorn is symbolized by the Persian Guards taking him captive, making of him a slave in fetters, and putting sackcloth over his head. This is the furthest point of winter; the point in the cycle of the soul where it has evolved to the lowest state of matter and is ready for evolution back to spirit. As a slave he is led to an audience with Darius, who represents the Man of the heavens, Aquarius, presiding over the last quarter of the zodiac.

The candidate is freed by Darius, the king of the zodiacal quarter symbolizing Truth, and invited to a banquet where it is the custom to propound and answer questions. The question is asked, “Which is of greatest strength, wine, the king, or women?” After a long discussion of the relative strength of each it is decided that Truth is stronger than any of the others. The candidate is commended for this answer and is reinvested with his weapons and insignia which were taken from him when he was made prisoner. The royal sign of the zodiac, Leo, is meant by the king, the bibulous

sign Scorpio is signified by wine, and the sign of Venus, Taurus, which is also the Moon's exaltation is referred to as women. Truth is symbolized by Aquarius. The Man of the zodiac is the product of the influence of all other signs, and represents the climax of material evolution. Truth is the highest possible standard, and man through his apprehension of truth is made Free and Immortal.

The particular emblem of the Knight of the Red Cross is a seven-point star in the center of which is a red cross surrounded by a circle in which are the words: "Magna est Veritas et Praevalebit." The red cross is emblematical of the world of physical suffering. The seven-point star represents the seven active principles in nature. The circle is the zodiac. The words mean that Truth is Mighty and Will Prevail. The whole symbolizes the fact that One Indomitable Truth pervades alike the zodiac, the spheres of planetary angels, and the world of mundane suffering; and that man's individual progress depends upon his ability to comprehend that Truth and conform his efforts to it.

Order of Knights Templar

—The Encampment of Knights Templar is divided by a veil into two compartments to represent the summer and winter halves of the zodiac. In front of the throne is a triangle, representing man's triune nature; body, soul, and spirit. Above it is a banner with a cross upon it surrounded by rays of light, symbolizing renewed life through death, and light received through union. On either side are sky-blue banners, the color of Saturn, of wisdom gained through earthly experience. The one on the right bears a pascal lamb above which is a maltese cross and the motto: "The Will of God." The lamb is the equinoctial sign Aries, where the sun is rejuvenated in spring. The maltese cross is the emblem of the solstice where the sun crosses from eastern to western or from western to eastern zodiacal signs. Each of its arms represents one quarter of the zodiac. The whole emblem symbolizes the sun sinking to the winter solstice and relinquishing the virile powers conferred by Aries. The Son of Man referred to this waning strength by saying: "Thy Will not mine be done," which is the significance of the motto of the banner. The banner upon the left has upon it the emblems of the order—a sword, a battle axe, trumpet, and shield—symbolizing by their form the signs ruling the zodiacal quarters: Taurus, Leo, Scorpio, and Aquarius. Above these is a crowing cock, representing the triumph of virility over death and the conditions imposed by the stars. It is typical of the sun resurrected into the signs of summer, immortality victorious over mortality. The three banners symbolize the cross of Christ between the two crucified thieves. The cross of Christ is the autumnal equinox, from which the sun sinks into the tomb of winter. The maltese cross dominating the lamb is the solstitial cross of winter, symbolizing the unrepentant thief. The crossed emblems on the right of the cross of Christ being surmounted by a crowing cock represents the vernal cross and the repentant thief to whom the Son of Man promised: "Today shalt thou be with me in paradise."

The knights are dressed in black to indicate the inevitableness of death. A black sash trimmed with silver lace hangs from a black rose on the right shoulder across to the left side, having suspended from it a poinard and a maltese cross. The sash as worn represents the solstitial colure dividing the zodiac into east and west. The western signs are symbolized by the black sash and the eastern signs by the white of the silver trimming. The black rose symbolizes the extinguishment of life and the decline of the sun from the autumnal equinox to the winter solstice. The maltese cross is typical of the solstice, and the poinard represents the vernal equinox; for by its form it is an inversion of the cross of Libra. The particular emblem of the order is worn on the left breast to indicate its dominance over the material motives. This emblem is a nine-point star in the center of which is a golden serpent entwined about a cross and surrounded by a circle in which are the words: "In Hoc Signo Vinces." The nine-point star symbolizes the moon and the eight planets under whose influence experience has been transformed into wisdom. The cross represents the cycle of life completed, and the serpent entwined on it represents wisdom gained through experience with good and evil. The words mean that Under This Sign Thou Shalt Conquer. The whole symbolizes wisdom gained through cyclic experience, by which death will be conquered and a new life gained.

The apron worn by a Knight is black, of triangular shape, trimmed with silver lace, having on it a serpent entwined about a cross, skull with crossbones, and stars placed in triangular form with a red cross in the center of each. The apron symbolizes by the black trine involution, and by the trine of silver lace, evolution. The serpent entwined on the cross means wisdom gained through experience during involution and evolution. The skull and crossbones are a reminder of the inevitableness of death and the following resurrection. The skull is typical of death and transition; the end of the cycle of life, or zodiac, being ruled by Aries, the commencement of a new cycle. The crossed bones signify the equinox, and being Marrow Bones signify renewed life; for it is thought that blood corpuscles, emblematical of life, are formed in the red marrow of the bones. Because of the red cross in the center, each of the three stars represents one of the kingdoms of physical life; mineral, vegetable, and animal; through which, amid suffering, the soul has evolved before arriving at the estate of man.

In this degree the Knights are arranged in the form of a trine to represent the union in a harmonious manner of once opposing forces. The candidate is taken to the chamber of reflection, which is a small room with its walls and furniture painted black to represent the tomb. Upon a table in front of him is a Bible, typifying the Law, skull and crossbones to signify his companionship with the dead, a bowl of water for ablution to represent purification before ascending to higher realms even as the sun must be baptized by the overflowing urn of Aquarius and pass through the waters of Pisces before the resurrection; and a small taper symbolizing his consciousness directly after death. Here he must write and sign his name to the answers to three questions. The first is his affirmation never to draw his sword except in the defense of

the Christian religion. It signifies his intent to combat evil only. The second answer affirms he has nothing heavy on his conscience, referring to the expiation of ill deeds in the astral worlds of purification. The third is his avowed intention to abide by the rules of the Encampment, meaning that he will conform his endeavors to whatever laws are necessary for spiritual advancement.

The question being satisfactorily answered he is dressed in pilgrim's weeds and sent on a seven-year pilgrimage to represent man's experiences on the material plane. He is provided with sandals, symbolizing the Oral Law, the traditional writings of men; bread, symbolizing material experience; and water, symbolizing emotions. One after another he passes the guards of the different veils, who each examine his script, give him good advice at some length, replenish his supply of bread and water, and send him on his way. This represents the sun moving past the summer solstice, past the autumnal equinox and winter solstice, and thus through three quadrants of the heavens. Finally the candidate is admitted to the fourth compartment to represent the sun in the last quarter of the zodiac. This symbolizes man triumphing over the four elemental kingdoms of earth, fire, water, and air. Having been found worthy, his sentence is remitted from seven years to three and he is given a sword and buckler to symbolize the sun passing to a new cycle. It also symbolizes the man, arrived at physical adeptship before the allotted span of life has been passed, who undergoes voluntary dissolution so that he may better support the heavens and combat the hells of the astral region.

The candidate has now become a Pilgrim Warrior sentenced to serve seven years in warfare, and has been given the Pilgrim Warrior's pass, Maher-Shalal-Hashbaz, meaning to spoil. This is given with four cuts under an arch of steel, to represent the necessity of conquering the four kingdoms of the astral world, the arch symbolizing the vernal cross of Aries. He now goes on a pilgrimage of warfare and again passes the three guards and comes to a halt before the fourth veil guarding the asylum. This asylum, as the region where the step to a new phase of initiation is taken, refers to the sign Pisces, the last sign of the zodiac, which rules imprisonment and places of refuge. To indicate the candidate's desire to complete the cycle and pass to higher realms the Senior Warden stamps on the floor three times four, referring to the four zodiacal triplicities. Here he gives assurance that he holds no enmity toward any soul on earth. This symbolizes the end of purification, typified in the zodiac by the urn of Aquarius. He is now required to partake of five libations, signifying the synthesis of the four quarters of the zodiac in the form of the fifth emblem represented by the sphinx. The first four are water mixed with wine, material emotions mixed with those spiritual; but the fifth is of pure wine to represent complete transmutation into spiritual life. The first libation is to Solomon, King of Israel, or the ego. The second libation is to Hiram, King of Tyre, the spiritual body. The third libation is to Hiram Abiff, the Widow's Son, the divine soul. The candidate is in front of a triangular table around which are ranged twelve burning candles and twelve cups, symbolizing life and love, the positive and negative aspects of the twelve zodiacal signs. In the center of the table is a black coffin, symbolizing the tomb. Above this is the Bible,

representing the Law that progress is made through death, the latter represented by a skull and cross-bones resting on the Bible. The Prelate then reads concerning the betrayal of the Christos by one of the twelve, and orders the candidate to extinguish one of the tapers to signify the apostasy of Judas Iscariot, the zodiacal sign of death, Scorpio.

The skull, which symbolizes the soul-mate of Hiram, and Pluto, ruler of the sign of death, is called Old Simon in memory of Simon of Cyrene who bore the cross of Christ and shared his misfortunes. The history of the trial and crucifixion being read, the candidate is called upon to drink the fourth libation to Simon of Cyrene. His term of warfare is reduced from seven to three years on account of good behavior and he must now pass a year in penance. He takes the skull in one hand and a lighted taper in the other, symbols of life and death, and travels to the sepulchre of the sun. He gains entrance to the sepulchre by means of five cuts, a symbol of intelligent dominion of the four zodiacal quarters, and by means of the password Golgotha, which means a skull, and symbolizes the end of life. At this point is read the portion of the Bible relating how the angel of heaven rolled the stone away from the tomb of the sun. That is, the sun descending from the cross of Libra into the Tomb of Capricorn reascends to summer because the angle of heaven of equinoctial Aries rolls away the stone of winter.

The candidate is now given a black cross, symbolizing the autumnal cross of death. It signifies the stage of the adept's journey representing the second death, the transition of the spiritualized man of the higher astral realms into the realm of pure spirit above the astral. The candidate is shortly admitted to the asylum, or fourth room and requested to drink from the skull the fifth libation of pure wine. This fifth libation symbolizes the spiritual body that survives the second death. It also symbolizes the reunion of soul-mates, the first libation representing the ego, the second the spiritual body of Hiram, the third the divine soul of Hiram, the fourth the soul-mate who shares all spiritual vicissitudes, and the fifth the spiritual body of the soul-mate which blends with Hiram's after the second death. In case the candidate refuses to take the fifth libation as ordered he is charged by six knights with drawn swords. He is the seventh, thus indicating that the septenary of existence compels this spiritual reunion if immortality is to be attained.

Having partaken of life from the cup of Aries, the skull, he is appointed to fill the vacancy caused by Judas Iscariot, and so relights the extinguished taper; for Aries, the sign of life, is presided over by the same planet as the co-ruler of Scorpio, the sign of death. The dieugard is given by placing the end of the thumb under the chin, the fingers clenched. It denotes the Will to conquer death by passing into the new cycle represented by the chin which is the particular portion of the head where Aries exerts its most pronounced rulership. The cross is given by drawing the hand horizontally across the throat and then darting it up before the face. This is the vernal cross of life. The grand hailing sign of distress is given by placing the right foot over the left,

representing the solstitial cross, and extending both arms to signify the autumnal cross, the head inclining to the right in dejection to indicate lack of power. The grip is given by interlacing the fingers of the right and left hands with the opposite brother, and as each crosses his arms pronouncing the word Emmanuel. It refers to the reascension through union after transition.

Knights of Malta

—This degree is usually given with the Order of Knights Templar. The sign is made by holding out the hands as if warming them, representing the heat of summer. The lower edge of the left hand is then seized near the middle with the thumb and forefinger of the right hand, representing the painful influence of the sun as it crosses the vernal equinox after being attacked by the claws of the Scorpion, and then the hands are raised in this position to a level with the chin, or Aries, and finally disengaged with a quick motion that extends them down at an angle of forty-five degrees, as if the evil influence of death, or Scorpio, has been thrown off. It is said to refer to Paul when shipwrecked on the Island of Melita being bitten by a serpent as he warmed himself at a fire.

The grand word of a Knight of Malta is INRI, said to be the initials of the words, Iesus Nazarenus, Rex Iudaeorum, meaning Jesus of Nazareth, King of the Jews. But all well informed occultists know these initials are of the words, Igne Natura Renovatur Integra, meaning All Nature is Renewed by Fire. This refers to the rejuvenating effect of the creative principle when properly applied and transmuted on the rosy cross of spring.

The grip and word of a Knight of Malta are given by interlacing the fingers of the right hand, placing the forefinger in the other's palm, reaching across with the left hand and pressing the fingers into the other's side at the waist line, or Libra. With the arms thus crossed one pronounces the words, "My Lord," and the other rejoins, "And My God." Their union in this fashion forms a maltese cross and an equinoctial cross, over both of which the sun passes annually. The fingers in the palm refer to Jupiter ruling the sign Sagittarius from which the sun crosses the winter solstice into Capricorn. Jupiter is the greater fortune, the planet of generosity, and this emphasizes the necessity of unselfishness in united effort to gain immortality. The exclamation, "My Lord," means all is under Law; and "My God," refers to the ego overshadowing counterpart souls the final reunion of which results in immortality. This sign is said to refer to Doubting Thomas who must feel the nail prints and the spear wound in the Master's side.

Knights of Christian Mark

—The ritual of this degree is based upon resurrection and punishment or reward for deeds done upon earth. After prayer each knight, one after another, takes the Bible and waves it four times over his head saying, “Rex Regnantium et Dominus Dominantium,” (King of Kings and Lord of Lords), then kisses the book and passes it to the next and so on around the circle. It symbolizes the sun’s passage through the four quarters of the zodiac, signifies that all is under law, and that the sun is the source of all physical and spiritual life. The sign is given by each knight interlacing the fingers of his left hand with those of his brother, and pointing a sword towards his heart, at the same time saying, Tammuz Toulimeth, meaning that life is uncertain and transitory. The sign symbolizes the fall of the sun from Leo, or the soul from spiritual realms, across the equinox where summer and winter, or spirit and matter, join. The candidate is dubbed a knight of the Christian Mark by interlacing his fingers with those of the Invincible Knight and placing his other hand over his heart. The Invincible Knight and the Senior Knight then cross their swords on the back of the candidate’s neck, to symbolize the equinoctial cross of spring, and give him these words, “Tammuz Toulimeth,” an assurance of the certainty of death and the uncertainty of life.

Next, the Senior Knight reads a long passage the purport of which is, “For he that overcometh, the same shall be clothed in white raiment, and his name shall be written in the book of life.” Six Grand Ministers, representing the six summer signs of the zodiac, come forward with swords and shields and one with an ink-horn. They are told to execute the judgment of the Lord, whereupon the candidate bewails his fate that his lips are unclean. The first Minister takes a live coal from the altar and touches it to the candidate’s lips, representing the purification after the resurrection, and the sun’s passage through Aries after its rebirth. The candidate is then marked on the forehead with a signet leaving the words, King of Kings and Lord of Lords, and is told that the number of the sealed is one-hundred-forty-four-thousand. This refers to an ancient tradition that each volute of every round of humanity produces its harvest of immortal souls. A volute is one precessional cycle. The twelve signs through which the sun annually passes while the equinox is in each sign, multiplied by the twelve signs that the equinox passes through in the precessional cycle, make up the one-hundred-forty-four varieties of souls born during one evolutionary volute of time. Those of all the one-hundred-forty-four zodiacal possibilities who find the Law, or Lord, and abide by it become spiritual kings.

The insignia which is worn over the heart is a triangular plate of gold, representing body, soul, and ego. On one side is the letter G in a five point star. It symbolizes that intelligent man is the climax of evolution through generation. On the other side are seven eyes, symbolizing the seven states of consciousness attained by the adept.

Order of Knights of the Holy Sepulchre

—This degree is said to have been founded by St. Helen, mother of Constantine the Great in gratitude for her success in finding the true cross. She had made a journey into the Holy Land and found three crosses but was unable to determine which was the right one. Pope Marcellinus made a test by taking them to the bedside of a dying woman. Touching the first cross, the autumnal cross of Libra, did not affect her. The second cross, the solstitial cross of Capricorn, produced no beneficial effect. But on touching the third cross, the life giving cross of Aries, she immediately was restored to perfect health. It is this latter cross which in spring revivifies the whole world.

The most significant ritual of this degree represents the candidate taking up arms, Aries fashion, to “guard the Holy Sepulchre,” the body and material possessions; to “defeat our enemies,” the negative forces of evil or winter; to “unfurl the banner of our cross,” life through union; to “protect the Roman Eagle,” transmute the sex forces into constructive channels; to “return with victory and safety,” return to spiritual realms consciously victorious over sense and seeming. The candidates first interlace their fingers, cross their arms and say, “*de mortuis, nil nisi bonum,*” meaning that nothing should be said but good concerning the dead, as the so-called dead are often conscious of our thoughts and words. The interlaced fingers indicate union in accomplishing their mission to overcome the forces of evil denoted by the autumnal cross.

They sally forth, going toward the south, even as the sun after the summer solstice moves south to the struggle with winter after passing the autumnal equinox. They meet a band of Turks, representing the feminine forces of winter, with whom they do battle, seize the crescent and victoriously return north to the Cathedral, the summer signs. They triumphantly place the banner, eagle, and crescent before the altar. The Holy Sepulchre is the winter solstice, matter, or when applied to the incarnating soul it is the mother’s womb through which it comes into a new life. As applied to incarnate man it is the body in which he is encased awaiting the period when earthly gestation shall be accomplished and he shall be set free from matter. Applied to the departing soul it is the grave. Yet for the righteous death has no sting and the grave has no victory. This is the significance of the Word of the Order, *Sepulchrum*, meaning sepulchre. The Roman Eagle bears testimony to the thought; for the same sign representing death, the stinging Scorpion, through regeneration becomes the soaring eagle of spiritual life. In this regeneration the sun is not alone; for the crescent moon is also given a place before the altar even as man and woman mutually sustain each other.

Order of the Cross

—The Provost reads the following in opening this degree: “It is now the first hour of the day, the time when our Lord suffered, and the veil of the temple was rent asunder; when darkness and consternation were spread over the earth; when the confusion of the old covenant was made light in the new, the temple of the cross. It is the third watch, when the implements of Masonry were broken; when the flame, which led the Wise Men of the East, reappeared; when the cubic stone was broken, and the word was given.” The first hour when the Lord suffered refers to sunrise on the day of the autumnal equinox, the veil of the temple which was rent being the equinoctial colure which was passed by the sun. Nights then became longer than the days and the covenant of summer gave place to winter. The sun had passed through three signs since the summer solstice, or now the third watch. The virility of the sun, mace and plumb, are broken on the cross. The cubic stone is the winter solstice, the dividing line of inertia, which is broken by the reappearance of the sun at Epiphany, the word then being given that heralds resurrection.

The sign is made by looking a brother full in the face and touching him on the right temple, the phrenological faculty of construction, meaning the use of constructive effort which is a quality ruled by Aries. The mark is Baal, Sha-Lisha, Lord of the three, meaning control over the three bodies; physical, astral, and spiritual. The candidate must give correctly his name, age, birth place, and residence; the data for erecting his birth-chart. The initials of the mark, IHS. Iesus Homium Salvator, Jesus Savior of Men, are in Hebrew, Jod-He-Shin, man and woman together attaining adeptship. In Latin they are the initials of words meaning, Son of Man Triumphant.

Secret Monitor

—This trading degree is founded upon the Twelfth Major Arcanum of the tarot, called the Hanged Man, corresponding to the sign Pisces, ruling universal brotherhood as well as intrigues and secret organizations.

The history of this degree refers to the brotherly love existing between Jonathan and David in the time of Saul. By means of arrows, symbolical of evil news Jonathan warned David to flee the wrath of Saul, or Saturn. David represents the sun, and Jonathan represents Jupiter, the co-ruler of Pisces and the ruler of Sagittarius, the zodiacal sign of the arrows, which is adjoining the sign Capricorn, ruled by Saturn, or Saul.

The signs of this degree are made secretly to assist each other in financial transactions. Yet to use psychic warnings from the invisible brethren for material advantages over our fellowmen is contrary to occult law, and is apt to be punished with the arrows of affliction. Those who proclaim the Piscean doctrine of universal brotherhood should be willing to make the necessary sacrifices to practice their doctrines. Failing to do so the penalty of expiation will fall as indicated by the dieugard, which is made by assuming the attitude of one who shoots an arrow. It is the symbol of vengeance.

Chapter 12

Serial No. 17
Original Copyright 1939
Elbert Benjamine

Copyright
Church of Light
August 2002

Ineffable Degrees

Chapter 12

Ineffable Degrees

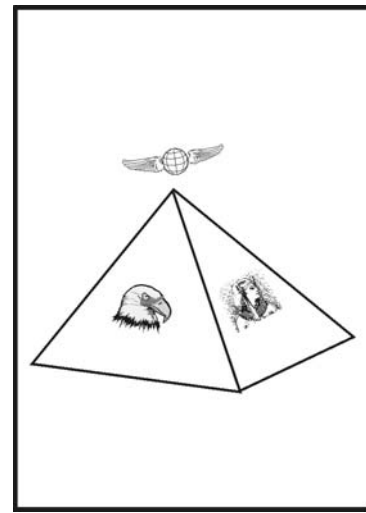

OF THE EMBLEMS belonging to the Master's degree, the naked heart symbolizes conscience, and indicates that on the inner planes the motive of any action can never be concealed, and that every impulse is laid bare.

The three steps on the Master's carpet symbolize the three steps in the sun's annual journey; its fall from summer into winter over the autumnal cross, its encasement in the tomb of winter at the southern solstice, and its final resurrection into a new summer by way of the vernal cross. In the cycle of the soul this represents the soul's descent into the mineral realm, its evolution through lower forms of life up to the state of man, and from man, by way of the equinox of regeneration, evolving into the still higher state of angelhood.

The sword pointing to the naked heart signifies remorse for past misdeeds; true repentance followed by penance. It exemplifies the truth that every mistake must be atoned for, and every debt of conscience paid to the last farthing before the spiritual plane is reached. Evil done on earth pursues the soul, as signified by the sword, into the astral. In this realm the conscience is laid bare, as signified by the naked heart, and atonement made through suffering and purification.

The hour-glass is an emblem showing the point where angel and animal meet in the soul and body of man; the up-pointing trine indicating the sands of time through which, in evolving from the animal to the human, there were developed the required initiative and selfish propensities. The down-pointing trine represents not the selfish acquiring of material things denoted by the sand accumulating below; but the evolution of man to angel, which requires giving to society, not receiving from it, well symbolized by the sand of this trine flowing freely away from it.

That Which Determines Control

—As the degrees upward from those of the cross, representing transition of the activities to the inner plane, repeatedly refer to ability to control the energies thus contacted and to ability to prevent control by entities thus contacted, this seems to be the place to set forth the principles on which rest such control.

To contact through the inner plane anything belonging to any realm the vibrations must be raised or lowered until they are similar to the vibrations of that which is to be contacted. When such contact is made, the similarity of the vibrations affords opportunity for the exchange of energies. The energy flow is always from the highest potential to the lower potential. This potential difference between individuals and between persons and objects is well illustrated by the Contact Potential Difference between metals discovered by Volta:

Volta found that when pieces of two different metals, otherwise insulated, are brought into contact, they acquire opposite charges and maintain a difference of electrical potential even while still touching. This potential difference he found to be characteristic of the given pair of metals. Thus when the metals are iron and copper, the iron has a potential about 0.15 volts higher than the copper, while for tin and iron the difference is 0.31 volts, tin being the higher. Volta listed a series of several metals, viz., zinc, lead, tin, iron, copper, silver, gold, such that when any two are put in contact, the one first named is at the higher potential.

I have quoted this principle of Contact Potential Difference from a standard work on electricity because it operates in all action of the mind and is an outstanding factor in ESP and in every variety of psychic phenomena. When we say, for instance, that one person is positive and another is negative, it implies that the one has a high potential and the other has a low potential. Yet, as illustrated by Volta's discovery, such positiveness and negativeness are not absolute, but relative. Iron is in this sense positive to copper, but is negative to tin; and a person who is positive to one individual may be negative to another individual.

In reference to mental and psychic phenomena of all kinds, it is customary to state that the positive controls the negative. In the sense with which positive and negative are thus used this signifies that a higher potential, or voltage, is able to overcome a lower potential, or voltage, and direct whatever action takes place.

From this it will be seen that a positive individual is one who habitually has so high a potential that he strongly resists control from any outside force, and a negative individual is one who habitually has so low a potential that he is easily controlled by outside forces. Also it will be plain from this that a negative thought is one which tends to lower the individual's potential, and a positive thought is one which tends to raise his potential. Fear, worry and anxiety arise from thoughts that rapidly lower the electrical potential of the body, and if intense and persistent enough, after a time can lower the potential differences in the body sufficiently that death results.

The vitality and life of the human body depend upon differences in electrical potential between different organs. The brain has the highest potential—otherwise it could not control the movements—and the liver has the lowest. But when through negative thinking over a long period, or through fatigue, shock, or loss of sleep, the electrical energies are exhausted to a point where there is no difference of potential between the brain and the liver, the body is dead.

In the nervous system there is a continual competition between electrical energies of different potentials, the highest potential always being successful in exercising control over the movements. And there is ever a similar competition between the potentials mobilized by the different thoughts which strive to get attention. The thought having the highest potential at the moment gets the attention.

These competitions between electrical energies of different potentials are mentioned to introduce the principle with which we are here concerned, that when on the inner plane we contact closely another individual, a condition, or a thought-form, there is a similar competition between astral potentials. Whether through hypersensitivity of the nervous system, or through extension of consciousness, we make a close contact with something on the inner plane, some part of us has tuned in on it. In the case of hypersensitivity we have used the electro-magnetic energies of the nervous system, or some portion of it, to tune after the manner of a receiving set. In the case of extension of consciousness we have used the electromagnetic energies to give the faculties of the unconscious mind an activity which places them in contact with that to be apprehended. In either instance we have tuned the astral energies associated with our nerves or associated with our intellects to the object, thought-form, personality, or whatnot about which we seek information.

If we acquire the information through hypersensitivity, this means that the astral energies associated with the nerve currents of our nervous system or some part of it have a lower potential, even though temporarily of the same vibratory frequency and vibratory modulation, than the astral energy being radiated by that which is contacted. For the reason the energy it radiates is thus of higher potential, we FEEL it distinctly.

On the other hand if the astral energies associated with the nerve currents and radiated from our nervous system have a higher potential than the vibrations tuned in on, the astral vibratory rates radiated by that which is contacted fail to move in on the electrical currents carried by the nervous system, and they are not felt by any portion of it. There is a competition between the vibrations radiated by that which is tuned in on and the vibrations of the individual who has thus tuned himself to these same vibratory rates.

An individual who has tuned in on something else either as a receiving set or to make an examination by the faculties of the unconscious mind, is as closely in contact with it on the inner plane through this similarity of vibratory rates as are two things on the external plane when they physically touch each other, and the energies as readily flow from the one to the other. The direction of flow of the astral energies when such contact is made is from high potential to low potential.

In Extension of Consciousness properly accomplished, the potential of the individual making the contact is at all times kept higher than the potential of that which is contacted. He does not, therefore, “take on” the condition which he contacts. Instead of being like the individual who, witnessing another in a serious accident sympathetically feels the other’s pain, and thus is partially incapacitated from effective action, he is like the skilled surgeon on the scene who has trained himself not to respond sympathetically to the patient’s pain, but to keep his intellect alert examining the condition and directing action in the most effective way.

In acquiring information through the positive method of Extension of Consciousness, the individual can recognize sound, colors, thoughts, even the feel of things. But in thus using the senses of the astral body he employs them from the standpoint of intellect, and does not permit energy from that which he contacts to flow to himself. Instead, through his own higher potential, the energy used in the examination is furnished by himself.

Secret Master

—The Secret Master degree is based upon the Fourteenth Major Arcanum of the tarot, which symbolizes regeneration and the application of the Master’s Word. The latter was recovered in the Seventh, or Royal Arch degree. Astrologically the Secret Master degree corresponds to the zodiacal sign Taurus where, after the resurrection on the cross of Aries, the sun fecundates the earth and brings forth the succulent verdure of spring. It is the positive rays of the sun mingled with the negative nature of Taurus, where the moon is exalted, that regenerates the whole world.

A Secret Master Lodge is said to represent the Sanctuary of Solomon’s Temple, the astral plane, which adjoins the Sanctum Sanctorum, or world of spirit. It is hung with black sprinkled with white tears to symbolize the realm of purification entered into after the resurrection from the wintry tomb of Aries. It is lighted by nine candelabra of nine lights each. The nine candelabra represent the nine decanates the sun passes

through in its regeneration from the vernal equinox to the summer solstice. The eighty-one lights symbolize the eighty-one days it takes the moon to thrice circle the zodiac, each time being born to new life, to represent the life of the soul and its transition on all three planes. The Master is dressed as King Solomon, and sits before a triangular table to signify his actions on these three planes of life. He is dressed in royal robes to symbolize his authority, and holds in his hand a scepter, symbol of his virile power. A large ribbon of blue indicates knowledge gained through experiences with matter, winter, or Saturn. It extends from the right shoulder to the left hip, indicating knowledge of sex energy; and at the hip is suspended a golden triangle, signifying that this energy may be used on all three planes to gain illumination.

The second officer is Adoniram, representing Pluto and the soul-mate of Hiram Abiff. He is clothed in black robe and cap to indicate mourning, and decorated with a white ribbon bordered with black, to indicate the dawning light of hope for immortality. The ribbon has a black rosette on it, representing the autumnal equinox and the triumph of material forces. Also suspended from it is an ivory key, a spiritual key, with the letter Z engraved upon it. Z is a double 7, a union of a positive 7, or physically perfect man, with a negative 7, or physically perfect woman. It is the union of two open trines, an open trine meaning energy expended. But in this union there is compensation, and the energies are directed along the highest lines possible to embodied man, regenerate forces being used for a definite purpose.

The other brethren wear black robes and caps, white aprons with black strings, and white gloves. They represent the union of positive and negative zodiacal signs, the apron strings indicating the equinox. The flap of the apron is blue, denoting knowledge of sex gained through experience. Upon the flap is a golden eye, symbol of spiritual wisdom.

Adoniram, asked if he is a Secret Master, replies, "I have passed from the square to the compass; I have seen the tomb of our respectful Master Hiram Abiff, and shed tears at the same." This symbolizes the moon as well as the sun passing through the rains of winter and crossing the vernal equinox. The winter union with the sun is signified by the square and that of summer by the compass. To the soul the tomb of the missing mate is the material world where both must sojourn, usually separated by its barriers, a cause for mourning. But there is also cause for hope as indicated by Hiram saying, "The dawn of day has driven away darkness, and the great light begins to shine in the lodge." This is the dawn of resurrection, or in physical life illumination through regeneration. The Master raps seven times to signify that the brethren are perfect physical men, and says, "If the great light is a token of the dawn of day, and we are all Secret Masters, it is time to begin our labors." The labor refers to the work of the sun in summer preparing the crops for harvest, and to the work on the astral plane of assisting others less progressed, the assistance being rendered by those who have entered into regeneration; and it refers to the even more strenuous labor performed in that region by those who have consciously passed through the tomb of death.

The candidate when admitted is led to the altar and kneels on his right knee, symbolizing his desire to render positive service. His head is bound, and fastened to his forehead by the bandage is a square, symbolizing the duties and obligations that still bind him to those yet struggling in the throes of matter. In his right hand is a great light, signifying his intention to labor spreading knowledge. On the altar is a crown of laurel and olive leaves, indicating his double victory, that of strife and that of love. The words are Shaddai, Adonai, and Juha, mystically signifying, Praise be to the Lord of the new Light. The password is Zizon, signifying a double triumph; that over the physical and that over the inner nature. The sign is given by placing the two forefingers of the right hand on the lips, indicating silence concerning the mysteries of both planes. The token is given by crossing the legs as the hands join in the Lion's grip. The crossed legs symbolize the solstitial cross, and the grip indicates the power of the sun in Leo by which he raises the moon from the winter signs to be united with him in the regenerate signs of summer. It represents the power of the purified soul to find and rescue its lost mate from the bondage of matter.

In closing, Adoniram is asked his duty, and replies that it is to guard the furniture of the Sanctorum, consisting of the altar of incense, the two tables of shew-bread and the golden candlesticks. The tables of shew-bread signify the result of experiences with good and evil which is assimilated by man's spiritual nature. The candlesticks are placed five on the north and five on the south of the holy place, and thus symbolize man and woman. The age of Adoniram is stated to be three times twenty-seven, meaning the twenty-seven days it takes the moon to complete its circle of life around the zodiac, three times around symbolizing the soul's progress through three planes. The special emblem of the Secret Master degree is a triangle in which are the Hebrew letters Jod-He-Vau-He surrounded by light. This is the Master's Word as revealed to Enoch, applicable alike on all three planes. It is the secret of uniting positive and negative forces to produce the spiral of life.

Perfect Master

—The Perfect Master degree is based upon the Twentieth Major Arcanum of the tarot, symbolizing the day of judgment and corresponding astrologically to the moon. The lodge is hung with green tapestry—the color of the moon—on eight columns, four on each side at equal distances, symbolizing perfect equilibrium, and justice received. There are sixteen lights placed at the cardinal points to represent the three signs and the presiding ruler of each zodiacal quarter. A pyramid stands in the north with open compass upon it, symbolizing the earth as an epitome of the universe under the direction of stellar law. The pyramid is the most stable form. The base is typical of the square of matter and the sides represent the four zodiacal triplicities meeting in a common point. Its most important significance is that of the earth being the womb of the universe from which is born, after its period of gestation, the Son of

God. The pyramid at the north symbolizes the earth under law, but as yet uninhabited by intelligent life. Another pyramid in the south has a blazing star upon it to represent gestation completed and the earth being delivered of its child, Man, who rules the world while in it, and when born into the realm above may become a god. A table stands before the canopy covered with black to typify the plane of death.

The assistants are decorated with a green ribbon about the neck from which is hung a compass extended to 60 degrees, symbolizing by the green ribbon, love received, and by the compass, harmonious union. The brethren wear black caps and robes, indicative of having passed the tomb of materialism, aprons of white leather with green flaps, signifying the reception of the reward for purity. Upon the apron is embroidered a square stone surrounded by three circles with the letter J in the center, symbolizing the earth surrounded by Mundane Houses, Zodiacal Signs, and Constellations, through all of which penetrates the divine fire, or J. The hour being four, the time when the sun at the equinox enters the first house of the horoscope, or house of life, it is time for the brethren to go to work, or enter upon the duties of the new life beyond matter.

The candidate has a green cord placed about his neck which is finally withdrawn by the Master to symbolize the moon passing out of the spring sign Taurus to a more elevated station, and man ready to be raised to a love higher than that of earth, and to an immortal work signified by the sprig of cassia placed in his left hand. The first sign is given by placing the palm of the left hand upon the right temple and stepping back with the right foot and again bringing it to its first position. It refers to the constructive use of virile energy in recovering the lost spiritual state. The second sign is made by raising the hands and eyes upward and letting the hands fall crossed in front, at the same time dropping the eyes downward, meaning the fall into temptation, from spirit into matter, or the sun across the autumnal equinox. The password is Acacia, symbolizing immortality. The token is that of a Mark Master, given on the five points of fellowship as explained in that degree. The Mysterious word is Je-Vau, meaning divine fire in union. The candidate approaches the East by four times four steps, from a pair of compasses extended from an angle of seven degrees to that of sixty degrees. The four times four refers to traversing the zodiacal circle, twelve signs ruled by the lords of the four seasons, corresponding to the sixteen Court Cards of the tarot. From seven degrees refers to perfect physical manhood, and sixty degrees refers to perfect union.

The tomb of Hiram was of black and white marble, good and evil experiences on earth. It was entered between the two pillars, winter and summer, supporting a stone surrounded by three circles, already explained. The heart of Hiram was enclosed in a golden urn, symbol of spiritual affection. It was pierced by a sword to indicate the afflictions befalling those who attempt to realize their spiritual ideals of affection on earth, and the resurrection of those ideals beyond matter; the sword representing transition over the cross of Aries. It is the action of a luminary in Leo, the heart; in Scorpio, the urn; and in Aries, the sword. On the tomb was engraved the letter J, the virile Hebrew Jod. To the side of the urn was fastened a triangular stone on which

were the letters J M B, surrounded by a wreath of cassia. The urn was placed upon the top of an obelisk erected on the tomb, symbolizing the solstitial colure, the foot resting on the tomb of winter, and the top, or summer solstice, being the highest point of heaven where the luminary passing through the tomb will finally be elevated. J is Jachin from which the soul falls. B is Boaz, the winter signs, or material realm where it falls, and M (see Course 6, *The Sacred Tarot*) is Aries where resurrection takes place. The triangular stone represents the experience of body, soul, and ego with material conditions, and the wreath of cassia surrounding the letters denoting the pilgrimage indicates that immortality has been attained. Hiram, the moon, returning to its home in Cancer, the summer solstice, is greeted by Solomon, the sun, who says with joy in his heart, "It is accomplished and complete." The special emblem of this degree is a coffin with a five-point star on the lid, and leaning over it a sprig of cassia. It signifies man enshrouded in the tomb of earth being promised immortal life in other realms.

Intimate Secretary

—The Intimate Secretary degree is based upon the Eighteenth Major Arcanum of the tarot, symbolizing false friends and deception. It corresponds astrologically to the sign Cancer. The Lodge is hung with black spangles with white tears to represent the realm of purification after death. There is a triangular table on which is a scroll and crossed swords, representing the record inscribed in the astral light of man's struggles on all three planes of endeavor. The Masters wear long blue robes and caps, symbol of wisdom gained through experience; their aprons are bordered with red, the white symbolizing purity, and the red symbolizing passion of purpose. On the apron is a scroll, and a golden triangle with the letters A P P in its corners. The letter A of the tarot symbolizes will, and P symbolizes hope. The scroll and lettered triangle signify spiritual effort on all three planes is sustained by will and two hopes; hope of future life, and hope of future love. All are recorded in the book of life. They also wear a red ribbon with a golden triangle suspended from it, meaning energy to be used on three planes. Their gloves are white, bordered with red, signifying purity and energy in execution. On the Bible is laid a triple triangle, symbolizing the law of perfect co-ordination between body, soul, and ego on all three planes.

The candidate in this degree takes the part of a spy who listens at the veil, is captured and condemned by Hiram King of Tyre, and is freed by the intercession of Solomon. Astrologically it symbolizes the moon separating from the sun and passing into the captivity of opposite zodiacal signs and finally being rescued from them by its return to the sun. It represents the soul of man after death, in the twilight realms of the astral, undergoing judgment for deeds done in the flesh and being found worthy after some purification to enter more spiritual realms because of the strength of its rapport with the ego.

The first sign is made by closing the right hand and drawing it from the left shoulder to the right hip. It refers to the fall of man through the destructive use of sex. It is also the fall of the sun into winter. The second sign is made by crossing the arms in front and holding them up so the thumbs touch opposite temples, speaking the mysterious word Je-Vau. It refers to constructive use of virile powers in union; astrologically the resurrection of the sun on the vernal cross, the mysterious word signifying its subsequent union with the moon. The grip is given by joining the right hands and turning them downward thrice, saying one of these words at each turn: Berith, Nedir, Shelmoth. These words symbolize the autumnal equinox, the winter solstice, or lowest point, and the vernal equinox, respectively; and each turn of the hands signifies the union of the sun and moon after the sun passes these points. It signifies man and woman united in indulgence, in proper generation, and in regeneration. The password is Joabert, and the response is Terbel. Joabert is the listener, or the soul seeking to be conscious of the inner voice. Terbel is the guard of the inner realms, the dweller on the threshold.

Provost and Judge

—The degree of Provost and Judge is based upon the Seventeenth Major Arcanum of the tarot, symbolizing the star of hope, and corresponding astrologically to the sign Gemini. The lodge is hung with red tapestries to represent the energies actuating life. There are five candelabra of five lights each, four being at the corners of the room and the other being in the center. The number five is the symbol of man. Each of the candelabra at the corners symbolizes man evolving through the zodiacal quarter corresponding to one of the four kingdoms, mineral, vegetable, animal, and man; and the candelabrum in the center represents man after his transit to the realm of purification where he recapitulates his past evolution and passes judgment upon his conduct. In the east is an illuminated transparent triangle in which is a circle around which are the letters J A I N, with a blazing star in the center on which are three J's. The triangle represents infinite Life, Light, and Love, the source of all being. The circle is the zodiac, and the letters symbolize the divine influx from above as transmitted through each zodiacal quadrant. J represents the divine fire in Leo, A represents the will in Scorpio, I represents intelligence in Aquarius, and N represents regenerate energy in Taurus. The blazing star in the center is man, the focus of universal forces, retaining a portion for his own use, reflecting the finer essence above, and refracting the grosser portions of the One Life Principle below, as symbolized by the three J's.

The brethren wear black robes and caps to symbolize their passage through the tomb of death; white aprons trimmed with red to symbolize purity sustained by virile energy; with a red and a white rosette on the apron to signify regeneration and translation to spiritual life; and a pocket in which to carry plans, the ideas formulated and vitalized in union. On the flap is a golden key, and another is suspended from a

red collar. The red collar is symbol of ardent affections, and the golden key signifies astrological knowledge. The hour is said to be break of day; 8, 2, and 7; meaning the entrance into a new life in higher realms has started through 8, Judgment; 2, with the aid of Esoteric Science; and 7, Victory over all temptations. They all combine in seventeen, the Star of Hope for future joy (see Course 6, *The Sacred Tarot*).

The candidate is led to the southwest corner of the lodge where the sun sinks in winter at the close of day, and is there instructed to kneel and pronounce the word Beroke, meaning to descend. The Master then says “Kumi,” meaning to rise, signifying a new epoch begun even as the sun rises at break of day. The first sign is to place the first two fingers of the right hand to the side of the nose with the thumb under the chin, symbolizing the will to use the energy of Mars, signified by the chin; to vitalize the etheric body, signified by the Jupiter finger; in the process of breathing, indicated by the nose. The physical body is also to be considered in this process as the finger of Saturn is used as well as that of Jupiter. The second sign is like the first except that one finger only is used, signifying the use of Mars energy to vitalize the etheric body. The token is given by clenching the three first fingers over the thumb and interlacing the little fingers. It means that will is to be subjected to science, as Mercury rules the little finger and also rules science. The password is Tito, the first to draw plans for the workmen. This signifies the formulative power of the intellect. The candidate having given the password and signs is presented with a key to a small ebony box which contains the plans for building the temple, and a key for opening an ebony box containing all the temple keys. The ebony box is man’s physical constitution, containing a correspondence to the universe. It is unlocked by practical astrology. The ivory box is man’s spiritual constitution and soul, containing the keys to all spiritual mysteries. It is unlocked by the spiritual astrology so carefully preserved in Masonry.

Intendant of the Building

—This degree is based upon the Nineteenth Major Arcanum of the tarot. It symbolizes reunion and corresponds to the zodiacal sign Leo. The lodge is lighted with three candelabra with nine lights each, the symbolism of which has already been explained. In addition there are five candles in the east to indicate man rising into another sphere of influence.

The brethren wear white aprons lined with red and bordered with green, symbolizing purity, energy, and receptive capacity. On the apron is a star with nine points, symbolizing wisdom gained under planetary influence; a sprig of cassia, representing immortality; and a balance, emblem of justice. On the corners of the triangular flap are the letters B A J, symbolizing occult science illumined by divine fire, directed by will. The collar is of red to indicate affectional energy, and from it is

suspended a golden trine with the letters J A B in the corners, and in the center three J's. The three J's represent the divine fire penetrating the three worlds. On the reverse of the triangle the three J's are in the corners and G is in the center, indicating the divine fire used in generation. As used on the first side they indicate that the divine fire aids the will to remove the veil of Isis.

In this degree, a chief of the five orders of architecture is selected to fill the vacant place of Hiram Abiff. The five orders of architecture are: Tuscan, Doric, Ionic, Corinthian, and Composite. The first four represent the zodiacal quarters and their correspondences. The composite, a combination of the others, symbolizes man. The true soul-mate being lost, a worthy substitute is selected to assist in the work. The obligation is taken while the candidate lies prostrate, and he is lifted under a sprig of cassia by the Lion's grip. The signs and passwords all refer to the separation of sun and moon, of man and woman, to the sorrowful descent into the winter signs, or matter; and to the ascent to spiritual realms, reunion, and consequent immortality. In the closing lecture the Senior Warden says: "I have made the five steps of exactness; I have penetrated the inmost part of the temple; and I have seen the great light, in the middle of which were three mysterious letters." The five steps of exactness refer to evolution through four kingdoms and the entering of the fifth, the kingdom of regenerate man. It also indicates the successive subjugation of the five physical senses leading to illumination and the use of the creative energy to explore the three planes, as signified by the three J's.

Master of Elect Nine

—This degree is based upon the Sixteenth Major Arcanum of the tarot, symbolizing catastrophe. It corresponds astrologically to the planet Mars. Solomon had appointed nine Masters to go to the spot where it had been learned one of the assassins of Hiram Abiff was concealed. Mars, one of the nine planets, represented by Joabert, steals ahead of the others and discovers the murderer asleep with a poinard at his feet. This is the equinox at the foot of Pisces. Mars takes the poinard and stabs him first in the head, Aries, and then in the heart, Leo. He then cuts off the villain's head and taking it in one hand and the bloody knife in the other returns to Solomon's home. The place of sunrise, Jubulum, is killed by the vernal cross, wielded by Mars. He is first stabbed in the head to indicate the sun rising in Aries, and later in the heart, in Leo, to which the sun returns. Cutting off the head signified that the rising sun has passed out of Aries. Its influence in the sign of the head has been cut off, and he passes to the rightful place of Solomon, in Leo. The sign is made by striking toward the companion's forehead as if stabbing, and the companion placing his hand to the spot as if feeling of a wound; then striking at the companion's heart crying Nekum, and the companion answering by placing his hand on his breast and saying Nekar. These words mean Vengeance, and Vengeance Is Taken. The jewel of the order is a gold-handled dagger with a silver blade. The handle and blade symbolize the summer and winter signs, and the guard symbolizes the equinox.

Masters Elect of Fifteen

—The degree Masters Elect of Fifteen is based upon the Fifteenth Major Arcanum of the tarot. It symbolizes the fate of the evil, and corresponds astrologically to the planet Saturn. The two other assassins of Hiram Abiff were not captured and punished with the first. Through one of his Intendants, Solomon learned that two persons answering their description had come to the country of Cheth and were working in the quarries. Cheth is the eighth Hebrew letter and presides over the Eighth Major Arcanum of the tarot, which symbolizes justice and corresponds to the sign Capricorn, the home of Saturn. Capricorn is the winter sign that symbolizes crystallization and has rule over quarries.

In front of each of the two officers that symbolize the sun and moon, one in the east and one in the west, is a candelabrum of five lights; one candelabrum to represent man and one candelabrum to represent woman. The brethren wear white aprons on which is pictured a square city, a form of birth-chart still used by Raphael in his annual ephemeris. It has three gates, and over each a human head impaled on a spire. These represent the three visible angles of the heavens, or assassins. Jubulum was captured in the preceding degree in a cave, that is, in Capricorn, stabbed with the vernal cross at the foot of Pisces, decapitated by passing into Taurus; and finally this representative of the Ascendant at sunrise returns to Leo carried by the strength of regenerate Mars. In the present degree, Jubela and Jubelo, Midheaven and Descendant, are captured in Capricorn and are carried from this region of crystallization into the warm months of summer, or Jerusalem. Their heads are cut off as they pass from Aries; and as they pass the summer solstice into Cancer, which rules the belly, their bodies are cut open. The sign of the degree is to place the point of a poinard under the chin and draw it downward to the waist, speaking the word Zerbul. It symbolizes the passage of the sun from Aries across the solstitial cross to the sign Libra.

Sublime Knights Elected

—This degree is based upon the Twenty-second Major Arcanum of the tarot, symbolizing the foolish man. It corresponds astrologically to the planet Pluto. Solomon rewarded twelve of the Masters for their efforts to apprehend the assassins of Hiram Abiff by conferring upon them this degree and giving them command over the Twelve Tribes of Israel. They represent the twelve signs of the zodiac. The zodiacal circle crossed by equinox and solstice is the symbol of the world. By removing the circle, or spiritual portion of the symbol, we have the cross of earth in its most material aspect. If the upper bar of the cross be removed the result is the Tau Cross, or English T, emblem of the Lower-Pluto influence, the primitive phallic symbol of creative energy directed to material ends. The lower bar, or vertical line,

indicates the sun in Capricorn at the winter solstice. It represents man spending his energies for material advantage, the worldly wise and spiritually foolish. By reversing the T so that the lower bar is missing we have a representation of the sun at the summer solstice as it enters Cancer, the emblem of the Upper-Pluto influence, signifying the virile energies directed to spiritual construction. And herein lies the paradox of the twenty-second card of the tarot, a card few students have understood; for the man that to the worldly may seem foolish may really have reversed the Tau, come under the Upper-Pluto influence, and being a true sage ignores the things that many spend their energies to obtain.

The candidate in this degree is required to swallow a piece of the heart of Hiram Abiff which is presented to him on a trowel by the Master. He is told that he may swallow it without injury if he is a faithful Mason but that it will not remain in the body of one perjured. This heart is the zodiacal sign Leo, symbol of affection, through the power of which Hiram is again united to Solomon. The trowel is an instrument used to bind together. Its form represents two souls occupying one form and overshadowed by a common ego. The candidate partaking of the heart on the trowel symbolically enacts the permanent reunion of soul-mates; the reward of the spiritually wise, whose efforts are denoted by the reversed T. Astrologically it is the reunion of the sun and moon in Leo, which is the sign that rules the house of love in a natural chart.

Grand Master Architect

—This degree is said to have been founded by King Solomon as a school of architects where deserving craftsmen might receive proper instruction. These Grand Master Architects are men who have mastered the various occult and lucidic sciences and have been found worthy to serve as Masters to struggling neophytes. The Chapter is decorated with white hangings, sprinkled with red flames, symbolizing purity combined with fiery enthusiasm. The five orders of architecture are present, symbolizing man who contains within himself the zodiacal quarters corresponding to the four kingdoms of elemental life. Man's rightful place is that of Master Architect directing the four elemental realms of life in their work of cosmic construction. The apron is stone colored, to indicate work to be done upon earth, and has a star on it to signify man as the chief of that work. The jewel is a gold medal with the five orders of architecture, a star, and a case of mathematical instruments, on each side. It symbolizes man measuring planetary angles and positions in the zodiac, and utilizing his knowledge of astrological cycles, forces and angles to direct the elementals in their work of assisting evolutionary progress.

The candidate makes a tour of the room, which represents the zodiac, and draws an exact plan of it to illustrate his ability to compute astrological positions and map the heavens. There is a star in the north with seven other stars around it to represent the Polar Star, the "Rock of Ages," about which swings the septenary of naked-eye planets. It is called the guiding star of the order; for it is symbolical of the immutability of divine law, and is the axis of all mundane reckoning. The Chapter is

said to be opened on the first instant, the first hour, the first day, the first year, when Solomon commenced the Temple. This is according to the prescribed rules of astrology; as a chart of the heavens for the instant commencing an enterprise indicates its future success or failure, even as a chart of the instant of physical birth reveals a child's physical destiny.

The sign is made by sliding the right hand into the palm of the left, clenching the fingers of the right hand and tracing a plan with the thumb in the other's left hand, looking at him as if taking dictation. It refers to man and woman united and taking advantage of astrological conditions to promote their interests. It indicates that from their knowledge of astrology they are able to formulate a plan of mutual effort. The token is given by interlacing the fingers of the right hand with those of the brother's left and placing the free hand on the hip. The united hands are at a level with the head. It indicates united transmutation from Scorpio to Aries, or the sun resurrected with the moon on the vernal equinox.

Knights of the Ninth Arch

—This degree revolves around a vision of Enoch in which he saw the letters of the Ineffable Name engraved upon a triangular plate of gold which was lowered into the bowels of the earth to the ninth arch. Later he and Methuselah built a temple underground of nine arches and deposited a facsimile of the plate on a pedestal of white in the ninth arch. He also built two pillars on a high mountain nearby; one of brass to withstand water, and the other of marble to withstand fire. On the marble pillar he traced hieroglyphics disclosing the whereabouts of the golden plate; and on the pillar of brass he engraved the principles of geometry, or Masonry. This was before the flood.

In clearing away the rubbish to rebuild the temple the vault is discovered and the plate recovered in the same manner as the vault and Ark of the Covenant were found in the Royal Arch degree. This ninth arch is the lowest grade of actual adeptship, where the mysterious laws are fully revealed to the worthy neophyte. Enoch was the perfect man, representing the natural adepts of the golden age. Methuselah was his son who lived to great age, symbolizing those who through subsequent ages have been found worthy custodians of ancient wisdom and who have proceeded with the work outlined by the Ancient Masons. The Ineffable Name in the lowest grade of adeptship is represented as mounted on a white marble pedestal to indicate that understanding while in the body depends upon purity. The pillar of marble on the high mountain is the physical means adopted by the Magi to preserve their knowledge for posterity such as monuments, sacred allegories, hieroglyphics, and the tarot. This marble pillar is said to have been destroyed by the flood, but a portion is extant as we find in the next degree. The pillar of brass was not destroyed; for it

represents the records left in the astral world where is preserved all the wisdom of ancient days. The floods of religious emotionalism and sensualism may destroy the material records of the past, assisted by physical floods due to climatic changes, but neither are effectual to efface the records left by Enoch, the early spiritual adepts, on the brazen astral column.

Degree of Perfection

—The degree of perfection is based upon the Twenty-first Major Arcanum of the tarot. This pictures the Crown of the Magi, symbolizing the accomplishment of the great work and corresponding astrologically to the sun. The lodge is represented as a subterranean vault hung with red curtains. It symbolizes the earth from which the adept is departing, the red indicating generated energy. A part of Enoch's marble pillar, found among the ruins, is placed in the west. The pillar of Beauty, or astral records, the Burning Bush, or divine fire, and the triangle of Enoch with the sacred Jod-He-Vau-He engraved upon it are in the east. When the members are not at work the lodge is lighted by the Burning Bush, and when they are at work they are lighted by twenty-four lights. Three are in the north to represent the monad's evolution through the mineral, vegetable, and animal kingdoms; five are in the south to indicate that man is a fruit of material evolution; seven are in the west to symbolize man arriving at physical perfection through the application of the subjective laws of union; and nine are in the east to represent man's wisdom before he is permitted to enter the ninth arch. These twenty-four lights correspond to the twenty-four hours in which the earth completes one rotation on its axis and symbolize all the experiences necessary to man upon the physical earth. Also before each of the officers is a triangular white table, symbolizing the spiritual plane to which the adept is translated.

For the same reason, that is, because it is meant to symbolize the voluntary completion of earthly experience, there can be only twenty-seven working members in a Grand Lodge of Perfection. These twenty-seven represent the twenty-seven days it takes the moon, symbol of the soul, to make a complete transit of zodiacal experience. The work of this degree is a recapitulation of preceding degrees, even as the adept ready to leave the physical plane goes carefully over his past, tabulating experiences for future reference. Here for the first time the candidate receives the true pronunciation of the Word as revealed to Enoch; for Enoch, representing the children of the golden age, walked with God and was not. That is, he was translated consciously without the process of death as we know it. In the golden age when the cycle of life had been run tradition records that there was a gradual voluntary dissolution by which the soul liberated itself from the body and passed consciously to

a higher realm. In those days there were neither phantoms nor shades in our earth's electromagnetic sphere. The adept who succeeds in accomplishing the great work while in the flesh understands the law governing translation and is able to pass to his future work in the spiritual world even as did Enoch, without being hampered by death or being detained in the astral worlds for experience and purification.

Chapter 13

Serial No. 18
Original Copyright 1939
Elbert Benjamine

Copyright
Church of Light
August 2002

Historical Degrees

Chapter 13

Historical Degrees

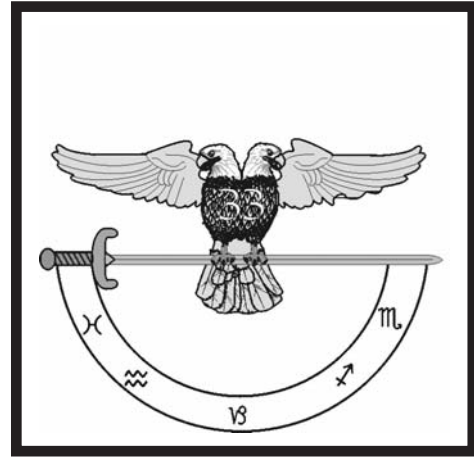

IN CONNECTION with the historical degrees, mention should be made of the origin of both Scottish Rite Masonry and York Rite Masonry. I do not wish it implied that I agree with Albert Churchward in archaeological matters. But as he seems to be correct in his opinion of the origin of these two orders of Masonry, and is himself a high degree Mason, I take the liberty of quoting from his *Arcana of Freemasonry*.

Chevalier Ramsay stated that modern Masonry had its beginning in the Society of Architects founded in Scotland under the protection of King Robert Bruce, and the title of 'Ancient and Accepted Masons of the Scottish Rite' may have possibly been formed in Scotland there and then; but if that is so, we must trace the origin of this to the Order of Knights Templar, who fled to Scotland, and through them to the ancient Mysteries practiced in the East. From whence did these Templars receive them? It is well known that one of the charges made against Jacques de Molay and his associates was that 'they used sacred rites in their initiation.' Their four oaths are well known, but who knew their rites of initiation? The aim of the Society of Architects was to perpetuate the ancient order of the Temple, and they continued to use their initiations of members, symbols, signs, and some parts of the initiatory rites, which had been obtained in the East, but they only knew three degrees out of the seven lesser and ten greater. The next question is: From whence did the Templars receive those symbols, and their esoteric meaning, in which we plainly trace the doctrines of the old Egyptians? No doubt from the Christians, who, like the Emperor Julian, the Bishop Sinnesius, Clement of Alexandria, and many other philosophers, had been initiated into some of the mysteries by the Priests of Egypt before being converted to Christianity. In this way we can trace how part of the religious mysteries of Egypt, signs and symbols, etc., came to Scotland.

Speaking further concerning the Egyptians he says: "There were also many who crossed over to Europe from Egypt, and spread from Italy into France, who possessed and clung to the true doctrines, endured torture, and some even death, by the early Roman Priests, who tried to usurp the temporal power by destroying the spiritual ideas; and yet these brothers would rather suffer death than give up their secrets and beliefs. Many of these migrations can be traced through Europe and finally to Scotland."

Relative to York Rite Masonry, Churchward continues: “As regards the origin from the Druids, I have given in ‘Signs and Symbols of Primordial Man’ the proofs of the origin of the Druids, and where they came from. They were High Priests of Egypt, who left the mother country at the early part of the Solar Cult, and were therefore well versed both in the seven Lesser Mysteries and the ten Greater Mysteries; and these practiced their religious rites in England until the edict of Canute prohibited their open worship. Canute reigned from 1015 to 1036. To evade persecution they resorted to private meetings and secret celebrations. I do not entertain any doubt that they formed the first so-called ‘Lodges’ in England, as a cloak to screen their religious rites and ceremonies, and to keep them as pure as they had received them originally from their parent sources in Egypt. Many of these old Druid Priests joined the Christian Church, and were the so-called Culdees, but although they had joined the Christian Church, they kept themselves very much aloof for a long period, up to the twelfth century.

“These were the last remnants of the old Druid Priests—descendants of their Egyptian brethren—who practiced the pure Eschatology of their forefathers. Gradually they all died out as a separate and distinct class, and those who remained were merged into Christianity; but up to the twelfth century at least they brought all their doctrines with them, and practiced them in secret places, in so-called Lodges.

“Here we have one source of the origin of Freemasonry, both in the Lesser Mysteries (seven degrees) and in the Greater Mysteries—so-called Higher Degrees in this country.

“The Druids, in Gaul, were mostly put to the sword, others fled to this country for protection, when the Roman Christian doctrines were brought to them. In America it was the same. As soon as the Spanish Priests arrived there they persecuted all the Solar and Stellar people, murdered their priests, overthrew their Temples, and scattered them with fire and sword. Yet there is sufficient evidence left in their Signs, Symbols, and writings on the wall which may prove my contention that all these had the same Eschatology, signs, symbols, and rites as the Old Egyptians, from whence they came, and that all these are analogous to our own with really very little innovation, considering the many thousands of years that these have been handed down from country to country, and generation to generation, as we must acknowledge to be the case if we study the history of the human past.”

Three Methods of Acquiring Information From the Inner Plane

—Ancient Masonry presents not merely a philosophy of life based upon provable information, but also instructions relative to the general principles, applying which an individual can make the most rapid spiritual progress and develop his latent occult powers. More specific instructions in such training should be reserved for those who prove, by tests, that they have sufficient comprehension of occult matters that they will not be likely to misinterpret or misapply the information presented to them. These will find such detailed information presented in the systematic graduate course embraced in the “Not Sold” Brotherhood of Light Award Manuscripts.

However, as reference repeatedly has been made in these Ancient Masonry lessons to Extra-Sensory Perception, it should be clearly understood by anyone contemplating psychic work of any kind that there are three distinct methods of acquiring information from the inner plane, and just what takes place in each. The three methods are: Mediumship, Feeling ESP, and Intellectual ESP.

Mediumship

—That which distinguishes mediumship is the partial or complete control of the medium by some intelligence other than his own. Mankind owes a deep debt of gratitude to spiritualistic mediums. I shall be the last to criticize them. Many in the ranks of spiritualism have sacrificed tremendously that the race might advance; many mediums have been martyrs to the cause of demonstrating human survival beyond the grave. But in spite of this debt of gratitude, the very real dangers to those who develop such mediumship cause us to discourage our students from attempting to become mediums. The reason is set forth in detail in Brotherhood of Light Course 1, *Laws of Occultism*, published in 1919. The subsequent years, in which through the many psychics contacted in connection with Church of Light work there has been unusual opportunity to observe the effects of the various types of development and psychic practice among a great many individuals, has but served more and more to confirm the attitude then taken. To sum this attitude up, The Church of Light does not advocate that anyone shall become a medium.

Two Methods of Independent Psychic Work

—The Church of Light has found, however, as the result of its own research and observation, that psychic work in which there is no control by some other entity is accomplished in two quite distinct ways. These two methods, even though exercised and directed by the individual using them and not by some outside intelligence, are as different as day and night, positive and negative. The one depends upon hypersensitivity of the nervous system, and is called FEELING ESP. The other is purely an intellectual activity, and is called INTELLECTUAL ESP.

Feeling ESP

—At the appropriate place in the “Not Sold” manuscripts I go into the details of these two methods. Here I hope only to bring out their contrasts so clearly that the neophyte will never mistake the one method for the other. The majority of independent psychics employ Feeling ESP. They make use of the hypersensitivity system of mental activity in which the nervous system or some part of it is tuned in on the astral counterpart of the object or person about which information is wanted. The nervous system, or some part of it, becomes a receiving set through which the electrical energies and astral energies closely associated with it pick up, radio fashion, the astral vibrations radiated by whatever is tuned in on. The individual then feels the condition of that which is thus contacted. The energy causing this feeling is furnished by that which is contacted. The individual who is hypersensitive is able to feel so discriminatingly what is received that his unconscious mind can give detailed information about that which is tuned in on, and perhaps about its past and probable future.

A quarter of a century of experience with students all over the world who have developed this Feeling ESP has convinced The Church of Light feels that this method of psychic development should be approached with caution.

Intellectual ESP

—The unconscious mind, itself occupying the astral plane, has faculties which, given proper impetus and sufficient energy with which to work, on this inner plane can examine objects and thoughts and communicate with other intelligences. In Intellectual ESP hypersensitivity plays no part. Instead of becoming a receiving set, the electrical energies of the nervous system radiate high-frequency vibrations which afford the faculties of the unconscious mind the energies with which to perform their work. Feeling or hypersensitivity plays no more part in such examination by the unconscious mind on the inner plane than it does in a similar examination on the physical plane, nor are the emotions more active.

The examination is conducted by the unconscious mind reinforced by the astral energies provided by the high-frequency electromagnetic radiations of the nervous system. This examination, which may include past and future as well as all aspects of the present about which information is sought, is an intellectual appraisal the results of which are not communicated to other sections of the nervous system, but, much as something is remembered even though seen but a moment before, is communicated directly to the brain as an Intellectual awareness.

The Brotherhood of Light ESP Research Department has found that the psychics using Feeling ESP can acquire information readily from persons or other living things which radiate strongly, or about people from objects which they have touched, or from their thoughts; but do poorly with the ESP cards. Those among our students who get the highest scores with the ESP cards, and in tests with inanimate objects in which the human vibrations are absent, are those who, perhaps without knowing how they do it, nevertheless, employ Intellectual ESP.

So far in our extensive investigation, and with numerous students who have made tests with it, we have found no danger in cultivating Intellectual ESP.

Age of a Prince of Jerusalem

—Zerubbabel, while rebuilding the temple, was interrupted by the Samaritans who finally forced him to abandon work. He thereupon sent an embassy to Darius, representing the ruler of the winter sign entered into by the sun, who issued orders prohibiting all persons from interfering with the work of construction on pain of death on the cross of Aries. The lodge consists of two apartments connected by a hall. The apartment in the west represents the western signs of the zodiac and is hung with

yellow, the color sacred to Venus, which rules Libra, the sign of the western equinox where Zerubbabel now holds court. The eastern apartment where the cabinet of Darius is situated represents the eastern equinox of Aries; for Aries is the leader of the eastern zodiacal signs. The hall connecting the two zodiacal divisions is the solstitial colure.

The jewel of the order exemplifies the ritual accurately. It is a golden medal, or zodiacal circle. On one side is a hand holding a balance, symbolizing the human soul involving through Libra into the winter of matter, man entering into generate union, and the five planets descending into the winter signs through the door of the autumnal equinox. On the other side is a two-edged sword with five stars around its blade and over it the letters D. Z. The sword symbolizes the vernal equinox. The five stars represent man evolving into spiritual summer, man entering into regenerate union, and the five planets emerging from the winter signs, victoriously crossing the vernal equinox of spring. D. Z. are the initials of Darius and Zerubbabel, and also have an esoteric significance. Thus the Hebrew letter Z means sword and symbolizes victory. The soul enters matter through Libra, the door to realization, and emerges victorious by means of the sword of intelligence, Aries. Man enters generation by D, corresponding to the sex sign Scorpio, to realize sensation, but frees himself from bondage by means of regeneration.

The candidate with four knights—the five symbolizing man—journey from the court of Zerubbabel in Libra to the cabinet of Darius in Aries, and back to Libra, completely circling the zodiac. Each time they pass through the hall they are attacked by armed ruffians, symbolizing the struggle of the solar forces to become repolarized at the solstitial points of Capricorn and Cancer. The password is Tebeth, which is a Hebrew symbol for Capricorn, the point where the soul descends no lower and becomes incarnated in the mineral. The sacred word is Adar, Hebrew symbol of Pisces, the zodiacal sign in which thanks should be given for the completion of the zodiacal temple. The age of a Prince of Jerusalem is said to be five times fifteen. Fifteen signifies the passage of the twelve signs over the three visible angles, or one diurnal rotation of the earth, which according to the Hermetic System of Astrology measures out to man the events of one year of life. The fourth gate to the temple, referring to the Nadir which is invisible, mythology informs us was always closed. This explains why there were but three assassins. Five times fifteen also points mystically to the sacred cycle of the soul, called Naronia, which governs the expansion and contraction of the psychic forces and thought-cell energies within the constitution of man. The age of a Prince of Jerusalem signifies that the candidate has observed the Naronic cycles of soul development, explained in the 13th Award Manuscript. from month to month and from year to year.

Knights of East and West

—This degree is based upon a vision of St. John as given in the Apocalypse. The book of seven seals is the septenary law of nature. The One Universal Principle is refracted from seven sub-centers about the Spiritual Sun, partaking of the quality of each medium through which it passes. As a definite portion of the divine essence under the dominion of one of the planetary angels it bears the seal and is governed by the laws relating to one planet. The twenty-four elders are the twenty-four hours, and symbolize those who have endured through great time. The seven lamps are the seven planetary angels. The four beasts, one with a head like a lion, one with a head like a calf, one with a head like a man, and one with a head like an eagle, are the lords of the zodiacal quadrants; and their many eyes looking within are the stars of these quadrants which look within from the circumference of the constellations. Each beast has six wings and rests not day and night, meaning that due to the earth's diurnal rotation each quadrant flies by in six hours.

The candidate bares his arms and the wardens lance them so as to procure blood on a napkin to represent those who have come out of great tribulation and washed their robes and made them white in the blood of the lamb. The blood of the lamb means the spiritual life of regeneration by which the body is completely purified. The Master then opens the seals of the great book. Opening the first he takes there from a quiver of arrows and a crown. It represents Sagittarius and the planetary seal of Jupiter. Opening the second seal he takes out a sword, signifying the sign Aries and the seal of Mars. Opening the third seal he takes out a balance, representing Libra and the seal of Venus. Opening the fourth seal he removes a skull, indicating the pale horse death, the sign Capricorn and the seal of Saturn. Opening the fifth seal he finds a cloth stained with blood, symbolizing the sign Virgo and the seal of Mercury. As the sixth seal is opened the sun is darkened and the moon is stained with blood to indicate the sign Cancer and the seal of the Moon. Opening the seventh seal he removes incense, symbolizing Leo, the house of love, and also seven trumpets to show planetary dominion, and thus the seal of the Sun. The four winds signify the aspirations of those born in each zodiacal quadrant, and the precessional cycle which governs the spiritual and mental influx received by men during different stages of evolution.

The draft on the floor, a heptagon in a circle, over the angles of which are placed letters, represents the seven planetary angels surrounded by the zodiac. The six elevated canopies in the north and the six in the south are the summer and winter zodiacal signs, eleven of which are occupied by venerable Ancients who are the ascended souls of those belonging to the state of life and degree of emanation of each sign. The vacant seat is that from which Judas, the sign Scorpio, fell, later to be occupied by the elect, or Eagle. The man in the center of the draft is the macrocosmic man of the kabala.

Knight of Rose Cross

—This degree is also called Sovereign Prince of Rose Croix de Harodin and Knight of the Eagle and Pelican. There was once a tradition that the pelican feeds its young with its own blood, hence it has been used as a symbol of sacrifice. The rose is the ancient emblem of spring. Upon the cross it signifies the resurrection of the sun after death on the autumnal cross, also signifies man regenerated. The eagle is sex, or Scorpio, spiritualized. The special emblem of this degree is a pelican feeding her seven young, on one side of her a rose and on the other side a sprig of cassia; above her a radiant cross upon which climbs a rose. The pelican feeding her young symbolizes the sacrifice of material aims to spiritual ideals. Each planet has its evil side as well as a spiritual quality. The regeneration of all through sacrifice is indicated by the seven young pelicans partaking of blood, or spiritual sustenance, from their mother, who represents the universal mother Isis. The rose on the right signifies the rejuvenating effect of partaking of spiritual nourishment; the cassia on the left signifies immortality gained; and the radiant rosy cross above is the symbol of the conscious translation to spiritual realms of those who have sacrificed all their lower nature to the higher.

The lodge has three apartments. The first represents Calvary, or the autumn of life. It is lighted with thirty-three candles to indicate full experience under the twelve zodiacal signs and ten planets through the ten kingdoms of universal life, completing the cycle of necessity. The thirty-third candle signifies transition to a new cycle. Eleven lights are placed on each of three pillars six feet high. The number eleven (see Course 6, *The Sacred Tarot*) signifies force. It is the force of the sanctified man on all three planes, corresponding to the sun at the three visible angles, culminating six hours after rising, setting six hours after culminating, and rising six hours after passing the nadir, or material point, or plane below man. The second apartment represents Christ ascending into heaven, and the third apartment represents hell; symbolizing the relative conditions after death of the sanctified and the evil man.

The purpose of this assembly is said to be the recovery of the Lost Word. The means of recovery is indicated by the candidate presenting to each of the brethren one pair of men's gloves and one pair of women's gloves and two sticks of sealing wax, symbolizing united work. The result is referred to as, "The moment when the word was recovered; when the cubic stone was changed into a mysterious rose, when the flaming star appeared in all its splendor; when our altars resumed their ordinary form; when the true light dispelled darkness, and the new law became visible in all our works." The cubic stone is physical gratification, which when the Lost Word is found is transmuted into the rose of spiritual union, revealing the pole star, Truth; illuminating all mysteries, causing oblation to be made to the soul rather than to the senses, and work to be performed harmonious with the new laws thus discovered.

Grand Pontiff

—The New Jerusalem as seen by St. John is the foundation of this degree. It is square with twelve gates; and in the midst a tree bearing twelve kinds of fruit. Above the earth, it descends upon the old Jerusalem crushing a three-headed hydra chained on the ruins. The New Jerusalem is the celestial heavens bounded by the twelve zodiacal constellations, or gates. The tree is that of immortal life, and the twelve fruits it yields are the immortal souls of those born under each sign through which the sun passes by precession of the equinoxes. The moon's nodes are known astrologically as the dragon's head and tail. The dragon is the serpentine cycle of the moon; corresponding to the cycle of the soul. The dragon has three heads, which symbolizes that the cycle of necessity embraces three planes. The New Jerusalem, or angelic realm, is attained only after the soul has successfully completed this cycle, leaving the attractions of each realm conquered and chained to the plane of their origin. The mountain at one side of the city indicates that the path to celestial realms lies along the summit of the highest type of physical development and union.

Grand Master of All Symbolic Lodges

—The brethren in this degree wear blue and yellow scarfs crossed in front and rear, indicating the union of wisdom with love. The Wardens wear a jewel suspended from the yellow scarf of love. It is a triangular golden plate with the word Secret on one side and the letter R on the other. The Hebrew R symbolizes ascension. The jewel signifies the secret rejuvenation of the soul through the power of love. The same thought is more specifically expressed in the closing lecture: "My Brother, enter into the cave of Silol, work with Grand Rofdam, measure your steps to the sun, and then the great black eagle will cover you with its wings, to the end of what you desire, by the help of the most sublime Princes Grand Commanders." The cave of Silol is union, Rofdam is vibration, the sun refers to the virile power generated, and the eagle is the spiritual plane contacted, by the help of whose denizens will be attained that which is desired.

Chief of the Tabernacle

—This degree is based upon the establishment of the Jewish Order of Priesthood, and their work of offering sacrifices. There are two side altars, one on the right in front of a representation of the sun, for sacrifices; and one on the left in front of a transparency of the moon, for incense. Man makes oblation of his animal nature to his ego, and exerts his executive power to direct his energies to noble purpose. To his soul he

offers the sweet incense of aspiration and loving thought. Both execution and reception are necessary to propitiate his divine nature. The brethren, representing Levites, wear white robes, symbols of purity. Over each robe is a scarlet sash trimmed with gold fringe, and at the bottom on the right hip is a black rosette from which hangs a golden censer. The black rosette symbolizes death on the physical plane, and the scarlet sash symbolizes virile energies used to build up the spiritual body, as signified by the censer. On the apron is pictured a golden chandelier with seven branches, and on the flap is a violet colored myrtle. The chandelier symbolizes the seven active principles of nature which are consciously utilized by the Magus. Violet is the color sacred to Mercury. Myrtle is evergreen, and emits a sweet-smelling odor. The violet myrtle symbolizes the intelligent use of the creative principle which, typified by the flap, is directed to the construction of the spiritual body, ruled by Mercury, and to the attainment of immortality as indicated by the evergreen.

Prince of the Tabernacle

—The main apartment in this degree is made perfectly circular to represent the zodiac. In the middle is a chandelier with seven branches, each branch having seven lights. There is also a round table on which is a cluster of inflamed hearts and some incense. The apartment symbolizes the zodiac as the cycle of life, and the seven branches of the chandelier represent the septenary of planetary influences affecting the physical under which the neophyte struggles. The other planets of the chain affect man more through his mental and astral nature, thus operating indirectly to produce physical conditions and events. The forty-nine lights symbolize seven branches of astrology, seven branches of alchemy, seven branches of magic, man's septenary constitution, seven physical senses, seven psychic senses, and seven states of consciousness; all of which must be mastered before reaching adeptship. The inflamed hearts symbolize the burning desire of the aspirant to learn the great truths concerning life and immortality, and his devotion to the Cosmic Work which has been given him to perform. The incense symbolizes the thoughts and aspirations ascending to higher worlds. The candidate approaches the altar by six equal steps and one long one. The long seventh step symbolizes that in evolution when the six states below man from mineral up are passed, and the seventh state, the state of manhood, is reached, there is offered the possibility of encompassing much in one life and gaining heaven, as it were, in a single bound.

Knight of Brazen Serpent

—This degree is founded upon the history of the brazen serpent set up by Moses that those bitten by fiery serpents might look thereon and live. Fiery serpents symbolize impure desires. The brazen serpent entwined on a T, or on a phallic Tau, symbolizes wisdom of good and evil gained through experience with generation. Moses healed his people of their licentiousness by teaching them the truths concerning generation. And it is of equal importance today that proper generation should be understood. No one can truly be regenerate until he has mastered the mysteries of generation. Those who isolate themselves from the other sex in the hope of attaining regeneration without passing through the intermediate grade of generation only deceive themselves, and become bitten by the fiery serpents that infest the astral regions and prey upon the imaginations of celibates.

The lodge is opened at one past meridian, the time when the sun is transiting the house in the horoscope ruling instruction and philosophy. The nature of the instruction is disclosed by the lodge being closed at four past meridian, the sun just having completed its daily journey through the house of death, ruled by Scorpio, the sign of sex. The serpent is of brass, a union of positive and negative metals; and on the flap of the apron is the Hebrew feminine letter He, indicating the importance of both man and woman to produce the serpentine spiral called life.

Prince of Mercy

—The Bible speaks of three sacred covenants: one with Abraham by circumcision, one with the Israelites in the wilderness through the intercession of Moses, and one with mankind through the resurrection of Christ. These are the acts of mercy upon which the degree is founded. Circumcision is a rite symbolizing the passage of the sun completely around the zodiac, and is performed to commemorate his virile strength in triumphing over the forces of evil. Abraham means the father of a multitude, and the first covenant signifies the law of physical union as applied merely to multiplication of the species. Israel means one who wrestles with the Lord, and the second covenant indicates the struggle to subjugate the law of multiplication to the law of generation as taught by Moses; for generation is not confined to the production of physical offspring. The third covenant made through the resurrection of the mystical Christos after crucifixion on the material cross, refers to the laws of regeneration.

The jewel is a golden equilateral triangle, upon which is a heart with the Hebrew He in the center. It symbolizes the receptive quality engendered by the affections resulting in illumination. A special emblem of the Order is an arrow, the feather on one side green, on the other side red, the shaft white, and the point gold. It symbolizes the soul penetrating all mysteries by means of its spiritual illumination supported by purity and guided by the dual attributes of execution and reception.

Sovereign Commander of the Temple

—This is a Chivalric Degree. The Wardens wear the order of the degree about their necks. It consists of a white ribbon edged with red, symbolizing purity and energy; and having embroidered on it four Teutonic crosses, each indicating one cycle of the sun past the solstices, and all symbolizing complete realization; the passage through the three planes of the cycle of necessity, after the cycle of involution. From the ribbon hangs a golden triangle upon which is engraved the Tetragrammaton, or sacred name of Deity, meaning that the wearer has complied with the requisites of the divine law on the three evolutionary planes. On the flap of the apron worn by the brethren is a cross encircled by a laurel wreath, signifying victory over death; and on the apron is a key, indicating that the region where the apron is worn is the key to higher life and attainment.

Knights of the Sun

—This degree is said to be the key of historical and philosophical Masonry. It is really the key to the history of the world and the philosophy of its inhabitants. Father Adam is stationed in the east to symbolize primitive man, and Brother Truth in the west to represent intellectual man. They signify the alpha and omega of the human race. The lodge is lighted by a sun in the south. There are seven officers called Zaphriel, Zebriel, Camiel, Uriel, Michael, Zaphael, and Gabriel. These are ancient names for the seven planetary angels, who after God actuate the universe. The deific radiance of Life, Light, and Love from the spiritual sun is refracted from these seven sub-centers, and constitutes the source of all life, love, energy, and intelligence manifest on earth. This one universal principle received from the sun enables man to grasp truth, and this truth embraces the law of cycles. The sun's cycles are the key to history and philosophy; for by calculating his precession at the vernal equinox at the rate of 2,156 years through each sign, the quality of mental and spiritual force received by humanity at any date can be determined. A definite section of this precessional influence by sign is under the rulership of each of the planetary forces named above¹, and this directs the channels into which the mental and spiritual forces are turned for its term of power; whether for military, artistic, literary, or other purpose. And as the earth's climatic condition is determined by solar periods it will

be seen that the physical environment as well as the intellectual and moral status of the earth's inhabitants at any time past or future can be calculated within certain limits by a true Knight of the sun. The jewel of the degree is a golden sun with a globe engraved upon it, signifying that the earth owes its existence to the sun and depends upon him for all. The sign is made by placing the hand upon the heart, the thumb forming a square. The answer is to raise the hand with the index finger pointing to heaven. It means that as the heart is the source of will and energy to the body, so is the sun the source of all power in the solar system.

Knight of Kadosh

—This is a higher aspect of the principle exemplified in Knights Templar work, and is also called Knight of the White and Black Eagle. The eagle is the symbol of sex spiritualized, the power that carries the soul to higher spheres. The white eagle is regenerate and spiritualized man, the black eagle represents woman similarly refined and elevated. Five apartments are necessary, the first four typifying the zodiacal quadrants, symbolizing the completion of the cycle of earthly experience. The fifth represents the spiritual realm to which the adept has been translated. It is hung with red to indicate action and energy. In the east is a throne over which is a crowned double-headed eagle with wings outspread, holding in its talons a two-edged sword. This is the reward awaiting the spiritualized man and woman, the white and black eagles. The two-headed eagle represents the permanent reunion of soul-mates, both intelligences occupying one body. The crown symbolizes the natural right to rule of those who have attained this exalted state. The jewel of the order is suspended from the neck of the eagle to indicate the victory won by love. On its breast is an equilateral triangle bearing the letters of the Tetragrammaton, meaning that the sovereignty was gained through obedience to divine laws on all three planes.

The candidate during initiation must climb a ladder having Two supports and Seven steps. The supports of all initiation are the two pillars, Wisdom and Love. The steps are the seven states from man to angel, the two-headed eagle symbolizing angelhood attained. The crown of human life is the attainment of angelhood through the reunion of the two portions of the ego, the reunion of soul-mates. Human no longer, the angel then occupies a throne at the right hand of Deity.

Sublime Prince of the Royal Secret

—The lecture of this degree explains, “That the mysteries of the Craft are the mysteries of religion.” The special emblem of the degree figures a human being having two heads, one a man's and one a woman's. It stands on the back of a dragon, the dragon crouched on a winged globe. On the globe is traced a trine, a four-sided square and a cross dividing the globe into quadrants. The human being holds in his right hand a compass, and in his left a square. In a semi-circle over him are the

planets, each sending a ray to a cuirass on the front of which is the word Rebis. This figure reveals man's past, and his future destiny. The globe is the earth, and the dragon represents the cycle of necessity that the soul must travel. The globe is winged to indicate its motion. The cross marking the quadrants represents the crossing of the solstice and the equinox. At the lower solstice is the letter Z, indicating the victory over matter. At the upper solstice is the letter I, representing the divine fire that exalts the soul above matter. The trine and square on the earth, and the numbers 3 and 4 accompanying each, symbolize the harmonies and discords through which the soul evolved its septenary constitution and became a microcosm. The feminine hand holding the square indicates the laws of physical union that were obeyed, and the compass in the masculine hand that spiritual laws also have been complied with. The rays of the seven planets converging on the breast-plate bearing the word Rebis means that they have an influence and perfect correspondence within this being. This figure stands on the dragon, having passed triumphantly through the cycle of necessity, and has a man's head and a woman's head to indicate the two halves of the divine soul permanently united. The whole is enclosed in an oval like an egg to convey the idea that every immortal soul when united to its mate is the germ of a future universe. The lodge is always on the top floor of a building, representing the realm of spirit.

Knight of the Sword

—The Knight of the sword is intimately connected with the Prince of Jerusalem, and is founded upon the first journey of Zerubbabel to Persia, during which he obtained from Cyrus, King of Persia, permission to rebuild the temple and the freedom of Jewish prisoners who had been held captive seventy years. Ten is the number expressing cyclic duration. The seventy years refer to the seven cycles through the seven states of life from mineral up to and including man during which the soul is imprisoned in matter or the astral realm immediately associated with it. Cyrus typifies the material captor, Saturn, the King of the winter zodiacal signs. He is said to have had a dream as follows: "I imagined I saw a ferocious lion about to throw himself upon me and devour me; his appearance terrified me, and I hastily looked for shelter from his fury; but at that moment I saw my two predecessors, habited as slaves, beneath a glory, which Masons designate by the name of the Grand Architect of the Universe. I was made to understand two words which I saw issuing from a blazing star. They signified, Liberate the Captives, and I understood that if I did not do this my crown would pass from me to strangers."

The lion symbolizes the creative energy which misused destroys. It thus enslaves the soul to the senses, making it a captive of its appetites while on earth, and after death still bound to earth by the magnetic ties of its desires. The creative energy may be used also to free the soul from the senses, even as Leo draws the sun from the domain of Saturn. The blazing star is enlightened man, and the two words that liberate him from bondage to the flesh are Wisdom and Love. The glory spoken of is represented

in the lodge by a triangle in which is the ineffable name of Deity. It rests upon a luminous cloud from which an eagle soars, carrying in its beak a banner on which are the words, "Liberate the Captives." It is the eagle of spiritual love freeing the soul and carrying it into brighter spheres than the sub-lunary realms of suffering where it so long has sojourned.

Sovereign Grand Inspector General

—The lodge of this degree is painted with skeletons and skulls and cross-bones. This symbolizes association with the dead. The room is lighted with eleven candles, the number symbolizing psychic force, and at the north of the pedestal on which rests the Bible is a skeleton holding in its left hand the banner of the Order, and in its right hand a poinard as in the attitude of striking. This signifies that while members of the Supreme Council on the external plane are the physical instruments through which are governed the lodges of any country, the real Masters have passed the borders of physical life, yet are still potent to enlighten and protect those who have proved worthy neophytes and to strike down any who attempt to desecrate and profane the sacred mysteries. The jewel of this degree is the thirty-third degree emblem.

This emblem is a two-headed golden eagle, wings outspread, holding a sword in its talons. From the two ends of the sword hangs a belt forming an under arc. Below the outspread wings are thirty-two stars. Above and between the eagle's heads is a golden crown surmounted by a Maltese cross. The upper bar of the cross touches an inverted radiant trine having in its center the number thirty-three. The two-headed eagle symbolizes two intelligences occupying one spiritual body, soul mates permanently reunited in one form on the spiritual plane. An eagle is the symbol of sex in its spiritual aspect; the two-headed eagle thus representing the fusion of two spiritually evolved souls who have obeyed the inner promptings of their sexual natures. In this final Masonic revelation is disclosed the reason that prompted the ancients to commence the symbolic cyclic pilgrimage of the soul in the zodiacal sign Leo; for Leo is the sign of that love which springs into existence as the result of natural affinity between soul-mates. These were differentiated at the same moment and constitute the eternal north and south poles of one deific ego. Leo, the mansion of Sol, well represents the spiritual spheres of the angelic parents; and as the sign ruling the house of love in a natural birth-chart it symbolizes that form of spiritual love resulting from common angelic parentage and identical Cosmic Work. Love, as signified by Venus and her signs, on the other hand, may be the result of planetary affinity, mental compatibility, or other causes.

The belt suspended from the sword on which the reunited souls rest is the zodiacal cycle of necessity from which they are now ready to soar, having risen superior to its attractions by means of the intelligent use of the regenerate sword, the vernal transmutation on the cross of Aries. This means is still further exemplified by the words on the belt signifying, "To me God's Will is Law." And the result of the

adoption of the spiritual life is signified by words above the belt meaning that Order has been established from Chaos. The thirty-two stars under the wings represent the twelve zodiacal signs, ten planets, and ten kingdoms of universal life under whose influence the soul pilgrimaged. These kingdoms are: I Celestial, II Spiritual, III Astral, IV Mineral, on the involutory arc; and V Vegetable, VI Animal, VII Human, VIII Astral, IX Spiritual, X Celestial, on the evolutionary arc.

The crown above the heads of the eagle symbolizes the ego to which both have become united, completing the trinity and conferring upon them the crown of everlasting life. The Maltese cross above the crown indicates the beginning of a new cycle in realms above the spiritual, that they will now enter, which opens up vistas and possibilities undreamed of by man. The ego, as it were, is at the lower solstice of this new cycle; the upper solstice contacting the very presence of the triune God, symbolized by the effulgent trine. Such is the exalted destiny of man. The number thirty-three signifies the cycle of necessity having been completed that the triumphant souls are translated to a new and higher round of life and action. The two threes united as thirty-three indicate the union of two souls having had complete experience on all three planes. And by their union their powers are multiplied as greatly as is the case when the two separate threes are joined in the manner indicated.

Conclusion

The ancient Masons, or Magi, specialized in acquiring knowledge that would enable man to live to his highest and make the most rapid spiritual progress. The information thus gained they passed on to posterity in the language of universal symbolism. In particular they emphasized these four things:

1. That the soul survives physical death and sometimes communicates with those still in the flesh. Also that man has faculties by which, while still on earth, he can explore the inner plane where later he will dwell and prove for himself that personality survives physical death.

They left instructions for the cultivation of such faculties, and for their use in acquiring information. The Brotherhood of Light ESP Research Department is engaged in ascertaining the details of the safest and most effective method of employing these faculties.

2. That energies from the planets exert an influence over human life and destiny. The Brotherhood of Light Astrological Research Department is engaged in acquiring as complete a knowledge as possible of these planetary influences, and of the precise manner in which they influence human life.

3. That love is a powerful constructive agent. The basic vibratory level on which an individual functions, now or in the hereafter, is determined by his own dominant vibratory rate. This dominant vibratory rate is determined by his governing mood, or feeling.

Cold asceticism, intellectual activity, and disregard of the welfare of others cultivate a dominant vibratory rate which enables the individual to contact only lower astral levels. Family life, including the unselfish affections of parents for children, provides opportunity for cultivating a high dominant vibratory rate, through which alone upper astral levels or spiritual realms can be contacted.

Selfishness is the most unprofitable of all things. It chains the individual, until he replaces it with love, to the animal levels of existence. Feelings engendered by parenthood, by caring for the weak and helpless, by harmonious marriage, and by eagerness to contribute to Universal Welfare, raise the basic vibratory rate, and this alone permits spiritual progress.

4. That thought is a powerful influence to shape human life and destiny. The Brotherhood of Light Control of Life Research Department is engaged in determining the most effective way of handling thoughts, feelings and planetary energies to the end of controlling life and destiny.

Note

1. For further information on this subject see Elbert Benjamine, *Astrological Lore of All Ages* (Los Angeles: The Church of Light, 1945/1994).

Book 5

Copyright
Church of Light
August 2002

Esoteric Psychology

Chapter 1

Serial No. 56
Original Copyright 1936
Elbert Benjamine

Copyright
Church of Light
August 2002

Doctrine of Esoteric Psychology

Chapter 1

Doctrine of Esoteric Psychology

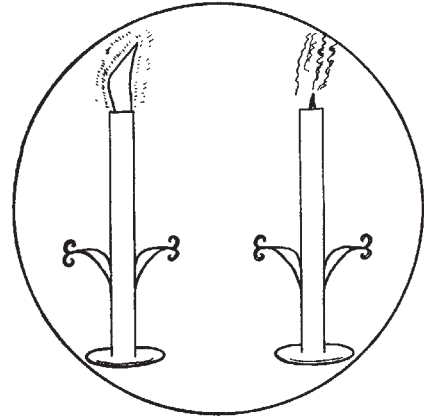

PSYCHOLOGY is the science of mind; and the word esoteric signifies inner. Esoteric Psychology, therefore, embraces the inner workings of the mind; not being confined in its researches to the physical, or three-dimensional plane, but including every plane and every type of life-form through which mind, or soul, expresses.

This does not exclude the findings of exoteric psychology, which confines its attention to the physical world. Inner processes are largely recognized by their external effects. Thus the better to understand the relationship of inner mental factors, we can afford to ignore no demonstrated finding of laboratory psychology. In fact, the experiments of the Behaviorist school of psychology, and those of the psychoanalysts, afford us a vast fund of carefully checked evidence. Thousands of such experiments conducted by specially trained men enable us to cite facts which give us understanding of the processes of the unconscious mind.

Terminology

—Some fifty years ago Thomas J. Hudson, after observing various types of psychic phenomena, came to the conclusion that man possesses, in addition to his ordinary everyday consciousness, mental abilities and mental processes of which he is unaware. In his *Law of Psychic Phenomena* he set forth the theory and apparently demonstrated it by many examples of their workings, that each human being has two minds. The common everyday one, of which we ordinarily are conscious, he called the Objective Mind. The other, about the operations of which we usually have no knowledge, he termed the Subjective Mind.

Then, after Hudson, there arose the school of experimental research, which exerted a vast ingenuity and dogged perseverance in devising and applying tests by which they hoped to determine, not merely if spiritistic phenomena took place as claimed by its advocates, but if it all could be accounted for through the subjective mind, or as they chose to term it, the Subconscious Mind.

These found that there is a section of the human mind which functions while still attached to a physical body much as Hudson said. Some of the greatest of these scientific Psychical researchers, such as Sir Oliver Lodge and Sir William Crookes, became convinced they had received evidence of the survival of the personality in an unseen world. And about that time it was decided that another name was more suitable for that which they had been calling the Subconscious Mind. They therefore joined the Latin *limen*, meaning threshold, to *sub*, meaning under, to form the word signifying those states of mind which are below the threshold of everyday consciousness.

Up to the time of Freud, the Subliminal Mind was the current terminology for that which Hudson had christened the Subjective Mind. It was coined as a strictly descriptive term. But certain popular metaphysical writers jumped to the unwarranted conclusion that it was used to denote sublime, in the sense of lofty, and was therefore a very superior thing to the Subconscious Mind.

To their imaginations, but not to scientific men, nor to genuine occult students, there existed three minds: the ordinary Objective Mind, the rather despised Subconscious Mind, and the god-like Subliminal Mind to which they looked in demonstrating whatever they desired; even to demonstrating into their own pockets, without giving value received, money which other people had worked hard to acquire.

Not that they wished to be dishonest. They merely lost sight of the fact that wealth is the product of labor applied to material, or its equivalent, and that even when wealth is demonstrated by the power of the Subliminal Mind, someone works to produce it. Money is not materialized out of thin air, but when one person acquires it, another person is deprived of it. Which is just enough, if he is given its equivalent value in return.

With the coming of Freud and the vast literature on psychoanalysis which followed him, a new fashion in terminology developed, and what had once been called the Subconscious Mind came to be recognized by psychologists as the Unconscious Mind. Therefore, to keep step with the approved terminology as it exists at the present moment, in these lessons that which once was called Subjective Mind, Subconscious Mind, and Subliminal Mind—all meaning the same thing—will be referred to as the Unconscious Mind.

Furthermore, because in it resides the sum total of consciousness including that which connects up with the physical brain to express as Objective Consciousness, it should be understood that the Mind, the Soul, the Character and the Unconscious Mind of an individual are one and the same thing. There are not two minds. What is called Objective Consciousness, or Objective Mind, and about which there is a growing tendency upon the part of some psychologists to call Clear Consciousness, is merely a portion of the Mind, Soul, or Unconscious Mind—as you choose to term it—manifesting through the physical brain. To do this it utilizes electric energies to impart vibratory rates to the brain cells.

How the astral substance of the four-dimensional realm in which most of the energies of the Soul, or Unconscious Mind reside, exchanges energy with physical substance through their mutual contact with the ether is explained in detail in *Laws of Occultism* (Course 1). That mind, in some degree is an associate of substance wherever found is set forth at considerable length in *Spiritual Alchemy* (Course 3). And the steps and processes of the Involution and Evolution of the soul are given detailed attention in *Astrological Signatures* (Course 2). Therefore, it must be assumed that the reader is somewhat familiar with these subjects, which afford the necessary background for the comprehension of Esoteric Psychology.

Man's Highest Tendencies Are Built From Low Desires

—The practice of psychoanalysis, for instance, has revealed to psychiatrists that within man's Unconscious there lurks every tendency, impulse and desire characteristic of lower forms of life on earth. Many of these traits have been amalgamated to express man's higher tendencies, and in the normal human life find little opportunity for their old expression. Nevertheless they are there, and under certain pathological conditions they separate from the higher tendencies of which they form a part and become dominant as bestial desires expressing in anti-social forms of behavior. And even in the lives of normal men the presence of these lower-than-human tendencies are revealed to the alert observer in the many little unconscious actions of everyday life, and particularly in dreams, while the vigilance of the higher mentality is dormant.

That such should be the case is to be expected when it is recognized that all the traits and characteristics of the Unconscious Mind are derived from its previous experiences, as conditioned, stored and fused into more complex organizations within the four-dimensional astral form.

Every Soul is Called Into Existence to Fill a Definite Cosmic Need

—Observing the operation of God's Great Plan, and how life-forms fit into it, each in its proper niche, all marching forward under cyclic law to perform a higher destiny, moving from the simple toward the more complex, brings conviction that souls are not brought into existence—differentiated, as the occultist would say—willy, nilly; but according to developing Cosmic Need.

The ego, or potentiality which furnishes the energy to cause the soul, or mind, ceaselessly to struggle forward to the accomplishment of its destiny, is a spark of the divine fire, that is, pure spirit; an eternal atom of Deity. But until the moment of differentiation, it has no special individuality. It has potentiality, but that potentiality has not been released in the performance of any given activity. Under the stress of the Cosmic Need for a special type of soul to perform a given function developing in the future, the spirit atom is drawn into the creative vortex of angelic parents and given that definite trend which becomes its individuality.

Needs and trends of the mental and physical worlds are mirrored by the positions of the planets and zodiacal signs. These create tensions and set up pressures in astral substance which have an influence upon life. Life-forms find it easy to move in the direction of the prevailing four-dimensional currents; but difficult to face the astral headwinds, or even to go cross-stream. Thus can activities on earth be foretold by charting the heavens.

This Law of Correspondences, as the relation between entities or movements and stellar positions is called, is universal in its application. And while the stresses in the Cosmic Mind belong to a plane of dimensions far above that which can be charted, we can assume that something similar obtains even in the most interior realm, and that, were we on the six-dimensional plane, the so-called Celestial Realm, where the ego receives its differentiation, that it would be quite possible to chart the stellar influences there which resulted in any particular ego's differentiation.

Observation, if extended sufficiently far, convinces that the universe is not fortuitous but exhibits the characteristics of intelligent design. And we must conclude, not merely from the Law of Correspondences, but from witnessing the processes of evolution, that the intelligent entities of which the universe consists, and which perform its work, are not brought into existence unintelligently, but because the completion of the universal design calls for the performance of the function for which each is being educated.

Each ego is called from the realm of potential unspecialized spirit by the developing need for a workman of a particular kind. And could we possess the stellar chart of the moment when it is born of angelic parents—that is, differentiated—this celestial birth-chart would furnish us with the design of the function the ego is called into existence to fulfill. Such would be the ego's birth-chart.

This celestial birth-chart mirrors one portion of the Whole Cosmic Plan. It is that section of the progressive Infinite Design which is the ego's special work and which it can do better than any other; because it is called into existence under those conditions which give its potentiality those special trends, which when developed through education, fit it particularly for that work.

As the Cosmic Temple is a very complex edifice there must be workers, so to speak, in iron and workers in brass, workers in wood and workers in glass— painters, masons, decorators, lighters, heaters and a myriad others—on the faithfulness and efficiency of all, each in his own line of endeavor, depending the perfection, utility and beauty of the Temple. Yet the edifice never will be completed; for it is laid out as a progressive plan, such that when one set of specifications is completely filled another is imposed, outlining a finer, more exquisite, effect.

Such increasing perfection, and such expanding proportions, not only require a continual addition of new workmen—egos with their attendant souls—but require in those already at work, increasingly higher skill of execution. Thus must they perpetually progress in the perfection of their abilities that they may handle the work which it is their special mission to perform, and which assures them of immortal life.

Each ego, therefore, at the moment of its differentiation, under the influence of the stresses that then mirror Cosmic Needs, is given a polarity—that is, attractive and repulsive qualities—that determines broadly the trend of its future development. This original polarity, could it be mapped, would constitute the ego's chart of birth, affording a blue-print of its future work, and indicating the type of experiences necessary to develop such abilities as are required in its performance.

The ego, when differentiated, however, cannot be said to have possessed either feeling or knowledge—Love or Wisdom—because, as set forth in full detail in “The Mission of the Soul” (Lesson No. 4), all knowledge and feeling are derived from experience with environment. They are based upon perceptions of relations; and the ego as yet had experienced no relations, awareness can be developed only through repeated contacts with changing environment.

All Feeling and Intelligence Are Due to Experience

—All intelligence and all feeling are developed through the recognition of the differences that exist between things contacted. And the ego, due to its Original polarity—attractive and repellent quality—at once started attracting experiences. That is, it started having those experiences which are the basis of feeling and intelligence—Love and Wisdom. And thus it gradually built around itself, of the substance of the plane it occupied, a form which was sensitive to such contacts, registering and reacting to them.

How the ego, that it might have wider contrast and variety of experiences, extended the sphere of its influence to the fifth dimensional spiritual realm; and there, to still further widen the scope of its training and ultimate usefulness divided the soul-sphere which it had developed into two-monads, is explained more fully in *Astrological Signatures* (Course 2). Each of these twin souls however, expresses the birth-chart of the ego according to its masculine or feminine polarity.

These two souls are impelled in their forward evolutionary movement by the same spirit ego. There is the same potentiality, or driving power, behind each. These souls, or minds thus developed by the ego, are organizations in substance which register experiences derived from contacts with the environment. The kind of environment attracted is determined by the polarity of the ego; that is, by its celestial birth-chart; just as the experiences attracted by a man are determined by his physical birth-chart. The ego at all times furnishes the divine driving power that urges the development of both souls and gives to them that ineradicable longing for significance that becomes the will to live and struggle. Nor can the soul lose its immortality so long as there persists the connecting line between itself and its ego.

The ego furnishes the eternal divine energy. This energy acts upon the substance of some plane of existence, and a form is gradually built. The form whether spiritual, astral or physical, becomes organized in a particular way through its contacts with environment. Its experiences are registered as feeling and intelligence. Feeling and intelligence, however, are not registered by physical substance. Three dimensional existence affords a means of contacting experiences of great contrast and wide diversity, but in itself is too coarse to retain such impressions. But associated with all physical substance (see Course 1) is both the ether—a transition substance—and the four-dimensional astral, or stellar, substance. This four-dimensional substance is frictionless, and retains indefinitely the motions imparted to it. And it is in this fourth-dimensional substance that all physical and astral experiences are recorded.

The recording of an experience, whether directly derived from the external environment or from a mental process, causes a change to take place in the substance where the recording is made. That is, the sum total of the organization in the finer forms, all derived from experiences, constitutes the soul, the mind, the character, or the unconscious mind, these four terms signifying identically the same thing.

What these experiences have been was determined by the birth-chart of the ego. Each of its two souls or thought-organization, is moving forward under the impetus given it by the ego, gathering those experiences, in association with various forms, which it requires to develop the abilities indicated by the ego's birth-chart to be necessary to perform the required function in realizing the Cosmic Plan. It is busy acquiring both the experience and the power to be able to handle that section of Cosmic Work for which the ego provided the blue-print.

The ego's chart is the blue-print to which both the female soul and the male soul work. That is, in the division of the soul sphere in the higher state of the spiritual realm, as a physical cell so often divides to form two, the original polarity of the ego impressed itself equally upon each. But this quality of attracting certain events and repelling others, because exerted in the one case from feminine relations and in the other from those masculine, does not result in identical experiences for twin souls. As the essential polarity of each is the same, in their broader outline the trains of experience parallel each other. But in particulars there is wide variation. Yet both the parallels and the variations in training tend to educate them so that they both desire, and are fitted for, a given work, in which their abilities complement each other.

Because through the long stretch of time since its formation a soul continues to manifest attractive and repellent qualities similar to those of its ego's birth-chart, even though these qualities have been given special twists and trends through contact with environment, the birth-chart of an individual when he appears on earth in human form bears, in a broad and general way the impress which indicates his Cosmic Work. But from this we must not conclude that the birth-charts of twin souls must be almost identical. In their broader aspect they show similarity; otherwise they would not be fitted to work together in the performance of a common Cosmic Function. But that their abilities should complement each other, each has had a variety of experiences not undergone by the other; and a birth-chart is a map of all the experiences a soul has had up to the time of human birth.

The Energy of All Experiences is Retained

— Experiments with subjects in a state of hypnosis, psychoanalytical practice, and a wide variety of psychological phenomena all demonstrate that every experience, even the slightest and most inconsequential, is registered and retained without loss by the unconscious mind. The awareness of the experience by the unconscious mind adds energy to its organization. As the astral substance of the finer body is frictionless this energy is permanently retained; although it may unite with other energies in the formation of a more complex organization. Yet at any time contact is made with it by etheric energies that have the power to impress the cells of the physical brain, it reproduces itself there and the experience is remembered.

No theory of material science has ever satisfactorily explained memory. It is estimated that there are 1,200,000,000 cells in the gray matter of the human brain. These are dynamos for the production of the electric energy used in objective thinking, including objective memory. The white matter is a matrix on which are recorded, through the development of interlacing nerve fibers, action patterns which are established through etheric energy hookups. That is, etheric energies forced to travel certain paths once, develop physical lines through the white brain substance that permit them again to follow the same route with greater ease.

Such action patterns, making it easy for etheric energies to follow paths once traveled, aid objective thinking. But what about the intelligent action of blood corpuscles or of an intestinal loop, when removed from a human body, as cited in lesson No. 64 (*How to Think Constructively*)? Nerves and brain facilitate objective consciousness, but many creatures have neither.

Yet memory is present, in some degree, in association with all life-forms. Goltz found that frogs deprived of their cerebral hemispheres would get out of an inverted jar by swimming under the bottom, and thus reach the air. And from such experiments material science concluded: "All nerve centers have then in the first instance one essential function, that of intelligent action." And Professor Ewald

Hering after exhaustive research and experiments in the realms of biology was forced to admit that memory of a kind resides in protoplasm. In his *Memory: Lectures on the Specific Energies of the Nervous System*, he says; “Thus every organized being of our present time is the product of the unconscious memory of organized matter.”

But while material science, to account for the things observed in laboratory experiments, insists all organized matter possesses an unconscious memory, it fails to suggest its mechanism. Nor can it be explained until it is recognized that associated with organized matter is a frictionless replica in four-dimensional substance which has the property of retaining all the impressions it receives, and through the intermediary of the electric energies which accompany all life processes, of again imparting similar energies to the physical protoplasm.

The Astral Body is Thought-Built

—For sake of convenience all states of awareness may be classified as thoughts. All experiences of which the unconscious mind is aware, as well as those recognized by objective consciousness, therefore, may be classified according to the kind of thought-elements they contain. That is, the energies added to the four-dimensional form, and which organize it, are those of definite thought-elements. In this sense the astral form of every living thing is a thought-built body, built of the thought-elements which on the four-dimensional plane serve a purpose similar to that served by the chemical elements of the physical world.

These physical chemical elements combine in certain compounds to form the protoplasm which is the substance of physical organic life. The body of man, for instance, is chiefly composed of protoplasm and its secretions. And on the astral plane the thought-elements also combine in certain compounds to form the chief substance of the organic four-dimensional body; a substance called psychoplasm.

The protoplasm of the physical body exists in the form of cells. And in like manner the psychoplasm of the astral body is not just a homogeneous mass, but exists in the form of innumerable cells, which are called thought-cells or stellar-cells. They are termed thought-cells, and the structures they form are called thought structures, because they are thought formed; and they are also termed stellar-cells and stellar structures, because both astral and stellar pertain to the stars, and the substance of the four-dimensional plane is that not only of which the thought-cells are Composed, but through which astrological energies exert their power.

Keeping in mind that stellar-cells are the thought-cells of which the four-dimensional body is formed, it's not difficult to understand that these enter into the organization of definite structures. In the physical body there are muscular structures, bony structures, membranous structures, nervous structures, etc., all composed of protoplasm cells or their secretions. So also in the astral body there are structures which have been built up by active stellar-cells, organized by the energies of thought processes into definite forms and each possessing its particular type of energy and performing its particular function.

The elements of which the stellar cells are composed have entered into combination according to the circumstances present at the time they were built, by experiences, into the astral form. The conditions then present, and subsequent mental processes, have arranged them according to a definite pattern, or have organized them into some definite structure of the astral body. The more powerful and energetic of these structures in the four-dimensional form are termed Dynamic Stellar Structures.

It should not be thought, however, that these thought-cells, thought-built stellar structures, and thought organized dynamic stellar structures have been chiefly acquired through experiences in human life. All life-forms on the astral plane and all life-forms on the physical plane are constantly adding energies derived from their various experiences to the cells and organizations of their astral bodies.

Neglecting consideration of the thought-cells built by the soul in five-dimensional substances in its descent to the astral, let us consider that the unconscious mind, or astral organizations, as the result of its experiences in one form, learns how to handle its processes, and in time to build and function through a still more complex form. Whatever experiences it had before it contacted the substance of three-dimensional existence formed thought-cells within its structure. And as a result of these astral experiences it finally was able to enter into the fertilized germ of some lowly form of physical life.

When this single-celled organism died, the experiences it had had in connection with it underwent further organization as it lived on the astral plane, and gave it the ability to be attracted to, and to function through, a physical life-form still higher in the scale of evolution. And this process continued until at last it had had experience enough to build about itself the physical body of a human being.

Innumerable processes take place within the human physical body which are undirected by the objective mind, about which the objective mind knows nothing, and which if it did recognize them it would fail to understand. The manner in which the blood corpuscles carry nutrition to the tissues, the processes of glandular secretion, the assimilation of food from the digestive tract, and the work of the various organs are all directed by the unconscious mind, the thought-cells of which, and the thought-built structures of which, have learned how to do these things in association with lower forms of life. That is, many thought organizations in the human astral body were built in the past to enable some lower organism to perform its function.

Thus when the soul, or unconscious mind, is attracted to the fertilized seed of the human species, it has back of it a long history of accomplishment, which has developed the abilities it will be called upon to use as a human being. Innumerable thought-cells fill the twelve distinct compartments of the astral body. Well built thought structures, or stellar structures, some of them containing great energy, such as the dynamic stellar structures that denote the natural abilities with which the child will be born, are already present.

And when the human child is born, due to that mysterious sympathy which exists between the soul and the stars, its birth-chart provides an accurate map of the most important arrangements of thought-cells within its unconscious mind, their composition, their energy, and particularly the type and activity of those most active groups of thought-cells, the dynamic stellar structures.

I am not here so much interested in indicating that a birth-chart is a map of the soul and its organization at the time of birth into human form, as in pointing out that the abilities and tendencies thus mapped are simply a cross section of the soul's progress through time. That is, centuries before birth its organization was different, and centuries after birth its organization will be different. That with which it is endowed at the time of birth represents the sum total of its experiences as organized at the time of birth. Before birth it had fewer experiences, and after birth it will have had more experiences, these adding new energy to the unconscious mind and changing its organization. Thus the soul, or unconscious mind, is not static; but ever moving forward, developing along the general line called for by its ego's blueprint; acquiring those experiences which most it needs at any given time to develop the abilities it will be called upon to use in Universal Construction.

The Justice of Each Soul's Experiences

—At this point someone may inject the thought that it is unjust for one person to suffer and for another apparently to escape hardship and to realize most of his heart's desires with little effort on his part. Such a question, however, is based upon a narrow and purely materialistic conception of universal processes. It assumes that justice can be obtained only by material awards.

Yet even the materially minded must admit that the sense of satisfaction is a far better measure of how life has treated an individual than is the possession of health, long life and worldly goods. By worldly standards alone those who have less opportunity and fewer material possessions, even though pain and hardship is their lot, often gain more from life in the way of happiness than do those who apparently sit in the lap of the gods yet grumble because they still are discontented.

But to consider human life and the physical plane as the sole place and time from which justice must be measured, even if the soul returned over and over again to occupy a human form—which it does not—is to narrow the judgment to trying to appraise the whole value of a life which is illimitable in time by viewing a single cross-section of it which is infinitesimal in duration in comparison to the whole. It is less logical—because a day in proportion to the span of a man’s physical life is far longer—than trying to judge how fortunate a man is, that is, what his rewards are, by estimating what befalls him on one day alone. Yet the particular day selected may not be a fair average. It may be the day of his whole life on which he has a heavy financial loss, takes down with a severe illness, has an accident, or on which he inherits money, gets honorable mention for some service, or is victorious over an opponent.

Not only the physical plane can not be used to estimate the justice with which an individual is treated by universal law, but even if the events stretching along the line of life in innumerable life-forms before the soul was incarnated as a human, and the myriad other events which are attracted after the soul has graduated from the physical plane, be used in the appraisal, the method still is faulty, because it omits the factor of satisfaction.

All life strives for satisfaction. And feels well treated or badly treated in the degree it attains or misses the satisfaction for which it craves.

The greatest single craving of any life-form is directed toward significance. Much will be said in subsequent lessons about this urge to be something, which is really the motive power behind every life-form, causing it to cling to life and to struggle on, even in the face of difficulties. Yet, because the ego’s blue-print is different, each pair of souls derives its ultimate sense of significance from attaining a different objective. That is, each pair of souls gains its sense of satisfaction from filling in the design furnished by its ego. Yet as the birth-chart, or blueprint, of each ego is different from that of every other ego, the line of effort which gives maximum significance and satisfaction to one pair of souls must be different than that of any other pair of souls.

To bring the discussion back to the commonplace, what man having great talent for watchmaking, and in love with his work, envies the locomotive engineer or the statesman? When a man is performing his proper function, whatever that may be, he has a sense of significance, and a happiness which he could gain in no other way. Who shall say that his real reward is smaller than another’s; and by what standard shall it be judged that the born watchmaker is being unjustly treated because he was not born with talent as a physician or with a flair for law?

Each soul, at every stage of its cyclic journey, is striving toward the realization of the blue-print of its own spiritual ego. Such realization is only possible through the exercise of highly specialized talents; through the use of abilities that are not the same in detail as those of any other soul. The only possible way such abilities can be acquired is through a suitable education. And the original polarity imparted to it by its ego was such as to attract to it whatever experiences might be necessary to develop the essential abilities.

All life-forms on the physical plane and astral plane have obstacles to overcome, suffer pain, enjoy pleasure, and must struggle to adjust themselves to an ever-changing environment. But the type of experience attracted by either a man or a worm is not determined by the moral worth, not meted out as reward or punishment: but is attracted because that man or that worm requires that particular experience to teach it something which it must know if it is to fulfill its eternal destiny.

If the lesson is not learned from one experience of a kind, it will continue to attract that type of experience until it does learn. Thus, whatever the experiences which a life-form undergoes at any particular time may be—however pleasurable or however painful—they are attracted because the soul has need of them in its education. The only way largely to escape painful experiences, therefore, is for the soul to learn how to acquire its essential lessons from experiences that are chiefly lacking in pain.

The Three Psychological Levels

—The soul that now molds the form of a man developed the ability to handle chemicals—chemical selectivity—from its experiences in the mineral realm. Its progressive experiences in the vegetable kingdom, recorded in the thought-cells of the four-dimensional form, gave it those experiences which developed its power to mold a form which has sensitiveness. Passing through the varied range of animal life, from the simplest to the highly complex, gave it experiences which finally enabled it to express Simple Consciousness. And because its experiences in such forms afforded it opportunity to learn how to handle a still more complex organism, it finally was attracted to the fertilized seed which under the intelligence stored in the cells and structures of the astral form, grew into a man, endowed with a still higher type of mental expression, called Self-Consciousness.

Experimental psychologists say that animal reactions, especially those of man, may be considered as occurring at three levels. The oldest is what they call the physiochemical level, through which the unconscious mind directs such functions as circulation, digestion and growth. On this level the thought-cells of the astral body exercise control through the chemical regulators of metabolism, the endocrine glands and the sympathetic and autonomic nervous system. Such processes were learned by the thought-cells in forms of life lower in the scale than vertebrate animals.

The next level of experimental psychologists is that of the reflex, the sensory-motor level integrated by the peripheral nerves, spinal cord and brain stem. Its processes were learned by the thought-cells in forms of life lower than man which had advanced far enough to possess a well differentiated nervous system, such as all vertebrate creatures use.

The highest level considered by experimental psychologists, the third, is the so-called psychic level commonly made use of by man, in which there is no problem of leverage, hydrodynamics or temperature; with acids, bases or hormones; nor even with simple or compound reflexes or nerve cells, nerve fibers or synapses. Instead, the reactions arise from the use of symbols. To a limited degree certain of the higher animals seem capable of handling symbols in their mental processes, but at least those more complex, such as are called concepts and ideas, only emerge as the implements by which the organism adjusts itself to its environment when the soul, having graduated from forms lower in the evolutionary scale, reaches the estate called man.

Man, however, does not function exclusively on the symbolical level. It is merely the latest superstructure added to the edifice of his acquired abilities. And because so lately acquired, he has as yet learned to use it but imperfectly. More of his various reactions, therefore, still take place at the physiochemical and the reflex level; the symbolical, in so far as it takes part, merely acting as a stimulus to set these other processes into motion.

This symbolical level of reacting to conditions does not imply the process of reasoning or even the activity of a physical brain such as is called Objective Consciousness; for the dream life, conducted by the unconscious mind, in higher animals is almost exclusively on this level. So let us examine now the processes and functions of that limited field of mental activity called the Objective Mind.

The Objective Mind Was Developed to Take Care of New Situations

—Life-forms if they are to survive must make repeated adaptations to their environment. They must replenish the energy which is expended in their life processes. Furthermore, conditions surrounding them are never static; changes take place, and they must take appropriate action to prevent these changes causing their destruction.

Their actions must be different in the heat of the day, for instance, than in the cool of the night; different in the summer than in the winter; different when in the presence of an enemy than when that enemy is absent.

These experiences of the forms it occupies at various times are retained in the thought-cells and thought structures of the unconscious mind and increase its ability to meet still other situations successfully. It learns how to do many things, and as soon as it has had enough experiences of a certain kind, the energies of the thought-cells involved become so accustomed to acting together in the manner required to meet that situation that the adaptation becomes habitual. That is, it requires no close attention to the details of its performance. Such actions are then said to be directed by the soul, or unconscious mind.

But when a new situation is present, toward which no habitual reaction has been established, a problem is presented which taxes the intelligence of the organism to solve. And to insure the organism of being fully aware of such changes in the environment, and to afford a keener tool to cut into the new problems thus presented, evolution—that is, accumulated and organized experience—has developed the nerve structures of the physical body, and as life progressed, grouped these nerves into a system, with ganglion, or centers, the highest type of which is the brain.

The brain of an animal was not designed to be aware of all the various states of consciousness, nor to direct all the activities of the body. It was evolved for the clearer apprehension of the external environment, and to direct more effectively those actions which were made necessary by new conditions.

The habitual responses of the organism to situations which it had encountered many times before are better taken care of by the unconscious mind. But to grasp all the implications of a new situation, and determine how they should be met, something more than the uncontrolled feeling which prompts habit became necessary. And to meet this demand for an additional implement for appraising reality, the cortex of the brain was evolved, which permits of feeling and wishing being to some extent subordinated to an intelligence which examines, compares, relates and finally decides. Exercising this and other functions through the brain is termed Objective Consciousness.

Objective Consciousness is not something apart from the Unconscious Mind. It is present when the unconscious mind is able to impart the energy of some of its thought-cells and thought groups to the electric energies which flow over the nervous system in such a volume that it sets up similar vibratory disturbances in the cells of the physical brain. The variety of thought-energies that the brain at one time can thus receive and handle is quite limited. That is, the consciousness which is associated with the physical brain can attend to but a few things at a time. Furthermore, in order to connect up the energy of the thought-cells of the astral body with the physical cells of the brain, a chain of relations must be stimulated by some environmental condition.

Objective Consciousness it may thus be seen not only was not designed to embrace more than a limited field, but by the nature of the forces under which it developed, it becomes active only at the point of conflict of the organism with its environment. That is, Objective Consciousness is chiefly concerned with new physical and mental adjustments. And it concentrates the mental energies in such a way as the better to overcome the resistances of situations not before contacted.

We may expect, therefore, Objective Consciousness always to be engaged with some special situation or condition or the problems which it suggests. The thought-energies in the unconscious mind related to the particular thing which at the moment engages it are connected up, through the etheric energies which interpenetrate the physical body, with the cells of the brain. In sleep, because the thought-energies of the unconscious mind are largely disconnected from the cells of the physical brain, the Objective Consciousness does not function. Dreams, which are activities of the unconscious mind, are remembered only to the extent their energies are connected up with the physical brain, and thus brought up into the region of Objective Consciousness.

Objective Consciousness has its important and special function to perform in life. But it cannot be considered as the action of a different mind. No more so than the animal soul and the divine soul are separate entities within the domain of man. The Animal Soul merely embraces those thought-cells and thought organizations that are concerned only with the interests of the individual. Divine Soul merely embraces those that relate to universal welfare. Yet both groups of thought-cells and thought structures are interblended into the single organization called the unconscious mind. The soul, character, mind, or Unconscious Mind thus embraces all the states of consciousness of the organism. But the Objective Mind embraces only those that communicate their energies from the unconscious mind to the cells of the physical brain in a manner to be recognized.

Chapter 2

Serial No. 57
Original Copyright 1936
Elbert Benjamine

Copyright
Church of Light
August 2002

Reason and Intuition

Chapter 2

Reason and Intuition

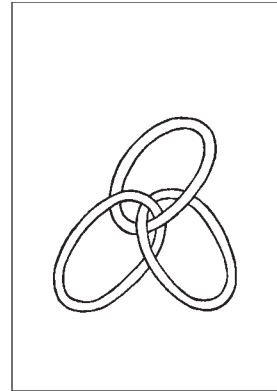

AS REASON and intuition are the very latest products of evolution, perhaps the best way to understand what they are and how they work is to trace the outstanding steps by which they gradually developed. Let us, therefore, start at the beginning, with the energy of the spiritual ego striving to realize that function in the Cosmic Plan for which it was called into being—which is the driving force behind every soul—and follow through to the present manifestation in a human form.

This urge to fill in its ego's blueprint manifests in all life-forms as the struggle to survive and to be something. That is, the desire for Significance is the oldest of all impulses with which the soul is endowed. And, as determined experimentally through laboratory work, it is the strongest of all desires. It is the one which, so long as life lasts, the soul will not relinquish. The thought elements built into the astral body by experiences that give additional energy to this most deep seated of all tendencies are called the Power elements. Their most energetic thought-structure in the astral body is mapped in the birth chart by the position of the Sun.

The Three Irresistible Drives

—These Power elements, in their expression, give rise to two primeval desires of opposite polarity, just as the ego evolves a positive and a negative soul. The two primeval desires are not thought elements, but the still more primitive factors of which all thought elements are built.

In our physical universe positive and negative charges of electricity (see lesson No. 40, *Astral Substance* in Course 1)), as protons and electrons, are the building blocks of which all the elements of matter are composed. And in a similar manner, all true thought elements are composed of Reproductive Desires and Nutritive Desires in some proportion. That is, the elements (belonging to 10 distinct families) of which the psychoplasm in the thought-cells is composed, are themselves built up of still simpler tendencies, called Reproductive Desires and Nutritive Desires.

Next to the desire for significance the two strongest are the positive desire to attain that significance through expression outside of the self and the negative desire to attain that significance through adding something to the self. The positive reproductive desire manifests as the tendency to perpetuate the race, or in the desire to perform some creative work; both of which give some satisfaction to the desire for significance. The negative, nutritive desire gives rise to all those activities having for their end self preservation, which, in turn gives opportunity for significance.

Experimental work in psychology determines that the unconscious mind of man will give up life, or even sacrifice his offspring, rather than consider himself inferior. Nevertheless, love of life and the impulse to perpetuate are so strongly built into the astral body as a part of itself—that is, as an essential portion of the thought elements of which it is composed—that it is impossible to suppress their energy.

In every person, therefore, as well as in all lower forms of life, there are three hereditary Drives: the Drive for Significance, sometimes called the Will to Power; the Drive for Race Preservation; and the Drive for Self Preservation. Behind all the elemental thoughts of which the stellar body is composed, as the original source of energy, is the Drive for Significance. But entering into their construction, even as protons and electrons enter into the construction of all matter, are the Reproductive Drive and the Nutritive Drive. We say they are hereditary because every living creature is born with them. They have been acquired in all stages of the soul's past coincident with those processes which built up the astral form.

Deferring until lesson No. 60 (*Why Repression is Not Morality*), to indicate how the Reproductive Desire and the Nutritive Desire have combined to produce the ten families of thought elements—Power elements, Domestic elements, Intellectual elements, Social elements, Aggressive elements, Religious elements, Safety elements, Individualistic elements, Utopian elements, and Universal Welfare elements—let us now turn our attention to the underlying law which determines how experiences combine in the unconscious mind that enables it, when the process has evolved sufficiently, to express as Reason and Intuition.

Sensation

—Starting with a simple sensation: A disturbance at the end of a receptor, or sensory nerve, results in an etheric movement called a nerve discharge being sent along the nerve to the cells in the brain, where it gives up its motion. This electric motion communicates energy to the astral body in that compartment relating to such experiences, and when there is a recognition that it has some relation to previously acquired motions residing in the thought-cells there, it is then felt as a sensation. So long as the etheric motions in the physical brain cells vibrate with the energy also communicated to the astral form, there is Objective Consciousness of the sensation. But when the etheric motions of the sensation subside all Objective Consciousness of it ceases.

The sensation is not lost, however, for the rates of motion imparted to thought-cells in the astral body, due to the frictionless nature of astral substance, persist. Under suitable stimulus, such as other etheric motions later setting up associated vibrations in the astral body, they may be communicated through etheric motions to the cells of the physical brain. The sensation is then remembered by the Objective Consciousness.

The more nearly the vibrations imparted to the etheric substance—which communicates the energy from the astral thought-cells again to the physical cells of the brain—resemble the original nerve discharge, the more perfect is the memory of the sensation.

Sensations commonly are the stimuli which produce physical motions. And that the reports of the senses may not be confused with the executive orders based in the soul, or unconscious mind, or even Objective Mind, upon these reports and upon the reports of long ago, there are different organic wires, or nerves. Those specially constructed to transmit messages, or electric motions, from the body to the Central Station, or brain, are called afferent, or ingoing nerves. Those parallel wires so constructed as to carry messages from the Central Station, or from those substations called plexuses, back to the same point are called efferent, or outgoing nerves.

For the purpose of securing information about the environment the soul has developed special organs called senses. Material science commonly recognizes but five such senses, whose relative accuracy is determined by experience. But the ancient wise men recognized not merely seven physical senses; but also seven psychic senses by which the soul could apprise itself of the conditions in its astral environment. And it goes without saying that the reliability of these psychic senses also can only be determined by carefully checking their reports against subsequent experience.

The report of a psychic sense, because it does not come in over a physical nerve, nor by means of etheric motion, does not register directly on the cells of the physical brain. Its motions are carried to the thought-cells of the astral body by means of vibrations in four-dimensional substance. But they are, nevertheless, registered in the energies of the thought-cells as completely as are the motions received through nerve currents which directly impress the physical brain.

Thus when suitable conditions arise that enable these energies, through associated vibrations being set up by etheric energies that connect with the brain, to impart their motion to the physical brain cells, they are remembered. Recognition by Objective Consciousness of the report of one of the psychic senses is always, not a direct stimulus like a physical sensation, but a bringing up from the Unconscious Mind something which it has recognized on the four-dimensional plane. That is, even though the interval since the experience is infinitesimal, it is in the nature of a memory.

Perception

—The awareness of a sensation—or of a combination of sensations; for what the individual is aware of is not just one sensation but various impressions that reach him from the environment—is called a PERCEPTION. Yet any given perception is not the simple thing it seems. The whole relation between sensation and objective phenomena has been established already through a process of trial and error. Thus the infant reaches for the moon and cries when it eludes him; but later experience teaches him that certain objects are too far away to be touched. Also that some other objects which look very nice, when reached for, give rise to pain.

Since it came into existence the soul has been gathering sensations. And the energy of these sensations, which when brought up into objective consciousness we call memory, is still retained in the thought-cells of its astral body. A sensation coming in, therefore, stirs up the thought-cells with which it becomes associated in the astral body, and these give up some of their memory energy to the physical cells of the brain. That is, the awareness of a sensation, such as may be called a Perception, is never simply the recognition of the energy which has come in over the nerves; for to this energy always is added that of associated experiences which has been stored in the thought-cells of the unconscious mind.

Apperception

—An apperception is the contribution of the mind—of the stellar cells in the astral body—based upon previous perceptions. And psychologists agree that APPERCEPTION contributes more to any perception than does the action of the stimulus upon the sense organ at the time. In other words, how an object looks, feels, tastes, smells or sounds to us, depends more upon the experiences stored away in the thought-cells of our unconscious mind than upon the report of the sense organ then active.

A savage looking at a beautiful painting may see only a few daubs of color where an artist will view a living scene of glory. The perspective of this or any other picture is simply an appeal to Apperception. It depends for its efficacy upon the fact that the observer has had innumerable experiences viewing objects whose lines presented similar gradations of shading and convergence, and in such cases the originals of the lines were found experimentally to have possessed three-dimensions.

Apperception, while commonly facilitating the correct appraisal of environment, also may give rise to errors in perception. Writers, for instance, find utmost difficulty in proofreading their own mental output. So familiar are they with the way it should read, and with the spelling they intended to use, that in reading their copy for the purpose of detecting errors, they see it as they intended to write it rather than as it actually is.

Preperception

—A preperception is an anticipatory mental image. Thus, as an example which everyone has seen, an outline drawing of a cube may be made to seem to stand on one edge, or it may be made to seem to stand on its bottom, at will by expecting the position it will assume while steadily looking at it. Or an outline drawing of interlaced rings may seem to be solid rings interlinked; or simply rings cut to fit each other snugly at the point of intersection.

An illusion may be produced by associated preperceptions. Thus if a visiting card bent to enclose an oblique angle be stood on end with the vertical fold away from the observer, and he stands about a yard away and looks a little downward into the cavity and imagines the two sides bent in just the opposite way so as to form a convexity, thinking the vertical line of the fold to be nearer than the edges, he will find he can then banish the illusion and make the card appear concave, as it actually stands.

Another illustration of illusion through preperception may be produced by handing some person a small box and a large one of equal weight and asking him to estimate the difference in weight. Far better still, have the small box lighter and have him fill it with sand until it exactly equals the weight of the larger. It will be found that because of the person's PREPERCEPTION, or expectation, that the smaller box will be deemed equal in weight to the larger when in reality it is very much lighter. A small object is expected to be light, and when given additional weight it seems unduly heavy.

When we see an object its picture is actually formed upside down on the retina of the eye. It might be expected, therefore, that instead of an object out in space in front of the eye and right side up, we should behold this small inverted picture in the immediate region of the eye. But Apperception and Preperception cause consciousness to refer the sensation to the outside world, right side up and in its proper place.

Due to the same influences, when a clairvoyant sees an image—which rises like a vivid memory into subjective consciousness from a perception of an astral image—the thing seen commonly presents itself as if it were at a particular place in front of, behind, or at the side of the seer. This is because previous images derived from three-dimensional sources have registered in consciousness as occupying definite spatial relations. Consciousness has come to expect images to be related to the three-dimensional world. Thus also, when we visualize a past experience from memory, even though the original setting of the occurrence has changed or been destroyed, we perceive it in the space relations with which once we were familiar.

Visual images are more important to man than those auditory. Yet the sense of hearing is subject to the same laws of perception.

Vibrations of the air strike the ear drum and thus communicate motion to three little bones, to the liquid and otoliths in the vestibule, and thence to the membrane and nerves leading to the brain. The disturbance which impresses consciousness really occurs within the head. But through Apperception and Preperception it is referred to a definite location in the external world.

As with visual images, by appealing to Apperception and Preperception, it is easy to produce illusions. For instance, by looking upward in an anticipatory manner the attention of others is attracted to the region above, that is, a preperception is established that something is happening there. Then by speaking without lip movement, and in a voice that suggests effort yet is of diminished volume, apperception is brought into play. The hearer often has heard voices at a distance such as to give a similar impression of tension and lack of volume. It seems to him, therefore, that the sound must come from a distance. And because his attention has been directed in an anticipatory manner to a high place, it will seem to come from there. He will be made to think the voice is that of a person on a high building, when in fact it is the voice of someone at his elbow. Such are the means used by ventriloquists.

The Two Kinds of Attention

—Not only do we never experience simple sensations, because they are always coincident with apperception—that is, perceived only coincident with related sensations previously stored in the stellar cells of the unconscious mind—but apperception and preperception can be used to increase the range of sense perception.

This may be demonstrated by having someone sit in a quiet room with his eyes closed. Let a watch be brought into the room and carried at the level of his head toward one of his ears, and the distance measured where its ticking first is heard. Then hold the watch for some minutes close to his ear until he has become thoroughly familiar with the sound, after which gradually move the watch from the ear while he endeavors to hear it, until at last he can no longer discern the sound. In this second experiment it will be found that the sound can be detected at a greater distance. The memory of the ticking (apperception) and the expectation (preperception) both aid in perceiving the sound.

Had his attention been focused on some other sensation, or on some mental process, he would not have heard the ticking of the watch even when it was adjacent to his ear. This circumstance derives from the well known fact that the number of factors that can be attended to simultaneously by the mind is limited; and that the awareness of any additional sensation diminishes the clearness of other perceptions which are already before the mind. Concentrating the energies upon a mental process or upon perception increases the efficiency in that direction.

The attention which is drawn to a perception or mental process, through the energy of the perception or mental process such as hearing a fire alarm or thinking about an absent loved one, is called SPONTANEOUS ATTENTION. It is the kind of attention animals lower than man in the evolutionary scale use almost exclusively, and also the kind man tends habitually to use. It gives rise to Fantasy Thinking, which has its use, but which also, through lack of critical discernment, is the source of most of our errors.

The attention, on the other hand, which is focused in the manner decided upon after a selective appraisal of various possibilities, and in spite of the distracting stimuli of irrelevant sensations and desires, is called DIRECTED ATTENTION. Directed attention makes possible critical analysis and the separation of facts from the beliefs encouraged by desire. It gives rise to a form of thinking of which animals lower in the evolutionary scale than man are incapable, and which is the crowning glory of man's intellect—DIRECTED THINKING.

All Mental Processes Are Governed by the Law of Association

—Sensations, perceptions, and other mental factors bear relations of likeness or of contrast to certain other sensations, perceptions and mental factors. And as experiences, either directly with the outside world or of a subjective character, add their energies to the thought-cells and thought-structures of the astral body these energies enter into combination with other energies added at the same time or already present in the thought-cells. And with what energies they thus combine is determined by the likeness or contrast between the two sets of energies.

To be more explicit, things are similar to each other, or dissimilar to each other according to size, color, weight, odor, taste, sound, form, feel, place in space, place in time, etc.

The similarity or dissimilarity in time or space has been given a special name. It is called CONTIGUITY. Two objects seen at the same spot, or near the same spot, at different times or at the same time are contiguous in space. Two objects seen at the same time, or near the same time, whether adjacent in space or not, are contiguous in time.

Other types of similarity or dissimilarity than those of time and space are classified under the term RESEMBLANCE. A red apple and a red nose resemble each other because both are red. A red apple and a white apple resemble each other by contrast between red and white. And a red apple and a baseball resemble each other, not so much through color as through form; that is, both are round. In a psychological sense, when the color of black suggests the color white, the images join in the mind through resemblance.

Taken together, Resemblance and Contiguity (which is really space or time resemblance) form the LAW OF ASSOCIATION.

That is, whatever enters the mind (adds its energy to the thought-cells and thought-structures of the astral body, or rearranges the thought-cells and thought-structures into different organization) combines with the factors already there, and exerts whatever influence it does, according to its Resemblance or Contiguity. And every and all mental processes, whether they rise into the region of objective consciousness or perform their activities wholly within the unconscious mind, are carried out under the influence of Resemblance or Contiguity, that is, according to the Law of Association.

Sensations Combine to Form Perceptions

—Granting that one sensation does not reach consciousness from the environment entirely apart from other sensations, and that when the soul is born in human form it has a wide background of experiences associated in its astral form, it is nevertheless both convenient and accurate to consider sensations as the building blocks of which all consciousness, however complex it may be, is composed.

The sun and fire give rise to similar sensations both of feeling and of sight, and become associated in the mind through this similarity; and the sun and ice give rise to contrasting sensations both of feeling and of sight, and become associated in the mind through this dissimilarity. The association between both the sun and fire and the sun and ice derives from psychological Resemblance.

Light and warmth, however, and ice and cold— because the light of the sun or of a fire is often experienced at the same time as heat, and cold is frequently felt in the presence of ice—are associated through Contiguity.

Light, stimulating the optic nerve may, therefore, bring to mind the thought of ice, through the Law of Association; light being associated with cold, and cold being associated with ice. And in some such manner, through chains of contiguity and resemblance, are all processes of which the mind is capable carried out.

However, what we now perceive is not just a simple sensation, but a combination of them greatly modified by apperception. When we see an apple—or the first time it presents to our vision the form of a disc and the additional sensation which we call the color red. Both the round form and the red color, as they enter consciousness are associated there with previous experiences of red and round, so that when on first sight the impression an apple gives is somewhat complex.

Let us then walk around the apple. The disc appearances which it presents from different angles then become fused, that is, the various sensations of form unite in the thought organization of the astral form, to produce an image of a sphere. When the apple is taken into the hand this spherical image is confirmed, and to it is added the sensation of hardness which in the consciousness is correlated to previous experiences with softness, hardness and elasticity.

The apple then may be tasted, and the texture, flavor, and juiciness become associated together through contiguity, and associated with other sensations previously experienced through resemblance. When the core and seeds are encountered these give rise to definite sets of sensations, which in turn are associated through contiguity with the other sensations derived from the apple, and through resemblance with experiences with other things that have been recorded in the unconscious mind.

The sensations we experience with the apple are retained in the mind in association with each other through Contiguity, and they join with other sensations already in the mind through Resemblance.

When, therefore, we again see a small red disc, the sensations experienced are much more complex than the color red joined to a round form. Instantly, through the Law of Association, the small red disc image connects up with a large variety of other sensations which, through experience, have become used with it. We perceive the apple not as merely a small red disc, but as being spherical, as having firmness, as possessing flavor, and containing seeds and a core. Apperception has played its part, and the fusion of many simple sensations has given rise to a composite picture presenting to us the many qualities which experience has taught us to expect in a red apple. In a parallel manner all perceptions are fusions of numerous simple sensations.

Perceptions Fuse to Form Conceptions

—Things having qualities in common give rise to perceptions which, through Resemblance or Contiguity, become associated in the thought organization of the unconscious mind. In biology, for instance, a species embraces many individuals having almost identical characteristics; a genus embraces individuals having characteristics in common, but not so nearly identical; a family embraces individuals that may belong to a number of genera, and which have at least a number of points in common; a class embraces individuals still more widely varying from each other; a phylum may include many classes, and a kingdom contains a vast number of individuals belonging to different phyla, classes, families, genera, and species. Yet because each of these terms embraces only individuals with points of resemblance it is called a CONCEPTION.

A Conception is built up somewhat after the manner of a composite photograph. By photographing successively on one plate a number of faces, allowing for the total exposure of all only the time commonly employed for one, a picture may be obtained such that all points in which the faces agree are brought out vividly, and those in which they disagree are hardly noticeable.

In a similar manner are all ideas built up.

Apple, for instance, is a composite of all our perceptions of various kinds of apples. The image in our mind brings out strongly all the points in which the apples of our experience agree; but those in which they differ, one from another, are left vague.

As an idea retreats from specific sensations toward the fusion of a wide variety of sensations into one composite whole, moving toward generalities, it is said to become more Abstract. Jonathan apple is rather specific, applying to individuals joined in the mind by a number of well defined and identical characteristics. The idea apple, however, growing more Abstract, embraces many varieties and a number of species. When we speak of the Rose family, if we are familiar with botany, we include not only apples, but pears, strawberries, plums, cherries, peaches, apricots, almonds, etc. The Vegetable Kingdom includes a still wider abstraction, and when we mention a living thing, there are still fewer points in common, and the term embraces a still wider field of individuals.

Finally, following this process, the fusion of points in common is so remote from suggesting any individual that it is called an ABSTRACT IDEA. Thus the number 10, because it does not bring to mind specific instances, but suggests so wide a scope of possibilities, is an abstract idea. The adjectives, such as good, bad, high, low; and such nouns as quality, honor, and integrity, while less abstract than numbers, are terms, nevertheless, which include points in common which have been derived from so wide a variety of perceptions, that they also must be considered Abstract in nature.

Conceptions Unite to Become Reason

—Let us take for a major premise the thought that all apples grow on trees. This signifies there have been many perceptions registered in the stellar cells of the unconscious mind of apples, and many perceptions also registered there of another group of objects which we have regarded as trees. The first group, apples, has been formed by fusing all the sensations and perceptions of our experience with a certain type of fruit. The second group has been formed by fusing all the sensations and perceptions of our experience with woody plants of that size and texture which we have come to call trees. Apple is one idea, or conception; tree is another idea or conception; and to grow is a third.

These three conceptions have been bound together in the mind by their Contiguity, that is, by observing that whenever we found apples growing they were always in space and time associated with trees.

Now if we take for a minor premise that this object is an apple, it signifies that we have recognized a full resemblance between a group of images in the minor premise and a group of images in the major premise. Apples thus become a common factor.

When, then, the two propositions—the major premise and the minor premise—are brought together, their Contiguity reveals a full Resemblance between concepts in both. They unite on this common ground to give rise to the Conclusion: The Object Grew on a Tree.

We do not, of course, in the common process of reasoning, state the matter in the form of a logical syllogism, as I have here presented the matter of the apple and the tree; but in all Reasoning there is, nevertheless, a clear establishment of associations between different states of consciousness by an intermediate state of consciousness, which by definite associations with both brings about their amalgamation.

Intuition

—Only when the chief steps in the process of arriving at some conclusion are recognized by the Objective Consciousness, that is, when the energies are communicated through etheric vibrations to the physical brain cells, may it be called Reasoning. But this bringing together of different mental factors, including conceptions, is also a normal function of the Unconscious Mind.

Thought-cells fuse, exchange energies, become organized into complex structures, and discharge their accumulated tensions, in the four-dimensional realm which is their proper plane of movement. These activities take place in obedience to the Law of Association whether etheric energies connect them up with the physical brain or not. Psychoanalytic experiments prove that asleep or awake, man's mind is never still; trains of thoughts are constantly in motion, many of which never gain recognition by objective consciousness.

When a problem is presented, or the interest is aroused in some subject, this interest, or desire, focuses the attention upon it. The energies thus directed through the Law of Association, connect up with various factors in the unconscious mind that have a bearing upon the matter. If the interest—desire to know or observe—is keen enough, it may stimulate the psychic senses of the astral body to pick up additional information from the four-dimensional plane. The Law of Association then brings together all the available information possessed by the unconscious mind having an influence upon the thing under consideration, and a Conclusion emerges.

This Conclusion, which is the result of a process similar to reasoning carried out below the threshold of objective consciousness, because there is no necessity to impart energy to the ponderous physical brain cells in each operation, may be reached instantly. The four-dimensional realm is frictionless, and its facilities for speed almost limitless; so that when Reasoning is carried out exclusively in the four-dimensional region of the unconscious mind, its processes seem to take no time.

When, as the result of attention being directed to some situation, the unconscious mind thus reaches a conclusion, objective consciousness may never be aware that such a conclusion has been reached. It is only when conditions are present that enable the conclusion reached by the reasoning of the unconscious mind to impart, through etheric energies, that Conclusion to the cells of the physical brain, that objective consciousness is aware of it. When it does thus rise, apparently full formed and spontaneously, into the region of objective consciousness, it is called INTUITION.

Intuition is due to a process similar to reasoning carried out by the unconscious mind; and because from the four-dimensional plane so many more facts are discernible than from the three-dimensional plane, if it is unwarped while coming through from the four-dimensional region of the unconscious, it is apt to be a far more reliable guide to truth than clumsy and ponderous Reason.

It is well to cultivate the Intuition, not only because it now may be made to yield such accurate conclusions, but because, in a few years, it must chiefly be depended upon; for after we have left the physical body behind, Reason, which is dependent upon physical brain cells, can no longer offer guidance.

To do this the thought must be vigorously and positively held that the unconscious mind can form correct conclusions regarding the various problems of life. It should be recognized that its range of perception, through the use of the psychic senses of the astral body, is vastly greater than that of the three-dimensional brain, and that in it are stored a vast number of facts and impressions long forgotten by objective consciousness, upon which it can draw. Confidence should be placed in it to form correct conclusions, and to find the opportunity to project them up into the physical brain cells as Intuition.

Then, to give assurance that it is being relied upon, the impressions should be alertly watched with the intention of discerning that feeling or inner knowledge which is Intuition. Every such impression should be noted. Not that it should be accepted as fact; for in each instance its accuracy should be subjected later to a rigid test of verification. The reliability of Intuition, of any psychical or physical sense, or of reason, can only be ascertained by checking it against subsequent experience. But by giving it the proper kind of exercise the power and accuracy of the Intuition can vastly be increased.

Suggestion

—Intuition, the reports of the psychic senses, and reason often are warped and distorted through the influence of some dominant idea; that is, of some organized group of thought-cells which have so much energy that they can determine what impressions shall, and what shall not, be imparted to the cells of the physical brain.

Emotions, particularly those experienced in early childhood before the critical faculties have acquired sufficient experience to appraise values and evidence, often add energy in unusual volume to the thought-cells relating to some conception. Those of shame, those of religious import, and those related to sex are particularly potent in this respect. When an idea attains an inordinate amount of power, through energy thus added to it in great volume, it is then able to dominate the unconscious mind to such an extent that no perception, impression, or fact in conflict with it can impart its energy to the physical brain cells. It acts as a censor, and anything that gets objective recognition must subscribe to its policies.

Suggestion, also through concentrating the attention, and therefore much of the energy, upon a given idea or image, temporarily exercises a similar function.

We hear a great deal about the power of suggestion, about its use as a therapeutic agent, and sometimes unfortunately, how it can be used by one person to take unfair advantage of another.

It is not necessary that a person be asleep or in a trance to be susceptible to suggestion. It is merely necessary that the critical faculties shall be off guard or held in abeyance. A state something between the full waking condition and sleep, in which the person is aware of what is being said, but takes no pains to analyze the statements, nor to recognize inconsistencies, is fully as advantageous in administering suggestion.

As previously mentioned, the mind can give its attention fully to but a very limited field at any one time. To the extent the attention is completely occupied by one thought or one sense impression, are all other thoughts or sense impressions shut from the consciousness. Let the experimenter, for instance, while looking at a picture, call vividly to mind some scene of his childhood and hold it attentively. He will find that, even though looking steadfastly at the picture, it will vanish and in its place he will see only the picture imaged by his memory.

Then, while still holding the mental picture before the attention, if a portion of this attention be transferred to his objective surroundings, he will perceive dimly the physical picture and some environmental objects, but these will not be vividly recognized; they will seem a part of memory's scene. Thus, in hypnosis, or under the state of half sleep, half wakefulness in which suggestions best are applied either by another or to oneself, the attention is directed by the operator to certain images, which for the time are so vivid as to inhibit the clear recognition of objective reality which in any manner conflicts with them.

If the hypnotic operator suggests to his subject that a stick is a snake, the mental image of snake becomes so blended with the sense reports regarding the stick that the two are blended, and the subject sees the stick as a snake. He feels and acts toward it just as if it really were a snake.

In the case of the unscrupulous real estate operator who takes his victim to a suburban cottage and paints for him a rosy hued mental picture, never permitting his prospect's attention to wander, or even to think about anything but what the operator is saying; the effort is made to build up an attractive picture which is so vigorous that it will, for the time being, exercise a censorship to keep the critical faculties in abeyance.

To give the image power, as many and as strong desires are appealed to as possible. It is the energy of desire, as the salesman knows, that leads to action. Thus he builds up the good qualities of the property in the prospect's mind, careful that he shall have no opportunity for calm reflection. Aware from experience that reflection will enable the critical faculties to impose disadvantages upon the image, the salesman increases his own enthusiasm and endeavors to flush a quick sale before the glamour, which has been created by his suggestions, wears off. He knows that if his victim comes from under the influence of the dominant image built thus painstakingly into his unconscious mind, before the sale is made, that it will not be made at all.

Later, after he has placed his name on the dotted line, the victim wonders why he was so stupid as not to think of this disadvantage and that detraction, which were quite obvious, but which he completely overlooked while the salesman's suggestions were dominant enough to rivet his attention and prevent the entrance of images that were in conflict with them.

Apperception and Preperception in Psychic works

—A person who is able to make no predictions as to the future, or to gain no unusual information without such aids, by the use of coffee grounds or tea leaves in the bottom of a cup, or by looking at clouds or into a flame, may be able to gain information quite inaccessible to the physical faculties, or to make predictions of startling accuracy as to the future.

Such methods of divination utilize the Law of Association in connection with apperceptions and preperceptions to bring up into objective recognition that which perceived by the senses of the astral body, or which already has found lodgment in the unconscious mind.

The psychic senses, functioning on the four-dimensional plane, are able to perceive a great variety of facts concerning a person, that are inaccessible to the objective consciousness of anyone. By combining these factors the unconscious mind is able to deduce correct conclusions not merely regarding the present but also regarding the future.

Unless the person, whose unconscious mind has been directed to ascertain the facts of present and future regarding someone, is a very gifted seer, without artificial aids his unconscious will be unable to project the conclusions up into the physical brain cells with sufficient force to receive recognition.

A certain group of leaves, grounds, clouds, or forms in the flame may remotely resemble some animal. It may really resemble the picture of a tree, a horse, a pig or a locomotive as closely as it resembles that of a dog, depending upon the angle from which is it viewed. But apperception and preperception cause it to be seen as the thing which is suggested by the unconscious mind.

There is anticipation that something will be seen in the divinatory instrument which will reveal the information sought; that is, there is a preperception that the image seen will represent information possessed by the unconscious mind. The unconscious mind under this impetus has sought out the information and has had its attention focused upon it. The nerve current set in motion by the image registered by the physical sense of sight thus connects up, through the Law of Association, with the information on which the attention of the unconscious mind is focused. The image in the unconscious mind, struggling to find an avenue into the realm of objective consciousness, thus all at once finds the necessary electric energy available to which

it can impart its motions with sufficient intensity that the impact is registered by the physical brain cells. Thus to the image registered by the physical sense of sight is added apperception—that is, the image with which it has become associated in the unconscious mind. And this apperception contributes so much energy that the physical perception is made to resemble the apperception. If the image dog is in the unconscious mind, and has sufficient energy, when it is connected up with the physical brain through electric energies, it can make any object seen, whatever it may be, so strongly resemble a dog that the thought of a dog will register in the objective mind.

And where, as in most divinatory instruments, there are a wide variety of images, or alternate readings to select from, the attention is easily directed by the unconscious mind to such an image as needs no great distortion through apperception to enable the Information it is striving to impart to gain recognition from objective consciousness.

Evolution of Mind

—Starting with merely the energy of the desire for significance, the soul acquires the ability to feel sensations. Sensations twine together to form perceptions, perceptions fuse into conceptions, and conceptions unite to produce those mental processes of which man is so proud, which, when the conclusion alone is presented to the objective consciousness, we call Intuition; but which when the intermediate steps also are objectively recognized, we call Reason.

Chapter 3

Serial No. 58
Original Copyright 1936
Elbert Benjamine

Copyright
Church of Light
August 2002

Language and Value of Dreams

Chapter 3

Language and the Value of Dreams

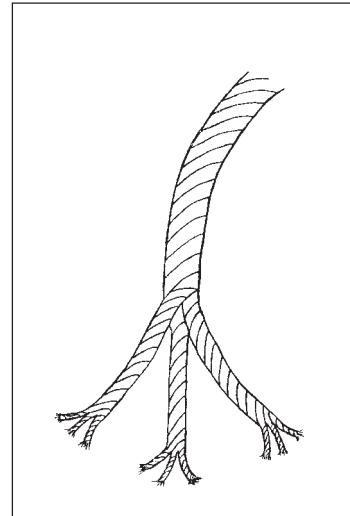

ONE can hardly locate any point in the evolution of mind where symbols first were used. After all, concrete things cannot exist bodily in the mind, and as a symbol is that which stands for something, whatever mental images the mind holds are the symbols of its physical and mental experiences. Those symbols which are now in current use as the words of our language, are merely the more complex development of a process that is as old as life itself.

The oldest language of all is the language of feeling; used by the soul, or unconscious mind, to receive information from its sense organs, and to communicate its orders to the form it occupies. Whatever, at any point in its cycle that form may have been, it reacted to the conditions of its environment. That which is felt was stored as thought-elements in the thought-cells of the unconscious mind. This feeling, as thus stored, imparted information to the unconscious mind; information which **CONDITIONED** the future conduct.

Even at the present day, because the language of feeling has been so very long in use, the cells and organs of our physical bodies take their orders readily from feeling, and but reluctantly from the reasoned commands of objective consciousness. One must steel oneself carefully, making the reasoned command unusually forceful, to prevent flinching while a knife digs out a sliver of wood that inadvertently has found its way under the finger nail. The old language of feeling gives the command to move away from the object inflicting pain. Reason says hold firm, that the offending invader may be removed and thus prevent still greater future pain.

When attacked, reason commands anger to be held in abeyance; that the actions may more effectively be guided by cool judgment. But the old language of feeling harks back to primitive occasions of attack, and commands that adrenaline should be secreted, stimulating the heart action, and withdrawing blood from certain vulnerable regions and giving those organs used in combat an additional supply. Even though the head be kept clear, when conflict thus arises, it is the unusual person whose physical cells and organs are so under the dominion of reason that his body

does not react to the stimuli of his glands. In spite of reasoned commands, on occasions people blush, grow pale, flush, exhibit signs of nervousness, and blunder in the performance of trivial tasks. All because the glands, cells and organs of the physical body more readily understand the language of feeling than they do the words employed by the objective mind.

Because physical life had the power to feel before those special organs of feeling used in hearing and in sight were developed, the general language of feeling is the oldest of all means by which the unconscious mind communicates its desires to the physical organism. But with the development of hearing and sight, visual images and auditory images were related, through the LAW OF ASSOCIATION, with this language of feeling.

Sight is the ability to feel, through special sense organs, the etheric vibrations reflected from objects in such a manner as to distinguish and define those objects. Hearing is the ability to feel, through special sense organs, the molecular vibrations that have been set in motion within the range called sound. Other people have a nervous system so sensitive that they can feel the thoughts of others at a distance in such a manner as to recognize their significance. And some, furthermore, perceive through bringing up into objective consciousness what is recognized by the special sense organs of the astral body. Yet whatever the organ employed to gain information from the environment, it merely specializes in some process of feeling.

Every Thought Brings a Change in the Physical Body

—Creatures with eyes have learned to place great dependence upon visual images, that is, upon the ability of the eyes to interpret the feeling received from lightwaves. Repeated experience has associated certain images with definite feelings. The image of a snake close at hand is so closely associated with danger that not only man, but many beasts, react instantly by leaping away from the image. No slow and laborious process of reasoning here. Nor in dodging a missile seen coming at one's head. Time is too short to think the matter over. Association has related the image of the snake or the missile not only with danger, but also with a special kind of movement to avoid the danger. The visual image itself, through its previous associations, is utilized by the soul, or unconscious mind, as a means of commanding specific action.

Another visual image—the sight of food—is utilized by the unconscious mind as a means of commanding the flow of saliva and the gastric juice.

Or if we wish to turn to auditory impressions, the cracking of a dry stick in a region where game has been much hunted, is so closely associated in the mind of each animal with danger, that it has all the force of a command from its unconscious mind to flee at once. No stopping to think it over. No pausing for visual verification. The crack of the broken stick sets it off as if, which at times it does, its very life depended on it.

Here I have given a few outstanding examples of the operation of a principle which the laboratory psychologists have formulated in these words: “No mental modification ever occurs which is not accompanied or followed by a bodily change.”

This means that every perception, sensation and conception being a change in the astral form is accompanied by a tendency to produce corresponding changes in the physical body. Astral substance being so much more mobile, the changes usually take place in it first. In the case of organic growth, for instance, the organic processes of renewal and multiplication of tissue afford the astral form the opportunity to mold the physical form by acting upon small particles as they are deposited from nutrition.

**Symbols Are Habitually Used by
the Unconscious Mind to
Communicate With the Bodily
Organs**

— It means also that while feeling is the oldest language used by the unconscious mind, that the unconscious mind in communicating information to the physical cells, physical glands and physical organs, customarily uses visual images, auditory impressions, sensations of odors, and perceptions of taste. The higher types of animals have had abundant experiences in association with each of the five common physical senses. The association of experiences of a given type with a given sense impression relates these so closely in the thought-cell structure of the unconscious mind that when one is given energy the other also receives energy. And because the experiences in the past have called for some special activity, this activity is also associated with the same thought-cell structure. The sense impression, whatever it may be, thus adds energy to thought-cells, which in turn stimulate physical change.

To put the matter in a slightly different manner, a certain sense impression has come, through repeated association, to have a definite meaning to the unconscious mind. It is the symbol of a condition. And acting upon that usual association the unconscious mind has come to use that symbol in issuing its commands to the physical organs. That is, visual images, auditory impressions and other sense impressions are the habitual symbols used by the unconscious mind to communicate information and to command action. And thus it is, whether through dreams, visions, or divinatory instruments, because the unconscious mind is so accustomed to using such symbols, it finds it easier to communicate whatever it perceives to the objective mind by means of such symbols, rather than by means of lately acquired arbitrary words.

Universal Emotional Symbols Used by Animals and Men

—The term language more commonly is applied, not to communications between the unconscious mind and its physical vehicle, or between the unconscious mind and the objective mind, but as denoting the means by which one individual communicates with another. And in this more widely accepted significance of the term it is interesting to note that the rudiments of language may be observed in animals other than man. Sounds, for instance, which arise involuntarily from an emotional stress, become associated with the emotion as its auditory symbol.

When an animal which has experienced pain that has caused it to cry out, hears another animal emit a similar cry, the LAW OF ASSOCIATION comes immediately into play. The sound is at once related in the animal's mind to its own cry, and to the pain which was coincident. In one way or another the particular cry becomes associated with pain in the mind of each member of a flock. And as pain in a similar manner has become associated with that which causes pain, the cry becomes a symbol by which the whole flock is made aware of the presence of danger.

A dog recognizes the snarl and bared fangs of another dog as the symbol of its animosity. A horse will paw the earth as a symbol of its desire to travel, will neigh as a symbol of greeting, and will snort as a symbol of fright. Other horses recognize the significance of these expressions; but the number of such symbols of communication that can clearly be recognized thus by other horses is hardly so numerous that such animals can be said to have a language. Perhaps even the methods commonly employed by man to express emotions of various kinds, though conveying definite information to other men, should not be dignified by the term language. But certainly they border closely on it.

In nesting time, if you will conceal yourself in almost any thicket and suck on the back of your hand, in imitation of the distress call of a fledging bird, every old bird in the vicinity, regardless of species, will come close and exhibit signs of anxiety and excitement. It is a favorite method used by bird lovers to see their feathered friends that otherwise remain invisible. But what interests us here is that birds of different species recognize the sound as conveying the information that some young bird—perhaps their own—is in trouble. That is, this particular sound is a universal symbol recognized by much of the bird world.

Thus also, a frown, a smile, laughter, tears, a cry of joy, an exclamation of fright, are universal symbols recognized in the world of men. Laughter, the world over, is recognized as the symbol of mirth. A smile is recognized as denoting pleasure. A frown indicates displeasure; as does the growl of a dog. The whine of a dog denotes anxiety, and is so recognized by other dogs and by men. Weeping is a symbol of grief among men; and a shout of victory, whether from the throat of a barnyard cock or from those who attend a football game, is unlikely to be misunderstood.

Man then Added Universal Imitative Symbols

— But in addition to these emotional sounds, some of which the higher animals use to convey similar information to their fellows, man at a very early date added those of imitation. That is, he heard the wind through the trees, the noise of water babbling over stones, the cries of birds and animals, and other noises of the wild. And he adopted and adapted these sounds to convey information about the objects with which more commonly they were associated. The sounds that express fear, love, anger and pleasure were derived from the spontaneous expression of these emotions; and an object that commonly gave rise to an emotion might be designated by the emotion; but if there was no such emotional association, it might be designated, instead, by some sound associated with it.

Take, for example, the sound of rushing water and note how it resembles the sounds of the names given it in the various languages: “Rauchen, risseln, ruschen, rinnen, rennen, to rush, ruscello, ruisseau, river, rhein.”

If you ever have listened to the whine of a Norther the word, wind, will be more than vaguely suggestive; as will the word, snow, to one who frequently has heard it slithering along an already ice-hardened crust.

The tracing of words to their origins is an interesting task. And the more we know about such origins the more clear it becomes that there is a complete chain of ASSOCIATION between the emotional and imitative sounds used by primitive people and the words we use today.

For that matter, through using imitative sounds and gestures as universal symbols, it is possible for two people of different nationalities to carry on considerable conversation. Once as a young naturalist in Southern Oregon, in a day when fewer Red Men spoke the English language, I had an Indian tell me of various experiences.

When he wished to tell me of a trapped animal, he placed his hands open on the ground like the jaws of a trap, then closed them suddenly on his foot and emitted the cry of the indicated animal when in distress. I have had him tell me, in such fashion, how many coyotes he had caught; repeating the performance and imitating the snarls and howls of a coyote; how many wild cats he had captured; repeating the

performance the proper number of times, and giving vent each time to yawls and cat-calls. I have had him tell me of other game, imitating the bounding of a deer by leaps with his hands, then picking up a stick and leveling it, and shouting “boom,” much as a child might do. Although I never received instruction in such sign language, I had no difficulty in following the tale he told.

Things Acquire their Names Through the Law of Association

—Through Resemblance and Contiguity sensations fuse to become perceptions, perceptions join to become conceptions, and conceptions amalgamate to become reason and intuition. And under the influence of the same two factors, which together constitute the LAW OF ASSOCIATION, an object acquires its name. In sound, form, color or some other attribute it may Resemble something for which already there is a name; or it may be Contiguous in time or space with something already named. And from the attributes of objects—as in the obvious relation between pigeonhole, which now means a place where a document ceases activity, and the hole in a dovecote where a pigeon comes to rest—as the need for speaking of them grew, were also derived the words by which man designates his conceptions.

Having once associated a word with an idea, another word expressing a different idea often is derived from it through Resemblance or Contiguity. And a whole train of ideas may be expressed by a single word through its associations with some of the words in the train. This development of language, one association leading on to another, each expression built in obedience to the LAW OF ASSOCIATION, on what had been before, is dramatically stated by Anatole France:

“The metaphysician has only the perfected cry of monkeys and dogs with which to construct the system of the world. That which he calls profound speculation and transcendent method is to put end to end in an arbitrary order the natural sounds which cry out hunger, fear, and love in the primitive forests, and to which were attached little by little the meanings which one believed to be abstract, when they were only crude.”

Written language, also, is based upon an imitative foundation. To express that a man was doing a particular thing, the simplest form of writing merely pictured the man engaged in the act. The Cro-Magnons who invaded Europe at the end of the Ice Age thus drew pictures upon the walls of the caves where they resided; and from which they had driven Neanderthal, who was the original cave man.

American Indians, to indicate where game was abundant, traced the trail to be followed on a conspicuous rock, and crudely pictured the game to be found at the proper place along the crooked line which mapped the trail.

Such pictographs are purely imitative, as much so as to make the sound of rushing water to designate a flowing stream. The association is of the most obvious kind. But intelligent peoples were not long content to be restricted by what could thus actually be pictured.

**Symbolical Pictograph is
Closely Allied to the Oldest
Language; that of Feeling**

—To express one thing, they pictured something else which was invariably associated with it. The spring of the year could not be pictured; but a rose, which came always with the spring, could easily be pictured. The time of year when cattle were taken into the mountains could not be pictured; but the clover on which the cattle fed in the high valleys could easily be drawn, and came thus into use to designate the summer.

Or take the cuneiform writing of the early Sumerians. Sheep when sold were kept in pens. It was difficult to draw a sheep with the little wedge-shaped marks in soft clay tablets, but four such marks in a rectangle made an excellent picture of a sheep pen. It was used to indicate sheep. And after it were placed as many wedge-shaped marks—shaped thus because the papyrus stem used for stylus is triangular—or tallies, as there were sheep to be designated. Thus a record was kept of sheep bought and sold.

Some sheep were fat, and some were not fat, and it was desirable in calculating the price to know how many of the sheep bought or sold were fat.

To draw a picture of fat is difficult. But to get sheep fat it was customary to feed them grain. To picture a sheaf of grain with the little wedge-shaped marks made by a papyrus stem was easy. It is the origin of the astronomical symbol of the sign Virgo, and also of the Biblical blessing given to his Virgo son by Jacob: “Out of Asher, his bread shall be fat.” To indicate the number of fat sheep in a transaction, such a crudely pictured sheaf of grain was placed alongside of the pictured pen which denoted sheep, and the required number of tally marks placed after it. Tallies after a pen adjacent to no sheaf of grain were so many sheep which had not been fattened.

In Lesson No. 132 (*The Development of Knowledge*, Course 12-1) the history and development of writing is followed to its more complex modern forms. But here it is only necessary to trace it from its simple beginning as visual pictograph images to the next step, which is the visual symbolical pictograph. Yet the necessity is urgent to make clear at this point that pictographs and symbolical pictographs not only were the first visual images used by the race in the communication of ideas from one to another, but that, because they represent obvious associations, they are the images still employed by the unconscious mind.

While the words we speak, and the letters we write, in reality are linked historically through a long chain of association with obvious relations between things, yet the links in the chain mostly have been lost. Thus our written and spoken language has the appearance of arbitrary sounds and arbitrary marks on paper. It is, in fact, a most effective tool for the expression of precise and detailed information. Yet biologically it is a very recent acquisition, as well as a complex one, and the unconscious mind, for this reason, often finds it a difficult instrument to use.

Pictographs, however, are closely related to feeling. To recognize a mountain or a tree from its picture requires no complex mental process. And if the individual is accustomed to think of the mountain as an obstacle, if it has prevented him from journeying to some desired spot on the other side, the picture of the mountain also, in his mind, has the function of a symbolical pictograph of an obstacle. And if he is accustomed to think of trees only in terms of firewood, a tree, following the most obvious association, may readily become the symbolical pictograph of fire.

Many thoughts cannot be expressed merely by pictographs. We cannot picture energy, love, desire, ambition, thought, religion, statesmanship, and thousands of other conceptions. But through the commonly observed and recognized relations of such conceptions to things that we can picture they can be expressed pictorially.

**Symbolical Pictograph is the
Language Commonly
Employed by the Unconscious
Mind When Feelings Do Not
Suffice**

—Feeling is the oldest language in existence. Visual and auditory images such as either directly or symbolically represent thoughts are far more closely allied to this oldest language than are arbitrary words and phrases; and therefore they are much more easily handled by the unconscious mind. Consequently, when the unconscious mind strives to communicate with objective consciousness, it may make use of feeling. We often hear people say that they “feel” something to be true, even when reason indicates the contrary. Or the unconscious mind may make use of visual and auditory images, such as those experiences which people have in their dreams.

Because symbolical pictograph is the language commonly employed by the unconscious mind to impart information too complex to be expressed merely as feeling, its appeal is universal. Pictorial symbols may be chosen, the common associations of which are the same the world over. In this manner, regardless of changes in arbitrary speech, or differences in nationality, an idea can be conveyed to any intelligent people in the world in spite of passing time.

It was the understanding of this language commonly employed by the unconscious mind, that led the ancient wise men to employ it to impart to posterity their knowledge of occult law and spiritual verity. Instead of entrusting their wisdom to the fluctuations of arbitrary speech, they employed symbolical pictographs which were universal in import. Such universal symbols were traced in the sky as the constellations, and were traced on tablets as the sacred tarot.

The Three Dream Factors

—The question often arises, especially in studying the significance of dreams, why when the unconscious mind attempts to impart some information to the conscious mind, it does not use the language to which the person is accustomed in his ordinary waking life. The reason now should be apparent; it is because symbolical pictograph is far more familiar to it, and is therefore much easier to use.

There are, in fact, three elements of the dream life that need some special consideration. 1. The effect of desire. 2. The effect of the preceding waking period and of stimulation from the external environment. 3. The actual experiences of the soul on the astral plane.

To understand the effect of desire upon dream experiences the difference between Directed Thinking and Fantasy Thinking must be known. Desires are energies in a state of tension within the thought structure of the astral body. Such energies, which are ever straining for release, as well as physical stimuli, tend to attract the attention. Because it was not decided beforehand to focus the attention thus, this type is called SPONTANEOUS ATTENTION.

The energy of a desire tends toward release in action of a particular kind. All action, in fact, is due to desire energy thus released. Yet desire can find expression not merely in physical activity, but also in mental activity. And when it is permitted thus to express in mental images which are uncurbed by the critical faculties, the process is called FANTASY THINKING.

DIRECTED THINKING is thinking with the attention directed by volition. The attention also usually is directed to actual conditions, the effort being made that the images shall stand in their natural relation each to the other, without distortion. That is, directed thinking is a careful attempt to reproduce reality.

FANTASY THINKING, on the other hand, makes little attempt to maintain the distinction between actual conditions and desired conditions; but follows wherever Spontaneous Attention leads.

When a master said that the person who Thinks is the exception, and a great naturalist remarked that few people ever think who think they do, they did not refer to Fantasy Thinking, but to Directed Thinking. Fantasy Thinking takes very little effort; but Directed Thinking quickly uses up energy. It is a process of psychic assimilation that consumes much vitality and leaves the system correspondingly exhausted. In other words, there is no harder work in the world, and none more useful, than Directed Thinking.

In regard to Fantasy Thinking, the late William James said:

“Our thought consists for the greater part of a series of images, one of which produces the other; a passive dream-state of which the higher animals are also capable. This sort of thinking leads, nevertheless, to reasonable conclusions of a practical as well as of a theoretical nature.

“As a rule the links of this sort of irresponsible thinking, which are accidentally bound together, are empirically concrete things, not abstractions.”

Day-dreaming and dreaming in sleep are not dissimilar processes. The difference is chiefly in how much consciousness is influenced by awareness of external conditions. Sit in a chair, relax the body, lean back and close the eyes:

The sound of a street car may recall the rumble of an earthquake, and thus through the LAW OF ASSOCIATION bring before the mind a whole train of images. To the extent the attention is completely withdrawn from the objective world does it more and more become absorbed in Fantasy images. The physical world seems to cease to exist. So long as the physical brain registers a recognizable consciousness of the physical environment it may be said to be awake; but when Fantasy Thinking so absorbs its attention that the few impressions received from objective consciousness are greatly distorted, the physical brain is said to be asleep.

The thought-cells and thought structures of the astral body never cease interacting with each other. In them are stored energies always straining for release. And those which at the time find some measure of expression become the focus of attention. Or, as the laboratory psychologist would put it, every person at all times has trains of thought passing through his mind. Every person dreams continually all the time he is asleep, even though he is unaware he ever has a dream. The psychoanalysts have proved this so completely that it is universally accepted.

Without as yet explaining the source of the energies which desires possess, let us merely consider them as energies straining for release. If a particular desire, whatever it may be, is rather completely realized in the daily life, it has released its energy in thus finding satisfaction. Because it no longer has much energy to spend, it has little power spontaneously to attract the attention, and little energy to use up in the weaving of Fantasies relating to its fulfillment. Its influence upon the dream life, therefore, is not apt to be profound.

We will learn later that attention reinforces the energy of desire and that action is always in the direction of the strongest release of desire energy. Yet the conditions of civilized life place, and rightfully, many inhibitions upon desires that have acquired tremendous energies in their biologic past. It is no longer considered good taste to kill an opponent, even if that opponent is the suitor for the hand of the lady of one's choice. Yet in the biologic past that was the proper thing to do. Nor is it now the proper thing to express the desire for reproduction, except under the protection of a marriage certificate. But birds and beasts and other forms of life through which the soul has made its way, have recognized no such restrictions.

The desire to conform to civilized standards is usually stronger in the waking state than the desire to follow more primitive impulses. Physical action, therefore, is governed by the proper amount of restraint. But restraint does not dispose of the energy of desire, it merely prevents the energy under tension from breaking through and becoming converted into action. The energy is still there, ever striving for release.

The desires which restrain other powerful desires from expressing themselves in physical action, do not offer such unbending resistance to their expression in Fantasy, that is, in the realm of imagination. It is not uncommon for people to permit themselves in their imagination to do things they certainly would not do physically. As a matter of fact, if they were able to express these acts in physical life there would be no need for them to use up the energies of these desires in Fantasy.

The child is born with a sense of omnipotence. In the womb all his needs are supplied. After birth a little crying, or kicking about, brings a quick response to his needs. When no desire is denied there is nothing to indicate he cannot have or do anything he wants. All infants thus live in a happy delusion of being all powerful.

As life moves on, however, their desires multiply and they find obstacles more and more barring the way to their fulfillment. Because the desires cannot be realized in physical action does not destroy their energy. The energy is still there, straining for release. And if a desire is powerful, we may be sure that sooner or later it will find some way of escape.

The Dissipation of Day-Dreaming

—If the desire is such as to afford possibility of realization, and such realization would be beneficial, the best method of using the energy of the desire is to direct it into those actions which tend to overcome the obstacles and thus lead on to its fulfillment.

If, instead, the energies of the desire are permitted to weave Fantasies, in which the realization is attained only in imagination, this may afford a substitute satisfaction. But it uses up energy which should be directed to some actual accomplishment.

The individual who finds great pleasure in imaginary accomplishment, to that extent decreases the energy at his command for actual accomplishment. He has drained his desires without getting concrete results.

Satisfaction in such imaginary accomplishment should not be confused with the use of imagination creatively. Creative imagination brings images together in various combinations, and lives vividly in the mental, or astral, realm, not to find complete satisfaction there for the desires, but to get ideas, to formulate plans, and to perceive how things the better may be done. That is, the desires create and build first on the astral plane; that they may have a correct pattern to follow when they express externally. But there is sufficient energy left, when the correct pattern is decided upon, for a valiant effort to bring about its physical realization.

But when desire, as in Fantasy Thinking and Day Dreaming, is permitted to be used up and attain its satisfaction in imaginary conditions, this is Dissipation. It dissipates energy in useless inner experiences which are negative. And to the extent satisfaction is found in such imaginary situations is there lack of ability to attain satisfaction in the realm of reality.

It is true that many desires, in their original form, should not be permitted expression. But they each represent so much energy that can be made available for real accomplishment; and means can be devised by which such energy can be diverted into channels that lead to worthwhile results.

Censorship

—Civilization has, from early childhood, built into the unconscious mind certain standards of conduct. More primitive desires, even when fortified with energy, are not permitted to trespass too far on these standards, even in imagination. There are things that an individual does not permit himself to do even in his day-dreams. Nor will he permit himself to do them in his dreams at night. That is, he has within his unconscious mind desires not to do these things which are stronger than the desires to do them.

This does not dispose of their energy, however, and they seek constantly to find some means of expression.

In our everyday life it is common to make veiled illusions to things that it is bad taste to state more bluntly. On the screen there is a ruling that the person firing a gun, the gun, and the victim who is killed by the shot, must not all be shown at the same time. The person firing the shot can be shown, then the person struck by the bullet can be presented an instant later, and finally persons looking down as if on a dead body. The actual killing is thus symbolized.

Civilized standards of conduct impose upon the movie screen restrictions as to what can be shown in its stark reality. Yet these realities are made known to the audience by symbolical pictographs.

Nor will civilized standards of conduct permit the individual, in his dreams, to do the crude things which some of his primitive desires prompt. The civilized desires stand as guardians of what may be presented to consciousness. They are stronger than the savage desires; just as the movie censorship is stronger than the producing companies. Yet even savage and crude desires are permitted to express themselves if they disguise themselves sufficiently to meet the requirements of the censors.

Bearing in mind that it is only those desires which have not found fulfillment in objective life which retain their energy, and that the energy of these unfulfilled desires, whatever it may be, is ever straining to find expression, it is easy to perceive that these are the desires which most influence Fantasy. Not able to release their energies in physical action, they release in finding an imaginary realization.

This also indicates that which the psychoanalysts have proved, that the strongest unfulfilled desires are those that most influence dreams.

As the reason they have never been permitted objective realization often is because they are unacceptable to the Civilized Desires, and as these Civilized Desires are frequently strong enough to prevent their crude expression even in the Fantasy of dreams; if they are to find any measure of satisfaction they must more or less completely disguise their real selves in the garments of symbolical pictographs. The experiences of the individual in his dream-life no less than what he hears or sees in his dreams, largely perform the function of such symbolical pictographs.

The Happenings of the Previous Waking State

— Whatever is now before the attention is always linked through Resemblance or Contiguity with that which was before the attention previously. Mental processes are not disconnected images, but trains of thought, one image joined to the preceding image through the Law of Association.

There is, therefore, no sudden jump from the thoughts which occupy objective consciousness to the thoughts which occupy the attention during sleep. All normal dreams start with some experience, or thought, of the preceding waking state. And contrary to what might be expected, this experience which enters into the dream as a connecting link, is more often than not some inconsequential happening or passing thought that was given slight attention during the waking state. Perhaps for that reason it was unable to release energy associated with it, and this energy carried over into the dream state affords the link of connection which dreams always require.

This fact, universally observed by students of dream life, is mentioned here to emphasize that thought is a continuous process night and day, governed at all times, as all mental processes are, by the LAW OF ASSOCIATION; and that in the analysis of what occurs during any sleeping state, if it can be completely remembered there will be happenings which have been definitely suggested by, and have their origin from, something which entered the mind before the period of sleep. This factor, therefore, in dream interpretation, even though represented in symbolical form, should not be given some other significance.

Recognition of Occurrences Witnessed from the Astral Plane

—The astral body possesses sense organs by which it can acquire information from the astral, or four-dimensional plane, in the same way the physical sense organs can be used to acquire information on the physical plane. Furthermore, the astral body during sleep is not chained to the physical, but has the power to move to distant parts, and there to perceive what is taking place.

To the extent it can raise or lower its general vibratory rates it can even travel to higher or lower planes than that of its usual vibratory level. It is almost as free to move from plane to plane, or from one region on a given plane to another region on that plane, as is a discarnate soul. And it can communicate with discarnate entities or persons on the plane it thus reaches after the manner in which people usually converse. Or within certain limits it can tune in, while actually on one plane, sufficiently to pick up information being broadcast from another plane. In other words, even as on the physical plane during the waking state the acquisition of physical information is limited only by the ability of the individual: so the acquisition of information from the astral plane during sleep is limited not by impassable barriers, but by lack of individual training and initiative.

If our attention is riveted during the day to worldly matters, and we have no knowledge of the possibility of acquiring information from another plane during sleep, the mind in slumber continues to occupy itself with the problems and desires of the day. The janitor who every day is in the laboratory where great scientific discoveries are made, as a rule knows nothing of the experiments there being carried out. He is so engrossed in his own personal affairs that these matters of vast importance affecting the destiny of thousands are carried out under his very nose without him knowing anything about them.

If we are absorbed in reading a thrilling tale some person may enter the room in which we sit, and we remain quite oblivious of it. We only see, hear, or otherwise recognize that to which our attention is attracted.

Nor is it something most can do without some training to direct their attention during sleep to the acquisition of information. Since birth the training all has been toward keeping the attention riveted to the physical avenues of knowledge.

Yet the four-dimensional world is open to inspection during sleep, and its entities are there to be contacted, almost as readily as they are after passing from the physical body. And through directing the attention to acquiring knowledge from such sources during sleep much of value, not merely that has already happened or is in existence, but also regarding that which will happen in the future, can be brought back into waking consciousness.

Wish Fulfillment

—Except when some unusual stimulus intrudes, the state of relaxation, such as that preceding sleep, favors Fantasy Thinking. Even without losing objective consciousness, if we close the eyes and relax the body in an easy position, the mind, no longer having its attention directed to reality, tends to drift into a world of the imagination.

In such a state, as well as in sleep, one thing suggests another, and this suggests something else, and if there is in the thought structure of the unconscious mind some strong unfulfilled desire, the energy of this desire, straining for release, soon captures the attention. That is, the energy of such an unrealized desire straining for release is sufficient stimulus that it attracts the attention. The trains of thoughts passing through the unconscious mind are led to this desire because it is making so much disturbance.

A foot uncovered during sleep, if it gets unduly cold, attracts the attention. The Fantasy images are led to include this coldness in their symbolism. This, for instance, may bring dreams of sleigh riding, or of arctic travel. And in the same way the stimulus of an unfulfilled desire brings the Fantasy images passing through the mind to include and symbolize it. The desire is energy seeking release. And it finds this release in the Fantasies of the dream.

But opposed to the crude, even though natural, methods of expression, there may be the rigid censorship of the Civilized desires. Thus if the energy of these unfulfilled desires are to express, even in the Fantasies of dreams, they must conceal their true identities under various symbolic disguises. The images are subject to condensation, displacement, and various other processes, which, nevertheless, when viewed with an understanding of symbolical pictograph, fail to conceal their true significance from one attempting to interpret them.

Dream Interpretation

—In the interpretation of dreams the effort should be made to separate and interpret, each according to its own type of significance, the three various factors of dream life. The happening of the previous waking state that is the link between waking consciousness and the dream should be sorted out and given recognition as possessing this function only. Then the unfulfilled desires, especially the one which at the time is strongest, should be sought, and given its proper evaluation; for it also commonly finds symbolic expression in the dream.

Finally, there often is, and this can be cultivated as the usual occurrence, information of real value to the individual gained from the inner plane. The best manner to learn to recognize this factor is to remember the dreams and correlate their happenings to the events that shortly come into life. Through such cultivation dreams can be made to possess great value.

Chapter 4

Serial No. 59
Original Copyright 1937
Elbert Benjamine

Copyright
Church of Light
August 2002

Desire and How to Use It

Chapter 4

Desire and How to Use It

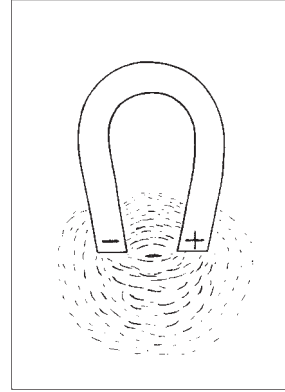

ON WHATEVER PLANE of existence the soul functions, it there functions through a form. This form is an organization. And the work of the soul on any such plane is to make proper adaptations to the environment of that plane. Such adaptations are not restricted to those necessary to survival; but include activities which have for their object the realization of various desires, and on the higher planes the performance of the Cosmic Work for which the soul has undergone its special training.

There is, therefore, at all times and on all planes, an intimate relation between the form occupied by the soul and the forces and conditions external to this form. That is, the universe outside the body occupied by the soul affords various stimuli whose impact affects the body and is felt by the soul. Both the body and the soul react to all such stimuli. In other words, after any particular experience, neither the body nor the soul is just the same as it was before. The form has changed in some respect; and the soul, or sum total of mental factors, also has changed. Something is added to the soul by every experience it undergoes.

Conditioning is the Most Important Process to Understand

—It is this factor which is added to the soul that determines how the organism will act in the presence of the same stimulus in the future. Take the simplest forms of physical life, for instance, and bring them repeatedly into contact with the same type of stimuli, and it is found that, as a result of experience, they react more quickly to them after a time than they did at first. A single-celled organism with power of locomotion will retreat from a drop of injurious acid more quickly after it has had some previous experience in close approach to such an acid. And a baby, after having been roughly handled a time or two by a careless nurse, will more quickly cry and thrash about at the approach of this nurse, in the endeavor to escape a similar hardship, than it did before the rough handling.

Furthermore, a single-celled organism when brought in contact with an object which affords satisfactory food, after having had repeated experiences with such a satisfactory food supply, acts more quickly and effectively to avail itself of the food than it did on the first occasion of its contact. And a human infant, having been fed or petted by a nurse, will crawl and reach out its arms toward this nurse, in a manner which it did not do before.

Omitting for the time further illustrations, and exhaustive experiments by which the point is demonstrated, it may be said as a characteristic of all life-forms that they possess, in some degree, the ability to learn through experience. Such processes of learning the psychologists call **CONDITIONING**.

In general, just as I indicated in the case of the simplest organisms of earth, and of the human baby which becomes the most complex, the Conditioning produced by pain tends toward repulsion and the Conditioning produced by pleasure tends toward attraction.

Of all the processes of the human mind and body there is none more important fully to understand than that of **CONDITIONING**; because all progress and all regress are the result of such conditioning; and if we are to make satisfactory Progress we must make intelligent use of the Conditioning processes.

Not only is every stimulus of the external environment accompanied by a sense of feeling when consciousness apprehends it; but every action taken by the organism, and every mental process, likewise is so accompanied. This is merely another way of saying that each experience, whatever its nature, is accompanied by a sense of pain or pleasure in some degree. Feeling, in some measure, accompanies every state of consciousness. It may, or may not, be clearly defined as pleasure or pain; but the basic elements of attraction or repulsion are in some degree present. And it is this affective accompaniment of an experience which Conditions the organism in reference to similar experiences in the future.

Each experience—whether awareness of an external condition, a physical action taken, or a thought—adds the feeling, or Conditioning Energy which accompanies it, to the thought-cells of which the astral body is composed.

These thought-cells which comprise, in their various organizations, the substance and the structures of the four-dimensional body, are compounds of the various thought-elements. Like the protoplasmic cells of the physical body, each of these cells has an individuality and a consciousness. But in its effort to express this individuality, due to the freedom of activity inherent to the four-dimensional realm, it is far less limited than are the physical cells of the three-dimensional body.

As such a cell of the astral body is composed of thought-substances derived from one or more experience, this psychoplasm of which it is formed, in addition to the energy of the thought-elements embraced within the cell, also has associated with it the feeling, or Conditioning Energy, which accompanied the experience. In fact, this Conditioning Energy—the degree and quality of pleasure or pain—determines the manner in which the thought-elements combine; whether the compound is harmonious or discordant psychoplasm, and to what degree.

Such thought-cells, or stellar-cells, are brought together within the astral body through the operation of the Law of Association—Resemblance and Contiguity—to form the structures of the four-dimensional form. Yet coincident with the operation of the Law of Association further Conditioning Energy is present, and becomes associated with, and affords a particular kind of energy to, the dynamic stellar structures formed from aggregations of thought-cells. That is, when two groups of thoughts, or experiences are brought together in the mind, or astral body, their union into an organization, or structure, is accompanied by feeling. It is this feeling, or Conditioning Energy, which determines whether the structure formed, and to what degree, is harmonious or discordant.

Pleasure or pain, in some quality and in some quantity, enters into, and forms an essential part of the energy of, every thought-cell, every dynamic thought-structure, and every combination of that thought-built body the organization of which is more commonly termed the mind or soul. Thus it is that every such cell or organization of cells normally feels in a particular way; and with as much intensity as was originally imparted to it when it was formed. This feeling is largely an expression of the Conditioning Energy imparted to it at the time of its Formation into a compound, or into an organization of stellar cells.

Within every cell and structure of the astral body, therefore, in addition to the family energy of the elemental thoughts—Aggressive elements, Safety elements, Domestic elements, Power elements, etc.— of which the stellar-cell or stellar structure is composed, there is also Conditioning Energy. The type of energy expressed by a thought-cell or stellar structure, or by any complex organization within the astral body, is determined by the thought-elements within it. But the special trend of its activities, its more particular attractions and repulsions, is determined by the Conditioning Energy it possesses.

The expression of stellar-cells largely composed of aggressive elements, for instance, will always tend to be aggressive in their action. But whether that aggressive activity is turned toward one object or another, and whether its action is to the benefit of the individual or to his detriment, is determined by the Conditioning Energy with which they are associated.

Because every cell of the astral body, as well as every organized group of such cells, possesses energy which exerts an attractive or repulsive force, and as such attractive or repulsive force when recognized by consciousness is called Desire, in the broad sense we are strictly correct in saying that every thought-cell stellar structure, and combination of thought structures, within the astral body every organization within the four-dimensional form—possesses Desires.

**All Action is Due to the
Release of Energy Which
While Under Tension is
Called Desire**

—Furthermore, this energy of a thought-cell or of a complex organization of thought-cells, because of the nature of its thought-elements and the Conditioning they have been subject to, tends toward activities of a specific character. That is, Desire is energy in a potential state straining to be released in a given activity: to move the physical body, to acquire sustenance, to destroy an enemy, to realize love, to enjoy a certain sensation, or any one of the innumerable things that life-forms do.

To state the matter in still other words, Desire is energy which has produced a tension which seeks release in some activity. Thus every activity of the mind and body, great or small, is due to the discharge of the energy which while stored and straining rightfully can be called a Desire. Where there is no desire, therefore, there is no organic activity of any kind.

This means that when the desire energies stored within the stellar-cells and structures of the unconscious mind are provided with opportunity for release they express in three different ways:

1. Attracting the attention of objective consciousness, which connects them up with the electric energies of the brain, they give activity to thoughts of a similar nature. Our objective thinking at a given time is given its trend by the release of the desire energies of the stellar-cells.
2. Without our being conscious of the process, just as we are unaware of the processes of digestion and assimilation, the release of the desire energies of the stellar-cells enables these cells to work on the four-dimensional plane to attract events into the life which correspond to the way they feel. That is, whatever fortune or misfortune is attracted is due to the activities of thought-cells which find opportunity to express on the four-dimensional plane.
3. The releases of such energies are responsible for the stimulation of endocrine glands and for chemical and other changes within the body, as well as for our observed behavior. In other words, all our three-dimensional activities are due to the release of the desire energies of the stellar-cells of which the unconscious mind is composed.

Because, along with the energy of the thought-elements involved every desire also contains conditioning energy, or feeling, the release of the energy of any desire gives rise to feeling. To move a hand or foot the desire for such movement must first be present and build up a tension in the nerves to the point where they discharge electric energy in the form of nerve current. This results in the movement. But accompanying the movement is an affective condition, that is, a sense of feeling which registers at least in the unconscious mind and Conditions similar movements in the future.

Certain desires, however, are powerful enough that the discharge of their energy when the tension is released creates a profound and widespread disturbance of the nerve currents. These more violent desires are responses of the life-form to emergency situations. Some of these situations are: the call to conflict, stimulating anger; realizing inadequacy to handle a situation, stimulating fear; realization of loss sustained and consequent inadequacy, stimulating sorrow; belief that a fond desire will be realized, stimulating hope; realization of a fond hope, stimulating joy; the thought or presence of a love object, stimulating passion or love. Such situations demand that energies be present in more than normal volume. Hence the tensions are higher, quickly piling up energies which are released so violently that they give rise to those intense feelings which are termed EMOTIONS.

Laboratory psychologists, through experiments too numerous to cite, have demonstrated that every mental and emotional state, every thought, is accompanied by a definite change in the physical body. Thought-tensions, even those desires which have been repressed and are not recognized by the objective mind, give rise to corresponding tensions in the physical body. All the innumerable weak desires in the unconscious mind produce their physical effect; the stronger desires stimulating pronounced tensions in the nervous system.

In the case of those most violent of all desires, which are built up in the presence of emergency situations, the release of their energy—that is, an emotion—produces an immediate response from the endocrine glands of the physical body. The action of the chemicals then secreted by them cause the body to be placed on a footing suitable to meet the emergency. Even though the emergency has passed before it is recognized by consciousness, the thought of it when it is recognized may release the emergency energy of emotion, to be followed by glandular secretion and the whole complex of bodily response which is the Conditioned manner the organism reacts to the emergency.

As inducing milder desires it matters not whether the stimulus is a sensory impression from the physical world, energy reaching the thought-cells from the astral environment such as that from a certain planet, or is the result of a complicated process of thinking, it increases the tension of the thought-cells or thought structure within the astral body. Such a tension may be called a Craving.

If the tension is imparted to the nervous system in such a manner that objective consciousness is aware of it, it is recognized as a desire, or craving. Yet whether so recognized or not there is a straining of energies toward attaining some goal, and toward activities that have this goal for object. If action results, the energy that has accumulated under the impact of the stimulus is released from its potential state and becomes kinetic. That is, it is used up in the action. This relieves the tension and consequently the craving. Desire, or craving, is energy in a state of tension, and therefore the desire or craving is reduced. Desire tensions in the astral body reproduce themselves in the physical body through etheric energies; that is, they stimulate certain nerve cells to generate electrical charges, as explained in detail in lesson No. 64 (How to Think Constructively), causing a pronounced difference in electrical potential between different regions of the physical form. When the mental and electrical energy released from the tensions of a desire is unusually intense and of relative short duration, the emotion, such as anger, terror, despair, triumph or revenge is commonly called a PASSION.

If the mental and electric energy released from the tensions of a desire is complex and indirect, the emotion, such as honor or patriotism, is called a SENTIMENT.

When the energy released from a desire tension is more moderate in intensity, but of greater persistence, it is called a MOOD.

And should the energy released from a particular type or desire tension become so habitual and continuous as to dominate the personality, it is called the TEMPERAMENT of the person, such as sanguine temperament, suspicious temperament, optimistic temperament, or pessimistic temperament.

Thus it is that all expressions of any life-form— physical actions, feelings, emotions, passions, moods, sentiments and temperament— have back of them as their motive force a lack of satisfaction which gives rise to a tension which is called a Wish or Desire.

To state the matter somewhat differently, all organic activity is prompted, and accompanied by, Feeling. This feeling may be the response either to external environment or to the relation of mental factors. But in all cases much of it is Conditioned energy derived from previous experiences and stored in the stellar-cells and stellar structures. And before the activity takes place the energy thus stimulated, including the Conditioning Energy, builds up a tension. As soon as this tension becomes sufficiently high it spills over in activity of some kind.

This activity imparted to those electric impulses called the nerve currents stimulates muscular response, that is, physical movement, or glandular secretion. If the energy has thus been conditioned, it spends itself chiefly in stimulating some physical movement, accompanied by only a moderate amount of feeling. But if the energy has been conditioned to profoundly disturb the nerve currents, the physical response is largely that of the endocrine glands. These act in an extraordinary manner when the feeling released by desire has an intensity sufficient to warrant it being termed an emotion.

Conditioning Desires Is the Only Avenue to a Better Life

—Thus the type of activity expressed by any physical cell or physical organism is determined by the type of Desire, or tension, contained within the thought-cells with which it is associated. And the amount of activity expressed is determined by the amount of Desire, that is, by the degree of tension within the thought-cells with which it is associated.

Instead, therefore, of considering Desire as something inimical to human welfare, as certain Oriental philosophies do, the teaching of modern psychology is that Desire is the most essential asset possessed by any living thing. Without it there is no activity. Such activity as is expressed, is the expression Desire; and what is done, whether beneficial or the reverse, is determined by the manner in which Desire has been Conditioned. Therefore, there is but one possible avenue by which man can attain morality or live a life which is better in any respect, and that is not through eliminating Desire, but through the proper Use, or Conditioning, of his Desires.

Furthermore, the only manner in which, now or hereafter, man can markedly change his destiny in the direction of his choosing, is through appropriate modification and intensification of the desires of the stellar-cells and stellar structures in his astral body.

That he is commonly unaware of their cravings—or the way these organizations in his unconscious mind feel in reference to certain situations—does not prevent them from acting, with what intelligence they possess, from their four-dimensional plane, to bring into his life those events which they are conditioned to attract. Those thought-cells and thought structures that feel happy, desire only those things which are harmonious. But those thought-cells and thought structures which feel mean and discontented, work equally hard to bring into the life discordant events. It is the function of a birth-chart to map the most energetic of such thought structures in the unconscious mind, as they existed at the time of the individual's birth.

Every event that comes into the life is attracted to it through the activities of the stellar-cells and stellar structures within the astral body. Such activities are determined by the Desires of these stellar-cells and stellar structures. Some pull in one direction and others pull in another direction. The Desires of those in one department of life may release energy, when stimulated by planetary vibrations, that brings fortunate events related to this department. Yet the Desires of those in another department of life may be such that when stimulated to unusual activity they attract the direst misfortune.

The only way, therefore, that an individual can escape certain misfortunes is to recondition the Desires of those thought-groups in his astral body such as are mapped in the birth-chart by inharmonious planets, so that they no longer will feel discordant and desire discordant expression; but instead will feel harmonious and desire harmonious expression. When they have become so Conditioned as to Desire harmony instead of discord, the character of the individual—that is, his astral organization—will be changed in that respect, and instead of having misfortune in that department of his life he will experience good fortune. The stellar-cells and stellar structures in that department of his life will desire harmony, and will work from their four-dimensional plane of vantage to attract harmony.

To change to a more moral or spiritual type of living an individual must change, or Condition, the desires of which he becomes conscious so that their tensions find greater satisfaction in releases which make for such a higher life than in releases which permit the old type of living. The desires for living a finer existence must possess more energy than the desires for living more grossly. They must be powerful enough to overcome the coarser, or antisocial desires.

And to change the fortune in other respects, so that better conditions will be attracted, an individual must change, or Condition, the desires of the stellar-cells and stellar structures within his four-dimensional form, so that their tensions will find greater satisfaction in releases which attract fortunate events than in releases which attract misfortune. So long as their discord is sufficient to cause them to desire inharmony, will they attract inharmony from without; and the only way such misfortune can be avoided is to change them sufficiently that their desire for harmony is stronger than their desire for discord.

Whether to improve the quality of those external actions which form the conduct, or to improve the quality of events attracted into the life apparently independent of conduct, desires, which in either case are the basic qualities of the character, must be changed. The process of thus changing the stellar-cells and stellar structures so that the energy released by their desires will attract events more to the liking is considered in full detail in Course 9, *Mental Alchemy*, and also to some extent in Course 10, *Natal Astrology*.

Will Power is Directed Desire

—When the energies of strong desires are persistently directed to a given purpose, from which they refuse to be deflected, we speak of it as an exercise of will power. Will power is nothing more nor less than persistently Directed Desire.

If the will is to accomplish much, however, there must be something more than inflexibility of purpose. There must be energy available which can be directed to the accomplishment of that purpose. That is, there must be energetic desires. As the great French psychologist, Th. Ribot, in his monograph on “The Diseases of the Will” states: “An intense, stable, permitted passion is the very basis of all energetic wills.”

Speaking of such great men as Caesar, Michelangelo, and St. Vincent de Paul, Ribot continues: "Their fundamental element is a mighty, inextinguishable passion which enlists their ideals in its service."

The highest type of Will is thus exhibited when there is a single aim in life, toward which there is an intense and enduring passion that will permit of no distractions. Such is found in all great men, and is the force behind their greatness.

For the most pronounced results the desires must have available energy, and must not be scattered. They must converge and coordinate to a single purpose. Such a convergence of desires to one end is present when the mind becomes dominated by some great and permanent passion. The one great passion enlists all minor desires in its service. As circumstances change, means are changed, minor desires are given play and bring about successive adaptations to environment, but ever they are subservient to the Dominant Desire of the life.

The greatest problem confronting every human life is that of intensifying the desires and directing them into the most beneficial and effective channels. If the desires are weak, there is not sufficient energy to carry to completion any worthwhile project. But no matter how strong the desires may be, if they are divided, pulling in opposite directions, or pulling in directions away from worthy accomplishment, the life will fail to make the attainment it should. Let us, therefore, again briefly consider the source of desire, and then, with this source clearly understood, move on to a consideration of the methods to be employed in directing it to predetermined ends.

Already it has been shown that desire was developed by the soul as the energy through which it moved toward or away from a condition in its environment. Those conditions it felt to be pleasurable it had a tendency to move toward, that it might gain their benefit. And the energy of this tendency, whether simple or more complex, was an ATTRACTIVE DESIRE.

Those conditions the soul felt to be painful, it had a tendency to move away from, that it might escape destruction. And the energy of this tendency, whether simple or more complex, was a REPELLENT DESIRE.

All the actions of life, including even the manner in which thought-elements combine in the stellar-cells of the astral body, and the way the stellar-cells unite in groups to form stellar structures, are CONDITIONED by pleasure or pain. That is, the energies of the thought organization of the astral body, as well as the movements of the physical organs and the actions of the body as a whole, are directed by the releases of energies which, while under tension we call desires. To the extent they are CONDITIONED by pleasure they cause action in one direction; and to the extent they are conditioned by pain they cause action in the opposite direction. PLEASURE is always ATTRACTIVE. PAIN is always REPELLENT.

We do the thing which at the moment is most pleasurable to us, or is at least less painful. It may be, however, that our objective mind registers only pain. Yet the very fact that we are urged on to a given act implies that within our unconscious mind there are elements that get more pleasure from this course of action than the amount of pain objectively recognized. When a patient goes under the operating knife, he may be conscious only of pain. Yet within his unconscious mind there is a mental group that gets more pleasure in the effort to save his life than the pain he experiences in the surgery.

Every thought-cell, at the time it is built into the astral body stores up the pleasure or pain which was coincident. Every organization of such thought-cells contains the pleasure or pain coincident with its formation. Thus within the unconscious mind are a vast number of experiences, simple and complex, which have **CONDITIONED** energies which now persist as those tensions which we know as desires.

Yet because strong simple sensations are those which the soul has had the longest experience recognizing, and which it developed specifically for the purpose of directing its conduct, these are the most powerful to build desires. To put it another way: the amount of Conditioning Energy a desire contains is proportional not merely to the duration of the feeling accompanying it, but also proportional to the intensity of the feeling.

The general rule is that the farther we get from simple sensations the less intense the feeling experienced. Ribot voices the findings of experimental psychologists when he says: "We have seen that the more abstract ideas are, the weaker their motor tendencies."

In lesson No. 57 (*Reason and Intuition*) I have indicated that sensations fuse to become perceptions and that perceptions fuse to build conceptions. Abstract ideas, therefore, are the farthest of all removed from simple sensations. That is, the amount of feeling they contain is negligible.

The number ten, for instance, is an abstract idea. Few people feel any enthusiasm, either for or against the number ten. It gives neither pleasure nor pain. It has, ordinarily, no tension associated with it in the astral body, such as we call desire.

Now let us take the idea of loving all mankind. There have been many experiences with individual members of mankind which have given pleasure or pain. The images in our unconscious mind, however, embraced in the idea of mankind, are not all pleasurable. Some of our experiences with mankind have been distinctly painful. Mankind, therefore, as an idea, embraces some **ATTRACTIVE DESIRES** and some **REPELLENT DESIRES**. Yet love is essentially an Attractive Desire. You may act benevolently toward that which causes pain. Only to the extent the image releases desires which have been built by pleasure is love possible.

It is folly to try to escape that law of nature which modern scientific psychology phrases: "Man is led by his feelings alone."

Why shouldn't he be led by his feelings? That is why feelings were evolved by his soul. When people try to act against their feelings they are attempting the impossible. What they should do instead, so that their actions may be controlled by wisdom instead of by blind impulse, is to properly train their feelings. When their feelings are properly conditioned their actions will take the proper course as a result of the operation of this natural law.

General ideas, like that of loving all mankind, are too vague. They do not contain the proper sensory elements to give them motive power. Furthermore, where mankind is concerned, some of the images contained in the composite give rise to feelings the very reverse of love. Then, again, how often we see people who with intellectual honesty condemn a vice or passion, yet themselves are unable to renounce it!

The difference between recognizing right and practicing it is so great as to have become proverbial. The mere intellectual conception lacks sufficiently in sensory elements to enable it to build strong desires.

It is the function of Wisdom to decide the direction in which the life should move. And when that direction is recognized the next step should be to build desires for such movement which are strong enough to absorb the energy of other desires, or at least which are strong enough that they can override any opposing desires. When such desires become strong enough, the actions will inevitably be in the direction dictated by Wisdom.

As all the desires which already persist in the thought organization of the astral body have been **CONDITIONED** by pleasure or pain it is obvious that the method to be employed in the conscious building of those desires decided upon is also to use pleasure and pain. Pain is repellent. A feeling of fear, for instance, may prevent the continuation of some action which had become habitual. But pain also adds discord to the stellar-cells and stellar structures which tends to attract future misfortune, so that its employment in the building of desires should be with utmost discretion.

Pleasure, however, is attractive, and in addition tends to the organization of the stellar-cells of the astral body into harmonious, and fortune-attracting structures. In the building of desires it is the chief agent to be recommended. Through its judicial use, any possible course of conduct may be **Conditioned** to yield pleasure, and, therefore, to possess strong motor tendencies.

As I have indicated, numbers are abstract ideas, pure and simple, and of themselves are not associated with desires. Yet, through **ASSOCIATION** with desires that have strong sensory elements, they may be made to possess intense motor tendencies. We all are acquainted with people, no doubt, who have a veritable passion for mathematics. If we follow the steps by which such a passion developed it will also reveal the general method of **CONDITIONING** by which a liking for anything can be cultivated.

The desire for conquest (Aggressive Urge) is one of the most primitive desires. When an organism was faced with an obstacle or opponent there was pain. To escape the pain it sought to overcome the obstacle or to vanquish the opponent. When it was successful in doing this it experienced a feeling of exaltation. In time the pleasurable feeling of exaltation in vanquishing opponents or obstacles developed to such an extent that difficulties that could be overcome were a source of pleasure. Both people and animals, even though injured in the encounter, may love to fight.

It gives almost everyone a sense of satisfaction to be able to do something better than others do it. Directed thinking is painful. And the solution of a mathematical problem requires directed thinking. Yet if the youngster in school finds he can solve a problem that a fellow student cannot, and particularly if he is praised for his success, this gives him pleasure. In this case not only his Aggressive Urges find pleasure in conquest, but his Power Urges gain satisfaction; for he is made to feel superior to other students.

Each new conquest in the realm of mathematics brings with it self-approbation, the increasing esteem of others, and a corresponding feeling of exaltation. And it is not long before the youth finds no recognizable pain in the working of mathematical problems. He becomes so Conditioned that he likes such work. And if he continues thus to Condition himself he may develop a veritable passion for what others regard as dry figures.

Let us not suppose that Sir Isaac Newton had a spontaneous attachment to numbers. It is true that both Mercury and the Moon in his birth-chart were in close aspect to Mars, indicating natural mathematical ability. But his early life was such as to cause him to get pleasure from the exercise of this ability.

Later the falling apple spontaneously attracted his attention and set up a train of Fantasy Thinking. He wondered why the apple did not fall up instead of down. This stimulated his desire for conquest. To accomplish this conquest it became necessary to develop higher mathematics. The solution of every problem gave him a glow of triumphant emotion. Each new conquest added its quota of pleasant feeling, increasing the power of the desire, until it became a veritable passion to conquer the whole universe through the application of mathematical methods.

What made the life of Abraham Lincoln possible?

Biographers tell us that early in life he had a great love followed by a great sorrow. He was intensely in love with Ann Rutledge and they were to be married. He was called away and before his return she died. He wept his heart out upon her grave and nearly died of grief. But after a period in which he was beside himself with anguish he succeeded in transferring this love from its special object to mankind as a whole. He never forgot his first love, and often, even in later life, revisited her grave. But in every human being he saw a resemblance to this earlier love, and because of the association, he could express that kindness, sympathy, affection and patient protection toward all that he first felt for the single object of his affection.

Properly Directing Desire

—When Wisdom has decided upon a course of conduct, it is utmost folly to try to drive yourself to follow this course. You cannot make yourself love all mankind. You cannot make yourself love anyone. You cannot make yourself a moral person. If you are a moral person it is because you take pleasure in doing right or fear to do wrong.

Instead of driving yourself to the decided course of action, the proper method is to set systematically to work to associate as many pleasurable feelings with this course of action as possible. Within yourself already have been built strong desires. These strong desires can be linked with the decided upon course of action in such a manner that their energy can be used in it.

Every family of thought-elements can express either constructively or destructively, and it is not difficult to cultivate as much of a glow of pleasure out of its constructive use as out of its destructive application. That is, it is easy to divert a given desire into a channel which will enable its energies to express their essential quality in a constructive manner.

And an appeal can be made to constructive expression of these desires which already have been strongly built into the astral body, in association with a decided upon course of action, so that their energy goes into the course of action, and lends pleasure to that course of action. If you have become accustomed to derive pleasure from the exercise of Intelligence, this Intelligence can be employed in the course of action. If you find pleasure in fighting, recognize this course of action as an opponent to be overcome. If you get your greatest pleasure from sex, associate the idea of the course of action as in some manner contributing to sex pleasure. Many a man has made a success of his life because he was in love with his wife and felt that his success would bring her pleasure.

It may be that the Urge for Power is strong within you, or the Urge of Domestic felicity, or the Individualistic Urges, or the Urge for Safety, or the Urge for Utopian Conditions, or the Urge for Universal Welfare. But whatever it is that gives you great pleasure is a source of energy. It represents an organization in your astral form possessing powerful desire. And through keeping before the mind the method by which the course of action decided upon can be made to contribute in some way to the realization of this powerful desire, its energies can be diverted into the channel of the decided course of conduct.

Before the electric current is present to run our industries there first are drops of rain, then the trickling rivulets, and the rushing torrent. Before altruistic effort of value there must be sensations, simple desires, a dominant passion, and finally—as the energy of the torrent is transformed into electrical power—artifice, ASSOCIATION, must be employed to direct the whole current toward a more complex end.

To permit the river to run its own wayward course is to waste its energy. To permit passion to expend itself in spontaneous gratification is to waste the vital essence of life. But to make it constructively available we must know how to use it. Merely to say, ‘I will to do good, I will to love mankind, I will to serve my fellowman, I will commit no sin,’ is about as effective as to say to the river, “I will that you shall run the industrial plants in yonder city.”

There must be knowledge how the current can be transformed and directed, and this knowledge must be applied. And, if life is to yield high accomplishment, there must be knowledge how, by artifice, the primitive impulses may be diverted into a more useful work than sensual gratification. Furthermore, this knowledge must be put into practice.

If I wish to love mankind I must learn to love some one or more persons—wife, husband, father, mother, child, friend, or acquaintance—ferently, so that when the generic thought of mankind rises into my consciousness it will have attached to it the lovable qualities of this familiar individual. I must scan every person I meet to find some admirable quality which I can love; and I must never permit the thought or image of any person’s repulsive qualities to remain an instant in my consciousness.

Why are there man-haters and woman-haters? It is because in every such instance the hater has met with disappointment in some member of the opposite sex. The whole generic concept of man or woman, as the case may be, consists of a composite image of experiences with individuals. Each experience adds to the quality of the generic concept according to its intensity. When grief of sufficient intensity, caused by one member of the sex, is added to the generic concept, the whole concept becomes dominated by pain. Every person of the sex which caused the grief is associated in the mind so closely with this painful image, that, because the one man or woman who caused the pain is hated, this hatred is transferred to all.

It will now be apparent that morality, as well as other desired characteristics, can be attained only through the cultivation of appropriate emotions. To annex some quality to the character, associate with it as many pleasurable sensations as possible. But do not dwell on the painful quality of that which is to be eliminated. To think of a characteristic feeds thought-energy into it. This is the real secret of the Biblical admonition, “Resist not evil, but overcome evil with good.”

As specific example, to cultivate truthfulness whenever the truth is told in spite of the temptation to falsify, as soon as opportunity presents, take time to gloat over the victory. Permit the feeling of pride to find full satisfaction. Think of those who are loved for their truthfulness. Think of how you will be admired if you continue truthful. Think as vividly as possible of as many pleasurable experiences as you have had in connection with truth telling.

Feel intensely about the matter, and should the desire for falsehood enable it to gain the victory, put it aside as of no moment, and never permit the painful emotions—shame, remorse, despondency—to rise into consciousness. Consider this but a single blow struck by the adversary in life's battle for character. A brave man cares nothing about one slight wound. Divert all the mental forces into feeling love for truth. It is the object to be gained at all cost, and one should not expect to win an important battle without some small loss.

By developing pleasurable sensations and emotions in their construction, any traits of character can be formed, and these by virtue of the energy they release, automatically dispossess their opposites.

Chapter 5

Serial No. 60
Original Copyright 1937
Elbert Benjamine

Copyright
Church of Light
August 2002

Why Repression is Not Morality

Chapter 5

Why Repression Is Not Morality

MORALITY is a particular kind of conduct. And as all conduct is the product of energies released and directed by desires, morality must depend upon desires which have sufficient energy at their command to overcome all other desires which tend to release their energies in the direction of immorality. Any comprehensive knowledge of how morality can be attained, therefore, must reveal first, just what line of conduct is truly moral, and second, how desires can be established which have at their command energy enough to overcome opposition, and that release their energies in the direction of such moral conduct.

Because desires and their energies, biologically speaking, are much older than morality, it seems better first to consider in some detail the ten families of desires present in every human being the energies of which, in various combinations, must enter into special channels of release if man attains to that which he calls morality; Then we can take up the practical details of diverting these energies into chosen channels; and reserve for another lesson a discussion of what those channels should be if they are to serve truly moral interests.

POWER URGES

—The oldest of all desires is the desire to survive and to be something. It is the driving force behind every soul, which impels it to struggle on, ever striving, even though blindly, to fulfill the destiny mapped for it by its ego. This desire for significance is the most deep-seated of all, and laboratory experiments in psychology demonstrate that so long as life lasts the soul will not relinquish it. The soul will relinquish any other conception, even that of physical survival, or that of the survival of offspring, sooner than relinquish the belief that it has some importance in the scheme of things. That this belief is grounded in fact is set forth in Lesson No. 56 (*Doctrine of Esoteric Psychology*).

In connection with the development of morality, and in the handling of desires and their energies for other purposes, it is essential to remember that the soul never can be made to admit its own insignificance, and that of the thought-cells embraced in the dynamic stellar structures of the astral body where are stored those energies that constitute the various types of desires, those for significance are more powerful than any others. They have been in existence longer, and have had added to them the energy of more experiences. To enlist them in any given cause, therefore, is to acquire a powerful ally. The family of thought-elements that express as the desire for Significance is called Power family. The dynamic stellar structure in the astral body the thought-cells of which are chiefly composed of these Power-elements is mapped in the birth-chart by the Sun.

The Three Hereditary Drives

—Desires which are so strong that their energies cannot be repressed or held in check, but are sure to find an outlet through some channel, may appropriately be called Drives. And this Drive for Significance not only is the oldest and most powerful of all, but is the evolutionary source of all the thought-elements, just as it is held by some that the Sun is the parent of the various planets. It is, at least, the center about which they swing. And this is the strongest of the three hereditary Drives.

The desire for Significance, as well as the electrical charges that comprise an atom of matter, expresses as a positive and a negative. Protons and electrons are the factors of which all elements of matter are composed; and Reproductive Desires and Nutritive Desires are the factors of which all the mental elements are composed. Significance can release the energies of its desire either in expressing outside of the form it occupies—as a Reproductive activity which is the positive expression—or in expressing inside the form it occupies—as a Nutritive activity, which is the negative expression.

Because these two primitive trends, the one positive and the other negative, enter in different proportions into the composition of all the ten thought-elements—even being embraced within the parental Power Urges—they do not attain the dignity of being called mental elements. Rather they are mental protons and electrons. Yet next to the Power Urges which fathered them, they are the oldest mental factors, and the most deep-seated.

Self Preservation in all its various aspects is an expression of the Nutritive Desire. And because it's so deep-seated and powerful that it cannot be prevented from finding some outlet, having been added to constantly since the soul first commenced its cyclic journey, it may be considered as one of the three Hereditary Drives.

The other Hereditary Drive is that which in its various aspects is an expression of the Reproductive Desire. Only those forms of life exist on earth today whose reproductive desires have become strong enough to overcome all inhibitions and all obstacles. When the drive for self-preservation is weak the individual fails to survive and his strain dies out. When the drive for Race Preservation is weak the individual either fails to leave offspring, or if he does reproduce the strain, he so poorly provides for them that they perish. Thus since life on earth began there has been a constant weeding out of those forms of life that had nutritive desires so weak they failed in Self Preservation, and those that had reproductive desires so weak they failed to leave, and properly provide for, their progeny.

In various combinations these two primitive mental factors, Nutritive Desires and Reproductive Desires have entered into the construction of and have built up all those more specialized mental factors which are termed elements. That is, just as there are chemical elements which combine to form the protoplasm of the physical body; so there are mental elements which combine to form the psychoplasm of which the stellar-cells and stellar structures of the astral body are composed. And these mental elements in turn are built of Nutritive and Reproductive Desires.

Bearing in mind that each element of the ten Families contains not merely one of the simpler types of mental factors, but both Nutritive and Reproductive, although in different proportions, let us now consider briefly how such elements have been formed. But in so doing, because Nutritive Desire and Reproductive Desire are technical terms, it will probably make the matter clearer if instead of Nutritive Desire we speak of the drive for Self Preservation; and instead of Reproductive Desire we speak of the Drive for Race Preservation.

Domestic Elements

—On the side of Self Preservation, if the form is to persist it must have sustenance. Nutrition is essential to the continued well being of the form. On the side of Race Preservation, a home for the offspring, food for them, and ministering to their various needs is essential. Through such experiences were formed and built into the astral body those mental elements called Domestic. The dynamic stellar structure in the astral body the thought-cells of which are chiefly composed of these Domestic elements is mapped in the birth-chart by the Moon.

Intellectual Elements

—Even the lowest form of life finds intelligence, of whatever degree it is able to manifest, an advantage to it in Self Preservation. Survival depends upon ready and adequate adaptation, and intelligence is the greatest aid to such adaptation. It is no less valuable in procuring a mate, and in insuring that the offspring shall be properly provided for. Race Preservation is more certain to those individuals that exercise

intelligence than to those that do not. It is through experiences in the exercise of intelligence, both to preserve the self and to preserve the race, that those mental elements were built into the astral body called Intellectual. The dynamic stellar structure in the astral body the thought-cells of which are chiefly composed of these Intellectual elements is mapped in the birth-chart by the planet Mercury.

Social Elements

—Creatures that band together often are more secure from their enemies than those that live solitary lives. Fish in the sea, birds of the air, antelope on the plains, and even many plants find close association an aid to Self Preservation. And it is the rule that Race Preservation requires the members of opposite sexes to mingle. Such experiences when they enter the astral form become those mental elements known as Social. The dynamic stellar structure in the astral body the thought-cells of which are chiefly composed of these Social elements is mapped in the birth-chart by the planet Venus.

Aggressive Elements

—All creatures are subject to attack and invasion. All creatures, likewise, are confronted by obstacles. Self Preservation is aided by the ability to repel invasion, to destroy the enemy, and to use initiative in the attack on obstacles. The ability to defeat an opponent in the struggle to secure a mate, the courage to battle for the welfare of the offspring, and the initiative to face difficulties for the sake of the progeny, all are aids to Race Preservation. It is through such experiences in combat, in construction and destruction, and in the courageous attack upon obstacles that those mental elements were built into the astral body called Aggressive. The dynamic stellar structure in the astral body the thought-cells of which are chiefly composed of these Aggressive elements is mapped in the birth-chart by the planet Mars.

Religious Elements

—The confidence of the members of a group that their wise and more experienced leaders will provide for emergencies, and that they need only have faith in that leadership, is a decided aid to Self Preservation; as is also the spirit of tolerance and good fellowship which prevents destructive strife from being a constant menace. And the confidence of the young that their parents will provide for their needs, and that the parents should be obeyed because they are benevolent and wise, is an aid to

Race Preservation. It is through experiences with such faith and such good fellowship, and the effort to seek the favor of others and of the ruling authority, that those mental elements were built into the astral body called Religious. The dynamic stellar structure in the astral body the thought-cells of which are chiefly composed of these Religious elements is mapped in the birth-chart by the planet Jupiter.

Safety Elements

—All life-forms are beset with dangers. The ability to escape from enemies, to avoid harmful conditions, and to provide for security is an essential if the individual is to survive. It thus is a necessary asset to Self Preservation. The young also need to be kept away from enemies and from destructive conditions. Providing security for the young is a necessary asset to Race Preservation. And it is through experiences which have sought the escape from danger and the attainment of security that those mental elements were built into the astral body called Safety. The dynamic stellar structure in the astral body the thought-cells of which are chiefly composed of these Safety elements is mapped in the birth-chart by the planet Saturn.

Individualistic Elements

—Conditions are in a state of constant flux. The old way of doing things may suffice for a while; but the ability to depart from the conservatism of the past, to do something that has not been done before, in time becomes an assistance to survival. This departure from the common methods of the race thus lends itself to Self Preservation. Not only is it valuable to invent better ways of doing things for the self, but the development of better ways of caring for the young, and better ways of handling conditions that affect their welfare assist in Race Preservation. It is through such experiences, in which the individual had departed from customary practices and had acted differently from the other members of his race that those mental elements were built into the astral body called Individualistic. The dynamic stellar structure in the astral body the thought-cells of which are chiefly composed of these individualistic elements is mapped in the birth-chart by the planet Uranus.

Utopian Elements

—All creatures, in addition to their external life, also have experiences in which the unconscious mind is somewhat dominant. We cannot say that plants dream, although we are sure that dogs and some others of the higher animals do. But even the lower forms of life draw from their inner, astral experiences. Vague yearnings for better conditions for themselves and their race. The feeling that finer things such as they sense on the inner plane are possibilities of attainment. Such forerunners of that

which we call ideals assist Self Preservation through the instinctive search for more pleasant relationships. And they aid Race Preservation through the success, in some measure, of the individual in realizing these finer relationships, and leading others of his kind into similar realization. It is through such experiences, largely filtering through from the inner plane, in which there has been an effort to externalize the yearning for a higher kind of life that those mental elements were built into the astral body called Utopian. The dynamic stellar structure in the astral body the thought-cells of which are chiefly composed of these Utopian elements is mapped in the birth-chart by the planet Neptune.

Universal Welfare Elements

—Cooperation between the individuals of a species helps all to survive and thus assists Self Preservation. Through cooperative effort, in which specialization of parts and division of labor are possible, we gain the highest types of organizations. The human body is such an organization of cells and organs. A modern industrial plant attains mass production with possibilities of low costs and high wages through such cooperative effort. Social insects, such as ants and bees, are outstanding examples of this spirit of cooperation. And as that which gives advantages to all, helps the young as well as the adults, cooperation is an aid to Race Preservation. It is through experiences in which cooperation of some kind has been practiced that those mental elements were built into the astral body called Universal Welfare Urges. The dynamic stellar structure in the astral body the thought-cells of which are chiefly composed of these Universal Welfare elements is mapped in the birth-chart by the planet Pluto.

The LAW of ASSOCIATION Operates through Energy Relationships Established Between Mental Factors

—As these various mental elements were built into the stellar-cells of the astral body, they were CONDITIONED by the pleasure or pain accompanying the experience which gave them origin. Their energies were under tensions which tended to release in certain channels and not in others. That is, each stellar-cell acquired in some degree, Conditioning Energy, such as commonly we call Desire.

Other experiences of a more complex nature, including mental experiences as well as those more directly derived from environment, ASSOCIATED certain stellar-cells into a thought-structure. This process was also accompanied by Feeling which gave to the organization so formed further conditioning Energy, or desire. The dynamic stellar structures in the astral body, such as are mapped in a birth-chart by the positions of the planets are the most highly charged of all with such Conditioning Energy. That is, they contain the most energy under high tension, and therefore indicate the most energetic desires within the individual's astral form.

The relations between various thought-cells and various groups of thought-cells are as numerous as the experiences of life itself. Where there is Resemblance between two experiences, no matter where individually they may have built mental elements or more complex structures into the astral body, that Resemblance when recognized—because Resemblance is the recognition of kinship in Feeling—is an energy relation between them. Things which are Contiguous either in time or space enter consciousness together—are likewise associated through an energy relationship, no matter how far removed from each other they may be in the astral body.

When an act has been performed in a given way, the thought-cells and stellar structures have made that act possible through the release of the energies of their desires. Those stellar-cells and thought structures responsible for the act have been united in a particular way so that their energies have been released in a given sequence. This fact, that their energies have been thus released in a certain type of action ASSOCIATES them in this manner and permits the energies of their desires to find more ready release over the line thus established than through some other channel, the associations of which have not yet become established.

Anything done once, through the principle of Contiguity, establishes definite energy relationships between the mental factors involved. And the more often it is done, the stronger becomes the energy relationship between these mental factors. All habits are formed through such energy relationships between the thought-cells, thought structures, and dynamic stellar structures of the astral body.

At sometime in the past the thought-cells and stellar structures have learned how to handle the chemical elements that build up the physical form, they have learned how to construct the various glands and organs of the body, how to provide for secretion and assimilation, and all the other innumerable processes that are not directed by objective consciousness.

These processes, like that of walking, were learned little by little, as the desire of the stellar-cells and thought structures found channels of expression that favored survival. Yet when any such channel—energy associations between thought-cells and thought structures that permitted their desires to express—was once established, it became the easiest conduit for such energy release, and the process became habitual.

Each organism is a collection of habit-systems, and the significant thing is that once the energies of desires have established a channel of release, because to break a new path is painful, they resist the effort to make them express through another avenue for which as yet they have no precedent.

A noted biologist says: "If it were possible for a given period of time to compare in humanity, taken as a whole, the total number of acts produced by voluntary attention with the total number of those produced without it, the ratio would be nearly as zero to infinity."

What is character, upon which we so pride ourselves? It is the organization of the thought-cells and thought structures of our finer form which gives rise to our habitual mode of thought and expresses outwardly as our habitual actions.

What is that which we so admire and call genius? It is habitual facility of execution.

Do you think that difficult music could be played if the conscious volition must be directed to each little action? Certainly not. Each little movement is learned separately, and the thought-cells responsible for it thus associated with other thought-cells governing other movements, the whole forming a chain of desire-release set off by the proper stimulus. Once the chain of thought-cell association has been established no attention need be paid to such separate movements. The volition—directed desire—merely gives its attention to playing the whole piece, and thus serves to connect up the releases of the various desires in the thought organization of the astral body so that their energies can flow through their habitual channels of expression.

Thus it is also with morality. Once we have determined what actions are moral and what immoral, it is but a matter of establishing habit-systems which release the energies of our desires in moral actions, each learned one at a time and separately, and gradually associated with the volitionally directed desire to be moral.

The difficulty to be encountered in such a method is that so many channels of energy release have already been established that the desires find it vastly easier to express through these less civilized channels than through those which wisdom teaches are more advantageous.

Within our astral bodies are tendencies built into it in forms of life lower than the human. Those that actuate the spider, the monkey, the tiger and the snake all are there. But gradually the desires which actuated these creatures have been taught to release their energies in more acceptable ways. When food is in sight the more primitive desire is to grab it. Yet civilization says it may be procured only in certain ways. If it belongs to another, civilized desires require that it be purchased, or in some manner obtained only with the other person's consent. This does not mean that the energy of the desire to grab food is no longer present, merely that it has been Conditioned to flow through a different channel of release.

In fact, life advances, step by step, through finding better channels of release for its energies than those which previously were habitual. There is a vast difference, however, between diverting energy into a new channel of flow, that is, into a new chain of associations, and in repressing it.

What happens to the rivulet flowing down the mountain side if the attempt be made to repress its flow? Like the gross and sensual desires that persist within the astral form of every man as a heritage from his animal past, the rivulet is there and cannot be obliterated. It cannot be made to run back up the mountain. Nor can the primitive desires of man be made to flow back to their source. The most that can be accomplished in either case is to dam up the stream. But when so dammed up it inevitably rises until at last it breaks the dam or spills over the top.

The old Mississippi steamboat captains, during a race, used to hang a monkey-wrench on the safety valve. This worked very well for a short time. But if they thus kept the valve closed too long, the engine blew up. Many a fine steamboat found a river grave because its captain failed properly to estimate the pressure the engine could stand. And most of the ills which neurologists and psychoanalysts treat likewise have risen from the efforts of people not to find some more acceptable release for the desire tensions within their astral bodies, but to completely block such energies from finding egress.

Any desire which acquires sufficient energy is in a position to defy efforts at blocking its expression. Certain experiences in human life may so charge a group of thought-cells with the Conditioned energy of emotion, that they gain such power. But the three Hereditary Drives have acquired that power through the energy added to them before birth. No one can prevent the Desire for Significance, the Desire for Self Preservation and the Desire for Reproduction, from releasing their energies. When their energies are confined over a period of time, and they find no other avenue of release, they perform as did the steam in the old river boats, they wreck the whole concern.

These old steamboats when the monkey wrench was hung on the safety valve did not always blow up. Sometimes seams gradually opened so that the steam found a devious outlet before the pressure became too great. And likewise the pressure of repressed desires, not finding other outlet, may seep into expression through neurosis, psychic instability, and peculiar quirks of character.

Let us here take for granted, that which there is a vast clinical data to prove, that no one ever successfully prevents the energies of the three Hereditary Drives from finding expression. But this does not mean that these desires do, or should find expression through channels which are primitive or immoral, although it is true that all three are based on animal impulses which expressed in the animal way are socially unacceptable.

The Drive for Significance, on the plane of the animal soul has no regard for the rights and feelings of others, and cares not what it destroys so long as it gains in selfish power. Rule or ruin is its natural outlet. Yet on the plane of the divine soul it finds complete satisfaction in the feeling of importance attained whenever it contributes to the welfare of others. Significance in the realm of man is measured, each according to his own standards, in terms of human relationship.

The Drive for Self Preservation, on the plane of the animal soul has no consideration for the rights and feelings of others. A dog or a cat, having more than it can eat, nevertheless, will guard the excess Food so that no other animal, no matter if it is famishing, can secure it. And if it is strong enough, it will drive other creatures from food which they have secured and need, and which is of no benefit to it. Yet on the plane of the divine soul the same impulse can, and does, find satisfactory expression in providing for the welfare, here and hereafter, of others. In a society where all are taken care of and which is progressing to higher states, its own security and opportunity is greater, and the effort to be helpful to others builds into its finer form those thought-vibrations which insure its progress in realms of the future.

The Drive for Race Preservation, on the plane of the animal soul tends to the baser expressions of the sexual impulse, in which lust is dominant, promiscuity is the rule, and there is no thought of tenderness or the well being of the sexual object. Yet creative expression of all kinds, such as art, literature, drama, invention, engineering, and other constructive effort, is an expression of the Reproductive Desire, which is the chief avenue of egress for the Race Preservation Drive. On the plane of the divine soul, therefore we find that this impulse gives rise to tenderness, to fine affection, to exalted love, and finds adequate satisfaction in creative activities which have for their object the delight of the loved one and the welfare of the race.

There may be other desires that, through special circumstances, have become endowed with enough energy that they can not be prevented finding a characteristic outlet; but the energies of these three Hereditary Drives always are sufficiently strong that they markedly express in spite of any attempt to hang a monkey wrench on the safety valve.

Repression

—Civilization has developed certain standards of conduct which it imposes on all its membership. From infancy the child is taught, and comes to believe, that whenever it departs from these conventional standards, and to the extent it so departs, it becomes an inferior being. The esteem of others, and the esteem of itself, depend upon its following the line of conduct which it has been taught to believe is the only moral one. And as it gains Significance only through self esteem, which usually in turn is largely dependent upon and measured by the esteem of those by whom it is surrounded, and as this desire to express Significance is the strongest of all Drives, powerful desires are built up to follow the conventional standards.

Because he believes that certain actions denote an inferior being, and because his Drive for Significance does not permit him to become such an inferior being, he builds up desires which are powerful enough to prevent these actions. Commonly the individual finds considerable opportunity to express the desire for Significance in the field of such accomplishment as is acceptable to conventional standards. Commonly also he finds opportunity to express the Drive for Self Preservation through working for a living, or in other ways providing for financial demands. But in the matter of the expression of the Reproductive Desires—Race Preservation—the teachings from his childhood often have built desires of a kind that oppose themselves to all expression.

His religion and his associates have led him to believe that sexual impulse is prompted by the devil, or at least is a sign of degeneration. So much emphasis has been placed by society upon sex that when the newspapers announce that some person has been guilty of immorality or that a moral charge has been brought against someone, it is always accepted that it has to do with sex. A stranger on our planet, reading the papers, might conclude that murder, arson, theft, and burglary were not considered particularly immoral, but were minor offenses compared to sexual misconduct.

Thus many individuals are raised in an atmosphere which adds so much energy to those thought-cells that oppose their desires to the Reproductive Desires, that these conventionally conditioned thought-cells are able to prevent the energy of the Reproductive Desires being recognized by the objective mind. The individual convinces himself that he has no such base impulses. He has no thought of sex, because he is a superior being, and all sex impulses are nasty. Other people may have such gross desires, but not so superior and moral a person as himself.

When a powerful desire is thus opposed by a contrary powerful desire to the extent that its recognizable expression is completely blocked, it is said to be repressed. Other desires—particularly the desire for Significance—can be, and often are, thus blocked, and exist in a state of repression. But the most common one to be repressed, and therefore the one that gives the psychiatrists the most work, is the Reproductive Desire, because it commonly finds more opposition to its expression.

Repression, however, does not prevent the energy from finding escape. The person has merely built other desires which hypnotize him into the belief that the repressed desires have no existence. They cannot find expression through the avenues of their original tendency because the censorship desires—those stronger desires opposing them—are too powerful to overcome. But after they are held back until they accumulate sufficient energy they do one of two things, they either find seams in the boiler through which their energy escapes, without being recognized by the censor, or they blow up the ship.

Psychoanalysis was developed to discover these repressed desires, and to release their energies through less destructive channels. All the various kinds of neurotic complaints which are relieved by psychoanalysis are expressions of repressed desires which finding no normal or constructive outlet, dodge the censorship desires, and express themselves under symbolic disguise.

This being widely recognized through the investigations of Freud, Jung, Adler and their host of followers, and proved by a whole library of clinical data, let us next consider the three methods by which the energy of such powerful desires can be released.

Three Methods of Desire-Energy Release

—First, of course, the energy of a desire when not too strongly opposed by other desires, finds expression through carrying into action that which the tension craves for satisfaction.

Second; when the desire energy is repressed it always finds some substitute channel of expression. What it is not permitted to do in one direction it COMPENSATES for by finding a subterfuge outlet in which its activities are permitted. Because such COMPENSATION activities are unrecognized as to their source by the objective mind, they are not controlled by it. Hence, more often than not, they are highly inimical to the welfare of the individual, and at times even dangerous to society.

Third; although this can be done only when the barriers of repression have been sufficiently removed that the desire can be recognized, such powerful desires can be associated with activities that are socially acceptable and through them find an outlet for their energies that completely satisfies them, and at the same time makes them an asset to the individual and to the race.

Sublimation

—When more gross or primitive desires are led through the process of CONDITIONING into channels of expression that are higher and more spiritual they are said to be SUBLIMATED. Most truly great men have succeeded in sublimating their most insistent desires. A single example will indicate what is meant:

Michelangelo never married, yet his name marks the pages of history as a man of almost super-human talent and energy, both of which were devoted to a high accomplishment. He records in his own words how he Sublimated his great passion for the one woman of his choice into energies that were expressed by him in his works of art:

“As a stone, when an intaglio is cut upon it, becomes more precious than in its natural state, so am I of greater worth since your image has been graven on my heart. When a sculptor would give shape to an idea, he makes a mold of it in some base material, such as clay or wax; then he puts it into marble and secures its immortality. So, I, born but the model of my future self, have been reformed and made by you, O, lofty and noble lady, into a more perfect expression.”

Censorship of desires is never successful as psychoanalysis, and the Prohibition Law which developed the worst crime wave in history, amply prove. And the evasions practiced to express usually lead to actions which are detrimental. Instead of repressing desires, therefore, the wise course is to carry out an intelligent process of CONDITIONING. Its aim should not be to prevent the expression of whatever strong desires have been built into the thought structure of the astral body, but to permit them to express fully through some acceptable and beneficial channel.

Dr. Frank Crane, writing many years ago, gave a hint of this process in these words:

“Peace and poise with sex instinct, are not to be attained by lawless indulgence; human nature shrinks from this; the angel within us cannot endure it; the bogs of sensuality are no dwelling place for so imperial a creature as the soul. Neither is the solution to be found in the utter denial and eradication of desire, as various cults have vainly fancied. That way madness lies, and outraged human nature wrecks the baffled spirit by perversion. In trying to kill the beast the spirit becomes worse than beastly.

“It was Dante and the Troubadours who found the secret the Church Fathers missed. Not by suppressing, but by idealizing the passions, can they be made wholesome. Dante’s ‘Vita Nuova,’ is a sort of Fifth Gospel. It also points the way to redemption. For it shows how the lust of the flesh may be transmuted in the alembic of the imagination into the most ennobling spiritual impulse. The material craving awakened in him by the little girl Beatrice is made to guide his striving spirit through hell and purgatory, and to expand at last into that glow that dyes the garments of the cherubim and colors the white radiance of ‘the rose of heaven’ with a human warmth.”

From this it should not be inferred, however, that the desire for sex is either immoral or degrading.

Had it not been for sex you and I and all other creatures on the earth had been prevented from experiencing physical life. The desire for sex expression, like the desire for significance and the desire for security, is normal to every healthy person. Only those physically so deficient in a glandular secretion that is an absolute necessity for any measure of success in life have never experienced sexual desire.

It must be reserved for Lesson No. 62 (*How to Apply Suggestion*) to indicate the direction of true morality; but enough already has been said to indicate that it cannot be found through repression; if for no other reason because repression is never successful. The energies thus blockaded by the Civilized desires always escape by devious paths which lead to disease and inefficiency.

Instead of repression, not only the energies of the three Hereditary Drives, but those of as many stellar-cells, dynamic structures and other desires as possible should be **CONDITIONED**, through proper association, to flow, and find harmonious expression through, those channels which have been decided upon as most truly moral.

As it is impossible to direct a flow of energy of which one is unaware into any channel, the first thing to be done is to recognize all the desires for exactly what they are. Instead of being ashamed of them, even if they are primitive, be glad they are there, because they alone afford the energy necessary to accomplishment. Yet recognize their primitive conditions and that their energies can be diverted into truly spiritual expression.

Whatever these desires may be, consider them in the light of their biological past. Then set about to **CONDITION** them so that their energies will find satisfactory expression through moral lines of conduct. Pleasure attracts, and pain repels. Yet wherever possible, it is better to use pleasure.

In such Conditioning bear in mind that the energy of each Hereditary Drive, and the energy of each stellar structure, and the energy of each stellar-cell can be made to express only in terms of its own essential nature. Yet that essential nature can find satisfaction through a wide variety both of destructive and constructive activities. Thus it is that the creative energy must always find expression through destruction or construction. The drive for significance must find expression through the channels that in some manner contribute to the feeling of importance. And the drive for self-preservation must gain satisfaction through activities that can be associated with security.

Recognizing each desire for exactly what it is, and when finding for it a more acceptable channel by which its own essential nature can express, tends to avoid conflicts between the different sets of desires. Through discrimination, the desire is not held back, but is given satisfaction of a nature that is not opposed by other desire groups. One group is not set against another group, no more so than when a child becomes a woman and has children of her own she needs still to play with dolls to find satisfaction for her maternal impulses. Discrimination reconciles the old habit of playing with dolls to finding a higher pleasure in looking after her real children.

Then when the more suitable outlet for the energies of a desire has been chosen, the next thing is systematically to **CONDITION** the desire to find greater satisfaction through this expression than through the old one. This is accomplished by associating with the new method of expression as many and as strong pleasures as possible.

Practice in Sublimation

—Although there are other desires needing sublimation, because this one is subject to so much emphasis in current literature, as an example of the method let us consider too insistent sexual desires. Obviously, because of their essential nature, they can find satisfaction only through creative activities.

When some morally acceptable creative activity which is suitable to the abilities and temperament has been selected into which to sublimate the sexual energies, the next thing is repeatedly to think of as many pleasurable things as possible in connection with this activity. Whenever the sexual desires begin to intrude, turn to this expression and through tying to it as many pleasures as possible, build it up until it is more pleasurable than would be the primitive and more gross expression. Think of it not only as a more highly gratifying expression than gross indulgence could ever be, but also recognize it as a higher, more spiritualized expression of the reproductive urge.

Get all the thrill possible out of this higher creative activity, and dwell at length on how it adds to the feeling of significance (Power Urges); how better it enables you to provide for the weak and helpless (Domestic Urges); what a fine thing it is to use so much intelligence (Intellectual Urges); how it conduces to peace and harmony (Social Urges); how exhilarating to thus gain the victory (Aggressive Urges); how noble thus to do something beneficial to aid God's Great Plan (Religious Urges); how satisfying is the greater sense of security (Safety Urges); how interesting thus to devise new methods of expression (Individualistic Urges); how fine it is to possess such high ideals (Utopian Urges); and how much better thus to cooperate in the progress of the race (Universal Welfare Urges).

In some manner tie in as pleasantly as possible the thought and the practice of the new expression with the desires of each dynamic stellar structure in the astral body, and with as many other desires as can be recognized. And this process of sublimating any gross desire is identical in method with that just outlined. To SUBLIMATE any of them find a more acceptable channel that will permit the essential nature of the desire to express. Then guide its energies into this channel through associating the desire with this expression, and with the pleasant realization of as many other desires as possible.

Chapter 6

Serial No. 61
Original Copyright 1936
Elbert Benjamine

Copyright
Church of Light
August 2002

How to Rule the Stars

Chapter 6

How to Rule the Stars



WHEN we understand the kind of influence exerted by the stars, and what steps to take in character-building to enable us to respond in the desired manner to the astral environment created by their positions, it remains only to act upon this knowledge to rule our stars.

To a great extent we rule the wind and rain, the heat and cold; and even lightning does not possess the terror once it had. This does not mean that we have succeeded in preventing wind storms; but have devised means to utilize the moving air to drive our mills and propel our ships, and have erected shelters that usually protect us from its harm. It does not mean that the summer sun will not burn the exposed skin, nor that we have prevented sultriness in the out-of-doors. But we have devised clothing to cover our skin, and air-conditioning to provide for indoor comfort. Rain is utilized to grow our crops, artificial heat protects from cold.

We do not prevent the various forces of nature, whether they be ocean currents, flowing streams, glaciating ice, or the ionizing cosmic ray, from acting. But through our knowledge we are learning to adapt ourselves rather successfully to these and other environmental forces. Nor can we prevent the planets from radiating the energies they most certainly do. But we can learn what those energies are and how they influence human life; and then take proper steps to utilize them so that they will work, not against us, but in a direction that will be to our advantage.

The planets each broadcast an energy of a special type, but they are neither responsible for the character with which the individual is born nor for the events which later enter his life. He comes into human existence at the time they accurately map the dynamic thought-structures in his astral body, which are the outstanding factors of his character, in obedience to the line of least resistance. As it is easier for a chip to float down stream instead of up, so is it easier for him then to be born than at any other time.

Nor are the progressed planets responsible for the events that come to him as life continues. It is true that they determine in great measure the astral environment at a given time; but how that invisible environment affects him is not determined thus, but by his reactions to it.

Two things are involved in every condition and event of the individual's life: the organization of thought-cells within his astral form which constitutes his soul, or character, and the environment to which that character reacts. Even though the environment remains the same, if the thought organization is changed, that which happens will be different. Change the thought structure of the astral body, and progressed aspects that otherwise had indicated misfortunes can be made to divert their energies into channels that will attract good fortune. As once destructive winds are made to drive his ships, and uncomfortable rains to grow his crops, so also with the understanding modern occult science gives can man make once fear-begetting aspects work for him.

In the previous lesson we have considered that the urges of thought-cells, stellar structures, and other organizations within the astral form determine the actions, and how, once discrimination selects the direction in which the desire-energies should express, those energies can be diverted into the designated activities. But many of the events that come into the life cannot be traced to our physical actions. They seem to be due to actions of others, and to conditions in the physical environment over which we have no control. If lightning strikes our house and kills a child, if an unexpected freeze destroys the crop, if a war breaks out and we must serve at the front, if another car crashes into the one we drive, if sickness comes into the family, if a bank failure takes our money and any one of a score of other events that do come into people's lives should happen, we are apt to feel that no exercise of intelligence on our part could have made things different.

Granting that many things happen which are beyond our control, such as wars and earthquakes; yet how our lives are affected by such events is not due to chance. The way we are affected by such events and the other events which come into our lives, such as our money being in a bank that fails, accidents, sickness in the family, unasked for opportunities—all are determined, not by chance, but by the inner plane activities of the thought-cells and thought-structures of our astral form.

That which we are inclined to attribute to chance is never such; but always the working of a hidden law. And the law which governs the events and circumstances that enter every life is that which relates to the release of desire-energy on the inner plane. Each thought-cell has within it energy under tension, and each thought organization within the unconscious mind has still other energy stored and under tension. These energies strain for release. And when they gain enough additional energy, through more thought or planetary vibration, they spill over into unusual action. Nor is such action confined to the physical plane. It works in an equally potent fashion from the inner plane to attract into the life those conditions which are the objects of the desires of these thought organizations.

In the proper place it will be indicated that true morality is conduct beneficial to the race. But the benefit an individual can render others is not determined merely by his physical actions. Often it is determined to even a greater extent by the events that are attracted into his life through the inner plane activities of the thought-cells in his astral body. If they cause him accidentally to kill some valuable person in an

automobile collision, he has detracted from his usefulness to society. If they cause him illness, he has decreased his efficiency to contribute to the universal welfare. But if they attract to him those conditions and opportunities which enable him to avoid disaster and to live to his maximum usefulness, they have conduced more in the direction of true morality than would be the mere following of any physical line of conduct, however worthy the motive, that ended, because of unforeseen circumstances, in frustration.

To be of greatest benefit to society, as well as most to benefit himself, and thus to live the highest type of moral life, the individual must not merely Sublimate the grosser desires until they flow into channels of physical action of noble purpose, but he must also RECONDITION, those thought-cells and stellar organizations within his astral body that tend to attract misfortune into his life, so that instead, they will work with equal energy from the inner plane to attract into his life those events which most conduce to spirituality, happiness and true success.

That is, real Morality demands actions on the physical plane that are in the direction of Universal Welfare; and other actions by the thought-cells and stellar organizations which take place on the inner plane. Because the activities of cells and groups of cells within the unconscious mind usually do not rise into the region of objective consciousness, the individual commonly is unaware of the forces at work to attract obstacles, separations, friction, and even calamity into his life.

In lesson No. 60 (*Why Repression is Not Morality*), it was indicated how the urges that clamor for expression in physical activities can be utilized by diverting their energies into predetermined channels. This, however, is less than half the problem presented by morality. The other, and larger part, relates to the diverting of the energies which express in inner plane activities, so that they shall contribute also to the more effective life. And it is this that we shall now consider.

The first conception that must be clearly grasped is, as explained more fully in lesson No. 56 (*Doctrine of Esoteric Psychology*), that human birth is merely one cross-section of the soul's journey through time. It has existed before, and it will exist after, human incarnation. And the character with which it is born into human life is the result of all the experiences it has had up to that time; the organization of these experiences as thought-cells and stellar structures in reality constituting the soul, unconscious mind, or character as it exists at that particular moment.

The birth-chart maps the more important factors of the character, and their chief relations to each other, as they have been formed up to the moment of birth. It does not map the characteristics that are added to the soul, or unconscious mind, after the time of birth. Yet it is the characteristics of the soul at the time, and not its characteristics at birth, that at a given period determine what events will then be attracted.

Thus what is attracted into the life in the way of circumstances and events is the result of the inner-plane activities of the thought-cells of the astral body. What these activities are is determined by the desires they possess, just as the activities of observed behavior are due to the release of desire energies on the outer plane. What these desires are, and the manner in which they release their energies are determined by the manner they have been **CONDITIONED** in the past. Therefore if we are to get these desire energies of the stellar-cells and stellar structures to flow into more acceptable inner plane channels of expression, and thus attract a better fortune, we must **RECONDITION** them.

Importance of Events Can Be Increased by Giving the Thought-Cells More Energy

—There is a direct relationship between energy and work, and this relationship is as true on the inner plane as on the physical. No matter how effectively it is directed one can do only so much work with a twenty-horsepower engine. And no matter how effectively it is directed, events of only so much importance can be attracted by thought organizations working from the inner plane that have a limited supply of energy.

The birth-chart indicates rather closely, by the positions and aspects of the planets—the number of astrodynes they possess—the amount of energy at birth in the thought-cells in each compartment of the astral body, and therefore available to attract events relating to that department into the life.

But it should be remembered that the birth-chart shows only the desire energy relative to that department as it existed at birth. That desire energy was built into the astral body gradually through states of consciousness associated with the things having to do with the department. And there is no reason to suppose that the thought-building process stopped at birth. In other words, if sufficient thought and effort is devoted to it, by building new thought-cells and re-organizing old thought-cells in the compartment of the astral body relating to some department of life, in spite of anything the birth-chart shows, enough energy can be added to the thought-organization there that it will work from the inner plane and attract important events concerning this department.

The general rule, supported by comprehensive statistical studies, is that the more energy—astrodyne's—possessed by the thought-organization associated with a given phase of life the more important, either favorable or unfavorable, the events relating to it become. If, therefore, it is considered to be in the direction of a more effective life to attract events that are of greater consequence relative to any

department, the thing to do is to work as energetically as possible to build experiences relating to it into the finer body. Not only work with the things of the department, but think and feel often and strongly concerning them. After all, what your birth-chart now indicates has all at some time thus been built into the astral body, and the process is as open for use now as it was before human birth.

Planets prominent in a birth-chart indicate thought organizations in the astral form possessing much energy. But the volume of energy thus available is mapped in terms relative to the total energy of the astral form rather than in terms that can be measured on some standard scale applied to all individuals.

A horse or a cow may have the same birth-chart as a man, but not be able to do the things the man can do. An Eskimo may have practically the same birth-chart as the editor of New York's leading newspaper, yet never be able to read or write. Among his people, where the level of his evolutionary ascent placed him, he may be the chief disseminator of news. Relative to the other thought-energies in his astral form those signifying ability to acquire and impart information of current interest are as prominent as those in the astral form of the editor. But compared to those of the editor they have little power.

Thus it is that from a birth-chart it is much easier to determine the special types of ability possessed by an individual than to determine how far he will go in the development and application of the indicated qualities. But whatever he does thus possess in the way of energies mapped in his birth-chart, he has the power immensely to increase by intelligently directed effort.

**More Fortunate Events Can
Be Attracted by Conditioning
the Thought-Cells to Desire More
Harmonious
Expression**

—What the stellar-cells and thought structures of the astral body attract into the life with such energy as they possess is determined by the way they are conditioned. This applies not only to those with which the individual was born, but also to all that have been added by subsequent experiences. The thought-elements enter into discordant psychoplasmic compounds when they are conditioned by feelings of distress, and into harmonious psychoplasmic compounds when they are conditioned by feelings of pleasure. The aspects in the birth-chart reveal not merely the relationships existing between the different departments of the life, but also what type of compounds exist at birth in the stellar-cells having to do with each department of life.

Stellar-cells and structures that have been conditioned by pain, when they release desire energy, use their psychokinetic power to attract into the life similar pain. A physical habit that is once firmly established, no matter how detrimental it is, because paths of association have been formed, tends to follow this line of least resistance. So also a discordant thought-compound in the astral body that has become ASSOCIATED with a certain kind of pain, no matter what the effect upon the organism as a whole, it finds it easier to release its desire-energy through pain-begetting channels. That is its habitual mode of expression.

If, therefore, the individual expects to attract to himself events that are more fortunate than those indicated by the aspects in his birth-chart, he must change the CONDITIONING of the thought-compounds in his astral body which those birth-chart aspects merely map. To the extent he can do this will more fortunate events come to him.

Again it should be pointed out that the birth-chart indicates the manner in which the thought-cells and organizations were conditioned at the time of birth. It does not indicate that their energies must remain conditioned in that particular way. In fact, even as the primitive desires characteristic of the snake, the scorpion, the badger and the fox, existing in the human astral form as derived from prehuman experiences, are usually reconditioned during infancy into socially acceptable channels of expression; so should those who would live more fortunate lives set about to recondition the misfortune-attracting thought organizations of their astral forms so that they will work no longer to attract disadvantages, but will as energetically strive to bring into the life advantageous conditions.

Yet as we found in lesson No. 60 (Why Repression is Not Morality), in the case of repressed desires, before energies can be reconditioned so that they will manifest through other channels they must first be recognized. And it is a function of the birth-chart to point out in no uncertain manner the thought-compounds in the astral body which attract each type of difficulty.

A discordant aspect indicates at each of its planetary terminals where a dynamic stellar structure has been built of thought-cells whose elements have entered into a disagreeable compound. And the thought-cells in the compartments ruled by these two planets partake also of this disagreeable quality. They have been conditioned by pain. Consequently when the two departments of the life connected by the aspect are present in the thoughts, there is either consciously or unconsciously, and often both, a feeling of dissatisfaction and annoyance.

Harmonious thinking and feeling about the things thus mapped by discordant planets in the birth-chart rearranges the thought-elements in the stellar-cells related to these things. And as an aspect really maps a line across the astral body of such a length as to pick up, radio fashion, the quality of energy indicated, such a reconditioning, when successful, dissolves the old stellar aerial and forms a new one which is able to pick up planetary energy that is free from static.

That is, an aspect in the birth-chart not only indicates whether, and to what extent, the thought-compounds at its terminals are harmonious or discordant, but it actually maps a line of astral substance which performs the function of picking up such planetary energies as are indicated by its terminals, and picking them up in harmonies or badly loaded with static. Work always consumes energy, and it is this planetary energy largely which is consumed in the psychokinetic work performed from the inner plane by the thought-cells in attracting events into the life. What they attract depends on how they have been conditioned, and how that feeling is modified by the new energy reaching them through the thus formed receiving set.

The planets in the sky form good aspects and bad aspects at closely spaced intervals. It is not, except as these affect world conditions, the aspects of the planets in the sky that form from day to day and from month to month that give the thought-cells in our astral bodies the kind of energy they express in attracting events. Mars energy, Saturn energy, Jupiter energy, and all the other planetary energies are being broadcast from their respective stations constantly, even though at times somewhat stronger than at other times.

It is not the energy being broadcast that affects us, it is the type of energy picked up by our own receiving sets—which are mapped by the birth-chart places and progressed positions of the planets—and thus added directly to the thought-cells at their terminals in the astral body.

Those receiving sets—mapped by the positions of the planets in the birth-chart and by progressions—that have well defined and strong aerials, pick up in volume the energy to which they are tuned. The length of the aerial, or line across the astral body mapped by an aspect, determines both the volume of energy picked up and whether it delivers it as a harmonious vibration to the thought-cells at its two terminals, or delivers it so loaded with discordant static that it gives them acute distress.

As with the ordinary radio set, it is not the programs that are being broadcast at any given time that affects us pleasantly or unpleasantly. It is the particular program of the many coming over the air which we tune in on. And the stellar aerials extending across the astral body of an individual, such as are mapped by aspects, determine the programs of planetary energy picked up and added to the stellar-cells of the astral body. No matter how badly the planets are aspected on a given day, unless we have stellar aerials that are tuned discordantly, and thus to the programs of these discordant planets, no discordant energy from them can reach us.

**Conversion Conditions the
Thought-Cells to Work
Energetically to Attract
Only Favorable Events**

—These lines through the astral body, such as the birth-chart and progressed aspects map, are not due to planetary positions, they are due to the ASSOCIATIONS between different groups of thought-organizations within the astral body. Such associations are not merely energy relations between groups, but these energy relations have caused the mental elements at each terminal to enter into a type of compound characteristic of the association. The aspect thus points infallibly to the type of compound in the stellar-cells, unless something special since birth has been done to change it.

As the line across the astral body mapped by an aspect is not due to planetary positions but to thought-cell composition and thought-cell organization, if the thought composition of the stellar-cells is changed, and a different organization effected, the line across the astral body which is the outgrowth of the original compounds and relationships also will be changed. Through rearranging, the thought-elements in a compound such as is mapped by a square aspect between planets, can thus be transformed into a luck compound such as is mapped by a trine aspect between planets.

The same thought-elements are present in each of such compounds in about the same proportion. But they have been CONDITIONED at the time of the formation of the obstacle compound so that they have arranged themselves in a manner to express a type of desire which works energetically to attract obstacles into the life. When they are RECONDITIONED, through giving the thought-cells at either terminal of the aerial harmonious associations of greater volume and intensity of energy than was given to them discordantly in their building, the thought-elements become rearranged in the thought-cells, and the old line across the astral body is dissolved. In its stead there is gradually built as an outgrowth of the new compound, another line, not mapped in the birth-chart, but which acts quite as effectively in its capacity as an aerial to pick up planetary energy as the old one did.

This new, deliberately built, stellar aerial picks up the energies broadcast from the same two planets that the old one did. But it picks them up only in harmonious vibratory rates, such as when delivered to the thought-cells at the terminals intensifies their desires to work from their inner plane to attract fortunate events into the life. That is, it gives them the additional energy they need, and in the harmony they require, to enable them to perform on the astral plane work of the character they represent which is beneficial to the individual.

Such rearranging of the thought-elements within the stellar-cells, and rearranging the stellar-cells within their stellar structures, without adding in any appreciable amounts thought-elements of a different family to the compounds and structures, is called CONVERSION.

Only the general principle of Conversion here can be set forth, as the process is considered with full detail in *Mental Alchemy* (Course 9). But it should be brought to the attention, in connection with its processes, that no new principle is involved.

Conversion Is Merely Reconditioning the Desires of the Thought-Cells

—In sublimating the grosser desires of which the individual may be somewhat conscious, they are Conditioned through the use of Pleasurable Associations, not so that their energies will fail to express, but so their energies will be led into channels of expression that are favorable to the individual and the race. And in CONVERSION, a similarly sound psychological technique is employed, not to prevent the expression of the urges of the thought-cells and thought-organizations of the astral body, but to Condition them through the use of Pleasurable Associations, so that their energies will be led into channels of expression that are favorable to the individual and the race. The only difference in the process is that in Conversion we deal with desires that express on the inner plane. The rearrangement of the thought-elements and stellar structures, and the stellar aerial which grows as a result, are effects of the Conditioning process, and indicate the new energy relationships established.

In other words, any condition within the astral body shown in the horoscope of any individual in the world, either in the birth-chart or by progression could be built into any other person's astral body if enough thought-energy could be acquired. It is true that physical life is too short, with the thought-energy most people have, to build into the astral body those thought-cells and organizations that express as genius or that attract world recognized power. But to the extent they do build into themselves the same thought-cells and thought-cell relationships possessed by genius or men of world-wide power, they also must inevitably attract to themselves similar external events.

What comes to any individual is attracted by the thought-organization and thought-element composition of his astral body. It is not due to the planets. The planets do furnish the energy with which the thought-cells work. But the kind of work done by the planetary energy thus utilized is entirely determined by the desires of the thought-cells and stellar organizations. That is, we build our fortune, as well as our abilities, through our experiences and how we mentally react to them. If we want a different kind of fortune, the only way we can get it is to build into the thought-cell compounds and structures of the astral body such desires as will attract it.

**Events of Importance Come
Into the Life Only When Planetary
Energies in More Than Usual
Volume Reach
the Thought-Cells**

—Because on the astral plane as well as on the physical plane, work consumes energy, the thought-cells in the astral body can only do unusual work when they acquire, from some source, an unusual amount of energy. Such energy can be supplied by properly directed intense thought and feeling, but commonly it is furnished by the planets.

The life moves along its normal trend, the thought-cells doing the work for which their desires condition them, with such planetary energies as the stellar aeries with which the individual was born—mapped by the birth-chart aspects—can supply them. But when a progressed aspect forms within one degree of perfect, the natural growth of the astral body under cyclic law causes a temporary line to develop across it. This line connecting the two groups of dynamic thought-cells, for the temporary period of its duration, which is as long as the aspect is within one degree of perfect, acts as a temporary stellar aerial to pick up the energies of the planets mapping its terminals.

The temporary line, acting as an aerial, picks the energy up either discordantly and loaded with static, or harmoniously, according to its length. This energy, whatever its nature, harmony, or discord, is carried to the thought-cells at the terminals, giving them both the impetus and the ability to perform unusual work. The energy they receive thus gives them a power they did not before possess to do work on the inner plane. And statistical work with the events that have come into thousands of people's lives, whose birth-charts are known, and whose progressed aspects have been calculated, shows that unusual or important events come into their lives only at those times when the thought-cells relating to the department of life influenced thus receive additional energy from the planets. Events worthy of being noted are always indicated by appropriate progressed aspects.

It is not a difficult thing to determine when unusual events affecting a certain department of the individual's life will come to pass. They come to pass when progressed aspects are within one degree of perfect. But it is entirely another thing to determine how much benefit, or how much distress, will be coincident with the aspect.

If the stellar-cells affecting a department of life have been conditioned harmoniously at birth, as shown by birth-chart aspects, or if they have been more harmoniously conditioned since birth, no amount of discordant energy reaching them from a temporary stellar aerial can cause them to feel mean enough so that they will find expression in attracting an unfortunate event. The energy they receive will build up their desires until they spill into definite inner-plane actions, but they have been so strongly conditioned to work through channels favorable to the individual that they do not know how to work in any other way, in spite of the inharmony and static they receive with the new energy supply.

On the other hand, if the thought-cells reached by the new energy supply have been conditioned at birth to feel distress, and to find an outlet for their desires only through actions detrimental to the individual, no matter how harmonious the new energy added may be, they will not work entirely in beneficial ways. They will not act so disastrously to attract misfortune as if the new energy supply had increased their pain, but neither can they feel joy. Because they have been so strongly conditioned to attract pain, the desire can only find satisfaction in some measure of discord.

All of which is said to indicate that which astrological research amply proves, that the **CONDITIONING** of the thought-cells and thought structures in the astral body more surely determines the nature of their inner plane activity than does the discord or harmony of the energy they receive at any particular time through a temporary stellar aerial.

Five Methods Employed to Rule the Stars

—Yet the quality of the energy they receive over a temporary aerial, through its harmony or discord, and its family type, also tends, during the time it thus reaches the thought-cells, to Condition them in a particular way. It may not have sufficient Conditioning energy, except as it stimulates thoughts and attracts events, to rearrange the thought-elements in the stellar-cells to any great extent, but through the feeling it stimulates in these cells it tends in this direction, and gives them desires they normally do not have. Even a person acts differently when in distress than when experiencing pleasure, and this distress or pleasure prolonged leaves a permanent impress.

Thus is signified, even though progressed aspects merely indicate temporary supplies of energy of a given kind, and do not indicate the thought-cell composition, that exactly the same methods are applicable in handling a progressed aspect as in handling the same birth-chart aspect, except that the method need be applied only while the aspect is within one degree of perfect, instead of more persistently.

This being the case it would be useless repetition to indicate each method of control as applied to the positions and aspects in the birth-charts and then again indicate it as applied to progressed positions and aspects. A progressed aspect merely indicates that energies of a specific type and harmony or discord are being at that time supplied certain thought-cells in unusual volume, and that, therefore, there is more acute need then of applying the methods of control than at other times.

These methods are five in number: The most obvious is through manipulating the physical environment and directing the physical actions. Other than this most external method, which for practical reasons is limited in its effectiveness, there are only two avenues by which the conditions indicated in a birth-chart or the nature of the events indicated by a progressed aspect can markedly be altered. One is by changing the thought-compound of the stellar-cells and stellar structures reached by the planetary energy, so that because they have developed different desires, any energy reaching them will be utilized in a different type of inner plane activity. Such are the methods of Conversion and of Mental Antidotes. The other is by changing the volume or the harmony or discord of the energy reaching the thought-cells, so that it will incite to more or less activity, or so that it will make them feel more disagreeable or more congenial such are the methods of Character Vibration and of Rallying Forces.

1. Manipulating the Physical Environment

— The earth is subject to different weather conditions simultaneously in different regions. And the energy delivered to the thought-cells in a certain compartment of the astral body, and therefore influencing that department of life is in the nature of an astral weather condition affecting one region strongly, and perhaps another region not at all. That is, it may affect money and have no influence over the health or affections.

One may take heed of storm warnings in a particular department of the life to prepare the external conditions so little damage will result, and turn the attention to some other region where the sun is shining, as explained more in detail in lesson No. 183 (Course 18, *Imponderable Forces*).

Or to state the astral storm indications in terms of energy and work: The activities of the stellar-cells from the inner plane can only bring such events into the life as the physical environment makes possible. If the physical environment is so arranged that a certain type of event cannot happen, it will not happen, no matter what the birth-chart and progressed aspects are. That is, the thought-cells can only do as much work from the astral plane as they have energy to accomplish. And if the

environmental resistance to a particular event is sufficiently high they do not acquire enough energy, and events that they otherwise would attract do not happen. The events which tend to be thus attracted if nothing is done about it, and what actions should be taken to give a high resistance, are given detailed consideration in Course 10, *Natal Astrology: Delineating and Progressing the Horoscope*.

2. Conversion

—In connection with birth-chart aspects considerable attention already has been given to Conversion. It can also be utilized quite as successfully in handling a progressed aspect. The progressed aspect indicates a line giving different groups of thought-cells ASSOCIATIONS they did not before possess, as well as adding to them planetary energy. Such energy relations if permitted to set up strong trains of thought and to attract characteristic events, may cause changes in the thought-compounds. But instead of permitting such changes if they are not advantageous, and instead of permitting thought-cell desires which are disadvantageous to develop, through predetermined thought ASSOCIATIONS the thought-elements within the cells receiving the additional energy supply can be rearranged, and their desires so conditioned as to make it easier for them to work to attract fortunate events than those of misfortune.

3. Mental Antidotes

—As the nature of the work done from the inner-plane by the thought-cells and thought organizations within the astral body is determined chiefly by the thought-compounds of which the thought-cells are formed, changing these compounds give them a different type of activity. In Conversion the attempt chiefly is to rearrange the thought-elements already present within these compounds.

But, even as when certain chemical elements are added to a chemical compound already formed, they unite harmoniously and readily with one or more of the elements present, converting what before was a dangerous compound into one highly beneficial; so there are mental elements, called Mental Antidotes, that when added to a compound containing another specific mental element, unite with it and quickly change the compound into one harmless or even beneficial.

Thus the work of changing a dangerous, or difficult, thought-cell compound into one that is harmless or advantageous, is much easier through the use of proper Mental Antidotes than through the process of Conversion. Conversion depends for its efficacy entirely upon Reconditioning the desires of the thought-cells through changing their feeling. And if a compound is to be changed by Mental Antidotes into

a highly beneficial type of activity, this Conditioning through giving the compound harmonious feelings also is necessary. But certain mental elements when brought together, by their own type quality, tend to unite with a feeling of harmony, and will do so unless otherwise conditioned by painful experiences accompanying their union.

Mental Antidotes, because cultivating a type of experience or thought suffices, without the necessity of giving so constant attention to intense feelings of pleasure, are the easiest applied of all methods of changing the composition of the thought-cells beneficially. They do not merely change the arrangement of its thought-elements, but they also add new thought-elements which give a different character to the compound. The thought-cells then act differently when they receive energy either from the aerial mapped by a birth-chart aspect, or from a temporary aerial mapped by a progressed aspect, because they possess thought-elements that have changed their substance into a very different psychoplasmic compound. This whole matter is set forth in detail in Course 9, *Mental Alchemy*.

4. Rallying Forces

—The nervous system of man, through the electric currents flowing over it, is tuned by his thoughts to pick up, radio fashion, the type of planetary program corresponding in harmony or discord and in type to these thoughts. That is, the individual can tune himself to feel rather intensely in a certain way, and the electric currents flowing over his nerves then pick up energy of this quality radiated from one or more of the planets.

Such electric currents also serve as conductors carrying the astral energy thus received to all the stellar aerials of the astral body. So long as a particular state of feeling is maintained the chief astral energy received by the stellar cells at the terminals of all the aerials is of this particular planetary type, and of this harmony or discord.

Thus can be controlled, to the extent the individual can direct his feelings, the type of planetary energy, and the harmony or discord of that energy, which is transmitted to the stellar cells in his astral body. As it is easier thus to keep the consciousness tuned to some aerial already present in the astral body, mapped either in the birth-chart, or by progression, than merely to develop and hold a certain feeling, birth-chart aspects and progressed aspects may be used to indicate the Rallying Forces, as they are called, which are easiest of cultivation.

As inharmonious birth-chart and progressed aspects also map aerials that may tune the consciousness in on discordant Rallying Forces, these indicate clearly what feelings should be avoided to prevent discordant energy being delivered to the thought-cells.

A certain feeling developed and maintained tunes the person in so completely on a specific wave-length and program, that other wave-lengths and programs are not strong enough to make their influence felt at the receiving sets. This does not to any extent change the composition, and therefore the basic desires of the thought-cells, but it does temporarily cause them to feel either better or worse than usual, and gives them energy with which to do more than the usual amount of work. Rallying Forces, which direct the desires of the stellar cells through the quality of energy furnished them are fully considered in Course 9, *Mental Alchemy*.

5. Character Vibrations

—Not only our human associates by their thoughts, but all the objects and conditions of our environment, are radiating astral vibrations which are similar to those that reach us from the planets. Such astral vibrations, not those of thought and not those from the planets are called Character Vibrations. And any such invisible energy reaching the astral body of the individual stimulates into additional activity the thought-cells of the astral body having the same vibratory tone.

Names, numbers, tones, colors, types of environment, etc., radiate definite vibratory rates and thus influence those with whom closely associated. They may, therefore, be selected for the specific effect they will have in furnishing a definite kind of energy to the thought-cells. Lesson No. 108 (Course 10) and No. 184 (Course 18) explain this method fully, and Course 6, *The Sacred Tarot* goes into much detail in regard to such vibrations.

How to Rule the Stars

—Experiments carried out in a dozen universities have now conclusively demonstrated psychokinesis, which is the non-physical power of the mind to move physical objects and bring about physical conditions. This psychokinetic power is not confined to the unconscious mind as a whole, but is exercised also by each group of thought-cells within the unconscious mind. Whether the events that come into the life are fortunate or unfortunate depends upon the desires of these thought-cells. Good luck and bad luck are not fortuitous. Good luck is due to the psychokinetic power of harmonious thought-cells within the finer form, and bad luck is due to the psychokinetic power of the discordant thought-cells within the finer form. The importance of the event is the algebraic sum of the psychokinetic power of the thought-cells working for the events minus the resistance of environment.

Thus what comes into our life is not due to the positions of the stars either at our birth or after our birth; it is chiefly due to the psychokinetic activity of the thought-cells within our astral bodies. If we would rule our stars, therefore, in addition to manipulating the physical environment intelligently, we must change the thought-cell activities. When these activities are altered the change thus in our character cannot fail to bring a corresponding change in the events and conditions attracted.

Thus to change the thought-cell activities, their desires must be changed. Such desires can be reconditioned, as can the desires more commonly recognized. This may be done through rearranging their thought-elements, in Conversion; through adding new thought-elements, called Mental Antidotes, to form a new and beneficial mental compound; through delivering to the thought-cells different Character Vibrations as energy for their work; and through supplying them with a different type and quality of planetary energy, termed Rallying Forces, which tends to Condition the thought-cells so they desire to perform the work decided upon.

Chapter 7

Serial No. 62
Original Copyright 1937
Elbert Benjamine

Copyright
Church of Light
August 2002

How to Apply Suggestion

Chapter 7

How to Apply Suggestion

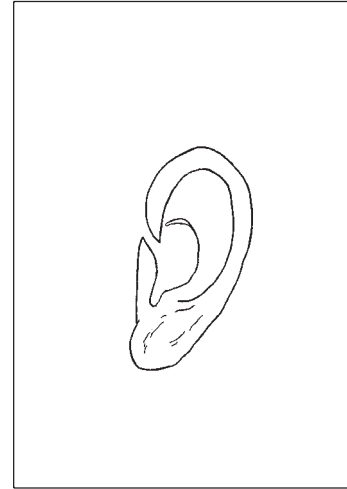

ALL the various activities of the body which are not specifically directed at the time by objective consciousness are directed by the unconscious mind. When we blush, tremble with excitement or fright, speed up the heart action through anger, bring innumerable muscles to bear each pulling just the right amount against another to enable us to stand or sit, digest our food, or to go to sleep, the unconscious mind—which is the sum total of the stellar-cells and thought organizations within the astral body—has given the proper commands to produce the indicated condition. It has the ability to accomplish many, many things that are beyond the power of the objective mind. And the proper application of suggestion is merely the employment of a method to reach and get the assistance of the unconscious mind.

The unconscious mind throughout its whole past has been Conditioned to give its orders to the various physical functions on the basis of the impressions it receives from the environment. If the image of a snake is presented to it by objective consciousness, it does not stop to argue whether this is the image of a real snake or a piece of rope that in the dim twilight, as it lies in the path, merely looks like a snake. Whatever its conditioned reaction to the image of a snake as derived from the past, those orders instantly are conveyed to the groups of thought-cells that have thus been associated. The person gives an involuntary start, jumps to one side, screams, stands frozen with terror, or merely smiles with pleasure. Whatever action is taken is not due to the presence of the snake, but is due to the image of a snake being accepted by the unconscious mind.

The voluntary actions likewise are governed by the images accepted by the unconscious mind. When we think of moving to a given place, that image connects up the thought-cells Associated with such movement, and the release of the energy of their desires causes us to walk or otherwise act so that we go to the designated place. But if, before we have made the movement another image, that of remaining where we are, reaches the unconscious mind, this constitutes a counter command and we do not move.

What our actions are, and what the four-dimensional activities of the thought-cells are, is not determined by what is actually present in the external environment, and not by what our reason and conscious thoughts command. They are determined by only two things: How the stellar-cells have been Conditioned to act when a given stimulus, or image, was presented to them, and what stimulus or image thus does reach them.

Certain images that are presented to the unconscious mind have been subjected to some critical analysis as to their truth and nature. In the process of thus accepting or rejecting them, the conscious mind has presented to the unconscious a variety of somewhat contradictory images. In fact, everything that reaches the unconscious mind by the way of reasoned thought presents these contrasting images. This process of exercising discrimination, through setting one image against another, is not conducive to concentrating the desires of the thought-cells all toward a single activity. Some pull in one way and some in another.

A suggestion, or image to which the objective consciousness pays little or no attention, and thus to which no counter images are opposed, may have a far greater power to enlist the desire energies of the thought-cells and stellar organizations within the astral body. If at the same time a large volume of emotional energy is associated with the image, it may easily build up a power which any reasoned thought is unable to overthrow. In this manner the various complexes are formed with which the psychiatrists wrestle in their endeavor to cure psychopathic patients and those who suffer from less severe complaints, such as nervous or mental breakdown.

Suggestions During Childhood

—It is because in early childhood experience is lacking for a proper critical appraisal of an idea or situation, and therefore no counter images are present to offset those received by the unconscious mind, that suggestion plays so important a part in that period.

The importance of a situation is easily exaggerated, and an emotion generated in connection with it out of all proportion to its real seriousness. This emotional energy, nevertheless, Conditions the thought organizations associated with the image of the situation so strongly that other images received later in life are powerless to cause actions either of the thought-cells or of the body, other than in the manner they have thus originally been taught to release the powerful desires then built into them.

A situation accompanied by the emotion of shame is potent to build such a complex because that emotion is Associated with the Drive for Significance. A situation accompanying sexual thoughts is potent to build such a complex because the emotions are Associated with the Drive for Race Preservation. A situation accompanied by fear is potent to build such a complex because that emotion is

Associated with the Drive for Self Preservation. Not that there are no other emotional accompaniments of situations which are at times powerful enough to build complexes into the astral body; but these three Hereditary Drives have acquired so much energy in their biological past that any image which becomes closely Associated with them has an available energy supply of tremendous power.

It should now be apparent that a Suggestion is merely an idea, image, impression, thought or feeling which through some avenue reaches the unconscious mind. Its acceptance by the unconscious mind depends upon the images of an opposite tendency already in the unconscious and those entering at the time of the suggestion.

As the mind can give its attention completely to only a very limited field at any one time, to the extent it is fully occupied by one thought, one Image, or one sense impression, are all other thoughts, images and sense impressions temporarily cut off. They have not ceased to exist, but it is the function of attention to give temporary dominance to that which is its object. Attention focuses the energies in one direction. That is, the unconscious mind has been Conditioned to divert energies so that they flow in the direction of the image before the attention.

This fact is made use of in the proper application of suggestion; and it plays an equally important part in the improper application of suggestion.

Much of the old time religion and much of the old time parental training given the young were based on fear. The emotion of fear is painful, it Conditions the thought-cells with so much discord they work energetically to attract into the life disaster, and it releases adrenaline into the blood stream as if an emergency were present requiring a complete mobilization of the body's forces for getting away from the painful condition. In an occasional real emergency the body can afford, to prevent being destroyed, the disarrangement of its normal functions and the presence of hormones in the blood stream that are foreign to its normal welfare. But these same emergency chemicals if present in the blood stream too often, as effectually poison the individual as if the poison had reached his blood through being administered by an enemy in his food.

Think of the thousands of invalids who owe their infirmity to nothing but the belief in a literal hell! Think of the innumerable maladies arising from the doctrine of eternal damnation! The licentiousness of ancient Rome through excess of sensual emotion no doubt developed many malignant maladies; but as a student of the reaction of the endocrine glands to painful images, I am sure they brought fewer maladies than the long-faced doctrine that to be happy is to be evil.

Whatever the images are which are accepted by the unconscious mind, to the extent they are not blocked by opposing images, and to the extent they can gain from emotion or from the desires of the thought-cells already present energy for action, and to that extent do they cause actions on the four-dimensional plane that attract events, and to that extent do they affect the health and efficiency of the physical body.

Realizing that pain Conditions the thought organizations to work on the four-dimensional plane to bring into the life misfortune, and that it invariably causes chemicals to be secreted in the blood stream that are inimical to its welfare, it is hard to conceive of a more pernicious belief than that joy is a sin. Let any person try to eat amid sordid surroundings, with the food in grimy dishes, even though in reality they be clean, and unless very hungry the appetite will depart. The same food tastily arranged in bright artistic dishes when served in a pleasant room will taste entirely different. And not only will it taste different, but because chemical secretion is different, it will be assimilated far better.

The artistic and the beautiful, through the power of suggestion, have an important function in human life. When reduced to its primitive elements pleasure expands and pain contracts; though this not so apparent in some of the more complex forms that may be observed. What then is the result of a religion of painful duty? It inhibits activity, brings mental and physical stagnation, causes inimical chemicals to enter the blood stream and poison the body, and leads toward inefficiency and general dissolution.

Pleasure Conditions the thought organizations to work on the four-dimensional plane to bring good fortune into the life, and it causes chemicals to be secreted in the blood stream that build up and give vigor to the bodily tissues. From practical experience the Greeks knew the value of recreation. They spent much time in sports, in music and in dancing and thus increased their efficiency.

Moral Conduct

—As in lesson No. 60 (*Why Repression is Not Morality*), we found how desires could be directed into predetermined channels, and in lesson No. 61 (*How to Rule the Stars*) how the energies from the stars could be utilized to attract events such as were considered beneficial, and now we are finding how suggestion can be utilized to give our lives efficiency along predetermined lines, it seems most appropriate that before going further we should decide just what lines of conduct should be followed. That is, we should now decide, once for all, what conduct is immoral and what conduct truly Moral.

There is an old fallacy that if we but listen to conscience it will always tell us what is right and what is wrong. What conscience really tells us gives voice to the Civilized Desires. When these Civilized Desires have not been strong enough to prevent being overcome by the more primitive desires, and these express in action, the discomfort of the Civilized Desires at thus being thwarted is felt as the Pangs of Conscience.

Society has formulated, according to the knowledge it possessed, such ideas about conduct as it deemed necessary for its well being and protection. Children are taught, and receive the suggestion from infancy through the reaction of their elders to certain situations, that there is something sacred about these ideas which are accepted by the group as moral. Often they are even taught that they are in the nature of a deific command.

The society to which we belong, as an example, for its own protection, has formulated the conditions under which it is permissible to express primitive desires in the manner of their original promptings. It sanctions the expression of the sexual desire, for instance, only after a wedding ceremony and the providing of a wedding ring.

The equally primitive desire to kill an opponent is also permitted, but only under conditions imposed by society. It is sanctioned in self defense; while in war in every way it is encouraged.

But society in different regions of the earth has been confronted with different problems, has had different experiences, possesses knowledge in different degree, and consequently has formulated different conceptions of what is, and what is not, moral.

In some regions, doubtless because in the olden time it was customary for so many males to be killed in battle that without polygamy the race would have been exterminated through lack of children, it is still considered at least a misfortune for a man not to possess numerous wives. In Tibet, where men are frequently away from home for long periods of time, a woman without several husbands is considered unfortunate. Yet in the U. S. A., to have more than one wife or husband is not only considered immoral, but is a penal offense.

A Roman gladiator not only had no conscientious scruples about killing an opponent in the arena, but had he felt reluctance to strike the fatal blow his conscience would have reprimanded him for his weakness. The old Calvinists were conscience stricken when a child was not baptized before its death. To them such lack of baptism was immoral; for they believed and taught that there were infants in hell a span long damned to eternal torment for not thus accepting Jesus as their savior.

Conscience depends upon what the unconscious mind has accepted as moral and immoral; and what is considered moral has been Conditioned by the social group in which the individual has been raised. In parts of India it is considered a sin to permit the shadow of a low caste person to fall upon one's food. For a woman's husband to die in some regions of that country is another sin, and it must be atoned for by the wife being burned on the funeral pyre.

To be a spirit medium in the days of Cotton Mathers was a sin punishable by death. To eat meat other than fish on Friday is considered a sin by some. To eat pork on any day would trouble the conscience of a Mohammedan or an orthodox Jew. Some suffer from their conscience until they can attend confessional, after which they trouble no more about the transgression.

Society in its different groups came to believe that certain actions were beneficial to the group, and that other actions were in the direction of disaster. To protect itself from injury it formulated such beliefs into a code of morals. As a group is composed of individuals anything considered detrimental to the individual, unless it was at the same time beneficial to the group, was also considered immoral. The taboos of primitive peoples are even more strictly observed, although to us they appear perfectly absurd, than are the precepts of orthodoxy among civilized church members. Because, through lack of correct information primitive peoples have come to consider certain quite trivial actions as the cause of misfortunes that were in reality caused by other things, these trivial actions are considered immoral, and the tribe punishes drastically any who resort to these, to us, trivial actions.

Thus must it be apparent that what is considered moral in a particular locality depends entirely upon what is there believed to be in the interest of the welfare of society. That is, those actions are truly moral which benefit society and those are truly immoral which harm society; and the code of conduct recognized as moral by any people is truly moral or lacks in true morality to the extent it really benefits or harms that people.

Wisdom and Morality are the Same

—A people can approach true morality only in so far as they have correct knowledge as to which actions are beneficial to the group and which are detrimental. True morality, therefore, like the best religion, must rest upon as inclusive knowledge as possible. Many of the teachings of past and present as to what benefits the individual and the race are found through scientific experiments to lead to harmful actions. Yet there is a great amount of evidence to indicate that one old teaching is true; that any action beneficial to the race, is also in the long run, beneficial to the individual who takes that action.

Wisdom dictates, from as wide a scope of information as can be acquired, those actions which are most beneficial to the individual and to the race. Such actions, to the extent there is wisdom are truly moral. In other words, true Wisdom and true Morality are the same thing.

What actions are taken by the individual are determined by how his desires are conditioned and the stimuli furnished by his environment. Therefore, any true moral system must include instructions on how the individual can condition his desires so that his actions will be in the direction dictated by wisdom.

The desires of the thought-cells in his astral body, which when given additional energy by a temporary stellar aerial mapped by a progressed aspect, attract to him fortune or misfortune are equally as important to the welfare of society as are the desires which lead the individual to some physical action. His value to society is often influenced as much by what happens to him in the way of opportunities or obstacles, good luck or disaster, as by the actions he takes. If he starts a venture, which when it fails drags down most of the members of his community, society is hampered. If he undertakes some work which in its success adds greatly to the welfare of others, that is in the direction of morality.

To lead a truly moral life knowledge must be at hand, such as astrology affords, as to the most valuable thing an individual can do, and how through conditioning the thought-cells in his astral body and taking advantages of planetary energies afforded by aeriels mapped by progressed aspects, he can thus live to his maximum usefulness.

Resolving Conflicts

—If the individual is thus to reach his highest, he must learn to Resolve his Conflicts. That is instead of imposing one set of desires to thwart and repress another set of desires, he must learn how to reconcile the various desires so that, both on the four-dimensional plane and on the three-dimensional, they will pull together. Yet for thousands of years so-called moral education, as well as the education of children by their parents and teachers, has followed the method of creating conflicts; one desire set pulling vigorously against another.

Suppose a child is forbidden to touch a knife. He sees it, nevertheless, as a pretty plaything. Thus the image of knife is associated in his mind with the Conditioning of pleasure. He has had no experience associating pain with the knife. The only painful Conditioning has come from the parent who has forbidden him to touch something that he feels will give him pleasure. The image parent has become Conditioned by experiences with pain; for he has been chastised in the past when he failed to obey.

So long, therefore, as knife and parent are together the painful Conditioning is dominant; that is, the desires to escape the pain associated with parent successfully oppose the desires to have the pleasure associated with the knife. But when the parent is called away the painful image becomes so remote that it no longer successfully prevents the pleasurable image of knife from gaining the supremacy; and the child plays with the knife, and perhaps sustains a serious injury.

Had the parent understood psychology, the child would have been permitted to experiment with the knife sufficiently to become convinced of its painful qualities, yet restrained from injury. By feeling the sharp edge and the painful prick of its point he would have associated the pain with the knife rather than with the parent. Or, better still, he would have played with it cautiously in the parent's presence and thus learned its proper use.

Later in life the ignorant parent forbids the child to go swimming. The child associates the danger of water with the threatened whipping. Therefore, when he sees opportunity of escaping detection he goes, induced by his chums, to the "ole swimmin' hole," and runs the risk of drowning. Yet had the parents taken the child to the swimming hole, and permitted him the experience of becoming strangled in deep water, he would have learned a wholesome respect for dangerous depths. And furthermore, he would have had both the opportunity and the incentive to learn how to overcome the danger by learning to swim.

The boy who has had some experience with the stomach ache does not need to be threatened with a whipping to keep him from gorging on green apples.

Why is it that many children, in spite of a deep sense of duty, grow up with a feeling of resentment towards their parents?

It is because their parents, in ignorance, have transferred to themselves the image of pain and suffering that should have been associated with certain objects. They have forced the child to do this and not to do that, until the image of pain and repulsion arising from disappointment to realize a thousand little desires is indissolubly associated with the parent.

Why does everyone like to hear a story in which a policeman is discomfited? Because each person looks upon a policeman as a bar to the realization of certain desires. All thus more or less detest policemen. But the stronger the desires that policemen have frustrated the greater the dislike. Not because policemen are bad, but because they are more directly associated in our minds with non-realized desires than are the laws which they are employed to enforce.

The race has been taught its morals in much the same manner that children are taught by ignorant parents and teachers. Some book, called sacred, or some priest, medicine man or preacher, has assumed to interpret the will of Deity. It has been taught that if certain primitive desires are permitted to express in action that the Deific Parent will become violently angry and mete out severe punishment. Commandments have thus been imposed by a Divine Being Who will take summary vengeance upon all who break them.

A lie is not Conditioned by its effect upon society and its reaction upon the welfare of the liar; but is associated with some superhuman Being Who is jealous and demands: "Thou shalt not lie." And so it is with all the other ideas of morality. They are not Conditioned by their association with some natural law, but by their association with some arbitrarily imposed command that seems to deprive mankind of what otherwise would be a pleasure. Thus is built up the desire, not to refrain from sin, but to escape the punishment imposed by the Heavenly Parent.

Such a system of morals sets one group of desires in deadly conflict with another group of desires. Have we not often wondered why some people considered very wicked remain in full vigor of body and intellect, while many of our most virtuous acquaintances suffer neurosis, forgetfulness, morbid anxiety and even migraine and lameness? It is because, as the thousands of examples cited by Freud, Jung and Adler thoroughly demonstrate, sensual gratification, unless quite excessive, is less destructive than the internal conflict of desires. And wicked people are not troubled with such suppressions.

Instead of thus developing conflicts which invariably detract from efficiency and work from the four-dimensional plane to attract misfortunes, the proper teaching of children and the proper teaching of morals should take whatever pains are necessary to reconcile desires. When all the facts of a moral conception are known it will always be seen as the line of conduct which, in the long run, will result in the most pleasure to the individual. So with the child, in the long run, the things he should do will give him the most pleasure. The problem is to so engage the more immediate desires that they will lend their assistance to this course of action.

Their cooperation is never gained through fighting them, or suppressing them. They must be Conditioned in some way to find pleasure in the proposed course of action. In the case of the child with the knife, when he had learned both its painful and pleasurable qualities it no longer would be dangerous to him, and he could employ it usefully as a tool. And in like manner when man knows enough about anything, this knowledge will indicate to him what his own line of conduct in reference to it should be that, in the long run, he will gain the most pleasure. In other words, it will show him how it can be handled to the best benefit of himself and the best benefit of society.

Knowledge and discrimination indicate the actions which are in the direction of Morality. Everything in the universe has its use, and we may be sure everything contacted by man is capable of abuse. Thus when we are called upon to meet temptation, which is merely the urging of the less civilized desires, we can exercise discrimination and condition these desires clamoring for expression to find their pleasure in channels that are beneficial to ourselves and to society, or we can handle it in less successful ways.

For instance, take the matter of reading novels. One of the fossilized notions fostered by Puritanism is that all novel reading is sinful. And the technique advocated is complete suppression. That is, the longing for reading fiction is met by a flat refusal. Thus one group of desires—that to conform to this Puritan standard of conduct—is set against the group of desires that strive for this particular pleasure. If the Puritan group is stronger it manages to keep the others from expressing. But their energy is still there. They are in a state of rebellion, and the internal conflict is neither conducive to physical efficiency nor to attracting, through the four-dimensional activities favorable events.

Another method of meeting this problem is merely to permit the desires to express their energy spontaneously. Yet the reading of sentimental trash, and stories appealing only to the primitive emotions, may build into the character still other desires, and condition those already there, in a manner that ultimately leads to serious errors of conduct.

Still a third way of handling the situation is alternately giving the Puritan desires control, then when the conflict becomes too severe, permitting the primitive desires to triumph for a time. Thus there would be indiscriminate reading for a time, the primitive desires temporarily winning the fight, and then a time when no reading would be done, as the Puritan desires again assumed the ascendancy. Dissipation would be followed by remorse. But to the discords of the conflict already in progress, such a course adds the painful Conditioning energy of remorse. Remorse is simply an added volume of discordant energy fed into the image of the action causing it, and thus making its repetition so much the more certain.

The fourth, and correct way of meeting this situation is to learn all the facts regarding both the good and the evil of novel reading. When the full details are understood it will be recognized that certain kinds of fiction stimulate undesirable qualities, while other kinds of fiction cultivate the higher impulses, add to the ability to use language, impart valuable knowledge, and conduce to healthful pleasures. Thus will it be recognized that some fiction reading is beneficial and other fiction reading is detrimental.

Four Ways of Meeting Temptations

—I have used the attitude toward novel reading merely to illustrate the ways in which any Temptation, whatever it may be, can be met: 1. The Desire may be suppressed by blocking it with stronger desires. 2. The Desire may be gratified 3. The Desire may alternately be gratified and suppressed. 4. Information about it can be collected and analyzed, and discrimination used to determine the line of conduct which alone is Moral.

Often, the perception of the effects of permitting the desires to express in different ways is sufficient to Recondition them so that their energies then strive for release in the line of conduct determined by Discrimination. That is discrimination of what each set of desires, if permitted to have its own way, will bring to the individual often is sufficient to reconcile them, so that both sets pull together to realize the line of conduct Discrimination has decided upon.

But with still stronger desires, such as have been subject to much past conditioning, additional inducements need to be used to get them thus to cooperate. That is, as explained in lesson No. 60 (*Why Repression is not Morality*), each set should be associated with as many pleasant things as possible to its desires, instead of being antagonistic to the decided upon action, will find greater pleasure in this action than

in that type of conduct it previously strove to realize. When two previously opposing sets of desires in this manner have been Reconditioned so that they both find greater pleasure in expressing through the channels determined by Discrimination, they no longer strive against each other. The new avenue of expression, which is acceptable to both, is a compromise on their differences. Their old antagonism is forgotten in their mutual effort to realize the new, and more pleasing, line of conduct.

This matter of conflicts, and how they can be reconciled, is a necessary prelude to any comprehensive study of the proper method of applying suggestion. Suggestions, and that type of suggestions called affirmations to be discussed in detail in the next lesson, are images or ideas to which the attention of the unconscious mind is drawn. Such an image constitutes the direction in which action will be taken, unless other images interpose sufficiently to draw the attention to them. If such other images are more powerful they will attract attention to themselves and the action will be in the direction of their desires. Thus, if a suggestion is to be effective, it must not be opposed by nor brought into conflict with, thought groups which afford a contrary auto-suggestion.

Attention Gives Tremendous Temporary Energy to a Desire

—The desires of the thought-cells and thought organizations within the astral body are the source of both the three-dimensional and the four-dimensional activities of man. To the extent they are energetic do they attract the attention of the unconscious mind; and to the extent the attention is thus called to those images by which they can be realized are their energies released in that direction.

A sensation arriving from the external environment, an emotion released by a thought, a statement received as a suggestion, Associates with certain thought-groups already in the astral body, giving them temporarily new energy, and temporarily thus increasing the power of the desires in the group to such an extent that action, both three-dimensional and four-dimensional, results. That is, whatever desire is temporarily dominant determines what images shall be presented to the attention. Desires which at the time have less energy, perhaps through not connecting up with some external source such as an objective thought, or visual image, receive proportionately less attention.

Throughout its biologic past the unconscious mind has been Conditioned to release desire energy in the direction of the image, or thought, which was the focus of its attention. In fact, attention is the focusing of desire energies. To the extent past Associations permit the thought-cells and thought-organizations within the astral body to be connected up with the image then present, are their desire energies temporarily diverted into an attempt to fulfill that image. That is, whatever image is the subject of attention, both the three-dimensional activities and the

four-dimensional activities tend in its direction. They strive for movement to make the picture a reality, whatever it may be, because throughout all its past the soul has given orders to its various parts and to its physical organs and function by using, as explained in lesson No. 58 (*Language and the Value of Dreams*), this kind of language.

Movement is Always Toward the Image Which Gains Attention

—It is of the utmost importance not only in the application of suggestion, but in the use of thought for any purpose, to realize that to the extent a given image is able to attract the attention of the unconscious mind, is there three-dimensional and four-dimensional movement toward that image. The desire energies are diverted into the image irrespective of whether it is something beneficial or destructive. It is not for the thought-cells and thought groups to discuss the merits of the matter. They have been trained to release their energies in the direction of whatever was before the attention, and this they do. Only to the extent other and contrary desires are able to capture some portion of the attention of the unconscious mind are they able to release their energies in activity. But if they are strong, they keep continually tugging to get some share of the attention, and thus enough supplementary energy to enable them to work.

Resemblance closely associates opposite images. Black is thus associated with white, sweet with sour, pain with pleasure, moving forward with running away. So that unless a suggestion is applied with some consideration for the manner in which the unconscious mind has already been Conditioned, instead of bringing the suggested image, or course of activity, to the attention, the previous Associations may readily bring before the attention the opposite image. Suggested bravery thus may bring to the attention of the unconscious mind the image of cowardly actions that have been taken in the past, and still further Condition the individual in the direction of cowardice. Suggested health may bring before the attention of the unconscious mind the various images of illness in the past, and Condition the individual still further in the direction of illness.

Applying Suggestion

—In the application of suggestion, therefore, that it may not have the opposite effect from that intended, a technique must be employed that will insure that the attention is directed to the proper image. This technique should be such that little conflict is developed. And it should as completely as possible hold the image vividly and persistently before the attention of the unconscious mind.

The most satisfactory condition for getting the complete and undivided attention of the unconscious mind to an image or idea is when, through some process, the objective mind is placed in a state of quiescence so that the reasoning process is stopped. Reasoning brings a succession of images, the process requiring a weighing and comparing of different viewpoints. To the extent, therefore, that the critical faculties are thus active, is the attention moved from one image to another.

Furthermore, in reasoning the energies of the unconscious mind—the desire-energies of the thought-cells and stellar organizations—are connected by energies with the brain cells and flow strongly outward. This outward flowing of the energies, commonly called being positive, is unfavorable for permitting any image vividly to impress itself upon the thought organization. That is, when the energies are flowing strongly outward, as they tend to do in objective thinking, that activity hinders the reception of a thought or image by the unconscious mind. But when the objective mind is relaxed, the thought or image meets no such outward energy. The person then is said to be in a negative state, and the image or thought, meeting no resistance is able strongly to impress the unconscious mind. Thus it attracts a large amount of the unconscious attention.

Objective attention can not be directed steadily to a single point for any length of time. The attention moves and must be brought back to the center of interest. Experiments demonstrate that attention waxes and wanes, reaching its maximum at intervals of about three seconds. But if the attention is directed steadily to a single point without wavering the consciousness fades. Objective consciousness depends upon movement, and when it ceases to move there is no longer objective consciousness.

If a bright and glittering object is placed in front of a person's eyes, and slightly above them, it will form a focus of attention that thus tends to cause the consciousness to fade. Strict attention to the droning talk of the operator tends still further to lull the activity of the objective mind. Close attention to so limited a set of sensations causes the subject to fail to register other sensations, and the brain becomes blank except to the voice of the operator. His suggestion that the subject is sinking into a profound sleep thus finds an open avenue to reach the unconscious mind, and sleep ensues. Such is the method of the hypnotist.

During natural sleep, also, it is possible to reach the unconscious mind of a person and give him audible suggestions, being careful that the voice does not cause him to awaken. And the suggestions received in this manner will be acted upon just as if he had been hypnotized.

But it is not necessary that a person should be asleep or hypnotized to be open to suggestions. The hypnotist gives his commands, once his subject is asleep, in a forceful and positive tone of voice. And because they thus are positive and forceful they more surely register and attract the attention of the unconscious mind. Yet when a person speaks to himself in such a forceful and positive manner he is almost sure to be exercising his objective mind. That is, his energies are radiating outward, and he is not in the state of reception.

Instead of being so vigorous, if the individual will relax and permit himself to become drowsy, or at least in a dreamy state of consciousness which is on the borderline of sleep, and repeat the suggestion to himself in a droning sing-song voice, or think it over and over with barely enough energy to keep the thought present, and thinking of nothing else in particular, just let the mind drift, he will be using the best method to cause suggestion properly to register.

At night, just before going to sleep, while in that state when objective thought has almost entirely eased, or in the morning while between the sleeping and the fully awakened state, is commonly the most convenient time to attain this negative condition in which the unconscious mind is most receptive to suggestion. As long as thoughts about the day's work flow through the mind, or as soon as they commence in the morning after waking, the energies are radiating outward, and the receptivity to the extent is hindered.

The psychoanalyst in the employment of the method of free association, uses the same relaxed state of mind, in which the radiating outward of objective thought has almost ceased, not to give suggestions, but to bring to light memories and desires that are buried in the unconscious mind. That is, in addition to the dreams of sleep, which he also employs in his uncovering of the strong unconscious desires, he gets the patient to mentally drift, stop reasoning, and merely to express such thoughts and images as flow spontaneously from the unconscious.

Even under hypnotism the subject will not convert into action suggestions which are opposed by strong groups of thoughts already organized in his astral body. To get him to commit a crime, he must have no strong objections to being a criminal, or he must, over a long period of time, be Reconditioned so that the moral group of thought organizations can be overcome by those which are suggested.

Clinics where suggestion is employed therapeutically have found that suggestion commonly can be applied quite as effectively without inducing the hypnotic sleep. And by observing the necessary conditions, such as avoiding statements that set up conflicts or such as encourage an image which is the opposite of the effect sought, and by applying the suggestion while the mind is free from radiating thoughts but instead is on the borderline toward the sleeping state, the individual can apply suggestion to himself quite as effectively as it can be applied by another.

Suggestion gains its force through the age old habit of the unconscious mind to divert as many desire-energies as possible into the performance of the act, or into the establishing of the condition, which is held before the attention. To the extent other images or desires claim the attention of the unconscious mind is energy drained from the one image into them. Thus the proper application of suggestion requires a technique in which the image decided upon is presented to the unconscious mind connecting up, or bringing to the attention, images or desires which are not opposed to its realization. The more completely the image is able to dominate the attention of the unconscious mind, the more desire-energy from non-opposing thought groups are made available for its use.

True morality consists in living so as to contribute the utmost to universal welfare. To contribute his utmost, an individual must develop his abilities to the highest extent and must use these abilities under favorable circumstances. Either to develop his abilities, or to attract to himself opportunities for their use, as well as to avoid those events which hinder happiness, usefulness and spirituality, he must Recondition the desires within his unconscious mind. And in the Reconditioning of the more obvious desires, which lead to three-dimensional activities, and in the Reconditioning of the thought-cell compounds, and the thought-cell organizations, which determine the events which, through their four-dimensional activities, will be attracted into the life, suggestion can be effectually employed.

Chapter 8

Serial No. 63
Original Copyright 1937
Elbert Benjamine

Copyright
Church of Light
August 2002

The Correct Use of Affirmations

Chapter 8

The Correct Use of Affirmations

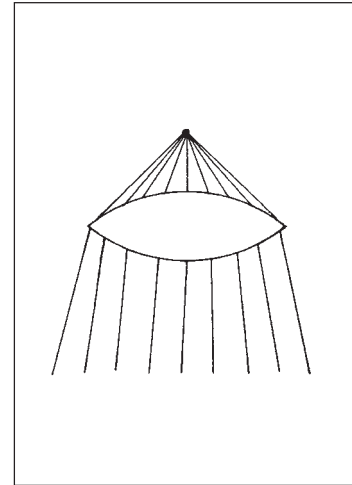

AN AFFIRMATION, in the sense psychologists and healers employ the term, is a statement of a condition given to the individual by himself or by another, in the manner deemed best suited to reach his unconscious mind and through suggestion bring its realization. That is, an affirmation is a suggestion that a certain condition is a reality.

If the individual repeats to himself in a positive manner, "I am in perfect health," this may bring to the attention of the unconscious mind the image of perfect health and divert enough energy to the realization of the image that the thought-cell composition and thought-cell organization within the astral body are markedly changed.

The predisposition to a particular disease is due to the energy of thought-cells that have entered into relations with other thought-cells in a discordant manner. As such relations are mapped in the birth chart by the prominence and aspects of the planets, the predisposition to any complaint, including not merely diseases of the body but also of finances, domestic relations, honor, etc., can be ascertained by a statistical study of the birth-charts of those having suffered from such difficulties. Such statistical studies have been made of 160 diseases of the body and are set forth in Course 16. The various C. of L. Astrological Reports make statistical studies of other conditions and of such diseases as have not been considered in Course 16, *Stellar Healing*.

If the affirmation succeeds in gaining sufficient attention and energy from the unconscious mind to alter the composition or arrangement of the thought-cells responsible for the disease, whether it is a disease of the body or of some other department of life, the fortune in that respect will be altered. If it succeeds in changing the thought organization into such as normally expresses health, the disease will vanish.

But whether, and to what extent the repetition of the assertion, "I am in perfect health," will do this depends upon a number of factors; chief of which is the manner that the thought groups in the unconscious mind already have been Conditioned.

To a person whose birth-chart has a strong and afflicted Saturn, indicating a tendency to be suspicious and to look for ulterior motives; this suggestion of health may merely the more strongly draw the attention of the unconscious mind to the illness. When the unconscious receives the suggestion, it may connect up with the thought that if there were no illness there would be no call for an attempt to cure it. That is, Association of ideas may lead to an image in the unconscious mind the very opposite of the one intended by the affirmation. Or it may inject the image that the individual really has no such power to heal himself as the attempt implies. This second tends to attract attention and to weaken the power of the suggestion.

To the man who habitually is a coward, the affirmation, —I am brave— may merely draw the attention of the unconscious mind the more strongly to his fear. Or if the man is a typically Mars character, who reacts customarily with initiative and courage, the affirmation, “I am afraid” may be so strongly opposed by the thought groups that commonly determine his actions that the attention of the unconscious mind is drawn more strongly to his courage.

When the unconscious mind, because of the manner in which its thought groups have previously been conditioned, directs its attention more or less to a different thought than the one that is afforded by the suggestion, that image is called an Autosuggestion. That is, an Autosuggestion is a suggestion furnished by the unconscious mind.

Action is Always Toward the Image Receiving Attention

—It can not too often be emphasized that the function of attention is to direct the desire energies toward, and not away from, the object of attention. That is, the unconscious mind throughout its biologic past has been Conditioning its thought-cells and thought organizations to mobilize their desire energies and direct them toward the object or condition held before the attention. The image or thought reaching them has come to exercise the function of a command. Therefore, it is not the suggestion given which releases and directs desire energies. It is the image or thought which is actually present.

Negative Desires

—When the image presented to the unconscious mind is such as to release energies in the direction the opposite of that which is the intention of objective consciousness It gives rise to a negative desire. It is called negative in the sense that an alternating electric current moves in one direction as a positive impulse and in the opposite direction as a negative impulse. That is, a negative desire is a desire straining to find release in a direction opposed to that of the objective intention.

Fear

—As an illustration of how Autosuggestion may, and often does, give rise to negative desires, consider that, in so far as sense of balance is concerned, it is no more difficult to walk a twelve-inch steel girder when it is 100 feet from the ground with nothing but air on either side than it is to walk the same girder when it rests firmly on the earth. A person who cannot walk such a girder while it is on the ground is unusual; yet the structural worker who walks it thus when high above the earth has ability so uncommon as to be a newsreel subject.

While it rests upon the ground the person does not receive strong autosuggestions. But place it 100 feet in the air, and the thought comes into the mind of the consequences of a fall. This connects up with the Safety Urges in the astral body, and with those powerful desires of the Hereditary Drive for Self Preservation.

The structural steel worker and the steeple jack have so conditioned themselves as to keep their minds on the actions necessary to safety. They do not let the thought of falling come before their attention. But those not having this special training in keeping their thoughts on what they are doing and what they are going to do, let the image of the consequence of falling enter their minds. The autosuggestion of some persons when on a high place is so strong that they feel the impulse to cast themselves off. In others the autosuggestion of falling in conflict with the suggestion of not falling is an emergency situation the emotion of which releases adrenaline into the blood stream, mobilizing it for flight, and giving rise to giddiness.

To the extent the autosuggestion holds before the attention of the unconscious mind the image of falling is there a tendency to fall, because action is in the direction in which the desire energy is released, and desire energy is released in the direction of the image of falling. As the objective intention is not to fall, the energy thus tending to cause a fall is called Negative Desire.

Self-Consciousness

—Self-consciousness, as it is called, is always due to a Negative Desire that arises from autosuggestion. In this case, however, the thought-group in the unconscious mind tapped to furnish the energy leading to confusion is not that of the Safety Urges, but relates to the Drive for Significance.

The self-conscious individual has within his unconscious such strong desires to appear to advantage before others that the thought of committing any little blunder is very painful. Often he is overconditioned so that he magnifies the importance of the effect of his actions. His Drive for Significance having been thwarted in some respects has accumulated an expressed desires that have exaggerated, through excess energy, all matters relating to them. To him a little blunder in public seems as great a disaster as does the plunging from a cliff of one who greatly fears a fall. To make himself ridiculous is more than he can bear.

When he is called upon to give a little public speech, let us say, his conscious desire is to stand out as a superior being. It may be all well enough for others to exhibit imperfection, but to keep his own sense of unusual importance in the scheme of things, it is imperative that he make an exceptional impression of superiority. And the very excess of his demands increases the autosuggestion that he will not be able to meet these self-imposed requirements.

Previous frustrations of the Drive for Significance may have developed an Inferiority Complex. But at least they offer the autosuggestion that his actions will not be up to his own expectations. Thus is his attention drawn to other things than what he is trying to do. He thinks of his audience. This detracts from the clearness of his thought, because attention can be given to only a limited area at one time. Feeling a lack of clearness, due to the distraction of his thoughts by other subjects, he wonders what the audience thinks of him. This connects up with the fear of appearing ridiculous, which brings to his attention the image or thought of his failure.

Faced with the possibility of failure in a matter which means so much to him creates an emergency. An emergency is met by a release of desire energy sufficiently intense to be termed an emotion. The emotion, in turn, releases chemical messengers, or hormones, from his ductless glands into the blood stream. These mobilize the body to meet the emergency. Blood rushes to his face, and he flushes, or it rushes under the influence of the new chemicals to certain organs and thus away from his face, and he grows pale. The stress on his nerves, carrying the etheric currents to which have been imparted the energy of emergency desires, is too great for control and he trembles, perhaps his knees shake. And his awareness that he is not behaving according to the superior standard he has set for himself still further draws his attention to the image of blunders and failure. These images then divert the desire energies into activities that are their fulfillment.

Bashfulness With the Opposite Sex

—Of course any special desires that have been overconditioned through having excessive emotional energy imparted to them, may afford autosuggestions that give rise to Negative Desires. But the three Hereditary Drives, because they have acquired so much energy, are the ones which more commonly cause difficulty in this respect. As already we have considered examples of the effect of Negative Desires due to autosuggestions afforded by the Drive for Self Preservation and the Drive for Significance, let us now take an example due to the autosuggestions of the Drive For Race Preservation.

People who are not unusually modest, shy, backward or timid with their own sex, sometimes exhibit a decided and painful bashfulness in the presence of the opposite sex. In particular such persons are unable to deport themselves in an admirable manner when in the presence of the one person toward whom their affections are attracted.

Such an individual has an overwhelming desire to appear to the best advantage before his loved one. It is of tremendous importance that he make a fine impression, and that he should do just the right thing to win the object of his choice. His desires to thus deport himself are so intense that he cannot bear the thought of failure. The image of his beloved is, of course, brought into association with the Hereditary Drive for Race Preservation.

Most children have had the feeling of shame associated with reproduction and the opposite sex. They have been shamed out of doing things, or even of making inquiries about things, relating to sex. And many of them have thus become abnormally conditioned in reference to all actions that through association connect up with the reproductive desires, even in their finer and nobler expressions. To the extent, therefore, that their thoughts associate an individual with these irrepressible desires, the early conditioning by shame, frustration, or other emotion leads quickly to the thought of further failure. The presence of the love object, in most life forms, constitutes an emergency. Therefore, emotions run high, with the result that new chemicals are placed in the blood by the endocrine glands. This increases the circulation, and blood rushing to the face causes blushing.

Yet the individual may not be able to force himself to speak to the object of his affection, or if he does so he may stammer and make puerile remarks instead of the witty sayings he has rehearsed. He may appear awkward, or commit blunders that are quite foreign to his ordinary pattern of behavior. All are familiar, through the comic strips and the movies at least, with the performance of the bashful lover.

The cause of his backward or otherwise extraordinary behavior is due to a conditioning in the past which has associated the intense Drive for Race Preservation with images which are quite different from the actions his objective consciousness intends. If the character of his behavior were a matter of no great concern to him there would be weak Negative Desires. But their importance is so great that they suggest the possibility and consequence of failure. It is these energetic images which intrude and warp the actions into their realization.

How a Complex is Formed

—The psychologists call any group of ideas that belong together and have the same emotive tone a complex. That is, a complex is a group of thought structures within the astral body so conditioned that their desire energies tend to release in a common direction. Thus a “football fan” may have a “football complex.” But usually the word is applied to a system of ideas that have an unusually high emotional content; those that have in some manner become overconditioned and thus, because of the tremendous desire energy they contain, are dominating in their influence.

Such complexes are mentioned here because suggestion often has played so important a part in their formation, and because they in turn have such a power to determine whether or not a suggestion or affirmation will release energies in the direction intended, or in the direction of Negative Desires.

Some people have a complex in reference to a certain political idea. They have thought so intensely about the injustice of certain economic conditions, or about what seems to them the foolishness of some economic measure, that they have endowed this idea with a vast amount of energy. The more they discuss it and talk about it, the more feeling energy do they contribute to the desires associated with the idea. If in their various discussions with others they are strongly opposed, in the effort to overcome this opposition they develop strong emotions, such as that of anger. Thus, as the result of keeping the matter before their minds and repeatedly charging it with emotion, it accumulates so much energy that whenever the complex is tapped the behavior is somewhat abnormal.

Most of us are acquainted with the individual to whom we can talk about everything else, but in whose presence it is unwise to mention some one subject. In the presence of this individual if religion, or socialism, or political graft, or the indecency of present-day movies, or the horrors of war, or some special subject is mentioned, he becomes so highly excited that his speech and conduct are exaggerated. He may be well enough balanced on other subjects, but so much energy has been built into the thought organization within his astral body associated with this idea, that when anything touching it is brought to his attention giving these over energized desires opportunity to express, they are powerful enough to brush aside reason and judgment and habitual moderation. His friends caution others against releasing the complex by mentioning that he is touchy about such and such a subject.

Most of us are more or less touchy in reference to some things. And this means that in the conditioning of the past more energy has been added to certain thought groups in our astral bodies than their importance warrants. When something associated with one of these overconditioned thought groups is brought to the attention, this releases their desire energies, which are strong enough to make us feel, and perhaps act, out of proportion to what the situation normally requires.

These complexes which are repressed, that is, so strongly opposed by other desires as to prohibit their expression in a recognizable form, are the ones that cause the most difficulty. Their desires dammed up and crowded back are the source of a perpetual conflict. And this conflict continues to add feeling energy to them. Objective consciousness attributes the feeling to other causes, because it will not admit that the desires thus repressed even exist.

People, for instance, who are touchy about the indecency of others, show by this very overconditioning of the idea of modesty, that there are primitive desires within themselves in a state of repression. If no such struggle were within their unconscious minds there would be only a normal interest in the modesty or immodesty of others.

Reformer complexes, or “messiah” complexes are the “projection” to the outside world of conflicts within the unconscious mind. The individual’s Drive for Significance does not permit him to recognize he has desires which are not in conformity to the moral code which his objective mind has accepted. The struggle within himself (see birth chart of Billy Sunday in lesson No. 96, *Mental Alchemy*) gives him the feeling that something is radically wrong and needs remedying. The repressed complex struggling to find some outlet for its energy, finally does so through the avenue of endeavoring to correct the ills of the sin-infested world. And because the energy is associated through the struggle with a particular type of sin, that is the one to which the reformation is chiefly directed.

Something after the same manner are persecution complexes formed. The individual develops a war within himself which he projects to the outside world. Or, he may have developed so strong a sense of Significance that the suggestion is frequently given to his unconscious mind that he is quite a superior person. When he fails, or when misfortune befalls, instead of perceiving its true source of origin, which is his own character, he can not admit that he in any way could be to blame. When his employer discharges him, the true cause being blocked from his consciousness, he concludes It was brought about by an enemy.

Because it is noticed that he is so suspicious, and tends to accuse others for his troubles, he finds it still more difficult to make the headway he believes so superior a person deserves. More and more he blames other people for his real and imaginary misfortunes, and thus develops the persecution complex in which he believes there is a conspiracy against him. Should this complex develop far enough to cause him to take action to destroy some supposed enemy he thus becomes a danger to society.

Inferiority Complex

—The unconscious mind, and quite rightly, refuses to consider itself as of no significance. Every person has the wish and the will to be superior in some respect. As a matter of fact, each soul is struggling to develop those qualities which will enable it to fill in the blue print of its ego, and thus occupy a position in cosmic work that no other soul could so successfully occupy.

Therefore no matter how inferior an individual may appear to others, nevertheless in some manner he ever seeks to establish his superiority. He may satisfy this feeling of superiority through the facing of obstacles and overcoming them. Or if he can not overcome his obstacles he may at least find a feeling of superiority in some activity which is beneficial to himself and to society. On the other hand, instead of facing his obstacles, he may run away from them, and gain the feeling of superiority through various venues of evasion, such as day dreaming, nervous breakdown, dementia praecox, or some form of behavior which is inimical both to himself and to society.

All children have this desire for superiority. Yet they are surrounded by grown people who can do things quite beyond their power. Significance is usually measured in terms of human comparisons; and thus a child may get the suggestion that in most abilities he is quite inferior. A youngster who is brought up in the company of brothers and sisters who, because they are older, can do everything better than he can, may also thus get the suggestion that in all ordinary accomplishments he is handicapped by lack of ability. Especially if he is constantly reprimanded for not doing better.

Or he may get the suggestion of inferiority through the social station, lack of money, or peculiarities of his family. Children who are ridiculed by their schoolmates because their clothing is shabby, or who are shamed because of the eccentricity of a parent, or who constantly are scolded by their elders, sometimes permit these suggestions to build into their unconscious minds an unreasonable feeling of inferiority where ordinary undertakings are concerned.

Then again, when there is some organic defect, such as poor sight, tendency to illness, a crippled limb, or even when there is no real defect but the parents are over solicitous and cause the child to feel he is not fitted to do the things other children do, this may offer suggestions which accepted by the unconscious mind build up a feeling of inferiority in regard to all normal activities.

It is not whether the child is really inferior or superior that gives force to the suggestion. It is what his unconscious mind accepts as a measure of his own abilities. If he feels that he is handicapped in his efforts to express superior qualities, this constitutes a suggestion. Yet whether that suggestion is accepted and to what extent, is determined by the previous conditioning of the Drive for Significance; that is, by the thought structure relations mapped in the birth chart. Two children, although both are conditioned by their environment, when brought up under exactly the same circumstances, may develop opposite trends because one accepts the suggestions from without, and the other opposes to them autosuggestions of great intensity.

Any one of a wide variety of circumstances may be responsible for building into the unconscious mind an inferiority complex. The unconscious mind will not accept the idea that it is really inferior, yet these suggestions force home the conviction that in reference to ordinary activities it is sadly handicapped. Every experience in which the individual is made to feel—irrespective of the merits of his actions—that he has not done as well as is expected of him adds the emotional energy of disappointment to the thought group. Whenever he thinks of his handicap, real or imaginary, his sense of frustration adds more emotional energy to the thought organization related to the Drive for Significance.

The very fact that the Drive for Significance is repressed in its normal channels of expression by the thought group built into the unconscious mind through suggestions arising out of past experiences, tends to cause its desire energy to gain a very high state of tension. We say the individual is thus overconditioned in all matters relating to the unconscious feeling of superiority.

In the same manner that the man on a precipice who too strongly desires safety, being overconditioned where safety on high places is concerned, feels the impulse to throw himself off, so the individual who is overconditioned where Superiority is concerned is confronted by the images of what he has come to believe are his defects. Because of the over intensity of his desire to be superior, he tends to set too high a standard for himself. So much energy has accumulated behind the Drive for Significance that even a trivial injury to self esteem is too painful even to contemplate.

Thus the person with an inferiority complex has built up, as opposed to, and in the conflict with, the suggestion of inferiority, an image of so great Superiority that it may be quite beyond any human realization. Some of the most successful people, the energy for whose high accomplishment was derived from the effort to COMPENSATE for an inferiority complex, have continued to feel dissatisfied and that in spite of what the world said. they had done far less than they should. That is, the image of Superiority in their unconscious minds had been given so much energy that its satisfaction called for a degree of achievement quite unattainable to mortals.

The individual with an inferiority complex thus has two things to contend with. His unconscious mind, through conflict with the suggestions of inferiority, has over-energized the thought of superiority, so that he can not bear to think of himself making tiny little mistake such as normal people do. He feels that he should be so Superior that anything he does is absolutely perfect. Lacking any small degree of perfection would bring him great pain.

Yet the images of inferiority in certain respects have also, through the power of suggestion, become slightly energized. His objective mind has difficulties or handicaps over whatever it is that has given him the inferiority complex. Therefore, when he thinks of attempting something, these images are presented to his attention, and the energy of the whole Drive for Significance is diverted into them. He feels the need so strongly of being Superior to others yet these images of inferiority, reinforced with emotion, come before his attention. He not only dreads to attempt things that otherwise would offer no difficulties, for fear of exhibiting some small imperfection; but should he gain the courage to make an attempt, the images of failure are so strong as to attract his attention. His inferiority complex thus energizes Negative Desires that cause him to blunder.

Superiority Complex

—The strength of a complex depends upon the amount of desire energy it contains. Any complex, therefore, which can drain into its reservoir the energy of one of the three Hereditary Drives has possibilities of exerting a tremendous pressure upon the thoughts and actions. Also, any particular desire, through gaining sufficient emotional energy from experience or suggestion can become overconditioned. By overconditioned is meant that it has desire energy stored up in it under too great tension to favor normal thinking and efficient action.

As all persons inherently have the desire to be superior in some respect, it often requires no great amount of erroneous conditioning to store energy in the thought group having to do with Superiority under enough tension that its release leads to abnormal behavior. We have just discussed the common methods by which an individual acquires an inferiority complex. He has an inferiority complex because the thought group relating to Superiority has an overbalancing supply of desire energy.

Likewise, an individual only acquires a superiority complex when this same group of thoughts relating to Superiority gain an overbalancing supply of desire energy.

How, you may well ask, can one person have an inferiority complex from an overconditioning of the Superiority thought-cells, and another person have a superiority complex when these same Superiority thought-cells are overconditioned?

The answer is simple enough. When the Negative Desires direct the attention to the images of inferiority, the energy is drained into those images. But when the attention is directed to images that have been formed by the feeling of exaggerated importance in regard to all the individual does, he thinks and acts as if he were quite superior to other mortals.

The suggestions he has had in childhood have not been such as to oppose images of lack of ability or handicap. They have been such as to cause him to believe that anything he says or does is a little more perfect than what anyone else says or does. Perhaps his fond parents, or relatives, have started early to applaud each thing he did or said, always telling others in his presence how unusually bright he was. His attention was so often directed to his extraordinary abilities, and he gained so much emotional satisfaction from the constant applause that it built an unusual amount of energy into the Drive for Significance. And at the same time he received strong and powerful suggestions that his behavior was superior in all respects.

The later experiences of his life, which indicate to other people that he has no remarkable abilities, are powerless to displace these early images of his superior abilities. When he fails, the fact that he has failed makes little impress on his consciousness. He is always ready and eager to undertake responsibilities, even when he is unfitted to handle them. Even his commonplace sayings he considers to be exceptionally brilliant, and any little responsibility he shoulders he feels that in its performance he has accomplished something of importance.

An individual with a superiority complex has so much energy associated with the thoughts of his own Superiority that it gives dominating power to any thoughts and images into which that energy flows. And he has had the idea of his own perfection so thoroughly built into his unconscious mind that any thought relative to Superiority immediately directs the attention of the unconscious mind to these images of his unusual importance.

He may thus go through life, always seeking applause, always “playing to the grandstand,” coming into prominence as frequently as possible in the belief he is a very superior individual. He is not a good team worker, because he feels the urge so strongly to demonstrate his unusual talents, and usually also he works for praise and glory rather than to help the common cause along; because he has been conditioned to take delight in the praise of his cleverness and talent.

If, however, the person with a superiority complex finds too great a difficulty in adjusting himself to the failures, he may, as already explained, develop a persecution complex. One thing he will not do, he will not admit he is to blame for failure. Thus in seeking some seemingly reasonable cause he may consider that the world treats him unjustly. Otherwise he would gain the things his superior talents deserve.

Compensation

—As the energy of the three Hereditary Drives can not successfully be repressed, nor can that of any other highly energized desire, when one channel is blocked the energy seeks and finds some substitute outlet. Thus a desire that is blocked in one channel of expression is said to COMPENSATE by expressing through the substitute channel.

Those people, for instance, who did we not look deeper we might believe to have a superiority complex, often are driven to the actions we observe in the effort to COMPENSATE for an inferiority complex.

The individual with a real superiority complex does not brag nor pose. He knows his actions are perfect, and need no exaggeration to impress people. But the individual with an inferiority complex feels the need of impressing others because he is so uncertain of himself. When he tells a story, he always makes himself the hero. Feeling himself to be inferior, he tries to overcome his imaginary handicap by living in a world of make-believe. In his stories, in his boasting, and in his strutting assurance, he is playing a part, presenting himself to the world as he would like to be. But, because so much energy is dammed up behind the desire to be important, in this compensating outlet, he tends to overdo the part.

Bullying those who are weaker does not arise from a superiority complex, but as a Compensation for the feeling of inferiority. The youngster or adult who resorts to such practices feels the need of proving to himself that he is not so powerless as the inferiority complex makes him seem.

Even the dynamic “go-getter” who makes the sale when others fail, and who gets more work accomplished than his fellows, is COMPENSATING for a feeling of inferiority. He has to do more than others to prove to himself he is not the weakling he feels himself to be. His assurance is mostly “front.” Yet the suggestions of inferiority that have lodged in his unconscious mind, while strong enough to make him feel inferior, are not strong enough to dominate his attention.

In spite of the fact that they have overconditioned the desires relating to Superiority, giving them terrific driving power, he is able to keep before his mind the images of the things he wants to do. His desires thus release in the direction of these and are not switched over to Negative images. Thus all the energy of the complex is directed, in spite of recurrent inferiority feelings, into channels of real accomplishment. The tremendous energy many unusually successful men are able to devote to their work is often derived from the effort to COMPENSATE for a feeling of inferiority. One, off-hand, could mention a dozen such outstanding American characters.

(See analysis of Theodore Roosevelt and Mark Twain in lesson No. 95, *Mental Alchemy*) But as an instance from olden times think of Demosthenes. Compensating for an impediment of speech; placing pebbles in his mouth and declaiming against the surf that roared in from the sea, and becoming the greatest orator of ancient Greece.

Affirmation Should Keep the Attention on the Image of That To Be Accomplished

—As it is always the image before the attention of the unconscious mind that receives the major portion of the desire energy released at that time, the most essential factor in the successful application of suggestion is that the image of that which is to be accomplished should be the center of attention. Then, to give the image strength for accomplishment, it should be linked up with as powerful desire energies as possible. Those of the three Hereditary Drives serve this purpose admirably.

The negative form of an affirmation should never be used. If you offer the affirmation, “I am not ill,” it draws the attention of the unconscious mind to the thought of illness, and gives the illness more energy. If in the effort to overcome the tobacco habit you use the affirmation, “I no longer crave tobacco,” it will almost invariably increase the craving, for whatever energy the suggestion releases is directed into the thought of tobacco craving. If you offer the affirmation, “I am not afraid,” it brings before the attention of the unconscious mind the image of fear, and drains into it, through association, the energy of the Drive for Self Preservation.

Were it not for the variations in the thought organizations of different people that causes the same thought or image coming in as a suggestion to connect up with thought groups previously in the unconscious mind, the correct application of affirmations would require only that the suggestion be given in terms that would portray what is to be accomplished, and that it should be given positively at a time when the objective mind is inactive, and thus not setting up counter images. But the matter is not so simple as this, because the same suggestion offered to one person connects up with desire energies and images that have been conditioned in one way, yet when offered to another person connects up with desire energies and images which are conditioned to release energies in the opposite direction.

One person repeating the affirmation, I am well, just before going to sleep and just at the moment of awakening, while in the border state between sleep and waking, may be greatly benefited. Another person doing the same thing may find that the illness is growing worse. When the thought, “I am well,” is brought to the attention of his unconscious mind, it immediately connects up with the images of the illness. These autosuggestions, being stronger than the suggestions coming in, then draw the attention of the unconscious mind to themselves. The releases, thus are in the direction of illness, instead of in the direction of health.

Yet through a study of this second person's birthchart, or through finding out in some other manner how he has been conditioned in reference to certain strong releases of desire energy, it is possible to devise a form of affirmation which will not set up counter autosuggestions. If his Religious urges, for instance, have been such as to cause him to have a belief in the power and beneficence of Deity, the affirmation may be so used as to make such energies available. Many people whose unconscious minds immediately oppose to the thought of them healing themselves the autosuggestion that they will remain ill in spite of any effort of their own, nevertheless have a strong belief that God has the power to heal.

To the confirmed atheist, the affirmation, "God is love; God is everywhere; God's love has the power to heal; God gives me perfect health; I am getting well," would be opposed by the autosuggestion that God has no existence, therefore, I will remain ill. But to one whose religious training has given his unconscious—in spite of what his objective mind thinks about the matter—a belief in God's power, the suggestion that through God's love and power the health is improving is apt to offer no counter autosuggestion.

And right here a word should be said about the much abused idea of faith. In the matter of suggestion and affirmation it is not what the objective mind believes that is important; only what strong images are in the unconscious mind. If the disbelief in the objective mind is strong enough and repeated enough to build a counter image in the unconscious mind, so that the counter image gets the unconscious attention instead of the image suggested, the suggestion will merely draw more energy into this opposite image and cause what it represents to work out more fully. Yet thousands of people are healed of various complaints who are decidedly skeptical in their objective minds as to the possibilities of such methods.

Religious belief is one of the strongest organizations in the unconscious mind that can readily be used to get the attention and energy for suggested thoughts, because most children have accepted the power and beneficence of Deity. Even though in adult life they have no belief in such powers, yet the suggestion that the difficulty—physical, financial, or whatnot—is being corrected through the intervention of God's power, connects up with the Religious Urge thought organization in their astral body as it was conditioned in childhood. Their later beliefs have not had emotional energy enough to recondition this early-formed organization. Therefore, the unconscious mind offers no opposite autosuggestions, and the image is brought to its attention in just the form stated in the affirmation.

Detecting Possible Autosuggestions

—One method of discerning what probable autosuggestions will develop from using a given affirmation is to employ the method of Free Association. That is, while in a relaxed state of mind, such as is most favorable to receiving such a suggestion, state the affirmation once, just as it is intended to use it, and then let the mind drift. If the word strength, for instance, is the essential thought in the affirmation, note what associations this word has when permitted to follow the line of free association. If, when it is thus used, images arise in the mind in which one has used strength in the past successfully to overcome obstacles, or to accomplish some desired purpose, the word strength may very well be included in the affirmation. But if images arise in which lack of strength brought disaster, or in which lack of strength in some manner brought a disagreeable experience, that word had better be discarded, and another word sought.

Some people are so negative—as shown by the negative planets prominent in their birth-charts—that almost any suggestion offered in a very positive manner to them by another person is brought before, and held tenaciously by, their unconscious minds. But other people are so positive—as shown by the positive planets prominent in their birth-charts—that suggestions offered by others tend to develop autosuggestion images of much power. And these tendencies of the individual to react in a particular way because of basic temperament—that is, the birth organization of the thought structures in his astral body—must be taken into consideration in the application of suggestion and affirmation.

Yet by a study of this birth organization of the thought-cells and thought structures, and by testing out through the method of free association, the tendency toward certain forms of autosuggestion can be ascertained. Then such words, or such methods can be avoided as tend to release energy in the direction of Negative Desires; and affirmations can be devised such that their associations in the unconscious mind will connect them up with powerful desires already here, directing all into the desired channel.

How much is accomplished by the affirmations or other suggestions is determined by the amount of desire energy they can enlist through their associations and the attention given them by the unconscious mind. The direction in which these energies will work depends not necessarily upon the thoughts suggested, but upon the thoughts and images to which the unconscious mind has its attention directed.

Chapter 9

Serial No. 64
Original Copyright 1937
Elbert Benjamine

Copyright
Church of Light
August 2002

How to Think Constructively

Chapter 9

How to Think Constructively

CONSTRUCTIVE thinking depends upon the ability to direct the attention, and thus the thoughts, persistently to a predetermined subject. That is, not only must thoughts and feelings be selected which build as desired, but the consciousness must be engaged by them to the exclusion of other thoughts and feelings which are detrimental. It would seem proper, therefore, first to consider how the thoughts can be properly directed, and then to consider the thoughts and feelings which should thus be engaged for the most constructive results.

Already in lesson No. 57 (*Reason and Intuition*) the difference between Spontaneous Attention and Directed Attention has been shown to be the difference between permitting such stimuli as are present to hold the attention, and the critical selection of that to which the attention is given. And in lesson No. 58 (*Language and the Value of Dreams*), it was shown that most of the thinking of man, as well as of animals, derives from Spontaneous Attention, and because uncurbed by the critical faculties is called Fantasy Thinking; which is in contrast to Directed Thinking. And that Directed Thinking, with the Attention Directed by volition, consumes energy so fast that it is not merely the most useful, but the hardest work in the world.

All Objective Thought and Feeling Expend Electrical Energy

—To understand why this latest product of evolution, Directed Thinking, is such hard work that most people shun doing more of it than is necessary to survive, we must briefly discuss the late trend of material science in the discovery of the processes of Objective Consciousness, and the nature of the etheric energies which flow over the nerves. Objective Consciousness, as was explained in lesson No. 56 (*Doctrine of Esoteric Psychology*), embraces only such mental states as communicate their energies, through etheric motions, from the unconscious mind to the physical brain or nervous system in a manner that can be recognized.

In fact, as set forth in Course 1 (*Laws of Occultism*), it is only by utilizing etheric energies drawn from organic substance, that any discarnate entity can exert physical force; and only by means of such etheric energies that the soul can make contact with, and control its physical body. And material science now has not merely recognized this etheric energy to be radiant and electrical in character; but it has advanced a theory as to its production by the physical cells of organic life.

These cells are of protoplasm, just as the substance of the astral body is thought organized psychoplasm. And each of these cells has a nucleus of protein, which is comparatively acid. Surrounding this nucleus is the cytoplasm, which is comparatively alkaline. Separating the acid nucleus and the alkaline cytoplasm of the cell is a semi-permeable membrane. Electrolytes are thus formed of the humors of the body in such a manner as to make of each cell a miniature electric battery. The semi-permeable membrane separating the nitrogen fraction from the hydrocarbon fraction of the cell, and the membrane surrounding the cell, are adapted to storing and conducting electricity.

We have long been familiar with the idea that the heat and light produced in burning wood, oil, coal or gas is merely the release of the heat and light radiated by the Sun and stored in the plant. Also that the heat of the human body, and much of its energy, is derived from the release of solar heat from such carbon compounds. The green leaves of plants are able to store these solar energies in the process of photosynthesis by which they manufacture the carbohydrates from the carbon dioxide of the air and water.

But the function of the nitrogen compounds in releasing high-frequency energies is a later discovery. And material science now holds that these high-frequency energies, which are of far greater intensity than the heat radiations due to oxidation of the carbon compounds, furnish the electrical, or etheric energy which runs the body.

Nitrogen as it occurs in the air, due to the firm binding of its atoms in pairs, is one of the most inert chemical elements. But when these pairs of atoms can be rent asunder, nitrogen becomes one of the most active of all chemical agents, forming with the oxygen of the air the unstable oxides of nitrogen, such as enter into the nitro group.

Carbon compounds united with this nitro group form the most powerful explosives known. Glycerin, for instance, when the nitro group is added, becomes nitroglycerin; toluol, a coal product, when the nitro group is added becomes the explosive TNT. Iodine and chlorine are elements essential to human life; and the iodide of nitrogen is so sensitive it may be exploded by a delicate electric charge or a slight mechanical disturbance; while the rays of the sun, a slight jar, or the lightest contact with the fringe of an oiled feather will detonate chloride of nitrogen.

Part of the energy of TNT, nitroglycerin, and gunpowder is derived from the energy of solar radiation stored in the carbon compounds. But glycerin, charcoal, etc., by themselves can not be exploded. The high-frequency energy content of such explosives is due to the nitrogen compounds. And in protoplasm, carbon compounds—sugars and fats—are joined with nitrogen compounds, called proteins.

Scientists hold that the temperature of the surface of the Sun, about 6,000 C, is insufficient for its radiations to tear apart the paired nitrogen atoms of the atmosphere. Lightning, terrestrial electricity, and nitrifying bacteria, however, are able to do this. The Fixed Nitrogen Research Laboratory at Washington reports that one hundred million tons of nitrogen are thus fixed annually by lightning and carried to the earth's soil by the precipitation of rain, snow and hail.

And as having a bearing upon the production of certain types of psychic phenomena through the use of high-frequency etheric energies generated in the body, if temperatures sufficiently high can be obtained even enough electrons can be knocked off of atoms to change them into different elements. Dr. Bengt Hedlen, for instance, in the Institute of Physics at Uppsala University, through an electrical discharge attained a temperature of 500,000 C, causing copper to lose 18 of its 29 electrons, and thus converting it into sodium, which has only 11 electrons revolving round its nucleus.

Because lightning puts more energy into the fixation of nitrogen than the Sun's radiance puts into the carbon atom, the oxidation of a nitrogen compound, such as protein, emits a shorter wave than the oxidation of a carbon compound, such as the fats and sugars. That is, each cell of protoplasm, in addition to gathering heat, emits waves of high frequency, capable of knocking electrons off of atoms and thus creating an electric charge.

Such electrical charges, Dr. Edwin J. Cohn, Professor of Biological Chemistry at Harvard, found to be present on the giant protein molecules, which previously had been considered electrically neutral. Measuring these charges, he points out that the movement of such an electro-magnetic molecule operates like the armature of a dynamo. It produces an electric current. And these electric currents are the etheric energies which flow over the nerves and enable the mind to control the body.

It is thus held that protein molecules are able to release the high-frequency energy of the lightning which fixed the nitrogen that plant life took from the soil. This is in accordance with Einstein's Law of Equivalence: that the energy of an atom is given out in the same quanta as those received by the atom. And these short-wave radiations have properties with which we have become familiar in the radio. In fact, Dr. Cohn used the same technical developments in the measurements of the electrical properties of the giant protein molecules that have led to the improvement of the radio.

Of all the cells of the human body, those of the nervous system are best adapted to the production of short-wave radiations, as well as to carrying electric currents. And the gray matter of the frontal lobes of the brain are the best adapted of the nerve cells in this respect. These, because of their high specialization, are the ones chiefly employed in objective thinking.

However, this discovery of the electrical properties of protein proves that the nervous system of man is, as occultists long have held, a radio broadcasting set. And it also means, because the scientists have found these electrical phenomena of the nervous system to be reversible, as when the cells recharge in sleep, that the nervous system is a delicate receiving set, capable of intercepting shortwaves which reach it from other broadcasting sets.

Telepathy, which material science very reluctantly is being forced by the experiments of its own savants to accept, thus finds its explanation. And also, as telepathy more frequently is due to the broadcasting and reception of ether waves rather than those astral, it becomes apparent why the ancients classified thought-transference as one of the seven physical senses.

Chemists, for some time, have been aware that the long-wave heat radiations resulting from the oxidation of the carbon compounds were inadequate to account for the "hair trigger" violent adaptations of the higher forms of animal life; or even those rapid changes from inaction to action commonly observed. They knew that in some manner the iodine nitrogen compound secreted by the thyroid gland was involved in energy production, and that another nitrogen compound secreted by the adrenal glands gave energy of the most explosive type. In proportion to the size of their hearts, for instance, lions and tigers, which from a state of rest move into terrific speed, have unusually large adrenal glands.

To initiate the explosion of dynamite, or yet more powerful nitrogen compounds, it is customary to use still more sensitive primer or fulminate. It has already been mentioned that iodide of nitrogen is such a sensitive detonator; and observation indicates that adrenaline is even more powerful than thyroxin in the human body to release the short wave lengths which lightning or nitrifying bacteria have stored in the protein molecules.

Because, through his thoughts and feelings, man has the ability to increase or decrease his mental and nervous tension, which means the rapidity with which the nitrogen compounds release radiant energy, and so control the comparative shortness of the wave lengths emitted, he can thus tune in on various levels. And as etheric energies of the nervous system are ready transformers and conductors of corresponding astral broadcasts, he can tune in not merely on broadcasts through the ether, but on the astral broadcasts from the planets and from minds that no longer are of earth.

In fact, whether he is aware of it or not, he does thus tune in on the energy of any planet that makes an aspect in his chart by progression. If he has a progressed aspect to Mars, for instance, as explained in Lesson No. 61 (*How to Rule the Stars*), the Aggressive thought-cells in his astral body receive, through the aerial mapped by the aspect, an additional supply of energy. Because they have more energy, they can impart it to the nerves of the gonads and of the adrenal glands. This local electrical stimulation releases hormones in the blood. These reaching the cells of the body increase their electrical discharge.

These electrical discharges over the nervous system, unless there is a deliberate effort made to cultivate other thoughts, stimulate thoughts of the Aggressive type, which keep the nervous system constantly tuned to pick up still more of the Mars broadcast. But as the brain-cells generate high electrical charges under the processes of thinking and feeling, it is within their power to reverse the process. That is, properly Directed Thinking, instead of being stimulated by the electrical currents coming from the body cells, can initiate a current which stimulates another hormone, which in turn has quite a different effect upon the body cells.

This, in turn, tunes the nerves and energies flowing over them in on invisible energies of a frequency corresponding to the thoughts which initiated the electric flow. In other words, whether the electrical current is a response to an external stimulation which determines the quality of thought, or is a response to a type of thinking deliberately selected for that purpose or some other, when once initiated it tends to gain volume and perpetuate itself through the action of the hormones of the endocrine glands, and the energies of similar frequency picked up radio fashion, by the nervous system.

To be able, therefore, to determine in large extent, what planetary energies, what thought-energies radiated by others, and what character vibrations from objects, are picked up, radio fashion, by the nervous system and added to the thought-cells, to give them special types of energy, requires the ability to do Directed Thinking. And Directed Thinking, which is the only avenue to Constructive Thinking, requires that the brain shall develop and use a high electrical potential.

Each cell of physical life, whether a portion of a larger plant, animal or man, or independent of such an organization, is a generator of electric charges and radiates short wave length energies. Through etheric motions it is kept in contact with the four-dimensional thought-cells which constitute its intelligence. It is these four-dimensional thought-cells thus associated through short wave-length etheric radiations with the physical that, as cited in lesson No. 95 (*CS 9, Mental Alchemy*), enable blood corpuscles, epithelial cells, and various physical organs intelligently to continue their special kind of work even after they have been removed from the body of an animal. In the Rockefeller Institute for Medical Research, for instance, a chicken heart has been not only kept alive but beating in a glass tube of nutrient solution, and constantly growing, for 25 years.

So long as the electric equipment is able to perform its function of furnishing short wave radiations the thought-cells, which have gained their experience for such work in less advanced forms, are able to keep contact with the physical; and to exercise control of its movements through directing the flow of electrical energies. But when, for any reason, the battery runs down, the essential conditions of contact between the three-dimensional and the four-dimensional plane are no longer present, the thought-cells can not exercise control, and the physical is pronounced dead.

As explained in full detail in lesson No. 59 (*Desire and How to Use It*), not only the thought-cells which constitute the intelligence of physical cells and physical organs, but the thought-cells and groups of thought-cells which are embraced within the astral body of man, possess energy in a state of tension seeking release such as is called desire. Also even those desires which have been expressed and not recognized by the objective mind, give rise to tensions in the nervous system. These tensions are due to differences in electrical potential. That is, the thought-cells and groups of thought-cells within the astral body, to the extent they have permanently, or gain temporarily, an energy supply, are able to impart that energy to the physical, causing electrical charges of high potency to be generated in certain regions of the nervous system.

Electrical currents carry the reports of the various physical senses—hearing, feeling, seeing, tasting, smelling—to the brain. These are stimuli received directly from the three-dimensional world. And in addition, the more powerful thought structures of the unconscious mind impart the energy of their desires to electrical currents which flow to the brain. At times, due to the additional energy supply received from the planets when progressed aspects form, as explained in lesson No. 61 (*How to Rule the Stars*), these thought structures are able to bring a tremendous force to bear upon certain nerves, causing them to generate electric charges rapidly.

These electrical energies, generated through impact with the physical world and through energy releases from the thought-cells of the unconscious mind, reaching the brain, tune its physical cells to thoughts of a corresponding nature. That is, the attention is directed, not to some critically selected subject, but to thoughts relating to the stimuli. The thinking which results is called Fantasy Thinking.

The Electrical Function of Rest and Sleep

—In order for the brain cells to vibrate sufficiently to register as objective consciousness, electrical energy is expended. The cells of the gray matter of the brain are the most effective electric batteries of the body. Yet all conscious thought consumes electric energy, and tends to exhaust the electrical charges formed by these cells. And like any electric battery if the circuit is kept closed it tends to run down. If you keep your foot on the starter of your car, you are aware that the current weakens, and if this is continued your battery goes dead. So, not only with the brain, but with every cell and organ of the body, if it is to continue to perform its function it must be given an opportunity to recharge.

Yet if, before a battery is dead, the circuit is broken, it recharges itself. For a battery thus to recharge, it is necessary for it to have resting periods. And all the organs of the body are provided with such periods of rest in order that they may not become completely polarized, or dead. The nerve cells that operate the breathing, for instance, thus rest, from sixteen to eighteen times per minute. The heart and its nerves take from seventy to ninety short rests between beats per minute; and the various other glands and organs take brief rests between their periods of rhythmical activity.

The brain, because its effective use requires a longer period of activity not broken by short periods of loss of consciousness, has developed the power to generate moderately strong electrical currents over considerable length of time. Yet, for it to recharge, it also must have a period of rest commensurate with the work it has done. Commonly, this period of rest is about eight hours out of each twenty-four. This period of rest, during which the cells of the brain recharge, is known as sleep.

A rabbit kept awake, but otherwise kindly treated, always dies, usually on the fourth or fifth day. Other animals and human beings, prevented from sleeping, also die. They die because the circuit has been closed so long the battery has completely run down. It has had no opportunity to recharge.

Rabbits and such animals as have been kept awake by scientists to determine the electrical effect of loss of sleep, have been given the minimum amount of stimulation to keep them awake. But college students, used for the same purpose, have been tested in connection with degrees of mental activity. The more intense the mental activity and the more concentration required the sooner exhaustion was observed.

Directed Thinking Requires High Electrical Expenditure

—In electrical terms, this means that to keep the attention Directed to some predetermined line of thought, the brain cells related to this line of thought must generate, or mobilize, an electrical potential higher than the electrical potential generated, or mobilized, by the brain cells receiving stimulation from the desires of dissimilar thought-cells or from incoming nerve currents. In other words, the thoughts to which the attention of the objective consciousness are given, must be able to command and use electrical energies of higher voltage than other thoughts which compete with them for attention can command. Or, to put it in another way, the thoughts which can muster the highest electrical potential, by virtue of the greater energy they can impart to the brain cells, are the ones which gain objective attention.

Yet at all times there are energetic thought-cells within the unconscious mind whose desires strive to gain recognition, and at all times stimuli from the outside world coming in over the nerves that tend to give electrical impulses to brain cells and thus gain recognition. These are the sources of Spontaneous Attention and the guiding influences in Fantasy Thinking. And that they may not thus gain recognition, and

dominate the thinking, the thought-cells within the astral body which relate to Directed Attention must be able to mobilize in the brain cells used in the Directed Thinking, an electrical energy not merely strong enough for recognition, but with a potential sufficiently high that it can overcome, and displace, the electrical energies stimulated by Spontaneous Attention.

We all know that the greater the distractions, the more difficult it is to keep our minds on our work; and that when some crisis in the life had developed, it may be almost impossible to give sufficient attention to ordinary duties to perform them properly. Such stimuli, from the outside or from within, under these circumstances, are strong enough to generate electrical charges of sufficient power to be able to displace those which we are able to generate by Directed Attention.

When, under such circumstances, we do keep our thoughts effectively upon our work, it is at the expense of a tremendous amount of vital force, that is, of electrical energy, and we quickly tire. Directed Thinking requires not merely an expenditure of electrical force to vibrate the brain cells properly as in Fantasy Thinking, but it must employ in addition, electrical energy sufficient to overcome other electrical impulses which compete with it for objective attention.

Because it must consume so much electrical energy in overcoming these resistances, and because such thinking is a recently acquired biological process, Directed Thinking is the hardest work in the world.

Self mastery and the intelligent conditioning of the desires, as well as the ability to think problems through and to act upon conclusions derived from reason, rather than acting from blind impulse, depends upon Directed Thinking. It is therefore of utmost importance to every person to be able to employ it. But it can not be acquired merely through wishing or willing. Like all other human activities, it is a Conditioned Process.

To acquire proficiency in it, therefore, it should be practiced regularly. Yet because it is such hard work, consuming much energy, unless this practice is properly approached, it is painful. Work in general, as distinct from play, of itself is painful; and the harder it is, the more painful it becomes. Therefore, unless associations are employed which give a feeling of pleasure, the painfulness of the process tends to cause it to be shunned as much as possible.

Cultivating Directed Thinking

—However potent painful conditioning energy may be to cause the thought-cells containing it to attract events from the four-dimensional plane, objective consciousness, for its own preservation tends to repress and forget that which gives pain. For Directed Thinking to get attention sufficient to become habitual, therefore, whenever it is employed it should be considered in connection with the satisfaction it

gives to numerous other strong desires; that is, as explained in lesson No. 60 (*Why Repression is not Morality*), in reference to Sublimating Desires, through artificial association it should be made as highly pleasurable as possible. Thus to be able to direct one's thoughts and one's destiny should give high satisfaction to the Drive for Significance. And because it can be made a means by which any of the other nine types of desires can more fully be released, dwelling on these in connection with a period devoted to Directed Thinking will tap their desire energies. And when through such associations Directed Thinking becomes sufficiently pleasurable, the pleasure will make it habitual.

Because it consumes so much electrical or vital energy, intense Directed Thinking soon leads to exhaustion. People, when they are tired do not think as clearly as when rested, because there is insufficient electricity at their command. High executives, for this reason, usually refuse to make important decisions when fatigued.

We can not expect to keep our brains intensely at work over long periods of time. But with the desires of the thought-cells relating to Directed Thinking sufficiently conditioned with pleasure to keep their main objective before the attention, it is not depleting to keep the mind enough occupied with beneficial thoughts, that non-beneficial thoughts, and destructive thoughts will not be able to intrude into objective consciousness.

This implies that the individual has cultivated a number of harmless yet pleasurable interests, to which, when his brain is not engaged in work, he can turn his attention, and which have enough desire energy that it requires a minimum consumption of electricity to keep thoughts relating to them before objective consciousness. An individual can not think of nothing and at the same time remain awake. If his attention is not occupied with beneficial thoughts it is sure to be engaged with those less constructive.

And as he can not work too continuously, both sleep and recreation are essential if he is to keep his thinking consistently constructive.

Common Hindrances to Constructive Thinking

—All action, as so thoroughly set forth in lesson No. 59 (*Desire and How to Use It*), is due to the release of desire energies stored through Conditioning in the thought-cells and thought structures of the astral body. The direction in which the action moves, whether that action is on the four-dimensional or on the three-dimensional plane, is toward seeking satisfaction for the desires. But the channel through which this satisfaction is sought is determined by the manner in which the desire energy has been Conditioned to find expression. When desire energy has been so conditioned that it repeatedly finds expression, and therefore at least some satisfaction, in a certain action, this constitutes a habit.

When desire energies within the thought-cells or thought structures of the astral body acquire a tension, or potential, sufficiently high to gain the attention of the objective consciousness, their energies are imparted to the etheric energies of the brain cells. They generate electrical charges which initiate nerve currents that produce glandular or muscular activities.

Visual images, auditory impressions, and other perceptions, as explained in lesson No. 58 (*Language and the Value of Dreams*), are the customary means by which the unconscious mind communicates information to the physical cells, physical organs and glands. It is not within their province to distinguish between an image more directly from the three-dimensional world and an image formed in the imagination. The reactions of fright or anger are just as strong when one mistakes a friend for a dangerous foe as if the dangerous foe were actually present.

Nor do the desire energies of the thought-cells and thought structures of the unconscious mind discriminate, unless they have been Conditioned to do so, between gaining satisfaction through imaginary accomplishment or through real accomplishment. Their energy is released quite as fully through either channel; and having been expended is not available for further activity.

In either case the desire energies cause electrical charges to be generated in the brain and nervous system, and electrical currents to flow. But if the satisfaction is obtained through imaginary exploits, the electrical currents initiate less pronounced muscular contraction and spend their energy chiefly in those emotional discharges that affect the glands.

Not only is the desire energy of the unconscious mind expended in imaginary accomplishment; but the physical vitality, or electrical energy, of the nervous system also. The person who day dreams is using up both thought energy and electrical energy which could be used for some actual accomplishment. And if his emotions are intense he is quite as fatigued as if he had been doing practical work.

Many people find that if they tell their plans to others that they never realize them. They thereafter begin to lose interest in the project about which they have talked. These people get so much satisfaction about what they are going to do, that it drains the desire energy which is seeking satisfaction in the contemplated project, and none is left for the actual work. That is, they have conditioned their desire energies to find release and some measure of satisfaction, through the mental pictures and the emotions which accompany a discussion of their future realization. To the extent the energy is thus spent is there less desire left for actual accomplishment.

Yet other persons, if they tell their plans, almost invariably carry them through. They have Conditioned the Drive for Significance so that, once they have committed themselves to others, its whole force is thrown behind the project. After stating they were going to do something, if they should fail to do it they feel they would not only lose face with others but with themselves. Such acknowledgment of inferiority is more than they feel they could stand. Consequently, once they have told others what they are going to do, they do it or die trying.

Energies of Emotions Should Be Utilized in Action

—Because actual accomplishment is always at the expense of desire energy and the electrical energy generated by it, it is a sheer waste of valuable assets to permit the finer sentiments and emotions—when through reading, through hearing music, through witnessing a good movie, or through other stimulation they have been aroused—to expend themselves merely in feeling and the accompanying glandular reactions.

Such emotions and sentiments as well as those less pleasant were developed for the purpose of meeting actual situations and doing something about them. Their energies can find sufficient release in the feeling which accompanies the mental images to give them some degree of satisfaction. And, like the energies released in day dreaming and in talking about what is to be done, unless they have been conditioned to express in action, it is much easier thus to give them satisfaction than to direct them into channels of actual work.

But constructive thinking demands that when an emotion or a sentiment is felt that its energies be used in doing some constructive thing. Furthermore, the body will be more healthful if given a task such as will utilize in a constructive manner, the activities for which the glands have mobilized its forces.

When, therefore, music, the screen, or reading has been of such a character as to give the impulse to do something noble, take special pains to decide right then to do some good deed. And having thus decided, be equally sure later to find some good deed to do, even though it be unimportant, and to carry it through. The importance of the worthy deed is not so significant. The significant thing is that, if every time a noble impulse is felt, or an aspiration to high endeavor, this desire energy of the thought-cells and thought structures is released, not merely in wishing to do something fine, but in real action, this Conditions such energies to find habitual satisfaction only through deeds. And such a habit once formed, because it uses desire energy so effectively, is sure to lead to real accomplishment.

Painful thoughts and their attendant emotions should be avoided as much as possible, through displacing them with pleasant thoughts and emotions. When, however, anger, fear, sorrow, lust, despair, or other painful emotion has been permitted, that is, when the tension of powerful desires is released in such a manner that they create a widespread and painful disturbance of the nerve centers, it is unwise to permit them to dissipate their energies merely in mental images. Such nerve currents mobilize the whole body for a certain type of action. And if action results, it not only ameliorates the tendency to chemical imbalance and consequent disease but it Conditions the habit of accomplishing something with such desire energy as finds release.

Whenever the body is mobilized to meet an emergency, as is the case when an emotion is present, that energy can be employed either in actions that are detrimental or in actions that are beneficial. Therefore, when irritation or anger, in an unguarded moment gets the mastery, find, as quickly as possible, some constructive work to do. Hard physical labor in which the thoughts must be applied to the work is a good way to expend such energy; or concentrated application to some mental problem that needs solution. That is, an attack on some physical object or mental problem which when defeated will prove beneficial, is substituted for the attack on a human enemy. And when the obstacle is defeated, whatever it is, to further condition the energies, the full glow of triumph should be felt.

Under the emotion of fear the body is mobilized to run away. Despair is a fear so great that it presents no images of possibly averting disaster. Sorrow and grief are fears for self satisfaction due to loss; and worry is a succession of small fears that conditions will not be successfully met, or that in the past they have not been met to best advantage. These, and all other negative desires, as explained in lesson No. 63 (*The Correct Use of Affirmation*), through directing the attention and therefore the energies into images of things to be avoided, tend to bring that to pass which is most feared. In this they are in direct contrast to caution; which is an intellectual appraisal, unaccompanied by emotion, of a situation for the purpose of deciding the best course of action.

Yet fear, as well as anger, mobilizes energy for action. And these energies should be used courageously in some constructive work. Yet thoughts about self and the effect of things upon oneself, which then tend to intrude, draw the attention to negative images. Therefore, if difficulty is experienced in diverting the energies of a negative emotion, such as fear, into productive channels, so strong an interest should be developed in assisting others, or in some unselfish work, that the mind is taken from thoughts about self.

Discordant emotions arising from the reproductive impulse, because in their essential nature they are creative, should be expressed in beneficial creative work of some kind. When they are present the body becomes mobilized for creative work. And the energy may be used to advantage in designing a house, in artistic work, in music, in writing, in mechanical invention, or in some other channel which is clearly creative in nature.

Displacing Painful Thoughts

—It is better not to permit painful thoughts to enter the mind, or for discordant emotions to be present. If one realizes that progress is only possible through acquiring ability to overcome difficulties, and that the only manner in which this ability can be acquired is through experience in overcoming difficulties, there will be less of a tendency to harbor painful thoughts when difficulties are present.

Situations, whatever they are, should be analyzed intelligently, to discern the best course of action. Such examination of the various factors, even if those factors menace life or happiness, so long as the process is a product of impersonal Directed Thinking to that end, is accompanied by very little feeling. It has little power to Condition the thought-cells, or to release emotional energy.

But after the period deliberately chosen for the purpose of carefully analyzing the best manner of meeting a difficulty has passed, and a decision as to the best course of action has been made, the attention should be kept away from the painful images which it suggests.

Yet, as the objective mind can not remain a blank and retain its consciousness, the only manner in which its attention can be freed from the painful images which tend to intrude when grave difficulties arise, is to give the attention so thoroughly to more pleasant interests that these completely occupy the thoughts.

Irritation, lust, fear, despondency, discouragement, worry, sorrow or any other painful thoughts or emotions are increased by giving attention to them or to their objects. The problem of preventing such thoughts, therefore, is that of having constructive interests of some kind, including recreational activities, which have acquired sufficient pleasurable Conditioning energy that when the attention is Directed to them it requires little volitional energy to keep them before consciousness.

For each type of painful thought there is a specific type of thinking and specific interest which is best to use in displacing it. These Mental Antidotes are given in detail in lesson No. 97 (Course 9, *Mental Alchemy*). But at least each person, whether familiar with these or not, should have, or cultivate some activity to which he can turn, in times of stress, with the assurance it possesses enough attraction to take his mind off himself and his problems.

Painful thoughts of all kinds thrive on introspection and consideration of self. In the office, or about the home, therefore, when annoyances or irritations develop, the sooner the attention is turned from them to whatever work needs to be done the better. And when worries intrude, or there has been a loss that tends to give rise to grief, the more completely the attention can be given to some positive work the better. And because the negative emotions arise from thoughts of effects upon self, nothing is better than to become so busy and occupied in helping some other person, or in assisting some worthwhile cause, that there is no time for thinking about self.

For the most effective type of living, those thoughts and activities should be selected which, after thorough analysis, are considered to be most highly beneficial. But these thoughts and activities should not be painful. As explained in lesson No. 60 (*Why Repression is Not Reality*), any type of thinking and any kind of activity may be conditioned, through association with the various other desires, so that its presence

will give a feeling of pleasure. This feeling of pleasure attracts the individual still more strongly to the thoughts and activities, tending to make them habitual. And in addition, it causes the thought-elements and thought-cells then built into the astral body to be harmonious enough to work from the four-dimensional plane to attract fortunate events into the life.

Whether in thinking or in acting, it is poor technique to be scourged to it by a sense of duty. Instead, as much pleasure as possible should be taken in such as is deemed beneficial.

Developing Will Power

—Most people know that worry, fear, anger and despondency are destructive, and set their will against them. But this avails little, because Fantasy Thinking is so habitual that they can not keep their thoughts Directed to other things.

Will power itself is merely a habit that has been Conditioned of carrying to conclusion those things resolved upon. Every resolution carried out as determined conditions a strength of will. Therefore, we should never make resolutions that are beyond our abilities to carry out. All matters of consequence in life that call for decision should be carefully analyzed in detail. Writing out all factors that favor each side of a decision helps prevent desires, other than that to give a correct appraisal of the situation, from warping the judgment. In arriving at a judgment, sensation and emotion should be held in abeyance.

But when the decision has once been made, the integrity of the character depends upon following out this predetermined course of action to the letter and in the face of all obstacles. To permit impulse, passion or pain to divert the efforts from the course decided upon is to dethrone the will and cause the character to revert toward the animal state in which spontaneous desire is the sole director of effort.

People of fixed wills have thus cultivated a habitual mood of resolute determination. Thus also, people of energetic will, through Conditioning, have cultivated a permanent mood of energetic activity. This mood vitalizes whatever they attempt to do.

To develop such an energetic will, and to live to better advantage, we should make a daily practice of Directed Thinking. Whatever requires our attention should chain our thoughts to the exclusion of irrelevant images. When we talk, our minds should be keenly interested in the conversation and never permitted to wander off in day dreams. When we read, we should think only about that which we are reading. When it becomes desirable to think about something else, we should put other thoughts and effort from our minds and concentrate the attention on it. When working, all the attention should be directed to the work; and when playing all the attention should be given to play. Nothing should be done half heartedly. Either put all the energy of the mind into it, or do not do it at all.

With such constant training in Will and Directed Thinking, but not through merely willing to do so without the Conditioning process, one can acquire the ability to entertain, even under the most trying circumstances, only Constructive thoughts and emotions. These, in turn, displace those which hinder spirituality, usefulness and happiness.

Chapter 10

Serial No. 65
Original Copyright 1937
Elbert Benjamine

Copyright
Church of Light
August 2002

How to Cultivate Subliminal Thinking

Chapter 10

How to Cultivate Subliminal Thinking

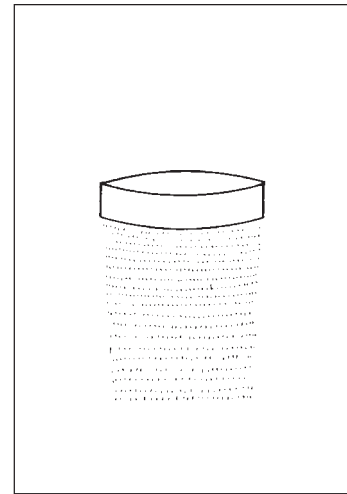

STARTLING as it may seem at first thought, it is nevertheless true, as demonstrated by the research of laboratory psychologists, that most of man's thinking is done below the threshold of objective consciousness. While this type of mental activity may be called unconscious thinking, many psychologists still prefer to employ the words sub, meaning under, and limen, meaning threshold, and thus refer to those mental processes which take place below the threshold of objective consciousness as subliminal thinking.

As to their prevalence, an eminent psychologist has quite correctly compared man's total thought to an iceberg; the small section appearing above the water representing by proportion objective thought, and the immense volume out of sight beneath the waves representing by proportion the vast bulk of subliminal thought.

A wide variety of experiments have been devised to demonstrate that streams of thought constantly pass through the four-dimensional consciousness of which we have no objective recognition; and that these thought processes of the unconscious mind are more active and numerous than those which are successful in imparting their vibrations to the cells of the physical brain and thus gain objective attention. One of the most interesting and convincing of these experiments illustrates the inability of anyone to pick a name or number at random. Careful analysis by the method of Free Association, which is explained in lesson No.100 (Course 9, *Mental Alchemy*), reveals that every such attempt brings to the conscious attention a name or number which, without being so recognized by the objective mind, is associated with, and thus becomes the symbol of, some strong desire.

For instance, one man desired to choose a name at random for a character in a book of fiction he was writing. Afterwards, when asked why he chose that particular name he replied that there was no reason, as he could remember no person having that name. Psychoanalysis, however, caused him to remember events of his childhood long forgotten, as he thought. And a continuation of the process, much to his

astonishment, enabled him to remember a person bearing the name he had given to the fiction character. Furthermore, the most pronounced characteristic of this person was that which he wished to portray by the character in his story. He thought he chose a name at random, but his unconscious mind had really given him the name of a person he had known who exemplified the traits he wished to set forth.

Dr. Jones tells of a man who defied him to connect a chance number with anything significant in his life. When asked to select such a number he chose at random 986.

Free association was then applied by Dr. Jones. Very quickly it brought to the man's mind the memory of a very hot day six years previous, when the newspaper, omitting the decimal point, had quoted the temperature as 986 degrees F instead of 98.6 F.

At the moment this number was selected the man had just drawn back from a fire in front of which he was seated because of its intense heat. The heat of the fire had suggested to the unconscious mind the hottest day of which it had knowledge. This, of course, is in conformity to the LAW OF ASSOCIATION, by which succeeding mental images are always related through Resemblance or Contiguity with those to which attention previously had been directed.

As this hot day in itself was not significant of any important desire, the Free Associations were continued. And they brought out that this man was greatly worried because of a noticeable lessening of youthful vigor and energy, which he had come to believe was due to excesses in private life. The fire in front of which he sat reminded his unconscious mind of the energies he had wasted in passion, and when he tried to think of a number at random, the unconscious mind projected into his objective consciousness one that symbolized the private dissipations that were draining his life forces. 986 was the symbol of excess, drawn to objective attention through his desire to reform.

Cause of Laughter

—In a not unrelated way laughter is the expression of a desire whose existence is not consciously recognized. The group of thought-cells whose energies express as civilized conduct are strong enough to exercise considerable censorship over the expression of gross, brutal and savage desires. Yet the three hereditary drives, and perhaps some others, always have thought-energy in a state of tension, striving for release. And as considerable of their energy was derived from experiences in lower forms of life, they merely require the removal of censorship restraint, or the sanction of civilized custom, under appropriate stimulus, to spill over into the nervous system and produce rather violent and widespread disturbances.

Significance is attained largely through comparison with others. A person who is conscious that he makes mistakes is apt to feel less inferior when he perceives that other people make mistakes that are quite as serious. This tendency to bolster up the feeling of superiority, not through the attempt to reach a higher level, but through tearing other people down to a level as low, or lower, than one's own, is a trait taken advantage of by politicians and the news sheets.

The unconscious mind, in its frantic effort to maintain its own sense of superiority, tends to believe, as a wish-fulfillment, whatever charges of incompetency or immorality are brought against others who have attained more wealth, higher social station, or political importance. That these individuals have attained the things it desires, but has failed to reach, is a challenge to its sense of importance. It does not like to admit that others have greater ability or more worth. Consequently, when these people who have attained to greater success or importance get into difficulty, or charges are brought against them, this gives the thought-cells related to significance great pleasure. They feel of greater significance than before, because by comparison the individual in whose unconscious mind they reside is made to seem equal or superior to these others.

The tendency of some to disparage the characters of others as well as the tendency to over-criticism, has back of it as a rule no conscious malignancy. It arises from a conscious feeling of inferiority, and the endeavor to compensate and find satisfaction for the drive for significance, not through constructive channels, but through the subversive means of making others seem inferior.

Yet the same individual, who habitually believes the worst, and tells the worst, about others; when he champions a cause or an individual, is equally prejudiced in its favor. This is because he then sympathetically identifies himself with the individual or cause. The cause or the individual then seems an expression of himself. He enjoys vicariously its virtues and its triumphs; and the greater its merits and the more pronounced its success, the more his own sense of significance is elevated.

When others make mistakes, blunder, or appear at disadvantage, this, by comparison, raises the individual's estimation of himself. If the mishap to another is serious, the energies of the more civilized thought-cells are released, rather than those of the drive for significance. There is a feeling of sympathy for the other, with the impulse to do something to remedy his plight. No one could laugh at the death of another; because, even though it brought a consciousness of superiority, and some very tangible advantage, the thought-cells stimulated more directly by a tragedy are those whose desires strain for release in efforts toward the preservation of human life.

But when another places himself in a position of inferiority through some error or action of no great consequence, such as through a blunder in action or in speech, this affords the necessary stimulus and the avenue to objective consciousness, through which the desire energies of the drive for significance find access to the nervous system. They generate electrical currents that flow over the nerves and produce laughter.

That which is humorous releases desire energies that have attained a high degree of tension through presenting situations in which no one suffers severe harm. Wit also, if cleverly applied, suddenly releases desire energies which have tension enough when they find access to the nervous system that they produce laughter. But wit is not altogether harmless. Too frequently it wounds someone, or tends to cause him too painful discomfort. Therefore, while people laugh at witty remarks, because it enables some strong desire to find violent and pleasant release, they unconsciously tend to distrust and resent the one who thus causes others pain. People who wound others, even when in so doing they cause laughter, are never popular.

Yet an individual can poke fun at himself and everyone will like him, because the drive for significance finds so much satisfaction in releasing its energies through perceiving weaknesses in someone else. And when an individual deliberately holds up his own weaknesses, no resentment is felt: for it is recognized that he is not suffering greatly, but apparently finds pleasure in pointing out his own follies.

It might seem strange that an individual could find pleasure in his own discomfort were it not for our understanding of the process of conditioning. Some people never laugh at their own mistakes who laugh boisterously at the mistakes of others. But there are those who have conditioned themselves to view their own conduct as it appears to others and find keen pleasure in discovering shortcomings and errors. It gives them a sense of superiority, and thus releases the energy of the drive for significance, to be able to recognize that which is ridiculous, even if it pertains to themselves.

Ability to do this is a valuable asset; because when we recall any situation of the past, or view any predicament of the present, as a subject of merriment; when we honestly can laugh at it; this releases its emotional energy. It also reconditions the thought-elements derived from the experience, which may have been repressed, and through the pleasant conditioning energy thus contributed, prevents the formation of an inharmonious thought-compound.

When people take themselves and their affairs too seriously there is apt to be painful conditioning energy built into the thought-cells whenever things do not go just as they desire. To prevent this, a sense of humor becomes highly valuable. Furthermore, when some repression causes difficulty, if it can be recognized through Free Association or some other method, and can then be seen, not as the tragic thing which it once appeared, but as having a humorous side, so that it provokes laughter, this will

release the repression, recondition the thought-cells associated with it, and remedy the difficulty more effectively than any other method. When you can laugh at experiences that when they occurred gave rise to shame, embarrassment, feelings of inferiority, remorse, ungoverned grief, etc., the emotional energy they built into the astral body will no longer be able to do much harm.

But laughter may be caused by the energy releases of other powerful desires as well as by those of the drive for significance. The drive for Self Preservation and the drive for Race Preservation also have thought energies that with proper stimulation find emotional release. The typical Jewish jokes, that is the jokes in which custom makes the traditional shrewdness of the Jewish people the central pivot, release the energy of the Drive for Self Preservation. One individual, in such stories, through some clever device or cunning deception, attempts to get the better of the other in a bargain. Business transactions are related directly to self preservation, and the recognition of the trick by which advantage might have been taken of the individual had he been unaware of it, gives pleasure to the thought-cells relating to self preservation, and releases their energies.

In a similar manner the traditional thrift of the Scottish people affords no end of jokes. Self Preservation requires in all of us the practice of economies against which there is a feeling of resentment. We would like to spend more freely, but the desire for safety imposes restraint. Yet in comparison to the stinginess of the central character of a Scotch joke, our own expenditures seem pleasantly generous. The energy of the Drive for Self Preservation which has been placed under restraint by fear of privation, thus is tapped and finds violent and pleasant release, generating electrical currents that give rise to laughter.

Similar electrical currents, stimulated by mechanical contacts which produce the sensation of tickling, may likewise produce the physical response of laughter.

In the jokes with sexual implications the energy release is, of course, that of the Drive for Race Preservation. The individual may not recognize the presence of sensual desires; but the reproductive desires have energy straining for satisfaction. Through the cunning wording of the joke, its suggestiveness instead of its more obvious statement, the energy of the reproductive desires are able to slip by the censorship of the more highly civilized thought-cells and into consciousness, imparting their energies to the nerve currents in a manner that causes laughter.

Thus the kind of jokes an individual laughs at, and the things he considers funny, are a rather good measure of his intelligence and spirituality. Among those of little sensibility, a serious injury, or even a disaster, to another may seem funny. Their sympathies are dull and it gives release to the feeling of superiority. Among those with little inclination for honesty, the cunning robbery of someone, even though it causes great hardship to the one deprived, may seem a good joke. And crude clowning on the vaudeville stage, or on the screen, defying plausibility in that no one unintentionally acts so foolish, to one of low intellectual perception, will seem funny. But a more intelligent and spiritual person will merely be revolted by such crudities.

That which is obvious in its sensual implications may evoke boisterous hilarity from those who inhabit the slums; but would be considered merely repulsive and gross to a more refined person. Yet much the same story, if cunningly enough arranged that its true implication can barely be glimpsed, can be told at a tea-party to cultured people and provoke merriment, and be pronounced quite clever.

Any number of jokes and witty retorts could be cited and analyzed to show that in each case the merriment was due to the violent release of the energy of powerful desires; those suppressed, because their energies are under higher tensions, more often being the source of the emotion. For instance, an old Colonel approaching Disraeli remarked: "Beware of tobacco, my boy. Women do not like it; it has ruined more charming liaisons than anything else I know."

To which Disraeli gave his famous retort: "Then you must consider smoking a highly moral accomplishment."

The Colonel's speech was funny only because, under an apparently friendly admonition was concealed the implication that Disraeli cared more for a liaison than for smoking or other more legitimate pleasures. And Disraeli's reply was funny because of its hidden implication that if tobacco were a preventative, society would suffer less if the old Colonel, who had merely judged Disraeli by his own poor standards, did more smoking.

Cause of Swearing

—Because the strongest repressed desires possess energy under the greatest tension, the jokes releasing their energies are the ones people laugh at hardest. Likewise, people swear and cry to release desire energies of high tension which can find no more adequate methods of expression.

The emotion of anger may find some relief through swearing if it is not permitted to express through more overt actions. Instead of lashing at an opponent or at an obstacle with the fist or foot the individual lashes out with his tongue, and gets some measure of satisfaction.

Weeping may be from grief or from joy. In either case the desires are stimulated to an intensity sufficient for emergency purposes; and when they impart their energies to the nervous system the electrical effects produce a profound disturbance, with glandular reactions which are beyond control.

Furthermore, even when the cause of the disturbance is not recognized, it is quite certain that the thought-cells which have had imparted to them intense emotions at the time of their formation, are going to seek every opportunity to release this desire energy in some kind of action. The existence of the energy under pressure which thus seeks release, and not finding a normal outlet, expresses in some symbolic manner

which may be decidedly disadvantageous to the individual, may be thus unrecognized due to the opposition of other groups of ideas which exercise a censorship over what enters the objective consciousness. Or it may be unrecognized because of the pain which was associated with the experience at the time of its formation.

As I have repeatedly emphasized throughout this course, pleasure is attractive and pain is repulsive in the direction of the activity they prompt. Not only do we avoid and dislike that which causes pain, but the Law of Association is equally applicable to mental processes, and we avoid giving attention to mental factors which cause pain. Just as we seek pleasant physical experiences, we also seek pleasant mental experiences. To avoid unpleasant mental experiences, we forget them. That is why our childhood and past vacations seem to have been such happy periods. We retain a clear memory of all that was pleasant, and have forgotten most of the incidents that at the time were considered almost unendurable hardships.

This tendency of objective consciousness to avoid pain through forgetting disagreeable occurrences is well recognized by psychologists. Yet the energy of the experiences is still present in the thought-cells of the unconscious mind, and when it is stimulated through association, it tends to modify the conduct.

One may have had a disagreeable experience early in life with a person named Brown, and have forgotten all about it. But in later years, although having some pleasant relations with persons thus designated, there may be a singular inability to remember the names of these friends. Somehow, when occasion arises to introduce them, the name is not at hand. While the old painful experience has vanished from objective memory, the name Brown is linked through the Law of Association with painful energy in the thought-cells. And because the memory of this name stimulates painful feelings in the unconscious mind, the objective consciousness avoids it so as not to feel this pain. That is, the name is forgotten.

However, if there is enough painful emotional energy in the thought-cells which are stimulated by this name, it may cause quite an unaccountable aversion to any person named Brown. And even though the experience which built the energy into the thought-cells has vanished from conscious memory, it may be strong enough to cause actions which are beneficial to no one. It may cause an important letter intended for Brown and Company to be accidentally mislaid; or through some other mischance the unconscious mind may find opportunity to express the displeasure of the Brown thought-cells in unfavorable action.

Psychiatrists who specialize in the treatment of neurosis find that this infirmity is frequently the expression of the unconscious mind which has burdened itself with a sense of guilt. It is quite unimportant whether the guilt is real or imaginary. A person who sets himself an absolutely impossible standard of conduct may feel, when he fails to live up to this false standard, that he has indulged in the forbidden, or even committed the unpardonable sin. According to the ideas his unconscious mind has been trained to accept, sin should be punished. Therefore those thought-cells which have been trained to this belief, administer an amount of punishment which, measured by their Conditioning, will satisfy this need.

All neurosis, however, is not due to a sense of guilt. Much of it, however, is due to repressions of energies that should have found some satisfying outlet in action. One of the most eminent psychologists remarked:

“Let no one think of his poor dear friends, A, B and C as paragons of virtue yet afflicted with morbid anxiety, forgetfulness, motor incoordination, bad dreams, or hallucinations, until he has studied Freud’s cases and learned to read the short subconscious wishes that lurk beneath a virtue so extreme and bedridden.”

And it certainly often is observable that those who live in a manner that permits them to avoid repression, expressing their animal impulses and inclinations with an abandon that makes them poor citizens, retain vigorous health. Those who have been brought up in an atmosphere of fear of transgression, who have been nurtured on the merits of duty, and who have been taught that pleasure is a sin, on the other hand, nearly all have repressions that haunt their lives and tend toward a variety of complaints.

Because such observations have been so well substantiated, there has been a tendency in much of the literature on the subject to give the impression that the way to health and normal life is to abandon oneself to the expression of the animal impulses.

Yet the process by which life has advanced from lower to higher levels since it first appeared upon the earth depends, not upon expressing the inclinations in the old, habitual channel, but in expressing the energies of these inclinations in more effective ways. In other words, as explained in lesson No. 60 (*Why Repression is Not Reality*), gross expression is one detrimental extreme and repression is another detrimental extreme; but the process by which life has advanced through the ages, and by which our own energies should be handled, is that of Sublimation.

Cause of Hysteria

—When an individual tends to over-emphasize the importance of everything which relates to himself it is very easy for him to become conditioned in the direction of hysteria. When everything is taken personally, rather than looking upon the experiences of life as part of a broader pattern, there is lack of proper appraisal of values. The numerous incidents which are common to most lives, because of the self-centeredness, each seem to be of tremendous importance. And as important situations give emergency reactions, the emotional release, even for trivial incidents, is of emergency volume. The individual thus conditions himself toward an unstable state of emotions, toward a state in which there is loss of emotional control.

Hysteria takes many forms. In infancy it manifests as tantrum. In childhood it gives rise to sudden and uncontrollable anger. Among adolescent schoolgirls it is exhibited as too ready laughter and tears. At an older age it becomes the yearning for jazz, excitement and exaggerated emotions. In adults it may develop self-pity, or so great sensitiveness to slight that the individual reacts to unintentioned incidents with violent anger, jealousy, revenge, or unrelenting hatred. That is, he is over-conditioned in his emotional reactions.

Because this intensity of emotional reaction has been conditioned through placing undue importance on events relating to himself, the first thing one so afflicted should do is deliberately to cultivate a realization that he is no more important than others, that the events which affect him are for the most part inconsequential, and that normal life embraces a spirit of give-and-take.

Instead of turning his attention in upon himself, and considering events so largely in their relation to himself, he should keep his interest as much as possible on how others are affected. In other words, the over-sensitive person should pay as little attention as possible to the effect of disagreeable incidents upon himself; brushing them aside as of no consequence. He should, instead, keep his attention as much as possible turned to the welfare of others.

But he can not expect to overcome a condition which has been built into his unconscious mind over a long period of time in which energy of tremendous volume and intensity has been added to the thought-cells relating to his own preciousness merely by willing to do so. He must set to work systematically to RECONDITION himself in reference to his sensitiveness. He must learn to take pleasure in overlooking, ignoring, and not even recognizing those incidents and impacts that previously would have raised an emotional storm. He must cultivate a distinct thrill each time he maintains his poise in the face of a difficult situation.

This same process of Reconditioning is also applicable to those who, as mapped by the prominence of the upper-octave planets in their birth charts, have nervous systems that are over sensitive to thought vibrations or other types of psychic influence. And to insure that greater pleasure is developed in being impervious to undesirable impressions, the practice of such resistance should be tied in pleasantly, as explained at the end of lesson No. 60 (*Why Repression is Not Reality*), with the desire of each of the dynamic structures of the astral body, and with the pleasant realization of as many other desires as possible.

Why People Fail to Perceive the Astral World

—The influence of the Conditioning process since birth has had another pronounced effect upon most individuals. The individual has been taught to place dependence upon the reports of his physical senses. In order to escape the impacts of physical existence he has had to keep his attention during the waking hours riveted closely to the affairs of physical life. If he gave attention to what was happening on the inner plane, this took his attention from physical happenings, and prevented him from escaping injury. Let anyone become absorbed in inner plane affairs now, while in downtown city traffic, and he will quickly be brought to the realization that such an attitude invites physical disaster. He will be bumped and jostled by others, and lucky, indeed, if not run over by an auto.

The struggle for physical survival is so intense that a little relaxation from giving concentrated thought to physical affairs brings suffering. The dreamer and visionary, who thus fails to turn most of his energies into channels of practical affairs is traditionally one who is also in financial want. And thus it is, even if in childhood we have been accustomed to view happenings on the four-dimensional plane, the pain of continuing to do so soon causes us to cease giving such things our attention. We are ridiculed by the older people and made to feel inferior because we imagine things. We are taught that the three-dimensional plane and its objects are the only reality. And these constantly repeated suggestions are given emphasis by the impact of physical pain when we neglect physical affairs for long.

From the time they are born, most people are systematically and effectively Conditioned through the pleasure gained when they successfully give attention to physical affairs and the pain endured when they take their attention long from them, to give attention only to the plane of three dimensions. There can be no mystery, therefore, however vivid and real the four-dimensional plane and its happenings may be, why few people are aware of its existence. Most spend their lives training themselves to be unconscious of it.

We do not expect an individual to give much of an account of himself in the performance of any work he is convinced can not be done and in which he has had no previous training. And so long as the individual remains hypnotized by the suggestions received since childhood that the only avenues of information are the five physical senses and reason, he can not be expected to gain much information from the inner realm.

Yet when it is recognized that the unconscious mind has access to information beyond that which can be apprehended by physical means, and it is given instruction to gain that information, this gives an impetus toward thus acquiring it.

If we are to put the unconscious mind to work gaining information that otherwise is inaccessible, and it is to prove efficient in this SUBLIMINAL THINKING, we should start to RECONDITION it. That is, most of our lives we have been Conditioning ourselves to get information exclusively from the three-dimensional plane. Our habit-systems to do so are well formed. And just as if we went to England, where the auto must drive on the left-hand side of the road, we should have to Recondition ourselves by painstaking attention and effort to keep from trying to pass cars by driving to the right, so, if we are to get information from the four-dimensional plane, we need to devote consistent effort to training our attention to apprehend it.

The first step in any form of character building is to have a clear cut idea of just what you want to do. Then, with that definitely decided, the Conditioning process should be intelligently and systematically applied according to the instructions given at the end of lesson No. 60 (*Why Repression is Not Reality*). To cultivate Subliminal Thinking, therefore, the first thing is to have quite definitely in mind the type of four-dimensional activity you wish to encourage. When this has been decided, then start to work to do the necessary Conditioning.

You will need, of course, systematically and intently to direct the attention of the unconscious mind toward acquiring the desired information, or toward developing the proper facility. As this is a new habit, to which as yet it is unaccustomed, do not expect it to do all the work. Some plan of energetically directing it to the performance of the required activity will need be devised. And this plan will have to include a definite system so that the matter will not be neglected.

Gaining Information During Sleep

—One of the best methods is to use the hours of sleep in acquiring some information inaccessible to the physical senses, yet which can be checked as to accuracy without much delay.

It is not in the best of taste to relate personal experiences that are somewhat out of the ordinary; but as in the passing years hundreds of students have followed similar methods with results equally gratifying, I feel that the practical suggestions thus conveyed to those seeking development far outweigh the transgression involved in relating some of my own experiences in cultivating Subliminal Thinking.

In the summer of 1908 I had been trying to see clairvoyantly, and at times did so; but the successes were so sporadic I concluded I needed some more effective method than the one I was using. At the time it so happened there was a rural mail box at some distance from the house where I lived. Each day, if there was mail, it was placed in this box by the Rural Delivery between the hours of 1:30 p.m. and 2:30 p.m. We received several papers, a magazine or two, mail order catalogues, and letters from widely distributed correspondents who were interested in astrology and occult matters. I decided to use this mail delivery to train my unconscious mind in gathering information.

At the time I was engaged in intensive study, and I attributed the lack of clairvoyant success to the high state of activity of the objective mind, which tended to broadcast thought-waves which interfered with bringing up into objective consciousness that which the astral faculty of sight had seen. I noted on the occasions when clairvoyant vision was satisfactory, that for a moment or two preceding, no conscious thoughts chased through my mind. As my difficulty seemed to be properly to cease generating energy in the brain cells, so that energies from the thought-cells could register on them, I decided to employ sleep to attain the desired end.

Lunch was at 12:30. Knowing there would be a mail delivery an hour or two later, I made it a practice to take a brief nap at exactly 12:00 noon. The purpose of this nap was to see exactly what would be in the mail box after the delivery. That is, I simply directed my unconscious mind to inform me of the nature of the mail to be delivered. Usually I would sleep only a few moments, and awaken with a vivid picture of the inside of the mail box in my memory, with such papers, letters or other things which it would contain. I made the effort to slow down the return to full waking consciousness, with its disturbing broadcast of thoughts, holding the consciousness in the border state between sleep and waking while I noted as many impressions as possible about what I had seen. These impressions were mostly pictures of action, such as one commonly sees in dreams.

Then at the 12:30 lunch I would relate in as much detail as possible what I saw and inferred in relation to the mail I had seen as I regained waking consciousness. At first there would be times when no image would be retained on waking. But with practice I could remember every article in the mail box and just how it lay in reference to each other article, as it would appear when shortly delivered. These details I would describe to others; and they would be verified after delivery had been made.

Letters from people with whom there had been no previous correspondence were seen quite readily, and the symbolical dream picture accompanying any important or unusual communication revealed its purport, and from what part of the country it came. To be sure, there were mistakes in these interpretations, but as in any art, practice leads on toward perfection.

Both in these rural mail experiments and in later experiments which started in 1915, after I had accustomed myself to bring the information through from the sleeping period, it had transpired that about half of the time it would come through before sleep had brought loss of consciousness. I would be almost asleep, when I would see that which I sought, and would arouse myself sufficiently to write it down. The unconscious mind merely needed a cessation of brain broadcasting in order to impress objective consciousness with the information it had been directed to acquire.

When I came to Los Angeles in 1915 I resumed a similar training, using the sleeping period at night to acquaint me with what the P. O. Box would contain. A majority of the letters were answers to advertisements, from people with whom there had been no previous contact. Yet in a mail averaging half a dozen letters daily, I could usually tell my friends, who were checking on it, the number of letters, the section of the country from which they came, what orders were contained in each, and the nature of personal remarks, if any.

These experiments interested a number of friends, who formed a small group for the purpose of developing the ability to acquire information during the hours of slumber. At that time I conducted two evening classes a week; and on one or two other evenings each week our group made it a practice to go to lectures such as were being advertised.

Each made the effort on the night before attending the class I conducted to note in sleep a description of any peculiar character that might attend for the first time. And on the night preceding attendance at some other lecture, each would endeavor to see some event, or to describe some chance arrangement of furniture, or remember the exact words of the speaker when he would make some outstanding observation or prediction.

These observations were written down in the morning and were compared among the group members before the meeting took place. And it came to be not unusual for two or more to describe some peculiarly dressed individual who had not attended before, or for two or more to bring back from slumber the remembrance of some chance and unusual arrangement of furniture, or for more than one to have written down the purport of a speech which would be delivered; and on occasions for someone to give an actual quotation of words that would be uttered.

The success of these experiments led members of the group to make the effort to bring back into waking consciousness experiences on the inner plane of life. Some certain destination would be chosen to visit, or information regarding some occult problem would be sought through contacting some definite school of thought. In the sense that the desired region was visited, or even that the information sought was

gained, these efforts were not strikingly successful. But that various members of the group had visited the same spot, and had experiences in common, could not be doubted. The things they saw, and the experiences they had, when written down by each and later compared, were often as similar as would be the descriptions, written by the same person, of a common experience on the physical plane.

The places they attempted to go in the after-life realm more often than not were beyond their power to reach; but each would bring back a similar description of the country through which they had struggled in trying to get there, of the incidents that happened, and of the obstacles that caused them to turn back. Much of what was thus seen was as fantastic as are most dreams, and was presented to the objective consciousness, as was the information gained, in the form of images and experiences that were universal pictographic symbols. A discussion of the import of the symbolism of the experience at times made its significance obvious; at other times the meaning would remain obscure.

At a still later date, the members of this group made it a practice to bring back from slumber information of practical value in regard to events that would have some significance in their lives a day or two hence. Incidents would be remembered from their sleep, yet almost invariably pictured in much the same symbolism as are ordinary dreams. But by the associations of the dream, and what occurred, they would be able to report that a certain individual had decided to accept or to reject a business offer, that within a day or two some money would come into their possession, that some proposition about which they had doubts would turn out advantageously, that some friend would become angry, that an attempt would be made to steal a purse, or other matters that were slightly significant. That is the unconscious mind was expected to apprise the individual of things in the offing, not merely that would take place, but that precaution should be taken to prevent taking place, or what it would be advantageous to make take place.

For many, many years, each morning I wrote down my dreams. Nearly always there were three distinct in memory, each of which had its own significance. And I endeavored a little later in the day to interpret this symbolical pictograph language by which the unconscious mind tried to convey the information I sought to my objective consciousness. Needless to say, what I sought was not confined to the every day matters mentioned. Nor, for that matter, were the methods employed to gain the information through the psychic senses, and through tuning in on higher planes and higher intelligences, confined to the period of slumber.

But essentials of any sane method of developing the ability to acquire information through Subliminal Thinking, are that there shall be frequent opportunity to practice: and that there is at hand a constantly available opportunity to test the accuracy of the information thus derived. One spends half a lifetime in practice to be able to reason accurately; And one should not expect to become proficient in Subliminal Thinking without persistent effort and application. Both past and present mystical folly have jumped to the conclusion that any information from the inner world must be reliable. Yet often it is as warped as are physical observations, and sometimes it is just plain gossip.

In remembering the experiences of the sleeping period, thought of other things is quick to break the line of association. Coleridge went to sleep reading "Purchase's Pilgrimage," in which mention is made of a stately pleasure house. He awakened with the poem, "Kubla Khan," fully composed. There were between two hundred and three hundred lines all fresh and vivid in his memory. He started writing these down as fast as his pen could travel, and had written fifty-four lines when interrupted by someone calling on business. This person stayed about an hour; a disastrous interruption; for when Coleridge went back to his writing, he found, to his chagrin, he could not recall a single line more of the poem. Thus, as wonderful as it is, Kubla Khan is incomplete.

Such methods as I have described may not be elevated in the information sought; but it gives opportunity for practice each night; and whether that which is perceived, or inferred, is true or false can be tested, usually within a few days.

When the information gained has proved to be correct, as many pleasant thoughts and feelings as possible should be associated with this demonstration of accuracy, in order properly to CONDITION similar efforts toward accuracy in the future.

The would-be aviator does not make a solo the first time he climbs into an airplane. To commence, there is a long period of ground training. Then he goes aloft with a pilot and is given opportunity to develop his skill in actual flying. But only after a persistent period of practice in which his performance is checked as to its efficiency, is he given a pilot's license.

Such practice in Subliminal Thinking as here outlined is not the only method, nor should one follow such practices to an extent that they prevent proper rest to result from sleep. But, like the preliminary training given the would-be air pilot, they afford a comparatively safe method of perfecting the required ability. After this ability has been thoroughly demonstrated, early restrictions can be removed, and the accomplished astral pilot can attempt record-breaking flights in Subliminal Thinking.

Chapter 11

Serial No. 66
Original Copyright 1937
Elbert Benjamine

Copyright
Church of Light
August 2002

How to Develop Creative Imagination

Chapter 11

How to Develop Creative Imagination

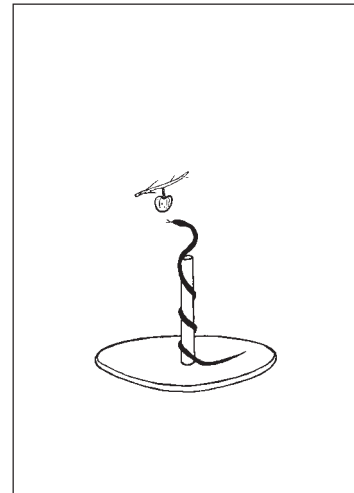

ALL creation is the result of giving something already in existence a new form; for all that is and all that ever will be has ever existed in some condition. Creative imagination, therefore, consists in rearranging the images already present in the unconscious mind, or which may be acquired for the purpose, into new combinations. Its application implies that the unconscious mind shall possess stored experiences in a state suitable for use, and that energy of sufficient intensity be applied to these mental factors to cause them to enter into new and unique arrangements with relation one to the other.

The kaleidoscope well illustrates this process when it is unguided by desire. The instrument contains loose fragments of colored glass and reflecting surfaces so arranged that changing its position presents the contents in an endless variety of symmetrical vari-colored designs. But the unconscious mind and its thought-elements, thought-cells and dynamic thought structures, as I have set forth in detail in lesson No. 65 (How to Cultivate Subliminal Thinking), is never uninfluenced by desires. Each thought-element is associated with the Conditioning energy which accompanied its formation, as is each thought-cell and thought-structure; energy straining for release in a given direction, such as we call desire.

Some of these desires are more powerful than others, and the one largely able to gain the attention of the unconscious mind at the time, exerts an influence upon the kaleidoscope fragments of experience somewhat parallel to that exerted by a magnet on iron filings.

Place iron filings on a plate of glass. They lie, like the mental factors within the unconscious when unaffected by desire, in a listless heap. But put a horseshoe magnet under the glass and all is changed. The filings leap into definite and beautiful designs, and follow all movements of the magnet. Desire energy is the magnet which is responsible for all movement, all change of pattern, and all new combinations of mental factors within the unconscious mind.

Creative Work Depends Upon Reproductive Energies

—The energy released by the Drive for Self Preservation, or by the Drive for Significance, is sufficient to cause trains of thought of intensity to pass through the unconscious mind. And some worthwhile new combinations may result from the thought processes thus set in motion. But the experiences of writers, composers, inventors, artists, and all those to whom we credit creative work, is that creative output of volume and importance, on any plane, is dependent upon the creative energy of the Drive for Race Preservation.

In other words, the procreative instinct has for its object the creation of something outside the self, and through all time since the soul started its journey it has been engaged in acquiring Significance through producing something new. It has thus been specifically conditioned to create, rather than to acquire. Thus is creative expression dependent upon sexual power.

Poorly sexed individuals never become noted for any kind of creative output. Hermaphrodites, and those of little sexual vigor, become the best of all mediums. They are easily dominated and controlled by a more vigorously sexed mind; and as irresponsible mediums sometimes are the instruments through whom a large amount of creative work is accomplished. But it is the controlling intelligence, in such cases, that does the actual creative work.

Back of all important creative activity, back of creative imagination of value, lies reproductive energy as the driving power. And as a corollary, the use of creative imagination, and creative work of all kinds, consumes sexual energy. Modern biologists and physiologists, such as Alexis Carrel, of the Rockefeller Institute, winner of the Nobel Prize in 1912, have commented on the relation between sexual energy and creative mental output; holding that a person engaged in such mental work could not expend his energies too freely through marriage relations without lowering his mental output; where a person doing merely routine work would not be noticeably affected.

Those who would develop creative imagination, therefore, must not dissipate their creative energies wantonly. Instead they should learn, as explained in lesson No. 60 (*Why Repression is Not Morality*), to Condition the reproductive desire to find a higher satisfaction through creating mentally than in flowing through more physical channels of expression. Not that a celibate life is essential for creative work; but that a reserve of reproductive energy should be present which may be diverted, as occasion demands, into mental creation.

While we occupy physical bodies the intensity of both physical and mental activity is largely, as explained in lesson No. 64 (*How to Think Constructively*), determined by the electricity generated in the brain and nervous system. Creative activity, either physical or mental, requires a high electrical potential. Mental creation requires an electrical potential even greater, and radiations of even higher frequency, than mere physical procreation. Yet through Sublimation the electrical energies responsible for procreation are given a higher frequency and higher potential such as enables them to create on the mental plane. In fact, in all important mental and artistic creation and in all exalted emotion and feeling of religious devotion, a portion of the electrical energies responsible for physical procreation is thus Sublimated, or diverted into a higher plane of expression.

For the specific generation of electrical energies, such as have intensity sufficient for use in procreation and other creative activities, by the cells of the brain and nervous system, the organism has developed special endocrine glands. It has developed the secretion of adrenaline and intercortin to meet the emergency of fight or flight, and these secretions generate potentials especially adapted to these emergencies. But it has developed different endocrine secretions, those of the gonads, to meet the emergency of procreation and other creative activities. And these gonad secretions are specially adapted to generating within the brain and nervous system electrical energies of the proper potential and frequency to do creative work.

Creative geniuses of all kinds—famous poets, famous composers, famous writers of fiction, famous actors, famous painters—have, like the moving picture stars of the present time who also are creative artists, the reputation of many irregularities in their lives. Some of the most productive writers of fiction of all time, like George Eliot of England and George Sand of France, for instance, both women of world-wide fame, have been noted also for the unconventionality of their loves.

It would be erroneous, however, to conclude from this that amours and creative genius are necessarily companions. For there have been other geniuses of great productivity whose lives have been quite conventional. But we are quite warranted in concluding that the glandular makeup of those who do much creative work is such as to give unusual sexual power.

Some of these are successful in Sublimating so large a part of this excess of sexual energy that their lives are quite regular. They are able to divert the abundance of electrical high tension into the channels of their work. But others, having the same or even higher electrical tensions, are able to Sublimate only a portion of it into their work, and the remainder drives them into excess, or into affairs that are not sanctioned by society.

Writers now quite generally recognize the relation between sex energy and creative output. Even the most dissolute among the more successful ones, while engaged in writing, live continent lives. Until the piece of work upon which they are engaged is finished they refrain from alcoholic beverage and from too close association with the opposite sex. Then with the literary effort delivered to the editor they go on a

jamboree that justifies their reputation as drunks and profligates. Such a mode of life, which is followed by some also in other lines of creative work, is reprehensible; but it nevertheless points to the working of a law, which these people have discovered through practical experience, that for creative work there must be a sufficient reserve of sex energy.

When such a reserve of sex energy is present, if it is to accomplish worthwhile mental work it must be directed into some specific channel of creation, and subjected to sufficient control that it does not run riot. Monastic life many times in history has been responsible for religious manias and wholesale hallucinations, due to the reproductive energies accumulated in forced celibacy running rampant with the imaginations of whole groups. The electrical energies present in high tension and over abundance created mental images that became so vivid, and charged with force, that they assumed the properties of physical presences.

As indicating the force of mental images, thus highly charged, to produce physical results, the records of stigmatization in the case of numerous individuals, from the thirteenth century down to the present day, are well attested. The votary, dwelling on the thought of the crucifixion, and identifying himself sympathetically with the image of the dying savior, received on his own body similar marks which became permanent. On some, the records show, no doubt because their imaginations were centered chiefly on it, there appeared only the mark of the crucifix. But on the bodies of others appeared wounds that bled, wounds of the nails and thorns and scourging.

Creative imagination, when it has sufficient electrical energy at its command, can produce the phenomena of the spiritistic seance room. That the phenomena are commonly produced through the direction of the creative imagination of a discarnate entity, rather than that of the person chiefly supplying the electrical energy, does not vitiate the principle.

All the evidence, again considering inadequately directed reproductive energy, indicates that an ascetic life, in which the sexual impulse is repressed, is the most highly productive in the development of psychism and a fertile and vivid imagination. Various strong desires of thought-cells and thought structures, finding no external avenue of expression, divert their energies into four-dimensional activities. The electrical tensions of high potential, generated in the brain and nervous system by the action of the gonad endocrine secretions, not finding a physical avenue of expression, exert a powerful pressure toward the creation of mental images. Fancies flow through the brain so highly charged with electrical energy that they seem convincing realities.

Nothing develops the ability to see, feel and hear psychically quicker than a complete suppression of the normal physical functions, especially the suppression of strong reproductive energies. But under such crowding and forcing, that which is seen, felt, and heard, although to the one having the experience it is most convincing, gives little information of value, and a multitude of errors.

I have enjoyed a wide experience checking the accuracy of the clairvoyant, clairaudient and psychometric experiences of those who have forced these faculties through asceticism. And I have found that to the extent there has been such forcing through repression, that the reports given are inaccurate and unreliable. Year after year I have been given predictions, warnings, and messages by those who still believe they are wonderful psychics, and whom no one could convince otherwise, practically none of which has proved reliable or of any value. What they thought was seen or felt or heard was really an image, often a preconception, in their own minds into which had been drained high tension electrical energy.

This, of course, presents no argument against the development of the psychic senses through normal methods of unfoldment; nor against the proper use of creative imagination. It simply indicates that when the energy present is too powerful to be controlled, or no special effort is made to direct powerful electrical energies when these are generated in the brain and nervous system, that these follow their natural creative trend, but their mental creations are inimical rather than beneficial.

Before indicating how the energies of creative imagination should be directed, however, it seems best first to consider the images of the unconscious mind, new combinations of which it is the function of the creative imagination to form.

Source of Images Used in Creative Work

— The experiences, physical and mental, which form the thought-elements, thought-cells, and dynamic stellar structures comprising the unconscious mind have fused according to the Law of Association; and they are recalled into objective consciousness in conformity to this law. Yet the individual has a certain power to create new Associations between the factors within his unconscious mind. If he could not do so there would be no power of discrimination; which requires that important matters, for instance, be selected and held before the attention apart from the unimportant material with which they were originally associated.

The process of separating images and other mental factors from the material with which they originally were linked in Association is called Dissociation. Some persons have great difficulty in Dissociation. And as creative imagination must make use of Dissociated ideas or images, they are unable to perform any work that they have not seen done in detail. They are unable to originate any marked variation in methods of work, unable to form an opinion of worth that they have not already heard expressed. Their mental processes are too tight.

People with small imagination often have a great fund of knowledge which has been integrated as received, but subjected to no process of dissociation in which it has been examined in a large variety of ways, in new combinations. Such an individual in relating an occurrence must tell all the details; if he tries to leave anything out, however unimportant, it breaks the whole train of his thought. Those of this type of

mind often have unusually retentive memories, but cannot pick out a passage from a memorized poem without repeating the poem from the beginning. Thus it is that those of much learning often are so hampered by the fixity of the contents of their minds that they cannot adapt themselves. Such ultra-conservatives travel in a rut; unable to dissociate the ideas they have received from books or from precedent.

Those, however, who have the Individualistic Urges more prominent in their mental makeup, such as are mapped in a birth chart by a prominent planet Uranus, find dissociation easy. The thought energies mapped by Uranus tend to act as alternate currents, attracting strongly for a time, then as strongly repelling. This breaks up the mental fixity, enabling new combinations of ideas to be made. More than any others, the individualistic Urges mapped by a prominent birth chart Uranus, give originality.

Mental fertility depends upon the supply of material at hand and its dissociation. By way of illustration we can think of any number of things that can be made from a large granite boulder. It may be used, finely ground, as sand in mortar; crushed to proper size as cobblestones; in larger blocks as building material, as monuments, or as part of a breakwater protecting a harbor. But so long as the boulder remains intact it cannot be converted into any one of these uses. It must first be broken into pieces of suitable size. And for mental fertility, the mental contents must be broken up, severed from the fixity of their original association. The ability to do this may be cultivated through the habit of viewing experiences from various angles and in diverse combinations.

Yet if there is to be great fertility there must also be plenty of material within the unconscious mind thus to dissociate. Invention is more frequent among civilized peoples, not because they have stronger energies, and not merely because they have the thought-cells mapped by Uranus more powerful in their astral bodies, but because they have a so much wider field of information from which to draw their material. Also, they have devised methods of directing their desires more persistently toward a single end.

Yet the unconscious mind has within it, or easily accessible, a vastly wider field of information than has the objective consciousness. The objective consciousness has at its disposal only those images and ideas which can be brought up, through the process of memory, in a manner that they impart vibratory energy to the physical brain cells. And because the physical brain cells offer so much resistance to the process, making new and complex combinations of mental factors in this way is a laborious process and consumes much electrical force.

When the conscious mind has its attention focused on creating through the use of the imagination, it has three sources from which to draw its materials. Within it, and therefore accessible for use by the imagination, are stored the experiences of the soul, including those it has had in the process of its evolution through innumerable lower forms of life. On the astral plane are an inconceivable variety of conditions which may be examined through the use of the independent psychic faculties, or by the soul during the hours of sleep.

An artisan, desiring to accomplish a certain result, even if the artisan is but a bird striving to build a nest or a bee endeavoring to build honey-comb, searches for suitable material. The energy put into the search depends upon the intensity of the desire. The degree of intelligence displayed in selecting the material depends upon the organization of the unconscious. Thus the unconscious mind of man, urged by intense desire to create mentally, seeks for the proper material to use with such intelligence as it possesses. If the desire is intense enough, it will explore widely in the astral realm.

Furthermore, it possess the ability to tune in on other intelligences, both on the physical and on the inner plane, who possess the kind of information it seeks. It is able not merely to explore the astral plane, but to take advantage of the knowledge and ability of those who are still more competent; of those who are willing to help in the enterprise.

If the desire is intense, with energy at its command to release, and the individual is not hampered by the conviction that all knowledge must come through the five physical senses and reason, the unconscious mind leaves no stone unturned either on the physical or the astral plane to acquire proper material for the creative work attempted.

Directed Thinking in Creative Work

—But For efficiency in using this material there must be the power to discriminate and to do Directed Thinking. Fantasy thinking, because strongly influenced by other desires, is too wasteful. It brings great quantities of material that are unsuitable for use, and arranges them in unsatisfactory patterns. Birds and ants go to a great deal of extra work because they do not discriminate in the selection of material and have not the power of Directed Thought to arrange it. A bird having the power of Directed thinking could build a nest with one-tenth the labor.

To start the unconscious mind on its search for material, there must be an intense desire to obtain a given result. Work on any plane is always at the expense of energy. The work of an organism is directed by desire energy, and, other things being equal, the more desire energy diverted into a given enterprise, the more accomplished. And for creative imagination, or other creative work, there should be, as previously indicated, a powerful supply of creative energy which through Sublimation can be diverted into the enterprise decided upon.

Nearly all important inventions and discoveries and artistic productions project themselves into objective consciousness complete as to general scheme and outline. The unconscious mind, in some manner given the impetus, has assembled material and arranged it suitably.

There remains for the objective consciousness, therefore, the gradual bringing up from the unconscious realm the details of the work. Yet this does not signify that no improvement can be made on the original plan presented. With more material, at least, better details may be afforded. The competent artist or inventor, therefore, will read all that others have written relating to the matter, will talk with those interested in similar endeavors, and in all ways will endeavor to add to the material from which the unconscious mind can make selection. Such procedure also encourages the unconscious to follow a similar method of research on the astral plane.

Truly creative work implies the use of the imagination. The workman who merely builds to the blueprint furnished by an architect does little in the way of creation. The creative work was done by the architect. Yet there are various kinds of Imagination. Imagination is used by science in all discoveries except those purely accidental. It is used in the commercial world for planning. Then there is the utopian type, which envisions conditions as they should be, if? But as we are specially interested in the attitude towards life of these three great classes of individuals, let us examine the kind of imagination used by the Materialist, that used by the Mystic, and that employed by the Occultist.

The aim of the material scientist is, as nearly as possible, to reproduce in his imagination the relations and processes of nature in all exactitude. All too frequently he restricts the material used to the reports of the five senses, and even then discards observations against which schooling has given him prejudice. He uses carefully ascertained facts presented clearly, in the proportion and arrangements found in nature, and with no distortion by the imagination. He is the exact antithesis of the mystic, who pays no attention whatever to the facts of the objective world, but relies entirely on his imagination to create a world such as he desires.

Where the material scientist endeavors to make every image definite, and an exact representation of an external fact, the mystic uses suggestive symbolic images and creates an ideal universe, according to his own conception of how a universe should be which he projects outward. Mystic literature, consequently, so long as it is mystical, is always obscure; ever hinting, suggesting and insinuating, but seldom giving concrete reliable facts. It stimulates the reader to picture things as the reader would have them.

Mystical thought is vague because it is mere fantasy. The imagination, left to itself, exaggerates the significance of the symbols which it uses, and stops at no extravagance. A revengeful and jealous Jehovah, for instance, was created by mystical imagination because a jealous god was desired by a jealous people.

And today, as in the past, fantastic ideas are being created by mystics and taught as truth. They are accepted by other mystics because these find in such notions the things they desire to find in the universe. They say that a notion appeals to them, hence they accept and act upon it. It appeals to them because it taps and releases desire energy. It is wish fulfillment. Yet the world of the mystic, and many of the things of the external world in which he has faith because they appeal so strongly to some desire to have them that way, have no existence except in imagination.

The mystic is accustomed to finding satisfaction for his desires within; he is of the introvertive type. His desires often are unusually strong, especially toward the realization of ideals; and his objective mind is unusually receptive to his unconscious. Due to the intensity of his desires, and the readiness with which material can be brought up from his unconscious, no form of imagination exceeds in fertility that of the mystic. His ingenuity often is amazing. And coupled with this is the general belief that all which is received from within must be true. In his case it is more often merely the wish fulfillment, created by his imagination, of some intense desire.

Yet we should not consider an imagination valueless which does not, like that of the material scientist, reproduce nature exactly and in proper proportion. To give a plain statement of fact may be scientific, but is never literature. Literature, which has an exalted value, appeals to the feelings and common associations, the details being left to the imagination. Each thus is permitted to fill in such particulars as are most attractive to him. It is what is left unsaid, as much as that which is related, that makes literature.

Following the same line of thought, a photograph may accurately represent something, yet be inartistic. To paint accurate to life in color and in detail the picture of a lovely woman is not art. But to give only such lines and colors as will stimulate the imagination of each person viewing it to construct a mental picture such as is most lovely to him, to see what he specifically most ardently desires, is art. And art has an exceptionally high value to human life.

It is not that the mystic creates a world as he would have it that is open to criticism; it is that he believes so thoroughly in the concrete reality of what his imagination creates. Music speaks to man in a language of symbolism. But to believe the voices of the instruments speaking in a symphony are the voices of people, either of this plane or of the inner, and that they are saying definite things, is to permit the mystical imagination to warp the judgment.

The mystical type of imagination, because it surpasses all others in ingenuity and in the diversity of material it can assemble, is most useful. It is only when, as happens in the case of the typical mystic, it departs from concrete images to place confidence in those created by the imagination, that it becomes inimical. Uncritical mysticism has been, and is today, the greatest foe of human progress; for even selfishness gives way before truth; but when fancies are substituted for facts, there can be no adequate adaptation. Yet when the mystical imagination is checked by experimental methods, it becomes one of man's greatest assets.

Unrestrained by critical methods, the mystical imagination leads to a warped conception of the universe; for it permits desires to distort the images of reality. It thus paves the way to fanaticism. Mystics are usually queer and eccentric. Sometimes they are unbalanced and fanatic. Occasionally they are the perverts; because their imaginations suggest plausible but unusual methods of expressing the desires that have found no normal outlet for their expression.

How the Occultist Differs From the Mystic and Materialist

—The Occultist differs from both the material scientist and the mystic. In fact, he may have qualities of both; but this he does, he uses all possible means, internal and external, to check the accuracy of his knowledge. Like the mystic he may imagine something. But before accepting it as a reality he devises ways and means of testing its truth.

The materialist has hypnotized himself into the belief that all phenomena can, and must be, explained by material processes. When phenomena originating on the astral plane are presented to him he concludes they can be explained by some as yet undiscovered law of matter. He believes his eyes and ears and feelings only so long as they present no proof that there is any realm other than the physical.

But the Occultist rejects no facts reported, regardless of the plane of their origin. He does, however, find means by which to test the facts as to their accuracy. His imagination does not accept as facts the things of its own creation, as does that of the mystic. And having a so much wider field from which to draw information, that is, from both the three-dimensional realm and the four-dimensional realm than does the material scientist, he is able to construct a far more perfect conception of the universe.

The field of information of the materialist is too narrow. That of the mystic is broad enough, but in his mental processes there is a tangled mass of fancies interwoven with a few facts gleaned from actual astral experience, and usually warped from all semblance of the truth by some dominant religious emotion. The Occultist, in his research, makes use of such methods as are reliable that are employed by both the material scientist and the mystic.

But whatever type of imagination is used for constructive purposes, the general principles are the same: There must be supplied by the unconscious mind as wide a variety of material relevant to the enterprise as possible. There must be intense desire energy straining for release in the direction of the contemplated mental creation. And finally, there should be some facility for the product created by the unconscious to be recognized in objective consciousness.

Rationalization

—Closely related to the mystic type of imagination is a mental process of which few of us are completely free. It is called Rationalization. This consists of arriving at a conclusion, or doing something, and then finding a plausible reason for it. The individual thus believes he has arrived at the decision through the process of reasoning, or at least that it is something quite reasonable, when in fact it is largely or wholly a matter of wish fulfillment.

A mob, for instance, can always find a good reason for what it does. In fact, mass psychology in general is mostly a response to wish fulfillment which is rationalized. And it is said that love is blind. It is so to the extent that desire for a certain perfection creates that perfection in the imagination and crowds out, for the time being, the image of reality.

We should recognize that the more direct appeals to sensation, because they have had more cultivation in the development of life, commonly afford the strongest stimulation to desire. A shrewd business man, for instance, in selecting a mate, commonly finds physical beauty more attractive than brains. If his reason were dominant it might deem intelligence more attractive. But reason is a late biological acquisition, and physical attractiveness has an age-long appeal.

The release of the desires through the avenue of creative imagination is not always in the direction of beneficial endeavor. As already indicated, negative desires create the image of the condition not beneficial, and because it is held before the attention, action is in the direction of fulfilling this inimical image. Nor is it necessary, for creative imagination to operate in this manner, that we shall be conscious of the importance of what is taking place within.

When some person displeases us and we permit a momentary flash of anger and immediately forget the incident, but an hour later awkwardly cut a finger with a knife, let us not deem this chance. Analysis will bring to light a train of thought within the unconscious in which the anger gave rise to a fantasy, a dream in which imagination, prompted by the animal instincts, actually pictured an assault against this person with a deadly weapon. The unconscious expresses symbolically, and the cut with a knife was really an expression of the suppressed desire to kill our friend.

Children crossed in trifles by playmates or parents commonly indulge in fantasies in which they avenge themselves for the fancied injury by inflicting death. The child would not carry out such an action, but the repressed displeasure, lending energy to the creative imagination, gives rise to a fantasy. And this is the common rule, that any desire which is repressed instead of having its energies diverted into some channel of expression, sets up streams of fantasy thinking within the unconscious of which the objective mind is seldom aware, but which, in some manner tends to find symbolic expression, often in our mistakes and blundering actions.

I have already mentioned the feeling of guilt and how the unconscious often metes out punishment because of it. But also if we feel angry at ourselves, this may lead to some form of accident. The resentment against self sets up a train of fantasy images released by the desire of the anger imparted to the thought-cells. A group of thoughts has been endowed with the feeling that action should be taken against the self. Then, while the mind is busy with something else, a few days hence, the individual falls down stairs, steps in front of a passing automobile, or through some other accident is severely injured.

It is a very frequent thing for a person suffering from a severe disappointment to be accidentally hurt or killed. The disappointment depresses him and he thinks to himself: "This world is a poor place to live. I would be better off dead, as I have such wretched luck." He puts much feeling into this thought, into his brooding, and then turns his mind to necessary tasks. On opening a bureau drawer he finds a pistol that excites his curiosity, or absent-mindedly blows out the gas.

The consciously thought desire for death, even though transitory, acted as a suggestion to the unconscious. It would have never been carried out in action with his conscious sanction. But a train of fantasy thoughts was commenced, charged with the desire energy his brooding imparted to them. When the unconscious accepts a suggestion to do something, creative imagination starts to invent a way for it to be realized in fact. And when conscious attention is off guard, giving the unconscious an opportunity to carry out what creative imagination has devised, such as when preoccupied with something, the unconscious brings the event to pass. It is a dangerous thing to entertain thoughts which we do not mean; for they so easily slip past objective consciousness into action in spite of ordinary vigilance.

But the unconscious, through inventing ways to bring things to pass, is able to exercise a beneficial function. It becomes aware, through the psychic senses, or through talking with others while the objective consciousness is asleep, of many things it is impossible for the objective mind to know without its assistance. Among people not crammed with artificial education there are many little signs of approaching events.

Do not in false superiority laugh at the Roman soldier who starting for the wars stumbled on his threshold and turned back because he took this as a symbol of death. His unconscious mind probably knew much more of what would happen to him if he were on the battle field than the modern professors do who dismiss the affair with the word, Bosh!

A knife dropped at table may really signify the approach of a lady, a fork so dropped a visit from a man; and before denouncing people as superstitious who believe thus it is well to find out in how many such instances the signs are verified by subsequent fact, unknowable to the objective mind beforehand. The unconscious mind, if set to the task, would have no difficulty in discerning who, if anyone, was approaching; nor would it find much difficulty in controlling the unconscious muscular activities sufficiently to cause the dropping of the table-ware which properly symbolized the type of individual who would come.

Even the things we forget that we should remember are symbols, illustrated in the case of forgetting the name Brown as mentioned in lesson No. 65 (*How to Cultivate Subliminal Thinking*), of something going on in the thought processes of the unconscious mind. To misquote a well known poem or saying is not just an accident. Analysis will reveal that the unremembered words are associated with some repression, that is, some painful image or experience, and that the words substituted are symbols of some desire. Pain is repellent, and thus disagreeable things are forgotten, kept from repeating their pain by being recalled into objective consciousness. Yet there are always desires seeking expression, which tend to do so in symbolic form, when opportunity presents.

If I call a person I know well by a wrong name, it is because there is an unconscious train of thoughts passing through the unconscious mind in which the person mentioned, or something with which he is associated, is under consideration. Furthermore, a lie always betrays itself to the keen observer; for volitional effort cannot conceal for long the truth which the little unconscious movements reveal.

To go calling on a person and in a brown study pass his door without turning in, only to be awakened to the fact after having gone by, is to acknowledge that there is something disagreeable to the unconscious about the call. It is probably a duty call, or at least there is a desire of the unconscious to be elsewhere engaged. To forget an appointment is an acknowledgment there is no strong desire to keep it, or that there is some disagreeable element in it. Whoever heard of an impassioned lover forgetting the time or place of an appointment with the idol of his heart!

Why We Forget Resolutions

—We forget resolutions because there is a repressed desire that opposes them. If we desire completely to do a thing, and there is no repressed desire opposing it, we never forget to do it. But when the unconscious is divided into two opposing camps, the more primitive desires, with much energy at their command, are apt to get the better of the situation, and thus the higher but less energetic desires slip from conscious memory.

In reading we often mistake words. Such is not mere chance; for it can be shown by Free Association that either the printed word is associated with some painful mental image, or the substitute word bears some significance as the symbol of a desire with which in some manner it has become associated in writing, also, when we use a wrong word which on reflection we recognize as wrong, it is because the wrong word bears a pleasanter association in the unconscious than the right one. The attention can be volitionally directed to but a few considerations at one time, and the thousand and one actions of life that are more completely directed by the unconscious while the objective mind is attending to other things, accurately portray the inner desires.

The feeling of intense abhorrence for something, of hate, or of disgust, indicates that certain groups of thought-cells, which have a dominant power at the time, are in a state of active conflict and aggressive antagonism against the desires of the thought-cells associated with the condition toward which the Feeling is directed.

Emotions are aroused only when the unconscious mind is given to believe there is an emergency. And such strong emotions indicate that the emergency is acute. It signifies that, within the unconscious, the thought-cells associated with the conditions are strong enough to put up considerable resistance. In other words, the individual who expresses undue repugnance at some act is much nearer that act than is the individual who can view it undisturbed and with a judicial outlook. He must summon all his reserve to escape it.

Those who make crusades against a given vice always have within themselves a strong temptation toward it. It is the violence of the struggle within which they project outward toward conquering the condition in the external world.

Nor is the power of creative imagination, even when its processes are unrecognized, limited to causing undesired actions of the muscular system. It can bring changes quickly in the chemistry and physiology of the human body. An illustration which can find plenty of verification in almost any rural community is the bean cure for warts. College professors may shout, "ridiculous!" but it actually works, as rural people can testify.

A person having a wart is told that if he will take a bean, split it in half and rub the inside of the two halves on the wart, afterward burying them in a crossroads at midnight, that the wart soon will follow the bean and go away.

The individual possessing the wart is given assurance that this works; and various persons who have had warts thus removed may be called upon to testify as to the efficacy of the process. The suggestion still further gains attention through the mystery of the rite performed, rubbing the wart with the bean, and then the unusual act of going to a crossroads at midnight, and the final burying of the two halves of the bean which are reputed to attract the wart. A day or two later, he looks where the wart was, and it has entirely disappeared, often leaving no mark to show where it was.

In many processes by which valuable results are obtained, or those dire, it is difficult to separate creative imagination from suggestion. That is, suggestion plays an important part in directing the activities of the unconscious mind to create something on the inner plane. This something thus mentally given creation then may be brought up into the objective world in some manner. It may be a change in the health, it may be a musical composition, it may be an invention, or it may be an act of the individual, unintended by his objective consciousness, through which the mental image is realized.

But in all cases it is the desire energy released into the process that gives it the power to create or bring about changes. The amount of work thus done is commensurate with the desire energy diverted into the process. And if new combinations are to occur, that is, if there is creative activity, some of the energy supplied the process must be creative in character.

Chapter 12

Serial No. 67
Original Copyright 1937
Elbert Benjamine

Copyright
Church of Light
August 2002

How to Demonstrate Success

Chapter 12

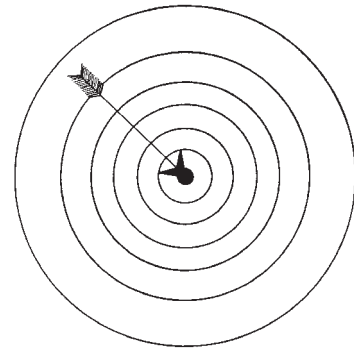

How to Demonstrate Success

NEW THOUGHT, metaphysics and the various schools of mental science have gained so wide a following, and those who have practiced the principles they teach have had so many outstanding favorable results, that few today deny the possibility of demonstrating success, at least in some measure, through the use of mental power. Success, however, implies to various people so widely different things that a discussion of its attainment divides quite naturally into two distinct sections; one devoted to ascertaining what the success is that should be desired, and the other devoted to determining how that success can be attained.

What Is Success?

—In the narrower sense of the word, the realization of any desire may be called a success. Thus a man may be a successful thief, and measure the amount of his success by the value of booty acquired. If he steals only a few hundred dollars he may feel his success has been meager; but if, through organizing a holding company and manipulating its assets, he manages to steal several million dollars, he feels his success has been quite gratifying.

The headhunter who catches a few unwary victims asleep and cuts off their heads, in the more restricted meaning of the word, is successful. In the circle wherein he moves he has a right to feel proud of himself, and very likely will be made chief of his village. And, in whatever measure it is aware of realized desires, a fly, when it finds the opening into a screen fly-trap and thus feeds on the syrup within, must feel successful; for its knowledge, like that of many people, is not inclusive enough for it to realize that the gratification of the immediate desire is at the expense of future welfare.

In the narrow sense, therefore, the person who sets out to rent a house and gets a satisfactory tenant has demonstrated success. One who determines to demonstrate money through mental power, and observes his bank account steadily increasing, has succeeded. Many people thus have demonstrated money, have demonstrated a home, have demonstrated marriage, have demonstrated social position, and have demonstrated health through mental means. Concrete results prove the efficiency of the methods they have used. The question here is not whether through mental power they have obtained their desires, but whether these realizations, in the broader meaning of the word, have led even in the directions of true success.

In this wider significance, success is the continuous and perfect adaptation of the individual to his environment. That is, it is not a temporary benefit, like the attainment of the syrup in the trap by the fly, which in the long run is paid for at enormous cost. It is the acquirement of something which benefits the individual in one section of his three-fold nature without robbing him of that which is even more valuable in another section. For man is not merely physical, he is also mental and spiritual.

To indicate what I mean by success in the broader sense, let me illustrate by an observation I once made on a band of wild horses. These horses lived in the desert region of Nevada, where similar wild horses still may be found today. For success, that is, for continued existence in the wild state, three things were absolutely essential to them: They had to have feed, they had to have water, and they had to have safety from the hunters, both Whites and Indians, that so frequently watched the water holes and attempted their capture.

To this band of wild horses, led by a big palomino stallion, cream colored with black mane and tail, the acquisition of any two of these essentials to their success offered slight difficulty. Plenty of feed grew near their water hole, so that food and water could be had with little trouble. Off across the desert at widely spaced intervals there were also other little water holes where they could drink in safety, but near which the small amount of bunch grass that had there grown had all been consumed. That is, they could easily enough have water and safety, food and water, or food and safety but on this occasion, and no doubt on many another, hunters lay in wait for them close to the water hole where there was still sufficient grass.

But the wise old palomino was too sagacious to permit any of his band to avail themselves of the opportunity to realize the immediate desire at the expense of future slavery. They went without water as long a time as they could, and then when it became absolutely essential, they traveled forty miles from their feeding ground to get it, returning again for further feed. This required a tremendous expenditure of energy, but it solved the problem of procuring all three requisites, for after weeks of vain waiting the hunters grew discouraged and departed.

The Three Essentials of Man's Success

—If a man is to accomplish much, either for himself or for others, his body must not be too badly diseased, and he must have food, clothing, shelter, and it is better to have the comforts of life. Many people, it is true, have not had good health nor the comforts and yet have made marked contributions to social welfare; but commonly a person can do better work and more of it, with a healthy body which does not have to combat distress in the environment. To put it another way, to get the best performance out of either an automobile or a man it should be given the physical things that are helpful to it. Society needs the whole man, not just a part of him, and it needs him at his maximum efficiency; which can be developed only under favorable environmental conditions.

There have been people in the world, many of them, and there are some today, who believe that spiritual success can only be obtained through torturing, or ignoring the needs of, the physical body. Monastic life largely was based upon this assumption. The early Puritans frowned on all that gave bodily sense of pleasure; not recognizing that a harmonious body can do more than one under the pressure of severity. And in India, where extremes of mystical folly have always gone further than anywhere else, even today there are those who deem themselves exceptionally holy merely because they do no ill to others, not even to the extent of defending themselves from invasion by lower forms.

To Western occultists, but not to many of mystical turn, it would seem that where a conflict of interests arose, it were better for those higher in the scale of evolution, because they can contribute more toward universal welfare, to survive than for those lower. That is, if they were set upon by savages, it were better to fight than merely to turn the other cheek and perish without resistance. Early Christians, however, thought differently, and permitted themselves to be fed to lions and otherwise slain in great number, without a struggle other than to pray for their persecutors. And certain sects of Hindu holy men at the present time permit body lice and other vermin to live upon them without remonstrance, getting sustenance from human blood, in the belief that even to brush them off would be moral transgression.

Or to carry the thought into present day controversy, and setting aside the facts as to the physical benefit to be derived from the different types of diet: there are those, many of them, who contend that when they live on a strictly vegetarian diet, with no fish or flesh, they find themselves negative and unable to do more than about half as much work as when their diet contains some animal food. Herbert Spencer, for instance, experimented upon himself, to determine how such a diet would influence the vigor of his writings.

Human bodily chemistry is so varied that there are certainly those who do better work without animal food. George Bernard Shaw seems to be an example of this. But there is a wide school of mysticism which contends, that regardless of its weakening effect upon some individuals, and its tendency to make these individuals mediumistic and easily dominated by more vigorous minds, it is better to live on a strictly vegetarian diet than to partake of any meat. But Western Occultists hold that, regardless of what that diet consists, it is better for the person to eat that which experiment proves in his individual case enables him to live harmoniously with his fellowman and turn out a maximum of work which is socially constructive. That is, they believe what a man accomplishes is vastly more important than what he puts into his stomach.

Yet probably the majority of people pay so much attention to their physical welfare that they ignore the other two elements making for real success in life. Those who devote themselves exclusively to making money, with which to buy physical things, miss the best of living. They exist almost exclusively on the animal plane; for all creatures so long as they persist make a living and provide for their offspring. The man who does nothing to benefit others outside his family is spiritually still on the level with the brutes.

Then there are others who make a decidedly mental success, who are physical failures, and perhaps even spiritual failures. Francis Bacon, for instance, was always in debt and often in serious trouble over financial matters; yet he was intellectually and spiritually a success. He gave the world the product of his mighty intellect, and because he did thus in a measure assist in human progress, in that measure was he also spiritually successful. Henry David Thoreau, American author and philosopher, also was able to solve two of man's essentials to complete success; but unable to solve the third, which in turn detracted from the possible value of the other two. He was a great man spiritually, and his writing proclaimed him a great intellect; but his abject poverty led to hardships of which he prematurely died; leaving the world vastly poorer than otherwise it would have been.

Yet to a degree, most of us succeed in being physically a success. We live the allotted span of years without too great ill health to prevent some accomplishment. But during these years few of us make the gains either in mental attainment or in spirituality that lies within the compass of our inherent energies. We are unlike the horses which traveled forty miles to secure the third requisite. We are content to drink at the waterholes where lurks everyman's danger of inertia.

If we neglect spirituality, and goad ourselves to it, we can without such tremendous effort adjust ourselves so as to gain both intellectual and physical success. Study and thought sharpen the intellectual powers, and there are always loopholes in the laws of the land that a clever man can crawl through to get the best of his fellows. One method, becoming increasingly prevalent with the broadening knowledge of psychology, is to use mental force to take from others what is desired.

The principle of the thing is as old as man, it is only that the method has now become more refined. Jacob procured the birthright of Esau for a mess of pottage through intellectual cleverness; and worthless mining stocks and oil stocks have been sold to widows and orphans. The Island of Manhattan was secured from Indians for a few trinkets, and later it was the custom to trade an Indian a bottle of whiskey, with which to demoralize himself, for a whole band of horses. In these instances physical compulsion was not used. Instead there was a clever appeal to desires.

Nor in high pressure salesmanship, by which a merchant is sold a supply of something so great that he can never dispose of it, or someone is sold something for which he has no possible use, is physical force used. Instead, suggestion is applied through carefully thought out methods in such a manner that the critical faculties of the purchaser are bludgeoned into temporary insensibility. Yet from the standpoint of spiritual success, although not so considered in civil law, it is as much a crime thus unfairly to take from another through mental processes as it is to take the same from him at the point of a gun.

Wealth, except in the form of natural resources, which as they exist in nature belong to society, comes from industry and the hard experience of human toil, as the late President Calvin Coolidge expressed it. When, therefore, an individual takes wealth from society, that is, acquires it in any form from another, he should be prepared to recompense society by returning wealth to it in some other form. However we camouflage it, we cannot escape the truth that when we take from society that which represents the efforts of others, and use it for our personal adaptation, and do not render an equivalent service to society by adding to its adaptability, that is, giving it equivalent value in return, we have become indigent.

Those individuals, therefore, who acquire mental power and cleverness, yet use these, not to discover some superior method of living, or of production and distribution; not in invention, not in better organization, and not in anything else through which society is benefited; but use their abilities to take from society what members of society have produced; or hoard and maintain wealth inherited from ancestors, without themselves making some adequate contribution to the welfare of the whole, are successful in only two essentials. They have acquired mental and physical success, but are living in abject spiritual poverty.

In the larger sense, in which success implies a perfect and continuous adaptation to the whole universe, those mental and spiritual factors that provide for progressive after-death conditions must be included. This means that for such complete success, in which all three essentials are met, discrimination must be exercised not to give undue weight to one factor at the expense of the others. And that the discrimination may have the materials with which to work, it must be provided with the most inclusive knowledge. It is this inclusive knowledge that the B. of L. lessons have been written to supply.

Success in Attaining Any Single Objective.

—When, through a careful analysis of its possible effect upon others, it is decided that a particular condition is beneficial to universal welfare; and is something to be desired and striven for, the first step in demonstrating it is to have a definite and clear conception of just what it is that is thus wanted. The clear visualizing of it, or holding it clearly in thought, is called its formulation. If formulation is not definite and clear, the results are likely to be indefinite and indecisive also; for the energies tend to fill in whatever is held thus before the attention.

It should be realized that on the four-dimensional plane work is accomplished, not through physical or chemical processes, but through the power of thought. When an image, therefore, is held before the attention, and desire energy diverted into it, that condition is actually constructed upon the astral plane, and has a real existence there. But just because a thing has an existence on the astral plane does not signify that it will become also a physical reality. Such an image is a pattern, which may, or may not, be filled in by three-dimensional conditions.

Whether, once formulated, it does become reality depends upon two things: the amount of energy that is diverted into the astral pattern, and the resistance offered by physical environment to being manipulated to fit this particular pattern. Certain thought-cells of the astral body, by their previous conditioning, readily respond to the urge to work to bring about the thing which is being demonstrated. Other groups of thought-cells may have so been conditioned that by natural inclination, as indicated by birth chart and progressed positions of the planets, they offer resistance to bringing about the condition; or certain of them may acquire an autosuggestion which makes them work energetically to oppose the realization desired.

The object, therefore, is to present the image in such a way, and to use suggestion efficiently, and otherwise to divert as much of the desire energy of the structures within the unconscious, that they will furnish their energy to the thought-cells which have set about bringing to pass that which is to be demonstrated through mental power. The amount of energy thus diverted into the image, after overcoming opposition from other thought-cells, is the effective energy released into the performance of this special work.

The work, of course, while performed from the four-dimensional plane, consists of manipulating the environment. To bring a given thing to pass, certain changes in the attitude of individuals, certain changes in the abilities of the one demonstrating, or certain changes where physical conditions are concerned, must first take place. That is, alterations must be made, if the thing desired is to be demonstrated.

Yet, whether the changes are in oneself, such as developing specific abilities, are in the desires or opinions of others on whom the venture depends, or are adjustments of the physical environment; to accomplish these alterations requires the expenditure of energy. Work is never accomplished apart from energy consumption. And the amount of energy it is necessary to expend to bring the various changes to pass constitutes the resistance of the environment.

One might try to demonstrate a condition, and have a tremendous supply of desire energy within the unconscious mind to release into it, and yet fail because the resistance of environment was too great. If one should endeavor to demonstrate himself Emperor of the whole world, the resistance of environment would be so great that, unless he were more energetic than anyone so far ever has been, he could not succeed. I point this out merely to indicate that the amount of energy that the thought-cells of the unconscious mind must possess to demonstrate some things is within the reach of almost anyone; yet the amount required to demonstrate other things is beyond the energy production of any living being. There is a direct relation between the amount of energy which the individual can divert into the mental image of that which he is demonstrating, and what he can accomplish with such energy. And the greater the resistance of environment, the more mental force is required to change it as desired.

Developing the Effective Mental Energy

—At first thought it might seem that the best manner to vitalize a mental image is to concentrate the thoughts of the objective consciousness upon it, and keep thinking about it as powerfully as possible. Objective thinking alone, however, may have very little power to divert the desire energies of the thought-organizations within the unconscious mind into such an image. For success, the image must gain as completely as possible the full attention of the unconscious mind. And if in addition it can be linked up with energy of the Drive for Significance, the drive for Self Preservation, or the Drive for Race Preservation, so that the desire energy of one or more of these powerful drives is directed into the image, the thought-cells they energize will work with great force to bring the thing to pass.

To thus bring the image to the attention of the unconscious mind, suggestion and affirmation are suitable agents. Yet needless to say, they must be applied in a manner, as explained in lesson No. 62 (*How to Apply Suggestion*) and No. 63 (*The Correct Use of Affirmations*), which will prevent the development of negative desires, and preclude contrary auto suggestions. The last part of lesson No. 63, in particular, gives much detail on how to keep the selected image before the attention of the unconscious mind and how energy may be diverted into it. It remains here, therefore, merely to add, that whatever method the individual finds most effective in this respect is the one to use.

If there is a feeling of doubt, or of resistance to the thought that the matter will be demonstrated, this is an indication that the thought-cells are not wholeheartedly working from the four-dimensional plane to bring the thing to pass. That is, they have not completely accepted the work allotted them. When they do properly take hold of the job, there is felt an inner conviction, or complete faith, that the thing will be brought about.

Mere wishing the thing will come to pass, and thinking about it in a listless manner, is very apt to give the thought-cells responsible for the work confused orders, or a feeling of hesitancy and doubt. That is, fantasy thinking is very likely to undo what may have been given a very good start. And for the same reason, after the matter once has been set in motion, it is better not to think about it at all except as such times as there is abundant positive mental energy to direct into the formulated image. Every weak and uncertain thought associated with the matter detracts from the vigor of the thought-cells doing the work.

Thus it is better to have some one period of the day set aside to use in the demonstration, during which the mind is positively and completely absorbed in the undertaking, than to use catch-as-catch-can intervals during which the mind may be partly occupied with other things. And if one finds oneself depleted, or too tired, it is better to skip the regular period set aside for this work; as when one's forces are thus at low ebb one easily may become negative, and permit contrary images to force themselves before the attention.

Do Not Instruct the Thought-Cells

How to Do Their Work

—When you call in a healer, you do so presumably because he is a specialist in his line and knows more about it than you do. Likewise, when you employ a lawyer, you do so because he is supposed to know how to get the results you want better than you do. And the unconscious mind, having so wide a field of information at its command, and its thought-cells being accustomed to get results by working from the four-dimensional plane, knows far better what steps to take, and how to take them, than does your objective mind. Therefore, do not attempt to visualize the steps it must take, or give it orders as to how it must proceed. The final result to be demonstrated when clearly held before attention constitutes sufficient orders. Let it, as an expert in a field your objective mind knows very little about, perform the work in its own way.

To put the matter into other words, to think of intermediate steps is to place limitations, or modifying clauses, which make the work more difficult. These limitations act as suggestions to the unconscious to curtail the scope of its activity. They are like sending an ambassador to a foreign country with orders to secure certain concessions, and then telling him just what he must do in each detail after he gets there. If he is a real diplomat, and worthy of the mission, he has the ability to meet each contingency as it arises. Yet every limitation set as to what he must, or must not do, by that much hampers his work and makes success less likely.

Give the Thought-Cells as Much Aid as Possible in Their Work

—The more information relative to the matter to be demonstrated the unconscious mind has at its disposal, the more readily it can discern the means by which to bring the condition to pass. Give it as wide a field of reliable information as possible regarding the matter, from which thus to select its methods. If it is health that is to be demonstrated, through reading and study learn as much as possible about hygiene, diet, and the principles upon which a sound constitution must rest. Thus concentrating the objective consciousness on gaining health information, also gives the unconscious the impetus during sleep, or even at other times, to seek still further information on the astral plane, or to tune in on the minds of those who possess such knowledge.

Or if it is some invention that is to be demonstrated, reading and studying everything accessible that has a bearing upon the problem will enable the unconscious to acquire a field of information from which more readily to select the necessary processes. With so vast a field of knowledge relative to the matter to be demonstrated, it will find much less difficulty in selecting the particular method which will enable it to do the job assigned to it, whatever that may be.

Do Not Require the Unconscious to Make Bricks Without Straw

—Here in California the little red Argentine ants are a pest to the household. Housewives frequently attempt to demonstrate the absence of these nuisances. And reports have been received from those who by direct mental power alone, and without the employment of any physical agent, have been able to drive these creatures from their premises.

On the market there are one or two preparations which placed in line of march quickly discourage them, and cause them to leave. And the point I here wish to make is that, for most persons, it is quicker, and a far easier process, to drive the ants out with one of these preparations than by merely concentrating mentally on their removal. One who attempts to demonstrate the absence of ants, therefore, and places a restriction upon the method his unconscious mind is to use, saying that nothing physical shall be employed, is at a decided disadvantage. It is likely that if he set out to demonstrate ant removal without such restrictions, that his unconscious would find it far easier to direct him to any corner drug store and to the proper preparation for their removal, than to exert a pressure upon a thousand ant minds sufficient to cause them to leave.

Every law of nature has well defined conditions which limit its operation; otherwise it would not be a law. This is as true of mental and spiritual laws as of those physical. When people in their enthusiasm overlook these limitations imposed by nature to the operation of some law, fanaticism is the result. All have witnessed cases of political fanaticism, in which the natural hindrances to the perfect working of some sociological principle was entirely ignored. All have known instances of religious fanaticism, in which the evidence of human experience was completely lost to sight in the interest of some blind and irrational belief. And most of us likewise have witnessed fanaticism in what was expected of the mind. We have seen those who demanded it without physical agents to restore a rotted and broken appendix, that it set a broken bone, or that it materialize money out of thin air.

The individual who undertakes to demonstrate some condition should not set some impossible limitations as to what agents should bring the desired end about. For instance, some years ago, two of the great industries of France were being ruined. The vineyards were dying of Phylloxera, and another disease was attacking the silkworms. It might have been possible to exterminate these diseases that were impoverishing the country by giving them absent treatments. Such would have been the direct mental method. But they were not eradicated in this manner; and had such direct methods been imposed as a condition of their removal, in all probability these industries would have vanished.

Instead, a man since famous, Louis Pasteur, (birth-chart in lesson No. 5, *CS 2*, *Astrological Signatures*) studied the diseases until he knew the nature and the habits of the bacteria causing them. With this information at his command, it was easy to stamp the diseases out. He applied the indirect mental method. He set his mind to work to demonstrating superiority over these diseases, and placed no fanatical limitations on how the result must be obtained. Thus was he able to demonstrate a great success.

For that matter, the use of physical agents is an absolute essential to obtaining many desirable conditions. The air we breathe, the water we drink, and the food we eat, are all physical remedies by which depleted humors and tissues are replenished and weakness healed. Yet even the most fanatical follower of the divine power of mind to perform wonders does not abstain from using these purely physical remedies. Nor

should one who expects to demonstrate money refrain from entering the fields, such as the professions and business, through which money more commonly comes. Even should he succeed in sitting at a desk and visualizing people coming in and placing money before him so successfully that they did so, unless he gave some value in return, he would be dishonest, and also quite likely to end his career by being hauled into a court of law.

The Bible relates that Pharaoh commanded the Israelites to make bricks without straw; but the result was not in his favor. Instead of such an attitude, when demonstrating a condition, give the thought-cells working from the four-dimensional plane every reasonable condition that may be expected to make it easier for them to bring the desired result about.

Fanaticism In Demonstrating

—I have just spoken of the folly of placing undue restrictions upon the manner in which the thought-cells are to perform their work. And right here I should not neglect also to point out that when the impossible is expected of the unconscious mind, and it is crowded forcefully into the effort through receiving vigorous and insistent suggestions and affirmations, that, in the effort to satisfy the demand, it frequently offers a substitute. That is, just as when the impossible feat of repressing the Drive for Race Preservation is attempted, the objective mind usually is given the belief that these desires are not present, yet their energy nevertheless escapes through some subversive channel; so delusional substitutes are offered when the demand is too insistent that an impossibility be performed.

A real estate man of my acquaintance, a year or two ago, started using the Affirmations sent out by a certain school which has a wide following, to sell properties given into his custody. This school taught that the proper method was to affirm, over and over, that the desired transaction had been completed.

Now if you hammer into the unconscious mind any suggestion often enough and with sufficient force, it comes to believe that suggestion. In this case, therefore, when the thought-cells failed to cause the sale of a given piece of property—or perhaps they never even tried to make it—they nevertheless accepted the suggestion as true. The man believed he had sold the property, told his friends he had sold it, and drew a check on the bank for the money he had obtained from the sale. But as he had no money in the bank, and had not made the sale, this led to confinement in the psychopathic ward of the county hospital.

In the same neighboring small town, in which the teachings of this school had, and still have, a strong foothold, a woman, about the same time, was demonstrating, through the use of affirmations, that her house had been rented. She had reached the point where she was telling her friends she had demonstrated renting her house through the use of affirmations, when the real estate man was arrested. Her relatives perceived that she was close to the same psychopathic condition, took her in hand, and brought her back into touch with reality before it was necessary to have her confined.

Paranoia, one of the three prevalent forms of insanity—dementia praecox and manic-depressive insanity being the other two—is not due to brain injury, but to building into the unconscious some idea which has sufficient desire-energy that it dominates the whole mentality. A hypnotized person, given some belief through suggestion, can be converted temporarily into a paranoiac. He can be given the conviction he has sold his real estate and deposited the money in the bank, or that he has rented his house, even though in reality he has not done so.

There is a certain percentage of those who believe themselves to be completely healed of some malady through absent treatment or some mental method, also, who are merely hypnotized into the belief they no longer have the complaint. It is true, they no longer feel pain. Yet later, as the disease still makes inroads in spite of their belief that it has vanished, they all at once completely collapse.

These instances in which the unconscious mind acquires a conviction that something has been demonstrated when it has not, are no legitimate detractor from the value of suggestion, affirmation, or other mental methods to demonstrate health, or to demonstrate anything else which is advantageous to universal welfare. It merely again emphasizes the danger of a prevalent type of fanaticism which, where religion, psychic matters, or mental power is concerned, refuses to keep in close touch with reality by carefully checking actual results against theoretical considerations. A thing should not be accepted as true merely because it professes to be a Divine Revelation; nor should health or anything else be considered demonstrated until ample proof has been acquired from the three-dimensional realm.

Demonstrating

—To visualize health, hold in the mind as clear a picture as possible of the body in a state of health. To demonstrate a bank account, visualize yourself making repeated deposits in the bank. To demonstrate success as a musician, hold the image of yourself playing the instrument of your choice before a vast and applauding audience. That is, hold before the mind, and then energize, the end desired.

In principle, such demonstrating has been constantly applied since life appeared upon the earth. Creatures have desired safety, have desired to procure food, have desired to reproduce, and to do various other things. When environmental conditions changed they did not know how to meet these new situations, but their intense desire to adjust successfully to them kept the image of the end sought before their unconscious minds. The thought-cells within their astral forms then set about devising means to secure these ends.

We can not say, with forms of life lower than man, just how much success was obtained in this demonstrating by the adults who first felt the need of something better. Probably the impress of the desire for a given end was more pronounced upon the genes of the reproductive cells, so that succeeding generations feeling the same urge were able to bring it to pass in a manner more marked. But we do know that this process has been at work among all life-forms, and is at work today.

Game in a country where it has never been hunted by man, for instance, is usually tame at start. But no matter how tame at first, let hunting commence, and usually by the next generation or two—in answer to the desire for safety—the game will have become exceedingly wild and cunning. Even individuals that have never before seen man will exhibit fear and cleverness. No better example of this can be cited than the coyote of Western America. A few years ago it was easily captured or killed. But now it has developed such craft that in spite of bounties on its scalp and a good price for its pelt, and the fact that every man's hand is raised against it, in the face of ruthless persecution, it has increased in number and widened its range.

A slightly more complex illustration of the force of desire for a given end to demonstrate its realization, which is in reality the chief factor in the origin of species, may be obtained from a study of either protective or of revealing coloration. Protective coloration—as space does not permit a discussion of revealing coloration—has been acquired by the desire to be concealed from natural foes or from intended victims. The image of the desired end in the unconscious mind has impelled the thought-cells to change the color pattern so that it blends with the habitual environment.

As a single example, taken from birds in the U.S., let us examine the Jays:

These jays no doubt, all had a common ancestor. They are perching birds, and the one in the eastern states, the blue jay, lives largely in trees of moderate foliage, or at certain seasons, of no foliage at all. Hence, to match the sky, we find the upper parts light purplish blue; the wings and tail barred with black to resemble tree-twigs; and the breast grayish or brownish, shading to white on the belly, much as the under side of the tree leaves are lighter than their uppers.

Now in the Rocky Mountain region, where snow covers the higher mountains a large part of the year, we find a jay of an entirely different genus; the Rocky Mountain Jay. To correspond with his environment, his upper parts are light slate gray and his under parts brownish gray.

Moving on still westward to the Pacific Coast region, we find throughout the chaparral belt, a jay of still another genus; the California jay. He lives largely in the brush and is blue and brown above and white below, except for bluish streaking on the throat. When motionless he blends nicely with the vari-colored foliage and dead sticks of his environment.

But if we ascend the mountains of the Pacific Coast into the gloomy firs, with their dense dark foliage, we will again find the same genus as the blue Jay of the East, but represented by an entirely different sub-species; the stellar jay. Living in the dark forests, the fore parts of his body are dull blackish changing to pale blue on the lower back and belly. And as he is a bird of the trees, like his eastern brother, his wings and tail of purplish blue are likewise barred with black.

Before leaving this subject of the power of desire to attain a specific end, such as safety or food or protection of offspring, through the action of the thought-cells from the four-dimensional plane, rather than through the chance survival of individuals which varied slightly from their fellows, I should give at least one example from the vegetable kingdom. For this purpose I shall mention the knob cone pine, a tree with which I am personally familiar, as it is common to the Pacific Slope.

It is called a fire type pine, because it has learned (demonstrated) the ability to take advantage of the fires that so frequently sweep the region where it grows. Instead of depositing its seed every year or two only to have the young seedlings killed by the shade of surrounding trees, it retains its cones with the scales tightly closed about the seeds for a period of from 15 to 25 years. If, however, a fire runs through the forest, charring the tree and perhaps burning its leaves, the cones still clinging to the unburned branches slowly begin to open, and a few days or a week after the fire has passed seeds begin to drop into the ashes or upon the soil. Under these conditions they sprout and grow, unhampered by the crowding of other trees. These knob cone pines have demonstrated perpetuating themselves in a region where other types of trees often are permanently eradicated.

When man, therefore, sets out to demonstrate success through the use of mental power, he is not employing some new principle. He is employing the same process which mostly has been responsible for the evolutionary advancement of physical life upon the earth. Every step taken by physical life-forms has been in response to the impulse to demonstrate some condition urgently needed. And man, through understanding how this principle operates, can vastly hasten a progress that left to the undirected working of nature is relatively slow.

He must, of course, first determine what it is that he wants. And to apply the principle, he must cultivate DIRECTED THINKING, so that he can hold his mind to the images he desires to realize, without permitting fantasy creations to intrude. And through DIRECTED THINKING he also must learn how to Direct his Desires, and to Condition more primitive desires so that their energies shall be diverted into the special channels of his choosing. As explained in lesson No. 59 (*Desire and How to Use It*), such persistently directed desire is commonly called Power of Will.

There is all the difference of night and day between wishing a thing and willing it. In wishing it, the Image of the thing desired is present in the mind, but it is a fantasy creation which does not receive positive energy. Instead, the person is negative to the wished for thing, and this frustrates its realization.

Young birds do not learn to fly by sitting on a limb and dreaming about it. They learn to fly by actual effort spent in the act of trying to fly. And psychologists estimate, from experimental work with what people commonly do, and what they are trained to do, that most of us live at about 50% of our possible achievements in the various things we attempt to do.

We arrive at a certain level, in physical performance or in mental output, and stick there. Instead of making perfect, practice, unless accompanied by intelligently applied effort to improve, merely links habitual errors more deeply into the unconscious. No matter how much you play golf or bridge or tennis, or how much you walk, you may not improve your technique. Instead, most of us go through life walking, talking, and thinking about the same as we did when we left school or college. There has not been sufficient Directed Desire and Directed Thinking applied to learning how to do these things, or to doing more important things, better.

The laboratory psychologists find that, merely through striving to do so, accompanied by effort in the practice, the ordinary person can double the speed with which he reads in about six weeks. This is not so important, except that it indicates what people can do toward developing talents they did not suspect they possessed, and toward demonstrating traits of character and abilities that will enable them to contribute vastly more to universal welfare, and thus make for real success.

To learn to do something better you must think about it. When you have done poorly, try to discern just what led to poor performance. When you have done better than your average, recall just how you felt, and just what you did that was different. Then strive hard to reproduce that which led to better work. Thinking about it between performances, if the thought is Directed to acquiring a better technique, is a great help. The unconscious mind learns to do the thing properly through seeing the correct procedure in imagination.

To Demonstrate Success, first have a clear-cut image of just what it is that you wish to accomplish. Furnish the unconscious mind with as much information as possible about the thing. Permit it to use whatever physical channels are available to bring its realization. Other than to prohibit any transgression of morality, give it no instructions as to the details by which the end sought shall be brought to pass. Then, positively and confidently, direct as much desire energy into this image as can be made available. And finally, be willing to work, for the get-something-for-nothing motive sooner or later is sure to backfire; and always be willing to render society adequate recompense for what is received from it.

Book 6

Copyright
Church of Light
August 2002

The Sacred Tarot

Chapter 1

Serial No. 48
Original Copyright 1936
Elbert Benjamine

Copyright
Church of Light
August 2002

Doctrine of Kabalism

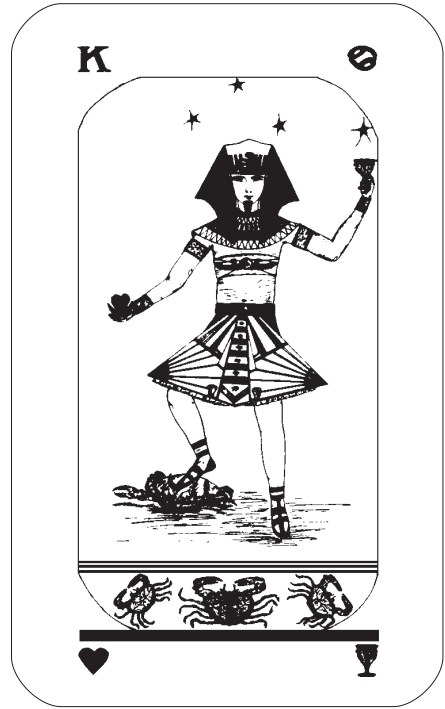
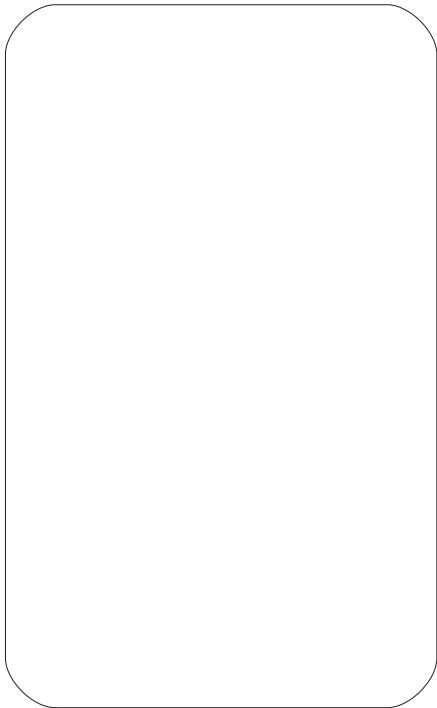
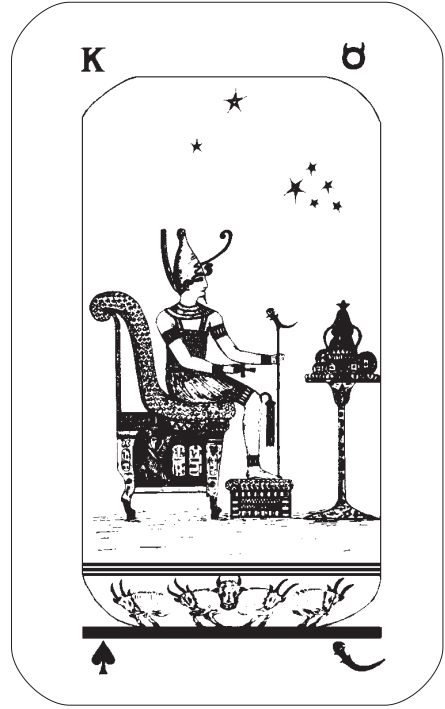

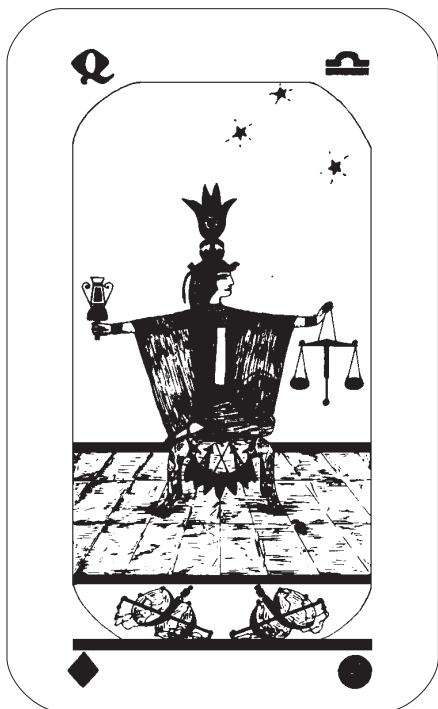

Chapter 1

Doctrine of Kabalism



THE WORD Kabala signifies traditional knowledge. It thus refers to the Oral Law, as handed down from antiquity; and embraces the occult traditions of all lands and all peoples.

Often it is used merely as referring to the esoteric doctrines of the Jews; but in its broader sense it includes also the secret doctrine of other races. This secret doctrine, common to many lands, was jealously guarded from the profane, and was never permitted to pass into writing except in such ambiguous terms as to baffle the uninitiated as to its true purport.

In this sense the sacred books of the world, including the Avesta, the Vedas and the Bible are largely kabalistical; for they set forth traditions that are capable of an inner, or esoteric, interpretation. In fact, there are usually several interpretations possible, each more inner version revealing a deeper truth to those who have advanced along the path far enough to comprehend it.

The Kabala has two divisions; the Written Kabala and the Unwritten Kabala.

Of the unwritten Kabala, S. L. MacGregor Mathers, in his *Kabbala Unveiled* says: "The term 'Unwritten Qbalah' is applied to certain knowledge which is never entrusted to writing, but communicated orally. I may say no more on this point, not even whether I myself have or have not received it."

The author of these lessons is not so modest about his acquaintance with the unwritten kabala. He has received it fully, and has also investigated the written traditions of the Jews and of all other peoples having had much influence in shaping the world's thought. And this seems the proper place to point out that the unwritten kabala, like the written kabala, is set forth in symbolical language, with purposeful blinds and subterfuges to confuse the uninitiated; so that of the few who undoubtedly exist at the present day who have received it, most remain in as much ignorance of its true interpretation as the majority of students do after studying the more accessible written kabala.

This unwritten kabala has been transmitted only through certain secret schools. Those receiving it well merit what is given to them. They are left to their own devices in the matter of interpretation. And because the real keys to its

interpretation—astrology and the tarot—have been largely ignored, or distorted, they have floundered sadly in arriving at its meaning. Whether written or unwritten, the kabala is a philosophy correlated to esoteric astrology as exemplified by the tarot; and it can only be comprehended fully by those who perceive the true relation between astrological energies and their pictured tarot exemplification.

The Kabala of The Jews

—Because the Jewish kabala has been the source of inspiration to so many alchemists, metaphysicians, occultists and mystics, it deserves special attention, and the remainder of the lesson will largely be devoted to it. It has three main divisions: A. The Practical Kabala. B. The Literal Kabala. C. The Dogmatic Kabala.

A. *The practical kabala* treats of ceremonial magic, and includes the making of magic circles, wands, swords and pentacles, and the use of inscriptions and symbols for performing wonders. It deals with necromancy, sorcery, exorcisms, sigils, enchantments and communications with angels and devils.

Accessible books treating of this subject are: The Sixth and Seventh Book of Moses, The Greater Keys of Solomon the King, and The Lesser Keys of Solomon. Needless to say, as set forth in detail in Chapter 3 of Course 18, *Imponderable Forces*, these books and all such practices are highly dangerous, and innocence is no protection to those who dabble in such matters.

B. *The literal kabala* is so written that the letters and numbers and words must be transposed to perceive the meaning. It is a work really written in code, and must be systematically decoded to have any value. And the code in which it is written, and which must be used to decipher it, takes three different forms as follows:

1. Gematria

In this system, words of the same numerical value are used as symbols of each other, and phrases of the same numerical value are employed to explain each other. And as each Hebrew letter is a number, this number is also obtained and used, by adding the numerical value of the letters of a word or phrase.

2. Temura

This is a code in which, according to prescribed rules, certain letters are substituted for other letters. In addition to this permutation, the form of the letters occasionally used, and the variations in spelling, all have a hidden meaning, and for important matters anagrams are employed.

3. Notariquon

In the practice of this, abbreviations are extensively used. Every letter, for instance, may be taken as the abbreviation of a word, and a single word expanded into a sentence. Or the first letters, or the medials, of every word in a sentence may be used to construct one word that conveys the mystical import it is desired to impart.

But even after, though determining just what code has been used, having translated the literal kabala into ordinary language, it still presents the matter in the form of universal symbols, which, while quite pregnant with meaning to those who understand this universal language, is merely a collection of babbling allegories to one ignorant of the tarot and astrology.

C. The *dogmatic kabala*. This division of the Jewish secret doctrine has four chief headings, each embracing more or less numerous commentaries which were written at different times by different writers: 1. Sefhir Yetzirah. 2. Sefhir Sephiroth. 3. Asch Metzareph. 4. The Zohar. Yet none of what is now called the Jewish Kabala was placed in writing before the beginning of the Christian Era.

We are seriously informed by commentators that it was first taught by God to his select angels who formed a school in Paradise. Then, after the fall, the doctrine was communicated to man that by its means he might regain his lost estate. From Adam it passed to Noah, then to Abraham, on to the Egyptians, from whom it reached Moses.

Moses was further instructed regarding it by an angel, during his forty years in the wilderness. Then Moses injected its doctrines covertly into the first four books of the Pentateuch, and initiated Aaron and the Seventy Elders into its secrets. From them, according to this tradition, it was handed down through an unbroken line of priesthood succession which included David and Solomon, to the time of the destruction of the second temple; when, for the first time, it was committed to writing.

This account, due allowance being granted to its symbolism, conforms rather closely to the traditions regarding the line of descent of the secret doctrine as recorded by initiates of other than the Jewish race.

It is held by this tradition that once the earth had a very different climate, warm and mild, and that the people of the Golden Age, like those in Jewish Paradise, were free from strife, and needed to take no thought as to what they should eat or what they should wear. So pure were they that they had constant communion with the angels.

But gradually changing climatic conditions, in which life became increasingly severe, coarsened the bodies and the minds of the people of the earth. And finally, so terrible was the struggle for survival with the advent of the Age of Iron, when a glacial sheet covered most of the northern hemisphere, that man was forced to eat the flesh of animals to avoid starvation. And thus descending to the plane of a carnivorous creature, the increasing activity of his animal soul cut off his ability to communicate with still higher entities. He no longer could get his information direct from the angels, because he had become too selfish and coarse to be able to tune in on their vibratory rates, and he must, perforce, get whatever he wished of the secret doctrine from those of his race who had preserved the tradition from an earlier time.

This kabalistic knowledge was a teaching concerning the origin of the universe, man's proper relation to God and all other entities, why man entered material conditions, and how he might through partaking of the Tree of Good and Evil

ultimately regain his spiritual estate and also partake of the Tree of Life, and so attain Self-Conscious-Immortality.

From the children of the Golden Age, the tradition relates, this information was handed down by word of mouth, as allegorical stories, to more material times. And thus it came to be an essential part of the wisdom for which the ancient lands of Atlantis and Mu are renowned.

Before the last cataclysm, in the Bible referred to as the flood of Noah, when the last of these two older continents sank, the Priests of Stellar Wisdom, perceiving through astrological cycles the approach of such a disaster, had encouraged the establishment of colonies in what later were to become the seven ancient centers of civilization—Egypt, India, Crete, Peru, Mexico, China and Chaldea. And to these colonies then established, that the ancient spiritual wisdom might not perish from the earth, they sent those to reside who were familiar with it.

Just when the colonists from Atlantis or Mu reached their various outposts is not clearly defined. But in Egypt, Moses, educated by the priesthood, came directly in contact with their teachings, and in his wilderness wanderings received further communications from higher intelligences; all of which became a part of the doctrine held by the Jewish priests, and handed down to later times in the form of abstruse allegories.

It seems certain that none of what now is known as the Jewish Kabala was written until after the commencement of the Christian era. The first to place any of this traditional knowledge in writing is reputed to have been Ben-Ha-Kanah, about 70 A.D. Rabbi Ismael be Elisha wrote about 121 A.D. And Simon be Jochai, another Talmudist, the supposed writer of the Zohar, appeared about 150 A.D.

However as a matter of historical research, it is found that the Kabala first put in an external appearance in the seventh century, apparently through Neo-Platonist and Neo-Pythagorean channels. The main body of the Zohar seems to have been unknown, except in the secret schools, until the thirteenth century of our era.

The early writings on the Kabala include a work called Palaces, describing God's throne and His angelic household, a work of The Dimensions of Deity, and the Alphabet of Rabbi Akiba. In this letter each Hebrew letter is taken to represent a primordial spiritual idea.

The Sephir Yetzirah

—In the eighth century the Sephir Yetzirah put in an external appearance. It is a complete philosophical system, divided into 33 brief sections, each in reality based upon one of the 12 zodiacal signs, one of the 10 planets, one of the 10 numerals, or the seal of the earth.

The work opens with the statement that there are 32 paths of secret wisdom. These are further elaborated in a commentary, called the 32 Paths of Wisdom, written in 32 brief sections.

Sephir Yetzirah signifies The Book of Formation, and is supposed to have been dictated by Abraham. The key to its meaning is the manner in which it is divided into chapters. As in all there are 6 chapters, the formation of the universe is to be explained through a study of the number 6. This number, as reference to Arcanum VI indicates, has for divinatory significance the word Temptation, and in numbers indicates the oscillation of unequilibrated forces in their action and reaction. Astrologically, it corresponds to Venus, the planet of love. Therefore, according to the system upon which the Sephir Yetzirah is to be interpreted, the idea is conveyed that the Infinite was Tempted into expression through the desire to love. The Supernal Mind, that it might enjoy love, brought forth the manifested universe.

Of these 6 chapters, the first contains 12 sections, which, of course, correspond to 12 zodiacal signs.

The second chapter has 5 sections and the third chapter has 5 sections. Thus these two chapters represent the universal man divided as male and female; the number of man being 5 and the number of woman being 5; and together these numbers embracing the 10 numerals of the decade.

The fourth chapter has 4 sections, each representing one of the formative attributes of the septenary, corresponding to the 4 negative planets: Saturn, Venus, Moon and Mercury.

The fifth chapter has 3 sections, each representing one of the 3 active principles of the septenary, corresponding to Sun, Mars and Jupiter.

The sixth chapter contains the remaining four sections each representing one of the three remaining planets of the chain, Uranus, Neptune, Pluto, and the seal of the earth which synthesizes these 32 numbers and astrological forces into a single grand unity.

Masonry and the tarot are both founded upon 33 universal principles. These are rather unsatisfactorily set forth in kabalistical code in the Sephir Yetzirah. They bear a correspondence in human anatomy to the 24 vertebrae plus the 9 ankylosed bones that form the base of the spine. In the widest sense Deity is the 33, or unifying principle. Thus we have the doctrine set forth kabalistically that Deity, all-potential and alone, was Tempted into an expression of his Love, and this formative power became diversified into the 32 principles through which His love is Realized.

The Letters

—In the kabalistical system each Hebrew letter is not only a number but in addition represents an idea. Just what the idea is which is thus associated with each letter it is a function of the Tarot to reveal.

The Hebrew alphabet as a whole contains 22 letters. These are divided by kabalists into three groups. The first group contains the three mother letters, representing certain general principles, from which the other letters and their corresponding principles were formed. Then there are seven double letters, and finally twelve single letters.

The three mother letters are Aleph, Mem, and Shin. Aleph represents the plane of spirit, Mem relates to the astral world, and Shin to the physical where all is given form. Thus do the three mother letters correspond to ego, Soul and Body of the Universal Man.

Certain other letters are sometimes aspirated and sometimes not, and are thus called double letters. As there are seven planets and seven active attributes in nature so are there seven double letters; Beth, Gimel, Daleth, Caph, Pe, Resh, and Tau. And as there are 12 zodiacal signs, so there are 12 single letters, although in detail they do not correspond to them: He, Vau, Zain, Cheth, Teth, Jod, Lamed, Nun, Sameck, Ayin, Tzaddi, and Quoph.

And now we arrive at a point which may easily prove somewhat confusing to the student. It is the numerical equivalence of the Hebrew letters, and of the corresponding English letters.

The Hebrew and the Chaldean square-formed letters are identical, and the square-formed Egyptian letters are very similar. These letters were originally hieroglyphics for the spiritual ideas represented by the corresponding Major Arcanum of the tarot, these, in turn, being correlated spiritually to astrology. Each letter, thus, expressed a number—some number from 1 to 22—which had the same thought-vibratory rate as one of the 22 astrological influences.

But these letters coming into use by those uninitiated in this spiritual and vibratory relation naturally were subject to conventionalizing influences. And furthermore, those who sought to make translations from Hebrew into the English language had no knowledge of the vibratory rate of a letter, and no care for its spiritual correspondence. Consequently, translators have made use of equivalents which, although convenient for them, are not of the same vibratory rate.

Therefore, to preserve the true numerical value of each square-formed letter, occult students have continued to use their original numerical significance rather than those established by later conventional use. And in deriving the English equivalent of a square-formed ancient letter, in those cases where translators have substituted an English letter with a different thought-vibratory rate, occult students use a true vibratory equivalent. Thus the Hebrew Tau, which means the sign of the cross, is translated conventionally as Th; and Teth, which means serpent, is translated conventionally as T. But not only is T in the form of the Tau cross used in many lands, but with its point down thus represents the creative energy diverted to earthly ends, and as such it has the significance of 22 and not 9; and 9 has the vibration of Th, the serpent, the spiral of life, being the Deific number.

This translation of T and Th is the outstanding difference between conventional translators and occult students. But it should be understood by those who study the kabala and the tarot, that in such studies the real vibratory rate of a letter is the important thing in determining its correspondence in another language; and that the English equivalent of each square-formed letter has been tested out on this basis.

The correct numerical and English equivalent of each square-formed ancient letter will be found in a table at the front of this booklet. And that the student may also have the conventional, and therefore exoteric, significance, a list here follows:

1. Aleph, A, means ox. 2. Beth, B, means house. 3. Gimel, G, means camel. 4. Daleth, D, means door. 5. He, H, means window. 6. Vau, V, means nail. 7. Zain, Z, means weapon. 8. Cheth, Ch, means fence. 9. Teth, T, means serpent. 10. Jod, J, means hand. 20. Caph, K, means palm of hand. 30. Lamed, L, means ox-goad. 40. Mem, M, means water. 50. Nun, N, means fish. 60. Samek, S, means support. 70. Ayin, O, means eye. 80. Pe, P, means mouth. 90. Tzaddi, Tz, means fishing-hook. 100. Quoph, Q, means back of head. 200. Resh, R, means head. 300. Shin, Sh, means tooth. 400. Tau, Th, means sign of the cross.

Sephir Sephiroth

—The Sephir Sephiroth is also called the Book of Emanations. It treats of the numerical expansion of the undifferentiated state of evolution. That is, it explains that creation, as it later came into existence, was first in the Divine Mind. Then to give this mental conception a more external form it was projected into an evolutionary system, by means of definite impulses, each of which bears a relation to a certain number. The universe is thus shown to have been created according to a definite plan, the parts of this plan bearing numerical relations to each other. This plan calls for a continuous expansion of possibilities, whereby an infinitely diverse number of forms move perpetually forward toward greater perfection.

The work, as written, is highly mystical; for it considers these impulses from the Divine Mind, by which the universe is brought into existence, as bearing the same relation to each other as do certain numbers. These numbers are thus the representatives of universal principles.

The student, therefore, who would read the Sephir Sephiroth understandingly must be well versed both in the Hermetic System of Numbers, and the Doctrine of Signatures; for the Doctrine of Signatures reveals in full concrete details the action of those principles which are but abstractions when merely considered as numerical relations.

Asch Metzareph

—Asch Metzareph, or Purifying Fire, treats of alchemy. To comprehend the allegories in which it is written the student must have a thorough knowledge of chemistry, of astrology, and of the tarot. The action of substance upon substance, as

set forth in this treatise in the language of universal symbolism, depends upon the inner nature of each; upon that quality which we now recognize as its vibratory rate.

The Zohar

—The most studied of the Jewish kabalistical works is the Zohar, or Book of Splendor. It is generally supposed to have been written by Simon be Jochai, about 150 A.D. Moses de Leon made it accessible to the public in the thirteenth century.

It embraces The Book of Concealed Mystery, The Greater Holy Assembly, The Lesser Holy Assembly, The Aged Man, The Book of Clear Light, The Faithful Shepherd, The Palaces, The Secret of The Law, The Concealed Treatise, Mysteries of Mysteries, Song of Songs, Come and See, The Youth, Illustrations of The Law, The Early Work, and certain fragments.

The aim is to reveal to the worthy the nature of the Supreme Being, the equilibrium of contrarities, cosmogony, the symbolism of numerals, the nature of man and angels, the law as revealed, the nature and destiny of the soul, and much about angels, elementals, demons and other occult intelligences.

The most essential and most emphasized of all kabalistical doctrines is expressed in translations of the Jewish work as “Quod Superius, Quod Inferius,” which means, that which is above is as that which is below, the Macroposopus, the universal man, is to be understood by a study of Microposopus, the finite man. God is thus related to the natural universe as the ego is related to the body of man. Consequently, we find Deity commonly referred to as The Ancient One, The Vast Countenance, Illimitable One, The Concealed of the Concealed, Adam Kadmon (the Archetypal Man), etc.

Next in kabalistical importance comes the doctrine of the Ten Emanations of the Sephiroth, by which the universe was created. Sephiroth means numerical emanation, and the kabala teaches that all manifestation is accomplished in definite numerical proportions through actions and reactions in the One Primeval undifferentiated substance.

Prior to creation there was Ain Soph Aur, meaning limitless light, or non-differentiated substance. The first emanation, or numerical impulse is known as Kether, meaning Crown, and symbolizing Motion or Life.

Instantly, upon motion being transmitted to the non-polarized, universal, all-diffusive spirit, it becomes polarized into two attributes, positive and negative, masculine and feminine, action and reaction; for life or motion is impossible apart from sex, or polarity. It is impossible to have action without reaction, positive polarity without negative polarity, motion without something moving, something moving without form. Consequently, springing into existence simultaneously with Kether, or Life, are two other emanations called Chocmah and Binah. These usually are translated as Wisdom and Intelligence by theological kabalists who try to dethrone anything feminine from the Deific Trinity. But all initiates are aware that they mean Love and Light; for Love is the highest and truest Wisdom.

However large the orbit of the student's investigations, or however recondite the plane of its action, he will find that it must start with, and finally end in, this kabalistical trinity of Life, Light and Love. From this primitive trinity of positive, negative and union the universe became differentiated into Seven specific attributes through seven additional emanations.

The Ten Emanations of the Sephiroth are, therefore, the Seven Active Principles of Nature springing from a central source of Life, Light and Love—from a triune God-head, or Spiritual Sun—just as we receive magnetism, light and heat from the physical sun.

Although it has been well known that there is a strict correspondence between astrological principles and the 10 Emanations of the Sephiroth, the Emanations really manifesting as astrological forces, this correspondence has heretofore been carefully concealed as part of the Greater Mysteries. Also, as the universe is divided into positive, negative and union, kabalists have divided the 10 Emanations into three pillars, or Trees. The tree on the right is the Biblical tree of Good, the Masonic pillar Jachin, kabalistically known as the Father, or Pillar of Mercy. The tree on the left is the biblical tree of Evil, the Masonic pillar Boaz, kabalistically known as the Mother, or Pillar of Justice. Centrally between these two trees of the knowledge of good and evil stands the tree of Life, conferring Immortality. It is the place of union of Jachin and Boaz, kabalistically known as the Shekinah.

But early kabalists, to conceal their knowledge from the profane, in illustrating the trees in the form of a diagram, gave it incorrectly, knowing the spiritually enlightened in the course of their initiation would discover the error. It would thus point to the truth without actually revealing it, which by their oath they were bound not to do. In all current works upon the kabala, therefore, being copied from older works, we find emanation 2-4-7 constituting the Tree of Good, 3-5-8 the Tree of Evil, and 1-6-9-10 the Tree of Life, the Shekinah, or Pillar of Mildness. The correct diagram is given on page 130 in chapter 6, where it will be seen that as should be, the even, or esoteric, numbers 2-4-8 constitute the right-hand Pillar of Goodness, and the exoteric numbers 3-5-7 constitute the left-hand Pillar of Evil. Also it will be seen that the necessary planetary correspondences to each of the emanations when arranged in the latter manner will place benefic planets on the Tree of Good and malefic planets on the Tree of Evil.

The First emanation is called Kether, meaning Crown, and symbolizing Life or Motion. It corresponds to the planet Pluto. It belongs at the head of the Tree of Life, containing latent within itself both male and female potencies.

The Second emanation is Chocmah, meaning Wisdom, and symbolizing Love. It corresponds to the planet Neptune, the head of the Tree of Good, in a spiritual sense being positive to Uranus, though not so from the material plane.

The Third emanation is Binah, meaning Intelligence, and symbolizing Light. It corresponds to the planet Uranus, being the head of the Tree of Evil, being external to, and therefore more gross and spiritually negative than Neptune, and also commonly much more malefic.

The Fourth emanation is Chesed, meaning Mercy, and symbolizing Beneficence. It corresponds to the planet Jupiter, being the middle of the Tree of Good, and positive to the Saturn principle of Evil.

The Fifth emanation is Geburah, meaning Severity, and symbolizing Affliction. It corresponds to the planet Saturn, the middle of the Tree of Evil, and is negative to the principle of Good.

The Sixth emanation is Tippereth, meaning Beauty, symbolizing Attraction. It corresponds to the planet Venus, the middle of the Tree of Life, where all influences join in a common harmonious Union.

The Seventh emanation is Netzach, meaning Victory and symbolizing Conflict. It corresponds to the planet Mars, the foot of the Tree of Evil, and is negative to Mercury even as blind force is ever subject to intelligence.

The Eighth emanation is Hod, meaning Splendor, and symbolizing Knowledge. It corresponds to the planet Mercury, the foot of the Tree of Good, and is positive to the instincts and impulses of Mars.

The Ninth emanation is Yesod, meaning Foundation and symbolizing Formation. It corresponds to the Moon, next to the foot of the Tree of Life, the enfolding, formative power that gives external expression to Tippereth.

The Tenth emanation is Malkuth, symbolizing Vitality. It corresponds to the Sun, at the foot of the Tree of Life, wherein the Spiritual Ideals of Kether, having been attracted by Tippereth, and having undergone formative gestation of Yesod, are brought forth in full Virility of expression, becoming in man Self-Conscious-Immortality.

These three trees have been the great mystery of the kabala, and volumes of abstruse reasoning and mystical allegories have been written in the attempt to throw light upon it; for kabalists have all perceived that the Tree of Life, or the four emanations 1-6-9-10, constitutes the secret of Immortality. But just what this signifies in human life only a few have discovered, and others have blundered along blindly for want of proper keys, which astrology and the tarot alone afford. But the moment any kabalist is shown that Venus is Tippereth he immediately perceives the truth.

The head of the Tree of Life is the planet Pluto, symbolizing the separation of the sexes, the place where soul-mates part on their downward journey and the place where they must again unite on their upward path. But the Tree of Life itself is formed by the union of the Tree of Good with the Tree of Evil—three positive forces

and three negative forces meeting at a common point called Tippereth. Thus what Venus is to the human body, by the law of correspondence, Tippereth must be to the Tree of Life.

Now Venus rules the seed and union, and kabalists are well aware that the Shekinah, or Tree of Life, is some kind of union. But what they usually fail to recognize is that in man there is a spiritual seed as well as one physical, and that union, as indicated by the four vibratory levels, or stations, represented by the four emanations within the Tree of Life, can take place on the plane of degeneration, on the level of generation, in the realm of regeneration, or in the exalted state of the reunion of soul-mates.

Yet Venus, the planet of love, is the key to this revelation. For those who recognize that Tippereth is a seed endowed with life during union, giving formative expression in the womb of Yesod, and brought forth into life and action by Malkuth, even as daily this is known to happen in the generation and birth of children, should easily recognize that the same principle applies to the evolution of Immortality. But, of course, as in bringing forth life in the domain of Malkuth, at the foot of the tree, the energies are directed toward the earth, and as immortality is not of earth but of the highest spheres, the energies must be directed toward the highest level of union, toward the exalted and permanent exchange of spiritual energies which corresponds to Pluto when that planet is represented by the letter T with its point up, instead of down toward Malkuth, as commonly written.

A few kabalists have perceived the truth of this matter. One, for instance, who was also a great alchemist, states in his writings that he was acquainted with the mystery of transmutation but had never proceeded to the practice because he had not found a woman who could help him in the work.

Also Mr. A. E. Waite, the eminent kabalist, in speaking of the Shekinah says: "I have said there are intimations of this state in eastern teachings, by which, I mean India, but that—so far as I am aware—they have not passed into writing." And he further concludes, after an exhaustive study of kabalistical literature: "We shall come to recognize only one secret doctrine of Jewry, which is the secret concerning sex."

Reincarnation

—This seems to be the place to mention that the Jewish Kabala teaches reincarnation, but only for those who fail to finish their work, and never more than three times. And even in these instances, more often than not, more than one soul occupies the same body to gain strength. Thus the teachings of the Zohar contradict the teachings of reincarnation as commonly taught in the East. It sets forth the impossibility of numerous reincarnations, and really seems to be a confused notion regarding the attachment of a discarnate soul to one in the flesh for some definite gaining of experience or the performance of some unusual purpose.

Soul-Mates

—The doctrine of soul-mates is quite distinctly taught in the Zohar, it being stated that those who abide by the laws of the Lord will meet and marry their true soul-mates; but that those who pervert the law will be denied such union. Impurity keeps soul-mates apart, but purity and a moral life bring them together, and when so united there also will be a permanent heavenly union after death.

God, Himself, is both Father and Mother. The word Elohim, translated in Genesis as God, is Feminine plural; but the translators of the Bible, not wishing women to share in anything Divine, have rendered it throughout in the Masculine singular. There is, however, an inadvertent admission of the Father-Mother principle when Adam is said to have been made in the image of “Elohim, Male and Female made He them.” Hebrew scholars say that “Eloh” is feminine singular, and that the ending “im,” is a termination of the masculine plural, the two being used together to indicate a feminine potency united to a masculine idea.

Throughout the Kabala “The Ancient of Days” is considered both Male and Female, and the Ten Emanations are divided into 5 positive and 5 negative attributes.

The Four Realms

—The Ten Emanations of the Sephiroth are divided into groups having affinity with the four worlds; but at the same time the ten emanations also each manifest in these four realms. The four kabalistical worlds are:

1. Atziluth, meaning Emanation and symbolizing the celestial realm and the element fire.
2. Briah, meaning Creation and symbolizing the spiritual realm and the element air.
3. Yetzirah, meaning Formation and symbolizing the astral realm and the element water.
4. Assiah, meaning Action and symbolizing the physical realm and the element earth.

The first 3 emanations relate particularly to Celestial realms, the place of ideals, even as Pluto, Neptune and Uranus have an influence over the highest ideals of man.

The second 3 emanations pertain specifically to Spiritual realms, to the creative regions, even as Jupiter, Saturn and Venus have an influence over man’s moral nature, his reflective powers and his affections.

The third 3 emanations relate more closely to the formative regions, to the Astral realms, even as Mercury, Mars and the Moon image, construct and mold the products of man’s genius.

And the final emanation belongs to the Physical world, to the realm of practical action, even as the Sun vitalizes and brings forth from the soil innumerable forms of life.

Interpreting the Kabala

—The great kabalistical student, Eliphas Levi, asserts that the kabala is a sealed book to anyone unfamiliar with the tarot. Not only is this true, but the tarot, as here presented, will be found a key to unlock all other sacred books as well. To the discriminating student the most difficult kabalistical phrases will yield their inner meaning when the tarot methods are applied.

Very briefly to illustrate, we find *The Book of Concealed Mystery* opens thus:

1. The Book of Concealed Mystery is the Book of the equilibrium of balance.” The balance here referred to is Polarity, as exemplified by the Second Major Arcanum of the tarot.
2. For before there was equilibrium, countenance beheld not countenance.” That is, consciousness was not possible before this duality.
3. And the Kings of ancient times were dead, and their crowns were found no more: and the earth was desolate.” These kings of the tarot being in ancient times, indicates a previous round of evolution; being dead refers to the cosmic sleep of nirvana. Kether, or Crown, means activity; therefore, intelligence of the Divine Mind was inactive, and there was no differentiation in progress.
4. Until that head, desired by all desires, appeared and communicated the vestments of honor.” Arcanum I, Deific Intelligence, awakens and sends the first Divine thought-wave throbbing throughout the unmanifested void of Ain Soph Aur.
5. This equilibrium hangeth in that region which is negatively existent in “The Ancient One.” Arcanum II, Isis, where polarity first manifests, is negative, or feminine.

Such explanations might be carried out in regard to every Kabalistical statement.

Summary

—As the Jewish Kabala is mostly written in code, and all of it in the form of allegories, it takes much effort for the student to form a clear idea of its chief tenets. I will, therefore, here sum them up in unequivocal language:

1. God and the Universe are the Ego and Body of the Grand Man, or Macrocosm; and finite man, or the microcosm, is a miniature copy of the Grand Man, corresponding to Him in all details.
2. The universe sprang into differentiated existence in conformity to the law of numbers. These ten emanations from Deity manifest on every plane as 3 general and 7 specific attributes. In their interaction with one another they form, by a principle similar to that giving musical overtones, 22 less abstract and more specialized influences, or astrological qualities. These, manifesting as the 12 zodiacal signs and 10 planets of the chain, together with the 10 original numbers, form the 32 paths of evolution, which really are the 32 factors of all manifested existence. Yet at any given time all these 32 influences converge at every point in the universe. That is, in some quantity they are

everywhere present. And the specific point where they thus manifest—the earth, for instance—being a synthesis of their influence, constitutes a 33rd factor.

3. Great importance is attached to sex, it being taught that man can reach the feminine principle above only through union. The Shekinah is perfect union; and it is taught that mankind approaches God only through Shekinah. Those of impure mind and gross passions can not partake of Shekinah, for Shekinah is the Tree of Life, partaking of the fruits of which mankind is brought face to face with Adonai; entering thus into Divine Consciousness.

4. Souls are differentiated in pairs, have an existence before material birth, are separated before incarnation; and it is this separation which constitutes the original transgression. But through living a pure and spiritual life on earth they ultimately are attracted to each other and may even meet on earth. This meeting is the Shekinah, and in time permanently reunites them in heaven.

5. As exemplifying these four doctrines and their numerous offshoots, there is the mystery of the pronounciation of the name of Deity, which in the Bible is translated Jehovah, and in Hebrew is a word of four letters, IEVE, or Jod-He-Vau-He.

Jewish tradition holds that, “He who can rightly pronounce it, causeth heaven and earth to tremble, for it is the name which rusheth through the universe.”

The real significance of this venerated word is that it stands as representing the four universal principles; and therefore he who understands these four letters is also able to comprehend all power and all manifestation; and he who is able to pronounce it—or utilize his knowledge—is able to live in complete harmony with the Divine Law and thus partakes also of Divine power. It really signifies that nothing is impossible to one who unites himself to the Cosmic Will.

Because it is composed of four letters the name is called the Tetragrammaton. These four letters, which are symbols of positive, negative, union and vibration, can be transposed in 12 different ways, all conveying the same meaning, just as nature manifests through the 12 zodiacal signs, yet in essence remains the same.

These twelve ways of expressing the Deific name are called the 12 banners. These banners are spelled thus:

IEVE—IEEV—IVEE—EVEI—EVIE—EEIV—VEEI—VIEE—VEIE—EIEV—
EIVE—EEVI.

**The Tarot Cards Utilize
Both
Extra-Sensory Perception
and Extra-Physical Powers**

—A vast amount of experimentation by universities in America and in England since the discovery of Pluto in 1930 not only proves that man possesses the power to gain, through extra-sensory perception, information not accessible to reason and the physical senses, but that this perception extends into both the past and the future.

On the inner plane consciousness can be extended unhindered by physical distance, and extended backwards and forwards in physical time. Even as to gain knowledge on the physical plane, so on the inner plane the attention must be focused on the information desired. The tarot cards, through their universal symbols, are designed, among other things, to assist in extending the inner-plane consciousness and focusing it on the information desired.

All mental processes are governed by the LAW OF ASSOCIATION. What has been perceived on the inner plane through extra-sensory perception resides in the unconscious mind as a memory. To remember it—to bring it up into objective consciousness—there must be a line of association between what is in objective consciousness and this memory. The symbols on the tarot cards are the most effective means known of forming the associations that enable what was perceived through extra-sensory perception to be recognized by objective consciousness.

The university experimenters have also demonstrated that physical objects can be influenced without the aid of any physical contact with them. This result of using extra-physical power they call the PK (Psychokinetic) Effect. The unconscious mind, or soul, uses this power to cause the tarot cards in a spread to become so placed as to reveal information obtained through extra-sensory perception.

Chapter 2

Serial No. 22
Original Copyright 1936
Elbert Benjamine

Copyright
Church of Light
August 2002

Foundation of the Science

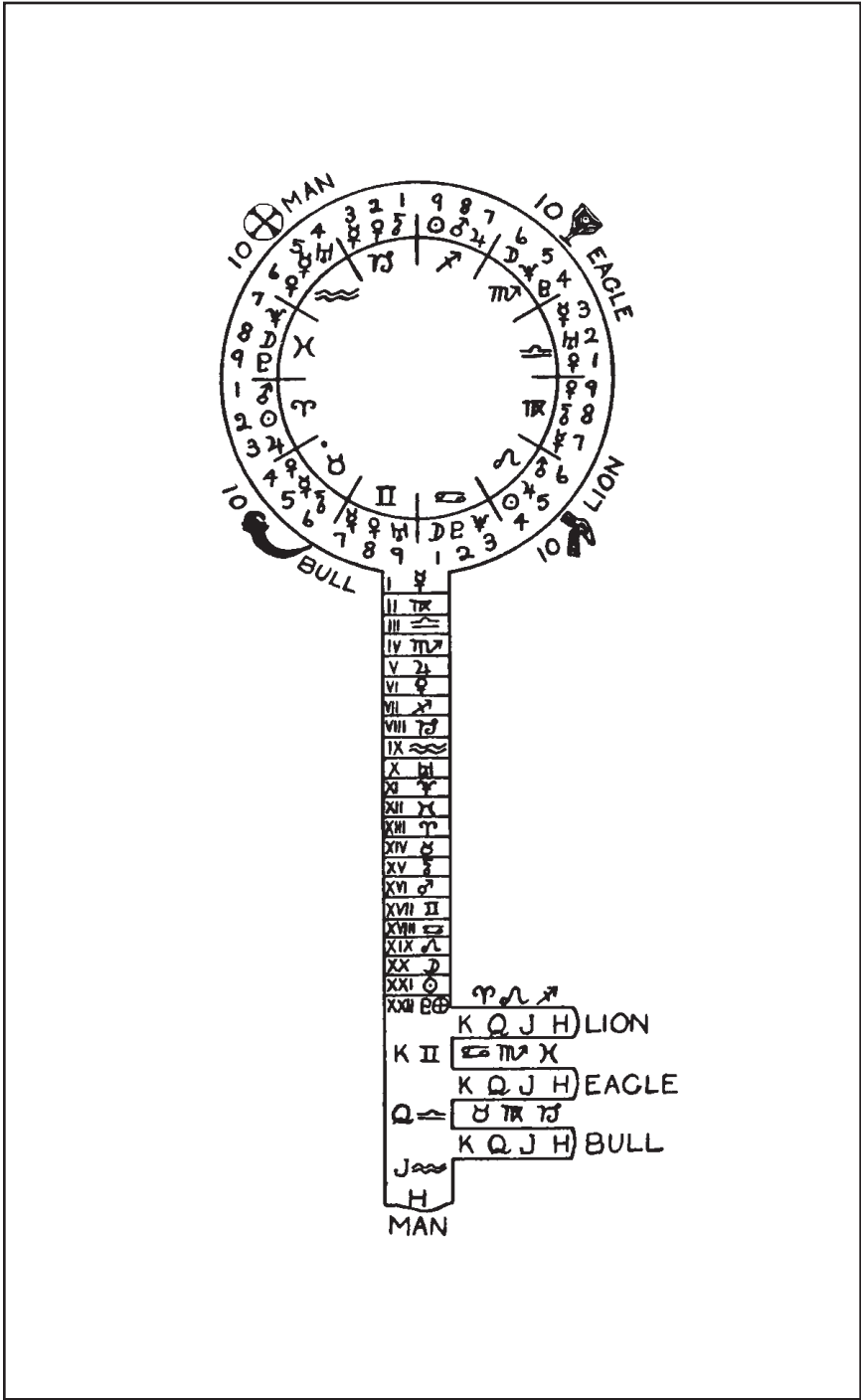

Tarot: The Silver Key

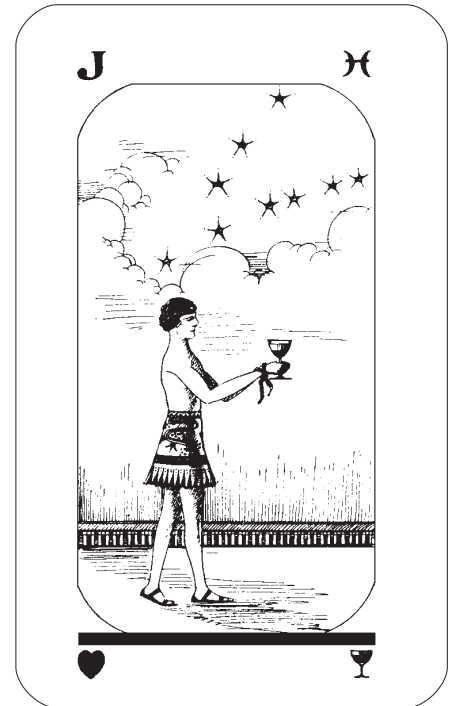
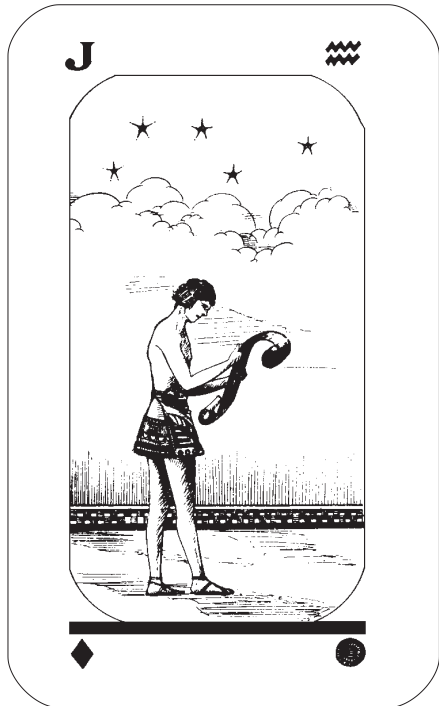
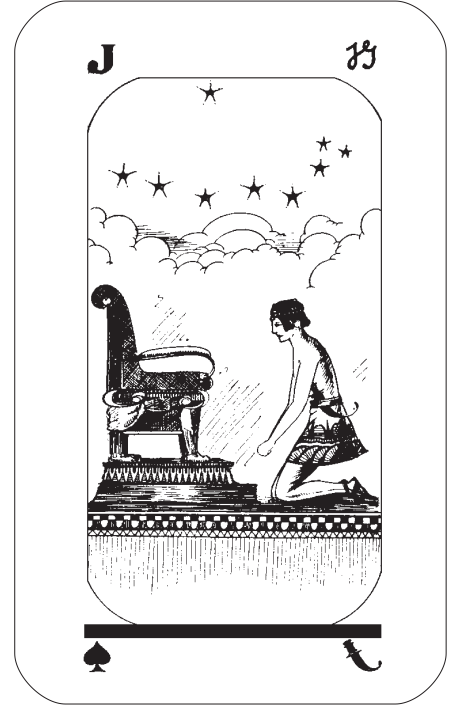

Chapter 2

Foundation of the Science

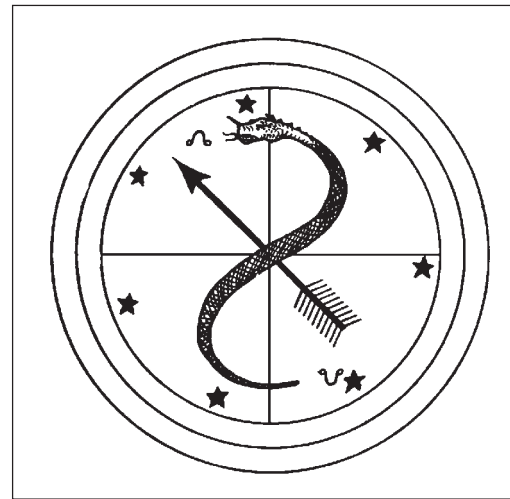

IT HAS BEEN said by that eminent kabalist, Eliphas Levi, that four signs express the absolute, and in turn are explained by a fifth. And we find this very true, both as applied to astrology and to the tarot. In each, the fifth term, by which the four fundamental elements are explained, is the language of universal symbolism. Therefore, the student may expect, in his study of the wide range of symbols employed in the tarot, to be made thoroughly conversant with a language which has been employed by learned men in all ages and all climes to impart the most profound truths, a language which, because of its wide appeal does not essentially vary with the passage of time, which is imperishable, and can be read by the intelligent members of any race. The tarot is the ONE standard text-book on the meaning of universal symbols.

Now these four signs, which are explained by universal symbolism, as applied to the Grand Man of the universe, are represented by the four quadrants of the heavens. These, in turn, of course, correspond in function to the four letters of the Deific Word, Jod-He-Vau-He. And because the sacred tarot pictures and explains this Grand Man from the feminine, or esoteric standpoint, it also has, in addition to being a text-book of the most ancient of languages, four distinct functions to perform.

Therefore, even before explaining the source from which the sacred tarot is derived, I feel that these four distinct and important functions should be set forth, and that those who teach this Hermetic System should insist that their students should at all times keep these four functions in separate compartments of their minds, without confusing one with another; for each is a distinct and clear-cut system in itself.

Two of these systems—as must be true if they correspond to the Divine Jod-He-Vau-He—are positive. They are really sciences. And the other two are feminine and negative. They are systems of divination, each accurately corresponding to one of the four corners of the universe.

Corresponding to the Leo quarter of the zodiac there is a Science of Vibration, to which numbers furnish the key. Corresponding to the Scorpio section of the firmament there is a system of Divination by means of Cards. Corresponding to the

Taurus quadrant of the sky there is a system of Numerology, or Divination by means of Numbers. And Corresponding to the Aquarius region of the heavens there is a Spiritual Science, which forms the basis of a complete philosophy of life.

The Science of Vibration

—Right here it should be emphasized, so that later no confusion may arise, that the Hermetic System of Vibration as determined through using numbers is quite unrelated to any system of numerology. Numerology, new systems of which are being devised each year, is a method of divination. And as divination by numbers is one of the four functions of the tarot, nothing here is said in disparagement of numerology. In fact, I set forth such a system in chapter 8 of this course.

But the vibratory science here explained, although dependent upon numbers for the determination of effects, is not numerology. It is a positive science, as precise in its results, and as independent of psychic matters, as any physical science. Through it, as the physicist determines by means of numbers the vibratory frequency of different colors, or as by means of numbers he determines the vibratory frequency of any selected musical tone, so also by means of numbers, can the vibratory key of any thought be determined.

The great Caruso, in demonstrating the power of his voice, also well illustrated the importance of the vibratory key. When he went into a cafe, at times he would call for a wine glass. Tapping the glass to get the key, he would request the waiter to place the glass on a table in a distant part of the room. And then, by singing the tone to which he had found the glass keyed, by the powerful vibrations of his voice reaching it across the room, the glass would be shattered.

Thoughts, like vocal tones, are vibratory rates; but they are definite vibrations in astral substance. Nevertheless, like Caruso's voice, they have the power to travel across space and bring about physical changes. And like his voice, also, it is their vibratory key, as well as their volume which determines their effect.

The key to which thoughts are tuned often can be determined by their subject matter. But other thoughts, which also have powerful vibratory rates, are abstract in quality. That is, they merely designate some thing or quality. Such are names, and such are numbers.

It is not the physical sound of a name or a number that is its potent influence; it is the thought-vibration of the one thinking it, which radiates outward from his mind to the person or thing thought about. This vibration reaching a person thought about influences him according to the key of the thought. Different names and different numbers vibrate in different keys. Different vibratory keys produce different effects upon the objects or persons they contact, even as do different sounds. And, wholly apart from any process of divination, it is the object of the Science of Vibration as set forth in these studies to determine the key to which names and numbers vibrate, and how they affect the things and people with which they become associated.

Divination by Numbers

—Because, as I have already pointed out, there are an increasing number of methods of using numbers in divination, little need be said about this phase of the subject here other than to point out that all these systems of Numerology, as well as the Hermetic System of Divination by Numbers, are really methods of divination. As such they possess a legitimate function. Many of them other than the Hermetic System give quite accurate results. But in no case should they be considered as a Science of Vibration; for such a science is based upon the observed effect of thought vibratory-rates, and is something entirely apart from any kind of divination.

Divination by Cards

—Nor is any system of laying out the cards strictly a scientific and positive process. Like numerology, the methods of card reading set forth in this Hermetic System, as well as all other card-reading methods, are useful; but they essentially are systems of divination.

Spiritual Science

—Now, however, when we come to that function which sets forth a spiritual science as a basis for a complete philosophy of life, we are again back on positive and scientific footing.

It is true that in perfecting this science there is recourse to the law of correspondences. Nevertheless, the philosophy of life derived from this science is based upon the strict observation, by those throughout the past ages who were most competent to ascertain them by experimental methods, of spiritual facts. Every noteworthy spiritual fact that has been uncovered by the researches of the most exalted minds since the world began, and checked as to accuracy by subsequent illuminated ones, is set forth in the language of universal symbolism in the sacred tarot. That is why we who delve deeply into it call it Sacred. But while the spiritual facts are thus clearly set forth, except for certain guiding lines each is left free to draw from them such conclusions as his state of evolverment will permit. The facts are there, but to us is given the task of giving them an adequate detailed interpretation. But after all, of what particular use is a spiritual philosophy?

Because the vibrations of people thinking our name, or our telephone number, reach us and conduce, through stimulating harmonious or inharmonious conditions within ourselves, to our health and happiness, or to our failure and misery, it is easy to see that a science of vibration which enables us to regulate such matters is important. And, in so far as divination gives us valuable and reliable information, it is not difficult to understand the prevalent interest in numerology and in card reading. But of what value is a spiritual science, or the philosophy derived from it?

Well, to give a proper perspective to this one of the four chief functions of the tarot, we must make a brief examination of life in general, and of man in particular.

Man, for instance, like all other living entities, possesses a strong desire to live. But the life of any organism continues only so long as it makes successful adaptation to its environment. Part of man's environment consists of countless other forms of life, toward which it is essential he should observe a proper code of conduct. He must obey the impulse of the moment seldom, but instead, consider the effect of his action as influencing his future welfare.

Especially is it important that he shall conduct himself properly toward others of his kind, otherwise conflict, or wanton depletion of food supplies, may cause all to perish. His chances of survival are greatly heightened when he can obtain, not the antagonism, but the cooperation, of some of his fellows.

Such cooperation, however, is only made possible by an understanding as to mutual aims. When such mutual aims have been established a single tribe becomes better equipped to attain them than any individual, and a nation becomes superior to a tribe. Yet members of any cooperative group who have variant aims weaken the effectiveness of the whole. Thus for mutual advantages, and to prevent disaster befalling, there must come to be a recognized standard of conduct.

Such a code has for purpose those actions which will confer the greatest advantages on the whole group, and thus also confer them upon the individual members. And the advantages striven for are determined by the knowledge of the people. But whether those prescribed in the standard of conduct actually contribute to the welfare of the group or not, and to what extent, depends entirely upon how correctly they have interpreted the true relation of one life-form to another, and the true relation of the individual to the group. This interpretation, because actions are based upon it, is the most dominant factor in shaping the lives of a people. It is called their ethical standard.

Now in national life those things are advocated which are believed to add to the richness of people's lives, and those things considered destructive are prohibited. Yet people have not found a means by which physical dissolution can be postponed more than a few short years.

After-Death Survival

—Not being able to make the continuous adaptation to a physical environment which would enable them to continue living upon earth, it was quite natural that some should investigate the possibility of a life in a region after physical death. And our foremost scientific men, by means of careful experiments, have confirmed their findings that man does live beyond the tomb.

Yet wherever life is found, its survival and the fullness of its existence depend upon successful adaptation to environment. This same law must apply to the after-life of man. That is, to the extent he is able to make perfect and continuous adaptations in

that future realm, will his life there prove satisfactory. Furthermore, as he has found knowledge to be the most essential factor in his adaptation on earth, he has a right to assume that the more knowledge he has concerning the conditions to be encountered, and about how difficulties are to be met and overcome, the better he will get along in the life after physical death.

Many as yet are content with mere surmise as to the conditions that there obtain. And all through the dark ages man was content merely to surmise how matter behaved under different circumstances. Yet the progress man has made in material ways, the attainment of numerous comforts, and all of what we call modern civilization, was brought about by those who were not content with surmise, but who set about gathering accurate knowledge about physical things.

Furthermore, ancient ruins give testimony of considerable scientific achievement even before history began. We have surpassed the ancients in these matters, it is true, and we may be able to surpass them in that other field to which tradition and ruins alike bear testimony, that is, in the field of spiritual science. But if we are able to do so we must discard surmise and substitute accurately observed phenomena.

Upon the accuracy of the Chaldeans in calculating certain celestial phenomena, modern astronomers are forced to place considerable reliance, and to base some of their own findings. And as to the knowledge of astrology these same Chaldeans possessed, anyone who will take the pains to learn to erect a birthchart can soon prove to himself that they had accurate knowledge which is scoffed at by the abysmal ignorance of parrot-taught scholars.

Instead of taking the rules laid down by the ancients, and testing them by the approved methods of experimental science, conventional intolerance does battle with them by appealing to prejudice. And the same dogmatic assertions are used to discredit and block the path of anyone who makes a candid investigation of spiritual science.

It is true that mystical folly runs rampant under the guise of occultism; but for that matter less than three centuries ago material science was no less a medley of confused notions and dogmatic opinions. And it became necessary, in order to build a sound structure for material science, to discard all that had gone before, and build on the solid foundation of observed facts. Upon such an unyielding foundation the framework of scientific thought has been reared, each timber being fitted to its proper place by the methods of deductive thought. And so erected, it constitutes a shelter which protects man from a thousand and one dangers which threaten his physical survival.

But it has been unable to prolong the physical life indefinitely, and man as of yore, looks beyond the earth-plane to another existence after the tomb. About this after-life much is said, but little is commonly known. Yet all seem to agree that some kind of preparation for the new condition is necessary, or at least desirable. That is, they feel that as effort is necessary to enable one to adapt himself to physical life, some kind of

effort must be necessary to make successful adaptation to any life in the future. But men do not agree of what this preparation should consist.

The very yearning of the human soul, therefore, demands that there shall come into existence a spiritual science, a science which shall inform man definitely about the life he will be called upon to live after he leaves the physical plane; and that will direct him as to the preparations which should be made, while still on the physical plane, that will enable him the more successfully to adapt himself in the realms of the future. Thus do the necessities of man demand a spiritual science. But such a spiritual science can be soundly constructed only on the plan which so successfully has been used in the construction of material science. Notions must be cleared away, surmise must be swept to one side, and a foundation laid of indisputable facts quarried from the lode of critically observed phenomena. Then upon this foundation a framework should be erected according to the strictest methods of logic. And if the work thus done has been thorough there should result a shelter which is effective in protecting us from the inclemencies encountered in any life on any plane.

In gathering this information for the foundation, we can use the reports of the physical senses somewhat; because they have been found to give rather accurate information as checked by practical affairs. But they also, at times, have been found unreliable; and thus they should be checked by those other senses, the senses of the astral, the psychic senses. These psychic senses also, in so far as practical experience proves them to be accurate, should be used to gather information. But because they also sometimes report falsely, their findings should be checked as to accuracy by the physical senses. Information should be quarried wherever it can be found, and by whatever method can be used; but before entering into the foundation of a spiritual science it should be tested by every known means.

Now as to these psychic senses, about which some people may be skeptical, bear in mind that because a man can not track a hare by scent does not imply that a hound can not do so. And because many hounds fail to follow some particularly cold trail does not prove that some other hound may not be able to do so. The limits of one hound's ability is not the measure of the ability of another hound, and whether a particular man can do something that another man can not should not be made a matter of surmise, but subjected to experimental proof.

And thus in the application of the psychic senses; just how reliable their reports are must be experimentally determined for each individual, by subjecting their reports to subsequent proof. Yet when used judiciously, and in conjunction with his physical senses and common sense, they are found to be extraordinarily valuable aids to spiritual knowledge.

In using the physical senses to gather material to be included in the foundation of a spiritual science, we find that there is a sympathetic relation between objects and events upon the earth and the heavenly bodies and their movements. No psychic faculties are needed to prove this, as it comes directly under the methods of physical experiment. Yet the science of astrology, which sets forth in mathematical terms, the

relation of the heavenly bodies to things on earth, has mostly been handed down to us from the ancient magi. Not that we merely accept what they have stated; but, using statistical methods upon observed results, we have found their statements and interpretations amazingly accurate.

The same magi specialized, generation after generation, for thousands of years, in just two things: they specialized in astrology, and they specialized in gaining information concerning the soul of man.

In the acquisition of information on these two subjects they developed their psychic senses to a high degree, and they kept laborious records of experiments, day after day, year after year, generation after generation.

And, in so much as the vast amount of information which has come down to us from them concerning astrology has been proved by experimental methods and modern research to be highly accurate, we are justified, I think, in placing some confidence in their findings where their other specialty is concerned. All the more so, because they linked their spiritual findings to astrology. Astrology, to them, was not merely character-reading, and a means of predicting events. It was also the science of the soul and the key to all spiritual possibilities. It had an exoteric side, which was applicable to the physical affairs of life; but it also had a more important esoteric side, which revealed the nature of the soul and to what conditions it would be subjected in the future.

Thus these men of an olden day formulated just such a spiritual science as that for which we search. They scanned the universe with highly trained psychic vision, they checked the information gained in one manner by information gained in another manner; and when, as time went by, they became convinced they had some spiritual treasure, by means of correspondence, which they understood so well, they traced this spiritual fact as a constellation in the sky.

Still further applying this principle of correspondences, they attached each to a number, so that spiritual ideas might be combined and handled mathematically, even as by means of numbers we solve the more humble problem of the family budget. And that they might thus be handled with facility, even as in algebra we use x , y , z , to represent more complex things, they used symbols to represent the spiritual verities that were being considered.

For convenience in handling, these symbols, which stood for definite spiritual ideas, were engraved on plates. And thus it came about that each plate contained, in the language of universal symbolism, the explanation of some important spiritual fact. It explained in more detail than the pictured constellation or the symbol of the planet, just what these men of old had discovered. It was an esoteric interpretation of the spiritual truths associated with some planet or zodiacal sign. And attached to the plate was its corresponding number, so that through combining numbers having the same value as definite spiritual ideas, spiritual ideas could be handled mathematically. By combining their numerical equivalents a number could be thus obtained which would represent the correct resulting spiritual idea.

Now, of course, we should not accept the spiritual findings of these ancients until they have been subjected to rigorous tests. We should not accept the findings of either moderns or ancients as conclusive. But because in those things where rigid tests have been applied these men of old have proved to have had such amazingly accurate and comprehensive knowledge, if we were to overlook their work it would, no doubt, make our own research far more laborious. Let us approach the spiritual ideas they have left us, not as conclusively proved, but in the same manner as we approached exoteric astrology. Let us take them, one at a time, and subject them to proof. And if the knowledge they left us concerning spiritual things compares in accuracy with the knowledge they left us concerning astrology, our labors in establishing a true spiritual science will surely be lightened.

Origin of the Tarot Cards

—Those plates upon which, in the language of universal symbolism, the ancients inscribed their knowledge of spiritual things and the attainments possible to the human soul, were called by the Egyptians, The Royal Path of Life.

In Egyptian, Tar means path, and Ro means royal, and thus, even at this day, the plates are known to us as the tarot.

As a part of the mysteries divulged to candidates only after passing hazardous trials and hardships, they have largely remained the property of secret schools of occultism and jealously guarded by them. What has filtered through to the public has been rather unsatisfactory and vague, although occult students the world over have recognized their importance.

The magical wheel discovered in the thirteenth century by Raymond Lully, which was to solve all problems, was the tarot. In the sixteenth century, William Postel wrote concerning it as, The Genesis of Enoch, in a book entitled, *The Key of Things Kept Secret From the Foundation of the World*. He believed it antedated the Bible. Count de Gebelin wrote concerning it, and St. Martin studied it. Eliphas Levi wrote his masterpiece, *The Dogma and Ritual of Transcendental Magic*, from studies of it, and S. L. MacGregor Mathers, Papus, and A. E. Waite have contributed works about it.

From this it might be concluded that little is left to be said about the tarot. But unfortunately for the general public the secret schools have had no intention of permitting real knowledge concerning it to escape from their midst. Consequently, much that has been written about the tarot has been, not for the purpose of making clear its real significance, but to reveal what had clandestinely escaped from the secret schools. Even so fearless a writer as Eliphas Levi admits this, and the few mistakes he makes in his own writings are so glaring, and yet so near the truth, that they can be ascribed neither to carelessness nor ignorance.

One of the most conscientious of mystical writers, Mr. A. E. Waite, explains the matter thus:

“There is no extant ritual, as there can be no doctrine, which contains, or can possibly contain, the secret of mystical procedure or the essence of mystical doctrine. The reason is not because there is, or can reasonably be, any indictable secret, but because the knowledge in question is in the custody of those who have taken effectual measures for its protection; and though from time to time, some secrets of initiation have filtered through printed books into the world at large, the real mysteries have never escaped.”

In the *Pictorial Key to The Tarot*, he further comments: “There is a secret tradition concerning the tarot, as well as a Secret Doctrine contained therein; I have followed some part of it without exceeding the limits which are drawn about matters of this kind and belong to the Laws of Honor. This tradition has two parts, and as one of them has passed into writing it seems to follow that it may be betrayed at any moment, which will not signify, because the second, as I have intimated has not passed at present and is held by very few indeed. The purveyors of spurious copy and traffickers in stolen goods may take notice of this point, if they please.”

Men who follow science as a profession have a very different code of honor. The truly scientific man does not hold what he discovers, or what others have discovered, merely to benefit a chosen few. It is the code of science to give whatever information is discovered to the public that not one select clique may have an advantage, but that the whole human race may be the gainer. And it has always seemed to me a colossal piece of selfishness for any group of men, if they really possessed information that might be beneficial to all mankind, to hoard it for themselves alone.

I hold, therefore, that secrecy in any matter that will aid the soul in gaining knowledge of its true relations to the universe, or that will assist in making life happier, or the attainment of spirituality easier, is not a virtue. Consequently, departing from the custom of many other writers on this subject, I am introducing no blinds and no subterfuges into these lessons. As to traffickers in stolen goods, what I present, in its essentials, has been in the custody of The Brotherhood of Light for ages. But even were it otherwise, I would not hesitate to present any information that I deem might in some manner assist human progress and happiness, from whatever source it might be gleaned.

The time has ceased, I trust, when a few shall possess a monopoly on the truths regarding spiritual things. The reader will find here all that is necessary for him to know about the tarot and its Secret Doctrine to put him on the right path, and he could hope for no more even within the most exclusive circles; for attainment is not vicarious.

As to the methods of mystical procedure so carefully guarded, supposed never to have been committed to writing, possessed by so very few, whose mysteries have never escaped to the world at large; I take pleasure in pointing out that it is the method by which man reaches God directly. It may be mentioned also that it is not the exclusive possession of the Occident, but is known as well to initiates of the Orient.

To give the western version might be deemed trafficking in stolen goods. Therefore, as the eastern interpretation is fully as valuable and accurate I will state where it may be found:

The original work is exceedingly ancient and rare, is inscribed on palm leaves, and found only in the remotest parts of India and Tartary. It is called, The Atma Bodha, or Book of Soul Knowledge. It is divided into three books, the second being a commentary on the first. The third book contains but seven statements which form a brief summary of the whole subject. The work, translated into English was possessed by members of The Hermetic Brotherhood of Luxor (long since closed), and is fully as lucid in explaining mystical atonement as are the teachings on this subject of any western order. Lack of space prevents the giving of more than the summary, the key to the whole matter; but this meditated upon in connection with the tarot will prove quite sufficient for anyone whose spirituality is such as to permit illumination; which is all that any outside help can give, although the whole work is of utmost value.

“BOOK III

“The Aphoresmata of The Logos

- “I. Whatever exists, exists as a Whole, as God, or is a part, or emanation from God.
- “II. In the Whole as an angel, unconscious of the Whole, is an undescended spirit.
- “III. Parted from the Whole, yet a portion of the Whole, and unconscious of the Whole, is the Law of Differentiation.
- “IV. Parted from the Whole, with the Whole, yet external to the Whole, is a descended or fallen spirit.
- “V. Parted from the Whole, with the Whole, yet conscious of the Whole and knowing it has fallen away from, and that it should, and can, return to the Whole, is the Law of Reascension.
- “VI. That which is parted from the Whole, turns again to the Whole, is the Law of True Repentance.
- “VII. That which was parted from the Whole, and has again returned to the Whole, is a part of the Whole, remains so forever as a blest spirit, and is the Law of Perfect Atonement.”

Tarot Correspondences

—Of the plates on which the ancients pictured the facts they ascertained regarding spiritual science and universal law, which have been handed down to us in the form of the tarot cards, 22 are more important than the rest. They correspond to the 12 zodiacal signs and the 10 planets in the chain. And the ideas thus pictorially expressed in universal symbolism later came further to be condensed as conventional and easily written hieroglyphics, and this is the origin of the square-formed letter of the Hebrew and Egyptian alphabets. And, because there were no separate characters for numbers, each such square-formed letter also became the number expressing the spiritual idea embodied in the pictured plate.

Then to still further express the numerical interaction of forces and ideas between the four kingdoms of fire, earth, air and water; a scale of ten numerals was added, and repeated in association with the emblem of a kingdom, giving a total of 40 additional plates, or suitcards. Each according to its number, of course, corresponds to some astrological subdivision of the original 22 conceptions.

All these forces, however, have an influence upon man. He is the point where they come to a focus. But men are not all the same, and this difference in type is best expressed by the sign of the zodiac under which each is born. So we have 12 plates, or cards, picturing people born under each of the zodiacal signs. To express the family relation they are represented as Father, Mother and Son, pictured more commonly as King, Queen and Youth (Jack). The temperaments of these people are further shown by the suits; for the fiery signs of the zodiac represent the sanguine temperament, the watery signs the lymphatic temperament, the earthly signs the bilious temperament, and the airy signs the nervous temperament. Thus the suit denotes the temperament.

In addition to cosmic and other influences there is another thing of importance. People have thoughts. They are probably the most potent of all forces. Consequently, it was essential to have them represented. And to show their source of origin they should be associated with people. Therefore, to depict them, the ancients had recourse to a horseman; for the Twins, ruling the house of private thoughts in a natural birth-chart, were often represented on horses; and Sagittarius, ruling the house of publically expressed thought in a natural birth-chart; is a horseman. The complete set of the tarot plates, or cards, therefore consists of 22 Major Arcana, 40 Minor Arcana, and 16 Court Cards; a total of 78.

Just why each Major Arcanum is a pictorial representation of the spiritual associations of the planet or zodiacal sign with which it is given will be made plain as we make a study of each.

The four members of each suit of court cards represent, in their wider application, the Hebrew name of Deity—Jod-He-Vau-He; signifying masculine, feminine, union, and the product. And they also throw light upon the origin of the Holy Trinity worshiped by Christianity.

In Egypt, Osiris the Father, Isis the Mother, and Horus the Issue, were popularly worshiped; and in addition there was a fourth deity which included the three others, and overshadowed them, as do the thoughts of a family, called the Holy Ghost.

So when Athenasis came from Egypt to the Holy Council of Nice to assist in settling of what the orthodox Trinity consisted, he introduced the Holy Ghost. Most contemporaneous nations, other than the Egyptians, held merely to the Trinity of Father, Mother and Issue. But the Holy Ghost came to Christianity at an opportune time; for due to the teachings of Paul, and the fanatic asceticism that was developing, it was becoming quite certain that woman could have no part in anything divine.

The monks who retired to monastic life looked upon woman as an instrument of evil, a tempting agent of the devil, strictly to be avoided. They characteristically shifted the blame for all the ills of humanity to her shoulders by teaching that the fall of Adam was due to the guile of Eve. So, while the Church still retained the Virgin Isis—which as the sign Virgo, has from time immemorial been pictured as a virgin with a crescent Moon in her arms to symbolize the immaculate conception—as the Mother Mary, and venerated her accordingly; they felt compelled to cut her from the Holy Trinity. In her stead they substituted the Holy Ghost.

Yet while cutting woman from the Holy Trinity, they were powerless to efface her from nature; and in the common playing cards as in the tarot, she holds her rightful place as Queen, joint ruler with the King. But the fourth court card, still retained in the tarot, even as the spirit of rectitude and justice which in its wider application it represents, has departed from our midst.

Origin of the Suits

—As to the emblems by which the four suits are recognized, they were derived as universal symbols from the most important of natural phenomena, the passing of the seasons.

Even as heralded in the verses of Omar, the spring is signaled by the rose. In certain older cards the rose is sometimes found. The spring is the period of renewed life, and thus the rose, as representing it, in some mystical orders, is the symbol of a renewed life. Spring brought a new food supply, which nourished life. But this food supply, by which life might be sustained also might be purchased. And thus we have the pieces of money, the coins of the tarot. But in later days a more commercial age decided that for sustaining life through trade, diamonds were even more precious than money. So in modern cards we have the suit of diamonds.

The summer brought the trefoil, or three-leaf clover, which was important for forage to the flocks of a pastoral people. So the clover became associated with the heat of summer. A similar heat could be produced with wood. And thus scepters came to be the symbol of summer heat, and are so represented in the tarot. Moderns, however, continue to picture the clover, but refer to the wood still, calling it the suit of clubs.

The autumn, when the wine was pressed from the grape, came to be the season of festivities, of dancing and of marriage. To represent the emotions then engendered, the cup, from which the wine was quaffed, came to be used, and thus is still one of the suits of the tarot. But moderns, associating the emotions of joy, and those that result in marriage, with the heart, have preferred to use them in picturing the corresponding suit of playing cards.

The winter was a time of dearth and want. To provide for this period when no food could be garnered, it was customary to work hard to gather and hoard a supply sufficient to last through until spring. And it was observed that the oak also thus provided a food supply which was similarly stored by the squirrels. Thus the acorn

came to be used as the symbol of winter. But, in time, the afflictions of winter, and the struggle to sustain life, especially as it often led to strife among peoples, came to be depicted by the emblem of strife, the sword. Yet a still later people looked upon the unfruitful season as the cause of their unceasing toil; and to depict this, used the modern emblem of toil, the shovel, or spade as it is called in modern playing cards.

Thus the balmy air of spring is represented by coins, the fire of summer by scepters, the bibulous festivities of autumn by cups, and the hardships of winter by swords. Therefore, we must consider that coins correspond to the airy signs, scepters to the fiery signs, cups to the watery signs, and swords to the earthy signs, of the zodiac.

Making the Spread

—When the unconscious mind has its attention focused on obtaining certain information, the psychic senses are active to obtain that information. And because of the vastly wider scope of their power, due to the properties of inner-plane existence where they function, they are able to acquire information quite inaccessible without their aid. This information then resides in the astral brain as a memory. That is, it is a memory of what has been gathered astrally.

The tarot cards afford both a means by which the attention of the soul is directed to acquiring such information, and a means by which this information, which then exists as a memory in the astral brain, can be raised into the region of objective consciousness.

One who has experience with the tarot cards will become convinced that there is some power present, not merely that directs how they shall be read, but that actually directs their distribution so that they will give a correct reading. Extra-sensory perception is able to observe their positions in the pack as shuffled. And extra-physical power (now demonstrated in our universities as the Psychokinetic Effect) in cooperation with the unconscious muscular activities of the shuffler, tends to arrange the cards in shuffling, and so to cut the pack, that when dealt they shall fall in positions to give the information desired. Full details of this process are set forth in Chapters 1, 2 and 3 in the Course 11, *Divination*.

The first essential of a reading is that there shall be a strong and unprejudiced desire to know something. If other strong desires or preconceived opinions intrude during the shuffling and reading of the cards, they will warp the reading from the truth. The mind should be concentrated on obtaining a correct answer.

While the mind is so occupied, the cards should be shuffled in such a manner as not merely to rearrange them in the deck, but to reverse the ends of some. They should then be cut into three piles and gathered again into a pack. This shuffling and cutting should be repeated three times; and then the cards dealt, face downward. They are turned over from top to bottom, but turned over only one at a time, as read.

Yes or No?

—To answer a question Yes or No, five cards are dealt in a single row, from right to left. The middle card counts 2 and the other cards each count 1. A majority of the counts right end up is an affirmative answer. A majority of the counts wrong way up is a negative answer. If the right way up and the wrong way up are evenly divided, it is a draw, and the answer is undecided.

Seven cards dealt in a row in this manner, from right to left, will answer a question briefly, and nine so arranged will give greater detail. The present of the matter is revealed by the middle card. The conditions or events leading up to it are signified by the cards commencing at the right. The cards commencing at the left of the middle and moving to the last one on the left, show the conditions and events pertaining to the matter in the future.

Chapter 3

Serial No. 23
Original Copyright 1936
Elbert Benjamine

Copyright
Church of Light
August 2002

Scope and Use of the Tarot

THE PYRAMID SPREAD

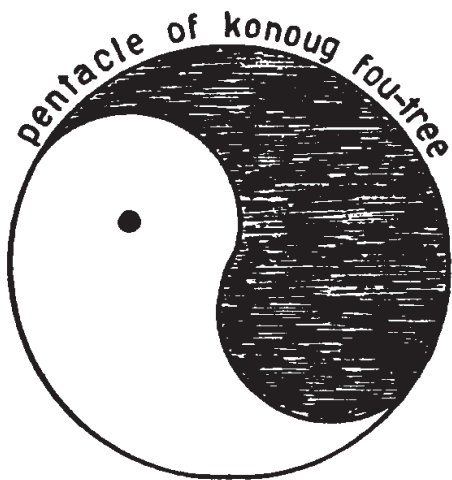
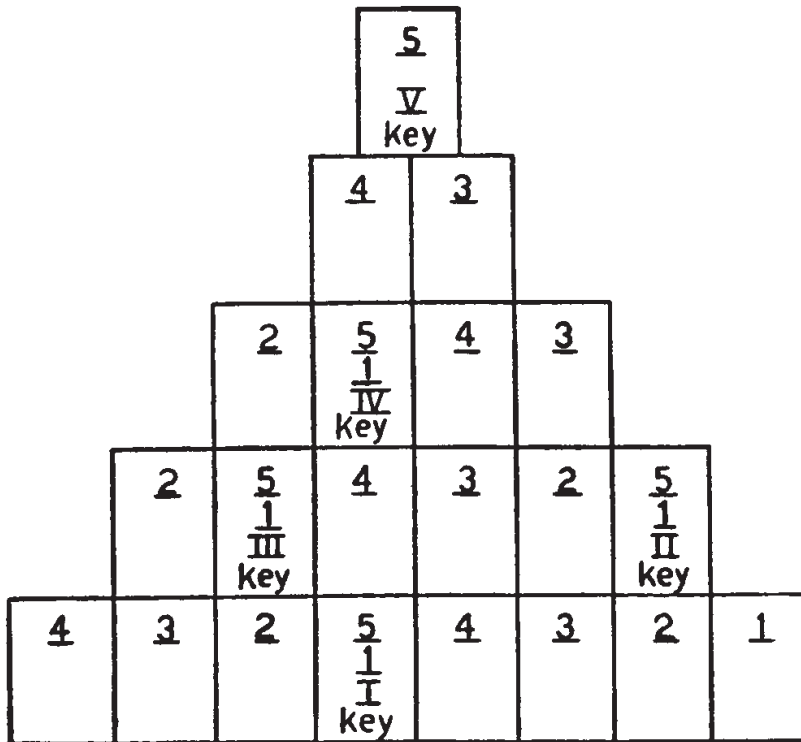

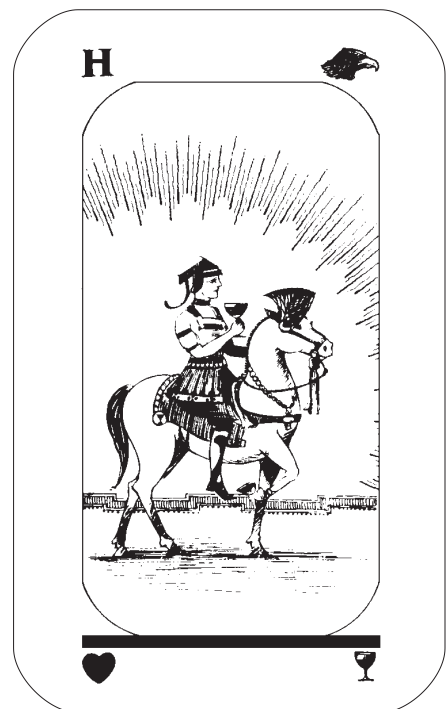
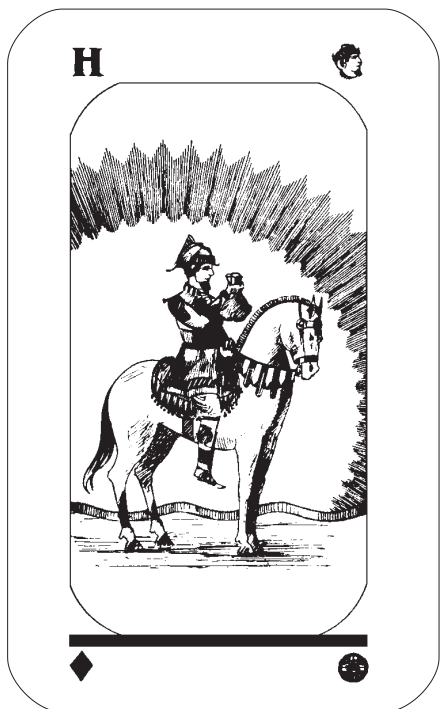
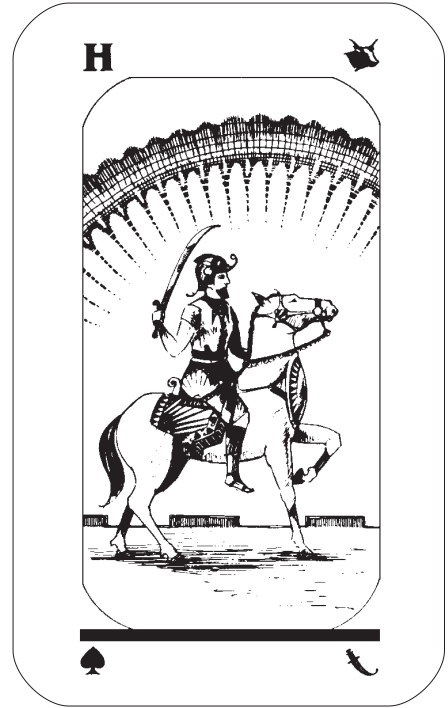
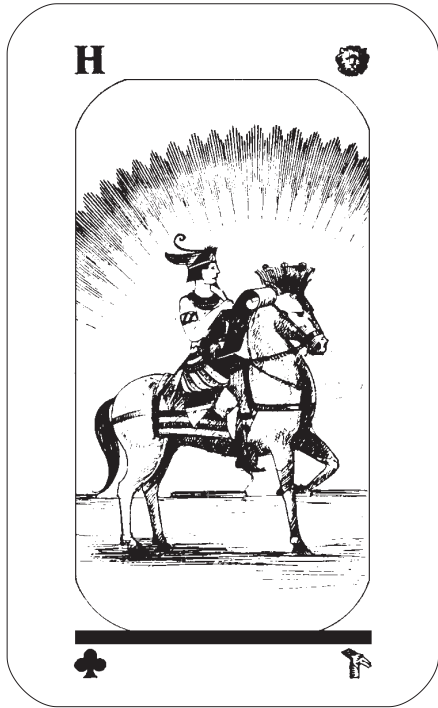

Chapter 3

Scope and Use of the Tarot



AMBLICHUS, a Neo-platonist of the fourth century and an initiate of The Brotherhood of Light, has left us an important document entitled, “An Egyptian Initiation”.

It contains an account of the trials of initiation, and of certain information given to the neophyte while passing these tests, in the Mysteries of Ancient Egypt. The different steps in this initiation as thus described, and what each step signifies, are set forth in full detail in Chapter 9 of Course 2, *Astrological Signatures*.

At one point in his journey the candidate is stopped before 22 frescoed paintings which picture the 22 Major Arcana of the tarot, and it becomes his duty to commit to memory these pictures, as well as their symbolism, which is then explained to him. As these pictures, together with such of their symbolism as is then explained to the neophyte, are fully described by Iamblichus, his work affords an accurate description of the Egyptian Tarot.

“An Egyptian Initiation” was translated from the original MS. into French by P. Christian, and those who have written much of value concerning the tarot have drawn heavily upon his translation. In 1901 it was translated into English, for private circulation, by my friend Genevieve Stebbins. And I am indebted to her for permission to use her translation of the description of the Egyptian Tarot.

In these lessons I have faithfully followed the description of the plates, the meaning of the symbols found upon the Major Arcana, and the interpretation of the Arcana in each of the three worlds, just as given in the translation of Genevieve Stebbins; and also the admonition after each Arcanum which runs, “Remember, then, son of earth,” etc.

The Admonition

—As to this admonition, although it probably will be used seldom by tarot students, I have thought it better not merely to include it, but to preserve it without change. It is a part of the old initiation ceremony, and may serve a more important function in the future than can now be discerned.

Modern translators of the old square-formed alphabet have changed the numerical value of some letters, and have transposed some letters. And modern astronomers, thinking to be more scientific, have sought to abolish the pictured constellations in the sky, using areas not identical in space and bounded by straight lines. Yet the original connotation of each letter revealed its vibratory significance and astrological relationship; and the original picture which each constellation presented revealed, as fully set forth in Course 7, *Spiritual Astrology*, the spiritual teaching it was designed to convey to later generations. Obeying an old Masonic command to “Alter not the ancient landmarks,” The Brotherhood of Light has preserved the original vibratory significance of the letters, and here faithfully reproduces the Egyptian Tarot, including the admonition associated with each Major Arcanum.

This admonition has a practical application both in card-reading and in astrology. Usually in a tarot spread, there is one card which is the key to the situation, or which indicates the individual for whom the reading is being given, or, perhaps, what this individual should do. And in a birth-chart, or in a horary figure, some sign or planet usually indicates the person for whom the reading is being given. When, therefore, it is desired to give an admonition to this person, the admonition given below the Arcanum which is the key influence in the spread, or indicates the person, may be used. And the admonition given below the Arcanum which corresponds to the dominant sign or planet in an astrological chart may be used in a like manner.

Correspondences

—The corresponding letter and number are a part of the translation of “An Egyptian Initiation.” But in order to handle the cards in the solution of any conceivable problem, as wide a range of accurate correspondences to the principles depicted by the Major Arcana as possible should be at hand. I have, therefore, given the astrological correspondence of each Major Arcanum. In the past this has been attempted in a desultory manner by one or two others, but those who attempted this were quite ignorant of astrology. My own familiarity with astrology dates from the year 1900, and by virtue of teaching it for years in class-work and writing courses of lessons on its various branches, which have become standard works upon the subject, I feel that I can speak in this matter with some authority. In these lessons the astrological correspondences of the tarot cards are given correctly in writing for the first time.

In addition, I have added the corresponding color, corresponding musical tone, corresponding occult science, corresponding human function, corresponding natural remedy and corresponding mineral, to each Arcanum.

The System of Presentation

—In order that the student shall have at hand concrete explanations of the application of the tarot, examples which he can use as models to follow in his own researches, after each Major Arcanum I have given some application of the principle which the arcanum represents in ten different domains as follows:

1. *Number*: The numerical significance of the principle is stated.
2. *Astrology*: It is shown why the principle pictured by the arcanum inevitably corresponds to a certain planet or zodiacal sign.
3. *Human Function*: It is pointed out which one of man's various forms and activities are expressions of the principle.
4. *Alchemy*: How this principle, indicated by the arcanum, operates in alchemical procedure.
5. *Bible*: As an aid to Bible studies, and the interpretation of allegories by means of the tarot, Bible passages are quoted which are exemplifications of the principle pictured in the arcanum.
6. *Masonry*: To aid the Masonic student to use the tarot to gain the esoteric meaning of his rituals, it is shown what Masonic teaching is conveyed by the arcanum.
7. *Magic*: In magic, also, the tarot is a valuable aid; and some magical principle corresponding to the arcanum being considered is set forth.
8. *Initiation*: If I were to omit examples of the use of the tarot in pointing out the steps in the soul's pilgrimage, it would be sadly remiss. This most valuable application is illustrated in connection with each arcanum.
9. *Occult Science*: For those who desire to use the tarot in special occult studies, the correspondence to some occult science is given under each arcanum.
10. *Minor Arcana and Court Arcana*: As a transition function, it is shown why the exoteric divinatory significance of the Minor Arcana are derived from their numerical relation to the Major Arcana, and how their esoteric and more spiritual significance derives from a corresponding decanate-division of the zodiac; also how the Court Arcana acquire their significance from the zodiacal signs.

And in addition to these examples of the use of the tarot, the lessons give instructions in the science of vibration, in divination by numbers, and after each second Major Arcanum there is given a different method of spreading and reading the cards.

If, however, the student goes no further than what is explained in these lessons, he has merely learned the fundamentals of the use of the tarot; for in the treatment here the attempt is to give accurate information, and to set forth examples, to the end of establishing proper methods of procedure which the student can apply at greater length in his own researches.

Different Tarot Packs

—The Egyptian Tarot pictures illustrated and described in these lessons, teach in still greater detail the same spiritual ideas that are taught by the constellations. Both constellations in the sky—the stars of which usually offer not the slightest suggestion of the design pictured—and the Tarot pictures adorning the walls of the ancient Egyptian initiation chamber, make use of primitive symbolical pictograph writing to convey the most important things the ancient wise ones had found out about the human soul. The Egyptian Tarot, then, portrays the spiritual conceptions of the Egyptian initiates, as derived from a still more remote past. There is a peculiar sympathy, however, between the thoughts of man and actions for which he finds no rational motive. That is, the same sympathy that exists between the happenings on earth and the positions of the planets in the sky also manifests through the unconscious mind.

If we but analyze our dreams we shall find that symbolism is the common language of the unconscious mind. And the successful use of the tarot cards as instruments of divination depends upon their sympathetic response to invisible factors of intelligence. So it would be indeed strange if they responded merely in the transitory laying of the spread, and not also in their symbolism to the minds of those who handle them.

When, therefore, the Tarot cards came into the hands of a people with a different conception of life, it would be remarkable if, at least in those tenets wherein they felt most strongly, the pictures on the cards were not changed sufficiently to portray these intense convictions.

Gypsy fortune-telling cards differ markedly from the Egyptian Tarot pack, but I am sure their symbolism is more correct in portraying the Gypsy philosophy and the Gypsy mode of life.

English, German, Italian and French packs differ from each other, because of national characteristics, and from the Egyptian and Gypsy cards because Christianity has made its impress upon them. But each pack, through that sympathetic response to the minds of those who use it, more correctly than the others, portrays in symbolical pictograph the deeper convictions of those who have thus somewhat altered its designs.

Even the playing cards, which are derived from the Tarot, show variations from the Tarot quite characteristic of their constant use as instruments of gambling.

To indicate more clearly what I mean, consider that in one of the best English packs the knight (horseman) of swords is an armored crusader, dashing across the frontier into another's domain in the well-known effort to spread enlightenment by means of the sword. The picture suggests instantly the conquest of far-flung empires and the forceful dissemination of Christian creeds among the benighted heathens thus conquered.

Variations of quite as important significance are to be found on almost every card in the different tarot packs; but I shall be content with indicating one more, which is, perhaps, the most striking of all.

The Egyptian Initiates believed justice to be the operation of an undeviating natural law. The number 8, by its two loops, is a symbolical pictograph of the two pans of the scales. The number 8 also represents an equal division; two realizations (4's) in equilibrium. In the Egyptian pack, the number 8 is attached to the Major Arcanum picturing the Goddess of Justice holding the balances in her hand, and, even as in the picture adorning the front of our court houses, Justice is pictured blindfolded, to signify that she is unprejudiced and not subject to bribery.

The Jews, however, believed that they were a chosen people; that Jehovah was a God of favoritism who could be cajoled into granting unmerited rewards to those who gained His good graces. Christianity inherited the same idea. In many Christian packs, therefore, we find Justice, although holding the balances, not associated with 8, but with 11. Because the scale of digits is complete with 9; and 10, by adding the circle of spirit, commences a new gamut on a higher plane, we have no difficulty in conceiving 11 as a force operating from the spiritual plane. But as the digits of 11 can never be equally divided, rewards, according to this Christian conception, are never exactly according to merit. They are meted out from above, not according to the Egyptian belief in an undeviating and blind law, but according to the whim of some higher power.

To make this conception of Divine Justice even more obvious, which seems to be patterned after the kind prevalent in some courts of earth, in these various Christian packs the eyes of Justice are not blindfolded, but wide open to prejudice.

It is not that one pack is better or worse than another, but that each pack of tarot cards has been unconsciously modified by the philosophy of life of those who designed it.

The Magus—Arcanum I

—Letter: Egyptian, Athoim; Hebrew, Aleph; English, A. Number I. Astrologically, the planet Mercury. Color, violet. Tone, B. Occult science, esoteric psychology. Human function, the spiritual body. Natural remedy, mental treatments. Mineral, the metal mercury.

A—I expresses in the spiritual world, Absolute Being, which contains, and from which emanates, the infinity of possibilities.

In the intellectual world, unity, principle and synthesis of numbers, and the will principle of acts.

In the physical world, man the highest placed of relative being, who is called upon to raise himself by a perpetual expansion of his faculties in the concentric spheres of the Absolute.

Remember, then, son of earth, that man should, like God, act without ceasing. To will nothing and do nothing is more fatal than to will and do ill. If the Magus should appear in the prophetic signs of thy horoscope, it announces that a firm will and faith in yourself, guided by reason and a love of justice will conduct you to the end that you wish to attain and will preserve you from the perils of the way.

In Divination, **Arcanum I** may be read briefly as **Will** or **Dexterity**.

Arcanum I is pictured by a Magus, type of the perfect man, that is to say, in full possession of his moral and physical faculties. He is represented standing; it is the attitude of will which precedes action. His robe is white, image of purity, original or regained. A serpent biting its own tail serves him for a girdle; it is the symbol of eternity which alone circumscribes his endeavors. His forehead is girt with a circle of gold. Gold signifies light, and the circle expresses the universal circumference in which gravitate all created things.

The right hand of the Magus holds a scepter of gold, surmounted by a circle representing spirit; symbol of the authority conferred by spiritual attainment. He raises it toward heaven in the sign of aspiration to science, wisdom and force.

Above is a four-pointed star, its rays extending heavenward; it is the over-shadowing genius of his spiritual master directing his efforts and counseling him in his upward struggles. The left hand extends the index finger to the earth to show that the mission of the perfect man is to reign over the material world. This double gesture also expresses that the human will should reflect the Divine Will in order to procure good and prevent evil.

Before the Magus, upon a cubic stone, are placed a cup, a sword, and a piece of gold money in the center of which is engraved a cross. The cup signifies the mixture of the passions which contribute to happiness and unhappiness according as we are their masters or their slaves. The sword signifies the work, the struggle which traverses obstacles, and the trials which sorrow submits us to. The coin, sign of determined value, is the symbol of realized aspirations, of work accomplished; and shows the sun of power conquered by the perseverance and efficacy of the will. The cross, seal of the infinite, by which the coin is marked, announces the ascension of that power in the spheres of the future. The cube upon which these symbols rest typifies the physical world; and has graven on its side an ibis, to indicate that eternal vigilance is a necessity if physical limitations are to be surmounted.

Number

—Numerically, I expresses the absolute. It is also the starting point of all measurements, and suggests infinite possibilities. All that is proceeds from one cosmos, which contains all, and to which all ultimately must return.

One is a synthesis, for nothing can be thought of without parts. It is the universal principle of existence, the creative intelligence of Deity, the motive force of the universe, which in man becomes will. In the macrocosm it stands for unlimited

potentiality, and in man for relative potency. It expresses the law of the conservation of energy and the indestructibility of matter.

Astrology

—The commencement of all work is its formulation, and this is a mental activity. Before the universe became manifest it was conceived within the spaces of the Divine Mind, from whence it was launched into objective evolution by the power of creative thought. Thus does mental activity correspond to number I.

A Magus is one skilled in magic. And magic is performed chiefly through the creation and vitalization of mental images. The Magus, therefore, is one in whom the power of the mind has been highly developed, and as in astrology mental ability comes under the rulership of the planet Mercury, this planet must correspond to both I and the Magus of Arcanum I.

Thus does Arcanum I represent the creative energy being directed intelligently, in distinction to the 2nd decave of I, which is pictured by Arcanum X, the planet Uranus, representing the one universal force unrestrained. It also differs markedly from the 3rd decave of I, pictured by Arcanum XIX, corresponding to the zodiacal sign Leo, representing the application of this energy to the attainment of happiness and the elaboration of domestic bliss.

In these three Arcana, each picturing the one universal virile force being used on a different plane, we have a complete commentary on the necessity of using the creative energies properly if any high degree of spirituality is to be attained. Without virility, without an abundance of creative power, nothing of importance can be accomplished in any field. Yet if this creative energy is generated in abundance and is permitted to act without proper guidance, it brings many abrupt changes in fortune, and through instability prevents little worth while being accomplished. If it is directed into mental channels alone it yields intellectual power. But when diverted into refined emotions such as true love and holy aspirations, it furnishes a power which attracts to the soul the highest spiritual bliss.

Human Function

—The spiritual body of man is constructed by states of consciousness having intensity enough to affect spiritual substance. Man does not possess a spiritual body merely by virtue of being man. He possesses it when, through the refinement of his thoughts and aspirations he has provided energy of a proper quality to build it. And only when the creative energies are active is there generated enough power, if it can be directed by ecstatic emotions, quickly to build anything on any plane. By a proper mental attitude toward them, all experiences may be made to contribute to this finer form. But to build anything on any plane quickly, there must be an abundance of the proper kind of energy, and this applies to the building of a spiritual body as well as to more material things.

Alchemy

—In alchemy, Arcanum I represents the most important of all discoveries, the philosopher's stone. Tradition informs us that any object touched with this stone is converted into gold.

This touchstone of alchemy is Truth; for when truth is pressed against anything its eternal principles are revealed, and these all-enduring qualities thus obtained constitute the gold of their underlying nature. Truth is correct knowledge, and this correct knowledge, if comprehensive, embraces the proper relation of souls and things to all other entities and forces. Thus truth is a freeing and transmuting power, a feeling as well as an intellectual perception. And when fully realized it results in deep aspiration, and in an unutterable longing and determination for a more perfect life.

Bible

—Even as Arcanum I is the opening page of The Book of Thoth, as the Egyptians sometimes called the tarot, so the Bible also opens with the principle of creative activity: Gen. I:I; “In the beginning God created the heaven and the earth.”

It is a principle especially revered by the Jews, constantly referred to throughout the Bible. Nor has it been entirely ignored in the New Testament, for the last chapter of the last book contains a clear, even if brief, exposition of Arcanum I.

Rev. 22:13; “I am the Alpha and Omega, the beginning and the end, the first and the last.”

Masonry

—The E.A. degree of Masonry is founded upon Arcanum I. This Arcanum represents the candidate who has been admitted into the Lodge, presented with the Masonic implements, and prepared to undergo initiation.

Magic

—Arcanum I indicates the importance of thorough preparation before any feat of magic is attempted. Every principle involved, and every implement used, should also be fully understood. The chief implements, including the magic wand, are depicted. The scepter indicates that the virility of some intelligence, either on this plane or another, is back of all magical phenomena. The star indicates the participation of an intelligence from another plane in the work.

In magic there are four operations, which are here symbolized by the four implements; the first operation, that of formulation, which means building the thing clearly in the mind, is also represented by the arcanum as a whole.

Initiation

—In the soul's pilgrimage Arcanum I represents the stage in which manhood has been attained and self-consciousness realized. He has learned the transitory and illusive nature of physical possessions, and has placed his feet once for all upon the road leading ultimately to adeptship. He realizes that success depends entirely upon his own efforts. In his aspirations he has raised his vibrations so that he tunes in on an intelligence of the spiritual plane, as signified by the star, and at critical times asks and receives guidance from this source. He moves forward henceforth with supreme confidence and sustained by an unwavering determination.

Occult Science

—The science of esoteric psychology embraces the complete field of mental activity; not merely on the physical plane, but on all planes where intelligence has expression.

The ancients placed so great importance upon the development of will power that they formulated a science of the will, the various phases of which each have a correspondence to one of the Major Arcana of the tarot. In expressing this, the name of each major card is taken as the emblem of some special principle involved. This science of the will, as given in "An Egyptian Initiation", is as follows:

"In uniting successfully the twenty-two significations which emanate from these symbols, their ensemble is summed up in the term,

"The Synthesis of Magic

"The human Will (1), enlightened by Science (2), and manifested by Action (3), creates the Realization (4), of a power which it uses or abuses according to good or bad Inspiration (5), in the circle which has been traced for it by the laws of universal order. After having surmounted the Trial (6), which has been imposed by Divine Wisdom, he will enter by his Victory (7), into possession of the work it has created, and establishing his Equilibrium (8), upon the axis of Prudence (9), he will rule the oscillations of Fortune (10).

"The Force (11), of man, sanctified by Sacrifice (12), which is the voluntary offer of himself upon the altar of devotion or expiation, triumphs over death. This divine Transformation (13), raises him beyond the tomb into the serene region of infinite progress and opposes the reality of Initiative (14), to the eternal falsehood of Fatality (15). The course of time is marked by Ruins (16), but beyond every ruin one sees reappear the dawn of Hope (17), or the twilight of Deception (18).

"Unceasingly, man aspires to that which ever flees from him, and the Sun of Happiness (19), will only rise for him beyond the Tomb (20), after the renewal of his being by death, which opens to him a higher sphere of Will, Intelligence and Action.

“Every will that lets itself be governed by the instincts of the flesh abdicates its liberty and is bound to the Expiation (22), of its errors. On the contrary, every will which unites itself to Deity in order to manifest truth and work justice, enters even in this life, into a participation of divine power over beings and things, Recompence (21), eternal of Freed Spirits (0).”

I not only earnestly recommend to all students that they commit the above summary of the Major Arcana to memory and meditate upon it frequently, but that they use it as a mantram. It contains vastly more of truth and power than appears upon the surface, and used as a mantram has been singularly potent in establishing self-confidence and in building up positiveness and constructive power of will.

The Relation of Minor Arcana to Major Arcana

—As previously indicated, the suit of Scepters, which in common playing cards is the suit of Clubs, symbolizes the element fire. This in human life becomes enthusiasm, ambition and enterprise. Consequently, this suit belongs to the department of life having to do with business, occupation, station, honor and profession. In astrology, it is represented by the M.C., where the sun appears at noon.

The suit of Cups, which in common playing cards becomes the suit of Hearts, represents the element water, symbol of the emotions and typical of domestic and affectional relations. It thus broadly corresponds to the western angle of a birth-chart, where the sun sinks below the horizon.

The suit of Swords, which in common playing cards becomes the suit of Spades, represents the element earth, symbol of struggle, allied to affliction and death. It thus corresponds to the Nadir, where the sun is in its grave, or lowest point in the diurnal cycle.

The suit of Coins, which in common playing cards becomes the suit of Diamonds, represents the element air, the breath of life. Air is merely one form of food, although the most essential of all. The other foods may be purchased with money, and thus money has become the symbol of life itself. It therefore corresponds to the Ascendant of a birth-chart, where the new-born sun each day rises above the eastern horizon.

The Aces

—In astrology, Mercury is general significator of study, writing, correspondence and travel. As the Aces correspond numerically to Mercury, in their more common divinatory significance they relate to one of these things, according to the particular department of life signified by the suit. But in their application to higher planes, they reveal the influence of, and can be interpreted by, the first decanate of each zodiacal triplicity, starting, of course, with the movable signs.

The divinatory significance of the Ace of Scepters is news of a business opportunity; its inner interpretation is ACTIVITY.

The divinatory significance of the Ace of Cups is a letter from a loved one; its inner interpretation is MOODS.

The divinatory significance of the Ace of Coins is a short journey; its inner significance is POLICY.

The divinatory significance of the Ace of Swords is news of sickness or death; its inner interpretation is ORGANIZATION.

Veiled Isis—Arcanum II

—Letter: Egyptian, Beinthin; Hebrew, Beth; English, B. Number 2. Astrologically, the zodiacal sign Virgo. Color, the darker shades of violet. Tone, low B. Occult science, the doctrine of signatures. Human function, clairvoyance. Natural remedy, such herbs as barley, oats, rye, wheat, privet, succory, skullcap, woodbine, valerian, millet and endive. Mineral, the talismanic gem Jasper, and among stones the flints.

B—2 expresses in the spiritual world, the consciousness of Absolute Being, which embraces the three terms of all manifestation; the past, the present, and the future.

In the intellectual world, the binary, reflection of unity; and the perception of things visible and invisible.

In the physical world, woman the mold of man, uniting herself with him in order to accomplish an equal destiny.

Remember, then, son of earth, that the mind is enlightened in seeking God with the eyes of the will. God has said, "Let there be Light," and light inundated space. Man should say, "Let truth show itself and good come to me." And if man possesses a healthy will, he will see the truth shine, and guided by it will attain all to which he aspires. If Veiled Isis should appear in the prophetic signs of thy horoscope, strike resolutely at the door of the future and it will open to you; but study for a long time the door you should enter. Turn your face toward the sun of justice, and the knowledge of the true will be given you. Keep silent in regard to your intentions, so as not to be influenced by the contradictions of men.

In Divination, **Arcanum II** may briefly be read as **Science**.

Arcanum II is figured by a woman seated at the threshold of the Temple of Isis. She is seated between two columns, the one on her right being red to signify pure spirit and its luminous ascension over matter, and the one on her left being black to represent the bondage of matter over the impure.

The woman is crowned by a tiara of three stories surmounted by a lunar crescent. From the tiara a veil falls over her face. She wears upon her bosom the symbol of the planet Mercury, and carries upon her knees an open book which she half covers with her mantle. This symbolic ensemble personifies occult science, which awaits the

initiate at the threshold of the sanctuary of Isis in order to tell him the secrets of universal nature. The symbol of Mercury (Hermes) upon the bosom of the Virgin, signifies that matter is fecundated by spirit in order to evolve mind, or soul. The cross below is matter, the circle is spirit. Together they figure the lingam of the Hindus, representing the union of the sexes; and the crescent above the union of spirit and matter represents the soul which is the evolved product of their union.

The seal on the breast of Nature also expresses the thought that knowledge comes from God and is as limitless as its source. The veil falling over the face announces that Nature reveals her truths only to the pure in heart, and hides them from the curious and profane. The book half hidden under the mantle signifies that but half of the truth can be discerned by the physical senses, the exoteric side. The esoteric, or other half, must be apprehended through the application of the psychic senses. Reason, divorced from intuition, can discern only in the realm of effects; but re-wed to intuition, can remove the obscuring mantle from Nature's most secret page and pursue her mysteries at leisure.

These mysteries are revealed only in solitude, to the sage who meditates in silence in the full and calm possession of himself. The tiara represents the power of the intellect to penetrate the three realms of existence—physical, astral and spiritual—which are signified by its stories. The lunar crescent, symbolizing the feminine attribute, is above the tiara to indicate that in occult science the intellect should be guided by the intuitional, or psychic powers. That is to say, in the occult sciences the feminine qualities of the mind are often of superior value to the masculine, or rational. The woman is seated to show that Will united to Science is Immovable.

Number

—Numerically, 2 expresses polarity. It suggests night and day, inhalation and exhalation, heat and cold. In fact, the most evident thing in existence is duality, truth itself being dual, esoteric and exoteric, the truth of the real and the truth of appearances.

Astrology

—Veiled Isis is none other than the immaculate Virgin who becomes a mother through union with the Holy Spirit. She sits in the doorway of the temple of Nature, veiling the knowledge that can only be gained through union, as depicted in Arcanum III. Arcanum II represents science. This is the harvest of experiences which have become assimilated as knowledge. Virgo is a scientific zodiacal sign, and it rules both the harvest and the processes of assimilation.

Human Function

—Mind implies perception, and chief among the perceptive faculties is the sense of sight. Both the mind and sight are ruled by the planet Mercury, and Mercury also rules two zodiacal signs. When the sun is shining physical sight becomes available, but in the darkness of night the inner sight may be more effective. And as the night sign of Mercury is Virgo, it indicates that both this sign and Arcanum II correspond to the inner sense of sight, to clairvoyance.

Alchemy

—Alchemically, Arcanum II is the universal solvent which, when properly used, can be made to reduce any metal to its first matter. Raymond Lully says in regard to this:

Metals can not be transmuted...in the minerals, unless they be reduced into their first matter...Therefore I counsel you, O my friends, that you do not work but about Sol and Luna, reducing them into their first matter, our Sulphur and Argent Vive.

This means, in plain English, that in smelting ores the lowest melting point is obtained by mixing them so that the amount of acid is exactly equal to the amount of alkali; and that in fluxing experiences, when the polar opposites are exactly equal their vibratory rate is raised to a point in which transmutation is more readily accomplished.

Bible

—The most notable mention of Arcanum II in the Bible is the story of the Virgin Mary.

Many nations of antiquity were familiar with the tradition of the immaculate conception; and the Christian account was borrowed directly from Egypt, where the Jews at one time were held captive and became familiar with traditional lore. For thousands of years in Egypt it was taught that Isis, conceiving immaculately, gave birth to Horus, the Sun God. The Egyptian Virgin is often depicted with a New Moon in her arms, instead of the baby Jesus, which was substituted when Isis became an object of Christian adoration.

The inner meaning of the immaculate conception is that matter, or the feminine principle in nature, is impregnated by spirit, or the positive principle. The gestation which follows is evolution, which finally results in the birth of man, who possesses an immortal soul and the potentiality of becoming a god.

Masonry

—The F. C. degree of Masonry is founded upon Arcanum II. The two Masonic pillars, Jachin and Boaz, are prominently pictured at the entrance to Solomon's Temple.

Magic

—In magic, Arcanum II depicts the principle of reception, which is the polar opposite of the principle indicated in Arcanum I. It is the feminine reaction of the magical agent, and teaches us the androgyne nature of the astral light.

It is further exemplified in the production of physical phenomena by mental means; for in order thus to move physical objects—a process now recognized by university scientists as the PK (Psychokinetic) Effect—there must be organic electromagnetism present of sufficient volume to make the contact and do the work. Organic electromagnetism tends to take whatever form, and to do whatever work, it is directed to do by the mental energy associated with it.

The ectoplasm of a materializing medium is an impressive example of this. The electromagnetism present is employed by the directing intelligence to convert some of the material of the medium's body temporarily into a plastic fluid outside the medium's form. This plastic substance can then be molded into whatever image the directing intelligence holds in mind. Electromagnetism is the magical agent which forms the connecting link between mind and matter. And it must always be present in sufficient volume whenever material conditions are affected by the action of mind.

Initiation

—In the pilgrimage of the soul Arcanum II represents a definite point in both the descending and the ascending arc of the cycle. In involution it represents the differentiation of the twin souls of one ego into opposite polarities. This takes place in the paradisiacal realm (highest spiritual state), just preceding their fall, as Adam and Eve, into material conditions.

In the upward cycle it signifies that point in initiation where it is realized that man or woman alone are not complete, but require another soul of opposite sex; and that reason alone is not sufficient with the aid of the physical senses to solve the problems of life, but that intuition and the psychic senses must be developed before adeptship is reached.

Occult Science

—Astrological Signatures is the science of the correspondences between celestial influences and other things. The soul of each life-form had a point of differentiation from which it departed on its cyclic journey, and this point of departure is within the spiritual vortex of one of the seven planetary families. Thus the soul of any living thing responds more strongly to the vibrations of one particular planet, which is its ruler. And even things possessing no life, such as environments, also transmit the influence of one planet or zodiacal sign stronger than they transmit that of others, and thus the planet or zodiacal sign becomes their signature.

The Deuces

—The sign Virgo is general significator of science and labor, therefore the Deuces, corresponding numerically to Virgo, in their more common divinatory significance must relate to these things as applied to the department of life indicated by the suit. But in their higher application they reveal the influence of, and can be interpreted by, the second decanate of each zodiacal triplicity, starting with the pioneer, or movable, signs.

The divinatory significance of the Deuce of Scepters is a business depending upon scientific methods; its inner interpretation is EXALTATION.

The divinatory significance of the Deuce of Cups is a work of love; its inner interpretation is REVELATION.

The divinatory significance of the Deuce of Coins is money acquired by hard labor; its inner interpretation is INDEPENDENCE.

The divinatory significance of the Deuce of Swords is sickness through over-work; its inner interpretation is MARTYRDOM.

The Pyramid Spread

—In using the pyramid spread, the cards are first shuffled and cut, and this repeated three times, in the method employed for all the spreads.

Then they are dealt from the top of the deck, one by one, and laid face downward from right to left in pyramid form as illustrated on page 40, 21 cards in all being thus dealt.

The spread may be used to answer a question, to solve a problem, or merely to give the general run of events as they may be expected in some person's life. But before shuffling, what is desired from them should be clearly formulated, and held in the mind until the spread has been completed.

Starting at the lower right hand corner, and counting to the left, every fifth card is a Key, and this key is counted as the first card in the next five, as shown in the illustration. When a Major Arcanum falls upon one of the keys, it makes this key particularly important.

To read, first turn over, from top to bottom, key I, which shows the present. The four cards to the right indicate the past, the one farthest to the right as the more distant past, and the cards nearer the key as more closely approaching the present.

Then key II represents the next turn in the wheel of circumstances, and the cards between key I and key II represent the factors leading up to it.

Key III is read as the next circumstance of importance following this, and the cards between as the lesser factors; key IV is still further in the future; and key V, which crowns the pyramid, shows the ultimate of the thing, or the distant future.

Chapter 4

Serial No.24
Original Copyright 1936
Elbert Benjamine

Copyright
Church of Light
August 2002

Involution & Evolution of Numbers

Spread of The Sephiroth

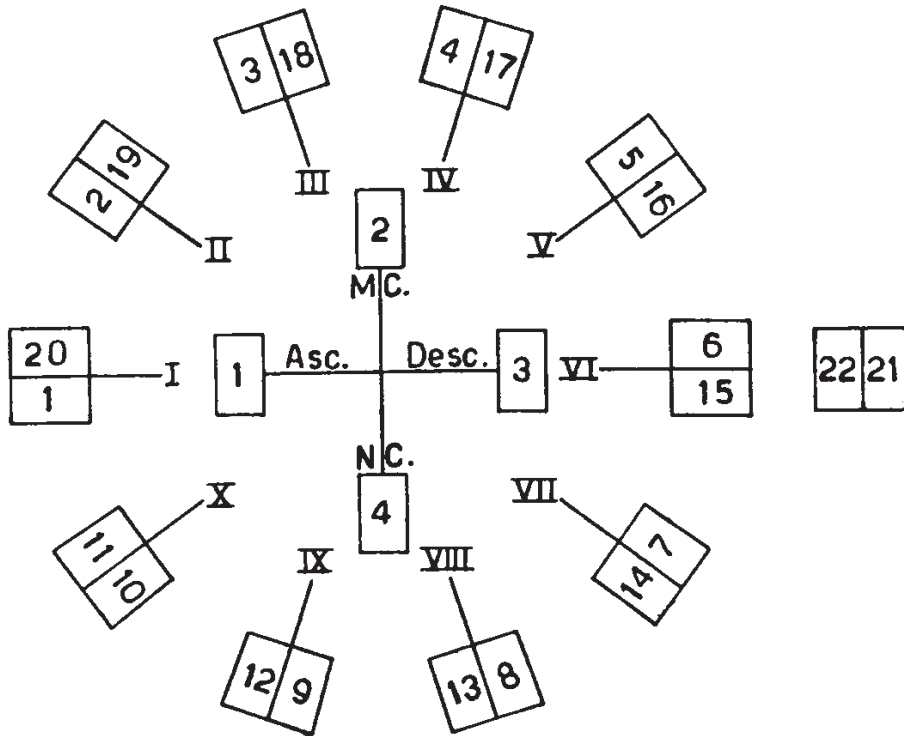

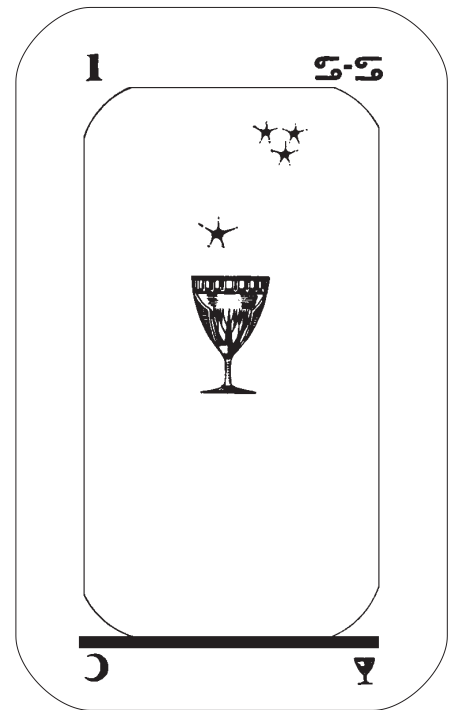
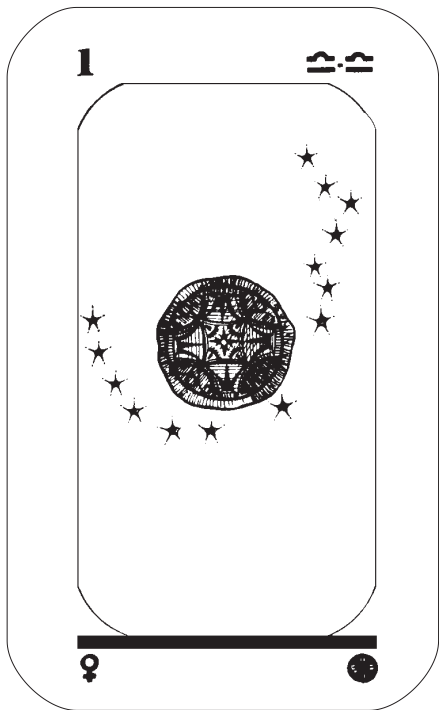
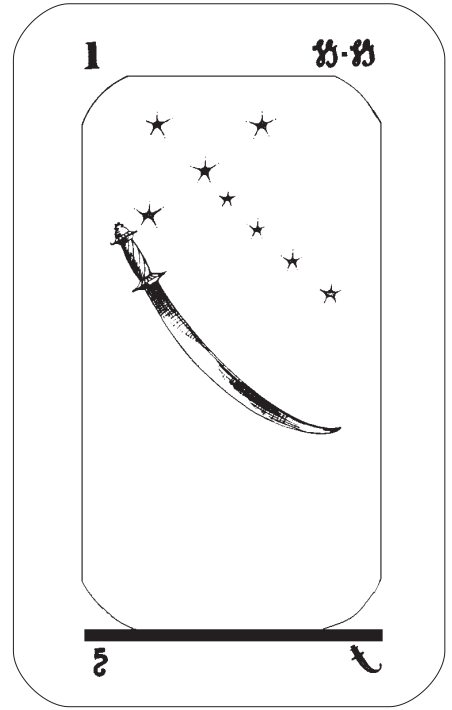
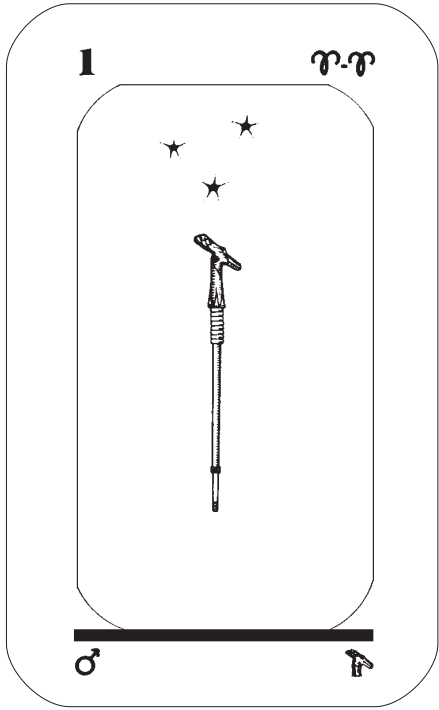

Chapter 4

Involution and Evolution of Numbers



ACCORDING to Hermetic Science there are 10 planets in the chain. But because it is a chain, the tenth planet (Pluto) not only closes the previous sphere of influence, but also commences a new gamut. That is, Pluto is a repetition, on a higher scale of existence, of the same influence as that exerted by the Moon; but in addition to being a higher expression of the influence of the Moon it serves an additional function as an influence of transition to an entirely new phase of existence. Neglecting this cycle-closing function represented by Pluto, there are 9 root planets.

These 9 root planets, however, express themselves also by virtue of overtone qualities, in keys that are denoted by the 12 zodiacal signs, in addition to the transition function of Pluto. Thus the principle expressed by Mars, expresses also in a distinctive manner through two other key influences, the sign Aries and the sign Scorpio; and the principle expressed by the Sun expresses in another key influence, through the sign Leo. But the number of such key influences is not unlimited, as shown by the fact that all things which we are able to discern can readily be correlated to one of 22 distinctive keys. That is, everything we contact corresponds to one of the ten planets or twelve Zodiacal signs. This we can prove by observing how a thing is influenced by astrological forces.

The system of numbers in common use is likewise based upon ten fundamental principles, the tenth influence closing the cycle, and starting a new gamut of existence. The 0 shows the completion of the cycle, or circle, and the 1 indicates that the first influence has been carried to a new plane, or phase of being. Thus either with planetary influences or with numbers, we work with 10 separate characters, but there are only 9 root influences.

Any number above 9 is merely one of the root numbers, to which 9 has been added a given number of times. This adding multiples of 9 to some number is called Theosophical Evolution, not because it derives from any particular group of people, but because Theosophy means Divine Wisdom, and because in its particular function, the number 9 is the key to Divine Wisdom in so far as numbers and cycles are concerned.

Due to this peculiar function of the number 9, when a number higher than 9 is given, instead of dividing it by 9 repeatedly until a remainder less than 10 results and thus obtaining its root, the same result may be obtained merely by repeatedly adding the digits of the number until there is but a single digit. That is, the adding of the digits is but a short-cut method of dividing the number by 9. Because this use of the key of Divine Wisdom, 9, to find the root of the number, is the reverse of Theosophical Evolution, it is called Theosophical Involution.

Dealing thus with numbers, we are considering mere abstractions. But when man thinks of a number, a name, or anything else, his thought is not an abstraction, but a definite astral vibration radiating outward. The astral counterparts of objects also radiate definite astral vibrations. And astral vibrations, as well as physical vibrations, and those electromagnetic vibrations known as light and radiant heat, have an influence upon the things they contact.

The tones of musical instruments are other vibrations with which we are even more familiar, and which have many parallels to the astral vibrations of thought. For even as a musical composition has a key, so every train of thought has its key, and influences its surroundings according to this key vibration. And each simple thought is a definite vibratory rate of astral substance, just as each musical tone is a definite vibratory rate of physical substance.

Now with physical tones, if the vibration is increased to a certain degree, the same sound repeats itself on a higher level. Raising the vibration still more causes the tone to be produced on each of many higher levels. We commonly call each of these higher levels an octave expression of the tone, because it was customary to use the diatonic scale in which the interval between one tone level and the next was divided into seven divisions, so that the eighth (octave meaning eight) repeated the tone on a higher level.

In the chromatic scale, however, the interval is divided into twelve tones, illustrated by the 7 white keys and the 5 black keys of a piano, the 13th expressing the octave. The Chinese have a reed instrument in which the interval is divided into 5 equal parts, certain Indians use a scale of 6 equal parts, the Siamese use a tone scale of 9, and certain Moravians use a scale of 24. Thus it will be seen that the interval between a tone on one level and the same tone (commonly referred to as an octave) on another level is variously divided by different people.

Now a thought has a vibratory quality very similar to a tone, except that it expresses in high-velocity substance, that is, in astral substance, and a thought can be sounded on different levels, just as a tone can thus be sounded. But it has been found convenient, and more in conformity to natural principles, to divide the interval between one thought-tone level and the next, not into 7, but into 9 divisions, so that the 10th shall express the same tone on the next higher level. Therefore, instead of calling the interval between a fundamental thought and its expressions on the next

higher level an octave, we call it a decave (decave meaning ten). The word DECAVE has been coined, and will hereafter be used, to express the vibratory levels of thought and astral substance.

In the notation, analysis, and charting of thoughts as vibratory tones, therefore, we have 9 root tones. But even as in music overtones play an important part both in composition and in the effect produced, so with thought-tones, there are peculiar overtone effects that make it necessary to employ not merely 9 fundamental characters to express accurately all thought-effects; but to consider as distinct factors certain dominant overtone effects that observation shows to occur in the levels just above the 9 root tones. Thus to chart a train of thoughts it may be necessary to employ as many as 22 different characters.

When the string of a musical instrument is sounded the string not merely vibrates as a whole, giving rise to the tone, but it also divides itself into two equal segments, each of which tends to give forth a sound; into three equal segments, each of which tends to give forth another tone; into four equal segments, each of which tends to give forth still another tone, and so on. These tones produced by the smaller string divisions are called overtones, and are utilized in musical composition.

Certain musical instruments encourage certain overtones and discourage others, and thought-vibrations, likewise, produce specific overtone effects.

But because thought-tones are vibratory rates in high-velocity substance, we cannot follow the comparison with physical vibrations into too great detail. University scientists, through innumerable experiments conducted under strict test conditions, have demonstrated conclusively that on the inner plane, distance and gravitation each are of a different order than they are on the outer plane. And astrology indicates that inner-plane weather affects the individual, not merely according to his inner-plane constitution, but through certain time-space relationships. Astrological energies, in their various combinations, constitute the inner-plane weather.

There are inner-plane weather conditions that affect groups, cities, nations and world affairs, and through these influence each individual in the group, city, nation or world. But the chief weather conditions affecting an individual are restricted to him. In addition to the more general astrological weather conditions, each has his own individual inner-plane weather. Such personal weather is mapped by major progressions, minor progressions and transit progressions.

Also it has been found that with a thought-vibration the overtone quality is dominant from tone 1 up to tone 22, and not only any one of the 9 root-tones, but any one of the 22 types of thought-vibration, can express its individuality on a higher vibratory level or DECAVE.

Thus, in considering not merely thought-vibrations, but character-vibrations and astrological-vibrations, because these are all inner-plane vibrations, we can not confine ourselves merely to 9 root tones, but, due to the peculiar overtone properties of astral vibratory rates, we must give full tone value to 22 different qualities, which we shall, for convenience, call KEYS.

Every thought, every train of thought, every individual, every influence from the firmament and every force in nature, therefore, because its astral nature is thus tuned, vibrates to one of these 22 Keys.

And because each of the 22 key-tones may sound on various higher vibratory levels, or Decaves, in order to find the key to which the thought of a number, for instance, vibrates, it is necessary to reduce or involve it, by subtracting multiples of 9.

To thus apply the number of Divine Wisdom properly to obtain the Key of the number, the digits of the number are added together, and the digits of the number so obtained are added together again, and so on, until a number is obtained which is less than 23. This number is the Key of the number considered.

Thus to find the Key, or vibratory thought-rate, of the number 1932 we simply add 1 plus 9 plus 3 plus 2, which gives 15 as its thought-tone quality.

Now the Key itself is the first Decave of a number. The second decave is obtained by adding 9. In this case the second decave is 15 plus 9 which equals 24. The third decave of a number is obtained by adding two times 9, in this case giving 33. But due to the peculiar overtone properties of astral vibratory rates, the Key of 24 and 33 is not 15, but 6. Yet when we add six times 9 to 15 we get 69, the Key of which is 15, because in this number the overtone effect again becomes dominant.

From the above it will be seen that the way to find the decave in which the key is sounded is to subtract the key from the number and divide by 9; and then because the key itself is the first decave, to add 1 to the number thus found.

Thus 1932 minus 15 gives 1917. 1917 divided by 9 gives 213. That is, 9 has been added to 15 just 213 times to get 1932. But as 15 itself is the first decave, to get the number of the decave we must add 1 to 213, which gives us 214. This means that the thought-vibration is 15 sounded on the 214th vibratory level.

Now if we desire to get the Key of the Decave, which we use only for divinatory purposes, we merely add 2 plus 1 plus 4, which gives 7.

15 itself has a root, obtained through adding its digits—1 plus 5 gives 6 as the root. But from a vibratory-tone standpoint the Key is the important thing.

The ROOT is a number below 10.

The KEY may be any number below 23.

The DECAVE is the number of times 9 has been added to the Key plus 1, this 1 being the first Decave, which is occupied by the Key.

The Key of the Decave is found by using the Decave as a number and finding its key in the ordinary way.

When, therefore, we add the digits of a number together, let us not believe this is some arbitrary method of finding its significance; but understand that we are proceeding according to correct mathematical principles to find what number, as a Key number, has been raised to a higher level by adding to it multiples of 9.

And when we find the Decave of the number let us bear in mind that the number itself is on the first decave, and that to it has been added 9 a certain number of times. The number thus expresses a certain decave of a Key number, just as a musical tone sounded on a higher octave expresses itself as a tone which has been raised by multiples of 7.

Isis Unveiled—Arcanum III

—Letter: Egyptian, Gomer; Hebrew, Gimel; English, G. Number, 3. Astrologically the zodiacal sign Libra. Color, the lighter shades of yellow. Tone, high E. Occult science, spiritual alchemy. Human function, the sense of feeling. Natural remedy, such herbs as white rose, strawberry, violet, water-cress, primrose, heartsease, balm, pansy and lemon-thyme. Mineral, the talismanic gem, diamond; and such stones as white quartz, white spar and white marble.

G—3, expresses in the spiritual world, supreme power balanced by eternally active intelligence and absolute wisdom.

In the intellectual world, the universal fecundity of being.

In the physical world, nature in labor, the germination of acts, which must hatch from the will.

Remember, then, son of earth, that to affirm what is true and will what is just, is already to create it; to affirm and will the contrary is to vow oneself to destruction. If Arcanum III should appear in the prophetic signs of thy horoscope, hope for success in thy enterprises provided thou knowest how to unite the activity which fecundates, to that rectitude of mind which will make thy works bear fruit.

In Divination, **Arcanum III** may be read briefly as **Marriage** or **Action**.

Arcanum III is figured by a woman seated within a radiant sun. The rays from this sun number thirty, the number of degrees in one zodiacal sign. The woman is crowned with twelve stars, to represent the twelve signs through which the sun passes each year. Her feet rest upon the moon, symbol of the feminine in nature. And the cube upon which she sits represents the cross of matter, where rays of sun and moon meet, and so signifies the union of male and female forces.

From her brow the sacred serpent thrusts its head as a symbol of enlightenment. In her right hand she carries a scepter surmounted by a globe. This is essentially a phallus, and indicates the perpetual action of creative energy upon all things born or

to be born. In her left hand she carries an eagle, the symbol of fruitfulness and of the heights to which the flights of the spirit can raise itself through the emotions engendered in union. The seat upon which she rests is covered with eyes, indicating that through union the eyes of the soul have been opened to a knowledge of good and evil.

This ensemble pictures, in terms of universal symbolism, generation, gestation, and universal fecundity.

Number

—Numerically, 3 expresses the union of polar opposites, the relation between such forces as cause vibration and change. It thus represents the universal agent, action, or word, and is typical of fecundity. It is the union of forces of different polarity that is back of all action, all life and all intelligence.

As applied to human evolution it represents the ego joined to the body by the soul. The soul develops and makes progress because the ego is polarized to positive spirit and the body is polarized to negative matter. The interaction between these two generates the force that impells the soul forward in its journey.

On the physical plane, 3 represents man and woman in marriage. In science it stands for the dynamic laws; for the laws that govern the production and directing of energy. It is because of difference in polarity that nothing is free from change, that all nature is in constant motion.

Astrology

—Having been tempted by the serpent of desire for material experience, the desire for offspring—astrologically the fifth house, presided over by the sign Leo—Eve falls into union. This union is astrologically the union of summer and winter, which, with the conception resulting, is represented by the natural ruler of all partnerships, the zodiacal sign Libra.

Arcanum III not merely pictures the union, but also the resulting enlightenment; for Adam and Eve after union discerned they needed clothing, and the serpent of desire, through desire's fulfillment, became the serpent of wisdom. This serpent, symbol of creative energy released by desire, is shown raised to the brow to indicate the power that union possesses to increase the range of mental activity.

Isis Unveiled should be distinguished from the second decave of 3, which is Arcanum XII and the sign Pisces; for this pictures negative union resulting in wasted vitality. Also from the third decave of 3, which is Arcanum XXI, ruled by the Sun, which reveals the use of union in making the highest spiritual attainment.

Human Function

—Union is prompted by feeling. Also, the contact with objects which gives rise to feeling is a form of union. Thus the human function known as the sense of feeling quite naturally attaches itself to the arcanum which represents union.

Alchemy

—Arcanum III represents the union of the various ingredients. Not only must all the proper ingredients be present before transmutation is possible, but they must enter into union. The reverberatory furnace imparts some energy to them, but not enough to complete the transmutation process. It is not, therefore, merely a matter of assembling suitable metals in proper proportions. But they must be joined in such a manner as mutually to increase their vibratory rates; adding the energy they thus mutually generate to the process. Physical proximity is not sufficient for this purpose. They must be intimately joined in their essential qualities.

Bible

—The fall of Eve and the consequent expulsion of the human race from the Garden of Eden is pictured by Arcanum III.

The ark of Noah is another reference to the same arcanum. Its three stories correspond to the three realms of the arcanum which are represented by the Sun, typical of spirit, the Moon, typical of the astral, and the cube, typical of the physical world. The cube, or physical world, or square cabin of the ark, is where the soul undergoes its period of gestation.

Masonry

—The Master Mason degree is based upon Arcanum III; and the meaning of the whole story of the assassination, the burial, the finding and the raising of Hiram Abiff is made plain by comparing it with the pictured symbols of this arcanum. It thus, in reality, is the key to the Master's Word which was lost at that time.

The G of Masonry, found traced upon the breast of the murdered Hiram, is the letter of this arcanum. High twelve, the time the master was attacked, is represented by the noon-day position of the Sun. Low twelve, the time he was buried, is indicated by the position of the moon at the nadir.

The grave, which is six feet due east and west, and six feet perpendicular, is represented by the six-sided cube upon which Isis sits. The sprig of cassia marking the grave is presented in the tarot as a phallic scepter. The twelve Masons sent out to hunt for Hiram Abiff are symbolized by the twelve stars above the head of Isis. The five points of fellowship upon which Hiram was raised by means of the Lion's paw

grip are indicated by the five eyes traced upon the cube; and the final transcendent result of so being raised is pictured by the eagle on the left hand of Isis.

Magic

—In Magic, Arcanum III reveals the principle of vitalization. This principle springs into existence as the result of that polarity represented in Arcanum II. That is, it is the vibratory effect of the interaction of polar opposites.

One of the first things we learn in the study of physics is that every action is accompanied by an opposite and equal reaction. Therefore, for every positive force in the universe there must be an exactly similar force of negative attributes.

It is impossible, for instance, to make a magnet possessing only a positive pole. For by the most fundamental law of nature, when a positive force of any kind is brought into existence it must be accompanied by an equal, but negative force. This is the principle upon which rests that great law of physics called the conservation of energy. For if one member of this duality were to be absent, and the energy spent in one direction were not always accounted for by an equivalent reaction, it would be possible not merely to transform energy, but to create new energies, or actually to lose energy already in existence. That such creation and such loss never take place constitutes the well known law of the conservation of energy.

The law of the conservation of energy does not apply merely to one plane of existence, but to all planes and states. Consequently, for every soul of positive, or male, polarity, which comes into existence through differentiation, there simultaneously springs into existence another soul of negative, or female, polarity. A soul is a definite force, and it has polarity, and it is as impossible to conceive of a male soul being launched upon the tide of involution and evolution without a similar female soul also being launched at the same time, as it is to conceive of a magnet with only one pole. Furthermore, because action and reaction are exactly equivalent, the female soul must be the exact replica of the male soul, except in the matter of sex, or polarity.

Other than sex, the only possible difference between souls which thus have been differentiated at the same time is due to the diversity of experiences which they have had since differentiation. Ultimately they are both born upon the earth, and sometimes they even meet in physical life as man and woman. But whether they meet upon earth, or in some higher state of existence, by virtue of their simultaneous differentiations and being originally exact counterparts, they are true soul-mates.

The ability of soul-mates spiritually to vitalize each other, although this may not be acquired until planes far above earth are reached, makes their joint immortality possible. But descending from such recondite considerations, in reality there is no action, no life and no consciousness that is not traceable to sex.

Chemical affinity, for instance, is due to the marriage of atoms. They are impelled to divorce less compatible partners and enter into union with those which have a greater attraction for them. And we use the power generated in such marriages to drive locomotives and to carry us about the country in automobiles.

Electricity and magnetism are due to positive energies endeavoring to unite with negative energies; and analysis could show that every force in the universe which has come under observation is the result of some similar sexual attraction.

Breathing, likewise, is dual, inhalation and exhalation, positive and negative. And in the process, in addition to the oxygenation of the blood, electromagnetic energies are picked up and lend their power to nerve, brain and electromagnetic body.

Initiation

—In the soul's pilgrimage Arcanum III represents its descent into material conditions and then, having climbed the ascending arc of the cycle to the human state, finding a suitable companion to assist in developing the spiritual attributes. Spirituality implies an exalted emotional development.

Occult Science

—Spiritual alchemy is the science which uses each and every event of life as a means of creating spiritual values. They are purified by separating the external appearance from their real significance, and fluxed in proper combination. Should some ingredients be lacking to perfect the transmutation, these events are sought out and added to life's collection.

The Treys

—The sign Libra is the common significator of partnership, open enemies, lawsuits and dealing with the public; therefore the Treys, corresponding numerically to Libra, in their more common divinatory significance must relate to these things as applied to the department of life indicated by the suit. But in their higher application they reveal the influence of, and can be interpreted by, the third decanate of each zodiacal triplicity, starting with the active, or movable signs.

The divinatory significance of the Trey of Scepters is a business partnership; its inner interpretation is PROPAGANDA.

The divinatory significance of the Trey of Cups is a marriage for love; its inner interpretation is RESEARCH.

The divinatory significance of the Trey of Coins is a marriage for money; its inner interpretation is EXPIATION.

The divinatory significance of the Trey of Swords is a lawsuit or a divorce; its inner interpretation is IDEALISM.

The Sovereign—Arcanum IV

—Letter: Egyptian, Denain; Hebrew, Daleth; English, D. Number, 4. Astrologically, the sign Scorpio. Color, the darker shades of red. Tone, low C. Occult science, imponderable forces. Human function, the absorption of electromagnetic essences. Natural remedy, such herbs as heather, horehound, bramble, bean, leek, wormwood, woad, charlock and blackthorn. Mineral, the talismanic gem, Spanish topaz, and among stones, bloodstone, vermilion and lodestone.

D—4 expresses in the spiritual world, the realization, perpetual and hierarchic, of the virtualities, the efficacies, contained in Absolute Being.

In the intellectual world, the realization of the ideas of contingent being by the four-fold labors of the mind; affirmation, negation, discussion, and solution.

In the physical world, the realization of acts, directed by the knowledge of the truth, the love of justice, the force of the will, and the works of the organs.

Remember, then, son of earth, that nothing can resist a firm will which has for a lever the knowledge of the true and just. To combat in order to secure its realization is more than right; it is a duty. The man who triumphs in that struggle only accomplishes his earthly mission; he who succumbs in devoting himself to it, gains immortality. If the Sovereign should appear in the prophetic signs of thy horoscope, it signifies that the realization of thy hopes depends upon a being more powerful than thyself. Seek to know him and thou shalt have his support.

In Divination, **Arcanum IV** may be read as **Realization**.

Arcanum IV is figured by a man; on his head a sovereign's helmet. He is seated upon a cubic stone; his right hand raises a scepter surmounted by a circle, and his right leg bent, rests upon the other, forming with it a cross.

The cubic stone, image of the perfect solid, signifies labor which has reached completion. The cat, pictured on the side of the stone, indicates that the vision of the soul penetrates the illusions of matter.

The sovereign's helmet is an emblem of force conquered by power. The ruler is in possession of the scepter of Isis, indicating that he has knowledge of the spiritual use of the creative energies; and he points downward with his left hand to indicate that he uses these energies in the subjugation of the physical.

The sacred serpent at his brow indicates enlightenment; and the hawk, sacred to the sun, indicates his ambition to attain spiritual supremacy.

The cross, formed by his legs, symbolizes the four elemental kingdoms he has mastered, and the expansion of human power through understanding.

The apron above the legs, together with them, figures a trine above a cross; the symbol of mind dominating matter, and of the conservation of energy.

Number

—Numerically, 4 expresses the result of action, the fruit of the toil typified by 3. It is the realization from effort, and it is life springing into manifestation as the result of the union of polar opposites. It thus represents the practical, the concrete, and consequently that which has form.

It becomes, therefore, the type of the universal truth of reality, indicating that each realm is actual when viewed from its own plane. It is also the practical as applied to everyday affairs.

In the macrocosm it signifies the result of motion; in man it is the knowledge which comes through experience. In science it relates to all those laws which govern the effective use of energy; to those which govern what is produced by motion.

Astrology

The Sovereign by his helmet and his attitude of dominating through force, expresses martial energy; and the prominence of the phallic symbol relates him to the sex sign of Mars rather than to the head sign, Aries. Furthermore, the fruitfulness and silent type of strength are attributes of Scorpio.

Scorpio is the zodiacal sign of sex, the magnetic forces of which conserved as indicated in Arcanum IV become a most potent power to dominate the elemental realms of life. The negative aspect of this principle is indicated by the second decave of 4, Arcanum XIII, which pictures the natural course of events when the force is undirected, life and death in different types of forms following each other in rhythmic cycles.

The inversive and degenerative use of the same principle is pictured in Arcanum XXII, representing the third decave of 4. Here the T is represented with its point down; but the other side of Pluto's influence is the T with its point skyward; which is the highest aspect of sex, the transcendent powers arising from a union of soul-mates.

Human Function

—Magnetically, Scorpio is the most potent sign of the zodiac. Sex is back of all energy, and in man generates electromagnetic currents. Sexual vigor tunes the organism in on electromagnetic energies, which are all about us, and these give force to the personal magnetism, and vitalize the emotions and the procreative fluids. Scorpio, because of its rulership of sex, more readily than any other sign, is capable of receiving and transmitting these magnetic energies, and thus Arcanum IV, corresponding to Scorpio, is correlated to the faculty of electromagnetic absorption.

Alchemy

—When the ingredients are brought together their union generates a force, or heat. The energy, thus liberated through the fluxing of polar opposites, when properly controlled, is an essential factor in proper transmutation. The control of it, however, is not accomplished by suppressing, or confining it, but by directing it into proper channels. In fact, the directing of this energy into those channels which prevent it from causing an explosion, or burning the various ingredients, is one of the most important secrets of the alchemical art. Diverting it to the end desired corresponds to Arcanum IV.

Bible

—As Arcanum IV is the emblem of fruitfulness, there are numerous passages in the Bible which refer to it; for throughout, fruitfulness is considered a virtue and barrenness a crime. This applies more forcefully to the mental than to the physical plane; for when man is barren of thought his progress ceases and the body falls into decay.

Gen. 1:28. “And God blessed them, and God said unto them, Be fruitful and multiply, and replenish the earth, and subdue it; and have dominion over the fish of the sea, and the fowl of the air, and over every living thing that moveth upon the earth.”

Rev. 12:5. “And she brought forth a man child, who was to rule all nations with a rod of iron; and her child was caught up unto God and His throne.”

Thus is mentioned the fruitfulness of the sign Scorpio; its rulership, as belonging to Mars, of iron; the rod held in the hand of the Sovereign, its dominating character, and its possibilities of spiritual realization as symbolized by the hawk; for the child was caught up to the throne of God.

Masonry

—The Mark Master’s degree is founded upon Arcanum IV. As a whole the degree and the arcanum teach that, “To him that overcometh will I give to eat of the hidden manna, and I will give him a white stone, and in the stone a new name written, which no man knoweth, saving him that receiveth it.”

The sovereign of Arcanum IV sits upon such a stone, and the symbol of a new name is engraved upon it, and he represents one who has overcome. The hawk pictured on his breast is reputed, in legend, to fly to the sun. It therefore carries the same purport as the eight Masonic letters which are interpreted either, “Hiram Tyrian, Widow’s Son, Sent To King Solomon,” or, “He That Was Slain Soars To Kindred Spirit.” Thus does Arcanum IV depict the key-stone which the builders rejected.

Magic

—In Magic, Arcanum IV reveals the principle of realization. This implies the expectant attitude, and the preparation after the energy has been released to provide for that which is to be fulfilled. There must be confidence that the work is being properly performed, and that gestation will result in proper fruition. Worry, or anxiety as to results, is fatal to proper development of that which is desired.

Initiation

—In the soul's pilgrimage, Arcanum IV indicates the result of marriage after the state of manhood has been reached.

Both Christian monks and Hindu ascetics were under the impression that to be holy one must be miserable. But modern psychology proves indisputably that happiness leads to efficiency, and that misery tends toward disintegration without necessarily adding anything to the spirituality.

Of all the avenues to spiritual development, the affections are the most potent. The union prompted by lust and selfishness is one of the most destructive forces. Through the emotions we raise or lower our vibratory rates, and thus tend to elevate ourselves to a higher condition or lower and degrade ourselves.

The creative energies, in union, customarily arouse intense emotional states. If these emotional states are such as inspire tenderness, kindness and the desire to be helpful to others, they tend vigorously to build up the spirituality; for they cultivate a higher basic vibratory rate. But if they engender brutal thoughts and encourage grossness, through cultivating a lower basic vibratory rate, they destroy the spirituality.

Furthermore, there is no power which can lift the soul to such exalted states of ecstasy as can love, and thus only through love can we of earth contact the higher spiritual states.

Occult Science

—Imponderable forces is the science which deals with all the invisible energies not recognized by material science. In particular, it deals with the principles of ceremonial magic, in which there is a more or less definite ritual and often there is used specially prepared equipment such as wands, circles, seals, pentacles, inscriptions, etc.

The Fours

—The sign Scorpio is the general significator of fruitfulness, legacies, spirit communion, the dead, and the partner's money. Consequently, each of the fours, in its more common divinatory significance must relate to one of these things according to its suit. But in their higher application these cards reveal the influence of, and can be interpreted by, the fourth decanate of each zodiacal triplicity, starting the count with the movable signs.

The divinatory significance of the Four of Scepters is a legacy; its inner interpretation is **RULERSHIP**.

The divinatory significance of the Four of Cups is an increase in the family; its inner interpretation is **RESOURCEFULNESS**.

The divinatory significance of the Four of Coins is money received through a partner; its inner significance is **ORIGINALITY**.

The divinatory significance of the Four of Swords is remorse for past action; its inner interpretation is **DETERMINATION**.

Reversed Cards

—In all methods of reading the cards are dealt face downward; and they are turned over from top to bottom, one at a time, as read. This prevents the mind from wandering to other parts of the spread.

Any card right end up is considered slightly more fortunate than its common significance. It then becomes like a planet receiving a good aspect. Any card wrong end up is slightly more unfortunate than its common meaning. It then becomes like a planet receiving a bad aspect. But reversal never makes a good card bad, nor a bad card good. As Saturn and Mars are less evil when well aspected, and as Jupiter and Venus are more potent for good when well aspected, in the same manner any card is improved by being right end up.

Method of the Sephiroth

—In this method only the 22 Major Arcana and the 4 Aces are used. The Aces are shuffled separately. They are the most potent of all; for they represent the four astral kingdoms symbolized by their suits. They are called the Astral Keys, and outrank any of the other cards.

The 4 Aces after being shuffled and cut are then dealt as illustrated on page 60, the first on the kingdom marked Asc., the second on the M.C., the third on the Desc., and the fourth on the N.C.

Then the 22 Major Arcana are shuffled, cut, and dealt one at a time around the ten thrones, from I to X. This completed, the others are dealt back from throne X to throne I. This leaves two cards, which are placed face downward at the side. These are called the staff, and are only consulted when the figure proves contradictory. In such instances the staff indicates why there was failure to give a plain answer, and thus supports the devout student in his disappointment.

The first Astral Kingdom, marked Asc., is that of Life, and if the Ace of Coins falls there it shows strength, vigor and vitality; if the Ace of Scepters, it is favorable but denotes work and responsibility; if the Ace of Cups, that love of pleasure may deplete the vitality; and if the Ace of Swords, that there will be sickness or death.

The second Astral Kingdom, marked M.C., is that of Honor and Business. The Ace of Scepters falling there gives it great power; the Ace of Coins is favorable, but indicates much effort required; the honor is blemished through the pursuit of pleasure if the Ace of Cups falls there; and the Ace of Swords there presages failure.

The Astral Kingdom of Love is marked Desc. The Ace of Cups falling there indicates joy and happiness; the Ace of Swords there marks disputes; the Ace of Scepters there brings difficulties through difference in station; and the Ace of Coins signifies abundant strength.

The Astral Kingdom of Results is marked N.C. The Ace of Swords falling there indicates a favorable ending; the Ace of Cups there brings pleasant results; the Ace of Coins there is most unfortunate; and the Ace of Scepters there denotes a hard struggle which yields inadequate returns.

If the question relates to life begin with the Asc., if to love or war with the Desc., if to honor or business with the M.C., and if to secret things with the N.C.

First turn over, from top to bottom, the Ace, or astral key, of the question. Every question possible belongs to one of the four kingdoms, and the Ace indicating the general fortune of the matter is located as explained. After the significance of this Ace is noted, turn over the cards belonging to its thrones. You will note that the Asc. and Desc. have three thrones of two cards each, and that the M.C. and N.C. have but two thrones of two cards each. In considering the Asc. or Desc. the two cards on the center thrones, either I or VI, as the case may be, indicate the most important factors, and the other four cards signify modifying influences. The cards on the thrones of the question will indicate why the conditions signified by the Ace shown there exist and give some details.

Then turn over the opposite Ace, which indicates the opposition to the matter. The cards of its throne show the details of this opposition. Now if good cards occupy the kingdom and thrones of the question, and also the opposition to the question, it is most favorable. But if both the question and its opposition are held by evil cards, it is a bad omen. If the opposition holds more evil than the question holds good, the matter will fail after a struggle. If the question holds more evil than the opposition holds good, the matter lacks merit and will fail of its own accord. If the opposition is good enough, it will be carried to

success in spite of its unworth. If the good in the question is stronger than the opposition it will succeed in spite of opposition.

The kingdom next in order always indicates the culmination of the matter, and the thrones opposite within their kingdom its end. Thus in a question of love, war, marriage, etc., the Desc. becomes the question and the Asc. its opposition. The N.C. then becomes its progress, and the M.C. its end. In a question of business, however, the M.C. becomes the question and the N.C. its opposition, with the Desc. its progress and the Asc. its end. If the question concerns psychic matters or hidden things the N.C. becomes the question and the M.C. its opposition; with the Asc. its culmination and the Desc. its end.

And in all cases the cards on the thrones will indicate the various factors, indicating how and why. The four cards on the thrones of the M.C. or N.C. are of equal importance.

Chapter 5

Serial No.25
Original Copyright 1936
Elbert Benjamine

Copyright
Church of Light
August 2002

Reading the Meaning of Numbers

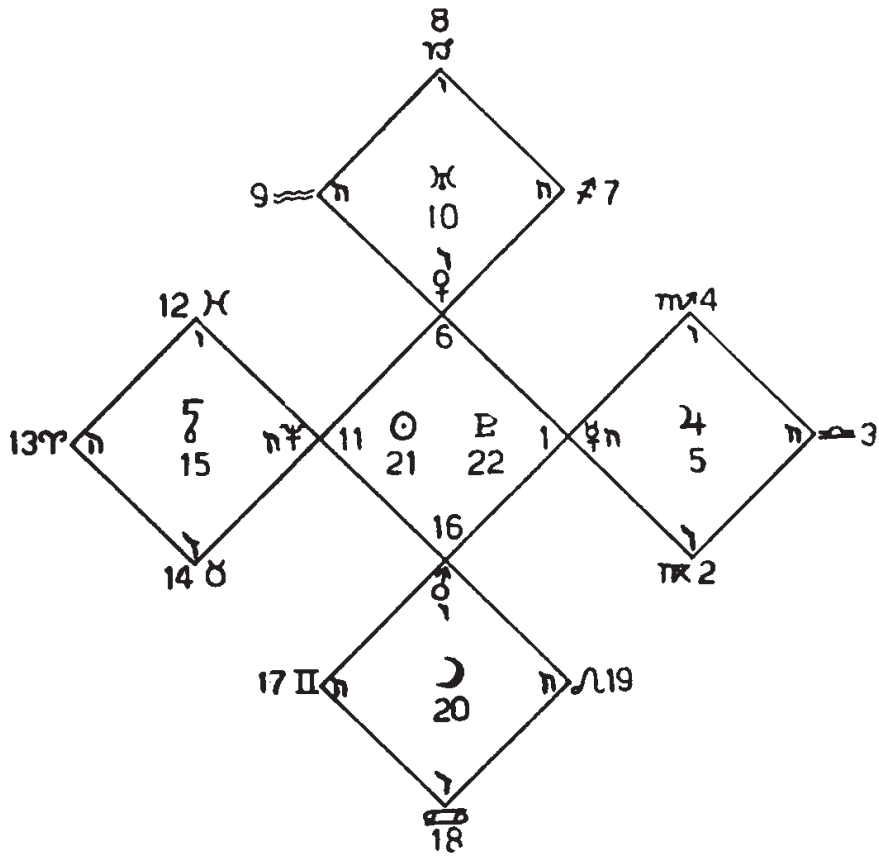

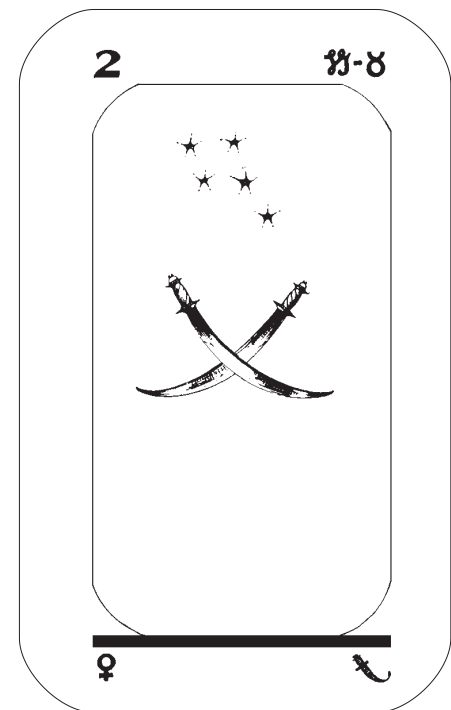
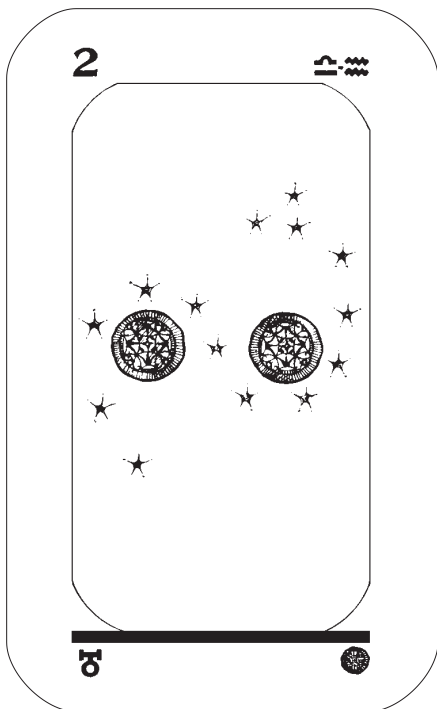
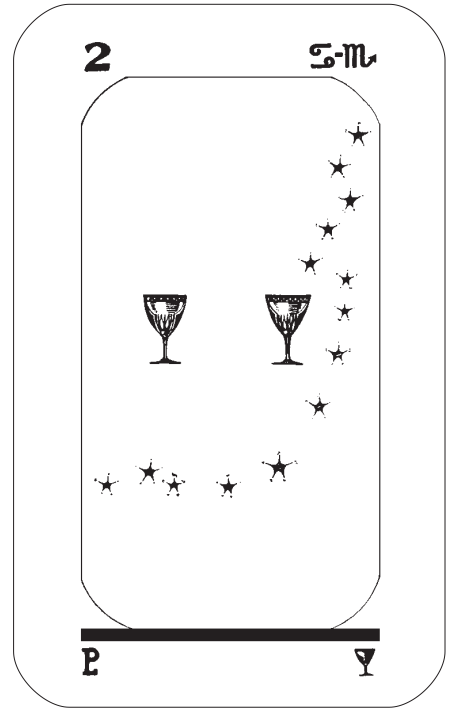
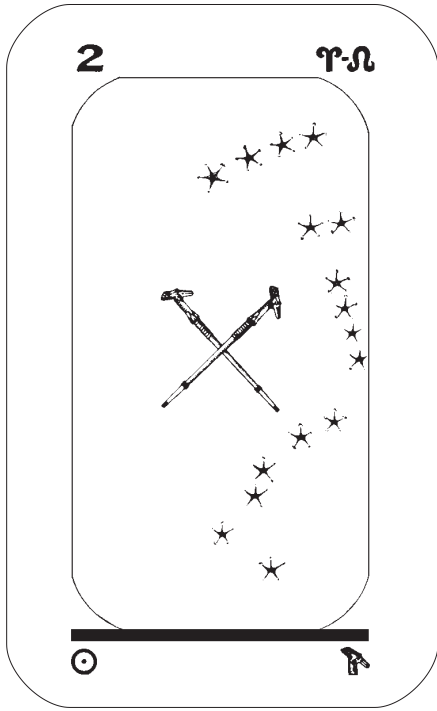

Chapter 5

Reading the Meaning of Numbers

BY MEANS of numbers we estimate the influence both of things and forces. The value of a material object, for instance, such as a house, is commonly expressed numerically in dollars and cents. The power of an engine is expressed numerically as so many horsepower. The speed of light is mentioned as so many thousand miles a second. And the pressure in an electric system as so many volts. In fact, the measure of quantity and quality would be very difficult to express except through the use of numbers.

When, therefore, we approach the study of the influence exerted by invisible energies, we quite naturally expect that they also should be expressed, in their power to cause changes, by means of numbers.

A vast amount of experimental and statistical evidence has been accumulated proving that man lives in, and is influenced by, two environments. And a vast amount of observation indicates that the inner-plane environment and its forces are as effective in determining his thoughts, emotions, behavior, health and the events which enter his life as are the outer-plane environment and its forces.

Man is influenced from the outer plane by what people say orally, over the radio, through the press and on the screen. And he is influenced from the inner plane by people's thoughts. He is influenced from the outer plane by objects. And he is influenced from the inner plane by the character vibrations of objects. He is influenced from the outer plane by the weather. And he is equally or more influenced from the inner plane by the astrological energies which constitute the inner-plane weather.

An individual ignorant of inner-plane energies is able to live up to only one-half his possibilities. Through knowledge of the inner-plane energies an individual who will apply such knowledge should be able to increase his spirituality, success, happiness and health 100 percent. Whatever his objectives may be, he stands a far greater chance of reaching them if he understands how the inner-plane environment influences his life, and how to take advantage of its energies.

As indicated, such energies may all be classified under these three categories:

1. Character-vibrations; which are the radiations of a thing or an intelligence due to its organization.
2. Thought-vibrations; which are the radiations of an intelligence due to thought processes.
3. Astrological-vibrations; which are the radiations from the heavenly bodies and the zodiacal signs.

The vibrations of physical substance within a certain range of frequencies give rise to tones or sounds. And electromagnetic vibrations within a certain range of frequencies give rise to colors. Likewise the range of frequencies of astral substance which has an influence upon human life gives rise to similar types of energy, producing effects comparable to physical tones or electromagnetic colors. Because we are more familiar with physical vibrations, it is convenient to refer to astral vibrations as tones.

There are thus astral tones arising from the signs and planets, astral tones arising from character radiations, and astral tones arising from thoughts. Tones may be isolated or in combination; and in either case there is often a dominant influence, or key. A character, for instance, is not just a single tone, but a combination of them. Yet there is usually a key note to the character. Likewise, a single thought radiates but a single astral tone. But a train of thoughts radiates a series of tones like a musical selection. Yet a musical composition commonly has a key tone. And a train of thoughts also has a key which can be determined from the nature of the thinking. In its influence the key tone is the most important vibratory rate.

We have all heard the story of how a building or a bridge can be demolished by a fiddler playing near it the tone to which it is keyed. And as already mentioned in chapter 2, the great Caruso, when he dined, would ask for a wine glass, tap it to find its tone, and have the waiter place it at the far side of the room. Then singing this tone in his powerful voice he would shatter the glass.

Now thoughts also have each a given tone quality. And just as Caruso's voice sounding a certain tone called forth that response in the tone of the wine glass, so a thought having the same tone as some particularly prominent vibratory center within ourselves, when it reaches us repeatedly, may set up a terrific vibratory intensity in that section of our astral body. That is, a specific thought reaching us from others, constantly being radiated to us by everyone who thinks about us, if it has the same tone as some section of our astral body, stimulates the thought-cells of that section of the astral body into unusual activity.

Of such thoughts sent to us regularly and with great frequency the name we use as signature may be the one from which we receive the greatest thought bombardment. However, the nickname by which our friends think of us, the given name by which relatives think of us, and the house number or telephone number which is used often by people while they visualize us, all have an influence. The amount of energy from each such name or number, of course, depends upon the frequency with which it is thought and the thought-power of those who thus think of us in such association.

Either a name or a number, as such, is merely an abstraction, and has no energy to do anything. But when a name or a number is thought, that thought is a definite energy radiated toward the one then thought about. As such it has also a specific vibratory key. Its influence, thus, is not to be measured by the sound produced in speaking; for the influence is quite as pronounced if it is only thought and not spoken. It is measured by the voltage, so to speak, of the thought; that is, by the energy supplied the thought by the thinker; and by the key to which it vibrates.

As to how much power to project their thoughts the various individuals who think our name have, and how often they think our name, we can only estimate in a very general manner. But as to the key to which any name or number vibrates we have a positive method of determination. Just as positive a method as we have of determining in which key a musical composition is written.

The Hebrew, Chaldean and Coptic square-formed letters served not merely as letters, but also as numbers. That is, there were no separate characters for numbers, each letter being a number. We thus have the numerical value of the letters of these ancient alphabets; that is, the vibratory quality ascribed to each by the early masters of occult science. And these values, as tested out today, prove correct.

And in tabulating the correspondence between the English alphabet and the ancient square-formed letters, the effort has been made, not merely to follow the precedent of translators of languages, but accurately to select the English equivalent in its thought-vibration quality of each of the ancient 22 letters. Thus we are able, by substituting the numerical vibratory equivalent of each English letter, to find the number which has the same astral vibratory rate as any name.

When the numerical equivalent of the name is thus found, the Key to which the name vibrates can be determined by finding the Key of the number. This Key is found by Theosophical Involution, as explained in chapter 4. That is, the digits of the number are added together, and this repeated, until a number results which is below 23. This gives the vibratory key of the number, and thus the vibratory key of the name.

By this method the vibratory rate of any name, whether it is associated with an individual or not, may be determined in a positive manner. And with this information at our disposal for determining the key of any name or any number, we have at hand a rather complete measure of all the astral forces that can have an influence over human life.

Character-vibrations are determined by finding the astrological signature. That is, the key to which a town, a person, a locality, an occupation, or what not, vibrates is made known when its astrological rulership is discovered. And astrologers have determined the rulership of most important things. In this connection, in subsequent lessons of this course, there will be some discussion of the influence of musical notes, of colors, of talismanic gems, and such things. The astrological vibrations, of course, are made known by astrological science. This leaves only the influence of thought-vibrations to be considered.

Thoughts are either abstract or concrete. Concrete thoughts are those that concern doing something, or which revolve about some definite object or action. We do not possess as yet any method of determining the tone of each separate thought in a thought-train. If we did we could chart any thought-train on a musical staff of 11 lines and 11 spaces. But we do possess a method of determining each separate tone in any name or any number; for each letter, or number, is one of 22 numbered thought-tones. Thus we can chart a number or name on such a staff as mentioned; the name C. C. Zain thus being charted on the frontispiece of Chapter 2 in Course 18, *Imponderable Forces*.

But the really important thing about a thought-train, or about a name or number, is the key to which it vibrates as a whole. This key to which a thought-train sounds can be determined by an analysis of it. Such analysis of a thought-train, or an emotion, reveals it to vibrate chiefly to the Domestic Urges (Key 20), to the Power Urges (Key 21), to the Safety Urges (Key 15), to the Intellectual Urges (Key 1), or to some of the other keys. From this the influence of the thought-train or emotion is made known. And in Course 9, *Mental Alchemy* the practical application of such knowledge is discussed in all its details.

Here, however, we are interested in abstract thoughts, such as names and numbers. The name FRED, for instance, when not associated in the mind with some particular person, is a mere abstraction. Yet when you, or anyone else, thinks the name FRED, there is radiated from the mind four thought-tones—17—20—5—4. No matter who thinks this name, the same thought-tones are radiated. And each of these four separate tones has a certain amount of influence.

But in thinking this name, or any other name, the various tones composing it are blended, just as the tones of a musical chord are blended, and the whole name as thought vibrates to a dominant key tone. And this key tone, the vibratory key of the name, has a far greater power than any tone embraced in it; in fact, it seems to have as much power as all the combined separate tones of the name.

Thus 17 plus 20 plus 5 plus 4 gives 46 as the number of the name FRED. Then as 46 is above 23, we add 4 plus 6 which gives us 10 as the astral vibratory Key of the name. No matter who thinks the word Fred, his thoughts send out a key-tone which vibrates to 10.

The meaning of this 10 tone, standing by itself, and unrelated to any individual, can be had by referring to the 10th Major Arcanum of the tarot. Its divinatory significance is there given as Change of Fortune. Its meaning is also there indicated in the spiritual world, in the intellectual world, and in the physical world. And still further information about it can be had from the detailed explanation of the number 10 tarot.

But as affecting human life things do not stand alone. Instead they exert an impact upon character. How the character is affected, depends not merely upon the vibration reaching it from without, but also upon the nature of the character thus reached. One individual is affected one way by a certain force and another individual is affected in quite a different way by this same force.

Therefore, if we are to have a positive science—as distinct from a divinatory method—of invisible vibrations as affecting human life and destiny, we must have a chart of the influencing vibrations, and also a chart of the character influenced. By a comparison of the two sets of vibratory rates we can determine, in the manner advocated by exact science, what response will be brought forth from the character by the vibratory tone reaching it.

And so far as human beings are concerned, I know of no method of accurately determining the various vibratory rates—their power, their harmony and discord, the department of life they affect, and the lines of energy exchange between them—that reside in the character, other than through the use of an astrological birth-chart.

The astrological birth-chart is a complete map of the astral body, revealing the strength and nature of all its dynamic thought structures, and how they are organized in relation to each other. It is a reliable map of the character.

Any invisible energy, whether character radiation, astrological radiation, or thought radiation, reaching the astral body of the individual stimulates into additional activity the same tone to which it vibrates as this tone exists already in the astral body. That is, it gives the thought cells of the astral body new energy. How this affects the individual then can be determined by the map of the astral body which is the astrological birth-chart.

The Heirophant—Arcanum

V

—Letter: Egyptian, Eni; Hebrew, He; English, E. Number, 5. Astrologically, the planet Jupiter. Color, indigo and purple. Tone, A. Occult science, Masonry. Human function, the electromagnetic form. Natural remedy, proper diet. Mineral, the metal tin.

E—5 expresses in the spiritual world, universal law, regulator of the infinite manifestations of being in the unity of substance.

In the intellectual world, religion, the relation of the Absolute Being to the relative being, of the infinite to the finite.

In the physical world, inspiration, communicated by the vibrations of astral substance, and the trial of man by liberty of action within the impassable circle of universal law.

Remember, then, son of earth, that before saying of a man that he is fortunate or unfortunate, thou must know the use to which he has put his will; for every man creates his life in the image of his works. The genius of good is at thy right and the genius of evil at thy left. Their voice can be heard only by the conscience. If the hierophant should appear in the prophetic signs of thy horoscope, retire into the sanctuary of thy heart, listen to the voice of the silence, and guided by it thou wilt reach the goal of thy aspirations.

In Divination, **Arcanum V** may briefly be read either as **Religion** or **Law**.

Arcanum V is pictured by a hierophant, master of the sacred mysteries. This prince of the occult doctrine is seated between two columns of the sanctuary; he leans upon a cross of three bars, and with his right hand makes the sign of the pentagram. From his brow the sacred serpent thrusts its head; and at his feet kneel two men, one dressed in red and the other dressed in black.

The hierophant, supreme organ of sacred science, represents the genius of good inspiration, of mind, and of conscience.

The column at the right symbolizes divine law, that on the left symbolizes the liberty to obey or to disobey.

The triple tau, or cross of three bars, is emblem of divine fire penetrating the three worlds, spiritual, astral, physical, in order that all manifestations of universal life may have their birth.

The left hand of the hierophant on the triple tau indicates his receptivity to the divine force; and the gesture of his right hand—making the pentagram—indicates his use of this divine energy to command the obedience of all sub-mundane atoms of life, and to hear the voice of heaven in the silence of the passions and the instincts of the flesh.

The sacred serpent at his brow signifies enlightenment; and the two kneeling men, the one red and the other black, denote the intelligences of light and shadow, both of whom obey the force of the pentagram.

Number

—Numerically, 5 unites the first four digits into a harmonious unity, and thus explains all the apparent contradictions of nature. That is, the One Principle, the One Law, the One Agent and the One Truth are not independent factors, but imply and mutually sustain one another.

These four ideas, as represented by the four animals standing at the four gates of heaven, each quadrant of the sky having one, are brought together in the fourfold form of the sphinx. And the zodiac, so expressed, finds its counterpart in the constitution of one man.

Thus man or woman alone is symbolized by the number five. The hands, feet and head form five positive points from which the electromagnetic fluid is projected, health depending largely upon the equal distribution of the energies to these five points. Also, man, having passed through the four elemental realms of being, becomes their rightful sovereign by reason of his higher accomplishment.

In this sense, as 4 and 1, 5 signifies Realization which comes from the use of Intelligence and Will. For having attained true manhood, by virtue of wider experience, man directs the various entities, physical and astral, which have their orbits within his domain, and these become his willing and obedient servitors in proportion as they recognize his spiritual supremacy.

Astrology

—Jupiter is the ruler both of law and religion. He has dominion over good inspiration, over the church and state, and over the authority of established institutions. He governs popes, hierophants and religious potentates of all kinds. The correspondence, therefore, between Arcanum 5 and the planet Jupiter is so obvious as to need no further comment.

Human Function

—The carrying power of the will upon the physical plane depends upon the strength of the electromagnetic forces. These, in turn, depend upon the extent of vitalization—Arcanum II. In other words, the power of the electromagnetic body, and the carrying power of the will on the physical plane depend upon the ability to receive and transmit electromagnetic energies. These energies circulate through the body and build up the electromagnetic form even as the blood, ruled by Jupiter, carries nourishment to the physical body. Such receiving and transmitting are depicted by Arcanum V.

Alchemy

—The various metals used in alchemy as they are collected are commonly found to contain other ingredients which would prevent them from properly combining in transmutation. Therefore, no matter upon what plane the hermetic art is carried out, there must be a thorough purification of the metals used. In this process of purification the dross is removed and cast aside and the true metal retained.

In spiritual alchemy, for instance, the dross is the apparent effect, while the real metal is the effect upon the soul. The spiritual metals, therefore, are purified by considering them not in the light of events influencing the material fortune, but as events which each can be made to yield spiritual values by taking the proper attitude toward them. In mental alchemy, the metals are purified, not by considering their effect upon the soul, but by casting aside the dross of discord and retaining the elements of harmony.

Likewise, in other branches of the art, purification of the metals, which corresponds to Arcanum V, is always an essential step.

Bible

—The most significant thing about the hierophant in Arcanum V is the sign of the pentagram, or five-pointed star, which he makes with his right hand. This is the symbol of man, the symbol of the intellectual power which dominates the four elemental kingdoms, and the symbol of the magical force of the human will. It gains its force by the gesture which bears token that the user is obedient to the laws of Deity, and thus participates in the divine power over all things.

Arcanum V, an ensemble expressing the idea of the pentagram in great detail, explains also the blazing star that led the wise men of the East to the place where the new sun-god was born that they might worship him. Their gifts of gold, frankincense and myrrh stand representative of the three worlds; spiritual, astral and physical; symbolized in Arcanum V by the triple tau.

These wise men, having been led by the star of religious devotion, into a knowledge of the three worlds and the laws governing them, departed into their own country by another way. That is, having gained illumination, their route to self-conscious-immortality—the return to the realm of spirit—was direct and certain, and not the devious path of the yet unenlightened neophyte.

This five-pointed star which they followed, has the same import as Arcanum V, signifying the Divine Law and Religion. Therefore, when it is inverted, the point of the star representing the head of man down, and the two points denoting his feet up, it signifies the opposite of the Divine Law, the opposite also of man governed by intelligence. Instead, it then denotes chaos, the devil, evil inspiration and the principle of destruction. Thus the Lamb of God is transformed into the Goat of Mendes; and to express this, in black magic the symbol is made by closing the hand so that two fingers are up—the horns of the goat, or feet of man—instead of three.

By such inversion Jupiter, or Jove, becomes Saturn, or Satan, and as such is represented by Arcanum XV. This is expressed in Rev. 8:10; “And the third angel sounded, and there fell a great star from heaven, burning as it were a lamp, and it fell upon a third part of the rivers, and upon the fountain of waters, and the name of the star is called wormwood.”

The waters and fountains refer to the emotions and to love, which in magical practices of any kind are the chief sources of energy. They are turned bitter, like wormwood, when thus utilized for purposes of black magic and evil, for they are then converted into forces of destruction. In Arcanum XV, not only the lamp may be seen, but also the servants of evil in the art of making the inversive sign.

The tarot itself expounds a complete religious doctrine based upon a spiritual science. And not only do the Major Arcana set forth a system which is synthesized as a mantram, for strengthening the will, as explained in chapter 3, but they also synthesize the Religion of the Stars.

Eliphas Levi, the great French magus, expressed his conception of this religion in verse, setting at the head of each line the number of the Major Arcanum whose significance is revealed by it, each Arcanum thus representing one tenet of this ancient Wisdom Religion:

- “ 1. All things announce a conscious active cause,
2. Vivific Oneness, based on number's laws;
3. Who all containing is by naught confined,
4. And all preceding, hath no bound assigned.

5. This only Lord should man adore alone,
6. Who doth true doctrine to pure hearts make known;
7. But acts of faith require a single chief,
8. Hence we proclaim one altar, law, belief.

9. The changeless God will never change their base,
10. He rules our days and rules through every phase,
11. His mercy's wealth, which vice to naught will bring,
12. His people promises a future King.

13. The tomb's a path which to new worlds ascends, and life through all subsists, death only ends. Pure, sacred, steadfast truth we here repeat. The venerated numbers thus complete.

14. The angel blest doth calm and moderate.

15. The evil is the friend of pride and hate.

16. God doth the lightning and the fire subdue;
17. He rules the dewy eve' and the evening's dew.

18. The watchful moon he sets to guard our heights,
19. His sun's the source of life's renewed delights,
20. His breath revivifies the dust of graves
22. Where crowds descend who are of lust the slaves;
0. Or, the mercy seat he covers with his crown,
21. And on the cherubs pours his glory down.”

These impressive words are full of mystic significance, and when repeated in earnestness and with the soul lifted to the Author of All Being, they form a powerful inspirational mantram. The mantram of the will, given in chapter 3, is especially potent to increase the force, the power, and the accomplishment of the will. But this religious mantram serves another purpose; for it adds Faith, unites the human soul to its Maker, and thus lifts the will and its works to a higher plane where their force is expended in cooperation with the Divine Plan, and solely through constructive channels.

These two mantrams, therefore, stand as the masculine and the feminine of a complete system, the best results following the use of both. Although other methods may be used to advantage, one of the best systems of training commences the day, on rising, and while standing erect, with the mantram of the will; and closes the day, while reclining in bed, after retiring, with the mantram devoted to faith. Thus used together they form natural complements, and are important aids to soul growth.

Masonry

—The Past Master's degree of Masonry is founded upon Arcanum V. It represents the Past Master who having passed the degree of this initiation is capable of presiding over a Master Mason's lodge. The lodge, of course, represents the human temple, over which the master must exercise constant dominion. Therefore, to indicate the rebellion of submundane atoms of life within the human domain, in this degree a riot is started.

Unless the one who would be master can use the force represented by the pentagram successfully to quell the elemental forces, as is done in Arcanum V, he is overpowered and made the slave of the very forces he sought to control, as indicated in the fifth degree of Masonry and illustrated by Arcanum XV.

Arcanum V also explains the Blazing Star of the Masonic Lodge. The compass joined to the square typifies both higher and lower union. Union is depicted by Arcanum III, and the Book of the Law, or polarity, is depicted in Arcanum II. Adding the 3 and the 2 we get Arcanum V, picturing obedience to that law, having thus the same symbolical import as the open Bible on which is laid the compass and square, as it is used in the fifth degree of Masonry.

Diamonds, the same suit in common playing cards as Coins in the tarot, are nothing more nor less than the united compass and square conventionalized, the G being removed from the center to show that the higher has superseded the lower.

Magic

—In Magic, Arcanum V expresses the importance of using the proper symbols in all invocations and in ceremonial magic. It reveals the potency of rituals and such symbols as are used by secret societies and by the church.

The pentagram is the symbol of white magic, and thus constitutes the most powerful of all magical tokens; for it expresses the power of a mind which has devoted itself to assisting the progressive evolution of creation, and which knows, and is obedient to, the Divine Law. It is a symbol of constructive purpose.

The use of signs, rituals and symbols either in religion or in magic is a means of contacting invisible entities and other planes of being. The innocent use of an evil symbol in the course of a rite does not prevent the intelligence to which the symbol actually belongs being contacted. No more so than if one innocently calls the

telephone number of a gangster, thinking it is the telephone number of a parson, one will fail to contact the gangster. Symbols and rituals tune the individual in on the intelligence corresponding to them just as a telephone number calls the individual to whom it belongs, regardless of his moral worth, or the intention of the one calling the number.

Initiation

—Arcanum V represents the point in the ascending arc of the cycle of life where the voice of the conscience calls upon man to turn from the flesh-pots and devote himself to cosmic welfare. He decides henceforth to live, not for self alone, but to guide his every action in the direction of aiding cosmic progression. He determines that the good of cosmic society shall be his constant aim.

Occult Science

—Masonry is that one of the seven branches of magic which treats in particular of the use of the emotions engendered by sex; and of the evolution of the human soul and its manifestations on the three planes of being, as set forth by means of signs, symbols and rituals.

In regard to such signs Eliphas Levi truly says:

“Four signs always express the absolute and are explained by the fifth. Thus the solution of all magical questions is that of the pentagram, and all contradictions are explained by harmonious unity.”

As a single illustration of this method of solving occult problems, and because astrology and the tarot are the two keys to all mysteries, I will apply this formula to denoting the true correspondence between each tarot card and its astrological counterpart.

To begin with, the four suit cards of any numbered Minor Arcanum arrange themselves about the Major Arcanum bearing the same number in the form of a diamond; scepters being above, cups at the right, swords at the bottom and coins at the left. Thus arranged the four Minor Arcana express Jod-He-Vau-He, and the Major Arcanum in the center explains the pentagram as a whole as an expression of some planet or zodiacal sign.

The rulership of each Major Arcanum can be found in a similar manner by forming a Grand Pentagram of the whole 22 cards, as illustrated on page 88.

This diagram shows the grand pentagram as composed of five lesser pentagrams, each perfect in itself. And, of course, to be correct, the outer circle of tarots must represent the twelve signs of the zodiac in their natural position and sequence. The planets, in nature, may occur in any of the signs thus located; but their proper place here should bear some significance in relation to life.

Thus the first quadrant, the quadrant of life, is rightly explained by the selfish planet Saturn, showing that self-preservation, among lower forms of life, is nature's first law. But in the same quadrant, and more interior to it, is to be seen Neptune, the planet of universal brotherhood. And thus is also explained that when life has evolved to a spiritual conception, the law of self-preservation gives place to that of unselfish idealism.

The top quadrant, the quadrant of honor, is occupied by Uranus, indicating the struggle to make attainment through the overthrow of existing conditions and the downfall of opponents. But more interior to this is another principle which eventually supersedes. The planet Venus sets forth the idea that "Love lieth at the foundation," of any worthwhile attainment.

The third quadrant, that of companionship, is occupied by Jupiter, indicating that leniency and generosity are attractive to others. But more interior is to be seen Mercury, the planet of intelligence, indicating that a lavish purse does not compensate for lack of understanding, and that intelligence is necessary to make union spiritually advantageous.

The lower quadrant, the home and the end of life, is occupied by the Moon, indicating that physical life ends in the tomb. Yet there is an inner force, a lightning of the soul, typified by the planet Mars, which defies death, rends asunder the tomb, or pyramid, and liberates the soul to a new life in the beyond.

And as explaining all, the pentagram in the center holds the Sun, the source of all vitality, representing the ego which has sent its souls through the cycle of necessity. And the result of this pilgrimage, after the tomb has opened and liberated the souls, is explained by one of two symbols, that of the Earth, or that of Pluto. The soul, even after death, may be earth-bound, or held to the lower regions by its viciousness; or it may move rapidly above the astral into the spiritual realm to be reunited to its missing mate. This latter is the higher aspect—represented by the T with the point upward—of the planet Pluto.

The Fives

—Jupiter, in astrology, is the general significator of good fortune; therefore the fives in their more common divinatory significance must relate to good luck in the particular department of life signified by the suit. But in their application to higher planes, they reveal the influence of, and can be interpreted by, the fifth decanate of each zodiacal triplicity, starting with the movable signs.

The divinatory significance of the Five of Scepters is good fortune in business; its inner interpretation is REFORMATION.

The divinatory significance of the Five of Cups is good fortune in love; its inner interpretation is RESPONSIBILITY.

The divinatory significance of the Five of Coins is abundant wealth; its inner interpretation is INSPIRATION.

The divinatory significance of the Five of Swords is escape from a danger; its inner interpretation is STRUGGLE.

The Two Paths—Arcanum VI

—Letter: Egyptian, Ur; Hebrew, Vau; English V—U—W. Number 6. Astrologically, the planet Venus. Color, yellow. Tone, E. Occult science, kabalism. Human function, the astral body. Natural remedy, rest and recreation. Mineral, the metal copper.

U—6, expresses in the spiritual world, the knowledge of good and evil.

In the intellectual world, the balance between liberty and necessity.

In the physical world, the antagonism of natural forces, the linking of cause and effect.

Remember, then, son of earth, that for the common man, the allurements of vice has a greater fascination than the austere beauty of virtue. If The Two Paths should appear in the prophetic signs of thy horoscope, take care of thy resolutions. Obstacles bar before thee the path thou wouldst pursue, contrary chances hover over thee, and thy will wavers between two resolutions. Indecision is, above all else, worse than a bad choice. Advance or recede, but do not hesitate; and know that a chain of flowers is more difficult to break than a chain of iron.

In Divination, **Arcanum VI** may be briefly interpreted as **Temptation**.

Arcanum VI is figured by a man standing motionless at the angle formed by the conjunction of two roads. His looks are fixed upon the ground; his arms are crossed upon his chest. Two women, one at his right and the other at his left, each place a hand on his shoulder, showing him one of two roads. The woman at his right is modestly clothed, and has the sacred serpent, indicating enlightenment, at her brow. She thus personifies virtue. The one at the left wears less clothing, and is crowned with the leaves and vine of the grape. She represents vice, the temptress.

Above and back of this group the genie of justice, hovering in a flashing aureole of twelve rays, draws his bow and directs toward vice the arrow of punishment. The genie is crowned with a flame to show he is a spirit; and is represented in an aureole of twelve rays to indicate that justice will be meted out in due time to all as the sun passes through the zodiacal signs.

This ensemble typifies the struggle between conscience and the passions, between the divine soul and the animal soul, and that the result of this struggle commences a new epoch in the life.

Number

—Six signifies two actions, or twice three. It does not represent forces in equilibrium, but a constant oscillation between action and reaction. It thus indicates a wavering, a vacillation, forces so uncontrolled and ill-directed that they tend to destroy one another.

Astrology

—Venus governs the affections and the social relations. It gives love of ease, comfort, luxury and pleasure. It is not essentially evil, but in seeking the line of least resistance it may be led into vice. When it thus fails to resist the importunities of the wicked, it comes under the negativeness of Arcanum II, and is then under the dominion of Arcanum XV, or Saturn, which is the second decave of VI.

Human Function

—Because the astral body is so responsive to every thought and emotion it is often called the desire body. The affections not only shape it, but give it nourishment; for it is organized by states of consciousness. Because it is so receptive and yielding, and the emotions play so important a part in its makeup, this astral body corresponds to Venus, and to Arcanum VI.

Alchemy

—After the metals have been purified, before they are finally joined in transmutation they are first tested to be sure that no dross or impurities remain. This process of testing the purity of the metals, of applying the test of love, corresponds to Arcanum VI.

Bible

—Of the sons of Isaac, Esau, who sold his birthright (spiritual heritage) for a mess of pottage (material things), listened to the voice of vice. Jacob, however, who once successfully wrestled with the spirit of temptation, and though afflicted was not conquered, in this story listened to the voice of virtue.

Math. 4:8, “Again the devil taketh him up into an exceedingly high mountain, and sheweth him all the kingdoms of the world and the glory of them; And said unto him, All these things will I give thee if thou wilt fall down and worship me.”

Masonry

—The Most Excellent Master degree of Masonry is founded upon Arcanum VI. “When the Temple of Jerusalem was finished, those who had proved themselves worthy by their virtue, skill and fidelity, were installed as Most Excellent Masters.”

Magic

—Arcanum VI represents the temptations that always come to those who attain power. Especially is this temptation great among those who attain to the use of invisible energies. Should they yield to such insidious promptings, their lot is terrible; for they become the slaves of the very forces they imagined they had controlled. This Arcanum also represents the use of privation, hardships and obstacles to strengthen and test the will.

Initiation

—The evolving soul, passing through the lower kingdoms, where strife and self-preservation are dominant factors, develops the animal propensities and instincts to a high degree. This is a necessary phase of its progression. But when self-consciousness has been reached, in order that the animal may partake of the Divine quality which makes self-conscious-immortality possible, these animal energies and instincts must be diverted into a higher than animal channel. They must be directed, or transmuted, into an organization of energy having for object the welfare of society as a whole. This higher-type organization, largely drawing its energies from the animal soul, or lower-type organization, yet containing many higher vibration rates, is called the divine soul.

Occult Science

—Kabalism, corresponding to Arcanum VI, and therefore the feminine, embraces the written scriptures and the oral traditions of every land. It is really the science of traditional knowledge, the tarot being a condensation of the whole science.

The Sixes

—Venus, in astrology, is natural significator of love, art, music and drama, as well as of social functions; therefore the sixes, corresponding numerically to Venus, in their more common divinatory significance must relate to these things as applied to the department of life indicated by the suit. But in their higher application they reveal the influence of, and can be interpreted by, the sixth decanate of each zodiacal triplicity, starting with the movable signs.

The divinatory significance of the Six of Scepters is music, art or the drama; its inner interpretation is AMBITION.

The divinatory significance of the Six of Cups is a love affair; its inner interpretation is ATTAINMENT.

The divinatory significance of the Six of Coins is a social event; its inner interpretation is REPRESSION.

The divinatory significance of the Six of Swords is dissipation; its inner interpretation is MASTERSHIP.

Method of Three Sevens

—After shuffling and cutting, the cards are dealt from the top, one by one, from right to left, starting with the bottom row, in three rows of seven cards each.

The bottom row represents the past, the middle row the present, and the top row the future. In each row the central card, marked with an asterisk, is the most important, being the key to which the others merely contribute. In reading, the adjoining cards modify each other, and all should be blended as parts of a complete whole.

Future	21	20	19	18*	17	16	15
Present	14	13	12	11*	10	9	8
Past	7	6	5	4*	3	2	1

Chapter 6

Serial No.26
Original Copyright 1936
Elbert Benjamine

Copyright
Church of Light
August 2002

Making an Astrological Chart of a Name

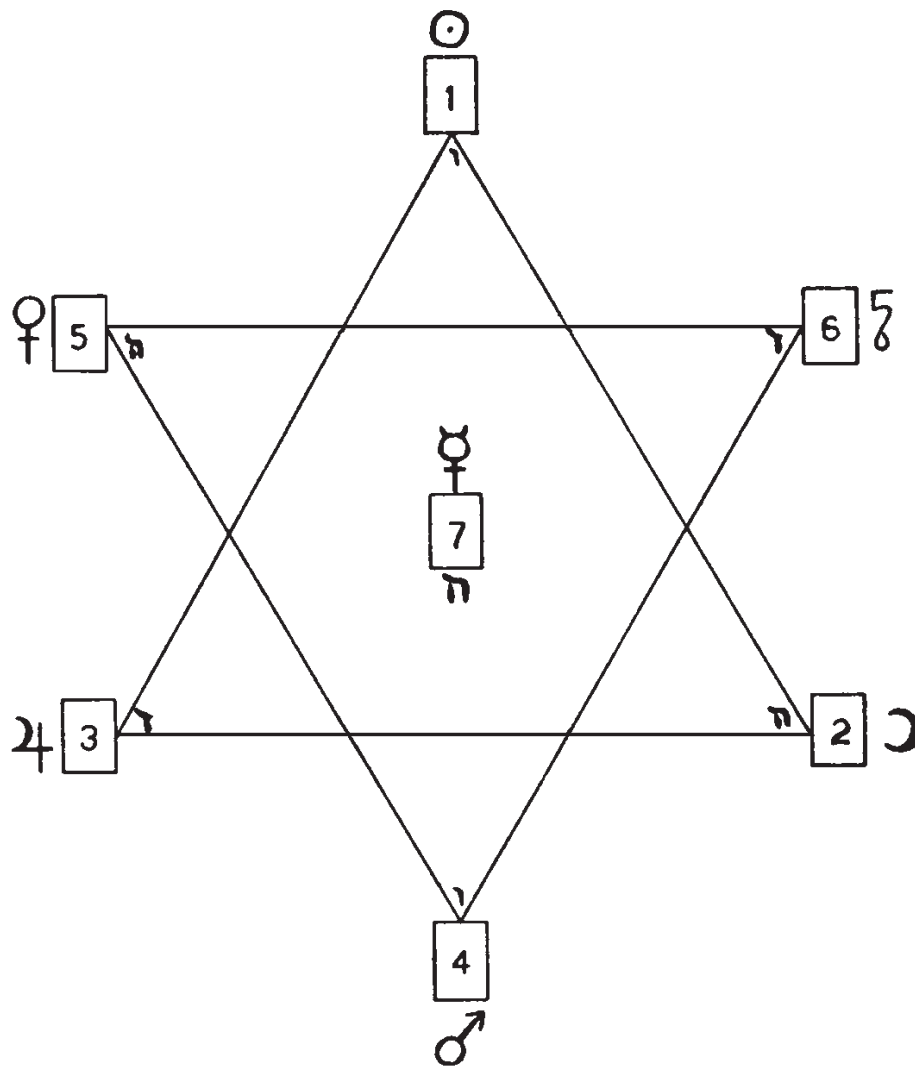

THE MAGIC SEVEN SPREAD

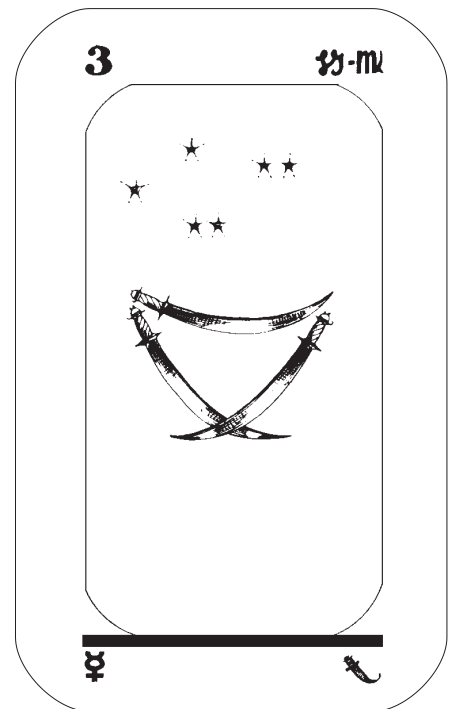
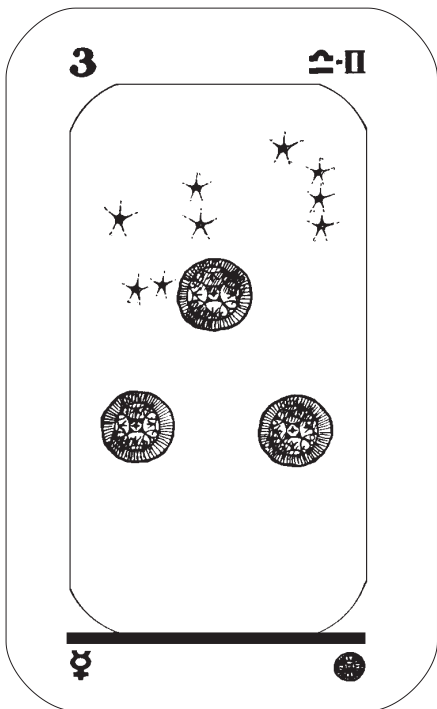
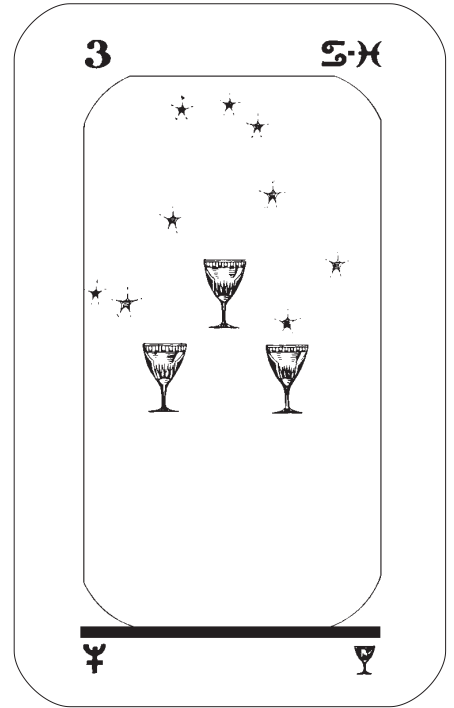
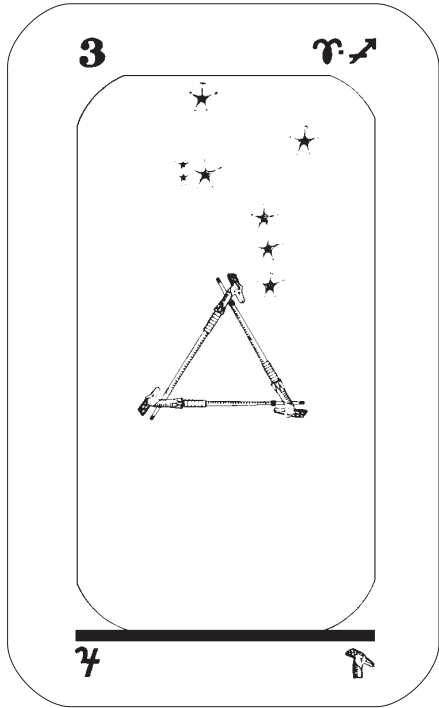

Chapter 6

Making an Astrological Chart of a Name



HERE is just one way, in so far as I know, of determining in a positive, reliable and scientific manner how any invisible vibratory tone, or combination of such tones, will affect a certain person. That is by comparing the tone, or tones, with the astrological birth-chart of the person.

The planets and signs in a birth-chart each map thought-cells of specific tones, as revealed by their correspondences, which are set forth in these lessons. Any thought-vibration, character-vibration, or astrological-vibration reaching the individual adds its energy to the thought-cells having the same vibratory rate in the astral body of the person. The chief influence of a name, or number, as affecting a person is to give added energy to the thought-cells of that section of the astral body of the person which vibrates to the same rate as the Key-tone of the name or number.

That is, to determine how a name or number or other invisible influence will affect a person, first get the Key of the name or number, or other influence. This key is expressed by some number below 23. Thus the Mars dynamic structure vibrates to the tone 16, and the Virgo zone vibrates to tone 2.

Now if the Mars structure in a person's astral body is very discordant, as shown by inharmonious aspects to Mars in the birth-chart, any energy added to its thought-cells by objects, by thoughts, or other influences vibrating to tone 16 merely increases the power of these thoughts to attract such Catastrophe as is pictured by Arcanum 16. But if the Mars structure in a person's astral body is harmoniously organized, as shown by Mars having strong beneficial aspects in the birth-chart, this added energy will increase the power of its thought-cells to attract events which are constructive and beneficial.

The pictured arcanum corresponding to each of the signs and planets thus represents the more common influence of the tone apart from lines of force which, like aspects, conduce to harmony or discord. But in the astral body of man these dynamic structures and zones, which vibrate to the tones so depicted, are usually strongly modified and influenced by the manner in which they have been associated with other thought structures. Therefore, while tone 15 may in general be considered as

Fatality; in a person's chart who has the planet Saturn exceedingly well aspected it might be the most fortunate influence in the life, and the one which, when given added energy, would bring the most benefit.

Therefore, in determining how a name, number, environment, or other invisible influence will affect an individual, the tone of the influence should first be determined, and then a study should be made of this tone as mapped in the astrological chart of birth. If the tone in the chart of birth is essentially beneficial, the same tone received from a name, number, other person, locality, birth-stone or anything else will be beneficial; because it will increase the power of beneficial thought-cells in the astral body. But if the tone as mapped in the birth-chart is detrimental, the same tone received from without, from any of the sources mentioned, will tend, through giving discordant thought-cells more energy, to attract misfortune.

Fortune or misfortune does not come equally through all departments of life. And a particular vibratory tone often stimulates one or two departments of life, and has little or no influence upon other departments. It thus may have an influence over finances and yet have no influence whatever over health or companionship.

The department of life influenced by a vibratory key is denoted by the compartment in the astral body ruled by the sign or planet in the birth-chart whose thought-structure is stimulated into activity by the key. Thus, disregarding whether the influence will attract or disperse it, if the key-tone is the same as a planet in the house of money (2nd house), or the same as the sign on the cusp of the house of money (2nd), its chief effect, for good or ill, will be upon money. But if the key-tone is the same as a planet in the house of partnership (7th), or the same as the sign on the cusp of the house of partnership (7th), the chief influence will be upon the relation with partners.

Now if on a pond of water there are several little sticks floating, and someone throws a rock into the pool, this disturbance of the water also disturbs the little sticks and they go bobbing about. Likewise, if there is one or several planets in a zodiacal sign in the birth-chart, because these planets represent organized groups of thought-cells in that zone of the astral body indicated by the sign, if the sign is given increased activity, the groups of thought-cells in it are set in motion.

The precise power of a dynamic thought structure mapped by a planet or the common thought-cells mapped by an unoccupied sign to attract good fortune when thus given increased activity is directly proportional to its harmodynes, and the precise power of a dynamic thought structure mapped by a planet or of the common thought-cells mapped by an unoccupied sign to attract misfortune when thus given increased activity is directly proportional to its discordynes. How to calculate the astrodynes, harmodynes and discordynes of each birth-chart planet, sign and house is explained in Chapters 1 and 2 of Course 16, *Stellar Healing*.

An unoccupied sign occupying one house cusp has one-half the harmodynes or discordynes of its ruling planet. An unoccupied intercepted sign has one-fourth the harmodynes or discordynes of its ruling planet. An unoccupied sign occupying the cusp of two houses has the same number of harmodynes or discordynes as its ruling planet. Thus on an average the influence of a planet is twice as important as that of an unoccupied sign.

Thus it is that when we have before us that complete map of the astral body of any individual, which is a birth-chart, we can determine in a positive, scientific and detailed manner how any invisible vibratory rate of which we know the key will affect him. We can determine if the particular key will tend to attract to him fortune or misfortune. We can determine in what department of life that fortune or misfortune will be attracted. And we can determine, by calculating the astrodynes of the planet or sign mapping the thought-cells within his astral body responding to this key and the probable volume of energy added to them by the invisible influence, somewhat of the magnitude of the events that will thus be attracted into his life.

Now any name or any number can be converted into an astrological chart by the simple expedient of substituting the corresponding Major Arcanum for each of the letters or numbers. Each Major Arcanum also, of course, signifies a definite astrological influence.

These various letters of a name, or the astrological influences substituted for them, each represent one tone. Each letter of the name, therefore, as a tone, has some influence in stimulating into activity the corresponding tone in the astral body of the person wearing the name. Sometimes in a person's name certain letters are repeated several times. Sometimes there will be several A's, for instance, or the letter l may occur twice in each member of the name. In such cases, naturally, the influence of the particular tone so repeated is intensified, and may be taken into consideration in its relation to affecting the individual. But in all cases the Key of the name as a whole is by far the most important vibratory rate, and even letters that occur repeatedly in the name are of subsidiary influence.

To chart a name, therefore, we find the Key of the number of the name, and set it at the head of the chart as the dominant influence. In relation to the name itself, it represents the birth-chart. Then if we desire to do so we find the Key of the Decave and place it at the foot of the chart. It indicates the end of things, that which the fourth house in an astrological chart represents. Then the letters of the name may be placed between the Key of the name and the Key of the Decave as transitory influences.

**Reading A Name Alone
Does Not Give a Reading
for the Individual Wearing
It**

—By using such a chart we can give a reading of any name. But because people wearing the same name are different individuals, we must not assume that a reading of the name alone gives a reading applicable to the individual wearing it. On the contrary, to give a reading of the individual wearing a name, even by the process of divination by numbers, we must add an individual element. This individual element which is most suitable for such use is the Birth Path. And the method of using it and giving such a divinatory reading by means of numbers is set forth in chapter 8.

Apart from any individual, however, and not indicative of any person's fortune, we can make an astrological chart of any name or any number which will be scientifically correct; and to one delving in spiritual research such a chart often will yield information of value.

Let us take the name Jesus, for instance. J-10, E-5, S-21, U-6, S-21. 10 plus 5 plus 21 plus 6 plus 21 equals 63. 6 plus 3 gives 9 as the Key of the name. 63 minus 9 gives 54. 54 divided by 9 gives 6. 6 plus 1 gives 7 as the Key of the Decave. Then the astrological chart may be stated thus:

Aquarius (9), Uranus (10), Jupiter (5), Sun (21), Venus (6), Sun (21), Sagittarius (7).

As the birth date of Jesus is unknown we will attempt no reading of his life. But the motive actuating those who follow his doctrines is very apparent. The Key of the influence is Aquarius, or Major Arcanum IX, signifying Prudence and Circumspection. The prudence of the followers of Jesus causes them to accept Him in the expectation of finding heaven and escaping hell. And the end for which they hope, both here and hereafter, is Sagittarius, or Major Arcanum VII, signifying Victory. "Onward, Christian Soldiers," as sung in thousands of Sunday schools, might well be inspired by the pictured Arcanum VII with its conqueror riding forward to overcome opposition.

Aside from astrology let us consider the vibratory significance of some other holy names: The Jews called their stern and unyielding God, Jehovah, spelled in Hebrew, Jod-He-Vau-He (I-E-V-E): 10 plus 5 plus 6 plus 5 equals 26. 26 being more than 22 must be involved. 2 plus 6 gives 8 as the Key of the name. 26 minus 8 gives 18. 18 divided by 9, plus 1, gives 3 as the Decave. Thus the Key and the Decave, 8 and 3, indicate the moral code of Jehovah to have been inflexible Justice in Action.

To proceed with other deific names, the chief deity of Christianity is spelled G-O-D: 3 plus 16 plus 4 equals 23. 2 plus 3 gives 5 as the Key of the name. 23 minus 5 gives 18. 18 divided by 9, plus 1, gives 3 as the Decave. The Key and the Decave, 5 and 3, thus indicate that the idea behind the Christian God is beneficent (Jupiter) Law in Action.

Now turn to the deity of Egyptian initiates, Ra. R-A: 20 plus 1 gives 21, which needs no involving because it is already a Key, pictured by Arcanum XXI. Ra is thus, according to its Key and its astrological ruler, the spiritual Sun of our universe; the highest spiritual and intellectual entity; and those who worship Him strive to become the most spiritual and intelligent men on earth; they strive to be adepts. Astrologically, Ra is the Sun. The religion of His devotees is expressed still more in detail by the two arcana picturing the two letters of the word, 20 and 1, signifying Will and Intelligence (1), Resurrecting (20), the soul beyond the tomb.

What is the vibratory import of the Hindu deific word used so frequently as a mantram, and rendered into English as A-U-M? 1 plus 6 plus 13 equals 20. The Key (20) reveals that the object sought is to Awaken (20), the soul to its latent possibilities. The method employed to do this is indicated by the three letters: The Will (1), brought to bear upon Temptation (6), to induce a Transformation (13).

And this rendering of a foreign name brings up a point of some importance; that of the different ways of spelling a name.

Again I would call your attention to the principle that it is not the sound of a name, nor its phonetics, with which we are dealing, but its astral vibratory-rates. These astral vibratory-rates are set in motion by the person thinking the name, and they are set up irrespective of vocal action. Nor do people of different countries, who spell a name differently, have the same conception of its significance.

Because with most people, according to psychological experiments, sight registers its impressions more quickly and more strongly than sound, the spelling of a name commonly determines its thought-vibration when it is thought about. The English spelling, therefore, only indicates the vibratory significance of the name to those who use the English spelling. Any alteration of the spelling of a name, even though the phonetic value is unchanged, thus changes the vibratory-rate and the inner meaning of the name. The native spelling of a name gives its significance to such natives.

Buddha: 2 plus 6 plus 4 plus 4 plus 8 plus 1 gives 25. 2 plus 5 gives 7 as the Key. 25 minus 7 gives 18. 18 divided by 9, plus 1, gives 3 as the Decave. Thus our conception of the life and teachings of this great reformer is Victory (7), of mind in Action (3).

Brahma: 2 plus 20 plus 1 plus 8 plus 13 plus 1 gives 45. 4 plus 5 gives 9 as the Key. 45 minus 9 gives 36. 36 divided by 9, plus 1, gives 5 as the Decave. This deity, therefore, to us signifies Wisdom (9) acting through Law, (5).

Vishnu: 6 plus 10 plus 18 plus 14 plus 6 equals 54. 5 plus 4 gives 9 as the Key. 54 minus 9 gives 45. 45 divided by 9, plus 1 gives 6 as the Decave. This god of preservation therefore exemplifies the thought that Wisdom (9) overcomes Temptation (6).

Siva: 21 plus 10 plus 6 plus 1 equals 38. 3 plus 8 gives 11 as the Key. 38 minus 11 gives 27. 27 divided by 9, plus 1 gives 4 as the Decave. The Hindu trinity, Brahma, Vishnu and Siva are usually translated as Creator, Preserver and Destroyer. But while Siva does represent destruction, it is a destruction which implies a restoration,

or reproduction, and thus the linga is used as his emblem. And this significance is conveyed by Force (11), undergoing Realization (4).

Devil: 4 plus 5 plus 6 plus 10 plus 12 equals 37. 3 plus 7 gives 10 as the Key. 37 minus 10 gives 27. 27 divided by 9, plus 1 gives 4 as the Decave. The Devil thus is the agent for a Change of Fortune (10), Realized (4).

Hell: 8 plus 5 plus 12 plus 12 equals 37. 3 plus 7 gives 10 as the Key. 37 minus 10 gives 27. 27 divided by 9, plus 1 gives 4 as the Decave. Hell, therefore, is a Change of Fortune (10), Realized (4).

The early Magi erected a tower to Bel: 2 plus 5 plus 12 gives 19 as the Key. As it is already below 23 no Decave influence need be considered. We chart this name in detail thus—19 (Key)—2-5-12, and read it as Happiness and Prosperity (19) devoted to Science (2), Religion (5), and Sacrifice (12).

Later generations forsook the worship of Bel for Baal: 2 plus 1 plus 1 plus 12 gives 16 as the Key. In detail it indicates that the desire for violence (16) prompted the energies to be turned to Science (2), Will (1), Intelligence (1), and Sacrifice (12).

Babylon: 2 plus 1 plus 2 plus 10 plus 12 plus 16 plus 14 equals 57. 5 plus 7 gives 12 as the Key. 57 minus 12 gives 45. 45 divided by 9, plus 1 gives 6 as the Decave. Babylon is mentioned in Revelations as the great prostitute; which is borne out by its vibratory significance which reads Sacrifice (12), to Temptation (6).

The above examples, I believe, are quite ample to denote how names may be handled as factors in themselves, apart from their influence upon any particular individual. But I must repeat, because it is so frequently overlooked by those who practice numerology, that when the influence upon an individual is to be revealed, or a reading is to be given an individual based on his name, that there is always an additional individual factor which must be included.

The Conqueror—Arcanum VII

—Letter: Egyptian, Zain; Hebrew, Zayin; English, Z. Number, 7. Astrologically, the zodiacal sign Sagittarius. Color, the lighter shades of purple. Tone, high A. Occult science, spiritual astrology. Human function, the sense of smell. Natural remedy, such herbs as mallow, wood betony, featherfew, and agrimony. Mineral, the talismanic gem red garnet (often called carbuncle), and such stones as are mixed with red and green, including turquoise.

Z—7 expresses in the spiritual world, the septenary dominion of spirit over matter.

In the intellectual world, the sacerdocy and the empire.

In the physical world, submission of the elements and forces of matter to the intelligences and forces of man.

Remember, then, son of earth, that the empire of the world belongs to them who possess the sovereignty of spirit, that is to say, the light which makes clear the mysteries of life. If the Conqueror should appear in the prophetic signs of thy horoscope, it signifies that in breaking through obstacles thou wilt crush thy enemies; and all thy wishes will be realized if thou attack the future with audacity, armed in the consciousness of thy right.

In Divination, **Arcanum VII** may briefly be read as **Victory**.

Arcanum VII is figured by a war chariot of square form, surmounted by a starry canopy sustained by four columns. Upon this chariot advances a conqueror armed with a cuirass and carrying both sword and scepter. He wears a crown from which rises three pentagrams, or golden stars with five points.

The square car symbolizes the material world vanquished by the work of the will. The four columns supporting the canopy represent the four quadrants of heaven which surround the conqueror. They also represent the four elemental kingdoms that have submitted to the master of the scepter and the sword.

Upon the square front of the chariot is pictured a sphere sustained by two outspread wings; symbol of the immortal flight of the soul through the infinitude of space and time. The sacred serpent at the conqueror's brow signifies the possession of that intellectual light which makes clear all the arcana of fortune. The three golden stars rising from the crown symbolize the dominion of man in all three worlds; physical, astral and spiritual.

A T-square and two try-squares are traced upon the cuirass. The T-square, or Tau, symbolizes virile force, and the two try-squares indicate the rectitude of judgment that enables the conqueror to direct this force either to right or left, into mental or physical power as occasion demands.

The cuirass signifies resistance; the high held sword is the emblem of physical victory; and the scepter indicates mental conquest. This scepter is surmounted by a square, a circle, and a triangle. The square is the emblem of matter, the circle indicates the realm of spirit, and the triangle is the emblem of mind; together denoting the perpetual dominion of intelligence over all realms and forces of nature.

Two sphinxes, one white and the other black, are harnessed to the car. A sphinx, as composed of the four emblems of the zodiacal quadrants, indicates the passage of time. The white sphinx signifies fortunate periods, and the black one signifies periods of adversity; both of which serve the soul victorious over the ordeals met in its pilgrimage of eternal progression.

Number

—Numerically, 7, as composed of the numbers 3 and 4, expresses action and completion. It is the number of perfect form on the physical plane. It is thus the septenary, which is the complete and perfect three-dimensional gamut; even as 9 is the complete and perfect four-dimensional gamut. A scale of 7 is better, therefore, to indicate physical tones and electromagnetic vibrations; but a scale of 9 is more convenient to indicate astral tones and thought-vibrations. Thus in three-dimensional existence where perfection of form exists it will be found that the number 7 expresses it as 3 and 4. The 3 are active principles. The 4 are reactions, or forms.

In human life 7, as composed of 3 and 4, express the concrete 4 dominated by action, or 3; the realization of physical perfection through active effort. As composed of 5 and 2, it indicates man in full possession of the law of polarity, realizing the potency of sex force. As composed of twice 3 plus 1, it signifies body, soul and spirit united to body, soul and spirit, guided by intelligence and under control of will; thus representing the perfect nuptial union. It is dominion of intelligence over all actions, hence complete Victory over all Temptations.

Astrology

—Astrologically, Sagittarius is pictured as the starry Centaur, with bow full drawn, indicating its combative qualities and its locomotion. Sagittarius is a dual sign, adapting itself to both scepter and sword. It is natural ruler of philosophy and travel; its chief mental characteristics being obedience to ruling authority, discipline, prompt decision, self-control and the power to command others. The conservative attributes are well represented by the cuirass; and the other qualities are all symbolized in detail by the various pictured emblems of Arcanum VII.

Human Function

—It has been explained that the planet Jupiter corresponds to the electromagnetic body. This body is nourished by the electromagnetic energy liberated from protein molecules, as explained in Chapter 9 of Course 5, *Esoteric Psychology*. The electromagnetic energy of the nervous system enables it both to broadcast and receive short-wave radiations. As an aid to tuning in on the desired wave-length incense has been found helpful. Through stimulating the sense of smell in the proper way the mind is directed to a certain state of consciousness, which raises or lowers the individual's vibrations, tuning him in on the grade of energy it is desired to contact. Thus does the sense of smell correspond to Arcanum VII.

Alchemy

—The various ores from which the metals to be used in the process of transmutation are obtained are not of equal richness, and are not of equal suitability as furnishing the required metals. And when the metals are extracted from these ores, or are otherwise obtained, they are not of equal purity, or of equal value. Thus it is that every ingredient used in the process should be assayed to determine its refinement, to determine its value, and to determine how best it may be treated to purify it to the extent required if it is to be used in the alchemical work.

In spiritual alchemy, for instance, each experience needs to be appraised as to its possibilities of providing spiritual values, and to determine exactly what attitude will recover the highest percentage of these spiritual values. In mental alchemy, a still different appraisal is made to determine the value in terms of harmony, and the treatment necessary to gain these values in highest measure. Such determinations are secured through assaying, which corresponds to Arcanum VII.

Bible

—Joseph, sold into Egypt, representing the soul born into matter and fettered by carnal desires, represents Arcanum VII.

But Joseph overcame all obstacles and rose to great power, as indicated by the sword. And in addition to having at his command the material forces thus indicated, he also became an interpreter of the Divine will, as symbolized by the scepter.

He was tempted by Potiphar's wife, Arcanum VI, but he Triumphed (Arcanum VII) over the temptation, even though it meant certain affliction. The dream of Pharaoh which he interpreted, of the 7 fat kine and the 7 lean kine, and the 7 good ears and the 7 bad ears, related to periods of good and evil, such as the white sphinx and the black sphinx of Arcanum VII signify. The result of his triumph through periods of good and periods of evil, and of his not yielding to temptation, is set forth in Gen. 41:41, and is symbolical of what may be expected by others who triumph over temptation; for they also shall be made rulers over the physical plane, which is the land of Egypt.

“And Pharaoh said unto Joseph: See, I have set thee over all the land of Egypt. And Pharaoh took off his ring from his hand, and put it upon Joseph's hand, and arrayed him in vestures of fine linen, and put a gold chain about his neck: and made him to ride in the second CHARIOT which he had: and they cried before him: Bow the knee: and he made him ruler over all the land of Egypt.”

Masonry

—The Royal Arch degree of Masonry is based upon Arcanum VII. The chariot, like the tabernacle, is an oblong square; but instead of being divided into four veils the canopy is supported by four columns.

The captivity in Babylon is denoted by the square-formed chariot; and the release from bondage by the scepter. The return journey to Jerusalem is denoted by the two sphinxes hitched to the wheeled car. The arcanum also symbolizes the vault into which the candidate is lowered; where he finds the Ark of the Covenant containing the four emblems which are the suits of the tarot cards. Of these the scepter represents the rod of Aaron; the sword is the symbol of the tablets of the law, the gomer is represented by the cuirass, and the sacred serpent indicates the manna, or intellectual food.

The three jewels, or trying squares of the three ancient Masters, are to be seen on the cuirass, and the wonderful scroll, which is the key to the ineffable characters of the degree, is present as the starry canopy overhead. The long lost Master Mason's Word, which is recovered in the Royal Arch, is fully exemplified by the four symbols mentioned, and is written in three languages as indicated by the golden stars. All of which, plainly stated, signifies harmonious union of positive and negative forces, such as the Masonic trowel suggests, on all three planes of existence.

Magic

—In magic, Arcanum VII represents the power of projection, of sending the astral form to a distance; and the power of attraction, of compelling the astral of another to appear and obey whatever commands may be given. And it is also of the same symbolical import as the Seal of Solomon, the two interlaced equilateral trines.

Next to the pentagram, Solomon's Seal is the most important magical diagram; for it represents the macrocosm and its laws, thus indicating its user to be familiar with nature, and to be endowed with intelligence.

Initiation

—In the soul's pilgrimage, Arcanum VII indicates physical initiation completed. It shows proficiency in both science and magic. The temptations of the material world have been surmounted and the neophyte has gained complete mastery of self. The body is under the control of a disciplined will, and whatever knowledge concerning spiritual things is obtainable in the external world has been gained.

The scepter and the sword balance each other, positive and negative, indicating that the neophyte has a partner whose physical temperament, mental polarity, and spiritual aspirations are in complete harmony with his own. And as shown by the Tau and squares on the cuirass, they both implicitly obey the divine laws governing physical union, having mastered which they become candidates for regenerate union as signified by Arcanum XIV, and later for true soul-union represented by Arcanum XXI.

Neither 7 nor 14 are decaves of 3, the number of union; but 7, composed of 3 and 4, expresses union and its issue, which is perfection of form. And the multiples of 7, though not decaves of 7, relate to some octave of the perfect form.

Occult Science

—Spiritual astrology reveals the facts which the wisest men of all time have learned regarding the nature of the soul, its destiny, and how it may best make progress. Such facts have been recorded still more specifically in the pictured constellations. These pictured constellations thus form a positive key to the sacred books of the world, and give detailed instructions on how the soul may best proceed to scale the spiritual heights.

The Sevens

—The sign Sagittarius is general significator of philosophy, long journeys, publishing, teaching and out-of-doors sports; therefore the Sevens, corresponding numerically to Sagittarius, in their more common divinatory significance must relate to these things as applied to the department of life indicated by the suit. But in their higher application they reveal the influence of, and can be interpreted by, the seventh decanate of each zodiacal triplicity, starting with the movable signs.

The divinatory significance of the Seven of Scepters is success in teaching or publishing; its inner interpretation is DEVOTION.

The divinatory significance of the Seven of Cups is a successful change of home; its inner interpretation is VERITY.

The divinatory significance of the Seven of Coins is money earned through a journey; its inner interpretation is INTUITION.

The divinatory significance of the Seven of Swords is danger through travel or sport; its inner interpretation is ACHIEVEMENT.

The Balance—Arcanum VIII

—Letter: Egyptian, Helitha; Hebrew, Cheth; English, H-CH; Number, 8. Astrologically, the zodiacal sign Capricorn. Color, the darker shades of blue. Tone, low G. Occult science, horary astrology. Human function, the sense of hearing. Natural remedy, such herbs as henbane, nightshade and black poppy. Mineral, the talismanic gem sardonyx, and ash-colored or black minerals such as coal.

H—8 expresses in the spiritual world, absolute justice.

In the intellectual world, attraction and repulsion.

In the physical world, relative justice, fallible and limited, which comes from man.

Remember, then, son of earth, that to be victorious over thyself and dominate obstacles is but a part of the human task. To accomplish it entirely thou must establish equilibrium between the forces that thou hast brought into play. All action produces

reaction. The will should foresee the shock of opposite forces in order to temper or annul them. If the Balance should appear in the prophetic signs of thy horoscope, it signifies that the future is balanced between good and evil, and warns that an unbalanced mind is like an abortive sun.

In Divination, Arcanum **VIII** may be read as **Justice** or **Equilibrium**.

Arcanum VIII is figured by a woman, blindfolded and seated upon a throne. She wears a crown of lance-heads, holds in her right hand a raised sword, in her left hand a balance, and from her brow the sacred serpent thrusts its head.

This is the ancient symbol of justice, which weighs all acts and opposes to evil as a counterweight the sword of expiation. Justice, emanating from God, as symbolized by the overshadowing protection, is the equilibrium between right and duty.

Justice is crowned with lances to indicate inflexibility, adorned with the sacred serpent to signify she acts with enlightenment, and her throne is placed on a platform of three steps to represent her action in all three worlds. At her side is a lion, symbol of the force over which she rules; and a sphinx, symbol of the passage of time which enables her to manifest. Above is a winged turtle, symbol of the repentance which may bring forgiveness. At the back is a divine messenger, signifying that the justice of God will be the final judge of the justice of men. The sword is here a sign of protection to the good and a menace to the wicked.

The eyes of Justice are covered with a bandage to show that she weighs and strikes without taking into account the conventional differences that men establish for themselves.

Number

—Numerically, 8 expresses complete balance and equilibrium, hence stagnation and death. As composed of two fours it indicates two realizations of an opposite nature, and is thus the antithesis of progress. In nature it signifies the polarization of the forces that bind together, or that produce motion; hence dissolution of matter and inactivity of energy. It is the number of annihilation, unconsciousness and mortality.

Astrology

—Perfect equilibrium of forces produces crystallization. A solid is the result of an equilibrium established between at least eight forces. First, two forces converge. And about this point of equilibrium two forces meet from above and below, two from right and left, and two from behind and in front; eight forces in all, well represented by a cube with its six faces and a center. Verily, matter is nothing but spirit in a state of equilibrium. The most earthy sign of the zodiac, the sign which the sun enters when life's forces are lowest and the waters and vapors of earth crystallize into ice and snow, is Capricorn. Capricorn well expresses that equilibrium which results in crystallization, and thus corresponds to Arcanum VIII.

Human Function

—Capricorn is receptive, and is also a reflective zodiacal sign which pertains to earthly endeavor. These qualities which express as receiving and not giving, of utilizing all to its own advantage, are well typified by the sense of hearing. It is often quoted that where speech is silver silence is gold; and Arcanum VIII pictures this stable attitude of listening.

Alchemy

—In all branches of alchemy different ingredients are brought together. And it is of utmost importance that they shall be present in just the right amounts. In order that they shall form the proper fluxes for each other, and in order that some essentials shall not be too small in quantity, the ingredients are weighed. If there is not sufficient of some substance, as indicated by such weighing, it must be sought out and added to the mixture. Both the weighing and the seeking of ingredients thus found lacking, correspond to Arcanum VIII.

Bible

—The descent of the spirit into matter, and the result of the equilibrium so established is set forth in Gen. 3:19: “In the sweat of thy face shalt thou eat bread, till thou return unto the ground: for out of it wast thou taken, and unto dust shalt thou return.”

Surely the wages of sin is death; but the only real death is the polarization of the spiritual forces by the animal propensities as indicated in Rev. 3:16: “So, then, because thou art lukewarm, and neither cold nor hot, I will spue thee out of my mouth.” Still more explicit, as indicating the reaction upon those who once see the truth and later turn to evil ways, turning back from a higher vibratory level to selfish motives, is the account of Lot’s wife, Gen. 19:26: “But his wife looked back from behind him, and she became a pillar of salt.”

Masonry

—The Royal Master degree is founded upon Arcanum VIII. As a Just reward for the most skillful and faithful Masons in building the Temple, it was decided to impart to them the Omnic Word as soon as the Temple was completed. “And behold I come quickly: and my reward is with me, to give every man according as his work shall be,” etc. It also represents the judgment which ultimately was passed upon the assassins of Hiram Abiff, and the state of disintegration in which the body of Hiram was found.

Magic

—Nothing is more sure than that in magic any thought or desire projected to another will in time return to influence the sender. The magical forces of the soul traverse the spaces almost instantly and fasten upon the object of its ceremony, and may act with terrible force. But if such a force launched toward another has not the power to penetrate his aura it at once reacts upon the sender and affects the other not at all.

In repelling any evil influence there should be no thought either of vengeance or of mercy, but instead an attitude of unbending justice. Efforts at retaliation attract fearful dangers. To launch a destructive thought is to attract denizens who are destructive by nature, and who may linger long afterwards.

Initiation

—In the soul's pilgrimage a time comes when the individual accepts some definite work to perform for the benefit of humanity. In carrying out this spiritual work, his body must have sustenance. Thus he can not entirely ignore the physical, nor can he devote his energies exclusively to financial ends. He also has certain obligations to his family which he should not ignore. Too much energy spent in gaining wealth and caring for the physical body prevents the accomplishment of the spiritual work; and upon his faithfulness to it depends his further progress. Thus he must learn to "Render, therefore, unto Caesar the things that are Caesar's, and unto God the things that are God's."

Occult Science

—Horary astrology depends upon the relation between the mental factors and the positions of the heavenly bodies. A question receives additional stimulation when the factors corresponding to it in the sky reach such a situation as to represent the facts concerning it. This equilibrium between the mind of man and the astrological influences at the time he is stimulated to ask a question, permits the astrologer to give a correct answer to the question.

The Eights

—The sign Capricorn is general significator of station, honor, business, and government affairs; therefore the Eights, corresponding numerically to Capricorn, in their more common divinatory significance must relate to these things as applied to the department of life indicated by the suit. But in their higher application they reveal the influence of, and can be interpreted by, the eighth decanate of each zodiacal triplicity, starting with the movable signs.

The divinatory significance of the Eight of Scepters is a political appointment; its inner interpretation is EXPLORATION.

The divinatory significance of the Eight of Cups is extravagance; its inner interpretation is SELF-SACRIFICE.

The divinatory significance of the Eight of Coins is a costly law suit; its inner interpretation is FIDELITY.

The divinatory significance of the Eight of Swords is loss of honor, or business failure; its inner interpretation is EXPERIENCE.

The Magic Seven Spread

—Ten completes a cycle, but seven completes a form. Common divination is concerned with external life, hence with form, the problems of which are readily solved by the application of the Seal of Seven, or Solomon's Seal, as it is commonly called.

This Seal is an astrological chart in abstract; for the sum of the angles of the two triangles equals 360 degrees, measuring exactly, but in a more concrete form, the number of degrees in a circle. The six external points of the star, together with the point in the center, express the planetary septenary in terms of Jod-He-Vau-He, both above and below, the final He, or product, being common to both and occupying the center of the star.

To use this magical figure as a tarot spread, first, as usual, clearly formulate the information sought and keep it constantly in mind while shuffling and cutting the cards. Then deal them face downward, one by one, on the points of an imaginary six-point star, in the order shown in the diagram on page 100, the seventh card taking the center.

Turn the cards over one at a time, and read as turned.

The first card dealt, the upper Jod, signifies the past of the matter inquired about. It is the Cause of the present condition.

The second card dealt, the upper He, represents the present of the thing inquired about. It is the effect of past causes already indicated.

The third card dealt, the upper Vau, signifies the past and present united. It represents the immediate future of the matter.

The fourth card dealt, the lower Jod, represents the power of the individual to control the matter. It is also the influence of those favorable to it to control the matter through initiative and effort.

The fifth card dealt, the lower He, designates the part that fate and environment will play in the matter.

The sixth card dealt, the lower Vau, shows the combination of fate and individuals in the future taking the form of opposition to the venture.

The seventh card dealt, the final He, corresponding to the seventh seal of the Apocalypse, reveals all the factors of past and future after they have undergone gestation and given birth to the final issue. It, therefore, represents the result of the thing asked about.

At the front of this booklet both Hebrew characters and planetary symbols are added to the figure to assist those studiously inclined to discern the astral and kabalistical meaning of the seal, and the method used in divination. These additional characters need not be considered by those interested in divination only. The question asked may embrace any phase or activity of life, and thus the application of this method in divination is universal.

Chapter 7

Serial No. 27
Original Copyright 1936
Elbert Benjamine

Copyright
Church of Light
August 2002

Influence of Changing a Name

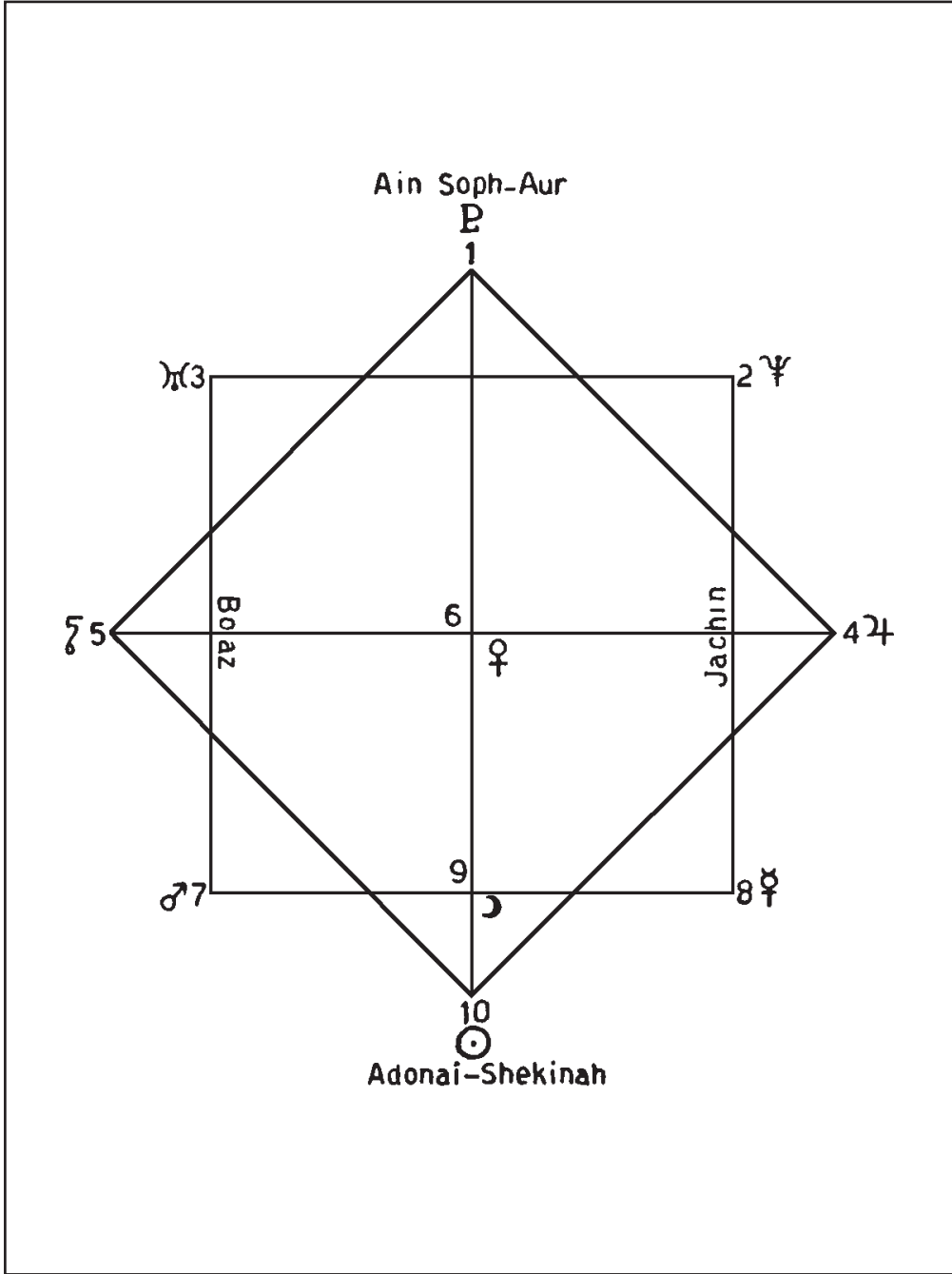

Spread of the Kabala

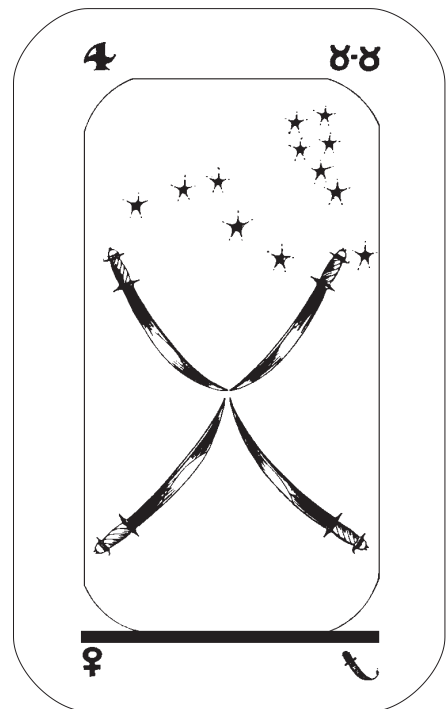
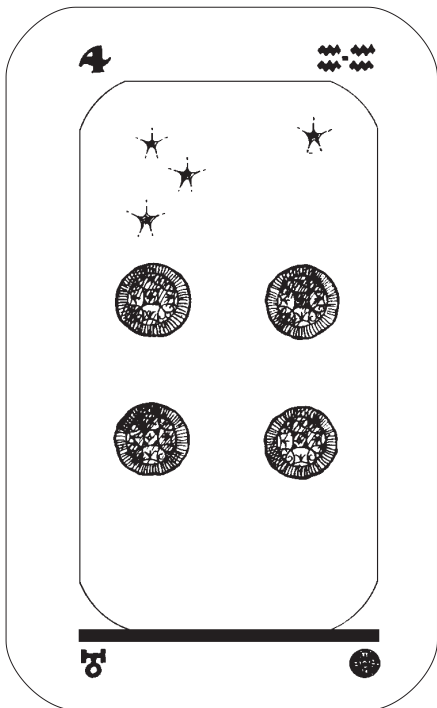
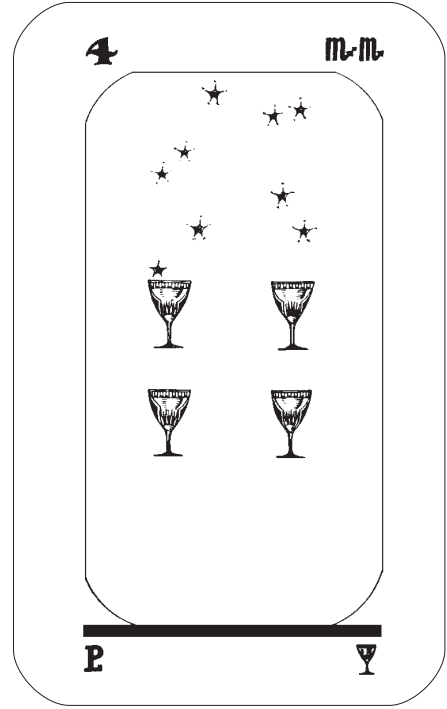
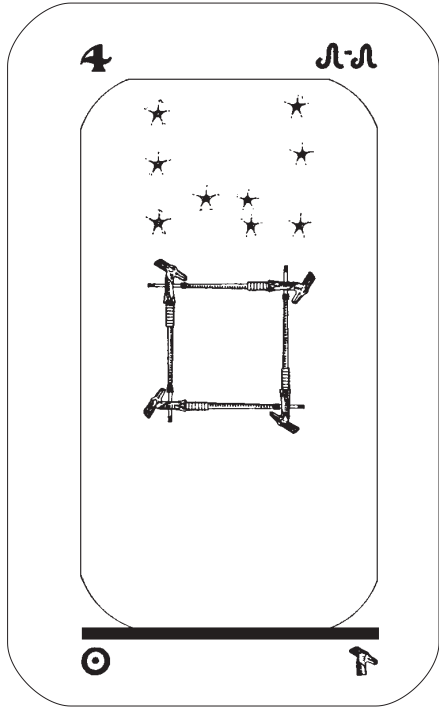

Chapter 7

Influence of Changing the Name



THE USE of the name as a divinatory instrument is the use to which it is put in the various systems of numerology. And because divination may be approached from so many angles and yet give good results it does not follow that any of the different systems of numerology in use are valueless. The method we have found to give the best results is set forth in the next chapter.

But the use of the name as a vibratory influence that affects the individual wearing it in a particular way is not related to divination. Nor can there be more than one interpretation which is correct, of the vibratory force exerted by a particular name as affecting a given individual. The vibration of a name, or of a number, is a positive thought-force of a definite quality; as much so as that light-vibrations of a certain frequency give rise to the color blue. You can not correctly call blue red, yellow, green or some other color. Such is the difference between the system I am now explaining and numerology.

A name has a definite thought-vibration quality which is radiated to the individual by everyone who thinks of him by that name. If different people think of him by different names, they thus bombard him with different types of thought-vibration. But because an individual usually thinks of himself by the name he customarily uses as his signature, and because the thought-vibrations of the person wearing the name probably have more influence upon him than the combined thought-vibration of all others who think about him, the way an individual signs his name becomes very important as a vibratory influence in his life.

If such a signature were something unalterable this would be an interesting but not very useful fact. But as a matter of observation, it is quite common for people in all walks of life to use a different signature at different periods in the life: using an initial instead of a given name, dropping the use of a middle name or initial, or even changing the spelling of the name. A woman when she marries, and therefore coincident with a marked change in her fortune, commonly changes her name. Others, also, who change the spelling of their name, or alter the signature, are discerned to change in fortune coincidentally. A change in name is nearly always accompanied by a change in the life.

Writers quite commonly use a pen name, and actors, more frequently than not, use a stage or screen name. And these names by which they are known to the public not only influences them according to the key of the name, but also from a divinatory standpoint often markedly differentiates their public life from the private life in which they are known by another name.

The practical application of the knowledge of thought-vibrations, character-vibrations and astrological-vibrations is in selecting those invisible influences which assist to bring into the life the things which are desired, and which prevent attracting events and conditions which are undesirable.

The Positive, Scientific Method

—Yet one can not know, by a positive method, what types of astral vibrations will prove beneficial and what types detrimental, and in what way this benefit or detriment will manifest, without a map of the astral body, such as is furnished by the astrological birth-chart. But with the astrological birth-chart at hand, it can at once be seen just what the effect will be upon the life of stimulating into unusual activity any particular section of the astral body, or any particular center of energy in the astral body. Even the connecting aeriels, or aspects, between such centers of energy are there clearly shown, so that the effect upon other departments of life through secondary influences can also be determined in advance.

A scrutiny of an astrological birth-chart will reveal to anyone who has even a slight acquaintance with astrology just what zone of the astral body, or what thought structure, it is advisable to give added force. If the individual wishes to attract favorable conditions in some special line, a glance at the birthchart will reveal what influence there shown most pronouncedly is beneficial to it. Then by stimulating this influence, by using a name having the same key-tone, and by having things in the environment which radiate the same key-tone, the activities of this favorable influence can be built up in a manner that will markedly attract the condition desired into the life.

The changing of the name, it will thus be seen, if the change causes the name to vibrate to a different key, adds the thought- energy of all those who think of this name in connection with the individual, to some different section or center in the astral body, and this causes a change in the fortune commensurate to the transfer of energy thus effected.

Unless the individual wishes especially to stimulate some one thing in his life in a favorable manner, the best plan in selecting a name or the objects and people of the environment, is first to find what influences in the birth-chart are more fortunate. This can be determined in a general way by inspecting the house positions and aspects of the planets. But by calculating the harmodynes and discordynes of the chart the relative harmony and discord of each planet and sign can be precisely determined.

It may be desirable to give the added intensity to a section of the astral body not occupied by a planet because the department of life it rules may be deemed more important. When this is the case, the favor or disfavor that may be expected from such stimulation is determined by the harmony of the planet ruling the sign governing the zone thus selected. The common thought-cells of the astral body are mapped by the signs, and the dynamic thought-cells by the planets. The power and harmony or discord of an unoccupied sign is one-half that of the planet ruling the sign.

In seeking the influence that will conduce most to the general good fortune the best planet and the best sign in the chart should be located. Then, if possible, the name should be spelled, abbreviated, or otherwise altered, so as to have the same key as the best planet or best zodiacal sign. If a sign is occupied by a planet, or planets, accentuating the sign also accentuates the planet, or planets, in the sign. As a planet has twice as much influence as the unoccupied sign it rules, the harmony or discord of a planet, or planets, in a sign may be more important than the harmony or discord of the planet ruling the sign elsewhere located. Thus in selecting the best zodiacal sign, the harmony or discord of any planet, or planets, in it must be given due consideration.

Usually without much alteration a name may be given such spelling or abbreviation as to cause it to vibrate to the key which has been selected as most desirable. A long name, however, can not vibrate to Key 1, and thus accentuate the influence of Mercury in the astral body; for to get this key the number of the name must be either 1 or 100. A name vibrating either to the number 99 or the number 198 gives key 18; but to get key 19 the number of the name must be either 19, which is low, or not less than 199, which is quite high for the ordinary run of names.

Yet when it is desired to get a special type of vibratory key in the name—for there is no number above 21 which gives key 21 until 399 is reached, and thus it is impractical to accentuate the Sun thought-cells in the astral body through using key 21—often almost the same result may be had by accentuating the sign the Sun occupies in the birth-chart. Thus if the Sun were the only planet in Virgo, the number 101—1 plus 0 plus 1 gives 2 (Virgo)—would accentuate key 2, and because the Sun thought-cells are in Virgo, it would be the influence chiefly accentuated. Of course, Mercury, as the ruler of Virgo, would be somewhat stimulated, wherever located; but the most pronounced influence would be the energy thus added to the Sun structure.

To illustrate by a personal example: When the author was selected to write the various lessons and other publications issued by The Brotherhood of Light, he felt it advisable to use a distinct name for these publications that would indicate that whatever appeared under this name had the sanction of The Brotherhood of Light, and was, therefore, in this respect authoritative.

In addition to his occult interests he is also a naturalist, writing and lecturing on natural history subjects. He also has, as does everyone, a private life. And while it is unlikely that any of his private opinions would differ from those of The Brotherhood

of Light, he did not wish to carry the responsibility of having any chance utterance he might make in an unguarded moment quoted as a Brotherhood of Light doctrine. So he decided he would select a pen name, that whatever appeared under that name should have the weight and careful thought of a Brotherhood of Light teaching; and that he would retain the name Elbert Benjamine for business purposes and for such writings as he did on other than occult subjects.

Now as he had entered into an agreement with The Brotherhood of Light to write a series of courses of lessons, each of the 21 occult sciences to be treated in a separate course, and ultimately to be published as a separate book, he felt that the chief requisite of the name should be to stimulate the tendency and ability to study and write about occult subjects. The announcement of the titles of these 21 courses to be written was made in the Declaration of Principles published early in May, 1915.

In his birth-chart the author has the sign Aquarius on the cusp of the third house, the house of writing. Its ruler, Uranus, is the most elevated planet in the chart. The aspects it receives are not all beneficial; but some of them are strongly harmonious, and those that are not, tend to attract just such discords as any person must attract who ventures to write and publish ideas that are as yet unaccepted by the vast majority of the race. So to give an impetus both to writing and to the acquisition of occult knowledge (for Uranus as ruler of Aquarius governs occultism) he decided that the chief thing to add energy to was the zone of his astral body ruled by Aquarius. The name, therefore, must vibrate to key 9.

Because the ability to gain information from the inner planes is chiefly ruled by the planet Neptune, and because it is the best planet in his birth-chart, it was thought advisable also to accentuate key 11. This could be done, although only in a minor degree, by using the initial C.

There were other considerations also of a symbolic nature. Zain (or Z) is the seventh letter of the Egyptian alphabet, and not only means victory, but corresponds to the sign Sagittarius, which is the natural ruler of the house of religion. And the writing and work to be accomplished was of a religious character; the re-establishment of The Religion of The Stars. Z also is a very peculiar letter, representing two 7's, one above and one below. Also 7 is an open trine, indicating giving out rather than receiving; and it was the author's purpose in issuing The Brotherhood of Light lessons to give as wide dissemination, both to material facts and to spiritual doctrines, as possible.

Furthermore, the author is a double Sagittarian; that is, he has Sagittarius both for a rising sign and for a Sun sign. So that not only were the vibratory ends sought gained by the use of C. C. Zain as a pen name—C-11, C-11, Z-7, A-1, I-10, N-14: 11 plus 11 plus 7 plus 1 plus 10 plus 14 gives 54; 5 plus 4 gives key 9 adding energy to the section of the astral body ruled by Aquarius—but it is an accurate translation of the strongest influences in his birth-chart into letters combined in a name. Whoever, therefore can read this name aright, can know the source from which these writings

come, the motives prompting their expression, the method by which the information they contain was gained, and much about the inner life of the author.

The name in full, given as a tarot chart is—IX—XI—XI—VII—I—X—XIV—VI. This may be read as Wisdom (9), and early Spiritual Power (11), followed by Psychic Strength (11), leading to Victory (7) over obstacles. Will and Intelligence (1), after a time dictate a Change of Fortune (10) and this brings Regeneration (14) and still other Trials (6).

Changing a Name

—At first thought it may seem that using a name in business other than that conferred at birth is exceptional other than in a few professions. But a little reflection will indicate that most people in business abbreviate, or otherwise alter the name, in using it as a signature.

And because people become familiar with this signature, it becomes more strongly associated in their minds with the person using it than any other name. The person signing himself in a given way, because he writes his name thus, and both makes and sees the signature, comes to think of himself according to the signature as written. And the name by which an individual thinks of himself, because his own thoughts are more powerful to influence his life than the thoughts of others, is commonly the most important name of all.

Therefore, because the business signature determines the thought-vibrations sent him by those who see this signature, and the thought-vibrations which he generates when he thinks of himself by name, it should be selected with an end in view of stimulating some department of life as desired, in a favorable manner. This is done by selecting for a business signature a name the vibratory key of which corresponds to the sign or planet in the birth-chart most favorable to the department of life it is wished to strengthen.

The Sage—Arcanum IX

—Letter: Egyptian, Thela; Hebrew, Teth; English, Th. Number, 9. Astrologically, the zodiacal sign Aquarius. Color, the lighter shades of blue. Tone, high G. Occult science, mental alchemy. Human function, clairaudience. Natural remedy, such herbs as myrrh, frankincense and spikenard. Mineral, the talismanic gem, sky-blue sapphire, and such stones as obsidian and black pearl.

Th—9, expresses in the spiritual world, absolute wisdom.

In the intellectual world, prudence, director of the will.

In the physical world, circumspection, guide of actions.

Remember, then, son of earth, prudence is the armor of the wise. Circumspection enables one to avoid snares and abysses and to foresee treason. Take it for thy guide in all thy actions, even in the least. Nothing is indifferent here below. A pebble can overturn the chariot of the master of the world. If Arcanum IX should appear in the prophetic signs of thy horoscope, keep in mind that speech is silver and silence is gold.

In Divination, **Arcanum IX** may briefly be read as **Wisdom** or **Prudence**.

Arcanum IX is figured by an old wanderer leaning on a staff and carrying before him a lighted lamp which he half conceals behind his mantle. This sage personifies experience gained in the journey of life. The cloak is of square form, symbolizing the physical world in which man may acquire knowledge of good and evil. That this knowledge has been gained is signified by the man having partially removed the cloak of material limitations, and by the lamp, emblem of intelligence, shedding its rays over the past, present and future. The lamp being concealed by the mantle symbolizes discretion, and also expresses the truth that if we are ever to know the real nature of anything we must delve deep beneath the cloak of external appearances.

The staff, which in form is the sixth letter of the Egyptian and Hebrew alphabets, indicates that man progresses through struggle, alternately overcoming obstacles and being vanquished by them, and that when finally he realizes he only develops his abilities through recurrent efforts to triumph over difficulties, this knowledge becomes his staff of prudence supporting him in all his endeavors.

Number

—Nine is the Deific number, the highest digit, which possesses the unique property that it may be multiplied by any number and the digits so obtained when added together always resolve into 9. On the inner-plane, where thought-vibrations and astral-vibrations of all kinds become effective, 9 is the perfect scale, even as 7 is the perfect scale of physical form. Such vibratory rates, consequently, are measured by decaves instead of by octaves.

As the multiples of 9 resolve, when their digits are added, into 9, it is the symbol of manifested Deity whose different manifestations may all be reduced to the one primal source. It is the figure unlocking the cycles of the ancients, and as composed of 3 times 3 indicates action on all three planes. As composed of 4 plus 5 it represents man realizing all earth can teach, and thus is the number of wisdom. As consisting of 7 and 2 it adds polarity, intuition and wisdom, to the union of man and woman, giving knowledge of good and evil, or wisdom gained through union. As 8 and 1 it is death, mortality and stagnation overcome by will and intelligence; hence new action, life, immortality.

Astrology

—The zodiacal sign of the Sun, Leo, is represented by the symbol of a serpent. This serpent, natural ruler of the fifth house of a birth-chart, and thus of pleasures and love-affairs, is the symbol of desire.

And while the Man of the zodiac, Aquarius, is represented commonly by the two wavy lines representing water from the urn, these wavy lines were also depicted in ancient times as two serpents, or two desires, one traveling in either direction. Desires thus kept in equilibrium through knowledge gained in experience with good and evil are true wisdom. Hence the serpent is sometimes referred to as the tempter and sometimes as the essence of wisdom. Math. 10:16; “Be ye therefore wise as serpents and harmless as doves.”

This is a clear statement of the import of Arcanum IX. The love nature is signified by doves, which are sacred to Venus; and the power of Aquarius to properly direct the love nature is indicated by the reference to wisdom. Aquarius astrologically represents the highest form of intelligence, expressing progressively in scientific and occult interests, such as are depicted in the arcanum of the Sage.

Human Function

—The highest wisdom, such as symbolized by the Sage, comes both from within and from without. Experience with good and evil is garnered in the external world and stored together with the experiences garnered in the interior realms. The two sources of knowledge are thus symbolized by the two wavy lines, anciently also depicted as two serpents. The Sage thus not only has listened to the teachers in the external world, but he has also been guided by those speaking from the inner plane; and to hear them he has developed the faculty of clairaudience, which thus corresponds to Arcanum IX.

Alchemy

—In alchemical processes of any kind, danger is sure to be present if the conditions are forced. Transmutations, for instance, can not be made to take place instantly. They require time. To try to alter a condition too quickly is apt to result in an explosion. Whatever energies are present must be taken care of through gradually diverting them into those channels which will promote the object sought. More failure in alchemical work results from undue haste and impatience for results than from any other cause. The prudence which alone enables the alchemist to be successful in his endeavors is depicted by Arcanum IX.

Bible

—In the Bible we find that the tempting serpent of desire denied the word of God that man would die when he should eat of the forbidden fruit.

“For God doth know that in the day ye eat thereof, then your eyes shall be opened; and ye shall be as gods, knowing good and evil.” (Gen. 3:4).

But it is true that when spirit descended into matter it died to its celestial nature and was no longer pure and innocent. Yet through yielding to Temptation (Arcanum VI) and entering into material incarnation, the words of the serpent also were verified: Gen. 3:7; “And the eyes of them both were opened, and they knew that they were naked, and they sewed fig leaves together, and made themselves aprons.”

That is, after partaking of the Tree of Good and Evil they gained knowledge and immediately put forth an effort to overcome matter and Triumph over circumstances, as indicated by Arcanum VII.

After the Judgment (Arcanum VIII) of the transgression—8 expressing crystallization—we learn: “Unto Adam, also, and to his wife, did the Lord God make coats of skins and clothed them.” In other words, they had spiritual bodies while living in the realm of spirit, but upon descending to the material plane they were clothed with physical bodies. The result of incarnation through the various lower life-forms is symbolized by coats of skins, verifying the wisdom of the serpent, and in the final result being depicted by Arcanum IX. Gen. 3:22; “And the Lord God said, behold, the man is become as one of us, to know good and evil.”

Still another reference to Arcanum IX is Solomon’s choice of Wisdom instead of worldly goods.

Masonry

—The Select Master degree of Masonry is founded upon Arcanum IX. It signifies the ninth arch of the secret vault of Solomon’s Temple, where are stored exact copies of all that is contained in the sanctum sanctorum above. It is what might be called the lowest degree of adeptship on the physical plane, being the Intellectual degree in which man has recognized the correspondence between the heaven above and his soul. Arcanum IX corresponds also to the three triangular tables arranged in a row with a triangular plate of gold in the center of each and a lighted candle at each corner. It corresponds likewise to the three times three of the ritual.

Magic

—In Magic, Arcanum IX corresponds to the various magical methods of obtaining information about occult subjects.

In such endeavors there are two chief methods which are followed. One is to leave the physical body and travel in the astral form. Through this process it is possible to visit the homes of the dead, to sit at the feet of the wise in the Halls of Learning on the astral plane, and to gather information through personal contact and observation, while the physical body slumbers on earth.

The other method, which is beset with far fewer dangers, is to tune in on the plane from which it is thus desired to gain information. In this tuning in process the proper astrological conditions are usually observed, and often it is assisted by an appropriate ceremony.

Initiation

—In the soul's pilgrimage, Arcanum IX indicates the attainment of cosmic consciousness.

Upon arriving at this state of his upward ascent the neophyte is able to discern the proper relations of the various entities in the universe, both to himself, and to each other. This is not merely an intellectual conception, but is borne home to him also through tuning in on the universal organism. He recognizes that each soul is being trained to perform a work which the expansion of the cosmic organization makes needful.

As a result of this higher state of consciousness he comes to recognize quite clearly the nature of his own function in universal work, and thus sets about his task with the knowledge that he is a valuable factor in the scheme of things, with a certain and definite mission to perform. And upon his faithfulness in performing what he comes to recognize as his present task in contributing to cosmic welfare, depends his future opportunities for progression.

Quite important in arriving at this higher state of consciousness, wherein he perceives his cosmic work, is the development of his affectional relations. That is, the power to tune in on either higher or lower states is chiefly regulated by the emotions. Passion and gross expression, therefore, must be supplanted by more exalted expressions of love. That which is gross and degrading tends to tune the mind in on lower states. But acts which engender strong emotions of tenderness, and kindly feelings that are so expansive as to embrace all, and which uplift the energies in intense desire for noble work, are the most effective agents known to tune the individual in on higher realms and to develop cosmic consciousness.

Cosmic elementals—sylphs, salamanders, undines and gnomes—as well as magnetic elementals such as fauns, elves, nymphs and fairies, have relation to man; but they are not dependent upon him for intellectual and spiritual force, as are the so-called degrees of life. Yet his thoughts and desires do arouse them into activity, and may enlist them in the performance of such work as is within their special province. His proper relation to all such life-forms, and the work he should do aiding cosmic progression, are revealed to him when he attains cosmic consciousness.

Occult Science

—Mental alchemy treats of the mental factors and how they may be made most effective to attract into the life just the conditions required. The process consists largely in transmuting discord into harmony and in providing the proper flux to annul undesirable conditions.

Under Arcanum V we found that four signs express the absolute and are in turn explained by a fifth. And now, rather paradoxically, we find that 9 symbolizes the absolute in expression. But if we use the lamp of the Sage to look beneath the surface of this apparent contradiction, we find that 5, or intelligent man must have a medium through which to express; a place in which to move and work, as signified by the square mantle of the Sage. This universal medium, of course, is symbolized by the number 4. Thus Arcanum IX sheds much light upon how mantrams, suggestions and the processes of mental-alchemy bring about their results.

For those with a penchant for symbolism to add further light upon their researches, this whole subject will be given clarity through a study of the diagram, page 19 of chapter 1. The square marked 1 should be colored yellow; 3 should be colored green; 5 should be colored purple; 7 should be colored red, and 9 should be colored violet. These are the five odd, or active, numbers. The colors yellow and red signify power (love) and motion (life).

However, activity must take place in a medium, which is represented by the four squares marked with even numbers, which should be colored the other primary, blue. Then the squares 5 and 3 represent the reaction of yellow and red on blue, and as stated are purple and green. And the central square, representing the highest vibration, the evolution of all below, should be colored violet.

Finally, the border around the whole figure, the solar combination of power and activity, should be colored orange.

The Nines

—The sign Aquarius is general significator of friends, associates, hopes and wishes; therefore the nines in their more common divinatory significance must relate to one of these things, according to the particular department of life signified by the suit. But in their higher application they reveal the influence of, and can be interpreted by, the ninth decanate of each zodiacal triplicity, starting the count from the movable signs.

The divinatory significance of the Nine of Scepters is a wise and profitable friendship; its inner interpretation is ILLUMINATION.

The divinatory significance of the Nine of Cups is that the hopes will be realized; it is the WISH-CARD; its inner interpretation is VICISSITUDES.

The divinatory significance of the Nine of Coins is money spent on associates; its inner interpretation is REASON.

The divinatory significance of the Nine of Swords is a quarrel resulting in enmity; its inner interpretation is RENUNCIATION.

The Wheel—Arcanum X

—Letter: Egyptian, Iothi; Hebrew, Jod; English, I—J—Y. Number, 10. Astrologically, the planet Uranus. Color, dazzling white, like snow in the sunshine. Tone, the astral chimes. Occult science, natal astrology. Human function, intuition. Natural remedy, electricity and mesmerism. Mineral, uranium.

I—10, expresses in the spiritual world, the active principle which vivifies all being.

In the intellectual world, the governing authority.

In the physical world, good and evil fortune.

Remember, then, son of earth, that for power thou must will, that is, will strongly; thou must dare, and to dare with success thou shouldst know how to be silent until the moment of action. If the Wheel should appear in the prophetic signs of thy horoscope, know that to possess the Key of Power you must learn to will persistently only for what is good and true. And in order to maintain thyself upon the heights of life, shouldst thou reach them, thou must have learned how to sound with a look, and without dizziness, the vastest depths.

In Divination, **Arcanum X** may be read as **Change of Fortune**.

Arcanum X is figured by a wheel of eight spokes suspended by its axis upon a dual column. At the right Hernanubis, genius of good, strives to mount to the summit of the circumference. At the left, Typhon, genius of evil, is precipitated. On a circular platform in equilibrium on the Wheel, is poised a sphinx, holding in its claws a javelin. At the foot of the dual column two serpents raise their heads.

This is the wheel of destiny. The circular platform upon which the sphinx stands represents the zodiac; and the sphinx, as a composite of the four constellations marking the zodiacal quadrants—Eagle, Lion, Man and Bull—signifies the passage of time.

It holds a javelin in its claws to indicate that time is always fructifying events and ever ready to strike to right or left as the wheel turns under its impulsion, raising the humble and lowering the proud.

The eight spokes of the wheel, eight being the number of justice, symbolize that time and opportunity, in the course of divine providence, are justly meted out to all. The dual column supporting the wheel indicates that all nature is polarized into positive and negative. The serpents signify that the law of all action is that of sex.

Number

—The number 10 represents the completed cycle, and therefore the starting point of another. It thus indicates transition to a new phase, or plane, of existence.

The absolute having expressed itself through all the various manifestations up to and including 9, which signifies perfection of consciousness in addition to perfection of form, commences a new gamut. 1 is the absolute unmanifest, and 9 is the perfection of its manifestation.

In humanity, as composed of two 5s, 10 indicates the whole man to consist of both man and woman, and that their union commences a new and higher phase of existence; that is, that it enables them to contact a higher plane of endeavor. 1 symbolizes will and intelligence, and 10 shows that they are now used by both in a new and higher field of endeavor.

Astrology

—Uranus is the octave expression of Mercury, even as Arcanum X is the second decade of Arcanum I, ruled by Mercury. The unsexed quality of Uranus is depicted in Arcanum X by the two serpents in equilibrium.

Uranus transits one sign of the zodiac in about 7 years, and the whole zodiac, completing the circle through the 12 houses of a horoscope, in about 84 years. That is, it corresponds to perfection of form in each department of life, its complete cycle coinciding with the present natural life of man. More than any other planet it gives sudden changes of fortune, either for good or for evil, and sudden change of the mental viewpoint.

Human Function

—In natal astrology it is found that those individuals who have Uranus prominent in their birth-charts have the ability to short-cut their reasoning. Instead of the ordinary slow mental process of the objective mind, the processes are carried out by the unconscious mind which has more complete data at its disposal, and which acts almost instantly in drawing conclusions from them. These conclusions thus arrived at then rise into the objective consciousness as intuition.

Alchemy

—No matter what the plane of alchemical procedure, it is a decided aid to observe the astrological conditions which are operative at the time. The energies of the planets have an influence upon all processes, and it is easier to perform a given type of work when the astrological influences favor it. Of course, alchemical work of many kinds can not await favorable conditions. But the knowledge that astrological influences

are hindering at certain times, both incites to more careful and energetic effort and prevents discouragement when it is observed that small progress is being made.

Bible

—Arcanum X depicts the Wheel of Ezekiel. Ezek. 1:15; “Now, as I beheld the living creatures, behold, one wheel upon the earth by the living creatures, with his four faces.” These faces were the composite symbols embraced in the sphinx; the Lion, the Eagle, the Man and the Bull.

The geni on the wheel of Arcanum X are mentioned thus: Ezek. 1:13; “As for the likeness of the living creatures, their appearance was like burning coals of fire, and like the appearance of lamps: it went up and down amid the living creatures: and the fire was bright and out of the fire went lightning.”

The change in the fortune of Solomon also has to do with Arcanum X. I Kings, 2:3; “And he had seven hundred wives, princesses, and three hundred concubines; and his wives turned away his heart.”

Masonry

—The Super Excellent Master degree of Masonry is based upon Arcanum X. Its ritual depicts the fate of Zedekiah, who did evil in the sight of the Lord, and underwent a sudden and extreme change of fortune.

Magic

—In magic, Arcanum X represents the orbit of action of the blessing and cursing energy of the human soul. This orbit is elliptical, with a periodic action of its own, sure to react upon the individual; for to cause a condition in another one must create within himself the matrix of that condition.

It is quite useless to fight a discordant emotion or a discordant thought sent to one by another. To fight it merely draws the attention to it and thus tunes in on its vibrations and enables them to gain a still greater potency. Thinking about either a harmony or a discord adds energy to it and gives it more force.

Whether it be events, the thoughts and emanations of people who think discordantly but without malice, or the actual malicious attempt to injure one by black magic; in all cases anxious attention feeds the undesirable condition. And except to recognize that it has an existence and should be thwarted, the discord and its source should be ignored. And in addition to this judicious indifference, the attention should be given as enthusiastically as possible to something harmonious. A discordant vibration can not live in the same place as a harmonious vibration.

Initiation

—As the soul progresses up the spiral ascending way of attainment, it gradually refines its organism to the end of living a richer life. On both planes, however, there is always the impact of environment; and some of the conditions contacted are sure to be discordant.

If, therefore, the life-form occupied by the soul becomes sensitive without at the same time developing the power of control there may be actual danger. No matter how sensitive it becomes, so long as the soul has the power to direct the thoughts and attention, no other entity can gain control of the organism or do it injury from the inner plane. But if sensitiveness becomes greater than the power of control, other entities or discordant conditions are able to hold the attention and can cause the individual to suffer.

Yet as abilities are developed only through the effort to overcome such obstacles as are shown by progressed afflictions in the birth-chart, at the state of progress here considered, astrological afflictions are viewed as opportunities to develop ability, and astrological harmonies are viewed as opportunities to use the abilities thus developed in assisting universal progression.

Occult Science

—Natal astrology is the science of discerning the character from a map of the mental factors within the astral body as pictured by the birth-chart; and of determining when certain events will have a tendency to be attracted due to the stimulation of these mental factors by energies from the planets.

Here also should be mentioned the doctrine of the Ten Emanations of the Sephiroth. The kabalistical scheme of three pillars is given in most works on the kabala, but someone a hundred or more years ago inserted a blind by placing Hod on the left and Netzach on the right, knowing that real intimates would discern that Netzach is the victory of woman. Yet this error has been copied by kabalistical writers ever since.

The correct astrological correspondences of each emanation has not been placed in writing before, but the chart on page 132 of chapter 6 gives the emanations in proper sequence and relations.

Above all is the Limitless Light, Ain-Soph-Aur (1). Pluto, is Kether, or Crown, the point of differentiation, where soul-mates separate and where ultimately they must again rejoin. (2) Neptune is Chocmah, or Wisdom. (3) Uranus is Binah, or Intelligence. (4) Jupiter is Chesed, or Mercy. (5) Saturn is Geburah, or Justice. (6) Venus is Tippereth, or Beauty. (7) Mars is Netzach, or Victory. (8) Mercury is Hod, or Splendor. (9) Moon is Yesod, or Foundation. (10) Sun is Malkuth, or Kingdom. And below all is the region of Adonai—Shekinah.

Benefic planets, of course, are on the tree of good, and malefic planets on the tree of evil, while Pluto, Venus, Moon and Sun form the Shekinah, or Tree of Life.

The upper story of the diagram is Atziluth, or Emanation; the next lower is Briah, or Creation; below this is Yetzirah, or Formation; and the lowest of all is Assiah, the realm of Action.

Of course, the river that waters the garden of Eden and parts into four heads is the planet Venus in the diagram and the four lines radiating from it. Each of the 10 emanations manifests in all four kingdoms, and the 12 triangles of the circumference are the 12 houses of a birth-chart; the 32 lines in the circumference representing the paths of wisdom.

The ten emanations operating through the four kingdoms, or suit cards of the tarot, are expressed in verse by Mr. A. E. Waite admirably, thus:

Four signs present the Name of every name. Four brilliant beams adorn his Crown of flame. Four rivers from his Wisdom flow. Four proofs from his Intelligence we know. Four benefactions from his Mercy come. Four times four sins avenged his Justice sum. Four rays unclouded make his Beauty known. Four times his Conquest shall in song be shown. Four times he Triumphs on the timeless plane. Foundations four his great white throne maintain. One fourfold Kingdom owns his endless sway. As from his crown there streams a fourfold ray.

The Tens

—The planet Uranus is general significator of uncommon pursuits, of sudden changes of fortune, of inventions, discoveries, and of unconventional relations and actions; therefore the tens in their more common divinatory significance must relate, according to their suit, to one of these things. But in their higher application they reveal the influence of, and can be interpreted by, the zodiacal triplicities.

The divinatory significance of the Ten of Scepters is an invention or discovery; its inner interpretation is ENTHUSIASM.

The divinatory significance of the Ten of Cups is a decidedly unconventional affectional interest; its inner interpretation is EMOTION.

The divinatory significance of the Ten of Coins is alternate financial loss and gain; its inner interpretation is ASPIRATION.

The divinatory significance of the Ten of Swords is sudden loss of employment; its inner interpretation is PRACTICALITY.

Spread of the Kabala

—When the influence and outcome of anything is sought, the cards may be dealt on a diagram similar to the one on page 120, one after the other, until 10 cards are laid out according to the sequence there indicated.

The cards of the Tree of Good are on the right, and indicate favorable events. The cards of the Tree of Evil are on the left, and indicate unfavorable events. The four cards in the middle are on the Tree of Life, and represent the outcome.

Card 1 signifies the spiritual result, and card 10 the material result. 6 is the result concerning life and love, and 9 the result as affecting the home. The cause of the influence exerted by each card is signified by its kabalistical name. Thus if on 2, Wisdom is the cause; if on 3, Intelligence is behind it; if on 4, Mercy has an influence; if on 5, there is a desire for Justice. 6 indicates love of Beauty, 7 desire for Victory, 8 Splendor and show, 9 home conditions, and 10 physical power as distinct from spiritual aspirations signified by 1.

Chapter 8

Serial No. 28
Original Copyright 1936
Elbert Benjamine

Copyright
Church of Light
August 2002

Reading Names in Detail

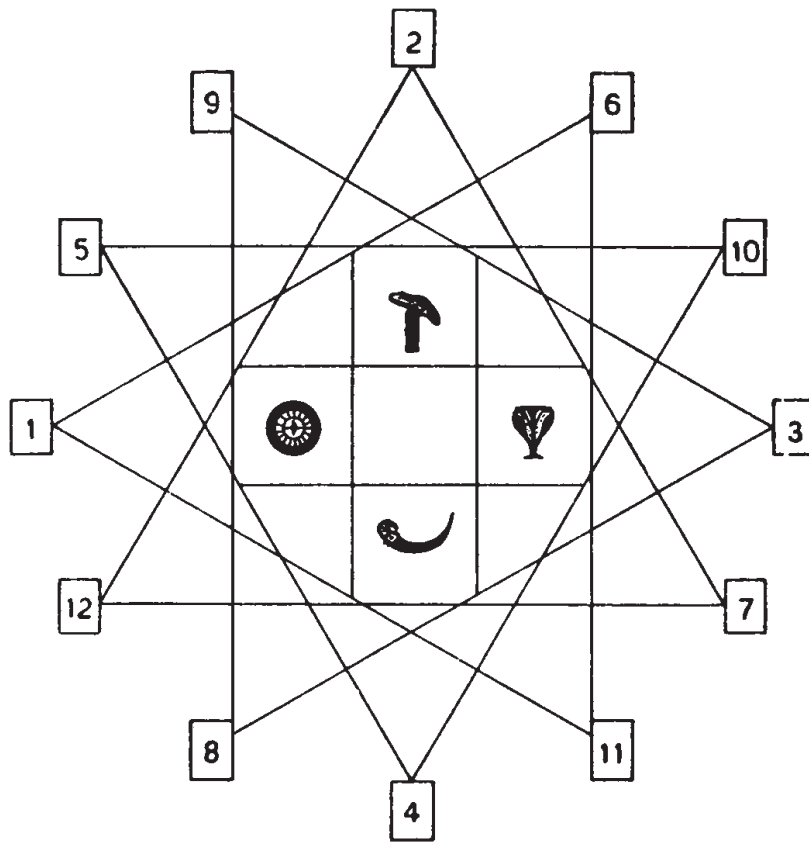

THE HOROSCOPE SPREAD

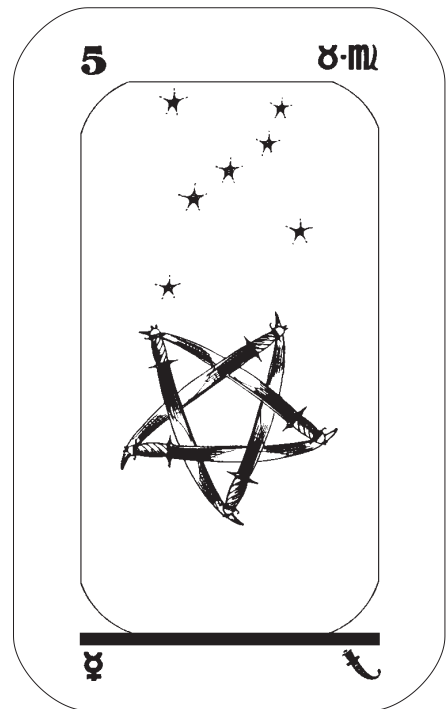
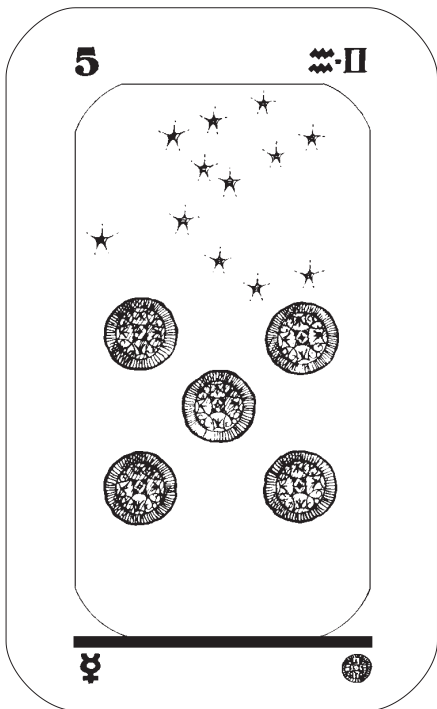
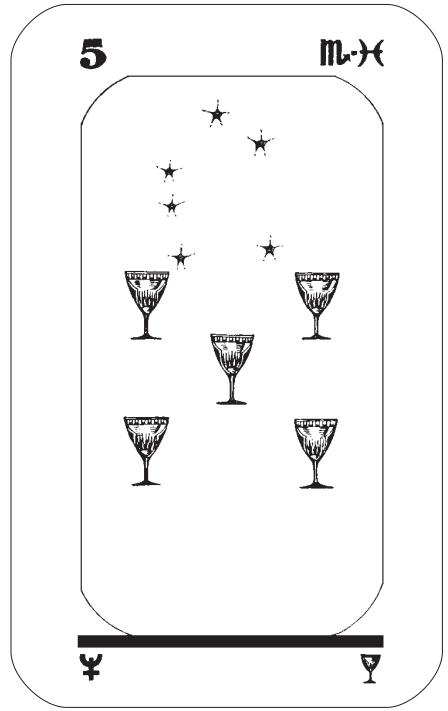
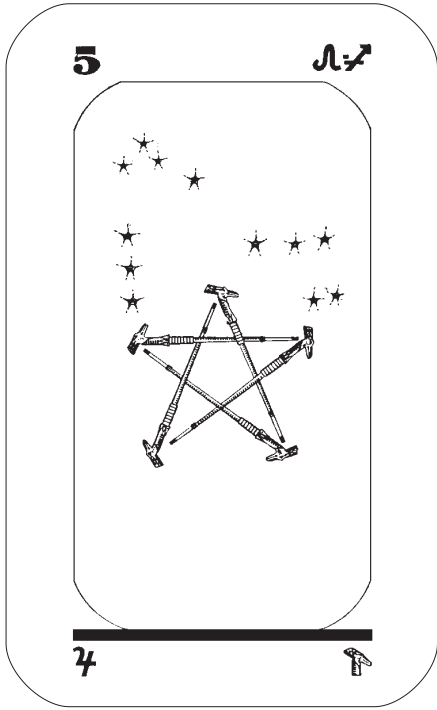

Chapter 8

Reading Names in Detail

ECAUSE the name John Brown when present in any person's mind always radiates the same component thought vibrations, and always reverberates to the same vibratory key, it is easy to map the influences of this name in a positive and scientific manner. And by substituting the divinatory significance of each numerical factor, it is possible to give a divinatory reading of the name, as such, without reference to any particular person.

But such a divinatory reading is a delineation of the name only, and should not be expected to reveal much concerning the life of any particular John Brown. Quite certain it is that of the thousands and thousands of John Browns throughout the world, their fortunes are markedly varied, and have no such uniformity as would be necessary if all their lives were to be represented by a single set of divinatory symbols.

When we have the astrological birth-chart of an individual we possess a positive map of his various important vibratory rates and how they are related to each other. When we have a name and find its key we possess a map of the vibratory qualities of that name. By comparing the two maps we can determine with all the exactitude of positive science how the name will influence the individual.

From the astrological birth-chart and the progressed aspects we can plot the invisible influences operative in the life of the individual at any given time, and thus have a positive way of mapping the probable events and the time they will happen, in the individual's life.

But when we do not have the birth-chart of the individual by which to determine his various vibratory rates, we have no positive method of determining how a name will affect him, and we possess no positive method of determining either the events of his life or the time they will happen.

But man is not dependent exclusively upon positive methods in the acquisition of knowledge. Reason is positive, but often intuition, which is not positive, yields information even more valuable. The physical senses are positive, but the psychic senses, under certain circumstances, are even more reliable. And while the positive method of gaining information by means of numbers is very valuable, it is not the

only method of using numbers to acquire knowledge. Numbers may also be used as divinatory instruments. All systems of numerology are purely methods of divination; and the one now to be presented is no exception. But it is the best system we have been able to find.

In order to have a constantly varying factor which provides a proper basis for the exercise of divination, it is customary to use the name of the individual, but to this name add another distinctive factor which is unique to the individual. This distinctive factor, which has come to be known as the number of the Birth Path, is merely the number which is obtained by adding crosswise the factors of the birth date as commonly expressed numerically.

Thus the number of the Birth Path of Jan. 13, 1872, is 1 (January is 1st month) plus 1 plus 3 plus 1 plus 8 plus 7 plus 2, which gives 23.

The number of the Birth Path of May 8, 1932, is 5 (May is the 5th month) plus 8 plus 1 plus 9 plus 3 plus 2, which gives 28.

The number of the Birth Path of July 4, 1776, is 7 (July is 7th month) plus 4 plus 1 plus 7 plus 7 plus 6, which gives 32.

The number of the Birth Path of December 7, 1941, is 1 plus 2 (December is 12th month) plus 7 plus 1 plus 9 plus 4 plus 1, which gives 25.

The number of the Birth Path of November 2, 1948, is 1 plus 1 (November is 11th month) plus 2 plus 1 plus 9 plus 4 plus 8, which gives 26.

The Birth Path is really the birth date, and therefore it is true that the number of the Birth Path does belong specifically to the individual; for it is a number obtained from the record of his birth; yet it must not be lost sight of that using it thus is not a method depending upon the vibratory influence of thought, but is merely a divinatory method of using the Birth Path, or date of birth, in a particular way.

Then having found the number of the Birth Path, this number is added to the number of the name, the sum giving a Divinatory Number, which affords a chart which should reveal to one whose intuitions are active, the character, the chief events of the life and the conditions surrounding the individual when life ends.

To obtain this chart the Key of the Divinatory Number is found and placed at the beginning of the chart as signifying the chief influence in the character. The Major Arcanum corresponding to this Key of the Divinatory Number is considered in the nature of symbolically representing the birth-chart of the person.

Then in the chart this is followed by a Major Arcanum substituted for each letter of the name. That is, each letter of the name, commencing with the first, is considered as a separate influence in the life. It is considered in the nature of an astrological major progression. And the nature of the event which it brings into the life is symbolized by the Major Arcanum corresponding to the letter. The first letter of the name thus

represents the influence in the life immediately following birth, the next letter an influence somewhat later, the third letter a period following this, and so on up to the end of the name.

Then the Key of the Decave of the Divinatory Number is found and placed at the end of the chart, after the Major Arcanum representing the last letter of the name. The Major Arcanum corresponding to the Key of the Decave does not so much represent a specific event, as the conditions which surround the person at the close of life. That is, it represents in a divinatory way, that which is signified by the fourth house of a birth-chart.

Abraham Lincoln was born Feb. 12, 1809.

A . . . 1	L . . 12	(Feb.) 2	
B . . . 2	I . . 10		1
R . . 20	N . . 14		2
A . . 1	C . . 11		1
H . . 8	O . . 16		8
A . . 1	L . . 12		0
M . . 13	N . . 14		9
. . . 46	. . . 89	23	Birth Path

46 plus 89 plus 23 gives 158 as the Divinatory Number. 1 plus 5 plus 8 gives 14 as the Key of the Divinatory Number.

158 minus 14 gives 144. 144 divided by 9, plus 1, gives 17 as the Key of the Decave.

14 (Key, or Character) —1—2—20—1—8—1—13—12—10—14—11—16—12—14—17
(Condition at end of life).

The numerical chart as given in the line above shows that Abraham Lincoln's character was based upon 14, or Temperance. A much more detailed description of it can be had by substituting the astrological correspondence, Taurus, which shows clearly the deep sympathy and the intense practicality of his nature.

Very early in life he began to develop himself through the application of Will in the expansion of his Intelligence (1).

Science (2) next comes under his scrutiny as a child, and exerted its full influence in his life as he ciphered on the back of a wooden shovel by the firelight.

But there was an Awakening (20) also in his early years, by which his thoughts were turned into higher channels.

And some travel (Mercury influence) which gave full material for his developing Intelligence (1).

This was followed by gaining for himself a reputation for Justice (8); for he came to be known as honest Abe.

Then further application to study and the development of his Intelligence (1); for he began to prepare himself to practice law.

And a Transformation in his affairs due to taking part in a military expedition (Aries) (13).

Then came the first great Sacrifice and sorrow (12) of his life through the loss of his beloved Ann Rutledge.

Followed by a Change of Fortune (10) as he was thrust forward into the political arena.

In which capacity his fairness and Temperance (14) in handling the issues of the day;

Lent to him a Spiritual Force (11) which swept him into the highest office in the land.

And brought to him the responsibility of that great Catastrophe (16), the Civil War.

This was an Expiation (12) of the sin of human slavery; and enabled him to set free these slaves at the Sacrifice of his own and other lives.

Then the war was ended, and he embarked upon a full program of Regeneration (14) for the country, when his own end came.

And while this end came suddenly, and violently, nevertheless, he had accomplished his work. The surroundings of his life at its end (Key of the Decave of the Divinatory Number) is well shown by 17. Truth had prevailed, Faith had been vindicated, and he left behind him a message of Hope that has continued unabated to this day.

George Washington was born Feb. 22, 1732.

. . . .	W . . 6		
. . . .	A . . 1		
. . . .	SH . . 8	(Feb.) 2	
G . . 3	I . . 10	2	
E . . 5	N . . 14	2	
O . . 16	G . . 3	1	
R . . 20	T . . 22	7	
G . . 3	O . . 16	3	
E . . 5	N . . 14	2	
. . . 52	. . 104	19	Birth Path

52 plus 104 plus 19 gives 175 as the Divinatory Number. 1 plus 7 plus 5 gives 13 as the Key of the Divinatory Number.

175 minus 13 gives 162. 162 divided by 9, plus 1, gives 19 as the Key to the Decave.

13 (Key, or Character)

—3—5—16—20—3—5—6—1—18—10—14—3—22—16—14—19
(Condition at end of life).

13 (Aries) indicates that Washington was typically a pioneer destined to bring about a Transformation by the use of the sword. A more detailed reading of the character may be had from the sign Aries.

His early life was spent in Action (3) rather than in study.

Then the influence of Law and Religion (5) played their part.

At an early age a commission as midshipman was offered to him, but his mother blocked this, which was a Catastrophe (16) to his ambitions.

The death of his brother brought him an inheritance and an Awakening (20) to new responsibilities.

Then he married (3) Mrs. Curtis, and settled at Mt. Vernon.

His life as a planter brought him into contact with the Law (5) in that he was elected repeatedly to the legislature of Virginia.

Then came a time of Trial and Temptation (6) in regard to Governor Dunmore, in which his position was always that of a radical.

His appointment to Congress in 1774 gave him opportunity for the exercise of his Will, Intelligence and Dexterity (1) for which later he became famous.

In this period, just prior to the Revolutionary War, Deception (18), subterfuge, and secret enemies were encountered on every hand.

And then, with the war, came a decided Change of Fortune (10).

When named commander-in-chief of the armed forces of the United Colonies his Temperance (14) caused him to refuse a salary, and to announce that he felt himself unfit for the command.

Then came the Action (3) of War.

But the stupidity, Foolishness (22) and impatience of his supporters during 1775 almost wrecked the enterprise.

It was a Catastrophe (16) when Benedict Arnold and his sympathizers turned against him.

But his persistence and Temperance (14) brought him through, established his fame, and placed him uncontested in the presidential chair.

From this position he later retired to his home at Mt. Vernon, to find the rural life he enjoyed so much, surrounded by his family and friends. Away from the conflicts of political quarrels, with the highest honors his country could bestow, with wealth and the affection of many, his closing years are well represented by the Key of the Decave of the Divinatory Number (19), the number of Happiness.

I believe these two illustrations will quite suffice to indicate the manner in which divination by numbers can be used to give a detailed reading of a name. The number representing the Key of the Divinatory Number should always be taken to represent the character. Then each letter of the name, in its proper sequence, should be taken to represent a period of the life, and the influence of this period can be expanded by using the astrological correspondence of the number.

There is no way, by this system, to know just how long any period lasts. The duration of time is the most difficult thing to determine by any method of divination. The general rule here, however, is to divide the total life—whether short or long—into as many periods as there are letters in the name. Each letter represents one of these periods. If the life is long, it represents a longer period than if the life is short.

Then the Key of the Decave of the Divinatory Number is taken to represent the condition at the end of life, whether this end comes early or late.

And it must not be forgotten that in such divination rigid interpretations are to be avoided. The numbers in such a chart are to be used merely as guides to the intuition; not to limit it. All impressions and intuitions, therefore, should be expressed freely, even when they somewhat contradict the rigid interpretation of the numerical chart.

The Enchantress—Arcanum XI

—Letter: Egyptian, Caitha; Hebrew, Caph; English, C—K. Number 11. Astrologically, the planet Neptune. Color, changing iridescence. Tone, the music of the spheres. Occult science, divination. Human function, thought-transference. Natural remedy, spiritual healing. Element, neptunium.

C-11, expresses in the spiritual world, the principle of all force, spiritual and material.

In the intellectual world, moral force.

In the physical world, organic force.

Remember, then, son of earth, that for power one must believe in one's ability. Advance with faith. To become strong, impose silence upon the weakness of the heart. If Arcanum XI should appear in the prophetic signs of thy horoscope thou shouldst study duty, which is the rule of right, and practice justice as if you loved it.

In Divination, **Arcanum XI is Force, Spiritual Power, or Fortitude.**

Arcanum XI is figured by the image of a young girl who opens and closes without effort, with her hands, the jaws of an angry lion. The maiden wears a crown surmounted by a vase and crowned eagles, and at her brow the sacred serpent.

The vase is symbol of the affections, and the crowned eagles represent force spiritualized. The sacred serpent signifies that she acts in full knowledge of her power, and not blindly. The lion symbolizes force, also the animal desires in man which are subdued by the spiritual nature.

The whole ensemble symbolizes the power over violent forces of nature that faith in oneself and an innocent life will give; also the spiritual power that is the natural result of unsullied affections which dominate and rule the animal instincts. It signifies that purity is the touchstone, and that goodness alone is power.

Number

—Numerically, 11 indicates the extreme magnetic and feminine forces of nature. It exemplifies the doctrine that evil should not be resisted, but be overcome with good. The finer forces of woman, while not giving the physical strength of man, enable her to govern him by appealing to him interiorly, and thus she molds his efforts through his affectional nature. She enters occultly into his life; and liberating the powers which lie latent in the structure of his genius, enables him to realize the ideals she in her love has formed of him.

As composed of 7 and 4, the number 11 symbolizes the power that is realized as a result of the perfect union denoted by 7. As 9 and 2, it represents Wisdom carried into the realms of Occult Science, giving control of the magnetic currents of the astral world. As 6 and 5, it signifies Temptation banished through devotion to Religion. As 10 and 1, it denotes Fortune dominated by Will.

Astrology

—Neptune is the octave expression of the planet Venus, signifying spiritual love as distinct from the material love ruled by Venus. Neptune is the planet of psychic manifestation, its prominence in a birth-chart being an indication of psychic ability. It exerts little power upon the physical world directly, but by its action upon the imagination of people it becomes singularly potent. Its influence is to spiritualize, and it usually is a prominent planet in the birth-chart of all types of genius, denoting that peculiar power so well expressed by Arcanum XI.

Human Function

—The peculiarly high-strung and sensitive organism given by the planet Neptune enables its natives to receive mental messages from others. It is capable of great negativeness, giving it capacity for reception, and is sensitive enough to perceive the import of thought vibration. At the same time it has an inward power by which it can send potent thought-forms to do its will, or through the faculty of imagination impress its messages upon the minds of others. It is like the strings of a cello, sensitive to impinging sounds and readily set vibrating by them, and at the same time powerful to cause vibrations in other instruments. These qualities requisite for thought-transference are indicated by Arcanum XI.

Alchemy

—Arcanum XI represents the energy liberated during the process of transmutation. When the metals join, and the heat of the reverberatory furnace is applied, they flux and reduce to the first matter before the alchemical transformation takes place. And in this process heat, electricity, magnetism, and still finer forces are set free. These

forces, so generated, are not violent, and are so subtle that they would go entirely unnoticed by the careless. Nevertheless, they are of great importance in the alchemical process, and especially essential in the completion of the Great Work.

Bible

—The most notable reference to the principle pictured by Arcanum XI which occurs in the Bible is the story of Samson. His strength lay in his purity and his virility; for his mother was commanded while carrying him; Ju. 13: 14; “She may not eat anything that cometh of the vine, neither let her drink wine nor strong drink, nor eat any unclean thing.”

Samson slew the lion of Arcanum XI with his hands, and later took honey from its carcass; honey being symbolically the nourishment the spiritual body receives from that creative purity represented by the highest work of the bee. In other words, Samson overcame his animal nature; and the bees, or creative attributes, utilized his virile powers to build up spiritual strength.

So long as Samson was pure his strength was boundless, but when he fell into sin his strength departed. Ju. 16:5; “And the lords of the Philistines came up unto her, and said unto her, Entice him, and see wherein his great strength lieth, and by what means we may prevail against him, that we may bind him to afflict him, and we will give thee, every one of us, ELEVEN hundred pieces of silver.”

The three times Samson was bound and easily broke his bondage signifies that the power of purity prevails in physical, astral and spiritual realms. Hair is coincident with the age when sexual virility is attained, and Samson having been unshaved since his birth, indicates his natural ability, due to purity of life, to use his virile forces in a constructive manner. But Delilah was a harlot, and robbed him of his purity, shaved him of his constructive powers, and delivered him into the hands of his enemies, who put out his eyes, or spiritual sight, and the spirit of the Law departed from him.

Masonry

—The Masonic degree known as the Heroine of Jericho is founded upon Arcanum XI. The scarlet line let down by the heroine, and the red handkerchief used in making the sign of the degree, denote feminine power.

The story is that by means of this cord two spies from Israel made their escape from their enemies in Jericho. It is symbolic of woman’s creative periods, and signifies the spiritual escape from physical limitations that the higher use of their creative powers will bring to man and woman. They are here alluded to as spies in a foreign land because the physical plane which they occupy is a domain foreign to their spiritual estate.

Magic

—In magic, Arcanum XI corresponds to thought-diffusion. This process, sometimes used maliciously, and sometimes used unconsciously, is a dominant factor in our political life, and is the means by which the so many occult absurdities and religious imbecilities are kept alive and gain a following.

Some strong, self-willed individual elects himself leader, and formulates some doctrine—political, occult, religious, or what not. This doctrine may, or may not, contain much of truth; and it may be an earnest conviction, or merely the means by which the leader hopes to further his own unscrupulous ambitions.

But in any case he attracts to himself other mentalities less dominant than his own, who unite with him in promulgating this doctrine. The combined thought-force radiates the thought-form of the doctrine outward with much force, and it reaches and dominates a number of receptive minds. These, in turn, convinced the doctrine is true, even though they have never subjected it to keen analysis, add their thoughts to the thought-form group. And in this manner, the dominant power of the thought-form overpowering reason through emotional energy, a chain is formed extending from the leader as the positive pole, through various links, to the masses as the negative pole.

Every additional person who accepts the doctrine and becomes its proponent makes its power stronger. As a snowball gains in size as it rolls down hill; so the thought-power of such a group of thoughts gains strength with each new adherent.

The viciousness of this thought-diffusion process is that it works so subtly. It attacks the unconscious minds of people quite unknown to themselves. The vast thought-power gives an emotional trend to the unconscious minds of the people it reaches, and this emotional element is often sufficiently strong to override any tendency to use reason or to bring to bear the critical faculties.

Thought-diffusion, minus the chain effect, is the kind of power used by a high-pressure salesman to sell a customer something for which the customer has no earthly use. But as employed by statecraft or by priestcraft, with the chain effect, it is used to sell the populace whatever ideas those in authority wish people to accept. And these ideas, all too often, are those that support decaying theological dogmas, those that keep people subservient to their exploiting rulers, or which cause Occidental students to accept, in spite of their logical absurdities, certain mystical follies from the Orient as a part of the real Secret Doctrine.

The real adept never utilizes such methods; and the only image he radiates systematically is his own ideal of himself in greater perfection than he has yet attained; and this ideal he receives through reflection, from his mate.

Initiation

—In the soul's initiation Arcanum XI represents the spiritual and psychic powers that are the outcome of the neophyte's occult training.

His training, as well as the general trend of his life, has been to give greater refinement to his body, his thoughts, and his feelings. And as this change, denoted by Arcanum XI takes place, he becomes increasingly more potent to use his spiritual and astral powers; for the power of a force depends upon the plane from which it emanates, and the finer the organism the finer the force which it is capable of receiving and transmitting.

This refinement and training also increase the sensitivity of the psychic senses, enabling him to register and interpret vibrations quite outside the range of perception of the less developed man.

As shown by Arcanum XI, the animal nature must be entirely subdued; but it certainly must not be killed. Man is dependent for energy upon the attributes developed while in the lower kingdoms; but these energies, to be spiritual, must be diverted from animal expression into purely constructive channels. Not the suppression of the animal nature is real purity, but the use of all energy, sexual energy included, in channels which are constructive and aid others instead of merely benefiting self.

This Arcanum does not represent the repression, or destruction of sex; for every energy in existence is dependent for its potency upon polarity, or sex. The power of an electric current depends upon the difference in potential; that is, the difference between the positive pole and the negative pole. And a man or woman to be able to exert any real power must be strongly sexed. The more feminine a woman is, and the more masculine a man is, the more power they possess. The mistake here must not be made, however, of concluding that intellect and will are strictly masculine qualities. Mercury is convertible, and not the exclusive property of either sex. A woman may be an intellectual genius and still be strongly feminine, and a man may have strong tender emotions and still be masculine. But to have great power, as amply demonstrated by the outstanding people of the world's history, the individual must be strongly sexed.

Things have been accomplished by hermaphrodites; that is, by those of dual sex; but an investigation of such accomplishment discloses that these hermaphrodites were merely the mediumistic and negative instruments through which some other strongly sexed intelligence was able to manifest. The lack of individuality, the lack of character, and the lack of sex, alike give easy access to some dominant force, and encourage the expression of a multiple personality. But it hinders the development of individuality, makes for the disintegrative phases of mediumship, and precludes real soul development. Real power

depends upon an energy controlled by the individual, and this energy has great dependence upon sex; but if it is a real power it must be projected from a high plane and only into constructive channels.

Occult Science

—By divination the attention of the unconscious mind is directed to obtaining information which is not readily accessible to the objective consciousness through external channels. The psychic senses, thus directed, perceive the information sought. This information then resides in the astral brain like a memory. Then, through the divinatory process, whatever it may be, this memory residing now in the unconscious mind, is brought up into objective consciousness to be utilized in everyday affairs.

King Court Cards

See Page 4

—Strictly speaking the king, queen and youth of each suit have a numerical value of 10 each; for they represent all of humanity, both men and women, as born under the twelve zodiacal signs. See Page 4

Man alone, or woman alone, is represented by the number 5; but each king not merely signifies a man of given temperament, but also, when reversed, a woman of that temperament, thus giving two 5s, or 10 for the whole card. Either the king, the queen, or the youth, is numerically 10.

The kings represent the first degree of emanation of each zodiacal triplicity; the queens represent the reaction, or second degree of emanation of each triplicity; and the youths or product of action and reaction, represent the third degree of emanation of each triplicity.

The horsemen, however, do not represent people, but the thoughts of people. Thoughts are ruled by Arcanum I; therefore, each horseman has a numerical value of 1.

The King of Scepters signifies a person ruled by the sign Aries: fiery, headstrong, ambitious, courageous and energetic. Right way up it denotes an Aries man; reversed it indicates an Aries woman. The dominant idea is I AM.

The King of Swords signifies a person ruled by the sign Taurus: reserved, sullen and practical. Right way up it denotes a Taurus man; reversed it indicates a Taurus woman. The dominant idea is I HAVE.

The King of Coins signifies a person ruled by the sign Gemini: intelligent, restless, volatile and fickle. Right way up it denotes a Gemini man; reversed it indicates a Gemini woman. The dominant idea is I THINK.

The King of Cups signifies a person ruled by the sign Cancer: mild, reserved, home-loving and pleasant. Right way up it denotes a Cancer man; reversed it indicates a Cancer woman. The dominant idea is I FEEL.

The Martyr—Arcanum XII

—Letter: Egyptian, Luzain; Hebrew, Lamed; English, L. Number, 12. Astrologically, the zodiacal sign Pisces. Color, the darker shades of purple. Tone, low A. Occult science, natural alchemy. Human function, sensing the spiritual aromas. Natural remedy, such herbs as mosses which grow in the water, ferns and seaweed. Mineral, the talismanic gem peridot; and such stones as sand, gravel, pumice and coral.

L—12 expresses in the spiritual world the revealed law.

In the intellectual world, the precept of duty.

In the physical world, sacrifice.

Remember, then, son of earth, that sacrifice is a divine law from which none is exempt; but expect any ingratitude from men. Always hold thy soul in readiness to render its account to the eternal. If Arcanum XII should appear in the prophetic signs of thy horoscope, a violent death will spread its snares upon the way. But if the world attempts thy earthly life do not die without accepting with resignation this decree of God, and pardon thy cruelest enemies; for whosoever does not forgive here below will be condemned in the next life to eternal solitude.

In Divination, **Arcanum XII** may be read as **Sacrifice** or **Expiation**.

Arcanum XII is figured by a man suspended by one foot from a gallows which is supported by two trees, each having six cut branches. His hands are tied together, forming a down-pointing triangle, above which one leg crosses the other in the form of a cross. From the hands gold pieces drop to the earth.

It is the sign of a violent death, coming unexpectedly by accident, or in the expiation of a crime, or accepted voluntarily through heroic devotion to truth and justice.

The twelve cut branches indicate the destruction of the twelve houses of the horoscope, signifying the extinction of life.

The cross above the triangle, a symbol the reverse of that on Arcanum IV, indicates that material forces have gained the ascendancy and subdued the mind.

The coins dropping upon the earth signify wasted effort and the ebbing of the life forces. They also indicate that the efforts of the martyr who loses his life in furthering truth and justice are never lost, but remain on earth after he has passed. Ideals as yet unrealized persist in the astral about the earth until they contact some other person through whom they find suitable and more complete expression.

Number

—Numerically, 12 being the second decade of 3, may be represented by Arcanum III expressing on the vibratory level indicated by Arcanum II. That is, union expressing on the negative plane, the result of which is depicted by Arcanum XII.

But it also has another aspect; for union may also be on the plane of science, as denoted by Arcanum II. And thus considered, Arcanum XII indicates that the science of union rests upon sacrifice and devotion; for selfishness is the antithesis of higher union. This thought, however, is perhaps better expressed by adding 3 and 9 to indicate union guided by wisdom; while the adverse significance is more completely denoted by 6 plus 6, indicating trials upon trials. The 8 plus 4 aspect is better; for it reads, justice realized.

Astrology

—As the sign Pisces is the last sign of the zodiac, and rules the house of self-undoing, of expiation and crime, as well as sacrifice and disappointment, the astrological correspondence with Arcanum XII is obvious.

Human Function

—As a symbol of religious devotion, or for the expiation of sin, it was anciently the custom to offer a sacrifice unto the Lord, or universal law. This taking of life and offering it upon the altar of expiation was to be a sweet savor unto the Lord. But its higher import was the implication of the sacrifice of the animal part of one's nature upon the altar of devotion to cosmic welfare, and that such sacrifice, through the aspirations which prompt it, nourishes the spiritual nature. Such exalted emotions, in addition to building a spiritual body, cause radiations to emanate from a man similar to those spiritual aromas which can alone be apprehended by the psychic senses.

Alchemy

—Because life is short and the processes of the alchemical art take time, the variety of the ingredients which enter into transmutation becomes limited. Some such ingredients, therefore, which, had we more time, might be used successfully must be sacrificed to the need of other ingredients. Thus are we compelled to exercise choice in their selection. This choice should be made only after careful analysis has revealed the quality of each, the effort at all times being made to retain that which already is far advanced and truly useful. When such a choosing becomes imperative the grosser metal must be sacrificed that we may retain the more refined.

Bible

—Arcanum XII pictures Judas after he repented. Math. 27:5; “And he cast down the pieces of silver in the temple, and he went and hanged himself.”

It also symbolizes the fig tree that was cursed for not being fruitful. Mark 11:20; “And in the morning, as they passed by, they saw the fig tree dried up from the roots.”

The other aspect of this symbol is that of voluntary sacrifice instead of expiation. This is exemplified in the persecution and violent death of the apostles, and also in the conversion of the rich publican, Zacchaeus. In mythology it is Prometheus undergoing perpetual torment for his immortal theft of the divine fire from heaven with which to benefit humanity.

Masonry

—Arcanum XII is represented by the ritual in the Christian Mark degree where the Grand Ministers execute the Judgment of the Lord and the candidate bewails his fate because his lips are unclean. Before conferring the mark, in some obediences, a live coal is taken from the altar and pressed to the candidate’s lips to signify expiation.

Magic

—Arcanum XII symbolizes the certain fate that ever follows those who use magical powers without discrimination. The cross above the triangle signifies that the magician has become the servant of the very elemental forces he sought to master. The practice of magic, unless with wisdom and unselfishness, inevitably leads to tragedy. And those who attempt to use sex in magic to attain selfish power merely fasten upon themselves evil elementaries that often force them to follow the example of Judas Iscariot and commit suicide in their attempt to get free from them.

The benefic side of the arcanum is this exposition of magical law: “Give all thou hast of breath, of power, or life, in just duty and lawful motive; expire honestly the corrupted or contaminated matter; and you shall instantly be filled with the celestial fire and become refined.”

Initiation

—Arcanum XII indicates the neophyte’s absolute devotion to the cause of truth and progress. It exemplifies the summons of the Nazarene: “Go thy way, sell whatsoever thou hast, and give to the poor, and thou shalt have treasures in heaven; and come, take up thy cross, and follow me.” Henceforth the struggling soul takes no thought

what it shall gain personally by its efforts, but devotes its energy to assisting in the progressive evolution of creation; sacrificing life itself if necessary in the cause of truth and justice.

Occult Science

—Natural alchemy embraces those processes which take place slowly in nature, but which man can hasten and utilize for himself if he possesses sufficient knowledge. To this end, therefore, he studies all the transformations that have taken place in the world; physical, biological, mental and religious, that he may perceive just what nature has thus accomplished. Having arrived at a comprehensive knowledge thus of relations of things to each other and to himself, he utilizes this information to bring those transmutations to pass which, in this new wisdom, he now most desires.

The Horoscope Spread

—The diagram on page 140 illustrates the principle that four signs always express the absolute and are explained by the fifth. The diagram on page shows how the five must move in a medium expressed by four signs, thus completing the number of deific manifestation, 9. But when we consider man, we find him the medium through which stellar forces act. So considered, the signs reverse and he is represented by cells 2, 4, 6, 8, and 9 in the diagram of page .

Furthermore, we know that everything possessing life is a trinity of positive, negative, and union, so that each of the active cells, 7, 1, 3, 5, shown in chapter 1 expands into a trine as indicated by the diagram on page. These are the twelve houses of life constituting a horoscope.

To use the diagram as a tarot spread the cards are dealt one by one upon the houses of the horoscope in the order indicated by the numbers in the diagram. The reading is used to foretell the near future of every department of life of the one making the consultation. The card falling upon any house of the chart will reveal the fortune of those things ruled by that house astrologically. The cards should be turned over only as read.

Trine 1—6—11 is the trine of life. 1 relates to personal things and health. 6 is the life of the mind, governing philosophy, publishing, and travel. 11 is the life of posterity, ruling children, love affairs, pleasures, and speculation.

Trine 2—7—12 is the trine of power. 2 is the power to attract honor and authority, ruling business, credit, and reputation. 7 is the power given by environment, governing sickness, servants, and labor. 12 is the power of wealth, ruling cash and personal property.

Trine 3—8—9 is the social trine. 3 is the society of partners, and rules the husband or wife, open enemies, and law suits. 8 is the society of kindred and thoughts, governing brethren, studies, writing, and short journeys. 9 is the society of associates, ruling friends and hopes.

Trine 4—10—5 is the trine of concealed things. 4 is the environment more or less concealed, ruling the home, real estate, and the end of life. 10 is the concealed things of death and fatality, ruling legacies and the partner's money. 5 is the concealed afflictions, governing disappointments, restrictions, and secret enemies.

A good card falling on any house signifies good luck in that department of life, and an evil card on a house signifies evil luck will come from the things it rules, the nature being shown by the card.

“Everything that has been, is, or will be, has its foundation and is built up, in four trines.”

Chapter 9

Serial No. 29
Original Copyright 1936
Elbert Benjamine

Copyright
Church of Light
August 2002

The Color of a Name

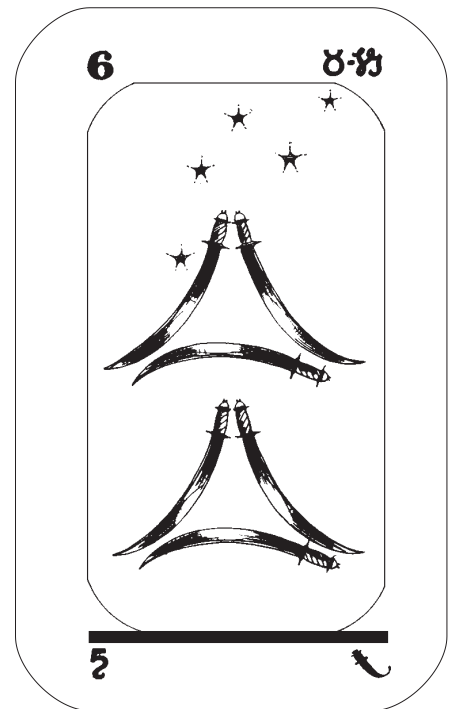
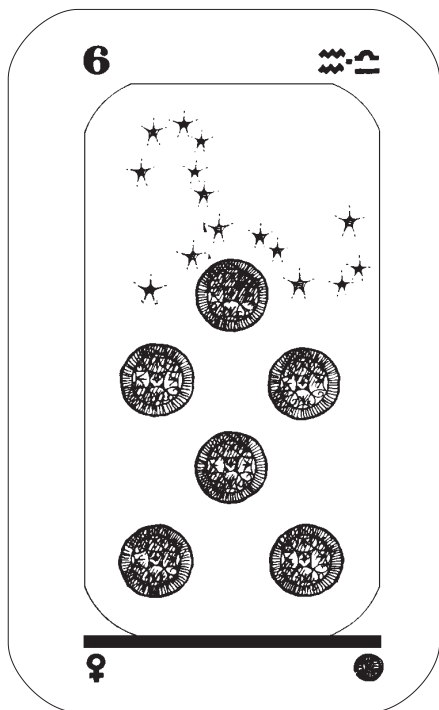
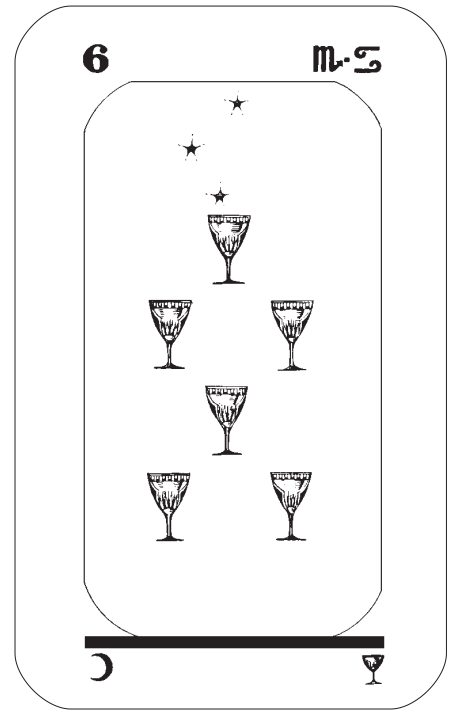
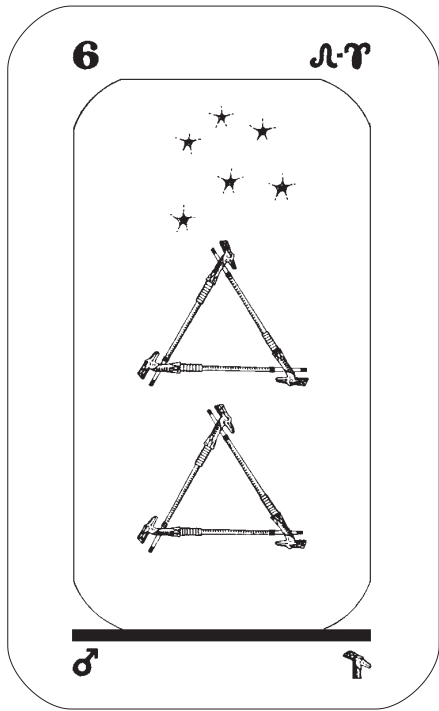

Chapter 9

The Color of a Name



ARACELSUS, one of the greatest physicians, and one of the most learned of occult students, several hundred years ago set forth the principle upon which depends the influence of a name, a number, a color, a musical tone, a locality, or other invisible vibratory rate.

He said: "If I have manna in my constitution I can attract manna from heaven. Saturn is not only in the sky, but also deep in the ocean and earth. What is Venus but the artemisia that grows in your garden, and what is iron but the planet Mars? That is to say, Venus and artemisia are both products of the same essence, while Mars and iron are manifestations of the same cause."

What you have in your constitution is mapped by your birth-chart. If you have the dynamic stellar structure in your astral body mapped by the position of the planet Mars powerful, you will, of necessity, attract events into your life of the nature of Mars; events of violence, either constructive or destructive in character. If you do not have much iron, or Mars, in your constitution, as shown by Mars occupying a weak house and having almost no aspects, you will not have aggressiveness nor much courage, and you will not attract violent events.

And what has been said of the Mars structure is also true of the other nine thought-structures mapped by the various planets, and of the twelve zones of the astral body mapped by the zodiacal signs. If the section of your astral form mapped by a particular zodiacal sign is shown to have much activity, as indicated by planets in the sign having many astrodynes, or by the ruler of the sign having many astrodynes, the department of life indicated by the house position of that zodiacal sign will come into unusual prominence all through your life. And thus it is that the type of events attracted to the individual depends exclusively upon the activity of the thought-cells within himself that have the same vibratory rates as these events. If the money structures and money zone of the astral body have considerable activity, money will enter the life as of considerable importance; but if the money structures and zone are weak, there will be neither large gains nor large losses, and money will not be as important a factor as some other of life's activities. If the structures and zone ruling marriage are unusually active, this phase of the life may dominate in importance all the other matters entering the life; but if they are passive, this

department of life may prove of negligible importance.

Now any of these structures or zones mapped in the birth-chart can be given additional energy, and thus made more active than it normally is, through associating with things or thoughts of a similar vibration. Whether we will or no, some of them are thus given additional activity through the progressed positions of the planets.

There are three sources of invisible energies that have the power to stimulate the thought structures and thought-cells of our astral body into exceptional activity: astrological influences, the influence of thoughts, and the influence of objects. And when a planet by progression reaches a zone of the astral body, it gives its thought-cells new activity, and this attracts events corresponding to the department of life ruled by the zone into the life. In particular, when a planet by progression also forms an aspect to a dynamic thought structure in the astral body mapped by a planet in the birth-chart, the additional energy thus gained by the thought-cells enables them to attract some pronounced event into the life. And thus, from such progressed positions of the planets, and the dates when they make aspects with structures in the astral form, the astrologer is able to predict what events will transpire and when they will come to pass.

But progressed planets are not the only source of such additional energy that may be made available to thought structures and zones within the astral form. Both thoughts and objects have a similar power, though varying in the amount of energy contributed. In Course 9, *Mental Alchemy*, I have considered the deliberate use of certain types of thought, and in this course considerable attention has been paid to the use of abstract thoughts, such as names and numbers. And right here I wish to indicate how the character vibrations of colors may be employed in a similar manner.

Sound is caused by vibrations ranging from the 4th to the 12th octave of vibration, or from 16 to 32,768 vibrations per second.

Vibrations either slower or faster than these must be apprehended by other means than the ear. Electricity, for instance, which is not perceptible to either eye or ear, includes the 25th to the 35th octave, or from 33,354,432 to 34,359,738,368 vibrations per second.

Radiant heat, such as that coming to us from the sun, ranges from the 46th to the 48th octave, or from 70,368,744,644 to 281,474,976,710,656 vibrations per second.

The effect of these vibratory rates, as producing physical changes in our organism, is readily apparent. But there are other vibrations which have quite as pronounced an effect in producing physical results that are less easily discerned in their action. Thus, the chemical ray, used in photography and producing sunburn when we stroll the beach in scanty attire, belongs to the 50th octave of vibrations; and the X-ray, which without sensation burns tissue within the human body, belongs to the vibratory rates within the 59th to 61st octave.

Within the range of the 49th octave of vibration, around 562,949,853,421,312 vibrations per second, the rates of motion are perceived by the eye as light. This white

light when refracted divides itself into vibratory rates slightly faster and slightly slower than the average, and these different rates give rise to the seven colors of the solar spectrum.

These seven colors, as ascertained by the effects they produce when associated with, each tend to stimulate, or add energy to, the structure within the astral form mapped by one of the planets of the septenary. And the various shades of these colors, produced by slightly higher or lower vibrations than the type color, are found to add activity to the zone of the astral body ruled by a zodiacal sign. Thus any color, or combination of colors, has an effect upon the astral body which can be determined from the correspondence of the color, or combination, to the zones and structures mapped in the birth-chart. These color correspondences, from which the structure or zone of the astral body stimulated can be ascertained, are given in the treatment of each major arcanum, and also in the table at the front of chapter 1.

Now as each letter, and each number below 23, has the same astral vibratory rate as the astral vibratory rate of some color, or its shade (the astral vibratory rate of a color must not be confused with the electromagnetic vibratory rate which affects the sense of sight), it is easy to find the color correspondence of any number or any name by first finding the vibratory key of the number or name, and then discerning to which color this key corresponds. In applying such correspondences it will be noted that the night signs of a planet correspond to the darker shades of the color ruled by the planet, and the day signs of a planet correspond to the light shades of the same type color.

Thus to find the color of the name, "Teddy": T-22, E-5, D-4, D-4, Y-10 added gives the number 45. 4 plus 5 gives 9 as the Key of the number, and by referring to Arcanum IX we find the color of this key to be light blue.

To find the color number 1918 we add 1 plus 9 plus 1 plus 8, which gives 19 as the Key to which it vibrates, and referring to Arcanum XIX we find the color to be light orange.

Thus by associating with the name Teddy there is the same kind of influence, but probably of different intensity, as that obtained by associating with the color light blue, such as wearing a light blue dress, or even a light blue necktie.

But the most important factor is yet to be mentioned. For while the type of event attracted is determined by the structure or zone of the astral form to which energy is thus added; whether the event will be favorable or unfavorable must be determined by how that structure is organized as shown in the birth-chart.

If the structure or zone as mapped in the birth-chart is shown to be decidedly discordant, adding energy to it (except as a mental antidote as explained in Course 9) gives it additional power to attract misfortune. Therefore, by names, by numbers, by colors, or by other means, pains should be taken not to associate with those astral vibrations that have the same rate as discordant conditions mapped in the birth-chart. Instead, those should be associated with which will add energy in large volume and intensity to such structures and zones of the astral body as the birth-map shows to be

especially harmonious. Thus will more favorable conditions be attracted from without.

The Reaper—Arcanum XIII

—Letter: Egyptian, Mataloth; Hebrew, Mem; English, M. Number, 13. Astrologically, the zodiacal sign Aries. Color, the lighter shades of red. Tone, high C. Occult science, mundane astrology. Human function, the sense of taste. Natural remedy, such herbs as hemp, mustard, broom, holly, dock, thistle, fern, garlic, onions, nettles, radishes, poppies, peppers and rhubarb. Mineral, the talismanic gem, amethyst, and such stones as ochre, brimstone and red stones of various kinds.

M—13 expresses in the spiritual world, the perpetual movement of creation; destruction and renewal.

In the intellectual world, the ascension of the spirit into divine spheres.

In the physical world, natural death; that is to say, the transition through which the soul leaves its physical form henceforth to function in an astral form in the astral world.

Remember, then, son of earth, that terrestrial things are of short duration and that the highest powers are reaped as the grass of the field. If Arcanum XIII should appear in the prophetic signs of thy horoscope, the dissolution of thy organs will come sooner than thou expectest. But do not dread it; for death is but the parturition of another life. The universe reabsorbs without ceasing all which springs from her bosom that has not spiritualized itself. But the releasing of ourselves from material instincts by a free and voluntary adhesion of our souls to the laws of universal movement constitutes in us the creation of a second man, a celestial man, and begins our immortality.

In Divination, **Arcanum XIII** may be read as **Death** or **Transformation**.

Arcanum XIII is figured by a skeleton reaping human heads, hands and feet. On the blade of the scythe wielded by Time is a serpent and a scarabeus, and back of all is seen a rainbow.

The progression of the scythe in its work is the emblem of the perpetual destruction and rebirth of all forms of being in the domain of time.

The serpent on the scythe represents the virile energy that has carried the soul, symbolized by the scarab, in its pilgrimage of births and deaths through the mineral kingdom, the vegetable kingdom and the animal kingdom up to the estate of man.

The skeleton mowing human heads, hands and feet signifies that the thoughts, works and understanding of man eventually pass from the earth. But the rainbow promises a new life of thought, effort and knowledge in a superior realm.

Number

—Numerically, 13 is the 2nd decave of 4, indicating Arcanum IV, or realization, operating on the negative plane of frequency of Arcanum II. It is what is Realized from the efforts of life when Polarizing forces disintegrate the physical body.

What this new plane of realization, to which the efforts have now been transferred, will offer, depends entirely upon how the energies have been used on the plane left behind. If this use can be represented by 9 and 4, the Realization of Wisdom, self-conscious progression gains momentum. But if the transition is only 10 and 3, Change of Action, 5 and 8, the operation of the Law of Justice, or even of 6 and 7, Victory over Temptation, the activities of life are merely transferred, without much gain or loss, to the inner plane.

Such transition is possible, however, as 1 and 12, Will directed to the Sacrifice of all selfishness, or as 2 and 11, under the Science of Spiritual Power. And when such is the case, the new life witnesses a great gain in freedom, in consciousness, in ability, and in enjoyment.

Astrology

—Aries is the beginning of the zodiac, where the circle is completed and the cycle of one life ends in the start of another. When the Sun crosses the first point of Aries the astronomical year commences, and when it again crosses into Aries, that year is ended, cut off, destroyed. And thus is Aries, as indicated by Arcanum XIII, Brahma as well as Siva, both creator and destroyer.

Human Function

—Life subsists upon life. The energy and substance of each physical organism is largely gained through the Death of others. To sustain the life of man there is a constant sacrifice of the lives either of plants or of animals. This life of the lower kingdoms, when taken into the body of man undergoes a Transformation by which it is made available for his use.

The cosmos depends upon the innumerable conscious entities embraced in it for expression and progression. And likewise man depends upon the innumerable cells of his body for expression upon the physical plane. Each of these cells is as independent of man as man is independent of the earth on which he lives. That is, each cell has its own individual consciousness, nor do the sum total of the cells comprise the man; for the man has a consciousness independent of these cells. Yet while these cells are a portion of man's anatomy they should each obey the dictates of man, just as man should obey the mandates of the Supreme Intelligence.

Even as man is undergoing a progressive cycle on the earth, so each cell in his body is undergoing its progressive cycle in association with him. Therefore, while the Death of the organism that serves as food liberates the soul that has polarized the protoplasm and energy contained in the form, this transition to the body of man is not without compensation to the life of the individual cells. For their substance and energy is now Transformed into cells occupying the body of man, and thus in association with an intelligence which affords them greater opportunity by far for evolutionary progress.

To the cell-life, at least, the serving as food for a higher form of life than that previously occupied is not without its advantages. And the human function by which man selects what shall thus be Transformed to his own use is the sense of taste, which corresponds to Arcanum XIII.

Alchemy

—Arcanum XIII represents that Transformation which occurs in the substance and form due to transmutation. The fluxing of polar opposites or natural antidotes produces not merely a blend of the substances, but the Death of the old properties in the production of a new and more highly refined substance with entirely different properties. There is thus a Transformation of both the substance and the form.

Bible

—As related in the 49th chapter of Genesis, Jacob, being about to die, called together his sons, who are the fathers of the 12 tribes of Israel. To each he gives his blessing, together with a prophecy; and this deathbed pronouncement reveals without error to any competent astrologer just which tribe is ruled by each zodiacal sign.

It should be evident, for instance, that when he speaks of Reuben being as unstable as water, that he refers to the Waterbearer, Aquarius, and the abrupt changes made by those in whose chart Uranus, its ruler, is prominent. Likewise, when he speaks of Simon and Levi as being brethren, he can be referring to no other sign than the Twins, Gemini.

That Judah is a lion's whelp must mean Leo, the Lion; and when he says that Zebulon shall dwell at the haven of the sea, he certainly refers to the home of the Crab, Cancer. Isaachar mentioned as a strong ass, is the sign Taurus; because Taurus rules donkeys as well as the Bull. And because justice is weighed in the scales of Libra, Dan, who shall judge his people, must belong to this sign.

Speaking of Gad, he says that a troupe shall overcome him, but he will overcome at the last; because Scorpio has a multitude of desires, but has the power to divert them to a high purpose as symbolized by the Eagle, which also is a token of this sign.

That Asher shall yield royal dainties and his bread shall be fat, of course, indicates the food sign, Virgo; and Naphtali being a hind, or deer, or Goat, signifies Capricorn. So,

too, when we read that in Joseph's bow abode his strength, we look for a bow among the signs, and find the Archer, Sagittarius.

Now Aries has a constructive and a destructive, or warlike, aspect; the latter being signified by the wolf, as when there is a wolf in sheep's clothing. So when we learn that Benjamin shall rave as a wolf, we know he belongs to Aries. And then when we come to Ephraim and Manassah, we find that Ephraim, who was the younger, was blessed first, contrary to customary usage, and that Manassah, who was older, was blessed later, thus indicating that at the end, or last sign, the dual sign Pisces, that the last shall be first and the first shall be last. This not merely signifies the sign of disappointments, but also indicates that the priesthood, who belong to this sign of Universal Brotherhood, should be willing, when necessary, to renounce worldly advantages for the good of mankind.

At the death of Jacob the twelve signs were thus represented, and Jacob himself, after delivering his blessings, was straitway gathered to his fathers, a Transformation such as is represented by Arcanum XIII.

The twelve disciples who were called by Jesus also represent the 12 zodiacal signs; Jesus making the 13th member, the lamb of God, or transitional influence of Aries.

He said on that occasion, Math. 26:23; "He that dippeth his hand with me in the dish, the same shall betray me."

Now of the four zodiacal quadrants the Scorpio, or Eagle, is represented by the suit of cups. Jesus is crucified on the autumnal cross of Libra, and was betrayed for 30 pieces of silver. And from the point where the sun is slain on the cross of Libra, the nights, or powers of darkness prevailing over the days, to the sign Scorpio, is just 30 degrees. Judas, therefore, is the sign of death, Scorpio, the realization of material forces, indicated by Arcanum IV, who betrays the sun into the winter signs; delivers the spiritual influence into the power of matter.

Judas later repents and hangs himself, as shown by Arcanum XII. This, however, but depicts the expiation of the sin; for Judas himself belongs essentially to Scorpio and not to Pisces.

The bread of the Lord's supper is the symbol of the physical nourishment that sustains the material body. The wine is token of the emotional nourishment which alone builds up the spiritual body and makes immortality possible. Man requires both forms of sustenance.

Because thirteen were gathered at the Lord's supper, and one passed on, even today some persons will not sit at a table where thirteen are present. To some it is an omen that one of them shortly will die.

But 13 is not merely the symbol of death and dissolution. It is the number of the vernal cross, of spring-time, of the sign Aries in which the sun commences a new cycle of life. It is thus also the promise of immortality; for the Sun God then arises from the tomb of winter. So while 13 means physical death to the vulgar, to the

initiate it signifies more frequently the Death of Selfishness and Crystallization through the Sacrifice and Devotion signified by Arcanum XII; and the commencement of a new life through the Transformation of material desires into spiritual aspirations.

Masonry

—In modern Masonry there are something like six degrees of the Cross, all dealing with some aspect of Arcanum XIII. But because in the zodiac there are two crosses, the vernal cross of Aries and the autumnal cross of Libra, these degrees of the cross have reference to both of them.

The Christian cross of crucifixion is Arcanum III, astrologically Libra. But there is also a militant cross of resurrection, Arcanum XIII, or Aries, symbolized by a sword, which in form is but an inverted cross, even as Libra and Aries are polar opposites in the zodiac.

The meaning of these degrees of the cross is that man is born upon the earth through generation, or Arcanum III, and is born into the next life through physical death; yet his real birth into a spiritual life is brought about through the Transformation of his animal tendencies into those that have for their chief object the welfare of the whole of cosmic society.

Magic

—In magic, Arcanum XIII represents the ability to separate the astral body from the physical at will and use it as a vehicle to visit other parts of the earth, to visit the homes of the dead, or to explore the tremendous regions of space. It is that process which is referred to in Masonry as “travelling in foreign countries.”

Various methods are employed to bring about this separation of the astral body from the physical without a break in consciousness. One of the safest ways is to go out during sleep, passing out through the pineal gland, retaining the consciousness by a realization all the while that one is dreaming, and holding to the recognition of things seen as a true astral experience. Full details of this method are set forth in the 11th Award MS.

Others quite successfully bring about this condition by gradually incapacitating the physical body and voluntarily slowing down the heart action. While lying in a relaxed state, and after thus slowing down the heart action, they induce a tremendous desire to move to some particular spot; and this, under such training, takes them out of the physical and permits them to maintain consciousness while moving about in the astral form.

Oriental commonly use mantrams, rhythmic breathing and a spiral swaying motion of the body to loosen the astral from the physical. The astral body by means of this method passes upward out the top of the head.

Mediums also leave the physical body during trance, and may bring back accounts of what has been seen on such journeys. But this method, because it is done under the influence of some controlling entity, is disintegrative and highly dangerous.

Such experiments are not to be undertaken lightly; and considerable precaution should be taken to protect the physical body from shock; as the too sudden awakening, or bringing back to the physical, is a great jolt to the nervous system, and might be so great as to sever the astral cord binding the finer to the grosser body, and thus result in death. Also some precaution should be taken that in case there is difficulty getting back into the physical that relatives do not conclude hastily that death has ensued and cause an untimely burial.

Initiation

—The soul has its birth into the next life, just as it has its birth into this one. This new birth does not always coincide with the moment of physical death, for there is commonly a short or longer period of unconsciousness in transition.

If one is too strongly attached to the things of earth, and unable to relinquish the strong desires for them, he may be bound, for a time, close to the earth, and not awaken into the consciousness of the new life. Or one may have become so dominated by some idea that one lives in the image of this idea and for a time shuts out the reality by which he is surrounded. That is, until something or someone awakens him to a realization of his true condition, he may live in an imaginary world of his own thought-creation.

But whether one passes through the doorway to astral existence quickly or slowly, ultimately the time arrives when he awakens into full consciousness of his surroundings. This is the moment of his birth into the next life, and it coincides with his new astrological birth-chart.

Then comes the period of judgment, in which he is both judge and the one on trial. He perceives the actions of his life and the motives which prompted them. He finds, perhaps, that his progress now depends first upon rectifying certain mistakes made while on earth. And this he does either through contact again with those he injured, or at least through rendering some constructive service to others.

After a period of adjustment to next-life conditions he gravitates, or levitates, to the particular plane which corresponds to his own dominant vibratory rate. And on the plane where he now finds himself, whether high or low, depending upon his spirituality, he moves into the environment which corresponds to the harmonies and discords within his finer form.

But whether high or low, there is always opportunity for progress. There are works to be performed, joys to be experienced, and an even greater variety of interesting events than is possible on earth. But in this new realm money has no value. There is but one currency which is legal tender, and his progress and any assistance rendered him by others

depends upon it. This currency of the next life is constructive service such as in some manner brings benefit to others.

Occult Science

—The events which happen to nations, to cities, to communities, and to the world in general are chiefly shown astrologically in Cycle charts. These charts, by which the events that thus affect groups of people are predicted and explained, are chiefly those erected for the moment some planet has circled the zodiac and crossed from south to north declination.

The point of the zodiac where the sun thus crosses from south to north declination is always the first point of Aries, and thus the first point of Aries becomes the accepted symbol for the commencement of a new cycle. And as Mundane Astrology largely depends upon such cycles, it corresponds to Arcanum XIII, which pictures the sign Aries.

Queen Court Cards

—The Queen of Scepters signifies a person ruled by the sign Leo: haughty, high spirited, ambitious and resolute. Right way up it denotes a Leo woman; reversed it indicates a Leo man. The dominant idea is I WILL.

The Queen of Swords signifies a person ruled by the sign Virgo: studious, rather even tempered, ingenious and witty. Right way up it denotes a Virgo woman; reversed it indicates a Virgo man. The dominant idea is I ANALYZE.

The Queen of Coins signifies a person ruled by the sign Libra; good, high minded, noble and amiable. Right way up it denotes a Libra woman; reversed it indicates a Libra man. The dominant idea is I BALANCE.

The Queen of Cups signifies a person ruled by the sign Scorpio: active, selfish, proud, resentful, reserved and thoughtful. Right way up it denotes a Scorpio woman; reversed it indicates a Scorpio man. The dominant idea is I DESIRE.

The Alchemist—Arcanum XIV

—Letter: Egyptian, Nain; Hebrew, Nun; English, N. Number, 14. Astrologically, the zodiacal sign Taurus. Color, the darker shades of yellow. Tone, low E. Occult Science, Practical Occultism Applied to Daily Life. Human function, psychometry. Natural remedy, such herbs as daisies, dandelion, myrtle, gourds, flax, lilies, larkspur, spinach and moss. Mineral, the talismanic gem, moss agate; such stones as alabaster, white opaque stones and white coral.

N—14 expresses in the spiritual world, the perpetual movement of life. In the intellectual world, the combination of ideas which create the moral life.

In the physical world, the combination of the forces of nature.

Remember, then, son of earth, to conserve thy forces, not to recoil at thy works, but in order to wear out obstacles, as water, falling drop by drop, wears away the hardest stone. If Arcanum XIV should appear in the prophetic signs of thy horoscope, a well formulated plan of action followed perseveringly will raise thee by degrees to the heights thou wouldst attain.

In Divination, **Arcanum XIV** is **Regeneration** or **Temperance**.

Arcanum XIV is figured by the genie of the sun holding a golden urn and a silver urn, and pouring from one to the other the conducting fluid of life. The genie is crowned with flame to indicate that it is a spirit; and its feet are winged to signify its rapid movements. The fluid transferred from one urn to another is the symbol of transmutation; and the eight rays of the sun which show behind the genie's head signify that the positive, or masculine, forces of the universe are exactly equilibrated by the negative, or feminine, forces. The cloak over the shoulder of the spirit indicates the perpetual fecundation of matter, as symbolized by the cloak, by spirit.

This ensemble pictures the combination and interchange of masculine and feminine forces throughout nature, working ceaselessly in all kingdoms, as the instigators and cause of all movements and life.

Number

—Numerically, 14 is the second decade of 5, and thus represents the Law, Arcanum V, operating upon the next interior plane as signified by Arcanum II. As 5 is the dominion of man's intelligence over the physical plane, so 14 must be the dominion of man's intelligence over the astral plane.

Now 7 signifies the perfect nuptial union on the physical plane, the union of body, soul and spirit with body, soul and spirit. Therefore, the double 7, or 14, must signify the perfect union on the inner plane, the perfect regenerate union, in which the finer forces, as shown in Arcanum XIV, completely blend and fuse. And herein lies the secret of rejuvenation; for, in the exchange of these finer energies, controlled and directed by love, there is a power to restore and maintain youth and vigor.

Astrology

—When, in the spring of the year, the sun crosses the vernal equinox and enters Aries, represented by Arcanum XIII, the forces of nature commence to move and new processes are set in motion within the laboratories of Isis.

But the solar force in Aries is not alone capable of regenerating the world; for such regeneration, or any other regeneration, requires also that the feminine forces shall be mixed with the masculine. This transmutation, therefore, is not celebrated at the vernal equinox, but on Easter, which can not occur until after the full moon has

brought a partnership and exchange with the sun, from the natural sign of marriage.

This process, started at Easter, is carried forward as the Sun enters Taurus, the exchange of the finer forces fecundating the earth (Taurus) to bring forth the grass and flowers. For while Aries is the exaltation of the Sun, Taurus is the exaltation of the Moon, and the Sun moving thus into the exaltation of the Moon after the partnership has been formed carries forward the process of fructification. This process by which fecundity is assured is pictured in Arcanum XIV; and is thus associated with the sign Taurus; for the bull also is a symbol of fecundity.

Human Function

—Already it has been shown that Libra, and Arcanum III, correspond to feeling in its external aspect. Libra is the sign of generation. The other Venus sign, Taurus, is the sign of regeneration, and rules the inner sense of feeling known as psychometry. Psychometry, therefore, is the human function corresponding to Arcanum XIV, which esoterically depicts the sign Taurus.

Alchemy

—Arcanum XIV represents the fluxing of polar opposites, or mental antidotes. When the minerals are predominantly acid, or positive, just enough of the alkaline, or negative, minerals should be added to balance the mixture; and when the minerals are predominantly alkaline, just enough acid minerals should be added to balance the mixture. When positive and negative, acid and alkaline, male and female, energies are of like volume and intensity the ingredients readily fuse and undergo transmutation into a different and far more valuable product. But when either positive or negative elements are not thus balanced by their polar opposite, it takes more energy than can be generated to affect the transmutation.

Bible

—The mystery of union as a spiritual force is set forth symbolically in the story of Jacob. First he wrestled with Temptation, as shown by Arcanum VI, and was Victorious, Arcanum VII. Then falling in love with Rachel, as symbolical of proper physical union he served for her 7 years. Gen. 29:30; “And Jacob served seven years for Rachel; and they seemed unto him but a few days, for the love he had of her.”

But this perfect physical union signified by 7 did not suffice; for it relates that he was deceived into marrying Leah of the tender eyes. That is, his spiritual sight was not thus opened. Therefore, he served another 7 years for Rachel, the 14, as shown by Arcanum XIV, indicating regenerate union.

And so much more satisfactory was this higher fusion that in his great love for her he served voluntarily another 7 years. This 21, as shown by Arcanum XXI, designates the true spiritual fusion, the union of twin souls, the attainment of the Great Work.

In Math. 28:2, we have mention of the Transformation to a new life indicated by Arcanum XIII; “And, behold, there was a great earthquake; for the angel of the Lord descended from heaven, and came and rolled back the stone from the door and sat upon it.” And following this, in Math. 28:18; this new life entered into, or Regeneration accomplished, Arcanum XIV, is indicated thus: “And Jesus came and spake unto them, saying, All power is given unto me in heaven and in earth.”

Masonry

—The Rosy Cross is but another method of expressing the process portrayed by Arcanum XIV. And the same principle is more briefly indicated by the compass. 14 is the second decade of 5; and when wine, symbolical of spirit, is added to the 5, as in the fifth libation of pure wine which is drunk from a skull—the skull represents Arcanum XIII—we again have the principle of regenerate fusion expounded, this time in ritualistic form. And as of universal application, instead of merely personal, Arcanum XIV is well rendered by the mystical letters, INRI, which more correctly stand as the initials of Igne Natura Renovature Integra, meaning, All Nature is Renewed by Fire.

Magic

—Love manifests on all planes and in various degrees of grossness and refinements; for it is convertible as passion, enthusiasm, heat, affection, fire, deific solicitude. In truth, in some form of expression, it lies at the foundation of all activity, all intelligence, and all feeling.

As to man, there are three planes upon which his love-life can express while he is still embodied. And when we consider that the power of an energy to benefit or to destroy depends upon the volume liberated and the intensity of feeling which accompanies it, it should be apparent that grossness, lust and viciousness in sexual matters is one of the most destructive forces upon earth.

Yet as life depends upon harmony, and death follows in the footsteps of discord, when sex is actuated by mutual esteem, and mutual harmony results, it has even as great a building power. The harmonious exchange of energies between husband and wife tends to build health, to prolong youth, and to increase the vitality.

Then as to the offspring, the intensity of the father furnishes the vital force, and the intensity of the mother the magnetic constitution.

The general health is thus usually more dependent upon the mother than the father, but the length of life more dependent upon those vital energies furnished by the father. And upon a balance between these two, as shown by the Sun and Moon in the birth-chart, depends in great measure the discords and harmonies, the fortunes and misfortunes, of its life.

But Arcanum XIV treats of a plane above that indicated by Arcanum VII. It reveals the mysteries of regenerate love.

Regenerate love does not consist of any physical act, nor does it consist of refraining from any physical act. Instead, it is a blend and exchange of finer forces. This blend and exchange can take place between husband and wife even while they are far distant in space from each other. In fact, when properly established, there is a continuously consciousness of each other on the part of both, and the fusion is more or less continuous. It is the beautiful ecstatic union between two who are devoted to each other, and who feel the most tender emotions toward each other.

It is a pure and holy relation, and has nothing in common with the practices of certain mediumistic individuals who leave their body to dissipate themselves and express unrestrained passion while thus on the astral plane. All such practices are destructive, and once were features of the witch's sabbat. They are much more destructive, because more intense and less subject to control, than physical dissipation; and are harder to break off because of the magnetic bondage established.

Nor is the regenerate union a matter of forced celibacy; for this often stimulates to unnatural desires, and always leads to an unbalanced magnetic condition which is undesirable.

Instead, it is merely the complete fusion of the finer forces of two purified souls who are working together in loving harmony, and in tender sympathy, for the advancement of the race. This fusion may be broken at times through intruding discords from without, but is again established at the first opportunity, and is maintained as completely as possible.

Initiation

—In the soul's initiation, Arcanum XIV indicates that state of advancement in which there is spirituality enough so that the animal desires and passions are transmuted into tender expressions of love which establish and maintain, with the matrimonial partner, a constant exchange of the finer energies. At this state of the soul's pilgrimage there still may be occasional physical expressions; but the chief and most satisfactory avenues for manifesting love are now purely in the ecstatic and devoted exchange of invisible forces.

Occult Science

—Practical Occultism is the application of the knowledge concerning astrology, concerning psychology, concerning alchemy, and all other invisible properties and energies to the affairs of everyday life. As such it corresponds to Arcanum XIV.

The Solar Spread

—The Solar Spread is based upon the 50 posts, or gates, of initiation. It thus depends upon correspondences to the seven active principles of nature which penetrate the

seven departments of human endeavor, for its revelations. The spread as a whole constitutes the jubilee, or fiftieth factor.

The cards are shuffled and cut as usual, and then they are dealt from right to left in 7 rows of 7 cards each as illustrated on page .

The cards should be turned over as read, starting at the bottom row and reading from right to left.

When the birth-chart of the consultant is known, each row of 7 cards reveals those things that the planet ruling the row governs in his birth-chart. And in all cases the three cards to the right of the middle card in any row govern the past of the department of life, the middle card represents the present condition, and the three cards to the left of the middle card reveal the future developments concerning this department of life.

When the birth-chart is not at hand, or, if the reader is unfamiliar with astrology, each row is read as referring to the department of life generally signified by the planet in front of the row.

Thus the bottom row, as ruled by the Moon, governs the home, the domestic life, the public, and if the querent is a man, his wife.

The second row from the bottom is ruled by Mercury, and has rule over studies, travels, writing, papers, brethren and the fruits of intelligence.

The third row from the bottom is ruled by Venus, and relates to love, society, friends, partners, cash and art.

The fourth row from the bottom—the middle row—is ruled by the Sun and signifies the honor, health and vitality, and if the querent is a woman, indicates her husband.

The fifth row from the bottom is ruled by Mars and relates to accidents, antagonisms and enemies.

The sixth row from the bottom is ruled by Jupiter and refers to business, occupation, employment and religion.

The seventh row from the bottom—the top row—is ruled by Saturn and relates to elderly people, real estate, sickness, losses, sorrows and secret things.

Chapter 10

Serial No. 30
Original Copyright 1936
Elbert Benjamine

Copyright
Church of Light
August 2002t

Talismans & Charms

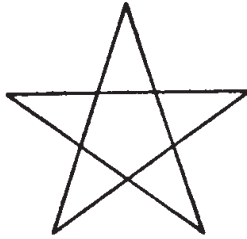

6	5	4
---	---	---

3	2	1
---	---	---

	W	
15	14	13

9	8	7
---	---	---

12	11	10
----	----	----

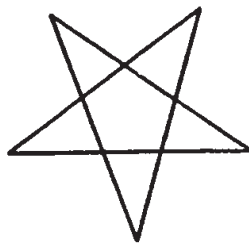

THE WISH SPREAD

The Wish Spread

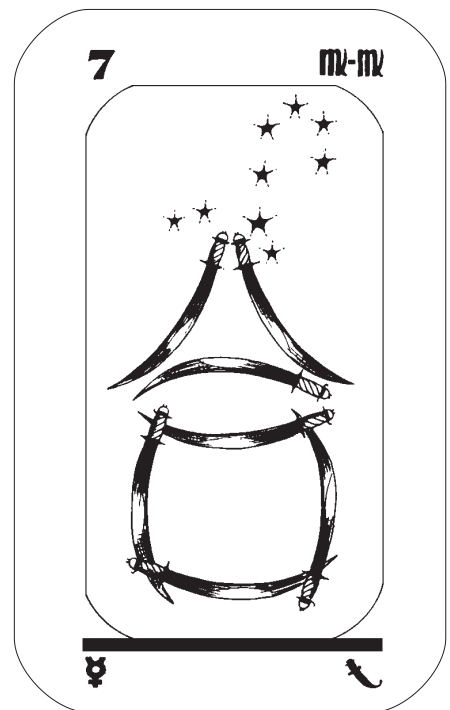
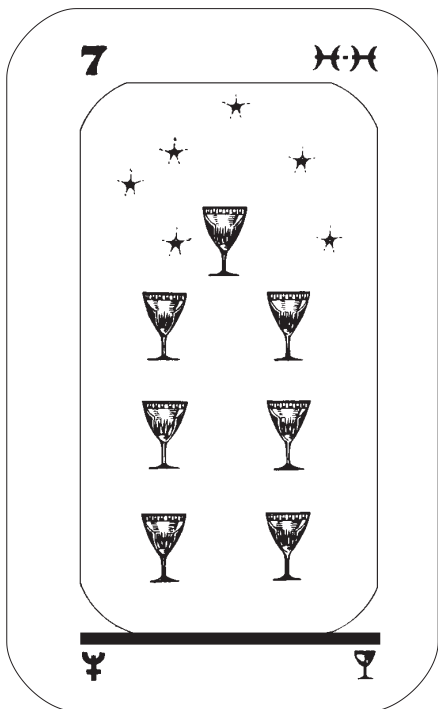
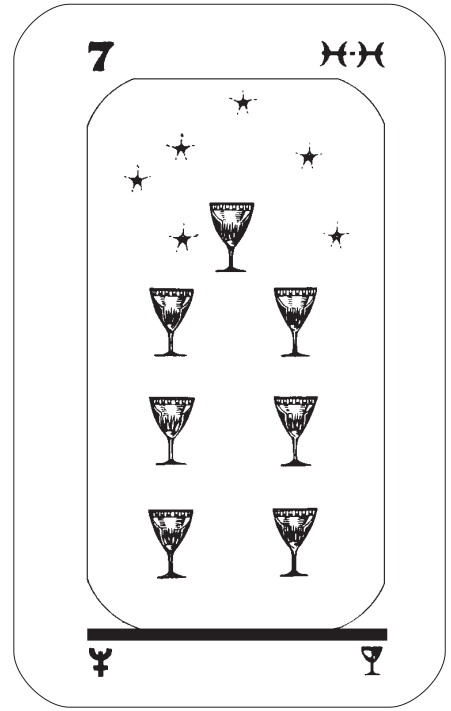
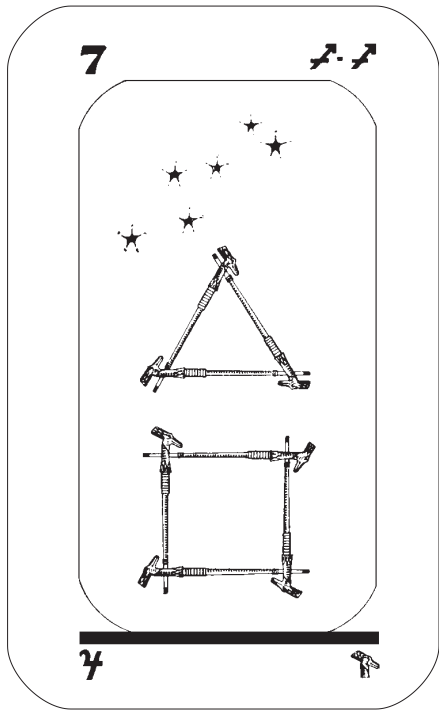

Chapter 10

Natural Talismans and Artificial Charms



OF THE three types of invisible energies which have a power to influence human life and destiny, I have already given consideration to those thought vibrations emanating from names and numbers. Trains of thought are more specifically treated, in their effect of changing the organization of the astral form and thus attracting certain types of events into the life, in Course 9, *Mental Alchemy*. Thus, in this and other courses, I have quite fully explained the use and effects of thought vibrations. And in Course 10-1, *Delineating the Horoscope*, I have gone into the subject of astrological vibrations. There remains yet to consider, therefore, only character vibrations.

The character vibrations of localities, climates, and types of environment are set forth in Chapter 5 of Course 8, *Horary Astrology* and Chapter 2 of Course 12-1, *Evolution of Life*; the character vibrations of plants and minerals are stated in connection with the various Arcana in this course; and the character vibrations of colors are explained more specifically in chapter 9 of this course.

Now, of course, the subject of character vibrations is as wide as the universe itself; for every object and condition has its vibratory rate, which may influence those associated closely with it. We, therefore, can not hope to exhaust this subject; but I feel that some mention, at least, should be made of the vibratory quality of musical tones; and that, because of their unusual potency, both artificial charms and talismanic gems should receive special consideration.

Musical Tones

—Music has two influences. The first is that which influences the mind through its suggestive power, reaching it through the physical sense of hearing. The rhythm, harmony and melody thus reaching the consciousness stir up emotional states and physical responses. Whether certain music is beneficial or not depends upon the individual. If it stimulates gross and selfish, or destructive, thoughts and feelings, it is detrimental to the individual. But if it engenders feelings of tenderness, the desire for helpful service, and aspirations to a noble life, it is beneficial.

But the tones of a musical composition have an astral vibratory rate as well as a physical one. The chief vibratory rate, and the one that thus has most influence directly upon the astral body, is that of the Key in which the composition is played. This key is itself a musical tone; for instance, the Key of C. The Key of C has an astral vibratory rate which is the same as that radiated by the planet Mars, or by the letter O. The direct astral effect of a tone, or of a musical composition played in the Key of that tone, may be known by referring to the tone associated with each Major Arcanum.

Talismanic Gems

—Talismanic gems differ from artificial charms in that the influence of a talismanic gem is that of its character vibration, while the influence of a charm is almost wholly due to the thought vibration imparted to it.

Gems are particularly active crystals which have been attracted about lively and energetic souls occupying the evolutionary plane of the mineral kingdom. The active life of the astral form of the soul occupying a gem reflects itself somewhat in the brilliancy of the gem. And due to the high degree of astral intelligence possessed by certain kinds of gems, and due to the powerful character vibrations which they radiate, they become among the most important of all character influences with which we can associate, in their power to impart energy to the structure or zone of the astral body of a person closely associated with them.

Now a birth stone is merely a gem ruled by the zodiacal sign occupied by the Sun on the day of birth. And because the dynamic thought structure in the astral body mapped by the place of the Sun in the birth chart is a very powerful thought group, a gem ruled by this sign, when worn, through adding energy to the structure mentioned, undoubtedly is rather powerful to influence the life.

But, as pointed out when discussing other things which add astral energy to structures and zones of the astral body, whether this rather powerful influence will increase the power to attract good fortune or will increase the power to attract misfortune, depends upon whether or not, as shown by its aspects, the Sun structure thus given power is harmoniously or discordantly organized.

The rising sign, also, corresponds to very strong thought cells within the astral body. Consequently, a gem ruled by the rising sign in the birth chart has a powerful influence upon the person. The intensifying of these thought cells lends itself to a more energetic personality. This may have its advantages. But whether such a gem will attract harmonious or inharmonious events through the greater energy of the personality depends on whether or not the rising sign in the birth chart is harmonious or discordant.

Furthermore, because certain stellar structures and zones of the astral body, as shown by the house positions of the birth chart, tend more to influence certain departments

of life, and other structures and zones to influence other departments of life, either a gem or a person taken into close association adds energy to the thought cells of the astral body in that zone which accentuates a given department of life. That is, either a gem or a person adds energy to the astral body of the one associated with it chiefly in that compartment ruled by the dominant astrological influence of the gem or person. Therefore, in selecting a talismanic gem, or any associate, this should be kept in mind, and such should be chosen as will add energy to the particular department of life where help is most desired.

If the gem is desired, for instance, as an aid to business success, it should have the same character vibration as the sign or planet in the birth chart most harmonious to business. If the gem is desired as an aid to matrimonial harmony, one should be worn having the same character vibration as the sign or planet in the birth chart most harmonious to matrimony. But for general purposes, a gem may be selected that has the same character vibration as the best planet or sign in the birth chart.

A word of caution should be inserted here; for jewelers who are not occult students, and have only a desire to push the sale of whatever gems they may have in stock, sometimes get up a list of birth stones according to their fancy and their particular need for sales. That is, having heard of birth stones, but having no actual knowledge of astrology, they give certain stones to certain months with no real information on the subject.

The gem given to each zodiacal sign, in association with the Major Arcana, is the one which, according to the ancients and according to competent occult students who have checked as to accuracy, has been found most potent as having the character vibration of that sign. To these gems listed under the Major Arcana should be added these other available gems which most powerfully have the character vibrations of the planets:

Sun—Sunstone.

Moon—Moonstone.

Jupiter—Chinese Jade.

Mars—Hematite.

Venus—Red Coral; also Amber.

Artificial Charms

—Charms do not owe their potency to their character vibrations, but to the thought vibrations imparted to them in their preparation. Therefore, the substance used in the making of charms should be mediumistic, in the sense of receiving and retaining thought influences.

We all know that a piece of iron, a knife blade or a nail, for instance, if rubbed repeatedly with a magnet, takes on the magnetic condition and itself becomes

capable of attracting and holding other objects. In like manner certain other metals—chiefly gold, silver, copper and tin—have the ability to take on, retain, and exert the influence of, a thought vibration imparted to them. That is, whatever thought influence is imparted to them with proper ceremony and at proper time, becomes a part of the charm, and the charm henceforth radiates this thought influence, whatever it may be.

Metals, unlike gems and stones, are very negative, and radiate almost no character vibrations; but they readily, for this reason, absorb thought vibrations that may be imparted to them. Organic substances, also, may be used in the manufacture of charms, if pains be taken to select only those which, like the young sprouts of peach, willow and witchhazel, are negative in quality.

The black magician usually makes his charms of organic substances of revolting character and in grotesque form, the symbolism thus tuning him in on the type of invisible force he wishes to attract and use. To this inversive image—as in voodoo rites—he attaches a diabolical thought form by means of ceremonies and invocations to the spirits of evil; the hideousness of the rite exciting the mind to fever pitch and releasing emotional energy of sufficient volume and intensity to impregnate the charm with the sinister thought and attach to it elemental forces. The fate of those who make such charms as this is well depicted in Arcanum XVI.

Evil charms, however, are not always the outcome of design; for mediumistic substances often absorb the mental images unconsciously impressed upon them. Houses in which there has been great mental anguish, or terrifying emotions associated with tragedy, sometimes become so permeated with these thought forms as decidedly to be uncomfortable, and even unlucky, for subsequent occupants. For this reason rooms in which there has been much sickness and suffering should not be occupied, without special purification and ceremony, by sensitive persons.

Certain famous jewels, though not in themselves especially mediumistic, and therefore not particularly suited to becoming charms, nevertheless, through tragedies associated with them, have come to exercise such an evil function. The emotional activities accompanying the tragedy have attached to the gem a vicious elemental, which is not the astral counterpart of the gem, but an added intelligence of malignant potency which guards it and brings misfortune to all who possess it. Such is the Hope diamond. And as probably bearing a more deliberate curse, are the treasures taken from the tomb of the Egyptian, Tut-Ank-Amen.

For ordinary purposes of making a fortunate charm, 14k gold or sterling silver is excellent. For special purposes a charm for a man may be made of 21k gold, 1k silver, 1k copper and 1k tin; and a charm for a woman may be made of 21k silver, 1k gold, 1k copper and 1k tin. The silver in the gold charm and the gold in the silver charm are responsive to the feminine element in man and the masculine element in woman; while copper and tin exercise the functions denoted by the planets Venus and Jupiter, the love element and the devotional.

Such a charm should be made only for some constructive purpose which can injure no one. The thought the charm should carry should be imparted to it with due ceremony and with as much high emotional intensity as possible, at midnight (completing the ceremony just before that time) of the full moon (the midnight that occurs just previous to the Moon making its opposition to the Sun). If the Moon is in a negative sign, so much the better.

Whatever thought is thus imparted to the charm, it will carry, and impart to the wearer. And it is potent to bring good luck, or any certain type of event into the life of the wearer, in proportion to the clearness and the intensity of the thought thus imparted to it.

The Black Magician—Arcanum XV

—Letter: Egyptian, Xiron, Hebrew, Samek; English X. Number, 15. Astrologically, the planet Saturn. Color, blue. Tone, G. Occult science, weather predicting. Human function, the physical body. Natural remedy, naturopathy. Mineral, lead.

X—15, expresses in the spiritual world, predestination.

In the intellectual world, mystery.

In the physical world, unseen fatality.

Remember, then, son of earth, that the most unprofitable thing in the world is selfishness. Pride and rebellion but enchain the soul to lower spheres; but all trials and misfortunes accepted with resignation to the supreme Will are an accomplished progress bringing an eternal reward. If Arcanum XV should appear in the prophetic signs of thy horoscope, cease to rely upon thy own power and wisdom and labor to disengage thyself from pride and selfishness, which but bind thee to matter, mortality and evil Fate.

In Divination, **Arcanum XV** may be read as **Fatality** or **Black Magic**.

Arcanum XV is figured by Typhon, genius of evil, standing triumphantly over the ruins of a temple. In his right hand he holds a scepter surmounted by a circle resting between two divergent bars. These spreading bars signify the inversive forces that hem in and hamper the influence of spirit, represented by the circle. It is the emblem of hatred and division.

In the other hand this creature holds the torch of destruction, whose blaze has been applied to the ruins of the temple. He is crowned with flame to indicate he is not of this world, and he has the wings of a bat, to indicate he is a denizen of the realm of darkness. The horn on his nose signifies stubborn rebellion.

He has the breasts of a woman and the organs of a man, and is thus hermaphrodite, emblem of self centeredness and a being devoid of love. The body is that of a hog, to denote greed. The feet are those of a goat, to indicate the sign Capricorn, the home sign of Saturn, or Satan; the sign most devoted to material ambitions. And the beings

chained at the feet of this master of chaos also have goat heads, indicating that their intelligence has been used exclusively to further material and selfish ambitions.

This malignant entity has the head of a crocodile, symbol of cruelty. The snake emerging from his body, instead of from his brow, indicates the use of the creative energy, not for enlightenment, but for physical gratification. It also represents mediumship, rather than conscious control; for the chief center of power in disintegrative mediumship is the solar plexus.

The two men with goat heads chained by the neck at the monster's feet represent the certain fate that awaits all who use magical powers to attain selfish or purely material ends. Sooner or later they become slaves of the very forces they have used, and are finally completely destroyed in body and mind; and even after passing to the next life, are chained by their evil deeds in the underworld.

All such evil entities, of this plane and the next, survive by preying on the ignorance and credulity of others, as shown by the sign of sorcery they make with their hands. They are racketeers and gangsters of both planes; and the ensemble, taken as a whole, indicates both the bondage and the fate of those who follow the inversive path and become dominated by the spirit of selfishness.

Number

—Numerically, 15 is the second decade of 6. Arcanum VI represents Trial and Temptation, and Arcanum II, being negative, may bring a yielding to such temptation to use invisible energies to gain personal ambitions at the expense of others. 15, therefore, in this sense, is the number of black magic. 5 is the religious hierophant, indicating the intellect dominating the elemental world. But adding 10 brings a change in fortune; and if this change of fortune precipitates the master from his height, the 5 is reversed, and the elemental world dominates the intellect. Thus the higher the station the farther the fall, and when such fall occurs, the exalted priest becomes a prince of evil, and is then represented not by 5, but by 15.

Astrology

—I suppose, from a very extensive study of birth charts and the influence of progressed planets in the lives of people, that the influence of the planet Saturn coincides with at least one-half of the total of all human suffering and misfortune. He is the planet of crafty selfishness, and, more than any other planet, seems to represent inexorable fate. He well corresponds to Arcanum XV.

Human Function

—The physical body is man's universe of matter. It is the external vehicle through which the soul gains experience and manifests its developing attributes. It should always be governed by consideration of what actions, thoughts and feelings

contribute most to universal progression. But, alas; all too often it is made merely the seat of animal gratification and the organ by which to gain purely selfish ends. As the most external of man's forms, and thus the least spiritual, the physical body corresponds to the planet Saturn, and to Arcanum XV.

Alchemy

—Arcanum XV is the impure ingredients which must be eliminated in any type of alchemy. In mental alchemy they are the discords which are annulled. In spiritual alchemy they are the material effects as distinct from the influence on the character. And in general this Arcanum represents the dross which rises to the surface of the fluxed mixture as a skum, or excess slag, which must be skimmed off and cast aside.

Bible

—All the various references to Satan give us the picture of Arcanum XV. Thus, Math. 8:31; "So the devils besought him, saying. If thou cast us out, suffer us to go away into the herd of swine." So the forces obsessing these men passed into swine, or were symbolized by swine, because of their greed. And their dashing down a steep place to perish in the sea well depicts the condition and the end of those who are ruled by selfishness; their affinity for evil forces precipitating them into frightful practices that are supported by abandoned emotions, and which, sooner or later engulf them in an ocean of misery.

Arcanum XV is also the star of religion inverted: Rev. 8:10; "And a third part of the waters became wormwood; and many men died of the waters, because they were made bitter." That is, the emotions of men became corroded by selfishness.

Rev. 9:1; "And the fifth angel sounded, and I saw a star fall from heaven unto the earth; and to him was given the key of the bottomless pit, as the smoke of a great furnace; and the sun and air were darkened by reason of the smoke of the pit." Thus is described in accurate symbolism the slums and hells of the astral region, and the works that emanate from these regions.

Some maintain that the inversive brethren can have no organization, but they are certainly misinformed. These entities are, in truth, the racketeers and gangsters of the life after death. Even on earth bandits and gangs have their organizations and their leaders. And such parasites on society when they pass to the other side retain all their evil propensities and their cunning. They are human beasts of prey, that hunt down and try to destroy the defenseless.

Their chief method of getting victims is through having ideas widely accepted that are untrue and which place people in their power. To get these ideas thus widely accepted, they have recourse to thought dissemination, to the suggestive power of repetition, to insinuations, to platitudes, and to inversions.

Inversion is a method of presenting some idea in a manner that the lie is deeply and inconspicuously concealed amid much truth. The more real the facts, and the more widely they are recognized as facts, the better they afford cover for some cunning lie. The inversive twist, by which the whole matter is made to appear to have a meaning exactly the opposite of its true purport, is made to occupy so small a portion of the whole presentation, and is so cunningly concealed by sophisticated handling, that it escapes the notice of all but the most acute. And this inversive twist—the misinformation or misinterpretation—is so worded as to be subject to no direct and simple test of accuracy. It is left as full of loopholes as possible, so that when one presentation of the matter is proved to be a lie, it can be said that, after all, something else was meant.

These inversions, having their origin in the astral hells by those who would prey upon the credulity of the human race, are well symbolized by smoke arising from the pit to darken the sun and air. And St. Paul recognized this invisible influence when he says, Eph. 6:12; “For we wrestle not against flesh and blood, but against principalities, against powers, against the rulers of the darkness of this world, against spiritual wickedness in high places.”

Masonry

—In the Past Master’s degree, the power of the forces indicated by Arcanum XV are represented by a riot when the candidate attempts to preside over the lodge and is dethroned. The Secret Master’s degree is represented by Arcanum XIV. But the Master’s Elect of Fifteen degree is indicated by Arcanum XV, in which the ruffians who assassinated Hiram Abiff are overtaken and captured. They attempted to take passage to Ethiopia, the dark underworld region, but were overtaken and paid the penalty.

Magic

—In Magic, Arcanum XV indicates all those methods by which the selfish and evil strive to gain control of others, to exploit them, and to make them their slaves. This subject is elaborated in detail in Chapter 6 of Course 18, *Imponderable Forces*.

But here it is convenient only to point out that as soon as some religion, some political doctrine, or some philosophy gains a goodly following, that the common course is for it to fall into the hands of those who use it for their own selfish interests.

There are those on both planes who have powerful intellects, but no spirituality. They are intelligent beasts of prey, having no sympathy, and no kindly feelings for others. They are dominated by a greed for power, and permit nothing in heaven or earth to stand in the way of their ambition.

By means of thought diffusion—by sending out powerfully charged thoughts, they dominate weaker thoughts, and thus collect them as a snowball gathers in size as it rolls down hill—they gain acceptance of certain ideas, which are utterly false, but

which are advantageous to themselves. They worm themselves into the highest positions of authority by showing power of leadership. And as soon as they reach a position where they can do so they begin to betray their trust by warping ideas and twisting truths, so that doctrines which were once spiritual and pure become the very reverse of this.

Christianity at start boldly set out to renounce the sword, and to be purely socialistic in its regard for money and property. But as soon as it gained sufficient following those came into control who made it a religion whose followers are noted for seeking power and worldly goods, and who carried, by means of torch and sword, their religion into every land. With rifle bullets to back them they thrust the Christian religion down the throats of weaker and less organized people the world over, and made them trade for their merchandise, greatly to Christian profit. The missionaries have been pioneers of trade, backed by soldiers, and later have been instruments for keeping the doors of trade open.

The bloody crusades were for the purpose of establishing the religion of peace and good will by means of the sword. And Christianity, as witnessed by the world wars, continues to tolerate the murder of one nation by another. I am not commenting on whether war is necessary, or whether the preachers did right in praying that God would help their soldiers kill the enemy. I am merely pointing out, that right or wrong, the original teachings of Christianity, as soon as the religion grew strong, were twisted to mean just the opposite of their original intent.

Confucianism was originally merely an interpretation of the Tao, but it degenerated into a political lever used to persecute those who followed other doctrines. Mohammedanism was to abolish priests and rituals, but in after times these returned. Buddhism now, having been practically driven from India, teaches many things diametrically opposite to its early doctrines, and like Brahmanism in India, is a great political power.

Perhaps no doctrine was ever concocted and forced on a people quite so successful in keeping them servile and in despoiling them as Brahmanism and its caste system, based on the doctrine of human reincarnation. Through investing the priesthood with the authority to say what acts give good karma and what acts bad karma, and the belief in its followers that bad karma is responsible for all the ills of life, and that doing anything the priests forbid condemns the individual to suffer in the next human incarnation, it places an absolute power in the hands of the priests which they use to enslave the people while themselves living in luxury.

The effort is made also, in certain quarters, to discourage a belief in a self conscious, progressive, enjoyable life after death. It is taught we must return to earth to gain experience, over and over again. But the evidence of this inversion is too strong. Thousands are proving for themselves that their loved ones still live in full consciousness, and can, under specific conditions, yet communicate with those on earth.

But behind all these inversions, stands the cunning, destructiveness and selfishness of those on both planes, who, in some manner, profit by confusing and deluding men.

Initiation

—In the soul's pilgrimage Arcanum XV represents the meeting with the Dweller on the Threshold.

This threshold dweller is Selfishness, and can only be overcome by a rigid determination to live for the good of the whole and its progress, rather than for self. When the individual decides, no matter where the path leads, to step only in the direction of universal progress, to work only constructively, he meets the grim dweller of the threshold.

You may be sure that racketeers and gangsters on either plane resent with tremendous venom the rescue of victims from their clutches. Those who attempt to enlighten their brethren, consequently, often suffer vile persecution.

Savanarola and other noble martyrs, were liberators of mankind from dark ignorance, and paid for it with suffering. Martin Luther was not dreaming when he threw his ink well at the devil; and he meant vastly more than appears on the surface when he announced he married to please himself, to vex the Pope and spite the devil. For where love is not, selfishness rushes in to fill the void; and ascetism, through extinguishing the finer emotions, prevents the building up of spiritual strength. Intellect alone can not build a spiritual body. It is feeling that creates. And the ascetic crushes out the very emotions of sympathy and kindness, of love and devotion, which otherwise would build an immortal vehicle for his soul.

Occult Science

—Weather predicting is the science of forecasting, chiefly by means of astrological charts and positions, what weather will prevail on a given date. As influencing weather, especially weather of severe character, the planet Saturn seems most important. Therefore, this science corresponds to Arcanum XV.

Youth Court Cards

—The Youth of Scepters signifies a person ruled by the sign Sagittarius: benevolent, free, jovial, quick tempered, energetic and fond of outdoor sports. Right way up it denotes a Sagittarius man; reversed it indicates a Sagittarius woman. The dominant idea is I SEE.

The Youth of Swords signifies a person ruled by the sign Capricorn: crafty, subtle, reserved and avaricious. Right way up it denotes a Capricorn man; reversed it indicates a Capricorn woman. The dominant idea is I USE.

The Youth of Coins signifies a person ruled by the sign Aquarius: witty, argumentative yet amiable, artistic, humanitarian and fond of refined society. Right

way up it denotes an Aquarian man; reversed it indicates an Aquarian woman. The dominant idea is I KNOW.

The Youth of Cups signifies a person ruled by the sign Pisces: negative, timid, listless, harmless, and much influenced by those about him. Right way up it denotes a Pisces man; reversed it indicates a Pisces woman. The dominant idea is I BELIEVE.

The Lightning—Arcanum XVI

—Letter: Egyptian, Oelath; Hebrew, Ayin; English, O. Number, 16. Astrologically, the planet Mars. Color, red. Tone, C. Occult science, Stellar Diagnosis and Stellar Healing. Human function, the animal soul. Natural remedy, thermo-therapeutics. Mineral, iron.

O—16, expresses in the spiritual world, the chastisement of pride.

In the intellectual world, the exhaustion of the mind which attempts to penetrate the mystery of God.

In the physical world, the ruin of fortune.

Remember, then, son of earth, that only God is absolute. If Arcanum XVI should appear in the prophetic signs of thy horoscope, reflect on the old oaks that have defied the ravages of time and have finally been brought down after a century of immunity; and think that thou too mayst be brought low at the very moment of thy great arrogance by some unexpected blow.

In Divination, **Arcanum XVI** may be read as **Accident** or **Catastrophe**.

Arcanum XVI is figured by a pyramid decapitated by a thunderbolt. A crowned and uncrowned man are precipitated from a platform built of seven stages, falling down with the rest of the debris.

A pyramid is the most stable of solids, is the symbol of the earth, and also represents the climax of earthly security. As composed of four trines, which are its sides, corresponding to the houses of a birth chart, it symbolizes the horoscope of physical life. From mineral up to man there are seven degrees of mundane life, the seventh, or last stage of incarnation, being that of man. After one incarnation of man, and thus gaining self consciousness, the soul continues its progress in higher-than-physical spheres. Thus the platform on which the men were standing represents the last incarnation in matter.

That the pyramid has been struck by lightning to the disaster of both a crowned and an uncrowned man, symbolizes that Nature is no respecter of persons, and that she strikes down both the high and the low, kings as well as subjects, who transgress her law. It is also the symbol of those rivalries which are so common among men, which divert energies into channels that result in ruin for all. It signifies sterile projects, ill considered enterprises which are doomed to failure, ambitions which are frustrated, and death by catastrophe. And it represents the false security which results from

material success and the reliance upon purely material science, as well as the sure punishment which is attracted ultimately by all those who use magical forces in the attainment of selfish ends.

Number

—Numerically, 16 is the second decave of 7, and thus represented by Arcanum VII, or complete physical union, used on the negative plane of Arcanum II. In this aspect it indicates the power of sex to destroy, when actuated by any motive other than love. Lust, selfish gratification with no care for the feelings of the other, union actuated by desire for gain, and union in the practice of magic, all generate a force, but this force is destructive in quality. Sex magic, in particular, generates a frightful force, but, as indicated by 8 plus 8, in the end reacts on the user and brings to him a violent punishment.

Astrology

—Astrologically, Mars is the planet of passion, of war, of violence, of accident, of sudden destruction. As such it is well portrayed by Arcanum XVI.

Human Function

—A great deal is said in condemnation of the animal propensities that so frequently crop out in the actions of men. But these animal propensities are merely men's most valuable assets in a state of undevelopment. They should not be encouraged to express their animal activities, it is true, yet without them to furnish energy, still higher functions would have no power.

Nature has been at great pains to develop those qualities which lead to self preservation and race preservation. These qualities are selfish, having been developed through the struggle with other forms of life, for survival. But even though they are, on the animal plane, self centered, and dedicated largely to the destruction of enemies and the gaining of sustenance with no thought as to the consequence to others, nevertheless, in order thus to preserve and provide for self and family, creatures have developed initiative and an energy supply. This energy supply and aggressiveness is the force behind the animal soul of man, to which Arcanum XVI corresponds.

Yet without this animal energy man would have no force, would be able to accomplish nothing. The animal propensities are the sole source of his energy, they are the reservoir from which he must draw for any spiritual accomplishment. Intellectual force may be on the plane of the animal, seeking selfish ends, or on the plane of the spiritual, seeking good for all. But while man is still in the flesh, even spiritual energy must draw its force from the volume of energy developed by the animal; transmuting it merely, that is, diverting it from a selfish to an unselfish,

purpose. Therefore, before there can be a vigorous divine soul, or a vigorous spirituality, there is usually present a vigorous and active animal soul.

Alchemy

—In Alchemy, Arcanum XVI represents the heat of the reverberatory furnace. This, on the mental plane, is supplied by feeling, the feeling of pleasure or pain. On the spiritual plane it is supplied by a still higher type of feeling, by aspiration and inspiration; and in its highest manifestation it arises from an insatiable longing to assist to the highest possible degree in the advancement of the universe and the happiness and joy of all forms of life.

Bible

—Elijah built an altar of twelve stones, represented by the four triangular sides of the pyramid of life shown in Arcanum XVI. Kings, 18:38; “Then the fire of the Lord fell, and consumed the burnt sacrifice, and the wood, and the stones, and the dust, and licked up the water that was in the trench.” The fire is seen thus falling in the Arcanum under consideration.

Sex magic also is mentioned in Revelations, and the destruction of all those who follow such practices: “Mystery, Babylon the Great, the mother of harlots and abominations of the earth.” And, Rev. 16:18, “And there were voices and thunders, and lightnings; and there was a great earthquake, such as was not since men were upon the earth, so mighty an earthquake, and so great.”

The great pyramids of Mexico, and those of the Mound Builders of the Mississippi Valley, had a flat place on top, where a fire was built by a priest. Atlantis is reputed to have been sunk in a single night by volcanic action and earthquake. Sodom and Gomorrah perished by fire and brimstone, and the Tower of Babel, according to Bible tradition, was never completed. And to still further clarify Arcanum XVI, it may be repeated that those who take up the sword perish by the sword, that those who seek to destroy others, themselves meet destruction.

Masonry

—In Masonry, the Master’s Elect of Nine degree is based upon Arcanum XVI. We find that Joabert steals ahead of the other pursuers, and discovering one of the assassins of Hiram Abiff asleep, stabs him in the head and in the heart, then cuts off his head and carries it home.

The 15 craftsmen who conspire to murder Hiram are represented by Arcanum XII. Tubalcain represents the constructive attributes of the planet Mars, while Cain represents the destructive side. Thus the three assassins of Hiram, and their punishment, as well as the act of Cain, are symbolized by Arcanum XVI.

Magic

—Arcanum XVI illustrates one of the most certain principles of magic, that any destructive force sent against another, when the period of its orbit has been completed, will return to inflict punishment upon the sender.

To send out an evil, or destructive, thought or force, a corresponding center, or point of projection must be formed in the astral body. This nucleus of evil, or discord, itself attracts influences of like quality, and thus ultimately brings misfortune upon the one who projects such a force.

To fight an invisible force is but to increase its power, unless the source of it is completely destroyed; for thinking about it in the act of fighting it keeps the person tuned in on its vibratory rates. One can, of course, build a protection of cold deflective armour about oneself, which will prevent the entry of such a force. Still better, one can tune in on some entirely different interest so strongly that the invisible energy is cut off, the receiver hung up. This is the safest of all methods.

But to start in to fight any individual, on any plane, by means of mental force, is dangerous, and nearly always brings punishment. I do not mean that injustices should be permitted. But that thought force, or magical energies, sent against another, usually do as much damage in the long run to the one sending them, as to the one against whom they are sent. Truth must be upheld, and the weak protected. But not by using mental magic as a weapon.

Evil influences can not exist in an atmosphere of love and constructive effort, nor can they penetrate into such a region. Therefore instead of sending out other discordant vibrations in combat, evil forces should be ignored, and only constructive thoughts built up and sent out. Such constructive efforts, together with the high energy supplied by love, paralyze any force of evil; for it can accomplish nothing in such an environment.

Initiation

—In the soul's pilgrimage, Arcanum XVI indicates that stage of development where the neophyte finds himself called upon to protect those weaker than himself from the influence of destructive psychic forces. But whether these forces are such as arise from the practice of disintegrative forms of mediumship, or are those directly from the inversive magi, either on earth or in the astral, he should obey the admonition of the Bible to overcome evil with good. If he builds the things he desires, if he constructs love and harmony, destructive forces can find no point of contact or influence.

Occult Science

—Stellar Diagnosis and Stellar Healing is the science of diagnosing from the birth chart and progressed positions of the planets the nature of the disease, and of applying the appropriate energies to the physical and astral bodies which will restore harmony; for all disease is caused by discord. Such a discord is depicted by Arcanum XVI.

The Wish Spread

—The wish spread, pictured on page 178, is used to determine if some wish will be realized. First a card to represent the one making the wish is selected and placed face up in the center of the spread.

The cards of the deck are then spread out, face down, and fifteen of them to be used in this spread are selected at random. The other cards are then discarded.

The fifteen are shuffled and cut in the common routine manner, and dealt, one at a time, face downward. Three go to the left of the central card, three above it, three to the right of it, three below it, and three in the center on it.

To read, turn those over to the left—1—2—3, saying, “This is what surrounds you.”

Then turn over and read those above—4—5—6, saying, “This is your wish.”

Next turn over and read those at the right—7—8—9, saying, “This is what opposes you.”

Following which turn over and read those below—10—11—12, saying, “This is what comes to your home.”

And finally turn over and read those in the center—13—14—15, saying, “This is what you will realize.”

If the wish card—the 9 of cups—appears anywhere in the reading except in “This is what opposes you,” it is a sure sign that the wish, at least in part, will be realized. The place where it falls will determine how soon it will come, the closer it is to card 1 the sooner the matter will come to pass. But if the wish card—the 9 of cups—falls on 7, 8, or 9, the desire will not be gratified, and the cards will show why.

When the wish card—the 9 of cups—fails to appear, if the cards are very favorable the wish will come true, but if unfavorable, it will be denied. In either case the cards by their different stations will indicate the details and show why the result is as denoted.

Chapter 11

Serial No. 31
Original Copyright 1936
Elbert Benjamine

Copyright
Church of Light
August 2002

Chronology of the Tarot

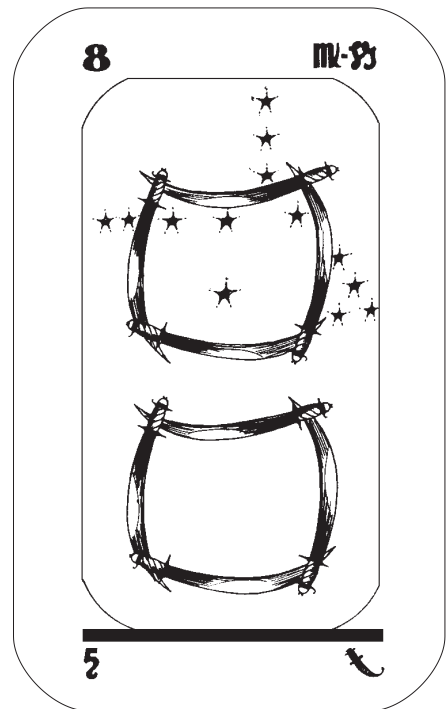
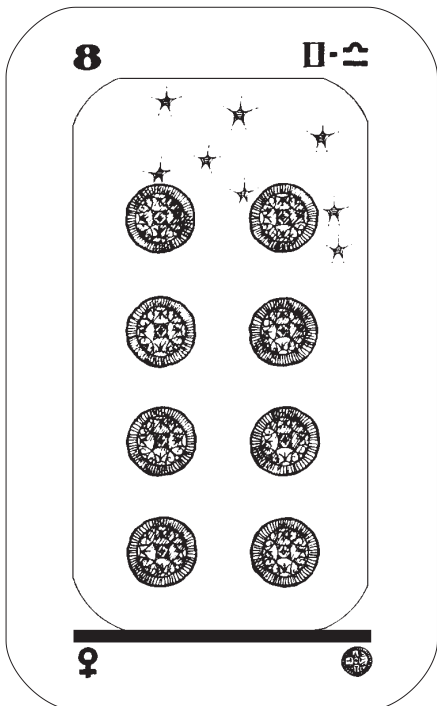
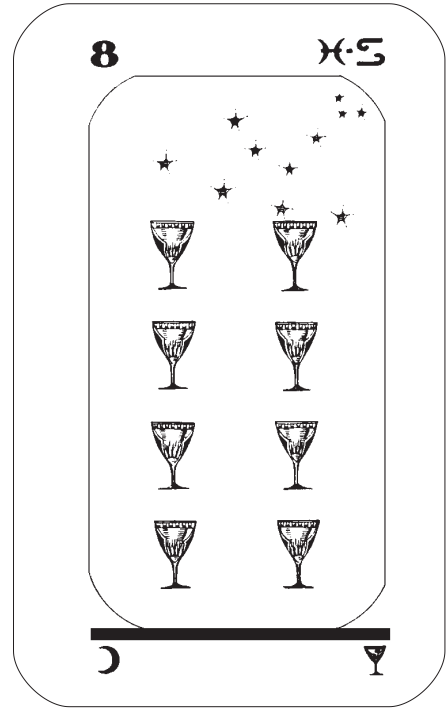
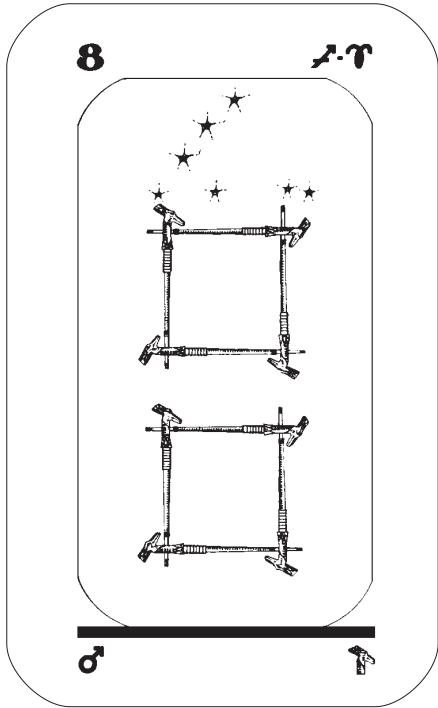

Chapter 11

Chronology of the Tarot



S the tarot is a pictorial synthesis of the universe, not only must it correspond to astrological influences, but also to the various divisions of time which are measured by these influences.

Already I have pointed out in some detail the strict correspondence between the 22 Major Arcana and the 10 planets and 12 zodiacal signs, that the 12 common Court Arcana describe people born under each of the 12 signs of the zodiac, and that the 4 horseman Court Arcana signify thoughts that relate to the 4 departments of life.

Now, as fully explained in Chapters 1 and 2 of Course 10-1, *Delineating The Horoscope*, each zodiacal sign is divided into three equal sections, called decanates. Each of these decanates embraces 10 degrees of the zodiac and has an influence distinctly its own. Thus in each quadrant of the zodiac there are 9 decanates. These decanates of the zodiac, however, each belong to one of the four elements; that is, to the triplicity of fire, of water, of air or of earth. The 10th, or transitional influence, therefore, represents the element to which the 9 decanates belong; for the 9 decanates are distributed among the three signs which make up one of the zodiacal triplicities. Thus the Minor Arcana of any one suit do not belong to one quadrant of the zodiac, but to signs in three quadrants; the triplicity to which they belong being designated by the suit, and the 10th Minor Arcanum of each suit, representing the completion of the cycle of that element and a transition to some other, more conveniently being placed adjoining the fixed sign of the element to which its suit belongs.

The astrological relationship of each card of the tarot is given in the key on page 21 of chapter 1. This key contains vastly more than is apparent at first glance, and is well worth careful study followed by deep meditation. The ring of the key shows the rulership of each decanate and each triplicity of the zodiacal circle in relation to each of the 40 Minor Arcana of the tarot. The stem of the key shows the relation between each planet and sign to one of the 22 Major Arcana. The wards of the key turn in the three worlds; physical, astral and spiritual. And the people who exert an influence in these three worlds, and the four types of their thoughts, are shown on these wards as the 16 Court Arcana.

Here, however, we are more interested in chronology. The 12 common Court Arcana which represent people born during each of the 12 months, of course, correspond to

the 12 months of the year. The 4 Horsemen, who represent the type of influence each person exerts through his thoughts, correspond to the distinctive influence exerted by each of the four seasons. If we include the 40 Minor Arcana, giving to each suit 13 cards in addition to the Horsemen, they then correspond to the influence of the 4 seasons, which contain 13×4 , or 52 weeks. And the 22 Major Arcana then represent the 22 astrological influences that cause the weeks and seasons.

The numerical value of the Minor Arcana of each suit, obtained by adding their numbers, is 55; or 220 for all 40 cards. The value of the Horsemen is one each, or 4 for all; and as each Major Arcanum represents a single principle, if we omit the no-numbered tarot for the present, it gives us for the value of the whole tarot pack, 220 plus 120 plus 4 plus 21, or 365. The value of the 12 common Court Arcana is 10 each, or 120.

Yet the no-numbered tarot does not represent exactly zero, but any indeterminate quantity, which in this case may be taken as a trifle more than $\frac{1}{4}$. This no-numbered tarot, which here is given an arbitrary value of slightly more than $\frac{1}{4}$, represents both the unknown factors of astronomical calculations and of human endeavors. It recognizes that both people and stellar bodies have the power to deviate slightly through the use of their own volition from any orbit defined for them by environmental influences. It thus signifies the inherent power of action known as Free Will. But in the Chronology we are considering it becomes something more than $\frac{1}{4}$ day in excess of 365, such as is found in a year.

The Birth-Chart

—Turning now to a more practical application, it is found that the Major Arcana can give the astrologer additional information, when it is required, about a birth-chart or a progressed chart. The chart may be completely read, if desired, by placing each of the Major Arcana on the place occupied in the chart by its corresponding astrological sign or planet. Then it should be noted what might be expected, in the houses where the influences fall, from such combinations of forces as are shown by the tarot cards when united, either discordantly or harmoniously, as indicated by the astrological aspects.

The chief value of the tarots to the astrologer, however, is their use in this manner when he is in doubt, or needs additional information. When, in natal astrology, horary astrology, mundane astrology, stellar diagnosis, or in any other branch, he finds some difficult problem, such as determining what will transpire under a certain progressed aspect; if he will combine the cards according to the aspects and conditions in the chart, they often will shed an illuminating light that makes the answer clear.

Talismans Other Than Gems

—Although stones and gems are more durable than others, they are not the only substances that can be used as talismans. Plants, for instance, have a temporary talismanic value when worn by those in whose birth-charts the sign ruling the plant is harmonious. And because some plants may be quite antagonistic to an individual, it is much better to select plants for the home and garden, not indiscriminately, but with the end in view of obtaining such as have a strengthening quality of astral vibration, and the aromas of which furnish subtle essences harmonious to the soul.

For talismanic purposes the young growing shoots or the parts bearing the flowers and seeds should be used. A good time to gather plants, either for talismanic or medicinal purposes, is during the hour just before the Moon rises in the sign ruling the plant, the best time being just at moonrise while the moon is in the sign ruling the plant.

Animals also sometimes have an influence similar to talismans, this being particularly true of domestic pets, such as cats, dogs and horses. When the attachment between the pet and its master is pronounced there is a keen desire on the part of the animal to afford protection and benefit. This desire stimulates its unconscious mind. And the unconscious mind, even of a creature much lower in the scale than man, through its psychic senses, has a very wide scope of perception. Not being inhibited by reason, the things that it thus senses psychically may make quite a strong impression upon it, and cause it to behave in such a way that it warns its master of approaching evil.

Even after the animal dies, its strong attachment to its master may cause it to linger in the astral realm quite close to him. Its unconscious mind, thus free from physical limitations, has a scope of intelligence far beyond what we expect of such an animal on earth. It perceives, from the astral plane, the events that affect its master. And it keenly senses his wishes, and desires that these wishes shall be granted.

It may thus, from time to time, be able to convey to him, through dreams and impressions, a knowledge of such conditions as are about to affect him. Or it may follow him to the seance room, and if this be of a certain low order, assist in manifestations there.

I am not assuming that an animal, just because it passes to the next plane, acquires human intelligence. But an animal which has had much human association while on earth, has little difficulty in sensing just what its former master wants. Just as, while on earth, a dog will fetch a stick that its master throws, so on the next plane will it try to do that which will please. It has not acquired human intelligence, but because it is free from the body its unconscious mind has a wide scope of perception, and it is more responsive than ever to its master's thought. And it sometimes finds opportunity to manifest an intelligence of a not very high order in the seance room.

But aside from talismans and exceptional types of influences, the various objects of our environment each radiate a characteristic energy. If an object vibrates to the frequency of an astrological influence which is beneficial in our birth-chart, through increasing the strength of the harmonious vibration in us it renders us assistance. But the association with either objects or people which stirs up in us consciously or unconsciously, a feeling of discord, should be avoided as much as is practicable; for we attract events into our lives that correspond to the discords or harmonies we harbor within.

Response to Healing

—This same principle explains why some people respond readily to one type of healing and some to another. By inspecting the birth-chart and the progressed chart the astrologer quickly can determine which planet's vibrations are chiefly responsible for the trouble. Then by referring to the Arcanum ruled by the planet he can find the Natural Method of treatment which is commonly most efficacious in correcting the discords caused by the planet.

Thus if Mercury causes the affliction, mental healing is particularly applicable. If Neptune is the chief disturber, the disease is more susceptible to spiritual healing. Jupiter brings ailments that need a corrective diet. Venus tends to depletion that may be treated with rest and recreation. Uranus produces peculiar disturbances in the electromagnetic body that often yield readily to electricity and mesmerism. The discords of Pluto yield quickly to stellar healing. Water is the natural remedy for the afflictions caused by the Moon, and light for those caused by the Sun. If Mars is the disturber there is usually a temperature to be reduced, and if Saturn is back of the discord you may be sure that the vitality is low and needs earth-baths and outdoor life to build it up.

The affliction shown by a planet, due to the sign it is in, may manifest its discord in any one of the twelve zones of the body. In this course certain herbs ruled by each sign are given under the Arcanum corresponding to the sign. This will enable you to select those suitable for temporary talismans, or those that, through a corresponding vibratory rate, most readily affect the part of the body ruled by the same sign. For more details of the rulership of specific diseases you are referred to Course 16, *Stellar Healing*, on Stellar Diagnosis and Stellar Healing.

Herbal remedies are administered according to two different schools of thought. The homeopathic system is that like cures like. From the occult point of view this means that an herb belonging to a certain sign, if taken into a healthy organism in excessive amounts, tends to cause a diseased condition of the corresponding part of the body. But if that part of the body is already diseased, the taking of the herb corresponding to this part of the body in very small amounts, builds up and strengthens this part of the body with its similar vibratory rate. In other words, the remedy is applied in such quantity as will give the diseased part the vigor to overcome the disease.

But this system can not be successfully applied to all diseases. Hence we have the allopathic system, which works on the principle that contrary cures contrary. From the occult point of view this means that the disease itself is attacked and an attempt made to annihilate it by means of something violently antagonistic to it. Instead of building up the vigor of the diseased part of the body, the attempt is made to destroy the disease and eliminate it from the body. Fire is thus fought with water, earth with air, and Mars with Saturn. This method seemingly is necessary to combat certain virulent diseases, but, through the violence of the remedies used, is much more apt to impair the constitution.

Here, of course, no attempt is made to discuss the relative value of medicines, or to give instructions in the specific cure of diseases through the administration of herbs. Instead, I merely give such hints as to the relative principles of underlying cures as I hope will prove of value to those who specialize in healing. From these hints they should be able to work out, in connection with their experience, the application in detail. And when the nature of the disease is obscure and the method of treatment in doubt, the use of the tarot as a divinatory instrument, by one who has some skill, can be used both in diagnosis and in determining the most effective treatment to secure a speedy recovery.

The Star—Arcanum XVII

—Letter: Egyptian, Pilon; Hebrew, Pe; English, F—P—Ph. Number, 17. Astrologically, the zodiacal sign Gemini. Color, the lighter shades of violet. Tone, high B. Occult science, cosmic alchemy. Human function, the sense of sight. Natural remedy, such herbs as madder, tansy, vervain, woodbine, yarrow, meadow-sweet, privet and dog-grass. Mineral, the talismanic gem beryl, and such stones as are striped.

F—17 expresses in the spiritual world, immortality.

In the intellectual world, the interior light which illuminates the spirit.

In the physical world, hope.

Remember, then, son of earth, that hope is the sister of faith. Shed thy passions and thy errors in order to study the mysteries of true science and the key will be given thee; then a ray of divine light will break from the occult sanctuary in order to dissipate the shadows of thy future and show thee the way of happiness. If Arcanum XVII should appear in the prophetic signs of thy horoscope, whatever may happen in life, never injure the flower of hope and thou wilt gather the fruits of faith.

In Divination, **Arcanum XVII** may be read as **Truth, Hope** or **Faith**.

Arcanum XVII is figured by a blazing star of eight rays in the center of which is a white trine with point upward joined at its base to a black trine with its point downward. This star is surrounded by seven other stars. It hovers over a nude young girl who has one foot upon the sea and one foot upon the land, and who pours the fluid of universal life from two cups, one of gold, the other of silver. Near the girl is a

flower of three blossoms, and above the upper one a butterfly opens its wings.

This young girl is the emblem of truth. She is nude, signifying that truth can be perceived only when stripped of the preconceived ideas and dogmatic opinions with which it has been clothed by the artificialities of civilization.

She rests partly upon the land and partly upon the sea to denote that truth is dual, the truth of reality and the truth of appearances, the truth of the practical and the truth of the ideal. The fluid is poured from a silver cup into the sea to indicate that the loving, emotional side of man's nature must be nourished if he is to grasp the inner truth. And it is poured from a golden cup upon the land to denote the necessity of cultivating the positive, reasoning intellect if he is to possess the external truth.

The fluid flowing from the golden cup represents the forces of man, and that from the silver cup the forces of woman; together revealing the truth of soul-mate-hood, and indicating how the finer energies of man rejuvenate woman and how the finer energies of woman rejuvenate man; their forces mutually sustaining each other and making a joint immortality possible.

The eight-point star symbolizes the Law of Equilibrium, the balance between spirit and matter, male and female, the inner and the outer. It is the book of the apocalypse sealed with seven seals, and thus represents the inner realization and the outer realization, the birth of the soul and the birth of the body, under the influence of the planets, represented by the 7 surrounding stars, or seals.

Each of these smaller stars, or seals, has four points, to signify that man should recognize the nature of its influence and realize how to direct it into channels of his own choosing.

The two trines of the larger star symbolize the Hermetic Axiom, "As it is below, so it is above," and reveal that evolution implies a preceding involution. It also indicates the necessity of experiences with both good and evil for soul progression.

The flower of three blossoms represents the three planes of existence from which the soul sips the nectar of wisdom, gaining thereby the strength to attain immortality, symbolized by the butterfly.

Number

—Numerically, 17 is the 2nd decave of 8, denoting the crystallized condition of Arcanum VIII polarized to the frequency level denoted by Arcanum II. It is involution followed by evolution, for, after all, matter is but polarized spirit. In the universe there is but one Principle, which manifests under two modes of motion as force and will. There is but one LAW, and this is sex, manifesting as male and female. There is but one Agent, which manifests as spirit and matter. And there is but one Truth, which manifests as appearance and reality. This is the truth represented by the star of Arcanum XVII.

Astrology

—The most pronounced symbolism of Arcanum XVII pertains to its duality, and the most dual sign of the zodiac is Gemini. This sign, pictured among the constellations as the Twins, representing Reason and Intuition, belongs to the first degree of emanation of the airy triplicity, and therefore represents the most interior and free use of the intellect. It corresponds to the day house of Mercury, the planet of mental expression, and thus is a fitting symbol of Truth. Better than any other sign, Gemini typifies the duality that sustains all worlds and alone makes life and consciousness possible.

Human Function

—The first step toward truth is perception. This perception should embrace both sides of the situation. And while knowledge requires also an inner comprehension of the meaning of things seen, the necessity for correct sight is implied in the vernacular expression, “I see,” used to signify comprehension. Mercury rules both Gemini and the eyes, and as Gemini corresponds to the day house of Mercury, it is more closely allied with the external vision. And if additional testimony were required to show the correspondence of the sense of sight with Arcanum XVII, it could be found in the restless activity of the eyes, and of the natives of Gemini, in their unceasing search for new information and new experiences.

Alchemy

—Arcanum XVII pictures the finding of the fountain of eternal youth. Gold and silver have been completely purified and the dross removed. Each, united to a proper flux, has been reduced to the first matter in the reverberatory furnace. And as a result of their transmuted union they are no longer merely gold and silver, but a delectable fluid, the coveted elixir of life.

Many have sought, but few have found, this precious draught. Some who have had it ready to their hand, have failed to recognize it. Others have discovered it accidentally, and while deeply awed by its wonderful properties have never perceived its real use and partaken of its life giving properties. More have been poisoned by drinking that which they hoped would prove to be the elixir, a fluid somewhat resembling it, but in reality quite destructive. Yet Arcanum XVII pictures its preparation in unmistakable terms to those who do not discard the simple and plain in search for the intricate and complex.

Bible

—The first pointed reference in the Bible to Arcanum XVII is Gen. 1:27; “So God created man in his own image, in the image of God created he him; male and female created he them.”

Thus is revealed the great truth exemplified in still more detail by the duality shown in Arcanum XVII. For not only does it point out that man is formed in the image of God, that the microcosm is a miniature copy of the macrocosm, but that both are, when complete, male and female. Whatever exists in the starry firmament above, according to both the Bible and this Arcanum, must have its correspondence in the constitution of man. But in addition thus to formulating the relation of the soul to the stars, it states positively that the macrocosm is both male and female; and implies that souls to persist must retain their sex; for when this attribute is destroyed man ceases to be an image of God, and no longer partakes of the divine nature.

John 8:32 reads; “And ye shall know the truth and the truth shall make you free.” Now freedom implies a previous bondage. The bondage here considered is that imposed by the restrictions of the physical. But these restrictions are removed when the truth is perceived of man’s relations to the universe, and that the soul, educated for a definite mission in the cosmic scheme, survives physical death.

Rev. 5:1 mentions Arcanum XVII: “And I saw in the right hand of him that sat on the throne a book written within and on the back side, sealed with seven seals.” This, of course, is the book of nature, under the dominion of the 7 planets; and through a knowledge of it immortality is gained, for it enables the soul to partake of the tree of life mentioned in Gen. 3:22.

Just how this book of nature is to be opened and its contents made plain is quite distinctly stated; “Behold, the Lion of the tribe of Juda, the Root of David, hath prevailed to open the book, and to loose the seven seals thereof.” As the lion is the zodiacal sign Leo, which rules the house of love, it is clear that the affections are used. But this is not the only factor; for next we read that the Lamb took the book. This is the zodiacal sign Aries, ruling the head. And this explains to us, in the language of universal symbolism, that neither love nor reason alone is sufficient, but that truth can be grasped completely only when there is a union of head and heart. And thus does the Lamb here typify the soul which has triumphed over Arcanum XIII, or death, through the combined activity of its intellect and its affections.

Masonry

—The degree of Provost and Judge is based upon Arcanum XVII. The duality of truth is symbolized in this degree by two keys. One is the key to the small ebony box containing the plans for building the temple, that is, the key to understanding the Divine Plan. The other is the key to the ivory box containing the temple keys, that is, the laws which govern the universe and the progress of the soul. The ivory box and

the ebony box clearly indicate that both positive keys and negative keys are required, and that man and woman complement and complete each other.

Magic

—In Magic, Arcanum XVII is the perception of both the external and the internal truth. Such perception is made possible through the cultivation of the soul senses. But, because, through the principle that like attracts like, even a slight desire to deceive others attracts deceiving influences, care should be exercised here. The desires of the unconscious mind, also, have a tendency to warp such information to coincide with them, as it is raised from the astral brain to the physical consciousness. When one becomes unusually sensitive an idea through its sentiment may exert so strong an appeal that the emotion may easily be mistaken for soul response. Then, again, the thought images projected by other powerful minds are sensed by the psychic faculties, and those not fully initiated are apt to respond to these as if they were soul-responses to truth, when they, in fact, are merely being dominated by thought-forms.

Therefore, while the pure intuitions of the soul, when sufficiently freed from various other influences, are reliable guides to truth; for those who have not attained a very high degree of spiritual initiation, they can not be relied upon too implicitly. Consequently, in the search for truth, and in its apprehension, one set of faculties is used to test the accuracy of the other; intuition is used to check the reports of reason, and reason is applied to determine the reliability of intuition. Thus the initiate grasps both the exoteric and the esoteric aspects of truth.

He perceives that every atom of physical life is but the symbolic expression on the external plane of an indwelling spirit-atom. With his psychic vision he notes that every living form is a collection of these indwelling spirit atoms controlled by a central soul monad. This monad furnishes the conditions for their progress, as they do for it, dominating them by virtue of its labors in past incarnations.

That is, every plant and animal, as well as gem and stone, is but the material vehicle through which some soul is evolving and elaborating its powers. These astral entities that mold the form of crystals, plants and animals, causing them to assume the shapes they do, are the realities; for they continue to occupy new and higher forms, while the material forms they inhabit are transitory and unenduring, and consequently but an appearance.

The initiate recognizes the truth of appearance at its true value. He does not deny the existence of matter and its properties; for to those occupying the physical plane misery, disease and sin are as real as are spiritual verities to those occupying interior realms. It is as great a mistake to deny the qualities expressed by material form as to deny the reality of the spiritual ideals causing their expression. To one living entirely upon the physical plane the mere denial that a substance is a poison will not prevent it causing the death of the body. But to suppose that the material particles are the real cause of the fatality is to observe but one side of the truth; for these particles are but

the material vehicles of spirit atoms that have a violent antipathy toward human life. They are really the physical expression of a spiritual ideal, or idea, and this idea can be sensed psychically.

If the spiritual development of the person is such that he realizes his own source and destiny, that he belongs to a higher spiritual state than the destructive forces of the poison, and that by virtue of his function in the cosmic scheme he should and can dominate all submundane atoms of life; in other words, if his spiritual nature is active, he can partake of the most violent poisons, or pass through fire as did Shadrack and his companions, unharmed, because his spirituality enables him to compel the obedience of the spirit atoms of the poison or the elementals of fire, preventing them from acting as usual.

Again, let us glance about us. The initiated see in all our great cities, slums and hotbeds of vice. It is useless to deny their existence, or the many contributing factors in external life that supply them with victims, the chief of which, perhaps, is the mental and magnetic inharmony of the parents at their conception. But even this is only a portion of the truth; for the clairvoyant vision reveals the existence of cities within cities, the lower astral world permeating the physical. The inhabitants of these astral slums are usually as unconscious of the people of the physical world as the latter are of them; yet the desires of the inhabitants of each realm react, through unconscious thought impression, upon the other, and the slums of the astral world stimulate the evil of external life. In fact, it might be said that the external slums are imitations of the inner hells to which they correspond.

Initiation

—In the soul's initiation Arcanum XVII represents the attainment of divine illumination through the perfect rapport of the soul and the ego. The ego is not some mighty angelic power, but an eternal, scintillating atom of Deity, pure and innocent, depending on the soul-monads which are the positive and negative attributes of itself for knowledge of external life. The soul monad becomes closely associated with the brain of man, and when the spirituality is sufficiently active a conscious rapport is established between this monad and its ego. This brings the brain directly in touch with the soul's center of deific life, enabling it to grasp the cosmic idea and realize what portion of that idea it is progressing to express. What God is the soul can never know, but it does grasp its own relation to God, and this truth leads it to freedom. This freedom is not that of annihilation, or a dreamy nirvana, but the ability through increased knowledge consciously to direct its own progression in harmony with the laws of cosmic evolution. Instead of being subject to the stars, it rules them. This illumination brings the conscious knowledge of its missing soul mate.

Occult Science

—Cosmic alchemy is the science of transforming the energies of society as a whole into those types of action that are most beneficial to it, that most effectively assist the highest

development of its members, and that most completely cooperate in the fulfillment of the divine plan.

Horseman Court Cards

—The Horsemen do not represent people, but thoughts or unseen intelligences. As thoughts are ruled by Arcanum I, each Horseman has a numerical value of 1. In divination they are read as thoughts or intelligences that have an influence upon the life of the client. The one who thinks the thoughts is indicated by the Court Card nearest whom the Horseman is found in the spread.

The Horseman of Scepters denotes thoughts concerning business. Right way up, it indicates thoughts advantageous to the client; reversed it signifies thoughts opposed to his business interests.

The Horseman of Cups denotes thoughts of love or affection. Right way up they are sincere and to the client's advantage; reversed they indicate deceit or opposition to the true affectional desires.

The Horseman of Coins denotes thoughts relating to health or money. Right way up, they tend to the prosperity of the client; reversed they are plots to unfairly obtain money from him.

The Horseman of Swords denotes thoughts of enmity, strife or sickness. Right way up, it indicates thoughts devoted to the defense and protection of the client; reversed they are plans and desires for his ruin.

The Moon—Arcanum XVIII

Letter: Egyptian, Tsaidi; Hebrew, Tzaddi; English, Sh—Ts—Tz. Number 18. Astrologically, the zodiacal sign Cancer. Color, the lighter shades of green. Tone, high F. Occult science, mediumship. Human function, spirit communion. Natural remedy, such herbs as water lilies, rushes, cucumbers, squashes, melons, and water plants generally. Mineral, the talismanic gem, emerald, and such stones as are soft and white, including selenite and chalk.

Sh—18 expresses in the spiritual world, the abyss of the infinite.

In the intellectual world, the shadows which envelop the spirit when it has submitted itself to the rule of the instincts.

In the physical world, deception and hidden enemies.

Remember, then, son of earth, that whosoever braves the unknown, does so at his peril. Hostile minds, figured by the black dog, will surround him with ambushes; friendly, servile minds will offer him flatteries; and treacherous minds, like unto the scorpion, will plan to attain their ends through his ruin. If Arcanum XVIII should appear in the prophetic signs of thy horoscope, observe and listen, but know how to be silent.

In Divination, **Arcanum XVIII** is **Deception, False Friends, or Secret Foes**.

Arcanum XVIII is figured by two pyramids at the edge of a road. The Moon above, half obscured by clouds, sheds a pale twilight. One of the pyramids, symbol of the twelve houses of the horoscope, is black, representing an ignorant and unspiritual life. The other pyramid is white, symbolizing a life enlightened by science and spiritual wisdom. In front of it is shown a door, or exit, indicating that those thus enlightened are not earth-bound, but pass freely, when their earthly life is completed, to a life in the higher spheres.

In the road before the pyramids are two dogs, one white and the other black; while between them, in a circle of white, crawls a scorpion. This dim, moonlight scene represents a seance room, the hidden perils of which are more redoubtable than those to be seen. The false radiance of the moon indicates the glamor that surrounds such an occasion. The good and the bad, the ignorant and the learned, symbolized by the pyramids, are gathered there at the edge of the road into the beyond. To such a place there may be attracted lying spirits, as signified by the black dog; friendly spirits, as denoted by the white dog; or treacherous and dominating spirits who have much knowledge, as indicated by the white circle in which the scorpion moves, but who use it to deceive and attain their selfish ends.

Number

—Numerically, 18 is the 2nd decade of 9, or wisdom polarized. Arcanum IX operating on the plane frequency of Arcanum II implies the exploration of secret realms. Such exploration is not without its perils, and should be attempted only by one who has made marked spiritual advancement, or under the guidance of a competent master. Under these conditions the negative and disintegrative states are not permitted, and then 18 becomes True Wisdom regarding the Science of Occultism.

Astrology

—Cancer is ruled by the Moon, and is the zodiacal sign most susceptible to influences from other planes, and most pronouncedly affected by its associates and its environment. The mediumistic quality correlates it to Arcanum XVIII.

Human Function

—Cancer is the most interior degree of emanation of the watery triplicity, and most readily receives and interprets the thoughts of entities occupying the interior worlds. What appears to be intuition often, with people born under this sign, is in reality the prompting of a discarnate entity. This ease of spirit communion corresponds to Arcanum XVIII.

Alchemy

—The true elixir of life has the peculiar power of absorbing and transmitting the energies of the surrounding magnetic atmosphere. If the elixir is pure it absorbs and transmits only the finer, higher, life giving energies. But if impure, it attracts grosser energies. Arcanum XVIII may represent either the true elixir or the false elixir.

The majority who seek this fluid of eternal youth fail to recognize the need for purity, or are unable to discern whether or not the elixir is truly pure. They thus prepare the draught by dissolving in the Water of Pythia whatever metals may be at hand, without precaution as to their purity and proper proportions. They deceive themselves, and drinking the false elixir thus prepared, are drugged into a semiconscious state in which they are unable to perceive even the approach of their own ruin.

Bible

—Saul, in his extremity, consulted a medium at Endor. Sam. 28:8; “And he said, I pray thee divine unto me by the familiar spirit, and bring up whom I shall name unto thee.”

The power of spirits to obsess is mentioned as a matter of course in Math. 10:1; “And when he had called unto him his twelve disciples he gave them power against unclean spirits, to cast them out.”

Paul speaks of deceiving spirits, I Tim. 4:1; “Now the Spirit speaketh expressly, that in the latter times some shall depart from the faith, giving heed to seducing spirits, and doctrines of devils; speaking lies in hypocrisy; having their conscience seared with a hot iron: Forbidding to marry, and commanding to abstain from meats.”

Masonry

—The degree of Initiate Secretary is based upon Arcanum XVIII. Its lower aspect is the spy who listens at the veil and is captured, condemned by Hiram King of Tyre, and finally freed through the intercession of King Solomon. Its higher aspect represents that eminent saint, John the Baptist, to whom modern Masons dedicate their lodge; for the sun is baptised in the Holy Ghost when it enters the watery sign Cancer and reaches the highest, and symbolically the most spiritual, point in its annual journey.

Magic

—Arcanum XVIII explains the process of mediumship. The passive ever becomes the medium of the active, hence matter is the medium for the expression of mind. Broadly speaking, in the sense that it receives and transmits force, everything is

mediumistic. Because the energies of the interior planes are more active than those external, the physical is mediumistic to the astral, and thus astrological forces influence the life of the material world.

Carrying the same thought further, the astral world must be passive to, and the medium of, energies from the spiritual world. Thus may we consider God as the great central controlling spiritual force of the universe, and that from Him down to the densest mineral atom there is a complete, graded scale of mediumship; each higher plane transmitting the One Universal Force to the plane next below, until finally it reaches and energizes the lowest realm.

Even the adept is but the medium for the expression of spiritual ideas upon the physical plane. The spiritual truths externalizing in his life are taught by schools on the interior planes and subsequently verified by his own experiences. The true adept never claims to originate the teachings he gives out; for he recognizes the fact that whatever truth man grasps on the physical plane is due to his reception of it from exalted souls whose interior plane of life enables them to dispel illusion. The truth these exalted beings realize is transmitted to them from still more interior worlds, and so on, to the very throne of God, Who is the absolute source of all truth. But there is a great difference between such conscious and controllable mediumship and that of the person who trusts to some controlling spirit guide, or permits a discarnate entity to use his body as a means of communication.

In the first place it should be understood that under proper conditions it is possible, and frequently happens, that people who have crossed the boundary of physical life do return and talk with their loved ones through the organism of some medium. But the soul world closest to earth is the lower astral, in which dwell earth-bound souls, vicious elementals, depraved elementaries, and a host of other entities, some of which are harmlessly mischievous, some of which are inimical to man, and some of whom desire to use him for their own ends. To abdicate the rulership of the body in favor of whatever unseen entity happens to be present, and that may claim to be anything that suits its purpose, is to court the domination of the soul by entities which may use their advantage to deceive, demoralize, obsess; and which always weaken the will.

Of all places, the public seance room seems to be one least likely to furnish anything of value, for the mixture of the thoughts and magnetisms attracts all sorts of questionable entities. Such conditions favor physical manifestations; for the beings responsible for them belong to the realm of force. Where the electromagnetic energy is present, phenomena can be furnished through an irresponsible medium as readily and as genuinely as can be produced by an adept. But the mediums can not control them.

Much psychical phenomena is faked, because the genuine is so great a drain on the medium that he can not generate the force to produce it often. Yet he feels that he must keep his patronage at any cost. Irresponsible mediumship is fraught with great peril.

Initiation

—In the soul's pilgrimage Arcanum XVIII denotes the neophyte's work in the astral, freeing earth-bound souls from their fetters, assisting those deceived to realize their errors, and encouraging them to strive for a new and better life.

Occult Science

—Mediumship is the science of reception and transmission, embracing the law of affinity and its application in the production of phenomena.

Spread of 36

—This spread is used to give a general reading of conditions and events. After the customary preparatory shuffling and cutting, the cards are dealt one at a time face downward in a square of 36, starting at the bottom right-hand corner.

To read this spread, turn the cards over, from top to bottom, one at a time, in the order of their sequence as given in the diagram on page 211. Read each card as it is turned either as something conditioning the card just preceding it, or as a subsequent event, as the case may be.

The bottom row represents the past, the next row above represents the present conditions, and the cards of the four rows above, each row in its proper sequence, as conditions in the future.

Then, for additional information, after the spread has been read in this manner, start picking the cards up in pairs, reading each pair as some incident of the future. The first two to be picked up and read in this manner are 1 and 36, the next are 2 and 35, and so on until all 18 pairs have been read. This pair reading starts with the immediate future, as denoted by 1 and 36. It is not meant to supplant or contradict the first portion of the reading, but through revealing incidents of the future to shed additional information.

Chapter 12

Serial No. 32
Original Copyright 1936
Elbert Benjamine

Copyright
Church of Light
August 2002

Solution of Ancient Cycles

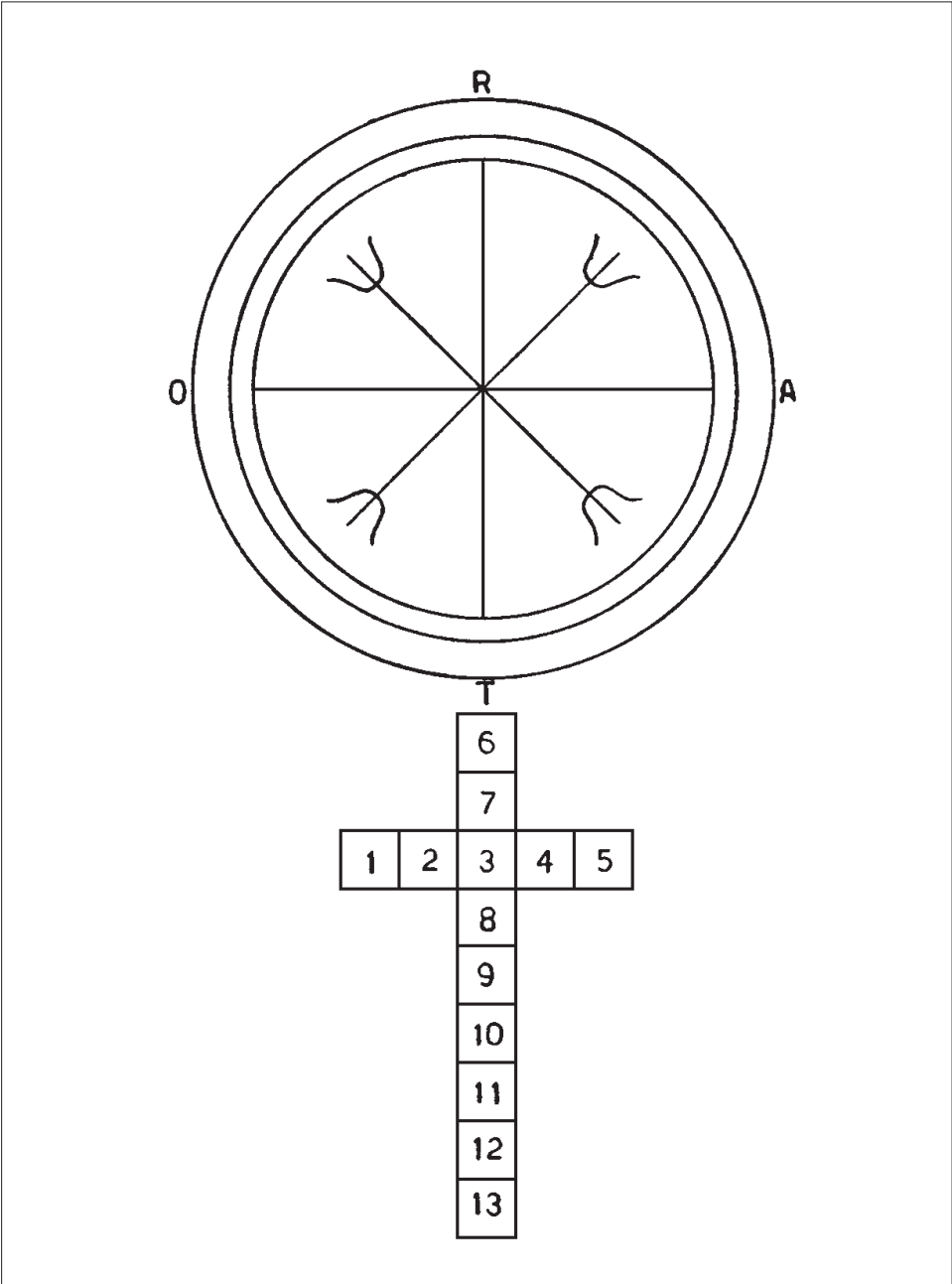

The Magic Cross Spread

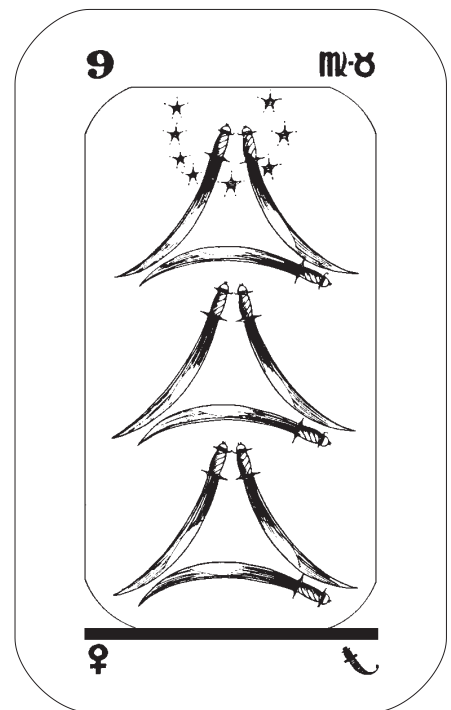
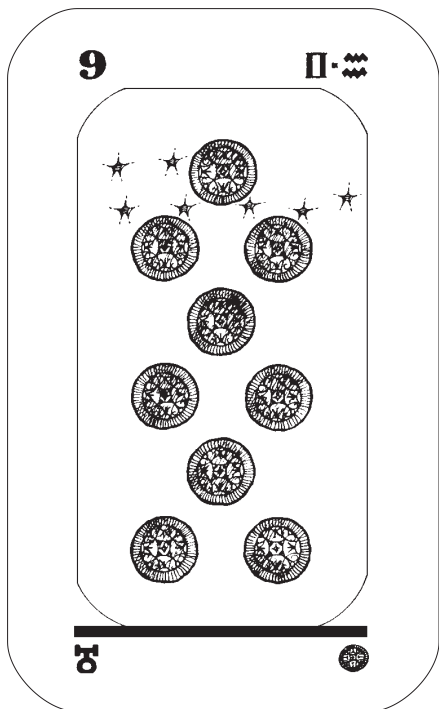
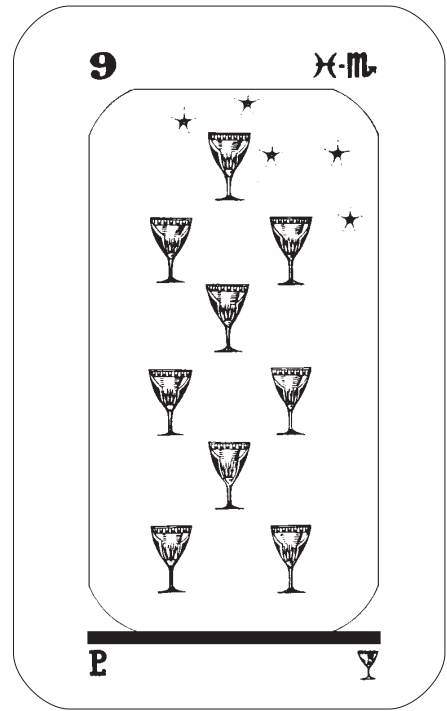
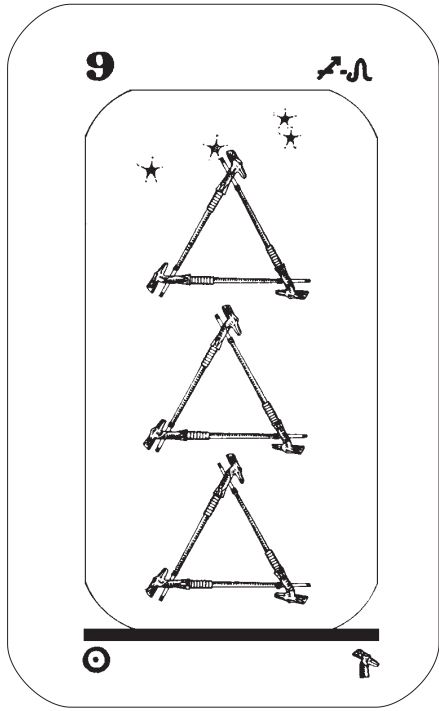

Chapter 12

Solution of Ancient Cycles

LHAVE designated under Arcanum VII that completion and perfection of form, in so far as the three-dimensional plane is concerned, is expressed by the number 7, and under Arcanum IX that the number of astral manifestation is exemplified by the number 9. We are now ready, therefore, to apply these two numbers to the law of cycles.

The cycles man can understand pertain to the physical plane and to the astral plane. He should first, of course, have some knowledge of the completion of form as seen on the physical plane, such as is to be found, for instance, in the septenary grouping of chemical elements. And for this purpose the number 7 is a valuable tool. But behind all such physical expression is the realm of ideas, the realm of astrological vibrations, the realm of the character-vibrations of things. And for the purpose of investigating this inner-plane region, the number 9 should be employed to aid the understanding.

Man, formatively considered, for instance, possesses a sevenfold constitution. Yet viewed from a higher scale, his interior potencies are not properly manifested until he has developed two additional factors, which we call reason and intuition. This adding of an evolutionary positive and negative factor to the outer-plane 7 gives us the inner-plane viewpoint, in which 9 aids the proper explanation.

Or, let us say, the 7 colors of the spectrum give formative expression to light on the earth-plane. But to understand the more essential nature of light, its inner-plane relations must be included. Black and white, the polar opposites, must be added to the physical 7, to get the necessary inner-plane comprehension.

The chemical properties of an element, to consider matter, are subject to the same law, being a periodic function of its atomic weight. But to reveal the thought-quality of the element it must be considered also as possessing a positive and negative, bringing the factors up to 9.

Yet as 10 is the cyclic number, the orbit of the cycles based either on 7 or 9, or both, expand and contract in this manner: Ideal cycles, those which measure intellectual and spiritual force, are solved by applying number 9. Practical cycles, which measure magnetic and vital force and the planes of manifestation, are unlocked by number 7. 10 closes the cycle. And by using 7 and 9 in connection with the cyclic number, 10, it

is possible to solve every cycle in nature below the spiritual plane, from the intra-atomic cycle of the electron up to the orbital movement of a universe.

Why are there 360 degrees in a circle? We can not say it is merely chance. A circle is obviously a cycle, therefore embraces the number 10. It is also in nature the measure of intellectual and spiritual force, as can be observed in the study of orbital motions either of planets or of atoms.

Such orbits always express through four phases, which are well recognized in the moon's orbit as its four quarters, and in the earth's orbit as the four seasons, but are none the less present in all orbital motion. Therefore an orbit, or circle, is the cyclic number 10 multiplied by 4, or Realization (Arcanum IV), giving 40, which indicates any cycle as measuring the Realization of effort.

This number 40, which is the number of Minor Arcana of the tarot, explains all reference to 40 in the Bible as periods in which Realization was accomplished.

But an orbit, as a measure of ideals, or intellectuality and spirituality, is a function of the inner-plane number 9. 9 evolved to the 40th decade is 360, meaning Wisdom (9) Realized (4) in a cycle (10). Thus it is that any point on the earth's surface passing through 360 degrees, or a day and night, is a measure of intellectual and spiritual force as applied to those born at different hours. It causes them to express, not merely the mental activity and repose which humanity at large does each 24 hours, but different Personalities.

In expressing cycles in terms of time, round numbers are used because often there are variable factors, such as are spoken of in connection with the no-numbered Arcanum of the tarot. The most apparent of these variations is that the relation of the Day to the Year is not exactly 1 to 360, but 1 to $365 \frac{1}{4}$.

There is a good reason for this, but suffice it here to point out that the ancients overcame this discrepancy by making their year measure 360 days, and then at the winter solstice cutting out 5 days. Those five "Dies Non" were given over to festivity and were not counted in their calendar. The year, or orbital motion of the earth through 360 (3 plus 6 plus 0 equal 9) degrees, measures to humanity at large not only the variation in light and heat, but the quality of mental and spiritual influx. People born at different times of the year thus express different Individualities.

Furthermore, the yearly return of the Sun by transit over its place in the birth-chart is the measure of spiritual energy received by individual man.

Now if we wish to find the operation of the practical forces in life, we divide the number of days in the year by 7. This gives us 52 weeks. As 5 plus 2 equals 7, we know these weeks relate to practical affairs rather than to spiritual influences. And as a matter of fact, man regulates his physical existence by a week of 7 days.

The Moon, as it passes through the zodiac, by its phases, or relations to the Sun, measures out to man the magnetic expansion and contraction which govern intellectual activity. This cycle is a little more than 29 days. 2 plus 9 equals 11,

therefore the 4 quarters of the Moon measure the Realization of Magnetic Force (Arcanum XI), the practical operation of which depends upon each phase of the Moon of a little more than 7 days. People born with the Moon in different parts of its orbit have different kinds of capacities.

But there is another cycle of the Moon of greater import to the Soul of man. It is the cycle of a little over 27 days during which the Moon traverses 360 degrees of the zodiac. 2 plus 7 equals 9, therefore this cycle relates to intellectual and spiritual forces, and we find actually that this cycle of the Moon from one transit of the Sun to another such transit in the birth-chart, measures the germination of spiritual powers and psychic possibilities.

By virtue of the function of 9, the movements in the heavens during the earth's diurnal motion through 360 degrees measures out the Major events of life to man while the earth moves in its orbit 360 degrees. And the Moon's orbital motion of 360 degrees measures out to man the Minor Events occurring during the earth's orbital motion of 360 degrees. In other words, in natal astrology, whose influences come from the inner plane, the chief events of life are measured to man at the rate of a day for a year, and the minor events of life at the rate of a month for a year; both measures being functions of the number 9.

The Equinox is observed to move at the rate of 1 degree in 72 years (7 plus 2 equal 9). This makes the place of the Sun at the beginning of the astronomical year appear to retrograde through the zodiac 1 degree in 72 years, or through 360 degrees, completing the circle in about 72×360 equal 25,920 years. 25,868 to be exact. This period measures unto man all the different mental and spiritual forces possible during one Precessional Cycle.

This cycle of 360 degrees is divided by 12 into sections corresponding to the zodiacal signs, each section containing 30 degrees. Divide 25,868 by 12, and we get 2,156 years as the duration of one sub-cycle, or Age, as it is called. The equinox passes through the 30 degrees corresponding to each zodiacal sign, and this gives rise to the Age of that sign. It is the measure of the intellectual and spiritual force received by humanity, and determines its general trend.

The equinox, or place of the Sun at the beginning of the astronomical year, retrograded by "Precession" back from the first of constellated Aries, which is the beginning of the circle of stars, 30 degrees, and therefore into the space corresponding to the sign Aquarius, in 1881. The exact date is January 19, 1881. The chart for the hour and minute as well as the date, and a discussion of it, are given in *Astrological Lore of All Ages*. This is the time of the commencement of the Aquarian Age, and because the mental and spiritual force received by humanity is different when the Sun's place among the stars at the beginning of the year corresponds to the place of different zodiacal signs, the student can get some idea of the type of civilization that, past or future, exists while the equinox is in any sign by multiplying 2,156 years by the number of signs removed from Aquarius, and adding to or subtracting from, the year 1881.

History thus records that during the time the Equinox moves by Precession through each sign there is also a change in the practical trend of the mental force and dominant interest about every 308 years. That is, the movement of the equinox through one sign is divided into seven equal periods, the number 7 signifying this formative trend. The duration of this period within the Sub-Precessional Cycle is obtained by dividing 2,156 years by 7, the result being 308 years.

Each of these formative periods is apparently under dominion of one of the seven planets. The Equinox always backs into a sign, entering the end of the 30th degree and moving back to 29, 28 and so on. And by reference to historical events we find that the first period after the Equinox enters a sign precessionally is ruled by the Sun, that the next period is ruled by Venus, the next by Mercury, then the Moon, Saturn, Jupiter and finally Mars as the last period in any sign. Anyone conversant with history can verify the influence of these periods.

From this information, which was first given out by Abbot Trithemius, it is possible to determine in a general way the trend of the intellectual forces as practically applied during any period of 308 years, past or future. If the period was ruled by the Sun the energies were applied to the engrandizement of State or Empire; if by Mars, they were devoted to mechanics and war; if by the Moon, it was a period of intellectual slumber; if by Venus, the energies were given over to art and luxury; if by Mercury, to intellectual culture; if by Saturn, to subtlety and superstition; if by Jupiter, to expansion and benevolence. The Sun started his rule of 308 years on December 23, 1880. Mars ceased to rule Dec. 21, 1880. Or, to be more precise, the solstice of 1880 in December is the point of reckoning from which the student can trace the influence of these periods either forward or backward.

Now we come to a very interesting theory which probably has no valuable practical application. That the obliquity of the ecliptic is constantly changing was observed by ancients as well as by moderns. That is, the Pole of the earth is moving in an orbit at right angles to the earth's diurnal rotation at the rate of about 1 second every 2 years, or 1 degree in 7,200 years. If, therefore, the earth should continue this motion it would turn completely polarwise in $7,200 \times 360$ equal 2,592,000 years. And as turning around completely equatorwise is called one common day, so turning completely around polarwise is called one polar day.

According to modern astronomers, however, the earth does not thus turn completely over polarwise, but after moving through 3 or 4 degrees starts to swing back, according to known laws, which cause it thus to wobble. But because the time involved to observe this swinging back was so great some ancient concluded this polarwise motion continued uniformly on around the circle, and he based his larger periods of duration on this false Polar Day of 2,592,000 years. The days of creation mentioned in Genesis refer to these Polar Days of immense duration.

The Polar Day was known in Egypt, and its duration is incorporated in the Great Pyramid; although just because the amount of average movement of the earth Polarwise is included in this monument does not warrant us to conclude that they

believed the earth thus completely to turn over, as this movement over a few degrees, even though it swings back, is really one of the most important astronomical movements, having profound effects upon the climate and other matters on the earth. And it is this average movement of 1 degree in 7,200 years which the pyramid records.

It should be understood that there is both geological evidence and archaeological evidence as well as modern knowledge of astronomical movements which all indicate that the earth does not turn over Polarwise and that the races which have been assumed to exist never have existed on the earth in physical forms. But because the theory was developed to a fine degree in India, and is the basis of the various sacred cycles there recorded, as well as being linked up with their accounts of races which once inhabited the globe, it is valuable to know it, even as a theory which modern science seems completely to have refuted.

The theory is that the Polar Day is the exact duration of the life-wave on the earth, and that this is the average time of the life on each planet. Therefore for the life-wave to travel once around the chain of 7 planets, and thus give formative expression to and develop 1 Round of Humanity, containing 7 Root-Races, takes $7 \times 2,592,000$ equal 18,144,000 years. Then to produce 7 Rounds of humanity requires $7 \times 18,144,000$ equal 127,008,000 years or 49 Polar Days. Then comes the Jubilee of Nirvana during which Nature sleeps for 7 Polar Days while the life-wave goes once around the septenary chain.

Then, according to this Eastern theory which archaeology quickly disproves, commences the Second Series, and the 7 Families, or Rounds of 7 Root-Races, each ascending to Angelic Spheres to become the parents and Guardians of the new series of humanity.

The number 360 was used by the ancients of the East to veil their sacred cycles, 360 Common Years being called One Divine Year. The Hindus, in their studies, also made use of the cyclic number 10. Thus we are informed that the Divine Maha Yug is composed of 10 Great Ages or Cali Yugs. A Cali Yug is 1,200 Divine Years, or $360 \times 1,200$ equal 432,000 common years, during which the earth's pole, according to their theory of polar motion, was supposed to pass over $\frac{1}{6}$ of its orbit of 2,592,000 years, making the sextile aspect to its own place.

A Dwaper Yug is two Cali Yugs, or 2,400 Divine Years, or 864,000 common years, during which the pole is supposed to pass over $\frac{1}{3}$ of its orbit, making the trine aspect to its original place. A Treta Yug is 3 Cali Yugs, or 3,600 Divine Years, or 1,296,000 common years, during which the earth's pole was supposed to pass over $\frac{1}{2}$ of its orbit, making the opposition to its original place. A Satya Yug, according to these Hindu cycles, is 4 Cali Yugs, or 4,800 Divine Years, or 1,728,000 common years, during which the earth's pole is supposed to pass over $\frac{2}{3}$ of its orbit, making the second trine to its original place.

Furthermore, a Maha Yug is composed of 1 Cali Yug plus 1 Dwaper Yug plus 1 Treta Yug plus 1 Satya Yug, or the equivalent of 10 Cali Yugs, 12,000 Divine Years, or

4,320,000 years, during which, according to the Hindu theory, the earth's pole is supposed to pass $1\frac{2}{3}$ times around its orbit. A Maha Yug is thus composed of 4 aspects bearing the relation 1-2-3-4 to each other, completing the number 10. And a Manwantares is 1,000 times 1 Maha Yug, during which portion of the Great Kalpa the planetary chain has been disintegrated and reorganized several times.

In some sense, for tradition so wide spread is seldom without adequate foundation, there doubtless was a Golden, Silver, Copper and Iron age. Astrological influx combined with climatic conditions at some time in the dim past of the world. We are not justified, however, in believing these ages were dependent in the strict sense upon the hypothetical Polar Day. Yet an account of this theoretical linking up, as derived from Hindu sources, is not devoid of interest.

It was supposed that these ages referred only to the first Round of humanity, and as a matter of scientific fact, the evidence all points that humanity has not been upon the earth longer than the periods embraced within one or two Polar Days. But it is supposed, according to the theory, that these ages recur again as the life-wave leaves the planet, developing the highest states of the round, although they are not strictly called by the same names.

It was supposed that with the pole at right angles to the ecliptic, or sun's path, there was an ideal climate in the temperate zones, and that the climate does not become excessively severe until the pole moves through 4×9 equal 36 degrees. As the pole moves through 1 degree in 7,200 years, this period of the Golden Age was supposed to have lasted $36 \times 7,200$ equals 259,200 years. Then while the pole passed through 3×9 equal 27 degrees, giving the Sun a maximum declination of from 36 to 63 degrees, there were hot long days in summer and cold long nights in winter. This Silver Age lasted $27 \times 7,200$ equal 194,400 years. While the pole passed through 2×9 equal 18 degrees, the Tropics reached an angle of from 63 to 81 degrees, and there were tropical summers and arctic winters on all portions of the globe. This Copper Age is supposed thus to have lasted $18 \times 7,200$ equal 129,600 years.

Then while the pole was passing through 1×9 equal 9 degrees, the Sun was approaching its vertical position once a year to both North and South Poles, and the climatic conditions were frightful. This Iron Age was supposed to have lasted $9 \times 7,200$ years or 64,800 years. These 4 Ages, related to each other by this theory as 1-2-3-4, are embraced in the time the Pole passed over one quadrant of 10×9 degrees, or $90 \times 7,200$ equal 648,000 years. And according to this Eastern theory the place in evolution of our present Great Western Race is that of one branch of the Fifth Root-Race of the 4th Round of Evolution.

Not the slightest evidence has been found to date that man existed on the earth so long ago as is thus implied. The records in the rocks indicate that one round of 18,144,000 years ago takes back to the end of the Oligocene Period of Geology, in which horses were the size of coyotes with three toes in front and three behind, camels were the size of sheep, bison, deer and the ox were small hoofed mammals, dogs were soon to develop to the size of bears, and the claws were developing on what later became

lions, tigers and cats. And if we go back 4 such rounds, geology indicates there were no mammals, that it was a time when reptiles dominated the earth, and the first primitive birds, and the marsupials, forerunners of the mammals, were just developing. Or, if we wish to call the little rat-size marsupials mammals, which later they developed into, we can say they were beginning to develop along the lines we now recognize as mammals, about 4 such rounds ago.

But if we consider the length of time covered by the Golden, Silver, Copper and Iron Age, that is, 648,000 years, there is plenty of evidence that man was on earth that long ago. Also that the earth once had, but not due to polar motion, a mild and fruitful climate, followed by increasing cold, which about a million years ago ushered in an ice age, with intervals of warmth for thousands of years, followed by more glaciers. Racial memory undoubtedly preserves a consciousness of times which were mild and bountiful, followed by times in which there was tremendous cold and hardship. Eden on earth, and the Age of Horrors are dreams which record actual conditions that transpired since men are known to have inhabited the earth.

The Sun—Arcanum XIX

—Letter: Egyptian, Quitolath; Hebrew, Quoph; English, Q. Number, 19. Astrologically, the zodiacal sign Leo. Color, the lighter shades of orange. Tone, high D. Occult science, organic alchemy. Human function, inspiration. Natural remedy, such herbs as camomile, daffodil, cowslip, anise, eglantine, fennel, eyebright, dill, lavender, poppy, yellow lily, marigold, St. John's wort, mistletoe, pimpernel, parsley and garden mint. Mineral, the talismanic gem ruby, and such stones as the chrysolite, hyacinth and soft yellow minerals.

Q—19 expresses in the spiritual world, the supreme heaven.

In the intellectual world, true happiness.

In the physical world, sacred union.

Remember, then, son of earth, that the light of the mysteries is a redoubtable fluid, put by nature at the service of the will. She lights those who know how to direct her; she strikes down with a thunderbolt those who ignore her power or who abuse it. If Arcanum XIX should appear in the prophetic signs of thy horoscope, happiness awaits thee in domestic life if thou knowest how to strengthen the conjugal circle and guard its sacredness in the sanctuary of the heart.

In Divination, **Arcanum XIX** may be read as **Happiness** and **Joy**.

Arcanum XIX is figured by a young man and a young woman holding each other by the hand. About them a circle of 20 flowers springs from the earth. Above is a radiant Sun of 21 rays, in the center of which is the symbol of conjugal union. This sun is the symbol of perfect union expressed on all three planes; perfect harmony of physical desires, intellectual interests, and spiritual aspirations.

The young man and woman are plainly dressed, indicating simplicity of life, moderation of desires and purity of thought. The flowers springing up about them symbolize the joy and happiness of the domestic circle which more than compensate them for material hardships. The 20 flowers signify the potency of domestic harmony to Awaken and Resurrect the spiritual flora of the soul.

This ensemble personifies the fact that when the sexes are truly wed, and the triple laws of harmony are obeyed, that their lives are a constant round of happiness and joy, even amid adversities and privation.

Number

—Numerically, 19 is the third decade of 1; or Arcanum I, Creative Energy, operating on the plane of Arcanum III, or Marriage. Consequently, Arcanum XIX is the application of the Divine Fire, controlled by Will and Intelligence, to the elaboration of domestic bliss. It is not only the perfect nuptial union of 7, but denotes added Sacrifice and Devotion (7 plus 12 equal 19).

It may, or may not, indicate the union of soulmates. But it certainly indicates the union of souls harmonious on all planes, not merely for the purpose of spiritual advancement, but also for the production and rearing of children and to experience the joy of a home. Yet in fact, the harmonious vibrations set in motion, and the sacrifices necessary in the rearing of offspring, are most potent factors in developing the spiritual nature.

Astrology

—Astrologically, the house governing pleasure, joy, happiness, children and love affairs, is ruled by the zodiacal sign Leo. Leo governs the heart and its sympathies. It is the signifier of such love as springs unselfishly into existence as the result of natural harmony, rather than the artificial marriages that today are all too common, which are prompted by material advantages. This “Lion of the house of Juda,” as it is called in Revelation, corresponds to Arcanum XIX.

Human Function

—Inspiration means the indrawing of the spirit. The source of all life and energy and spiritual power is the Sun, and He is the true source of inspiration. Leo is the home of the Sun, the heart center of man through which the Sun exerts its strongest inspirational power. Leo, therefore, corresponds to the capacity to receive inspiration. Love, which is ruled by Leo, is acknowledged to be the power which opens the inspirational gates. This is symbolized by the Sun overshadowing the lovers in Arcanum XIX.

Alchemy

—In alchemy, Arcanum XIX represents the quaffing of the true Elixir of Life. This does not bring instantaneous perpetual youth, for perpetual youth is the result of the gradual changes which the Elixir sets up in the finer forms.

This Elixir is really a love potion, and the result of quaffing it is a general and complete harmonizing of all the internal vibratory rates, so that they sound a sweet and powerful chord, the pitch of which gradually rises as the body and desires are refined, and in time thus results in youthful vigor added to perpetual life.

Bible

—In the Bible, Arcanum XIX represents the increase of oil by Elisha: 2 Kings, 4:6. “And it came to pass, when the vessels were full, that she said unto her son, Bring me yet a vessel.” Again in Kings 2nd, 4:17; “And the woman conceived, and bare a son at that season that Elisha had said unto her, according to the time of life.”

In the New Testament we find, Math. 5:9, “Blessed are the peacemakers; for they shall be called the children of God.” And Rev. 22:17, “And the Spirit and the bride say, Come. And let him that heareth say, Come. And let him that is athirst, Come: and whosoever will, let him take the water of life freely.”

Masonry

—In Masonry, Arcanum XIX is the basis of the Intendant of the Building degree in which the vacancy left by Hiram, the lost soul-mate, is filled. As the third decave, or marriage function of the creative 1, it is mentioned in the first Masonic degree: “Behold how good and how pleasant it is for the brethren to dwell together in unity! etc.” Furthermore, Arcanum XIX is the Lion’s paw grip by which Hiram Abiff is finally raised.

Magic

—In Magic, Arcanum XIX represents the sanctity of the home circle, within the protection of which, when it is harmonious and pure, there is utmost safety from any and all forces of evil.

Where there is complete harmony, the forces of discord, and all evil tends to discord, can not intrude. The harmony between two who love devoutly is repellent to pernicious thoughts and pernicious entities. It is a hallowed circle of invisible influence which they can not penetrate.

For this reason, and because the unselfish feelings developed in the rearing and care of children tend powerfully to raise the dominant vibratory-rates far above any which

can be reached or influenced by pernicious entities, these do their utmost to discourage domestic life and the rearing of children.

It is even taught in some quarters that a woman who bears children forfeits her chance of spiritual attainment in this life; and not until she reincarnates again and lives a non-child-bearing life can she expect to make much spiritual progress.

This is patently an inversion of the real truth; because spiritual progress depends upon love, unselfishness, and the refinement of the thoughts and emotions, and nothing develops these soul qualities faster than the love and care of a parent for children. The love of parents for their offspring is often the saving grace of their lives, keeping the inward affectional fires burning, whose warmth transmitted to the soul, keeps it from sinking into the icy death of self-centeredness.

The bearing of children on earth corresponds to sacred functions in the spiritual world. And while it is true that economic conditions, as well as pronounced discords in the fifth house of the birth-chart, may be severe enough that it is the wiser course not to bring children into the world, as they could not be given proper support and proper vigorous bodies, yet such conditions contravene nature, and occasion the loss of valuable experience to the soul.

The very fact that childlessness is always indicated in a birth-chart by severe discords, shows that such a condition is in the nature of an affliction rather than a benefit. Such a childless life can only be compensated for, in its effect upon the soul, by some marked and continuous effort, to benefit and care for some section of mankind, or some work for mankind as a whole.

There is a great amount of foolishness taught concerning the possibilities of eugenics. In order that men should profit as does domestic stock, through proper breeding for results, it would be necessary to place a practical breeder in charge of the whole human race, with the power to prevent the mating of all humans except a few superior individuals whom he would select, and to be able to compel the union of any man and woman, regardless of their desires in the matter. Such power, which is the secret of a stock-breeder's success, is not likely to be given any man.

It is possible, within limits, however, to select the birth-chart of a child and thus determine many of the characteristics which the child shall possess. It is possible, also, through proper environment, to encourage characteristics which otherwise would not develop. And the ancient magi believed that an ideal image of characteristics of the future child, held by both parents before and at the time of conception had a powerful effect in determining the kind of soul attracted to the form thus conceived. They held also, as elaborated in Course 4, that the mental plane in general of the parents, as indicated by their daily thoughts, and their harmony or discord in relation to each other, had a still further influence in shaping the destiny of the future child.

Initiation

—In the soul's pilgrimage Arcanum XIX represents the reunion of true soul-mates into a single soul-mate system. So far as common requirements are concerned the marriage of harmonious souls is sufficient to afford those harmonies which aid spiritual progress. And, because this inner union is of spiritual bodies, only the few are highly enough developed to recognize it when it does take place. The majority mistake magnetic affinity for this inner blend, and consequently all too many discard one partner for another in the belief that the soul-mate has been found.

This is a deplorable situation, but does not mitigate against such relations when they exist in truth. In fact, this abuse is just another inversion of something holy to gratify sensuality.

The real union of soul-mates, to which Arcanum XIX corresponds, is purely spiritual, and does not of necessity require carnal contact. The blend may even take place in the spaces while the individuals are asleep, all, or nearly all recollection of it often vanishing when they awaken. Yet once this bond is formed, its power is never lost, and ultimately the two become conscious of the bond, either in this world or the next, and they begin to function then as a single system.

Occult Science

—Organic alchemy is the science which embraces all life-forms in the universe, and the changes in their characters which are produced by their experiences, and the processes by which they develop along special lines, each to become a valuable function in the body of the universal organism. Such processes are indicated as taking place by Arcanum XIX.

The Sarcophagus—Arcanum XX

—Letter: Egyptian, Rasith; Hebrew, Resh; English, R. Number, 20. Astrologically, the Moon. Color, green. Tone, F. Occult science, the next life. Human function, the Divine Soul. Natural remedy, hydro-therapy. Mineral, the metal silver.

R—20 expresses in the spiritual world, the immortality of the soul.

In the intellectual world, the judgment of conscience.

In the physical world, unexpected elevation.

Remember, then, son of earth, that all fortune is changeable, even that which appears most stable. The ascension of the soul is the fruit that it should draw from its successive trials. Hope in suffering, but mistrust thyself in prosperity. If

Arcanum XX should appear in the prophetic signs of thy horoscope, fall not asleep, either in idleness or forgetfulness; for thou hast a mission to accomplish which providence will reveal when thou art prepared to receive it.

In Divination, **Arcanum XX** may be read as an **Awakening** or **Resurrection**.

Arcanum XX is figured by a sarcophagus on whose side is pictured a scarab. Above this tomb a genie sounds a trumpet, whereupon it opens and a man, woman and child rise from it, still dressed in their winding sheets.

The sarcophagus is the tomb through which man ascends to a higher life. The scarab is symbol of the immortality of the soul. The genie blowing the trumpet is the call to ascend to higher spheres. A man, woman and child arise together to indicate that immortality depends upon the trinity of positive and negative soul-monads united about their Deific ego. The innocence of the ego is represented by the child.

The real tomb is the physical body which confines and envelops the soul while it develops its powers through the functions of social life; its relations to other life-forms. After one life in human form it has acquired self-consciousness and has no need to return to earth. As indicated by the trinity rising from the grave, there are opportunities for family life and other experiences on the next plane, the total ensemble symbolizing this entering into a new and active life in a realm above matter.

Number

—Numerically, 20 is the third decade of 2, and thus represents Arcanum II operating on the plane of Arcanum III, occult science manifesting in marriage. In the King's chamber of the Great Pyramid in Egypt is found a lidless sarcophagus, symbolizing the soul's flight out of matter, and out of the physical body; but significant enough, no sarcophagus is found in the Queen's chamber, for those who devised this great monument of occult science recognized that man and woman were but the two immortal portions of one Deific spiritual ego.

Astrology

—The Moon governs all periods of gestation, and is the magnetic mother of all life. Life on earth, in a physical body, is but the period of gestation which precedes a more vivid and active life in higher-dimensional realms. The Moon thus corresponds to Arcanum XX.

Human Function

—The ego is a spiritual spark of Deity, and as such is eternal; but the soul alone is immortal. What the Moon is to the Sun, that the soul is to the ego. It is the divine soul which, having evolved through countless life-forms, attains self-conscious immortality. Its effort in this direction is shown in Arcanum XX.

Alchemy

—In alchemy, Arcanum XX represents the Consciousness of the changes in himself, or the changes in other things, as the case may require, that take place as the transmutations proceed. It is the recognition of the new vibratory rates.

Bible

—The trinity rising from the sarcophagus of Arcanum XX is referred to in John 21:14; “This is now the third time that Jesus showed himself to his disciples, after He was risen from the dead.” Then Luke 24:51; “And it came to pass while he blessed them, he was parted from them, and carried up into heaven.” Such ascensions are mentioned still further in Rev. 20:6; “Blessed and holy is he that hath part in the first resurrection: on such the second death hath no power.”

This signifies that those who attain adeptship, and in the process build a spiritual form, not only voluntarily translate to the inner plane when life’s work is over, but that, instead of requiring still more arduous experience in the astral realms, they move at once to sojourn on the spiritual plane, thus escaping the so-called second death. Voluntary ascension is plainly indicated for both Elijah and Jesus, and may be inferred for Moses; Deut. 34-6; “But no man knoweth of his sepulchre unto this day. And Moses was an hundred and twenty years old when he died; his eye was not dim, nor his natural forces abated.”

The birth into the next life may be accidental, natural, or surgical, depending on the circumstances. The natural method is that indicated in the lives of Jesus, Elijah, Moses and certain of the Indian tribesmen of the North. That is, they go voluntarily, and need no assistance from others on either plane.

The accidental method of birth into the next life occurs frequently on the field of battle, in sudden accidents, where there are explosions, and other places in which the death of the physical comes without warning and with considerable shock. In such cases not infrequently the individual does not realize for some time that he is dead. These cases, however, which represent a temporary inability to make the proper adjustment to the inner plane, are not the same as those in which, through the strong and unbreakable attachment to some earthly thing the individual is earthbound: Rev. 20:5; “But the rest of the dead lived again until a thousand years were finished.”

Masonry

—In Masonry, Arcanum XX is the basis of the Perfect Master degree. It is symbolized by the sprig of cassia, sign of immortality, that was found on the grave of Hiram Abiff. Still more is it exemplified by the coffin with a five-point star on the lid, and leaning over it the immortal sprig of cassia.

In the ritual of raising Hiram Abiff from the grave, there are three attempts made, as signified by the three persons rising from the tomb of Arcanum XX. The first two efforts are unsuccessful; and the resurrection is finally accomplished only when the soul-union method of the Lion's paw grip of Arcanum XIX is employed.

Magic

—In many magical practices the assistance of those who have once lived on earth is invoked. More commonly than not those who control mediums are, or pretend to be, those who have once lived on earth.

It is true that a medium can tune in on a thought-form, or record left in the astral substance about our planet, so thoroughly as to be dominated by it. This is especially true of thought-forms to which, through mental magic, elemental life-forms have been attached. More commonly, however, mediums are actually controlled by those who once lived on earth, or they tune in on the thoughts and desires emanating from the unconscious minds of those in their circle.

The electromagnetic body of a person never moves far from the corpse after physical death, and it has no intelligence, or special power that can be utilized. The astral body of an individual can only be used through control of it, and an astral body is not a shell. The only spooks and shells of human origin are the powerful thought-forms left by people under great emotional excitement, the astral bodies of souls which are earth-bound, and the electromagnetic bodies of those whose corpses have not yet disintegrated. One might delude oneself into thinking any one of these was a departed loved one; but the discriminating would not make this mistake; and such spooks and phantoms can not be made successfully to impersonate loved ones who have passed to the next plane. The teaching that such is the case is merely the inversive use of a fact in the effort to disparage the belief in the immortality of the soul and to create a disbelief in the possibility of spirit communication.

Initiation

—In the soul's pilgrimage Arcanum XX represents the awakening of the soul to its angelic state as the result of entering into the soul-mate system.

Occult Science

—The Next Life, is the science of those conditions which surround the life-form after it passes from the physical plane, and embraces a consideration of inner-plane properties, and the means by which the soul continues its advancement in the realms beyond the tomb.

The Magic Cross Spread

—In this spread the cards are shuffled and cut as usual. Then five cards are dealt in a straight line from left to right; and eight more cards are dealt in a vertical line crossing the horizontal row at right angles, as illustrated on page 214. Thus while there are really only 13 cards in the spread, there are 5 in the horizontal line and 9 in the vertical line, making 14, the double 7 of regeneration. This explains the mystery of the cross; for 13 is the cross of death and 14 is the rosy cross of life.

The cards marked on the diagram 1 and 2 are to be read as the past. Cards marked 6 and 7 are the hopes and expectations. 4 and 5 represent the opposition and the adversaries. Then 3 is the present, where all factors meet to give birth to the future. And cards 8, 9, 10, 11, 12 and 13 represent the future so conceived.

Chapter 13

Serial No. 33
Original Copyright 1936
Elbert Benjamine

Copyright
Church of Light
August 2002

How to Read the Tarot

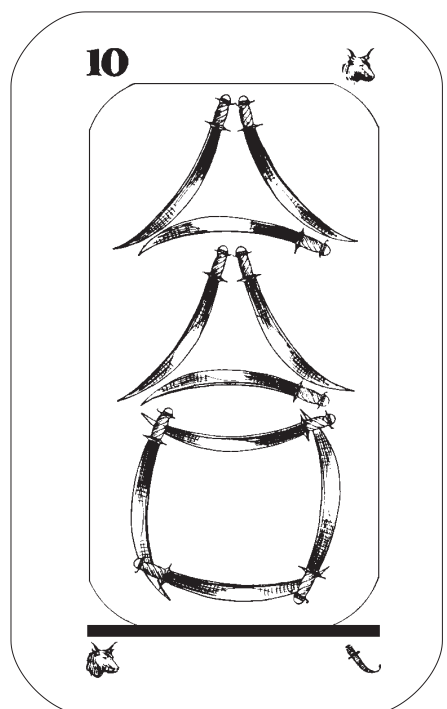
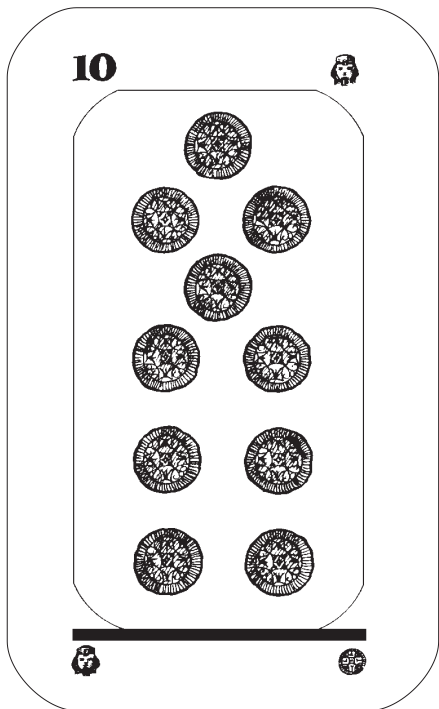
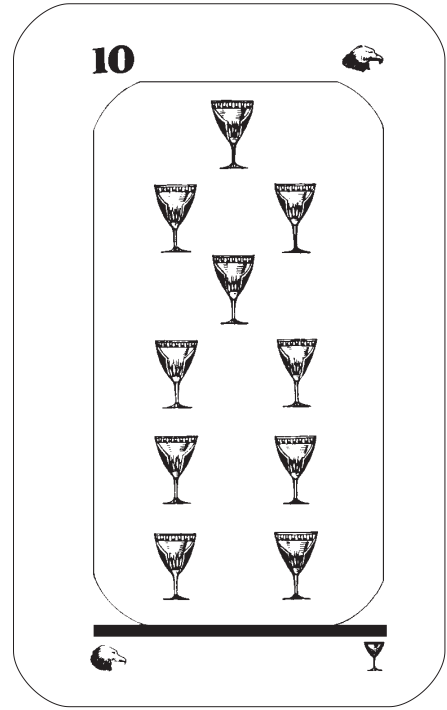
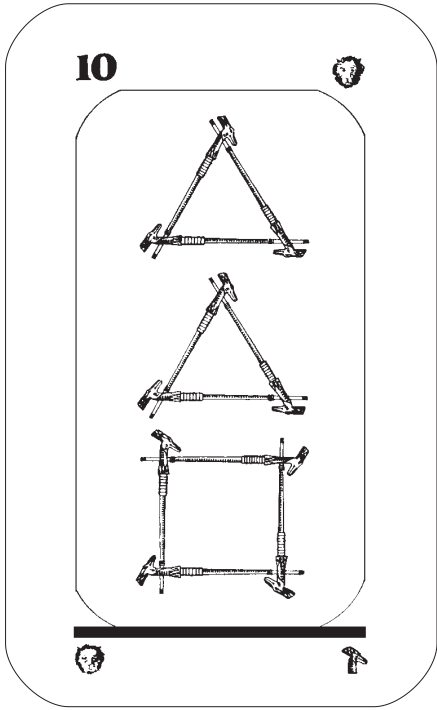

Chapter 13

How to read the Tarot



PROFICIENCY in any art, physical or psychical, depends largely upon system and method; and this is true of acquiring proficiency in tarot reading.

The first thing to adopt in formulating such a system is a rule in which, except when another shuffles them for the purpose of receiving a reading, no other person is permitted to handle the cards. The more the tarot reader handles the cards the better, for they thus the more completely become impregnated with his magnetism and are able to respond to the subtle thought-vibrations of his unconscious mind. But the magnetism and thought-emanations of others tend to impair this responsiveness through mixing the influences.

For this reason new cards are not so good as those which have been used repeatedly in card reading. And in order that they may the more fully retain the reader's influence they should not be left lying around in contact with the household furniture and thus become contaminated with the magnetism of others; but for best results they should be kept in a special box. This box should not be too large, and a wooden box lined with silk, which is a non-conductor, is preferable; a small box of soft white pine being excellent for the purpose.

If the reader expects to devote much time to tarot practice, and to the spiritual aspect, it is better to have two different tarot packs. The magnetism, or mental emanations, with which the cards become saturated in giving personal readings belongs to one basic vibratory level, while philosophical and spiritual research belong to another. If the cards used for the higher lines of thought are also used in personal readings they may become so influenced by the lower trend for which they are used that they do not properly respond to the desire to obtain information about spiritual things. So it is well to have a separate pack for each type of use, and not to use either pack for gaining information except on its own vibratory plane.

As a table on which to lay out the cards, any surface will do. A sewing table is excellent and easily handled; but where the amount of time devoted to the subject warrants, a light, unvarnished and unpainted table of soft white pine is still better. A new table imparts no extraneous thought-vibrations to the cards, and if unvarnished more quickly absorbs the thought emanations of the reader and gives the best conditions for the psychic intelligence to manifest itself.

A room which is the scene of constant discord and strife is not suitable for any kind of psychic work, as the vibrations left disturb the tranquillity of the unconscious mind and tend to impair the action of the psychic intelligence in its manifestation through the cards. Of course, good results can be obtained when the conditions are not ideal. I have here merely outlined the best conditions. But if these are not to be had, diligent practice will yield good results with the cards even under very unfavorable circumstances.

I have in an early chapter of the course indicated that a definite system in shuffling and cutting should be followed, and only departed from when there is a very urgent impression to do so. Thus the unconscious mind of the reader, and such other psychic intelligences as may be present, will have a clear idea of how the cards are going to be handled. Knowing how the cards will be handled facilitates giving them the proper arrangement by which accurate information may be conveyed through them.

The person to whom the reading is given should be seated on the opposite side of the table facing the reader; and if the arrangement permits, it is better that the reader sit on the south side of the table and the person to whom the reading is given sit on the north side. The natural magnetic flow is from north to south, and this seating aids the establishment of a relation of positive to negative between the client and the reader.

Before the cards are touched the reader should ascertain just what it is that the client wishes to know, so that he will have a clear idea of what the cards are expected to reveal. Then he should ask the client to clear his mind of all desires and thoughts other than the desire to receive a true and correct reading, or answer to the question. A trivial attitude will cause the reading to take a frivolous turn. And if there is a strong desire in the mind of the client or reader to receive a certain answer, it will tend to cause the cards to give that answer. But if the desire is only for the truth, and there is earnestness, the cards will mirror this attitude and respond with a clear and accurate reading.

Holding their minds to this unbiased attitude to know the truth, the client is then instructed to pick up the cards and shuffle them in such a manner that the ends of some will also be reversed. He is then told to cut them at random into three separate piles, and to collect them again into one pack in a manner giving them a different position than they had before cutting. This process is gone through a second time, and then a third time, all the while the minds of both being occupied with the desire to receive a truthful answer. When they have been thus shuffled, cut, and recollected the third time by the client, the reader takes the cards and deals them from the top, face downward, in the form of the spread he chose to use before the shuffling started.

Then the reader starts by taking the first card by the top and turning it over from top to bottom so that it lies face upward on the table. He looks at this card and notes any impressions he receives in connection with its usual divinatory significance and states them to the client. But in reading the interpretation he is merely to be guided by the common meaning, and is not to be restricted to it.

For the sake of facility the brief divinatory meaning of each card as given in these lessons should be memorized. Yet the real artist will recognize that every card is the symbol of some astrological influence, and his intuition often will select some phase of this astrological rulership to indicate the events which are to transpire.

The Broader Significance of Each Card

—On each Major Arcanum is given its corresponding number, at the upper right-hand corner is the symbol of its astrological planet or sign, below is the English letter, at the lower left-hand corner its Hebrew and Chaldean letter, at the lower right-hand its Egyptian letter, and if it corresponds to a zodiacal sign, the stars of the constellation picturing the sign are traced on the card as they appear in the sky. Outstanding things relating to each Major Arcanum are given in the text accompanying its description; and further things ruled by the corresponding sign may be learned from Chapter 5 of Course 5, *Esoteric Psychology* and Chapter 3 of Course 4, *Ancient Masonry*; and further things ruled by the corresponding planet may be learned from Chapter 7 of Course 8, *Horary Astrology* and Chapter 5 of Course 10-1, *Delineating The Horoscope*.

The scope of interpretation of each arcanum is thus vastly increased through the application of the law of correspondences. For instance, should Arcanum XVI be turned up it might read as an accident, which is the common meaning. But this arcanum is really an expression of the energy of Mars, so that if there were cards preceding it which indicated sickness, it should then be read as a surgical operation; for surgical operations only occur in people's lives when there is a Major Progressed Aspect involving Mars in their birth-charts.

The Kings, Queens and Youths See Pages 4, 5 & 23

—On each of the court cards which represents a type of individual, in addition to the corresponding playing card symbols to be found above and below on the left-hand side of the card, and the emblem of the suit to be found at the lower right-hand corner, the symbol of the zodiacal sign it represents is given at the upper right-hand corner, and on the card the stars of the constellation picturing that sign are traced as they appear in the sky. If the picture on the card is that of a man, it represents a man when right way up, and represents a woman when reversed. If the picture is that of a woman, it represents a woman when right way up, and represents a man when reversed. Then the suit alone indicates one of the four general temperaments, and the complexion of the individual thus designated, if such is all that is required.

The brief description and the Key-phrase given in association with each card representing a person, adds further information about the designated individual. But the student, as he advances will desire more details about such persons as are indicated in the

spread; and on occasions will wish to know their spiritual leanings as well as their more common characteristics. The description of people born under each zodiacal sign, as set forth in Chapter 2 of Course 2, *Astrological Signatures* and Chapter 3 of Course 10-1, *Delineating the Horoscope*, will give full details of their characteristics; Chapter 4 of Course 8, *Horary Astrology*, will give their personal appearance; and the allegorical story and its spiritual teaching given in Course 7, *Spiritual Astrology*, as relating to the sign, will reveal their spiritual possibilities.

The Horsemen

See Page 41

—The Horsemen are mounted to signify the carrying power and astrological significance of thought. The suit, as shown by the symbol at the lower right-hand corner indicates what the thoughts are about. They represent the thoughts of other people in relation to the client; usually being the thoughts of the person nearest whom found in the spread. If a Horseman is found right end up, it indicates that the thoughts and plans so signified are favorable to the client; but if the Horseman is reversed, the thoughts and plans are detrimental to the interests of the client.

The Minor Arcana

—In astrology the Sun or a planet is considered not only in its relation to the point where the observer stands, but also in relation to its position in the zodiac. In relation to the diurnal rotation of the earth, when the Sun is on the M.C. at noon, it corresponds to Jod of the divine word, and to the suit of scepters; yet in relation to the Sun's apparent annual journey through the zodiac, scepters correspond to the fiery signs.

When the Sun sinks below the western horizon its position corresponds to the first He of the divine word, and to the feminine suit of cups; yet in relation to the zodiac, cups correspond to the watery signs.

When the Sun is on the nadir at midnight, where one day joins another and the power of darkness is greatest, this position corresponds to Vau of the divine word, where Jod and He unite, and to the suit of swords. Yet in relation to the zodiacal circle, swords correspond to the earthy signs.

Finally, when the Sun rises on the eastern horizon, bringing new life to an awaiting world, its position corresponds to the suit of coins; yet in relation to the whole zodiac, coins correspond to the airy signs.

The common divinatory interpretation of the Minor Arcana considers the suit according to the positions relating to the diurnal rotation of the earth; that is, in reference to the M.C. (business), the Desc. (affections), the Nadir (affliction) and the Asc. (life and money). But the inner interpretation is derived from the correspondence of each card to a ten degree section of the zodiac.

Each Minor Arcanum has its number placed at the upper left-hand corner, and the symbol of its suit at the lower right-hand corner, the emblem being repeated the

proper number of times in the symbolic design. The nine arcana of each suit correspond to the nine decanates of each zodiacal triplicity, the tenth arcana, both embracing the whole triplicity as a completed circle and marking a transition to a new cycle, being summarized by the triplicity's Key-word.

The Movable signs of the zodiac are the starters, the PIONEERS, hence the true point of departure in any triplicity is not where it first appears in the zodiac, which with the earthy triplicity, for instance, would be Taurus, but with its first appearance in a movable sign. Thus the fiery triplicity commences with Aries, the watery triplicity with Cancer, the Airy triplicity with Libra and the earthy triplicity with Capricorn.

If you will turn to the illustrated key on page 22 of Chapter 2, it will be plain that the first three decanates of the earthy triplicity, corresponding to the suit of swords, are there shown numbered 1, 2, 3, in Capricorn at the top of the key; that the next three decanates occur in Taurus and are numbered 4, 5, 6; while the last three decanates of the earthy triplicity appear in Virgo, numbered 7, 8, 9. A little study of this key will indicate the astrological position and correspondence also of the decanates of the other triplicities corresponding to the other suits.

Each of the Minor Arcana below 10 thus corresponds strictly to one of the 10 degree section of the zodiac. And as each of the 36 decanates is pictured in the sky by a constellation, the stars of the constellation corresponding to each Minor Arcanum are traced upon it. In the text, in addition to the common divinatory meaning of each Minor Arcanum is given its inner interpretation, which is revealed by the Key-word of the decanate to which it thus belongs.

As the student advances, however, he will wish still more detailed information as to the significance of these Minor Arcana. The symbols indicating the decanate to which each belongs are given at the upper right-hand corner of the card, and the planet ruling the decanate is placed, for ready reference, at the lower left-hand corner. Full details of the physical significance of each decanate, and thus of its Minor Arcanum, may be learned by consulting Chapters 1 and 2 of Course 10-1, *Delineating the Horoscope*, while the allegorical story relating to each, which reveals its spiritual significance, can be had by looking up the decanate in Course 8, *Horary Astrology*.

Interpreting The Cards

—Beginners should restrict their interpretation closely to the common divinatory meaning; but it will be seen that as all events, thoughts and circumstances have astrological correspondences, every possible combination of events and conditions may be indicated in a tarot spread if the wide astrological interpretation is used.

If all the cards are turned over before the reading starts the mind spontaneously wanders all over the spread and it detracts from the ability to draw correct conclusions from the card under consideration. Therefore, the cards should be turned over, one at a time, as read. After reading the first card, which usually indicates some

event or condition in the past, the next card should be turned over and read as a subsequent condition or event modifying the first, and the third card as a circumstance modifying all that has preceded. Thus proceed from past through the present into the future, each card like a single petal of the opening bud of events, which alters in shape as it expands, yet all required to represent the full blown flower of the future.

Some of the cards will be found right end up, and some reversed. But this reversal of ends does not reverse the meaning, as is sometimes thought. Instead it makes the card somewhat less fortunate than it is when right end up, just as a planet is less fortunate when it receives a bad aspect, or as a sign is less fortunate when its ruler receives an inharmonious aspect. For instance, Saturn can hardly be considered a benefic planet when well aspected, and Arcanum XV is never a good card, even when right end up; but when reversed it is more like Saturn afflicted by a discordant aspect. On the other hand Jupiter, even when much afflicted, is never very malefic; therefore Arcanum V, even when reversed can signify very little evil, although it is then not so good as if right end up. The same principle applies also to the minor arcana. Thus except for the court cards, the significance of which when reversed has already been explained, any card right end up is more fortunate than it is when reversed.

To determine the influence upon the life of the client of any Court Arcanum, consider the card just preceding it in the spread. To determine what action will be taken, or move made, by a person represented by a Court Arcanum, consider the card that next follows it in the spread.

One may read the cards for himself; and one may read the cards successfully for an absent person, both shuffling and reading the cards. And as in any art, proficiency is acquired only by much practice and observation of results.

When using the tarot cards for spiritual and philosophical problems, in which the life of no person is involved, the Major Arcana become of great importance, and at times may be used apart from the other cards. In such considerations the 12 Court Arcana represent the 12 zodiacal signs, and the things to which they correspond, such as the 12 types of intelligence. The Horsemen then represent the 4 elemental kingdoms, and also the four principles related to the word Jod-He-Vau-He. The Minor Arcana become useful to designate the various numerical relations.

In using the tarot for philosophical and spiritual problems, the Court Arcana, other than the Horsemen, may also be taken to signify the influence of their corresponding zodiacal signs to modify conditions.

And in the use of the cards for such purposes, it should be carefully borne in mind that the reading of the Major Arcana should always occupy the same plane as the problem to be solved. Thus if the problem concerns the physical plane, such as the destiny of a nation, its success in war or commerce, the geological epochs of the earth, the growth of plants and animals—physical relations—the reading given for the physical world should be used. But if the problem is concerned with the soul world, with mental action, with the intellectual development of life, or with the interaction of magical

forces, the reading should follow the interpretation of the Major Arcana given for the Intellectual world. Furthermore, if the thing about which information is sought has to do with universal principles, with spiritual conditions, with eternal verities, or with the working of God's Great Plan, the interpretation given in connection with each Arcanum in the spiritual world should be employed. The idea is always to have the premises and conclusions on the same plane.

The Major Arcana of the tarot are only surpassed as subjects for meditation by the spiritual texts of astrology. One such card can be used thus on one day, and another card on the following day, its symbolism and meaning in the three different worlds receiving undivided attention. After thus thoroughly covering the entire 22, they may be variously joined in twos, the interaction of the two principles being meditated upon, in different arrangements. If, for instance it is desired to know the value of good and evil, conjoin Arcanum V and Arcanum XV; or if the effect of controlling desire would be known, meditate upon the union of Arcanum I with Arcanum VI.

Because everything which exists has an astrological correspondence which is also associated with a tarot card, by selecting the proper factors, any physical or occult problem may be solved by the use of the tarot. Thus, taking something crude, if you wished to know the possibilities of gasoline, ruled by Neptune, for power, you would select Arcanum XI. If you wished to know more about the alternating current of electrical science, you would combine X, ruling electricity and sudden changes with VI ruling the copper transmitter. Arcanum XVI thus would give you something definite to think about.

In an astrological chart, to get a clearer view, you can substitute the admonition which starts, "Remember, then, son of earth," for the dominant planet, or for the significator of the thing asked about. And if the correspondences of the factors in the problem are unknown, you can take the pack of cards and lay out a suitable spread as in other divination by cards, to get the answer. What the tarot can be made to reveal is limited only by the capacity of understanding of the person using it.

The Adept—Arcanum XXI

—Letter: Egyptian, Sichen; Hebrew, Schin; English, S. Number, 21. Astrologically, the Sun. Color, orange. Tone, D. Occult science, personal alchemy. Human function, the ego. Natural remedy, light and color. Mineral, the metal gold.

S—21, expresses in the spiritual world, angelhood.

In the intellectual world, the triumph of adeptship.

In the physical world, the highest possible attainment.

Remember, then, son of earth, that the empire of the world belongs to the empire of light and that the empire of light is the throne which God reserves for the sanctified will. If Arcanum XXI should appear in the prophetic signs of thy horoscope, thou wilt gather the fruit of the knowledge of good and evil, and drink of the eternal

fountain, if thou art sufficiently master of thyself to approach it without coveting; obstacles will disappear from thy path, and thy destiny will have no limit save those of thy will.

In Divination, **Arcanum XXI** may be read as **Success** or **Attainment**.

Arcanum XXI is figured by a kneeling young girl playing on a harp of three strings. Above is a wreath of twelve flowers, each flower having three blossoms. At each of the four angles of the wreath is a head; the two below being the head of an eagle and the head of a bull, the two above being the head of a lion and the head of a man. The man's head has the sacred serpent at its brow to indicate mental fertility. In the center of the wreath is a phallus and a yoni conjoined. This sacred lingha is soaring upward through the wreath, sustained by two wings.

The young girl symbolizes purity of life. She is modestly clothed to indicate simplicity of living and moderation in desires. She kneels as she plays the harp to indicate absolute devotion to the higher laws, and prayerful aspirations to live a spiritual life.

The harp has three strings, signifying harmony of body, intellect and emotions.

The twelve flowers of the wreath above are the twelve zodiacal signs in which all experience is gained. The three blossoms of each flower indicate that both souls, as represented joined in the winged linga, have garnered the flowers of zodiacal experience on all planes, physical, astral and spiritual.

The head of the Lion signifies the creative forces of the solar sign, Leo, and the courage which is necessary to all real attainment. The head of the Bull represents the fructifying agent of nature and points out the necessity of labor in all progress. The Eagle signifies that sex, as signified by the sign Scorpio, has been turned into channels which lead to spirituality. And the head of the Man indicates that both intuition and intelligence are necessary guides in unfolding the highest spiritual possibilities.

These four emblems ranged around the zodiac typify the processes of evolution. They are the four forms of the Egyptian sphinx, and also symbolize the passage of the Sun through the four zodiacal quadrants. As applied to adeptship they point out that the neophyte must have energy and courage to sustain his efforts, must have knowledge to direct his energies properly, must labor ceaselessly for the realization of his aspirations, and must gradually tune his emotions to a higher, more spiritual vibratory level. Those four attributes, Wisdom, Perseverance, Courage, and Love are usually rendered in occult circles as: "To Know, To Do, To Dare, To be Silent."

The winged linga in the center of the wreath of zodiacal flowers symbolizes the permanent union of soul-mates and their ascension into angelic worlds by virtue of the properties of the soul-mates system so formed. The girl kneeling by the harp denotes that this union was brought about by living the life of the spirit while on earth. Spiritual aspirations and devotion to furthering God's Great Plan, loving and unselfish endeavor to contribute the utmost to cosmic welfare, together with a clear

conception of the laws of harmony, in time bring about the recognition across the spaces and the development of exchanging lines of force, which lead to this ineffable union. This harmonious reverberation of soul to soul is symbolized by the harp of three strings, for the union embraces all three planes.

Strength depends upon harmony, and the music of their souls sounding across the spaces endows both with a hitherto unknown power to overcome obstacles, to gain the blossoms of experience on all three planes, as signified by the three flowers related to each of the 12 zodiacal signs. As a whole the ensemble signifies the attainment of adeptship while on earth, and the crown of angelhood that awaits such perfect human beings when they have passed from the physical and function in the sublime vistas of the future.

Number

—Numerically, 21 is the third decade of 3, representing Arcanum III operating on the plane of Arcanum III, hence marriage in its most perfect expression. It signifies the complete nuptial union of 7 carried through three planes to be developed into angelic expression. And it also signifies in its other aspects, the 3 x 7, or highest possible development of human functions and possibilities.

Astrology

—As in truth the Sun is the source of all physical, mental and emotional power expressed on earth, the planets merely refracting its various attributes, and the signs acting as sounding-boards for such expression, so Arcanum XXI, signifying perfection, union and attainment on all three planes, corresponds to the Sun.

Human Function

—Arcanum XXI pictures the ultimate reunion of soul-mates. And as such reunion enters into the formation of a new system in which the ego is the central nucleus, about which the magnetic and spiritual forces of both souls play, endowing the whole with properties which transcend even those of five-dimensional life, Arcanum XXI well corresponds to the ego.

Alchemy

—In Alchemy, Arcanum XXI represents the final product, or successful transmutation, and more specifically it denotes the completion of The Great Work.

Bible

—The Bible refers to the principle involved in Arcanum XXI as the Promised Land, on which Moses was permitted to look, but into which he was not able to enter. In this

respect the Kabala states that Moses was able to pass 49 gates, but could not pass the 50th, or gate of jubilee.

Masonry

—In Masonry, the Degree of Perfection is based upon Arcanum XXI. This Arcanum is symbolized in ancient masonry by a two-headed eagle. An eagle is the spiritual aspect of sex, and the two heads signify two intelligences, or souls, united and occupying one soul-mate system.

Magic

—In Magic, Arcanum XXI represents the exercise of the functions of adeptship. Although not easily distinguishable, there are seven grades of humanity who live and move upon the earth, the seventh, and highest, state being that of the perfect man. The attainment of adeptship on the physical plane is the grand climax of physical evolution, the topmost point in the ladder of worldly ambitions.

The adept, commencing as an earnest neophyte, has undergone a system of study by which he has mastered the 21 different branches of occult science. He has entered upon a process of regular psychic training by which his inner faculties are made active and accurate, and thus he masters the 21 lucidic arts. Intuition is used to check reason, and the psychic senses are developed to a keenness that they can be depended on for far-reaching information not accessible in the outer world.

Furthermore, there are 7 states of consciousness which are developed, which constitute soul attainment. Those 49, then, are the 49 gates of attainment which Moses passed. And the 50th is that which relates to the union of true soul-mates.

The real adept, however, is not, as so many seem to imagine, a being who has attained wonderful power, but who resides in seclusion and lets mankind work out its own problems. Instead, if he is really an adept, and not merely a magician, he moves among men, and uses all his powers, in the manner that will be most helpful, to alleviate suffering and to aid the forward movement of universal progression.

Whatever the powers he has developed, you may be sure the adept is actively engaged in using them for human welfare. He realizes that the destiny of the cosmos depends upon each section of it advancing as rapidly as possible, and performing its own work. And he has striven to become an adept, not to have magical powers by which to amaze the multitude, but because such a high state of development gives him added usefulness in the general scheme of things. Constantly, and persistently, he works for human upliftment, and for everything that will aid in the proper development of God's Great Plan.

Initiation

—In the soul's pilgrimage, Arcanum XXI represents the consciousness of the whereabouts of the soul-mate, and finally, due to spiritual work accomplished and spiritual faculties developed, the union in a soul-mate system. As such permanent union is a relation of spiritual forms, it is apparent there can be no permanent union until both have spiritual forms developed. Spiritual bodies are not something with which people are born, they are builded through living a spiritual life. Consequently, the effort to locate the soul-mate, until such finer forms have developed, is premature, and leads many people to grievous error.

Furthermore, as when the spirituality is sufficiently advanced, through living a truly spiritual life, it leads spontaneously to a recognition of the soul-mate, the most fitting effort toward such a state is not to set out on a soul-mate quest, but to set out with the determination to develop adeptship. When adeptship, or even its approximation, is attained, the knowledge of the soul-mate comes by virtue of the states of consciousness developed, and with no special endeavor required.

Occult Science

Personal alchemy, which embraces the various changes which the devotee of The Religion of the Stars must make in his manner of living as he ascends the spiritual ladder to become the perfect man, or adept, corresponds to Arcanum XXI.

The Materialist—Arcanum XXII or 0

—Letter: Egyptian, Thoth; Hebrew, Tau; English T. Number 22. Astrologically, the planet Pluto. Color, ultra-violet and infra-red. Tone, harmony. Or the color may be black and the tone inharmony. In science it is either materialism or spirituality. Natural remedy, stellar healing. Human function, soul-mate system. Mineral, the soil of earth, or the element plutonium.

T—22 expresses in the spiritual world, annihilation; 0 expresses eternal progression.

In the intellectual world, 22 is atheism; and 0, devotion to The Religion of the Stars.

In the physical world, 22 is materialism, and 0 is ceaseless cooperation in the furtherance of God's Great Plan.

Remember, then, son of earth, that all things physical pass away; and that before the soul can pass to higher realms every debt to nature must be paid to the utmost farthing. If Arcanum XXII should appear in the prophetic signs of thy horoscope, imprudence threatens to encompass thy ruin, and thou wilt be called upon to pay for thy folly unless thou immediately changeth thy ways.

In Divination, **Arcanum XXII** means **Failure, Folly, and Mistake; (or Spirituality)**.

Arcanum XXII, or 0, like the planet Pluto, has a dual interpretation. As XXII, it is well represented by the letter T with its point thus down; but as 0, the circle being the symbol of spirit, it is represented by the reversed T, that is, having the point, or energy, directed upward, the cross-bar resting below on the earth, and thus indicating that the thoughts, emotions and actions, are directed exclusively toward spiritual endeavor. It is figured by a blind man carrying bags on his left shoulder. He leans on a black staff and walks toward a fallen obelisk behind which a crocodile with open mouth awaits to devour him. Above is an eclipse of the Sun. The eclipse signifies that the spiritual light from within has been obscured by material interests; or it signifies that dark forces from the inner plane try to shut away the spiritual illumination which guides the neophyte.

The bags over the left shoulder of the blind man indicate the material things of life he has spent his efforts acquiring; or it represents his ability to minister in physical ways to those in need.

The staff of experience with good and evil is black, indicating that prudence is subservient to the demands of the senses; or that the demands for uplifting and protecting others is so great that, though enlightened, he ignores all danger.

The fallen obelisk symbolizes the final overthrow of all temporal work and power. The crocodile indicates the ultimate fate of all who are blind to spiritual things, and also the persecution of those who work to spread the true facts of spirituality.

This blind man is the atheist, or materialist, and the man who is so absorbed in material aims that he neglects all thought of spiritual things. It is likewise the man who is a slave to his desires. And the ensemble thus symbolizes the inevitable suffering which follows sin. Or, it symbolizes the truly spiritual man, who is so enthusiastic in his effort to assist the race that he is completely blind to the consequences to himself. And thus, equally well, it symbolizes the law of universal compensation, which decrees that for all effort expended in a constructive channel there inevitably follows increased ability and real advancement.

Number

—Numerically, 22 is the third decade of 4, and thus represents sex used to gratify the passions, or for magical and selfish purposes. 0, however, which is the alternate reading of the Arcanum, represents the cycle, and shows that there is a transition of character to a higher basic spiritual, or vibratory, level.

Astrology

—In astrology it is found that the planet Pluto has two marked and opposite qualities. It rules the gangster and racketeer when its destructive side manifests; and it rules the

highest type of spiritual effort, and the realization by the individual of his cosmic work, when the better side is manifest. These two extremes are symbolized by Arcanum XXII.

Human Function

—On its destructive side Arcanum XXII corresponds to, and symbolizes, the disintegration of the vehicle on the inner plane occupied by the soul; and on the constructive side Arcanum 0 represents the infiltration to the soul yet on earth of information and instructions from adepts occupying the super-velocity spiritual plane.

Alchemy

—In Alchemy, Arcanum XXII signifies failure in transmutation, and the regimes adopted in the hope of transmutation which lead only to repressions. Arcanum 0, on the other hand, represents the work in cosmic affairs which is undertaken after the Great Work has been accomplished.

Bible

—In the Bible we read that the Fool has said in his heart that there is no God. Also, Math. 16:26; “For what is a man profited, if he shall gain the whole world, and lose his own soul?” Math. 12:32; “But whosoever speaketh against the Holy Ghost, it shall not be forgiven him, neither in this world, neither in the world to come.” Speaking against the Holy Ghost is effort made to prevent the progress of God’s Great Plan of eternal evolution.

Masonry

—In Masonry, the Sublime Knight Elected is based upon Arcanum XXII, the Tau, or T, with the point down, instead of with the point up, and thus indicating that the creative energies are devoted exclusively to material ends.

Magic

—In Magic, Arcanum XXII indicates that the individual has given himself over to the control of invisible intelligences who have no regard for his welfare, and who use him consistently to thwart any and everything which is true and progressive on the face of the earth. It symbolizes elemental affinities that are formed in the selfish endeavor to gain, through magic, material advantages over others.

Arcanum 0, the alternate interpretation, however, indicates that there is freedom from all control; but that the individual has contacted intelligences of a very exalted

spiritual plane who direct him consistently in his efforts to give to those on earth new and higher teachings.

Initiation

—In the soul's pilgrimage Arcanum XXII represents the failure of the soul to gain self-conscious immortality. It also represents the obstacles which, whenever the neophyte sets his feet resolutely on the path of adeptship he is sure to attract. The resolution to live in a different manner, by the law of affinity, causes the thinking about it to attract obstacles to the performance of the thing resolved upon.

Arcanum 0, on the other hand, indicates that the soul through its earthly experiences has developed in the building of its spiritual form far enough that it will not need to tarry in the astral world after the dissolution of the physical, but will go at once to undertake a higher mission for The Father, on the still more interior planes. And it represents that law of affinity which, when the aspirations are vivid, attracts spiritual entities and forces which enable it, through their help, to overcome the obstacles to its spiritual progress.

Occult Science

—Arcanum XXII represents the soul-annihilating dogmas of materialism. But Arcanum 0, on the other hand, represents the soul uplifting teachings of THE RELIGION OF THE STARS.

The Life Spread

—The Life-Spread requires a large table, or space, on which to lay the cards. After shuffling and cutting the cards in the usual manner, the cards are dealt, one at a time, face downward in the form of a hollow square of 28 cards. 4 is realization and 7 is perfection of form, and these 4 x 7 cards of the square, or 28 (2 plus 8 equals ten) involving to 10, symbolize the cycle of life in the physical form. Yet, as laid, there are 8 on each side, the number of crystallization. This square relates to the physical endeavors.

Within this hollow square of the physical, deal a triangle of 12 cards, so that there are 5 cards on each side of the triangle, always dealing from the right hand corner around to the left. 5 is the number of inspiration and 3 is the number of action. These 12 cards indicate the sacrifices (12) which have been made of the physical comforts for the sake of developing the mentality. This triangle, the triangle symbolizing mind, relates to mental attainment.

Then in this hollow trine, commencing at the bottom, deal a circle of 9 cards. 9 is the number of divine wisdom, and as it is in the form of a circle, which symbolizes spirit, it relates to spiritual attainment.

There are now 49 cards, or 49 gates to life, and there remains only to add the 50th card in the center to give the jubilee, which is the point where square, trine and circle are one. The spread is illustrated on page 232.

In reading this life oracle, start with the lower right hand corner of the square and read entirely around the square to the left, turning and reading but one card at a time. The cards in this outer spread are all to be considered as events relating to the physical life and material success; and not as having much direct bearing on intellectual pursuits or spiritual attainment. Each, in the order in which it occurs is to be considered as a subsequent event or influence.

After the material events and influences have thus been read, start at the lower right hand corner of the trine, and read around to the left; but consider these cards, as turned and read, to have to do with the mental processes, the intellectual attainment, and such studies and opportunities as have to do with acquiring knowledge.

Next start with the bottom card of the circle and read it around to the left. The conditions there found, and the opportunities shown, relate to the spiritual development, and the moral trend. Of course, material happenings and mental opportunities have an influence upon the spiritual life; but only such as are found in the circle of 9 cards are to be considered as really important factors in the spiritual life.

The events relating to each plane of endeavor, as shown in this spread, are to be considered as those of most importance throughout the whole of the life. And as a final revelation, indicating the event which, on the physical, mental and spiritual plane, will have most influence in shaping the client's life, the central card, or Jubilee, should be turned over and read.

Book 7

Copyright
Church of Light
August 2002

Spiritual Astrology

Chapter 1

Serial No. 71
Original Copyright 1935
Elbert Benjamine

Copyright
Church of Light
August 2002

Our Spiritual Legacy

Chapter 1

Our Spiritual Legacy

A LEGACY of untold value has been left by spiritual and intellectual giants who labored in the dim and misty past. It is the purpose of these lessons to transmit this priceless heritage to the people of the present day, to whom now rightfully it belongs.

We of the present have specialized in material science, and as a result of that specialization have possessed ourselves of mechanical contrivances and an industrial achievement far superior to those of any People in the past. Yet in that past there were specialists also; the equal of any on earth today. But instead of devoting their energies to material things, their field was that of spiritual research. And they were as far in advance of our material scientists in their chosen field, as the material scientists of today are in advance of their ancient knowledge of the physical properties of things.

We are where we are today in matters of physical science because men of vast understanding like Sir Isaac Newton and Albert Einstein have labored in research and recorded their findings for other men to read. Were it not for the records left by those of unusual ability, ours would be a sorry world of muddled thought.

Such records give not merely the details of information, to which other men left to devices of their own might seldom attain, but by revealing the correct method of ascertaining the fact they eliminate wasted effort on the part of those who otherwise would follow many a blind trail before finding the one leading to it. Yet because these men, who themselves have stood upon the intellectual shoulders of other geniuses who preceded them, have left to us their findings, there is no implication of blind belief.

Not only are their findings included in the records, but the experiments which led to these findings also. And it was understood by them, and is so understood by us, that all and sundry are to have full liberty to repeat these experiments, or if they can, to devise better experiments of their own, to test the accuracy of this recorded knowledge.

Likewise, far in the past other men of exceptional talent, generation after generation, labored under conditions of exceptional advantage to acquire a knowledge, not of the

chemical and mechanical properties of matter, but of the nature and possibilities, here and hereafter, of the human soul.

To them, that which was of supreme interest was the character of man. Other knowledge was valuable only to the extent it could be made to contribute some thing which would enable the soul to reach a higher, fuller destiny.

These men also, standing on the shoulders of other inspired geniuses who preceded them, acquired vast knowledge in their chosen field, and of this knowledge they left a careful record.

In here setting forth this record, and something of the methods they employed in reaching these facts, there is no implication that anyone should accept their findings in the spirit of blind belief. No more so than that he should thus accept the findings of our chemists that each molecule of water contains one atom of oxygen and two atoms of hydrogen.

It would require more than one lifetime to perform every experiment recorded in the chemical treatise to be found in our libraries. Nevertheless, they have been performed by others, and anyone is at liberty to perform such of them as he chooses, again and again to his own satisfaction.

The laboratory of Nature is always open. Whether it be a problem in Euclid, the law of falling bodies, the influence of the planets on human life, or the survival of the personality in the spheres of the beyond, he who is willing to perform the requisite amount of labor need take no statement of fact on faith. Nor was it the desire of the ancient masters of spiritual science that he should do so.

The Language Employed In Recording the Legacy

—These records left by the wisest men of a very ancient time could not, of course, have been written in the English language. Even the writing used by the Maya, a race yet surviving, and conquered by the Spaniards only about 400 years ago, can but be deciphered now sufficiently to reveal dates and their astronomical learning. The meaning of the more conventionalized characters is quite unknown.

The most ancient form of writing is the pictograph, in which the thought to be conveyed is actually, although perhaps roughly, pictured. Until modern schools were introduced the American Indian often made use of such writing. To represent good hunting, for instance, he merely painted or carved on a rock the picture of deer and other game.

The scope of true pictographs, however, is too narrow to recommend their exclusive use among a people of advanced ideas. But this scope was vastly widened through using them, not solely to picture a condition as it actually exists, but to represent other things with which the pictured object most commonly is mentally associated.

To indicate in our desert region, that there was a water-hole in a certain direction, the American Indian traced on a rock a line in that direction. Where the line ends is the water-hole; for every Indian trail, in such a region, ends only at a water-hole.

In such writing he has gone beyond simple pictograph and employed universal symbolism. He has not felt the need of picturing the water or the water-hole. He knows that the end of a trail in every Indian's mind is associated with a water-hole. When he pictures where the trail ends, he thus conveys to any other Indian the information that there water can be found. Such picture writing can be found from Mexico to Canada throughout the arid region.

We say, "The pen is mightier than the sword," to convey the idea that the written thought is superior to warfare. This also is universal symbolism, even though it be not pictured by a broken sword lying beneath an arrogant pen.

Thus in addition to that which can be recorded as a picture there is also that which can be recorded orally. The myths and legends and folklore of the various peoples of the world often are very interesting as stories. But in addition to their entertainment value, which is given to them to insure that they shall be perpetuated, they also, quite as much as a picture drawn on a rock, convey ideas of more serious import.

Either pictures or stories may have a certain attractiveness of form; but pictures are not drawn, nor stories perpetuated, by primitive peoples except as they are employed to give expression through pictograph or universal symbolism to important thoughts which there is a desire to convey to other minds.

And because the attributes of objects are fairly constant, as are also their common associations, thought conveyed in such a manner remains clear and understandable across intervening centuries and regardless of race or clime. It is in such language as this, whose meaning does not pass away, nor changed by time nor place, that the sages of old recorded their ineffable wisdom.

Source of the Legacy

—Few details persist of the civilizations that once existed on the land area over which now rolls the waters of the Pacific. This land, called Mu by some of the peoples deriving from it, and termed Lemuria by those of the present day who find evidence that the lemurs had their origin there, probably was inhabited by several races in varying stages of culture.

That it actually existed there is abundant geological, biological and ethnological evidence to prove. Such proof, however, belongs more properly to Course 12, where the origins of life-forms and human cultures, and their spread from centers of dispersal, are considered in some detail. But as a lot of nonsense has found its way into print about this Pacific land area it may not be amiss to indicate that *The Problem of Lemuria*, by Lewis Spence, is a book based upon scientific findings, and is

consequently free from the wild speculations written as fact that too frequently are outstanding features of other books on the subject.

There is even more abundant evidence that Atlantis once occupied some portion of what is now the Atlantic Ocean. Atlantis, by Ignatius Donnelly, was written many years ago, but is still a good book. The History of Atlantis, by Lewis Spence, brings the findings down to date, and is authoritative. But as in the case of Lemuria (Mu), what we know about the inhabitants of this ancient land rests wholly on tradition.

That somewhere on the earth there was a people of intelligence and prowess superior to the Neanderthal Man who inhabited Europe during glacial times is not tradition, but positive knowledge. When the last ice sheet receded sufficiently to make the climate of Europe a little more attractive, the Cro-Magnon race invaded that area and exterminated its more primitive inhabitants. The indications are that they came out of the west. In cranial capacity and physique, as shown by their abundant remains, they were the equal of any race on earth today.

Also in America, as soon as the great ice sheet had receded, a people arrived from somewhere. They were not Indians, and apparently their culture extended to the Atlantic seaboard. Their flint points were first turned up in 1925 near Folsom, New Mexico, along with a type of bison now extinct. After the place where first discovered, they are called the Folsom people.

Equally certain it is that there existed some people in the distant past who knew vastly more about the unseen world, about spiritual laws, and about the influence of astrological energies upon human life than does the modern scientist. This is just as certain, and for the same reason, as that there were Cro-Magnon and Folsom people. Portions of this knowledge persist, and are being uncovered from time to time, in various areas of the world where long ago they took lodgment.

Just where the Stellar Wisdom first was practiced, and from whence it spread, there is as yet no conclusive evidence to enable us to decide. That in forms which are but modifications of an identical original it was present at the very beginning of the seven ancient centers of civilization—Egypt, India, Crete, Peru, Mexico, China and Chaldea—it is easy to demonstrate. And experience proves that wherever a particular biological form, or a culture having many complex yet identical interrelating factors, is present in different areas of the world, it had its origin in a single region of dispersal.

Atlantis and Mu certainly existed, and it is quite probable that each was inhabited by several races, some member of one of which perhaps rose to great heights in spiritual knowledge. But as a naturalist, and a student of the development and dispersal of new life-forms on earth, I find no evidence on which to base the popular conception that the inhabitants of these ancient lands were skilled in the construction or use of machinery. Nor do I believe they were the equal of present-day astronomers in making precise calculations.

In the Great Pyramid of Egypt, and in some of the embankment mounds of the Mississippi Valley of America which seem to employ the same formulas, astronomical proportions and cosmic knowledge are included which have a vast range. We do not know just how vast, because as scientists of the present day make new discoveries regarding the structure of our universe, it is revealed that such also are included in these monuments to the wisdom of the past.

On the whole, however, in so far as there is any evidence to indicate, in the work the ancients contemplated they had no need for, and did not use, the minute precision which marks the work of present-day laboratory scientists. Their knowledge of astronomical ratios and cosmic relations was derived from applying the Law of Correspondences with the aid of their highly developed psychic faculties, rather than through the use of refined mechanical contrivances such as are employed today.

They were interested in the various factors, seen and unseen, with which the universe abounds, as they relate to human life and destiny, here and hereafter. And it is to their everlasting credit that they worked out a mathematics, and formulated methods of procedure, which were adequate to meet these practical requirements.

Origin of the Constellations

—Without setting the date when the method as we know it, and as it has passed down to us through the Chaldeans and the Greeks was perfected, nor attempting to decide how much and when it may have been modified in its passing, we can trace the road traveled by these ancients who left to us our spiritual legacy.

We can do this with great confidence because we know that the purpose for which they studied astronomy was to be able to chart astrological influences as they affect human life, and to correlate spiritual truths with these observed influences. All the more positive can we be in thus following their steps because most of the methods they used are still similarly employed in some portion of the world today.

We know, for instance, it was desirable in that ancient time, as it is desirable today, that some point be fixed upon from which to reckon the days in the year, and from which to indicate the east-and-west position of the objects to be seen in the heavens. One cannot, very well, refer to the place of an object along a circle either a circle of days or a circle in the sky—unless there is some established point to reckon from.

The ancient astrologers of almost every land, as far back as we can trace them, seem to have recognized the earth to be round. Aristotle, who dominated scholasticism from the fourth century BC until after the time of Copernicus in the sixteenth century AD, held and taught this view. Eratosthenes, the librarian at Alexandria, who died 196 BC, measured the size of the earth's globe; and Hipparchus, born 160 BC, working from the accepted idea of the Chaldean astrologers that the earth is a globe, and from his observations that the Sun varies in the speed of its orbital progress, demonstrated that the earth does not lie at the center of the Sun's (we now know apparent) orbit.

It was Christian dogma, misinterpreting, certain biblical passages, which forced its followers in many localities—although Aristotle was still considered the better authority by many scholars—on pain of punishment to accept a flat earth with four corners.

Because a conspicuous star is so easily located, such may at first have been chosen, to mark the line extending southward from the apparently immovable Pole Star, from which the positions eastward of the other stars could be located. The conjunction of the Sun with this star also could have been used to start the year. But in time it was found that some stars have a motion relative to others, and that the position of the Sun on the longest and shortest days of the year was shifting westward among the stars.

It became apparent, therefore, that the best point from which to locate stars and planets in reference to east-and-west, and from which also to commence the year, is the place in the heavens occupied by the Sun when the days and nights are equal. And as the spring is looked forward to with such eagerness by people who have felt the oppressive weight of winter, the Vernal Equinox was the one chosen.

Because it is the best starting point, it is still so used by astronomers; both the timing and east-and west positions of the stellar bodies being stated by them as so far from the Vernal Equinox, or first point of Aries.

They draw a line from the Pole Star directly south through the point on the equator where the Sun crosses it. This line, called the Prime Meridian, cuts off the old year and the old circle of stars. It is 0 hours of Sidereal Time, 0 degrees of Right Ascension, and 0 degrees of Zodiacal Longitude where it cuts the celestial equator. It is thus the point both where and when a new cycle starts.

It had been observed that people born within 30 days after this chosen starting point, that is, from March 21 to April 21, were aggressive, used their heads when taking the offensive, and were given to leadership and to “butting in” on the affairs of others. In selecting a symbolical pictograph to represent these Aries qualities nothing seemed so appropriate as the Ram.

When it was found that people born in the following 30 days, from April 21 to May 21, were slow to anger, but violent and headstrong when once aroused, that they did not turn aside from obstacles, but stubbornly crushed their way through them by force and perseverance, the Bull was selected as best representing these Taurus traits.

The pictures thus selected to convey the outstanding qualities of those born under each 30 degree section of the path of the Sun were traced in the sky as stellar constellations. These constellated pictures are not each 30 degrees in extent, as are the signs which they describe. Some are more and some are less than 30 degrees. Yet a pictograph system must portray the first major division of the zodiac with the first constellation, and the second major division with the second constellation in the circle, wherever these may have shifted in the precessional cycle.

It was also anciently found, and made constant use of by the Chaldeans, that each of these twelve signs could be divided into three sections, and each of these sections, which were called decanates, had a distinct influence of its own; only less pronounced than that of the sign itself.

Therefore, to express in pictograph writing the influence of these 36 sections of the zodiac, embracing 10 degrees each, the ancients traced the 36 ultra-zodiacal constellations in the sky.

And in placing these symbolical pictographs of the influence of the 36 decanates of the zodiac in the heavens, they used the same system as they did when they traced the pictures of the 12 signs. That is, the first ultra-zodiacal constellation pictured the first 10 degrees of the zodiac, the second ultra-zodiacal constellation pictured the second 10 degrees of the zodiac, and so on.

Modern maps of the sky have many more than 48 constellations, because with the study of modern astronomy, kings and notables desired something placed in the heavens to remember them by, and the astronomers were accommodating. But the Greeks visited Chaldea and brought home the celestial sphere of the Chaldeans. And these old Greek sources show only the 48 constellations given in the illustration on page 3.

To form 48 distinct pictures, both north and south hemispheres of the heavens were used. To place pictures covering much of the two hemispheres on a single plane surface in their true relation to their distance from the commencement of the zodiac, causes pictures of one hemisphere greatly to overlap and obliterate the outlines of pictures of the other hemisphere. Hence, if the pictures of all 48 constellations are given on a single page, their true positions must be distorted.

The illustration on page 2 thus gives the ancient picture of each of the 48 constellations in correct detail, and proper proportion as to size; but moved sufficiently from its true place in the zodiac that the complete picture can be shown. The relation to the particular section of the zodiac which each ultra-zodiacal constellation represents in pictograph, is here denoted by the symbol of the sign to which the decanate belongs, and by a number showing whether it relates to the first, second, or third decanate of this sign. The diagram on page 10 shows this relationship fully.

The System Used to Denote the Zodiacal Relationship of Each Constellation

—Modern astronomers, because their work largely relates to observation, find it more convenient to locate positions in the heavens east from the Prime Meridian. Thus the east-west positions of the planets and stars are given in the Nautical Almanac for each day of the year in terms of Right Ascension.

But a vast amount of observation both ancient and modern—the Anu Enlil Series of the Chaldeans, which recorded both the positions in the heavens and the coincident events which happened on the earth, alone extending unbroken for over a thousand years—has made it clear that it is the position of a planet along the path of the Sun, and not its distance eastward from the Prime Meridian, which determines its influence upon human life.

Not only the signs of the zodiac and their decanates are measured along the path of the Sun, called the ecliptic, but the aspects that are formed between the planets, both in a birth-chart and by progression, are calculated along this path. The same point which is cut by the Prime Meridian is used as a starting place, that is, the first point of Aries; but the line of reference instead of extending south from the Pole Star through this point, extends south through it from the Pole of the Ecliptic. The distance from the Vernal Equinox, and from this line of reference, along the path of the Sun, or ecliptic, which a star or constellation is, is called its Zodiacal Longitude.

Because it is the Zodiacal Longitude of a heavenly body, instead of its Right Ascension, which determines its influence over human life, astrologers do not use the positions of the heavenly bodies as they are given in the Nautical Almanac in erecting and progressing birth-charts. Instead, they use an astronomical ephemeris, in which the ephemeris maker has conveniently, and by means of a simple formula, converted the Right Ascension positions of the Nautical Almanac into the Zodiacal Longitude which is required in all astrological work.

Now as astrologers of every age have used the Zodiacal Longitude positions of the heavenly bodies in their work—the star tables of both Hipparchus and Ptolemy including such zodiacal longitudes it is apparent that if they wished to indicate the order of sequence of pictures drawn in the sky they would use Zodiacal Longitude to indicate it. And that is just what we find they did.

The outlines of these pictures are not suggested by the contour of lines of stars. The pictures are imposed over star groups where their sequence would correspond to the same sequence of the sections of the zodiac which they were drawn to explain. The boundaries of the constellated figures, consequently, are quite arbitrary.

Modern astronomers, in ignorance of their true purport, have expanded some of the constellations to embrace adjacent areas, and contracted others to allow for the inclusion of new ones not recognized in ancient times. Thus in the matter of their size and sequence no reliance can be placed upon modern astronomical atlases.

Fortunately, about 1820, Alexander Jamieson published in a school atlas the pictured constellations of the ancients, with Longitude, Declination, Right Ascension, and Latitude of each correctly mapped for that year. Jamieson obtained these from some large, highly emblazoned, foreign monkish charts, which were reduced according to scale. Whence Jamieson obtained these old celestial maps, no one appears to know. But they are the most authentic maps of the ancient heavens we now possess, and are to be found reproduced in Henry Melville's "Veritas," published in London in 1874, which only recently has gone out of print.

We are under no obligation to accept the Ram as the proper picture of the influence of the first 30 degrees of the zodiac; or that the Sea Goat, able to swim in water, travel on the land, and scale the mountain heights, correctly portrays the diplomatic qualities and vaunting ambition of our Capricorn friends, over whom the tenth 30 degree section of the zodiac holds particular sway. Yet our everyday astrological observations convince us that these pictographs have been given their proper allocations.

Nor do we need to rest on any arbitrary method of sequence to convince ourselves that the pictured constellation corresponding to any decanate of the zodiac really portrays the significant quality over which that 10 degree section has special influence. Thousands of astrologers are using these decanate influences in their work. They have found that the picture and its Key-word accurately describe the influence of each.

Thus when we trace the manner in which they were given their proper place in the sky, we find it was after the system most direct and easily understood:

Starting after the first constellation which was to picture the first 10 degree section of the zodiac, no matter how far north or south the following ones were placed, the first point of their pictured outlines touched by Zodiacal longitude determined their order of sequence. According to this simplest of methods the second constellation, picturing the second decanate of the zodiac, was placed so that the portion of its outline nearest 0 degrees Aries was second in Zodiacal Longitude. The tenth ultra-zodiacal constellation, picturing the tenth decanate of the zodiac, in that portion of its outline nearest to 0 degrees Aries, was tenth in Zodiacal Longitude And the thirty-sixth ultra-zodiacal constellation, Cassiopeia, picturing the last decanate in the zodiac, was as farthest removed in the Zodiacal Longitude of that portion of its outline nearest 0 degrees Aries, following eastward around the circle.

The proper order of sequence, both according to the Zodiacal Longitude of the most westward point in the outline of each ultra-zodiacal constellation and according to the findings of research in natal astrology, is given in picture and in diagram on pages 2 and 10.

The Method Used to Perpetuate the Spiritual Teachings

—The objects sought by the ancients in these pictures, however, were not merely to portray the influence of a section of the zodiac over human life, but also to set forth the particular spiritual teaching which was equally related to the same zodiacal section.

Each position in the sky that had an influence over human conduct, to them implied that there should be a definite teaching which revealed how the individual could

overcome the threatened danger, or how he could take fullest advantage of the spiritual opportunity offered.

Natal astrology was not ignored. It was used as an avenue by which to make life on earth more successful, to the advantage of the individual and of society as a whole. But it was never lost sight of that the soul existed before incarnation in human form, and that it would continue to exist and function after the dissolution of the physical body. Therefore, they deemed it of even greater importance to know the spiritual trends associated with each astrological position than it was merely to know its influence as affecting the material fortune.

It was these spiritual teachings which defined the relation of the soul to other entities and to the cosmic whole, as revealed by the influence of the various sections of the zodiac, that the wise ones of old most earnestly desired to perpetuate, and to pass on to coming generations as the most valuable of all possible bequests. Yet the amount of information which could be conveyed by a single symbolical pictograph was narrowly restricted to the ability of others coming later to interpret it.

There is, however, also an oral form of universal symbolism commonly employed by primitive people. It conveys information through the avenue of a story. Therefore, to make correct interpretation of the pictographs drawn in the sky more certain, and to give details that were difficult to incorporate in such pictures, those who traced the constellations wove about each a symbolic story.

These stories, modified by time and custom though they are, still clearly reveal their correct stellar relationship. Some of the constellations and some of the stories, like those relating to Halloween and the destruction of the world, to May Day and the May Pole Dance, and to the Great Bear that circles the northern pole, are to be found among the people of every continent. Others are now less universally known; yet still are to be found as the cherished myths of certain peoples.

Thus it is that the sacred literature and the sacred customs retained by various peoples, when collected and interpreted according to the universal symbolism employed by those who gave them origin, afford a clear exposition of the Stellar Wisdom of the past. Racial memory, even though their meaning has long been lost, still feels the-r sacredness, still feels that they have spiritual import, and still preserves them, even as lifeless cloaks from which the vitality they once embraced, and which rightfully they still should clothe, has long since departed.

In each of the twelve lessons to follow, using the same universal symbolism in reference to the zodiac that was employed by those who first traced the constellated pictures, and using the stories about the characters thus pictured that are still retained in myth, legend and sacred custom, I shall indicate the spiritual teachings which originally were attached to one of the zodiacal constellations and the three constellations picturing its decanates.

In each instance I trust to be able not merely to indicate the spiritual doctrine taught by a constellation, but to point out the obvious implications of the universal symbolism employed by those who drew the picture in the sky and told a story to still further explain its purport. And I hope to do this in so clear a manner that the reader can easily discern the process followed by the ancients in thus perpetuating their findings, and that he will be able to recognize in each instance just why they adopted the picture and story employed, and thus to discern how wisely they selected each as best fitted to transmit the idea they wished to convey.

Why Moderns Are So Ignorant of the Stellar Wisdom

—Their wisdom in using pictures among the stars which the vandal hand of man has been unable to erase, and stories which have persisted in sacred literature, or like that of Santa Claus, in spite of the accepted sacred literature, is not merely demonstrated by the history of the past, but by events of the present day.

It has been the almost universal custom of those who rose to power, for the purpose of fastening their own pet religious beliefs upon the minds of their followers, as completely as possible to destroy all records and remembrance of every preceding religion. Even the name, as well as the beliefs, of Akhenaten, that most spiritual ruler of Egypt, was chiseled from temple and tomb wherever found.

In the Alexandrian Library, founded by Ptolemy Soter about 300 BC, had been collected, in so far as vast resources and research could obtain it, the written knowledge of the world, reputed to represent 700,000 volumes. It was over these scientific documents and treasures of literature, in so far as they had been collected, that Eratosthenes had been brought from upper Egypt to act as custodian. No wonder he could measure the globe and lay down precedents for finding latitude on the earth's surface which in principle are still followed by the mariners of our day!

When the Roman emperors adopted Christianity they saw in this great body of scientific knowledge and spiritual tradition a menace to the blind belief they demanded of their subjects. They destroyed the Alexandrian Library, and not content with burning books, they demolished all statuary, wherever found, that would give any inkling of the wisdom of the past. Of the Alexandrian volumes that escaped the ravages of Imperial Rome, the Mohammedans, equally as fanatical in their desire to preserve only the Bible and the Koran, made short work as they invaded westward.

When America was discovered it was rich in astrological wisdom. But the decree went out that every vestige of that knowledge, which was looked upon as diabolical, should be destroyed.

In The Church of Light QUARTERLY I have published articles—Stellar Religion and Healing of Akhenaten (Egypt); Stellar Religion of Southwest Indians; Astrology of the Aztecs; Posidonius and Chaldea; Itzamna, Great Initiate of the Maya; The

Arkansas Astrological Stone; etc. — in which has been set forth in considerable detail the Stellar Wisdom of various peoples in so far as it has been uncovered by modern research. These articles are available in the book, *ASTROLOGICAL LORE OF ALL AGES*, by Elbert Benjamine.

In this course, therefore, the stellar attainments of particular peoples will receive no consideration. Instead, the attention will be devoted to indicating the spiritual doctrines which in part measure were retained by all, in much larger measure by some and in lesser measure by others, and in full measure probably only by the most enlightened few.

Even the detailed explanation of the Aztec Calendar Stone which forms the lower illustration on page 13 must be referred to the article on Aztec Astrology. Suffice it here to say that it is a single season calendar by which not only the day of the year, but the zodiacal position of both Sun and Moon could be ascertained on that day. Too large to destroy, as it is of basaltic porphyry eleven feet, eight inches in diameter, and weighs some twenty-four tons, sometime between 1551 and 1559 after the execution of such Aztecs as were known to possess historical or astrological knowledge, Friar Alonso de Montufar had the stone secretly buried.

No one suspected its existence for over 200 years until in 1790, when some workmen, excavating in the Plaza Mayor, unearthed this huge testimonial of astrological knowledge, and it now rests in the Mexican National Museum.

The picture above it, preserved by Veytia, gives the names of the 13 days in each week, and the 7 weeks in each season, the dots being, of course, the universal symbols for the number of the week or day. It is thus, together with the universal symbolism in its center, merely a less conventionalized reproduction of the same factors sculptured on the Aztec Calendar Stone.

All four seasons of the Aztec Solar-Lunar calendar have been preserved to us by Diego Duran, who paid for his disregard of Spanish orders by being burned alive. The sketch, which was included in his "History of the Indians of New Spain," written earlier than 1588, is reproduced at the lower left-hand corner of the illustration on page 14. The diagram at the lower right-hand corner of the illustration explains just how it was used to find the relation between Sun and Moon on any day, and to find when any given aspect of Moon to Sun recurred throughout the year.

At the upper right-hand corner of the illustration on page 14 is the Triskelion Calendar used by the Aztecs, as preserved by Clavigero. By its means the Aztecs and other people who used it, could determine any distance in the future or the past, when an eclipse would occur and where visible, also when New Moons would occur, and which house of the chart they would occupy.

In the lower center of the illustration is a sketch of a date stone found on a Tennessee tomb, which employs both the Triskelion and the Swastika Calendars, after the Aztec manner, to record the time of an important burial. To left and right of it are Triskelion and Swastika symbols as commonly found in Europe.

The main part of the illustration on page 14 represents the Arkansas Astrological Stone. It was found a few years ago by a boat builder on the bank of Lake Hamilton, which is formed by damming the water of the Ouachita River near Hot Springs, Arkansas.

This Astrological Stone, although using quite different names for the 13 days in each week, and for the 7 weeks in each of the four seasons of the year, employs the same method, and determines the relation of Sun and Moon on any day of the year in precisely the same way, as does the Aztec Calendar Stone. In addition there are other symbols which relate to the astrological practice and the occult knowledge of the mound builders. These are fully explained in the article.

There is no call, I am sure, to give further instances of the fanatical endeavors which at various times have swept all important lands in the effort to obliterate all knowledge of preceding beliefs and customs; for we can see the process now in operations. Soviet Russia has placed a ban on God and religion; the Scopes trial made it illegal to teach evolution in the schools of Tennessee; and Hitler, dictator of Germany, not content to decide the religion his people must adopt, has made it illegal even to possess any book or literature relating to astrology.

The Religion of the Stars in Stone

—Yet in spite of the ease with which, for the most part, the more intricate astrological knowledge could be destroyed, so enthusiastically did the people of late prehistoric times build their monuments to the four chief tenets of THE RELIGION OF THE STARS, that the combined vandalism of subsequent ages has failed appreciably to remove them.

Huge stone monuments commemorating the stellar belief are to be found wherever there is land in a belt extending entirely around the world. Thousands of them, embracing four different types, still stand. In England, in France, in Egypt, in Mesopotamia, in India, in Peru, in Mexico and in the United States, there exist these stupendous stone records of beliefs inherited from a still more ancient people.

Even as the zodiac is divided by solstice and equinox into four quadrants, each represented by an arm of the swastika and presided over by the Bull, the Lion, the Eagle or the Man, so the ancient Stellar Religion had four corresponding outstanding doctrines, which like the quadrants of the swastika (see illustration this page) united in the complete circle of spirit to express a single all-embracing spiritual doctrine.

Dome-shaped mounds were used for magical ceremonies and for initiation. They are so used today by primitive peoples, the kiva of the Indians of the Southwest being a single example of many that can be cited. These were places where they went to demonstrate the hidden powers of the mind.

The sign Taurus, governing one quadrant, is the exaltation of the Moon, ruler of Mentality and of the feminine in nature. It is an earthy sign, and the dome of earth often was provided with a small entrance to the interior. Here then we have a teaching regarding the gestation of thought, and a record of the belief that man, through the proper exercise of his mentality, can control his own life and destiny, here and hereafter.

Huge, straight shafts of rock, upright like the rays of the midday Sun, symbolize the virile masculine powers which are associated with the sign Leo, which governs another heavenly quadrant. The house Leo naturally occupies in a birth-chart is the one concerned with pleasure, love-affairs and children.

The love of husband for wife and of wife for husband is a most holy and sacred thing, and is one of the most constructive forces that man can utilize. The love of parents for their children approaches the deific in its sanctity, and germinates the seed of that unselfish love that alone makes immortality possible. These straight shafts of stone, and the round towers which dot the globe, both record the belief of an ancient people that love is the way to life.

A horizontal slab supported by two or more pillars presents the form of a doorway. These dolmens are more than doorways, for the conspicuous feature of their construction is the flat, table-like surface presented by the slab held thus high above the ground. It strikes the eye at once as a plane, a plane above the earth.

The third quadrant of the heavens is presided over by Scorpio, ruling the house of death in a natural birth-chart. In its higher aspect it is pictured as an eagle. Thus does the slab of stone supported by two pillars indicate that death is the doorway to a higher plane of conscious existence, and that passing through it man ceases to crawl in the dust like a scorpion and soars, like an eagle, to a life of greater power and freedom.

Aquarius, presiding over the fourth quadrant of the zodiac, measures the influence of the stars with one hand, while water running from his urn flows down upon the earth even as do the vibrations of the planets.

Huge concentric circles of stone portray the orbits of the planets. These cromlechs, as they are called, bring to us the same message that is revealed by the constellation of the Man. They attest to the belief of those, who at the cost of tremendous labor erected them, that the planets have an influence over human life and destiny.

When these four ancient doctrines are united, their mutual implications become as obvious as that a circle is formed by the united zodiacal quadrants. The whole, as a logical necessity, then becomes summed up as the spiritual admonition, **CONTRIBUTE YOUR UTMOST TO UNIVERSAL WELFARE.**

Chapter 2

Serial No. 72
Original Copyright 1935
Elbert Benjamine

Copyright
Church of Light
August 2002

The Fountain of Youth

Chapter 2

The Fountain of Youth

Passover: Ancient and Modern

—Only in spring occurs that significant astronomical phenomenon which anciently was celebrated by the feast of the Passover.

This festival, in its essential elements, although called by different names in other lands, was not unique to the Jews. Nor was its observance confined to the Old World; for we find the American Indians also celebrating in quite as appropriate a fashion the passing of the Sun from darkness into light.

The Hopis, for instance, eagerly watch for the time in spring when the Sun shall rise exactly behind a certain peak of the San Francisco range. For generations they have recognized that when the Sun thus climbs the mountain, to balance a fiery globe atop its lofty spire, that days and nights are equal; and thence forward the day in length will exceed the night.

Because at this time the nights are thus equal to the days, we moderns call it the equinox.

It is, in truth, the passing over to the summer half of the year, from the dreary months of winter darkness.

When we think of the privation endured by primitive people, and even by our American pioneers, as their stored supplies became exhausted at the end of the season of snow and cold, we can have no surprise that they universally celebrated the passing of the Sun over the celestial equator from south to north, heralding, as it does, the commencement of the growing period with its new supply of food and its relief from the icy blasts that make demands for special clothes and shelter.

The less provident people of our state of Michigan are wont to say as winter draws to an end that if they can only hold out until the leeks come that their troubles will be over. The leek is an edible plant closely related to the onion. It grows abundantly in the Michigan woods, affords considerable nourishment, and is one of the very first of the “bitter herbs” to show green above the ground.

Why astronomers, both ancient and modern, considered the Vernal Equinox, or 0 degrees Aries, as the best starting point for both time and for measuring the east-west position of a star or planet in the sky, has fully been explained in lesson No. 72, as also was there set forth the method followed in selecting the pictograph symbols that they traced in the heavens, and about which they told stories and established customs by way of further explanation.

In this language of universal symbols which they employed the winter half of the circle, in which the darkness exceeds the light, is representative of our physical world and its obscuring clouds of misconceptions. The spiritual world, and the spiritual life, are referred to the summer half of the celestial circle.

Even as a week had seven days, one ruled over by each planet, so the life of man had seven corresponding phases of activity. The Sun, of course, was then as now, recognized as the source of virile power.

Among the Jews, who had acquired some of the ancient Stellar Wisdom, it was desired that each boy should be consecrated to a spiritual life of constructive effort. That each planet should have opportunity to impress its influence upon the child before this consecration, and that thus all seven phases of activity should be impressed by the ceremony, seven full days were allowed to elapse after birth.

When the Sun had circled the zodiac and passed over the Vernal Equinox into Aries, a new year began. to many ancient peoples as well as the Jews, symbolized the transition from the physical world to the spiritual plane of life. To signify that the child, while still on earth, was consecrated to a life of spiritual endeavor, a ceremony was instituted which should represent the circling of the Sun and its annual transition. On the eighth day the boy was circumcised.

As the section of the zodiac pictured by the Ram, into which the Sun moves as it completes its transition, embraces 30 degrees, at its very commencement it could hardly be considered a full grown sheep. Not only among the Jews, but among other ancient people, the first entrance of the Sun into the sign was associated with the beginning of a ram, that is, it was considered to signify a Lamb.

Using the blood of a Lamb as a token that a new and spiritual life had been entered upon was not a custom confined to Christian and Jew; it was part of that universal symbolism employed by all peoples who had inherited traditions based upon stellar correspondences.

The land of Egypt was referred to by the Jews as the land of darkness, corresponding to the dark signs of the zodiac, in which the Sun is prisoner before it passes over into the summer signs. The last of these signs, Pisces, has astrological rule over slavery and imprisonment, and the Israelites were captive in Egypt. The three constellations picturing its decanates are Cepheus, the king of Ethiopia, who sits on a throne; Cassiopeia, the queen of Ethiopia; and Andromeda, their daughter, who is chained to a rock.

The day anciently, as at present, commenced at midnight. When the Sun reaches the Vernal Equinox and first touches the Lamb it requires about six hours after midnight before it rises. Those sections of the zodiac through which it already has passed are of the old order, the old cycle, and are thus among the first born. Also on that day before the Sun appears, and after midnight, there are first born, rising through the house of birth to appear above the horizon ahead of the Sun, Capricorn, the goat; Equuleus, the horse; Pegasus, the winged horse; the king; the queen; and their captive daughter. Yet these all belong to that part of the celestial circle cut off by the passover into Aries.

Aries is a militant sign, and thus the Bible relates, "And it came to pass that at midnight the Lord smote all the first-born in the land of Egypt, from the first-born of Pharaoh that sat on the throne, unto the first-born of the captive that was in the dungeon; and all the first-born of cattle."

Exodus gives the rules to be observed during the passover ceremonies. No leaven bread was permitted in the house for a period of seven days, leaven being the symbol of impurity and pollution. At the feast the Lamb could not be eaten raw, nor sodden with water, but must be roasted; for Aries is a fiery sign. And it must be eaten with bitter herbs, to indicate the new growth and that the transition from physical life is not without discomfort. To show that the transition should be complete, avoiding earthbound conditions, any that remained in the morning must be cremated.

The Lamb to be used at the passover ceremony must be without blemish, in the first year of its life, and when slain, its blood was to be daubed on the lintel and two side posts of the door to the house. Thousands of doorways, formed of huge stones, where no houses have been, remain in various parts of the world where erected by prehistoric people. On top of two or more upright pillars, there is placed a huge slab of rock to indicate a plane above the earth, that is, a plane of life where people consciously dwell and perform their activities after they have passed through that doorway which commonly we call death.

The feast was to be attended, "with your loins girded, your shoes on your feet, and your staff in your hand; and ye shall eat it in haste."

The Jews who attended as thus instructed were plainly prepared to go places and do things. The daubing of the lintels with the blood of a Lamb portrays in universal symbolism the belief of those who originated the ceremony that we enter physical life through a doorway of pain and suffering, and that we take our departure to the next life through another doorway no less difficult. Yet because the blood used is that of the animal by which birth and happier days are represented, it also expresses the conviction that the new life will be an improvement over the one from which the passover has been made.

In a still broader sense the passover of the year has its counterpart in the precessional cycle. But instead of the Sun passing over the Vernal Equinox, the boundary between sections of the stellar circle does the passing. Thus have we now passed over into the Aquarian Age.

Pisces, the sign from which the world is passing, rules not merely imprisonment and restrictions, but crime and its punishment. It gave us a heaven which to most would be nothing more than a prison, and it taught us the doctrine of everlasting torment in hell.

With one hand Aquarius measures the influence of the stars, and with the other pours down his blessings. Right now the world is enduring the pangs of its birth into a heaven of new knowledge. The blood on the doorposts are but the incidents of this passing.

Many truths this new Aquarian Age will unfold. But none perhaps, of greater import to the human race that a detailed knowledge of conditions in the after life, of the best training here to fit the individual for his eventual responsibilities there, and the establishment of a non-restricted system of communication between those who live and function on the different planes.

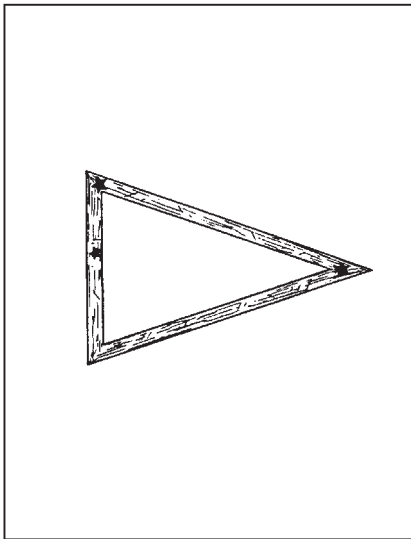

TRIANGULUM १२१° *Activity*

Figure 2-1

First Decanate of Aries

The Drama of the Triangle

—If one has ever watched an old ram lead his flock, the use of the Ram to head the procession of constellations will call for no further explanation. The section covered by Aries, however, embraces a full 30 degrees, and is divided into three sub-sections, called decanates, of 10 degrees, each having a distinct influence, which calls for a distinct spiritual teaching, or text, of its own. And until a little thought is given to the matter it is not so obvious why the very first 10 degrees of the zodiac should be represented, not by some heroic figure like Perseus or Hercules, but by something as prosaic and unromantic as the diagram of a triangle.

Aries has been given the Key-phrase, **I Am**, on account of those born under this influence, more than other people, viewing things from the standpoint of Individual survival and expression. Because of this, because they are pioneers who venture into new lands, and because it is here that the transition symbolically takes place, it is eminently fitting that the ancients associated the Ram with their teachings of survival. The text they sought to convey by Aries has been expressed by the poet:

**“There is no death! What seems so is transition:
This life of mortal breath
Is but a suburb of the life elysian
Whose portal we call death.”**

Yet as each of the other constellations of the 48 was carefully chosen and given its particular place where best it would convey specific information, we must conclude that the placing of a triangle at the beginning of the circle of decanates was not due to lack of more glamorous figures, but was prompted by the necessity of conveying some profound meaning.

Universal symbolism, a language which does not change with age nor race nor clime, is based upon common human experience. And as human nature in its essentials changes but little with the ages, our first response to the word triangle is probably that of bygone times. The domestic triangle is a favorite plot of stage and story, and a never-ending source of news headlines and neighborhood gossip. But in its more universal application just what does such a triangle imply?

Essentially, even as the green coloring matter in leaves in the presence of sunlight exerts so strong an attraction for the atoms of carbon in the air that they desert the oxygen atoms, with which they have been united as carbon dioxide, to enter a new partnership with atoms of the leafy structure; so does a domestic triangle embrace two forces acting upon a single center, yet pulling in a different direction.

The three sides of the constellated triangle express, better than anything of which I can think, two energies of different polarity, that is, with a different type of motion, united, and the result of that union.

While such a domestic triangle as has been mentioned, suggested by its drama quite as much as by the frequency of its occurrence, is indicated by the starry trine, there is another domestic triangle of still more common occurrence. Father, mother, child, are portrayed in the heavens, have positions of honor on both the tarot and the common playing cards, and represent the means by which nature reproduces and perpetuates the species.

Thus the domestic triangle, suggested by the trine of heaven, upon reflection reveals to us that the interaction of two forces, the diverse pull of polarity, has a potency in either of two directions: It may either build up or tear down, be devoted to creation and construction, or turned into channels which disrupt and destroy.

Although our physical lives are entirely dependent upon such constructive use of carbon taken from the air by leaves, all food coming to us either directly from the vegetable world or indirectly through other animals that have so obtained it, I believe we should seek in antiquity for the reason that the triangle, thus revealed as all-important, should have been placed at the very beginning of the zodiac.

Let us, then, take the story which has come down to us from the remote past which serves as commentary to the first pictograph in the decanate circle. We might well suppose that the start of the starry circle would find explanation at the commencement of some sacred work. Let me, therefore, quote the first three verses of the Bible:

“In the beginning God created the heaven and the earth. And the earth was without form and void; and darkness was upon the face of the deep. And the Spirit of God moved upon the face of the waters. And God said. Let there be light: and there was light.”

Great scientific learning is possessed at the present day. But with it all no better nor more scientific description of the bringing into existence of the material universe has ever offered. Out in the infinite spaces, Millikan believes matter is being created, and Jeans believes matter is being destroyed; as revealed by the terrific energy released in the formation of the cosmic ray.

Many scientists hold that stresses in the ether shear out right-hand and left-hand spirals of motion which are positive and negative charges of electricity such as, according to Millikan and Jeans, form the protons and electrons of matter which out in space is being created or destroyed. It is the same kind of matter of which our world is composed.

Substituting the ether of science for heaven and the matter sheared out of it for the earth, and we possess two sides of the constellated triangle, and a Bible description of the beginning of physical existence which at every point is parallel to that offered by material science.

Until there was the stress of two forces, strains pulling the ether in diverse direction, our men of science say that existence was without form and void; and as light is a particular motion in the ether, there was darkness everywhere.

Cosmic rays, resulting from the creation or destruction of matter, are invisible, as are many other waves in the ether, and thus even when ether and matter, as heaven and earth, were given existence, darkness may still have accompanied these waves; moving upon the face of the deep.

Nevertheless, this interaction, or polarity, generates movement; in fact, no movement, physical, mental or spiritual, ever takes place apart from the union of positive and negative potencies. Thus whether visible or not, when heaven and earth, positive and negative, ether and matter are present, there is action, which, as it is chiefly wave-like and not understood as to its exact nature, is well described as the Spirit of God moving upon the face of the waters and the third side of the universal triangle.

When, however, this energy reaches an intensity that causes the electrons revolving in given orbits about the nucleus of an atom, to make big jumps from their accustomed orbits to other paths, there is a spilling out of energy into the surrounding ether which sets up those wave-frequencies that we see, and call light. Light, therefore, while not the only product of the first interaction of positive and negative forces that divided ether from matter, heaven from earth, was a product that is of paramount importance to human life. As previously indicated, all the food we eat is manufactured by the green leaves of plants, and only in the presence of light.

To trace the universal application of this creative principle would be to encompass the entire realm of science, philosophy and the innumerable relations of life; for the first factor leading to every result is the union of the other two sides of the triangle.

As we are interested in the signs, decanates and constellations, let us consider how they are located and measured; by triangles, of course. Distances along the zodiacal circle from the Vernal Equinox, and distances north and south of the celestial equator, in fact, all distances considered in astrology, are measured and expressed in degrees of arc.

Such an arc is really one side of a triangle, the other two sides being the lines extending from its ends and meeting at the point of observation. The number of degrees east or west, north or south, either in the sky or on the surface of the earth, is merely an expression of the angle between the two lines which extend to the extremities of the third side of the triangle, which is an arc.

The science of spherical geometry and the science of trigonometry were both developed in olden times, and made skilled use of by Hipparchus before the Christian era, to plot the stars and constellations and measure the relations of the planets, each to the other.

The first measurements of time, and also of the positions of the Sun, were made by shadows cast by a stake upon the ground. By such shadows recorded at noon on the longest day and the shortest day of the year, the Chinese, in 1100 B.C. ascertained the inclination of the earth to the ecliptic. The stake and the shadow on the ground formed the sides of a right-angled triangle, the hypotenuse being the line from the top of the stake to the end of the shadow. Measuring this angle at the two specified dates, and dividing by two, gave them the angular distance north and south of the equator of the tropic of Cancer and the tropic of Capricorn.

The astrolabe was invented to measure the angular elevation of stars and other bodies which do not cast a shadow which can be measured. And as an astrolabe was a clumsy thing to use aboard a rolling ship, in rather modern times the sextant was developed from it as chief aid to navigation.

Thus it is that triangulation enters now into all surveying on the earth, and all plotting of the heavens; and any mariner who would venture far from land without an instrument by which through the use of triangulation based on his observation of Sun or Moon or stars he can locate his latitude, would be deemed mad.

The measurement of angles—triangulation—is not merely the first step in astronomical knowledge and astrological practice, but the importance of the trinity at the beginning of everything has been recognized by all the great religions of the world: Father, Son and Holy Ghost of Christendom; Brahma Vishnu and Siva of the Hindus; Osiris, Isis and Horus of ancient Egypt.

Creation involves a trinity, as also does destruction. It is only when the union of contending or divergent factions is properly directed that we attain true progress. Either in our mental conceptions or in our political systems, there must be some destruction of the old, worn tissues, to give place for the sound and new. Yet if the old is destroyed too swiftly and completely, there is insufficient power for recovery.

Those who are born from **March 21 to March 31**, while the Sun is in the decanate pictured by Triangulum, are distinguished for their **Activity**. And the starry triangle itself sets forth in its own symbolical language the text: **All Life, Thought and Action Are the Product of the Union of Positive and Negative Potencies.**

The Fountain of Eternal Youth

—As the first 30 degrees of the zodiac are pictured by a Ram to denote that they relate to creative energies, we may be sure, as already we have found in relation to the domestic trine, that the other two decanates also have to do with the creative trinity.

We find the Leo-decanate to be pictured by a river; the significance of which, I believe, is clearly set forth in the second verse of the Bible; for as the land can bring forth only when united to water, so in the story of creation, as soon as heaven and earth were manifest, the Spirit of God moved upon the face of the waters. That is, water is used immediately, even while the earth was without form and void, to symbolize the medium, or agent, through which the Spirit of God accomplished His purpose.

Now what is this thing in human life having a wave-like motion which is essential, as water is to parched earth, to its production? The zodiac quickly gives us the clue; for the starry river pictures a decanate having a sub-influence of Leo, which in a natural birth-chart rules pleasures, love-affairs, entertainment and children. Probably, therefore, the river is affected by all of these things.

The most characteristic factor common to enjoyment, love, and the production and care of children is emotion. The Key-word for the watery signs of the zodiac is emotion, and water, from time immemorial, has been used as the universal symbol of those mental states which cause a ripple of the nervous system, as the surface of a pond is stirred by a summer breeze. Our river Eridanus, however, in which the bestial Cetus dabbles his paws, and on the bank of which brave Orion struggles with the mighty Bull, is a particular kind of water. It is not just any pond, nor is it a raging torrent. It is emotion, but not of the Passive, sluggish kind; nor yet is it torrid passion. This river is deep, strong of current, and ample wide. For more details concerning it, let us turn to the rivers of tradition.

Across the black waters of the river Styx, the Greeks were wont to have Charon ferry the souls of their dead; while in Egypt the boat of the Sun transported them to the judgment seat of Osiris. Thus is the river quite definitely associated in one of its functions with the passing over so aptly symbolized by the beginning of Aries.

Just what part this river—picturing the decanate where the Sun, in whose boat the soul is said to depart, has its highest influence plays in that after life, and how it determines the plane of man's earthly endeavors, sacred literature reveals quite fully in either of two stories; one from the Bible and the other from the Greeks. But as already, with no aid from these, it has become apparent that our river relates to the emotions, let us first consider their chief influence upon human life.

Ponce de Leon might have saved himself much travel in search of this same fountain of eternal youth, so aptly pictured by the river in the sky, had he but known about his endocrine glands, and the varied response of their secretions to the emotions. Minute chemical messengers, secreted into the blood, burn up the life in fits of rage, starve the organs in fear and melancholy, and add youth and vigor at the behest, not of passion, but of unselfish lore.

Endocrinology has made it plain just how gross desires and ignoble delights add poison to the system; just how, also, the tender feeling of a mother for her babe, or the compassion which prompts the aid of those in distress, tones up the structure of the physical cells, conferring beauty, strength, and years of life. Here, however, even more than with the welfare of the body, are we intent upon discovering those laws which rule the fortune and the station of the individual, now and hereafter.

That finer body of man, his astral form, the energies of which, as may be proved by progressed aspects and his birth-chart, determine not only his abilities but also each event that comes into his life, is thought-built. His character is composed of thought-cells derived from his experiences, and these thought-cells have been compounded of such grades of four-dimensional substance as correspond to the feelings and desires coincident with their formation. They have been compounded also in association with pleasure or pain, and to the extent they feel discord do they attract misfortune into the life, and to the extent they feel pleasure do they work to bring good fortune.

Nor is this Law of Affinity confined in its operation to the physical plane. The thought-built body is the one that persists beyond the tomb. The basic vibratory rate of the character, in that after life, determines the plane, or level, to which it moves. In fact, here or hereafter, it; can neither rise above nor go below its basic vibratory level except as some finer emotional state temporarily raises its vibrations, or as through baser inclinations it lowers them to inferior strata.

In that after life, even more than here, the environment to which an individual is attracted is determined by his strong desires. Emotion not only expresses, but nourishes and fattens, kindred inclinations.

Man's etheric body, and the currents which flow over his nerves, as well as his astral form, are receptive to vibratory rates of similar tone coming from without. Thoughts of sufficient potency to engender feeling tune the etheric forces in on planetary energies of similar kind. Thus, not only is man a radio receiving set, but his emotions turn the dial to the program which he receives.

Furthermore, again considering the domestic triangle with which we started on our tour of the decanates, when man and woman are joined in the pure affection of family life, there is a blend of mental and etheric forces, a stream of energy, flowing from each to the other. A complete circuit is formed between them, an invisible river, which transfers without need of speech, the thoughts and inward aspirations.

Those thus united by the astral and etheric flow pictured as Eridanus are said to be in rapport. And their ability to pick up invisible energies of corresponding quality in volume is immeasurably increased. It becomes a potent means, therefore, of lifting them to greater heights, or misused, is equally powerful in their own destruction.

The Greeks relate that Phryxus and Helle were the children of Nephele, queen of Thebes. As the only queen in the sky is Cassiopeia, picturing the last decanate of the emotional sign Pisces, these children must be represented, not by Andromeda chained to a rock, but by two fish. This is further borne out by the ribbon of love uniting them, as the etheric river Eridanus binds together through affectional power.

These children were persecuted by their stepmother Ino, pictured directly across the zodiac as Virgo, the critical woman. To escape her faultfinding and more serious intentions, the queen provided the youngsters with a Ram which was to transport them through the sky to Colchis.

The Ram rose high in the air, bearing on its back, even as can be seen now on any winter evening, the two children; for Pisces rises just above Aries. Phryxus kept his seat and reached his destination in safety. But so high did Aries soar, and so swiftly did he move, that Helle became giddy and fell off, to meet a tragic death in that stream now called the Dardanelles, but renowned in song and story, thus named because of the event just related, as the Hellespont.

The Ram, universal symbol of creative energy, carries those in safety who are level-headed enough not to meddle with rousing the kundalini, or with any one of the abnormal methods by which energies are engendered that once set in motion, more frequently than not, get beyond control. Nor does it offer any menace to those who truly live in chastity. But to those who stimulate and then repress, in monastic life or out of it, desires which normally find expression in founding a family, as there is now a vast psychoanalytic literature to prove, the fate of Helle offers warning.

Of similar purport, and also indicating the survival values in the after-life, of properly cultivated emotions, is a story of passing over the Jordan as retained in the twelfth chapter of the Book of Judges.

There had been a fight, and the Gileadites had taken possession of the river crossings. Survivors of their vanquished foes, the Ephraimites, sought to escape through fording the river; and to do so claimed to be men of their own troops. Whereupon, to determine if this were so, they were required to pronounce the word Shibboleth. This they could not do if they were Ephraimites, as they were unable to sound the H, speaking it Sibboleth.

This H, inability to pronounce which doomed the Ephraimites to be slain, is the second syllable in the divine word, and its omission denoted to those familiar with its significance, that the feminine principle, which constitutes one important factor in the trinity when its action is constructive, was missing. In the language of symbolism it was the lack of the softer, finer, kinder, and sympathetic emotional qualities which betrayed the Ephraimites, and prevented their crossing the river in safety.

In practical astrology it is found that the Sun exerts its finest power from **April 1 to April 11**, while in the Leo-decanate of Aries, long recognized as the region of its exaltation. And it was to portray that quality in human life which more than any other is able to lift the soul to lofty heights, give youth to the body, and assure immortality in the realms of the beyond, that the ancients sought a fitting symbol.

The Key-word of the decanate is Exaltation; and it would be difficult to find a symbol which so clearly indicates the means to attain this end as does the celestial river. Eridanus, to those who read its purport, sets forth this text: **The Fountain of Immortal Life Springs From Man's Emotional Nature; the Vibrations of Exalted Love Having a Rate Sufficiently Frequent to Affect Spiritual Substance and Build a Spiritual Body.**

Knight Errant of the Zodiac

—Only since the World War, when bureaus were established to create a public opinion favorable to certain ends regardless of their merit, has the term Propaganda, which is the Key-word for the last decanate of Aries, fallen into some disrepute. Its original meaning was that of an organization by which some doctrine or system of principles could be disseminated.

People born from **April 11 to April 21** are observed to have a spontaneous enthusiasm for ideas and plans which interest them, and a special ability to impart similar enthusiasm to others. It is not enough for them to believe some doctrine to be worth while; they must also broadcast it to the ends of the earth. And they are as quick to attack falsehood and corruption as they are to strive for world-wide recognition of such truths as they have found.

The ninth house of a birth-chart, over which Sagittarius has natural rule, governs long journeys and air travel; also teaching, lecturing, preaching, publishing, radio broadcasting, and all other means by which opinions are expressed to others. The Sagittarius decanate of Aries, therefore, relates somewhat to such things. Thought, which is thus expressed, is so swift that speeding on the wings of thought has become a current literary phrase, conveying the same idea that the ancients did when they placed wings on the feet of Mercury and Perseus.

In addition to wings on his feet, which Greek legend says were furnished by Mercury, the ruler of thought, Perseus is equipped with a sword, the tip of which is as close to the line which cuts off the old circle and starts the new as it can be and yet follow Triangulum and Eridanus where their outlines are farthest west in longitude. You will remember that David of the Bible had no sword, but that he used one in victory to sever the head—which is ruled by Aries— from the body of the fallen Goliath.

The severed head which constellated Perseus holds is not that of the biblical personification of greed and selfishness, but that of the Gorgon Medusa. In the Bible story it was Goliath who wore the helmet, now seen on the champion of truth and righteousness. Also a famous shield went before Goliath; but in the Greek story is used by heroic Perseus, and is not pictured in the heavens.

To understand these stories of David and Perseus it must be recognized that the ancients knew what modern astrologers grant, that people born with the last Decanate of Aries dominant are natural champions in the cause of truth and ever fighting to destroy greed, licentiousness, and those materialistic trends which fasten shackles on the soul.

In both stories a stone appears, one the smooth white pebble of scientific truth, of material knowledge completely understood, which vanquishes selfishness through the realization that its crystallizing power so narrows the field of accomplishment that its own ends are defeated. The gross, the bestial, the greediness which seeks its own pleasure and welfare only, as typified by Goliath, when seen in the light of careful reflection, are not the way even to the highest material pleasures. Enjoyment of life, even physical enjoyment, is dependent upon appreciation of quality. It is dependent upon a responsiveness to the aspirations of others, and a progress toward refinement, both of which are denied by impervious selfishness.

This aspect of the matter, and that of the influence of licentious thought to coarsen and harden, is made quite plain in the legend of the Medusa, whose hair was serpents, so awful in appearance that whosoever looked upon her was immediately turned to stone.

Perseus, picturing the Jupiter-decanate of Aries, was the favorite of Minerva, a goddess who, as personifying the mental rather than the sporting side of Jupiter's dual sign, sprang without a mother, full-armored, from the brow of this Sagittarian ruler.

Minerva is mentioned only because, when Perseus decided to rid the world of the wicked Medusa, she furnished him with a shield so highly polished that he could approach the lascivious monster without actually looking at her. Had he glanced directly at her dread countenance, he, as had so many others, should have been turned to stone. But the shield of Minerva, the mirror of the higher mind, gave him the reflection of this seducer of men, so that, while she slept he was able to make a stealthy approach and sever the terrifying head from her body.

No greater wisdom was ever uttered in reference to character building than is thus dramatically presented. Impure thoughts and unworthy desires not only harden the individual, but they thrive and prosper to the extent attention is paid to them.

There is but one way to destroy them, the way employed by Perseus; and that is to become so interested in something else that the attention is riveted to it—as his gaze was fixed on the mirror of his shield—so persistently that there is no room for the image of the undesirable to find its way into the field of vision.

When we think about a thing we create it in the astral world. Way back in Bible times it was said, that which we fear shall come upon us, and modern psychology is in full agreement with this view. To fear a thing is to keep its image before the mind and, by the accompanying emotion, to nourish it.

But whether the image is vicious or beneficial, destructive or constructive, the energy added to it by whatever emotion is present—fear, anger, hatred, joy, happiness, affection—sets the thought cells within the astral body related to this department of life to working from the four-dimensional plane to attract that thing into the life. If, therefore, the thing be detrimental, find other occupation for the vision of the mind.

This same principle also must be followed if there is to be success in building better habit-systems, if there is to be success in avoiding the inimical thoughts of others, and in combating undesirable psychic forces. The more a habit is thought about, and the greater the emotion felt when so thinking, the more strongly does it become impressed upon the unconscious mind. Bad habits can be cured only through the substitution of beneficial ones which crowd them from the life.

Not all of this Medusa story has been told; only that which relates to mental images and the desires of physical life. She was one of three Gorgon sisters, and when she was slain there was danger of reprisal. Perseus was able to escape them, however, by the use of the helmet shown in the constellation, which made him invisible.

This helmet had been provided by Pluto, ruler of the underworld; the planet now assigned to govern the eighth house of a natural birth-chart, the house which rules all influences from, and relations to, the dead. More than any other planet its influence is such as to enable the individual to tune his vibrations, radio fashion, to influences from the invisible world.

Those who have difficulties of a psychic nature, who have tampered unwisely with the invisible world, are here instructed by the wisdom of the past, as handed down through universal symbolism, in the best method of escaping from these remaining Gorgon sisters.

When through strong desire, we tune ourselves quite completely to one frequency of vibratory rates, this automatically cuts off others. When the dial of a radio set is tuned to pick up the program broadcast by one station, this eliminates the reception of programs which are broadcast over frequencies quite dissimilar. Thus it is, as proved by the experience of many people, that the best way to escape an undesirable psychic

influence is not to fight it, which tunes the finer body to receive its rates, but to wear the helmet of Pluto, and become invisible and unaffected by its power, through completely and persistently tuning in on some dissimilar and constructive interest.

True to the Key-word of the pictured decanate, Perseus was a glamorous hero who felt it necessary to help the world along. Escaping from the remaining Gorgon sisters, and triumphantly bearing the severed Medusa's head, he flew high through the air; an aviation exploit which led him to the discovery of a princess in distress.

Like many mothers now Cassiopeia was a slave to pride and station. She wished to be the envy of all the other women in the world. And in her desire to outdo them she boasts of her beauty, claiming to be of greater charm than Juno and the Nereides, nymphs of the sea. This so angers Neptune—who rules the sign in which the decanates pictured by Cassiopeia and Andromeda are found—that he has her daughter, Andromeda, chained to a rock in the sea for the monster Cetus to devour.

But before this fearsome human sacrifice is completed, Perseus, flying high overhead after his conquest of the Medusa, spies the fair maiden in distress, dashes to the rescue, vanquishes the monster of the sea, releases her, and carries her off in happy marriage.

We will not here dwell upon the release of the human soul from the blind beliefs of the Piscean Age through the dissemination of correct information. Nor is it necessary to comment upon the power of undue attachment to any material thing to bind the soul to earth, and prevent its progress, both here and immediately after death.

But again it should be pointed out that the character of the individual is the sum total of his experiences stored in the thought-cells of his finer body. No one can change these for him; no one, therefore, except himself, can slay the beast within nor overcome the noxious influence of creeping slimy thought, nor release the soul from other bondage.

The exploits of Perseus each, in symbolical language, conveys an important message; but most important of all, he accomplished the work himself. The leading text thus portrayed, therefore is: **There is No Vicarious Atonement. Each Soul is a Responsible Being, Working Out its Own Deliverance from the Thralldom Inherited from Ancestry and Forced Upon It by Environment.**

Chapter 3

Serial No. 73
Original Copyright 1935
Elbert Benjamine

Copyright
Church of Light
August 2002

Knights of King Arthur

Chapter 3

Knights of King Arthur

The Use of the Golden Calf

—What was the amazement of the first explorers of the mighty Amazon to learn from the Indians that the group of stars comprising Taurus, and picturing the money sign of the zodiac, was known to them as the Jaw of the Ox. Yet when we reflect that the Vedas of India and the Avesta of Persia both make mention of the massive Bull, and the Apis was an object of special veneration in Egypt, it is not so surprising that ideas which doubtless had their origin in Ancient Atlantis and Mu should also have been retained in part by aboriginal South Americans.

The interpreter of Pharaoh's dream reveals himself familiar with astrological practice. Personal possessions are governed by the second house of the birth-chart, over which Taurus has natural rule. When the Egyptian king began to speak of kine coming up out of the river, even as the Bull of heaven appears to be emerging from the river Eridanus, it could refer to but one thing: to wealth. When he told of ears of corn, that also was speaking of a universal symbol long established among the stars. Virgo, the harvest constellation, holds such in her hand.

Joseph revealed his acumen not in his knowledge that the kine meant wealth and the corn meant food, but by his recognition that the seven fat cattle which were devoured by the seven lean cattle, and the seven full ears which were consumed by the seven lean ears, related to future years; and by his ability to so thoroughly convince the monarch of the truth thus revealed that for the seven years of abundance he was willing to set aside one-fifth of all the crops as a reserve against the years of approaching famine.

Picturing the middle decanate of this sign of material possessions there is another hero. The Akkadians called him Sargon, and the Greeks called him Orion, but we are more familiar with him through the Hebrew account. One foot he rests upon the river; for like the far earlier Semitic Sargon, Moses put in his first appearance among the Bull-rushes.

Yet as here we are interested in the mighty Bull pitching down upon him from the sky, rather than with exploits of valor, he enters our story only to the extent made necessary to reveal the teachings the ancients sought to picture by the Taurus constellation. It all is embraced within the drama of the golden calf.

It will be remembered, or the thirty-second chapter of Exodus can be consulted if the memory has grown dim, that Moses went up Sinai to receive instructions, and came down the mountain with two tablets of testimony, tables of stone, written with the finger of God.

Taurus, the fixed earthy sign of the zodiac, more nearly than any other relates to stone; but this alone does not explain why there had to be two tablets, instead of one. That such was the case is clearly indicated; for after the first set was broken, the laws of God were again written on two tablets, and so survived.

Spirit, being without beginning and without end, has ever been symbolized by a circle, while the earth, as a plane receiving the vertical rays of the Sun, has universally been represented by a square or a cross. As later is to be related, Easter is a festival commemorating the union of Solar and Lunar forces which causes seeds within the earth to germinate; and a feature of Easter custom still retained is the eating of hot cross buns, circular in outline with a cross traced upon their tops.

Removing one of the four arms gives us the Taucross of the Egyptians and some others, from which was derived the Greek letter Tau, the English T, and the common gavel of ancient Masonry. It expresses creative energy moving in the direction indicated by the longer member of the three-armed cross. As this may point either toward heaven or toward earth, by this means was indicated whether the energies of life were being used for gross and physical gratification, or were directed into channels of aspiration by which the spiritual heights might be scaled.

Even as the reversed T was used in various lands to indicate by its upturned point the striving upward of spirit, and by its more commonly down turned point material ambition; so were there also two tablets of stone, one setting forth the laws of physical survival and the other revealing those laws which relate to spiritual realization.

But as Moses tarried on the mountain his people became impatient and induced Aaron to make a molten calf. It was of gold because the Sun rules that metal; and because this orb of day had but reached the commencement of the sign it could not be considered a full grown bull, therefore it was called a calf. It was molten because this section of the constellation is backed against the fire of Aries.

To make this interpretation of the olden story still more certain, Taurus in practical astrology rules not merely material possessions, but also the neck and ears of human anatomy. Repeatedly, in the narrative, those who divested themselves of their earrings, from which to make the golden calf, are called a stiff-necked people. And as the vocal organs also come under the rule of the same zodiacal sign, it was their

singing which he heard, as he approached the camp on his return, that first apprised Moses that mischief was afoot.

The constellated hero in the sky is pictured with upraised club in the very act of demolishing this symbol of the greed for gold. On the bank of the river is he in the act of demolishing it. Yet only the story reveals the ultimate fate of the calf so attacked; for strange to say, it was not thrown away, nor again turned into a bauble of adornment.

Instead it was burnt with the fire of spirit, ground to powder in the mortar of compassion, and strewn on the life-giving water from the nearby river of affection. It was neither ignored, nor despised, nor coveted; but was made of spiritual use; for after thus converting this symbol of material possessions into that which no longer could be worshipped, it was given to the children of Israel in their drink.

But before this came to pass, because they had been divested of their earrings, they were seen to be naked. These earrings, as I have endeavored to show, were universal symbols for all the tinsel and display, all the money and its power of purchase, which many men set their hearts exclusively upon. Divest them of this and they have nothing left. Their treasures are purely physical, and they have nothing suitable to clothe their souls in higher realms.

Nothing could be plainer, I think, to one conversant with universal symbolism, that the significance of utilizing, in an affectional way—all the more easily understood because Venus, planet of affection, is the ruler of Taurus—the material things represented by the golden calf. If anyone ever had great provocation completely to destroy, it seems to have been Moses. Nor was it due to a relenting heart that he made use of the material idol when spiritualized, as his orders to the Levites clearly indicate. It was because wealth, station, power, and other physical possessions, all can be converted, as he converted the golden calf, into a means of creating spiritual values.

Some there are, I know, who believe the vow of poverty opens wide the Elysian gates. Others there are who teach withdrawal from the contacts of the world of men, deeming that in solitude the spirit more quickly develops wings. But the story of the golden calf refutes all this.

People come into this world endowed with natural talents of various kinds and diverse degree. Richness of life to human beings comes not from absence of contacts, but through the development of proper appreciations. These imply some freedom from the dulling grind of economic necessity, some surcease from grueling toil. And they depend upon human associations, upon opportunity to learn, and upon material objects through which the senses gain an insight into what is fine and good.

Material things are detrimental when they are worshipped, like the golden calf, for what they bring in selfish gratification. They prevent spiritual growth when they become so insistent in their care that the burden is too heavy. But nothing opens the avenues to spiritual attainment so effectually as being of assistance to others. And often the assistance needed is of a physical nature.

To worship the golden calf of wealth is utmost folly; yet to ignore the power of money when rightly used to advance the welfare of the human race is almost an equal fatuity. Libraries have been built and stocked with books where men may read and free their minds; literature has been published and widely spread by which the spiritual truths have been made accessible; laboratories have been set up for research and clinics established for treatment, that have practically eradicated certain previously prevalent forms of disease; but not without the aid of money.

While we occupy a physical world the body has physical needs, possesses physical functions which if not exercised cause trouble, and must make contacts with physical conditions if we are to gain those experiences which alone fit us properly for a still higher type of life when we have passed on to the next inner plane. A physical body which is neglected detracts from the ability of the individual to do constructive work; hampers his efforts to contribute values to society.

According to the natural abilities, which the birth-chart so surely reveals, is there open to the individual the opportunity to advance himself in the direction of becoming more valuable to others. Whether it is the use of gold, the power to heal the body, ability to teach, inventive genius which contributes a device that, relieving toil, gives time and strength for soul development, or other power to do, it may be turned to spiritual advantage.

Because those born from **April 21 to May 21** are found to be so interested in personal possessions the Key-phrase given to Taurus is, **I Have**. Because the physical is so necessary in developing the spiritual, the ancient text becomes: **Physical Life and Its Opportunities Should Not be Slighted; Neither Should Spiritual Aspirations Be Ignored. Learn, therefore, to “Render Unto Caesar the Things Which be Caesar’s and Unto God the Things Which be God’s.”**

The Good Luck of the Rabbit’s Foot

—Seeking to discern what the ancients had in mind when they traced the picture of a rabbit in the sky to represent the earthy decanate of the sign of material possessions brings instantly to thought the three outstanding attributes of the hare: fleetness, timidity, and rapidity of reproduction.

Fleetness, as indicated by wings on the feet of Mercury and Perseus, has to do with thought; and as the Moon exerts its strongest power in the Taurus-decanate of Taurus, we perceive the aptness of an association between this section of the zodiac,

occupied by the Sun from **April 21 to April 30**, and the lunar orb, which in a birth-chart rules Mentality.

Easter is a modern adaptation of the old name of the Moon, which by the Chaldeans was called Ishtar became Astarte to the classical nations, Eoster to the Saxons, and finally was designated by the term now used for her chief annual festival. In this festival her greatest power, as signified by her exaltation in the beginning of Taurus, is celebrated as chief aid to the function of the Sun. Easter is the Sunday after the Full Moon after the Sun has passed into the summer half of the zodiac.

At this Full Moon, because the Sun is in Aries, where its creative energies are strongest, the Moon must be in Libra, the sign ruling both marriage and eggs. Eggs, consequently, form a persistent factor in that spring festival dedicated to the redemption of the world by united man and woman, even as it is deemed to be rescued from winter through the offices of the united Sun and Moon.

These eggs commonly are colored in various hues to signify diversity in the expected harvest, and they are hidden about, and must be hunted for, even as other seeds are placed in the Sun-warmed dark ground of the beginning of Taurus, where they germinate, and only later thrust green shoots through the surface into the kindly light of day.

Bunnies also are part of the ceremony; for although they do not lay eggs, as children are sometimes led to believe at Easter, they are unusually prolific, and stand symbol of the power of the earth to bring forth.

This decanate where Easter has her strongest power also is associated with the greatest tragedy mankind has ever known. Hallowe'en commemorates the destruction of the world, the fire, the flood, and the sinking of Atlantis. The Sun at that time is in the death-decanate of the death-sign Scorpio, directly across the zodiac from this rabbit-decanate of Taurus. Thus when Ophiuchus, the man in death struggle with a serpent. who pictures the first-decanate of Scorpio, sets in the west, vanquished by the great destruction, Lepus, the hare, rises in the east, and is shown fleeing from the scene of catastrophe as fast as fleet legs will carry him.

Tradition holds that the time when such cataclysms occur may be timed by the position of the Pleiades, a group of stars behind the shoulder of the Bull, in relation to the precessional cycle. As the Bull faces eastward toward the earth as it rises, and as the whole rear half of it has been destroyed in the cataclysm, the Pleiades come up first, as Lepus pictures that section of the Sign Taurus first to rise. Noah quickly left behind his sinful companions when he entered the ark. Lot left Sodom in great haste: and legend says that the wise ones of Atlantis, warned by the position of the Pleiades, went from their doomed land at top speed.

In one of the oldest written accounts in existence, the Gilgamesh Epic of still more ancient Sumeria, the cuneiform tablets of which have been recovered from Assurbanipal's famous library at Ninevah, it is related that after the hero conquers the mighty Bull which has caused seven years of sterility on the earth that Ishtar places a curse upon him. But Gilgamesh evades the curse, tears the entrails from the Bull, dedicates its crescent horns to the Sun, and washes his hands in the Euphrates, which was the river Eridanus of the Sumerians.

As the earthy-decanate of Taurus may well be taken to represent the more physical section of the sign, so the rear of the Bull, which in rising comes first, is similar in its symbolic implications. It was the materialism and wickedness of the world that made necessary the flood from which Noah fled. It was the turning from God to abominations of the flesh that led to the destruction of Sodom and Gomorrah. And the use of mental powers and psychic forces to enslave the populace is said to have preceded the sinking of Atlantis.

All magic, now more commonly called mental demonstration, new thought, or metaphysical practice, is made possible through the activity of the mind. And this peculiar power resides in greatest measure in those born with the first decanate of Taurus dominant.

Such magic, such healing energy, and such force of mind, can be used in either of two directions. The voodoos of our South follow the example of Ishtar, and place a curse upon their enemies. But others more enlightened follow the example of Gilgamesh, and dedicate this crescent power the horns of the Bull, to spiritual purposes, represented by the Sun.

That the self-seeking, materialistic, or destructive use of this lunar power must never be countenanced was portrayed by the ancients when they failed to picture other than the front portion of the Bull in the sky. Nor will the Jews, preserving the symbolic custom to this day, eat of a beef other than the portion pictured. To those of that orthodox faith the portion omitted from the stellar picture is unclean and may not be served as food; as they say, it is not Kosher.

As the Sun, in practical astrology rules the Individuality, and has its exaltation in the Eridanus decanate, and the Moon rules the Mentality, having its exaltation in the Lepus decanate, when the epic hero of Sumeria dedicated the crescent horns of the Bull to the Sun and washed his hands in the river, in pantomime he was consecrating his Mental powers to their highest, most spiritual, use. And these horns of the Bull, through various avenues have descended to us as a means by which the adverse effect of mental forces can be avoided.

How blind are those who can see no farther than the material plane; who prostitute their souls for the attainment of carnal desire, and whose minds turn only to wickedness and destruction. When Sodom and Gomorrah fell in flames the Bible relates: "And they smote the men that were at the door of the house with blindness, both small and great; so that they wearied themselves to find the door."

This blindness of devoting the energies solely to the gross, with no thought for the finer experiences of life; and that even more terrible practice of using the psychic powers for the injury of others, is pictured by the star which blots out the eye of the rabbit in the sky. Blindness is also traditionally associated with the Pleiades, the cyclic pointers of cataclysmic destruction.

Ptolemy, compiler of ancient astronomical knowledge, says that when the Moon is with the Pleiades and afflicted by Mars in a chart of birth that the person will go blind. As a matter of astrological research, when the Moon is greatly afflicted by Mars, trouble with the eyes may be expected whether the Pleiades are involved or not. But in this manner has the tradition of loss of sight through evil mental practices come down to us.

And thus it is today, in all regions where prevails the belief in “evil eye,” which is supposed to be a curse placed upon one person by another’s malignant look, that the attempt is made to ward it off by forming the sign of the Bull’s horns. This is done by closing the hand in such a manner that the first and little finger stand out to form a crescent, and then gouging in the direction of the person casting the spell as if to gouge out his eyes.

The rabbit in the sky is pictured fleeing in great haste from all such influences; and as he is moving directly away from the section of the zodiac where the cataclysmic struggle takes place, turning his back on the scene of various iniquities, the legend persists to this day that, like those who fled from Atlantis before it sank, and like Lot who made his escape from Sodom, the rabbit gained safety. It thus acquires an implication of good fortune.

The foot of any creature is the universal symbol of understanding of some kind; and the foot of the rabbit implies an understanding of those things for which the rabbit stands, that is, of mental practices devoted to injury, and how to escape their influence. The negro who carries a rabbit’s foot to prevent a “jinx” being placed upon him, and as a talisman of good luck in general, is merely perpetuating, by means of a symbolic ritual, an ancient truth of vast import.

It requires great determination not to look at, or think about, the thing which if permitted to do so would cause fear: and thus those born with the first-decanate of Taurus dominant have, as the Key-word **Determination** clearly indicates. The earthy decanate of the earth’s own sign in particular needs to exercise the Determination which it so abundantly possesses to face away from the gross and sensual, and to escape the paralyzing effect of fear.

The hare, although fleet of foot, is a timorous creature that burrows in warrens beneath the ground, like those who, submerged in materialism, live in constant dread of death. Lot escaped from the hail of fire and brimstone, but his wife, unable to resist visualizing the thing which she feared, looked back, and became rooted to the spot. The salt, which ultimately she became, shows the crystallizing power of selfish inclinations.

When we positively desire a thing we flash the image of that which is sought upon the mental screen, and the thought-cells belonging to that department of life work with such energy as they possess to make that condition a reality. But when in fear the image is the opposite of that which we seek, these four-dimensional sparks of consciousness work just as hard to carry out the orders they thus receive, disastrous though the result may be. Even as the rabbit is blind, so fear blinds the eyes to the proper mental picture, accepted as a command by the unconscious mind, to get wished-for results. Hence follows the text: **One of Man's Greatest Enemies is Fear.**

Knights of King Arthur

—Jason conquered the brazen-footed Bull in one of his adventures while searching for the Golden Fleece, and Sargon of Akkad, fourteen hundred years before the time of Moses, came up out of the Bull-rushes to deliver his people from their tribulations. But nearer to our own time, and perhaps, therefore, dearer to our hearts, is King Arthur and the famed Knights of his round table.

As is common to traditions when the historical background is dim or lacking, there are variants of the original, but the most authentic version of the story finds twelve knights, bold and strong, seated at a circular and revolving table; ready, like a panel of modern jurymen—twelve men good and true, each to view the matter from the angle of one sign of the zodiac—to pass judgment, and, unlike these later representatives, to fare forth in valiant exploits in the enforcement of their decisions.

The most conspicuous constellation on any yule-tide night, while the Candlemas Bull, Taurus, goes sailing overhead, as legend says it must, is Orion, who follows with upraised club. In every land is he recognized as a warrior, and the three stars in his belt are known in every land. In the region where the Tigris and Euphrates flow they are called the Wise Men of the East; but Celtic Druids held them to be three ladies who were present at King Arthur's birth.

Not only is Orion a warrior, but whether as Sargon, Moses, Jason, or the western legendary king, the fight he wages is not merely against oppression from without, but also against the materialistic tendencies and selfish ambitions of his own men. In every legend relating to him, he fights with environmental forces that endanger his plans; and in every struggle some loss is sustained.

Moses, you will remember, when he had vanquished and utilized to more spiritual purposes the golden calf, called upon those who would support him, even as the constellation thus pictures it, every man to put his sword by his side. And legend relates that the round table episode was precipitated by the personal ambitions of Arthur's men.

Each one desired the place of honor at the yule-tide feast; each man believed himself entitled to sit near the head of the table. Nor, although so many hundred years have passed on what should have been progressive feet, do we witness much diminution in

the ardor for similar social prestige. But on this notable occasion the snubbing of one's neighbor was insufficient to express the fires of jealousy that raged within, and a brawl ensued which resulted in many slain; as a thousand years before a like slaying had occurred over the incident of the golden calf.

And thus, as Moses in the Bible times had been confronted by a serious problem, so was Arthur put to it to prevent a recurrence of such an incident among his men. Nor did he shirk the responsibility thus at hand. After all, ancient or modern, there is always a best way to meet every situation, always an opportunity to make the obstacle less retarding to progress than otherwise it would have been.

The Bull is pictured full tilt, as if enraged and pitching down upon the hero from the sky; who looks up to meet the impact of its charge undaunted, and with club well poised to deliver its most effective blow. As belonging to the earthy-earthly sign, the Bull itself most appropriately typifies the crowding strength of the material environment with which we all must struggle and win if we are not to die.

But in its headlong plunge from the regions of above it also conveys the significance of those forces, invisible but potent, which assail man from the sky; the energies from planets and zodiacal signs, which, though more subtle in their attack, have even more power to shape and mold the destiny of man.

Environmental forces, those from the stars and those from the earth, are ever present, and their impacts call for well considered resistance. We can not escape them, as the timid hare seems to seek to do as it scampers from beneath Orion's feet. When problems are present, which every day they are, be they large or be they small, their issues must be met. And for each such problem there is always a best of all possible ways in which to meet it.

This applies to all of them; and that they should be met with courage and full confidence, as Orion meets the rushing Bull. No situation of life should cause the soul to quail. Whatever physical disaster may come, whatever distasteful thing may be uncovered in the recesses of the unconscious mind, it is always better to face it squarely, to recognize it for what it is, and then to formulate plans by which the situation may best be met.

Those who form the patients of psychiatrists more frequently than not have refused to face something in themselves, or have refused to face some situation of their lives. Freudian literature is filled with cases of illness due to unwillingness to recognize certain facts of people about themselves. And even more serious is the effect of refusal to meet some crisis in the life; for when a condition is present which can not be faced, the mind turns back upon itself, invents unconscious lies to explain behavior, and if the case is extreme enough in its unwillingness, there develops dementia praecox, one of the most prevalent forms of insanity.

We must face the problems of life firmly. And among those problems is that of meeting the impacts from the stars.

The only possible way that the planets in their courses can exert an influence on the life of man is through imparting energy to him. Whether spiritual, mental or physical, whenever work is done, whenever action results, there is always a proportional expenditure of energy. Without consuming energy nothing is accomplished.

Within the body of man at his birth are lines of tenuous substance that act as aerials do on a radio receiving set. And after birth, in response to the progress of the planets, other lines temporarily form that have a similar function. It is these stellar aerials, mapped by aspects, which pick up the energy of the planets, load it with harmony or discordant static, and convey it to the thought-cells of which the finer body is composed. They transmit to man, at times which can previously be ascertained, those forces from above symbolized by the downward pitching Bull.

Man is influenced by heat and cold and wind and rain and sun and innumerable other conditions that comprise his ever-changing environment. But his reaction to the impact of these physical conditions is largely within his own control. He can not change the weather, but he can prepare to meet it, or if favorable, to take advantage of what it has to offer. Neither can he change the motion of the planets in the sky, but he can change his own character, and in so doing receive energies more to his liking.

The permanent lines which extend across his finer body, and act as aerials to gather the programs from the planets, are expressions of his character, expressions of the harmonies and discords that have been organized within himself. And if he changes these, so also will he change the aerials within his finer form, or even construct others not present at birth, which tune in spontaneously to the energy broadcasts of his seeking.

The temporary lines which form in response to the progress of the planets pick up energy corresponding to the rates to which they are attuned. But the harmony or discord of the energy thus acquired may be vastly modified, so that it has a beneficial influence when it reaches the thought-cells.

Not only so, but the dial of man's own consciousness can be turned, if he used the resolution of Orion or King Arthur, to make an even more potent radio receiving set of his whole nervous system. He can tune in on the planetary rate desired so completely and persistently that other programs coming from above reach him very little.

Here we see the wisdom of King Arthur. To prevent a recurrence of the discord occasioned by each knight desiring the preferential place, he called to him the most cunning artificers of the land and instructed them to make a round table that would revolve, at which all the knights could sit, and each could thus consider himself at its head.

In the region where fabled Arthur is said to have reigned are still found today cromlechs, concentric circles of stone erected in prehistoric days to portray the orbits of the planets. And in that land, as also among the Maya of Yucatan, the people array

themselves in shirts of white on the first day of May, to dance in circles about the symbol of the Sun, the upright Maypole.

The weaving in and out of the dancers, as they hold ribbon strands reaching to the central post, cause these to form, one with another, sextiles and trines, squares and oppositions, and the other aspects by which astrologers ancient and modern plot the harmony or discord reaching the earth from various parts of heaven.

On that day the Sun has just entered the **Struggle**-decanate of Taurus, so-called because the life of those born from **May 1 to May 11** is so seldom free from obstacles that must be overcome. It is the decanate pictured by Orion.

We can not doubt, therefore, that the problem of settling the conflict between his knights, with which King Arthur was confronted, was the same problem which confronts each individual at this day; the problem of avoiding the strife of influences coming from the planets as they sit in their seats among the twelve signs, and of winning their harmonious allegiance.

And he solved it as it must be solved today, by devising a method by which the dial of consciousness can be so revolved that any planet in its seat can be considered at the head, can be given temporary prominence, and thus enlisted fully in support of the most cherished endeavor. Thus is derived the text: **The Task of the Soul on Every Plane of Manifestation is to Struggle With and Overcome the Limitations of Its Environment.**

The Mantle of Elijah

—Not always are we so fortunate as to have preserved to us, in the stories handed down from remote antiquity which serve as commentaries on the pictographic teachings of the constellations, both the danger to be avoided and the end to be sought. But these are amply set forth in the dramas associated with Auriga, the heavenly charioteer.

Orion, picturing the previous decanate, is shown using the solar fire of the Sun, even as the Maypole about which the dancers revolve reveals its source, as a shield of courage in his battle with the onslaughts of his environment. The lion's skin upon his arm gives him a resistance hard to crumble.

It is quite to be expected, therefore, that the last decanate of Taurus, through which the Sun sheds his influence from **May 11 to May 21**, should offer further comment on the Bull and on the use of the celestial fire.

It was the duty of Phoebus, according to the Greek account, each day to drive the chariot of the Sun across the heavens. Phoebus had a son, named Phaethon arrogant with the inexperience of youth, who begged his father constantly to be allowed to drive the prancing steeds. For a long time the father was adamant in his refusal; but at last in a moment of paternal weakness he gave permission to the boy, for one day, to do his work.

But the horses were too hard to hold; they were beyond the strength of the untrained youth, took the bit in their teeth and veered from the accustomed course. To make matters worse, having left the beaten road, they neared the den of the vicious Scorpion, pictured across the zodiac. With upraised tail he struck, burying his sting in a horse's flank. Then they completely ran away.

It had been a sorry day, indeed, on earth, if Jove, from high on his Olympian throne, had not glanced that way. The frightened horses went tearing toward the earth, the heat drying up the lakes and scorching the plains. Something had to be done if the world was not to be consumed in flames. Jove hurled a thunderbolt from where he sat, and as a bird is shot when on the wing, Phaethon was dropped into the adjacent Po, the stream now called Eridanus.

Dangerous, indeed, it is to develop forces which get beyond control. Many methods there are by which energies can be set in motion. Oriental breathing systems which have this for object gain such results. The etheric energies of the body may be increased until they surge in frenzy against the bit. But unless controlling skill is developed at an equal pace there is no proper guiding them.

Thus also is the kundalini power of Oriental fame a source of potential energy; but those who thus incautiously approach the Scorpion's lair more frequently than not receive the venom of its sting.

The bit and reins which Auriga holds in his strong right hand speak in no uncertain terms of careful guidance. Mastership, which is the Keyword of the section of the sky thus pictured, is the very opposite of irresponsible mediumship.

When forces from the invisible realm, whatever may be their pretensions, invade the physical organism of man and take charge of his mental processes, to the extent this is true, is he in danger of the fate of Phaethon.

To invite the control of any intelligence other than one's own, from this plane or from any other, is to play the part of the self-assured son who begged to drive the chariot of his father. When such steeds gather headway, and realize the hand that holds the reins is too weak for their restraint, no one can tell where they will go, or what the result will be.

One rule always holds, whether it be applied to driving a car on a crowded street, to developing the vital etheric flow of life, or to the use of the psychic senses; energy and speed must never exceed the power that guides and directs them. If, therefore, new sources of energy are tapped, a habit-system of more effective control must be inaugurated at an equal pace.

In the time of Elijah a Phaethon-like drought had taken hold on the land. As Ishtar in the long ago had cursed the Sumerian Gilgamesh, so Jezebel had likewise sworn to take the life of the Bible prophet.

The third-decanate of the second sign is pictured by the charioteer. It is the decanate of Mastership; and mastership implies control of the solar fire and a willingness to

sacrifice material things, as symbolized by the Bull, for the benefit of others.

The test as to his possession of these qualities came to Elijah during the great drought as related in the eighteenth chapter of First Kings. As at all times, not excepting the present day, there were then many men who claimed to knowledge and power which they did not have. False prophets, they were, like the swarm of charlatans who now prey upon the credulity of the public.

And even as at the present time, when one appeared who was truly a Master of his subject, the envy and malice of those who found an easy living in their pretensions, was directed against him, and against his teachings. So, therefore, did the four hundred and fifty spurious prophets array themselves against Elijah, and worked to turn the tide of public sentiment against his doctrines.

But Elijah called for a test of their teachings; he called upon them to make a sacrifice of their material wealth, to draw the fire from heaven and consume the Bull upon the altar of the common good. But although they shouted until hoarse, leaped upon the altar in dramatic gestures, and prophesied through all the day until evening, nothing of consequence happened.

Then Elijah built an altar of twelve stones, after the manner of the ancient cromlechs, one stone for each tribe and zodiacal sign. Round about it, as the magical decanate of Taurus is associated with planting in the ground, he made a trench as great as would contain two measures of seeds. Such seeds, even as material things germinate spiritual powers when used with intelligent compassion, require moisture if they are to grow: therefore, were twelve barrels of water, one for each type of crop to come, poured over the altar, filling the trench.

When all was in readiness he called down the celestial fire which consumed the sacrifice, the wood the stones, the dust, and even licked up the water in the trench, as emotional energy is always consumed in any physical demonstration of mental power. Thus did Elijah show his skill; but it was the final result that demonstrated him a Master. The drought was broken, and shortly there was the sound of abundant rain.

True Mastership is never shown merely through the exercise of ability, however unusual it may be. Auriga in the heavens holds the bridle reins in his strong right hand, to indicate ability to control and guide the forces of nature. But this alone does not constitute Mastership. With his other hand he holds and protects a mother goat and her young. He possesses ability to harness the fire divine, but he sacrifices this power by which selfish possessions might be gained, in aiding those in dire distress. Even thus did Elijah use his skill for the benefit of a stricken land.

Whenever, as frequently, is brought to my attention the marvelous feats which are reported from far-off places—the walking on red-hot coals, long interment beneath the ground, knives and nails piercing the flesh without the flow of blood, and other wondrous things galore by way of contrast I always think of Elijah. Especially, as is usually the case, when excuses are made for these wonder-mongers in their customary failure to help the condition of the miserable population around them.

I often wonder what Elijah would have said had someone remonstrated with him over the self-perpetuating handful of meal and cruse of oil, telling him that thus to interfere with the karma of the widow was to commit a sin.

It was during the time of drought, and before the episode of the trial of strength with the charlatans, who after the manner of certain wonder-workers of the East today, cried loudly and cut themselves with knives to induce the emotional frenzy necessary to their work. Elijah gave assurance to the starving woman that she should not want for food until the drought was ended.

Had the wonder-workers of his time been told of this help to the widow, or the bringing back to life of her son, no doubt they would have said that such procedure was contrary to divine law. For ever thus do those whose claims to spiritual power are unjustified, make excuses for their lack of alleviating action. Yet the Key-phrase for the Capricorn sign is, I Use; for the goat there pictured, or on Auriga's arm, is noteworthy for utilizing everything at hand for food.

Unusual power is no token of spiritual attainment. Those who have such power and use it only for self-aggrandizement have failed to make the sacrifice demanded of the one who followed in the steps of the great prophet.

Elisha was ploughing with twelve yoke of oxen before him, he being with the twelfth, or Taurus, when Elijah cast him his mantle. Whereupon he slew the oxen, boiled their flesh, and gave unto the people, and they did eat. Also for their benefit he devoted his other possessions. Thus did he demonstrate, before he was permitted to minister unto his teacher, that he understood the necessity of using whatever powers he should acquire for the benefit of the needy.

Phaethon, in the story from the Greeks, failing to control the power he sought to master, was hurled stricken into the river. But Elijah, striking with his mantle, walked to the other side dry shod. And when Elijah went heavenward in a chariot of fire, the power he once had used went to his disciple, whose immediate healing of waters to help a city in distress indicated his worthiness to wear the mantle. Thus the text is apparent: **The Function of a Master is to Control the Forces of Nature and Use Them for the Protection of the Weak and the Benefit of All.**

Chapter 4

Serial No. 74
Original Copyright 1935
Elbert Benjamine

Copyright
Church of Light
August 2002

The Story of the Three Bears

Chapter 4

Story of the Three Bears

Damon and Pythias

—It was held in ancient times that the Twins were the builders of cities and the founders of empires. Picturing the section of the zodiac related in a natural birth-chart to brethren, thought and travel, and ruling the hands and arms of human anatomy, the stories about them show skill in the use of tools, dexterity in war, and often relate to travel.

In Peru they were believed to have built the first city, the symbol for them there being a pile of brick; and Rome is held to have been founded by Romulus, after his twin brother, Remus, had been slain in a quarrel over building a wall. They had reached the site of the future metropolis as infants, drifting down the river in a boat which there found lodgement in the marshes.

The Romans thus regarded the heavenly Twins as exerting a special power of protection over them. Because they relate to travel they were frequently pictured with steeds, and Grecian temples thus retain them, riding side by side, armed with spears, on snow-white horses. The Romans, adopting the idea, struck a coin in their honor. The pence of the Good Samaritan was such a silver piece, on which the two horsemen were shown.

This protecting power of thought and skill was honored so greatly in the time of Imperial Rome that it entered into the customary oath. On our witness stands the Bible, as the sacred word of God, is considered the emblem of that high power which none should dare defy; but in olden Rome the solemn token of the sacred power by which they swore was Gemini. Passing to a less reverential generation, By Gemini, which to us is, By Jiminy, became a by-word of the street.

Six hundred years after the devotion displayed to David by Jonathan, and three hundred years after the founding by one Twin of Rome, lived Dionysius, the tyrant of Syracuse. The Pythagorean sect then flourished, and to those who joined its ranks, revealed the teachings of the still more ancient Stellar Wisdom.

Damon and Pythias were such followers of the great Samoan sage, developing their spiritual powers and learning about numbers and the stars from the same ordained instructor. Thrown constantly together in the school, a strong attachment formed between them, and their friendship grew as the horizon of their knowledge widened. The bond of religious brotherhood was strengthened by personal admiration.

Then Pythias, through some political indiscretion, came under the disapproval of the monarch and was condemned to die. He was a man of varied interests, and financial matters, due to his absorption in his studies, were rather at loose ends. Thoughtful of others, who might be left destitute by his sudden passing, and of debts that rightfully should be paid, he begged the tyrant liberty long enough to set right these various affairs.

Quite naturally, the one who had condemned him to death wanted to know what assurance could be given, if he were allowed temporary freedom, that he would come back, and be present on the day of execution. Whereupon friend Damon stepped forward, pledging himself, standing ready to be slain if Pythias failed thus to return. In this manner, therefore, was the matter settled.

Damon was kept under closest guard, and as the day approached, speculation ran high whether Pythias should die or Damon. Some thought the teachings of the initiates in the school to which they both belonged had so imbued the friends with a sense of honor that, even though his life be forfeit, Pythias surely must return. Others, more numerous and more highly vocal, expressed their belief, and backed it with a wager, that he had made good his escape, having fled to some foreign land.

On the death-day excitement ran high and a huge crowd gathered. Damon seemed the least concerned of all. And sure enough, as the time for the fateful ceremony drew near, here came Pythias striding through the gathering, to take his place before the executioner, true to his word and true to his friend.

So impressed was Dionysius with this loyalty of friend to friend, and with teachings which gave so high a sense of honor, that not only did he free Pythias, and spare his life, but he also asked to be admitted as a member of the Pythagorean order.

No less dramatic, and also concerned with the absence of one, is the Greek story of Castor and Pollux, after whom the heavenly Twins are now named.

They fell in love with the daughters of Leucippus. But as these maidens already were betrothed to the sons of Aphareus, resentment was expressed by these earlier suitors toward the Twins. At last the rivalry ran so high that insult was passed, resulting in a challenge to battle. In the course of the ensuing fight Castor was slain.

So great was the attachment of Pollux for his brother that he walked up and down the earth, disconsolate and filled with sadness. Interest in life had departed, and he longed to die, but this he could not do, for unlike the absent brother, he was immortal.

Jove, from his Olympian heights, perceiving the vast distress in the heart of the surviving Twin, took pity and permitted Castor to share his brother's immortality.

Yet in granting this favor he made the stipulation that but one of the two could be on earth at a time, the other remaining meanwhile confined in Pluto's dark realm.

The mind of man, after the manner thus described, is acknowledged to be two, the objective and the unconscious, linked inseparably so long as earthly life shall last. The objective mind being dependent upon the physical brain for expression, is, like Castor, subject to the forces of death. But the unconscious mind, persisting in the astral realms after the dissolution of the physical, like Pollux, is, in truth, immortal.

The conscious, or objective mind, embraces those states of consciousness, thought, feeling, and visual images, which, through the etheric energies that connect the four-dimensional and the three-dimensional form, impress themselves strongly on the physical brain. Castor is mortal, because when the physical brain ceases to function he exists no more.

Yet when Castor is on earth, when the objective mind is active as in the fully waking state, the unconscious mind, Pollux, is below the threshold of consciousness, unable to express except imperfectly on the physical plane. He is chained in the realm of invisible forces, in Pluto's dark domain.

But when Castor finishes his daily sojourn, and departs through the processes of sleep, himself to enter the realm of darkness, it is then that Pollux holds full sway. In dreams the unconscious mind finds experiences such as it desires, visits the halls of learning, and weaves a pattern of fantasy which, more frequently than not, is all the memory it brings back to relieve the monotony of the waking state.

Jonathan and David were like Castor and Pollux in the eternal bond of their affection. And just as David was wont to soothe the troubled spirit of King Saul by playing on a harp, so is that harp still pictured, as anciently, held by a heavenly Twin.

When Saul sought the life of David, it was Jonathan, who loved David as his own soul, who saw to it that he escaped. He made a point of reporting to him every whim and purpose of his father; and on one occasion when the peril was most high, he devised a means by arrows, that David should be enlightened that danger threatened.

A place was appointed where David should come in hiding to receive the signal agreed upon. A bow and arrow are still to be seen clasped in a Twin's hand, and the robe is there also which was given to David. Three arrows were to be shot, as if Jonathan were practicing at a mark. If he spoke to the boy with him saying, as he started to retrieve the shots, that the arrows were this side of him, David was to know that he was safe. But if he said, as he was compelled to do, that the arrows were farther on, it should be a signal for David to depart in haste.

On still another occasion it was his wife, Michal, who saved David from the wrath of her father. This was accomplished by using a pillow of goat hair, and covering it with cloth, as if it were David prostrated with a fatal illness. The bed was brought to Saul at his command, with expectation that he would hasten the demise, but the one he thus sought to destroy had meantime effected his escape.

Thus again was the goat employed, as so often is the case, to symbolize the power of use. David possessed ability, and after the manner of the adjoining decanate of Taurus, in which a goat and her kids are pictured in association with the Master, Elijah, it is made plain that his powers were not being employed for selfishness, but for the good of the nation.

So long as David worked constructively, so long as his thoughts were directed to the accomplishment of some good end, he was helped by those nearest to him. And to the extent that any other person is able to live a completely constructive life, will he also receive the maximum benefit from his environment.

Nor is the harp pictured with the heavenly Twins without great significance; for to the extent thoughts are joined harmoniously, as were joined Damon and Pythias, Castor and Pollux, David and Jonathan, do they enter into beneficial compounds. Thoughts that are born at the same time, that arc presented to the consciousness in association, become linked together in such a manner that they present a united action. The thought-cell so formed works from the four-dimensional plane, with such energy as it possesses, to attract events relating to it into the life. To the extent there are discords present it attracts misfortune, but to the extent there is that harmony which the harp symbolizes, does it work to attract events which are fortunate into the life.

The Key-phrase for that section of the zodiac where the Sun is from **May 21 to June 22** is, **I Think**. The text, therefore, is: **Thoughts Are Man's Most Potent Builders**.

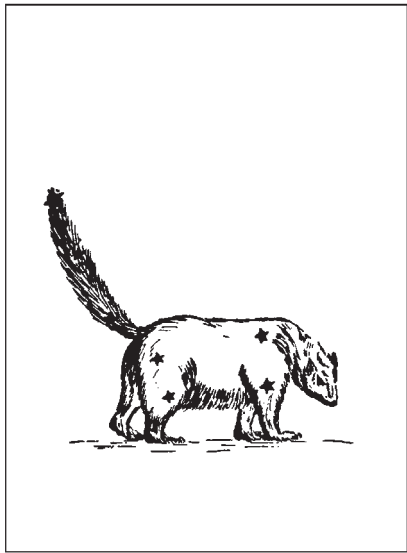

Ursa Minor III Intuition

Figure 4-1

First Decanate of Gemini

The Wee Small Bear Whose Porridge Was Just Right

—Way to the north, where they may be seen circling close to the celestial pole, is the constellation of the Big Bear and the constellation of the Little Bear. A Middle Sized Bear is not shown; for the middle decanate of Gemini, instead, is pictured far to the south as a good sized dog.

Not only are we led to expect, because Gemini is the natural ruler of thought, that the constellations picturing its decanates shall relate to mental processes, but the stories of David and Jonathan, Damon and Pythias, Castor and Pollux quite prepare us to recognize in the bears a further elaboration of teachings relating to the two types of consciousness.

Bears, in addition to unconquerable restlessness, and their habit, like mind, of devouring everything presented that has possibilities as food, have unusual feet. They are plantigrade, as is man, walking not upon their toes as most beasts do, but upon the soles of their feet. The feet of a bear are mentioned in Revelation; and in Second Samuel, 17, it speaks of men that are chafed in their minds as a bear robbed of her whelps in the field; indicating recognition of this largeness of understanding and restlessness which associates the bear symbolically with types of mental activity.

Taking the two bears to signify objective thought, which in its latest development becomes reason, and unconscious thought, which in lower forms gives rise to instinct and in man to intuition, next must be decided which bear relates to the latest form of thinking. If we follow the simple system employed by the wise ones of old in their starry portrayals as similarly we followed it in learning the order of pictorial succession, we are led to conclude that the mental activity which first developed is that which also appears first in the constellated pictures.

The Little Bear, exemplifying that section of the Sun's warm path from **May 21 to May 31**, coming first, reveals something of import regarding the unconscious mind. Just what that something is, let us try to learn from legendary stories about the little bear.

Some American Indians recognize the constellation as a Dipper and some as a Bear. Because of its form, just as Whites do, they often refer to it as the Little Dipper. But in general throughout the world the Pole Star, at the tip of small bruin's tail, is given a place of special honor.

One legend of wide diffusion among the American tribes is that once a hunting party of Indians lost its way and its members were in grave doubt as to the direction to go to reach their home. It was such a serious matter that they very earnestly prayed the Great Spirit to give them proper guidance. No sooner had the prayer been finished than a little child appeared in their midst and proclaimed itself the spirit of the Pole Star.

Following it, as plainsmen and woodsmen commonly at night look to the Pole Star to give them direction, they were guided safely to their home; and ever since that time Indians have recognized the orb, whose spirit is like an innocent child, as the star which never moves. When they died the huntsmen who were thus guided were carried up to heaven where yet they may be seen as the stars of the Little Dipper constellation.

Now that which is ever the same, changing not, but immovable, and which like the Pole Star is the best of all guides, is Truth. It is the Rock of Ages, upon which any lasting church must have foundation; the rock which the Psalms proclaim is higher than I. Thus to the Greeks was the Pole Star known as Mount Olympus, the abode of the gods; a mountain so high that birds could not fly to the top of it, nor clouds collect upon its summit. Truth is never cloudy, nor can the thoughts of men ever soar to its utmost height.

The Big Bear in the sky, by means of its pointers, indicates the way to Truth, but the tail of the Little Bear actually touches it. As the Pole Star is reached by the Little Bear's tail, so are there faculties of the Unconscious Mind by which Truth can directly be apprehended.

The Objective Mind, with its mature powers of Reason, is a long way removed from the infantile stage. Not only is it full grown, but also sophisticated and often ruthless. Suggestions offered it are met with skepticism. But the Unconscious Mind, as dream life reveals, is not so critical. That which Reason, when it is brought to bear, calls impossible, takes place in the fantasy of dreams. For that matter, it also takes place in the reality of the four-dimensional realm, where the restrictions imposed by three-dimensions no longer hold.

This naiveté with which the Unconscious Mind accepts conditions that the Conscious Mind rejects as illogical leads to associating it symbolically with a little bear or a little child. As the Indian legend indicates, so the Bible also asserts, that the kingdom of God must be received as a little child. There is a faculty of the unconscious mind which feels assured when things are right.

Thus did little Goldilocks, in the nursery tale told over much of the globe, always find the possessions of the Little Bear just to her liking. The Things which belonged to the Great Big Bear were too coarse and rough for her; and those of the Middle Sized Bear were also uncomfortable; but the Little Bear's were just right.

You doubtless remember Goldilocks, the little girl who lived near a forest covered mountain, like Mount Olympus, and often went for a walk in the woods.

One bright and sunny morning she had gone farther than usual, picking the pretty flowers, when she came to a house, and as the door was unlocked she entered; much as we enter the physical world. But this was the house of the three bears. We call them Reason, Impulse and Intuition.

The bears were out for a stroll in the woods, while the porridge which Mother Bear had made— and what a porridge Impulse often makes of life— had been left, already poured in bowls, on the table to cool. So as Goldilocks was hungry she sampled the food. The great huge bowl of porridge was too hot, the middle sized bowl of porridge was too cold, but when she tried the little wee bowl of porridge, it, like the Intuitional appraisal of life's experiences, was neither too hot nor too cold, but just right.

After eating her fill she tried the chairs. The great big chair was too high for her, and the middle sized chair was too low, but the little wee chair was neither too high nor

too low, but just right. These were not immobile chairs. They were such as typify action; for Goldilocks rocked and rocked until the little chair broke all to pieces, as in the end man's body always does.

Then she went upstairs where there were beds; beds that symbolize rest to the body after the assimilation of grueling experience and the destruction of physical tissues through the monotonous rhythm of the daily toil. The great huge bed of Reason was too high for her; for the reasoning process is a foe to sleep. And the middle sized bed of Impulse was too hard; she would have tossed and turned if she had attempted to rest there. But the wee little bed was just right- for the Unconscious Mind has full charge in slumber and Intuition can then impress its guidance through the avenue of dreams.



Canis Major ♀-♂ *Fidelity*

Figure 4-2

Second Decanate of Gemini

Such impressions are more easily recognized in the moment of waking. Of course, Intuition often is active at the very moment some situation is presented, giving instant appraisal of its possibilities and its outcome. But more often than not the Great Huge Bear of Reason so intrudes its ungainly force that the wee small voice of Intuition can not then be heard. But if listened for, it can be heard readily in that transition state between sleep and waking.

When the three bears came home it was the Little Bear that discovered Goldilocks in his bed, and spoke in a wee small voice. Whereupon—just as Reason and Impulse rush in when one starts to awaken—the two larger bears rushed over to the bed, making so much noise that they frightened Goldilocks, and she jumped out the window and ran safely home, despite the Little Bear calling to her to come back and play with him.

No time is quite so easy, as a rule, to hear the voice of Intuition as in this transition from the sleeping to the waking state; but its promptings must be carefully listened for and noted before thoughts begin to clamor in the mind.

It is because Reason and Impulse so often intrude and create a clamor that the promptings of the unconscious mind should be subjected to whatever method may be available to check their accuracy. Like the Little Bear's tail, **Intuition**, which is the Key-word for the decanate this animal pictures, is in constant touch with the Pole Star. Truth. But its voice is easily deflected and is often misunderstood through the crowding influences of other forms of thought.

Not that the unconscious mind is able to apprehend all there is to know; but, because it draws information from the reports of both the physical senses and the four-dimensional senses, having access to both realms, its possibilities of acquiring information are vast. In the astral realm the process of tuning in on the knowledge desired makes the more laborious methods of earth quite unnecessary.

When the unconscious mind realizes what is expected of it, it will endeavor to meet the expectations, traveling in sleep, using the faculties of clairvoyance and clairaudience, and the tuning in process to acquire information.

Yet after it has collected facts from both the outer and the inner plane, and from them has formed correct conclusions, there is still the more difficult problem of getting recognition from the objective consciousness. Only through training can its voice be heard. Yet the text is clear: **Only Through the Intuition Does Man Contact the Real Underlying Truth of Things.**

Why a Mad Dog Shuns the Water

—The marriage-decanate of Gemini, so called because it has a sub-influence ruled by Libra, the marriage sign, is pictured by a dog. This dog is not fat and plump. Thought, to which the sign as a whole relates, is swift, therefore, this dog is long of leg and speedy, like a hound.

Character is the real man, the whole man, and represents a fusion, or marriage, between the unconscious mind and the objective mind, whose powerful activities are portrayed by the bears. And because character is the truly important thing, in placing its pictographic symbol in the sky it might be expected that the ancients would use in its portrayal the most conspicuous of all the stars. Sirius, the star in the mouth of the greater dog, is the most brilliant star in the whole expanse of sky.

Joining, as it does, the Reason section of the zodiac with that section relating to Intuition, one can not help but wonder how much the ancients knew regarding it, how much was coincidence, and how much was an intuitive recognition of the real nature of the Dog Star, Sirius.

The star, like thought and like the hound, has a rapid proper motion. That is, relative to other stars it is moving at tremendous speed. And it is not one star, as to the naked eye it appears, but Twin stars, united, or married, by the mutual pull of gravity, and thus revolving around a common center; bound together by a tie as inseparable as that which held Castor and Pollux.

But more amazing still, the companion star, the smaller of the two, has a density incomparable to anything known on earth. Forty thousand times as dense as water, more than a thousand times as heavy as platinum, an amount of it such as might be placed in the pocket of a boy weighs not less than a ton.

Like planets revolving around the Sun, and with space between as large in proportion, the electrons of all atoms of matter revolve around the nucleus at the atom's center. And it is supposed that the pull of the nucleus at the center of the atoms on the companion star of Sirius, under conditions which are not understood, became so great that the atoms collapsed. The positive and negative charges entered into a still closer embrace to form a type of substance that no longer can be considered

atomic; a substance having a distinctly different character to anything existing on the earth.

Very much as electrons and protons, united in a miniature solar system, are part and parcel of every atom of matter, so while man functions through a physical body the conscious and unconscious minds unite to contribute to his character.

As the dog is an animal which frequently gives warning of danger, like the voice of conscience protesting against the trespass of wicked deeds, and as both reason and intuition unite to apprise of other peril, so the Dog Star in ancient Egypt gave warning of the flooding of the Nile.

In the spring of the year this brightest of stars is visible just after sunset. But each evening it sets about four minutes earlier, so that as the season advances it is closer and closer to the Sun, until there comes a time when it is so close to the orb of day that it can no longer be seen. Then some fine morning, to anyone ambitious enough to be up, it may be seen as a morning star, heralding the approach of the rising Sun.

This first visible appearance of Sirius before the Sun was of great importance to the Egyptians because it timed the yearly approach of an event which to them meant life or death. They were an agricultural race, dependent upon the harvest for sustenance. That harvest, in turn, depended upon the flooding of the Nile.

The raising of crops, year after year, on the same piece of soil is made possible only when the elements removed are in some manner replaced. It is customary for men to spend time and money thus to prevent the wearing out of their ground. But in Egypt, each year, the Nile did this for them, overflowing its banks, depositing a thin layer of rich new silt, and in addition giving the farms a very necessary soaking.

Egypt was dependent for her life upon this flooding of the Nile. The civilization which persisted for thousands of years was made possible by it. Is it any wonder then, that the brilliant star which heralded this event should have received unusual homage!

Its first visible appearance before the Sun marked the commencement of their year. It was the first of the month of Thoth (Mercury). Were this not known historians would have a sorry time with ancient chronology. It serves them as the reference point from which to calculate the past.

There was a vague year of 365 days and a sothic year of 365 1/4 days. The coincidence of the two calendars after 1461 vague years or 1460 sothic years gave them a Sothic period. And it is on record, fortunately, that one such Sothic period commenced on the first day of Thoth, in AD 139.

Each year it was the custom, on this first day of the month of Thoth, for the Pharaoh or one of his sons to go early to the temple. Then, just as Sirius came into view, and its rays shone through the temple and fell directly upon the shrine, to make an offering of papyrus and of lotus flowers. This officially commenced a festival which the populace celebrated with fervor and pageants of splendor.

When Sirius thus rose ahead of the Sun, Etesian winds were piling moisture from the Mediterranean against the interior mountains, and soon the resulting rains would bring inundation. It was time, so the dog in the sky warned them, for farmers to move their household goods to higher ground until the flood had passed and it was safe for them again.

Thus the constellated dog may be seen keeping a watchful eye on the rising river. And although, due to the precession of the equinoxes, the time of this event is now earlier in the year, when the Greeks and Romans first contacted the Egyptians, the first visible rising of Sirius before the Sun commenced the close sultry days of summer, which because of this were called dog days, and are still so termed in many parts of the world.

Canis Major is a friendly dog with his master's welfare dominant in his heart. Ever faithful to the trust imposed in him he willingly risks his life in the protection of his human friends. The Sun is in the **Fidelity** decanate he pictures from **June 1 to June 12**.

As man looks up to God in service and devotion so does the faithful dog look up to man. No other animal habitually displays these qualities which in their fuller bloom become the flowers of religion and altruistic action.

As pictured in the sky he is not fleeing in terror from the rising water. He is merely warning that temporarily it is better to repair to higher ground. The soil can bring forth its fruit only when it thus has been moistened; and the earthly life of man acquires a healthy harvest only when the finer, kinder qualities of affection have softened its hard, dry selfishness.

The great dog in the sky portrays the character of man, which warns him when the emotional tide runs high enough to bring him peril; and leads him back again to moist and fertile ground when there is safety.

But when he develops fear of water, when the character no longer is swayed by the softer, kinder sentiments, he, himself, becomes a greater peril. To turn loose the dogs of war, was a customary expression in the days of ancient Rome. And when the character of a people develop madness, as a dog develops rabies, it seeks to find expression in acts of military aggression.

Hydrophobia means to have a fear of water, and those engaged in war must of necessity shun contact with those finer, kinder emotions which give quality to the soul and build for it an enduring spiritual body, such as symbolized by the stellar river. Instead there is the cruelty and wanton destruction so well expressed by the mad dog which tradition says thus shuns the water.

This is the worst of the whole affair, that one nation in the world affected with this military madness endangers every other nation. As a dog with the rabies bites right and left with no discrimination, so one jingo nation infects the others. None can disregard the threat of its armament. And each thus infected country, strengthening

its powers of destruction, becomes a source from which the malady spreads to others who are fearful of its possible aggression.

And so, from one country to another, does the disease move forward. Nor apparently is there any prevention of the spread of this dread madness except through the restraint of the nation where it develops, suppressing it at its source.

Still another form occurs within a nation. Reasonable hours of labor, reasonable wages, and kindly working conditions for those employed are the dictates of proper character and in the interest of the universal good. But one firm developing the cruel traits of competitive madness, lowering wages, lengthening hours, making living conditions impossible as one nation infects another with vast expenditure for armament—compels other firms in the same business to develop like methods to prevent being bankrupt.

Mad dogs of industry and mad dogs of military aggression must be restrained for the protection of all, themselves included. But such madness primarily is that of character. There is no real benefit to the individual that can be purchased at the expense of the universal good. It is a sign of hydrophobia when, within the law or without it, the attempt is made to racketeer.

The good of any man resides in his character, and his character is sound only so long as it has due regard and sympathy for the interests of others. The text therefore may be expressed in the words of the bard of Avon: **“This Above All; To Thine Own Self Be True; And It Must Follow As the Night the Day, Thou Canst Not Then Be False to Any Man.”**

When the Giants Made an Assault on Heaven

—In the long ago there was a race of giants whom the Greeks called Titans. They were very powerful and became arrogant with the knowledge of their strength. In this they were not unlike some scientists of the present day, who triumphant in their conquest of certain laws of matter, believe no information of importance, of a different nature, can lie beyond their ken.

So certain of themselves did these giants become that they decided to storm the gates of heaven and dethrone the gods who resided there. That is, like Soviet Russia at the present time, they deemed there was no power superior to the physical. Brute force and intellect seemed to them supreme, and in their atheism they sought to overthrow the very judgment seat of God.

Still further back in Bible times another race of men had kindred thoughts. The sign Gemini, the third decanate of which is pictured by a Giant Bear, relates to building, the Peruvian symbol for it being a pile of bricks. Such bricks were used, as described in Genesis 11, on Shinar’s plain to construct a city and a tower, whose top should reach to heaven.

The Sun while in this decanate of **Reason**, from **June 12 to June 22**, like the laid brick tower of Genesis, the barrows and pyramids of various lands, and the mountains which the Titans piled up in their invasion of the dwelling place of God, mounts higher and higher in the sky. Only at mid-day on the 22nd of June does it reach its highest, most northern, declination. This is the longest day of the year, the nearest approach of the earth to gaining perpetual light.

But the Sun, at the end of this giant decanate, ascends no higher. The Titans are defeated by the power of Jove, whose Sagittarian sign across the zodiac opposes to Intellect and Reason the mandates of true religion.

Gemini relates to thinking, but no less also to the expression of thought in speech. On Shinar's plain, therefore, the defeat of those who assaulted heaven with Babel's tower was accompanied by a confusion of tongues, and a scattering of forces, such as those born in this sign find often to defeat their ends. And the Titans, like scientists who pile up facts to refute the possibilities of an after life, to have other greater groups of facts piled over them, were buried under the very mountains they had erected; and their blood, as the essence of atheism always does, gave rise to a race of ruthless men.

It is not to be inferred from this defeat that Reason is without its proper use, or that the Titans had not a proper function. Reason should be used wherever possible to check the reports of the psychic senses and intuition. The two stars in the outer bowl of the dipper which mark the shoulder of the Giant Bear point directly to the pole star, Truth. Mariners and plainsmen and those who must find their way through the forest at night constantly use them to indicate the North Star which gives them true direction.

It was the assumption that objective consciousness and the reports of the physical senses which Reason commonly employs, were sufficient in themselves to acquire the whole of Truth that led the Titans to disaster. Reason, like the Pointers, only indicates the direction of Truth, which is really touched by the unconscious mind and the Intuition as symbolized in the Little Bear. Yet as affording a necessary means by which the accuracy of the findings of the other faculties regarding the inner world are tested, and when true their doctrines may be upheld, Reason has a fundamental work to do; for Atlas, one of the defeated Titans, henceforth was compelled to support the heavens on his head and hands.

This Atlas, one of the fabled giants associated with the larger bear, was the father of the Seven Sisters now translated to the Pleiades. Six of these well-known stars are plainly visible in the shoulder of the Bull; and keen eyes can see the seventh, and perhaps the eighth and ninth, Atlas and Pleione, father and mother of the famous girls.

Alcyone, Maia, Merope, Taygeta, Asterope and Cleaeno were quite proper in their conduct, and in due course of time, according to the conventional standards of their kind, were married to immortal gods and lived in respectability. But the seventh sister, Electra, was of a different turn, and had a disgraceful affair with a mortal lover.

So great was the shame her sisters felt for her that her light died out, leaving but six stars to be seen by common eyes.

Suffering from the disdain of these sisters, and still disconsolate over her lover who, being mortal, had died, she wandered far away and became lost in the cold region of the north. Thus did the Greeks identify the naked eye star, Alcor, in the constellated Great Bear as the Lost Pleiad, who previously had been Electra, and in addition to marrying a mere mortal had veiled her face at the burning of Troy which had been founded by her son.

The Seven Sisters, through their residence in the Bull of material possessions, indicate their attachment to physical things. But Electra went beyond mere desire for the tangible things of life and formed so intimate and persistent a longing for such things that it veiled the light of their transitory nature from her inner sight.

Like many another who has formed too strong a love for that which is mortal, she wandered in the region of cold intellect, and found her final abode in the lair of the icy giant, Reason.

She was like the soul who can not turn from the thoughts of earth to higher things, even at the time of mortal passing, and thus remains earthbound for a period after death.

It was at the period of the summer solstice, when the Sun has reached the end of the decanate pictured by the Giant Bear, that the Maya and the Aztecs built special fires atop their numerous pyramids. Symbolically, because the Sun was then nearer to them by declination, this represented the closest approach of the deific spirit to the earth. The day was easily ascertained; for it was the time when at noon a stake cast its shortest shadow.

This northmost position of the Sun on earth, because thus so simply found by watching a shadow, was the index more commonly employed to mark the precession of the equinoxes, and thus to indicate the time of vast changes on the earth, including cataclysm. That is, when the decanate pictured by the Great Bear, representing the Tower of Babel, moves to a point in opposition to the Pleiades, associated with the decanate pictured more completely by the frightened Hare, such changes are at hand.

At Uxmal, in Mexico, to indicate this relation between the solstice Sun and the northern constellation, seven pyramids were so arranged as to represent the seven bright stars of the Great Bear. The Mound Builders also had altar fires atop their piles of earth; and those who make a study of the origin of words report that such mounds in the British Isles, through "berw," the ancient name of bear, have now come to be known as barrows, after that animal, and that the Welsh name for hill, "bryn," is the original of the popular name, "bruin."

At least, when Ireland was converted to Christianity one of the most difficult tasks of the good Fathers was to abolish the ancient custom of lighting fires on the tops of towers, pinnacles and conical hills in honor of the Sun. The pyramidal temples of Bel (the Sun) scattered throughout the world relate to its solstitial position. A belfry is now a cupola in which a bell is suspended, was once a tower of refuge, and at an earlier date was derived from words having to do with Bel-fires, that is, places where fires were kindled in honor of the Sun.

A pyramid of soil or stone is a high point on the earth; and some of them, those more carefully constructed, were so built that the inclination of the northern side was in line with the solstice Sun, so that on the longest day at noon no shadow would be cast, but the Sun apparently would perch like a ball of fire on the summit, when viewed by those at the northern base. Thus on this day was spirit symbolically joined to matter.

The pyramid or tower, as the highest edifice of man's construction, well represented the apex of his physical attainment, the highest point reached by the objective mind. But such a physical structure in itself was limited in its function. It was like the legendary Atlas who failed in his attempt to storm the gates of heaven; but was given useful employment holding this celestial region on his head and hands.

This, I believe, quite accurately describes the function of physical life, the hardships of which compel the development of the power of Reason as an effective means of escaping painful penalties.

Pain is the warning that the organism is not fully successful in adapting itself to its surroundings. And to escape the pain, the organism struggles. When it is successful in making the proper adaptation, the pain ceases and pleasure is felt instead. Pleasure is the signal to an organism that difficulties have been overcome and that all is well.

Ants and bees readily sacrifice their lives for the good of their fellows, a dog will die for his master, and many mother animals will defend their young to the death. We can not, therefore, place man on a pinnacle due to his altruism. But in the exercise of intelligence, especially Reason, he is as high above other creatures of the earth as a pyramid or tower is above its surroundings.

Yet Reason does not perceive all. When we approach an object from one side we may see all that can be seen from that direction, but not all that may be seen from the other side. Reason and Intuition thus approach knowledge from different directions. While Intuition touches Truth, it does not get the view that Reason does, even though Reason only points in its direction.

Both the inside and the outside of things need to be known to possess complete knowledge. As for the Great Bear it indicates the text: **Reason Points the Way to Truth, and Offers a Valuable Means by Which the Accuracy of the Reports of the Psychic Senses Can be Tested.**

Chapter 5

Serial No. 75
Original Copyright 1935
Elbert Benjamine

Copyright
Church of Light
August 2002

The Ladder to Heaven

Chapter 5

The Ladder to Heaven

Angels That Go Up and Down

—Even at the present day, when arbitrary forms of speech long since have displaced the more primitive use of universal symbols, it is not uncommon to refer to the highest point as nearest heaven. The highest point in the zodiac, the place for which pyramids and mounds were erected, is the dividing line between Gemini and Cancer. Fires were lighted on these eminences to signify the Sun had reached its greatest elevation; that is, had reached the very gate of heaven.

If there is a special gate to heaven, to which in ancient times great homage was paid we moderns should not be ignorant of its nature. Peter, who is pictured in the sky as Cepheus with his foot upon the rock of Truth, the Pole Star, against which the gates of hell, at the opposite side of the zodiac, shall not prevail, is reputed to hold the keys to the kingdom of heaven, as related in Matthew, 16. But it were better for our purpose to go much further back; back to the dream of Jacob as described in the twenty-eighth chapter of Genesis.

The degrees of the zodiac are not unlike the rungs of a ladder which arches the sky, extending from earth to heaven. Jacob dreamed of such a ladder set up on the earth, and the top of it reached to heaven; and angels of God were ascending and descending on it. Thus do the Sun and the various planets move higher and higher in the sky until they reach the first of the sign Cancer and then start their descent to lower declination.

This sign Cancer, where the Sun may be found from **June 22 to July 23**, is the natural ruler of the home and family. Therefore, next in his dream he is told that his children will be many and that in them all the families of the earth will be blessed. But when he awoke he was frightened, saying, “this is none other but the house of God, and this is the gate of heaven.”

As angels more commonly are considered, instead of their going up to heaven from the earth, and the returning from that superior region, we should expect them to come down from heaven and after their visit on earth to return again to that higher plane. But in Jacob's dream they were going up, as the Sun ascends to reach the sign Cancer, and then coming back to earth, as the Sun again descends after it reaches that family sign.

This going up and coming down, which the Sun is observed to do each summer, evidently signified to those who traced the starry pictures in the sky and gave to each a story, a going up and coming down which was suggestive of the movement of those intelligences which have no physical form, and which, for want of a better term, may be called angels.

Although the place where a person commonly sleeps may be regarded as his home, the action of Jacob after awakening, of setting up a stone to be the house of God would be difficult to understand were it not that other contemporaneous peoples, in various parts of the world, were also accustomed to set up pillars, pyramids and towers to commemorate this nearest approach of the spiritual symbol, the Sun; which, in this position, marks the commencement of the home sign, Cancer.

It was the belief of the better informed of these people that the soul made progress by gaining experiences in one physical form; passing at its dissolution into the astral world, as Jacob saw the non-material beings do in his dream, and after a period of experience and assimilation in the astral world, descending, as Jacob saw them do, to occupy another, but more complex, physical body on the earth.

Every such form occupied constituted one rung in the soul's evolutionary ladder. It could be gained only through the offices of parents who provided it opportunity to have a new physical body.

Every physical cell, every germ or shoot which develops into bacterium, plant or animal is dependent upon parenthood for its existence. Without parenthood there could be no opportunity for evolutionary progress, no successive rungs which more complex life-forms provide, no avenue to reach the spiritual development which opens wide the Elysian gates. As the commencement of Cancer marks the highest declination of the Sun and the boundary of the place of home, so also, as signifying parenthood, it is in truth the very gate of heaven.

This coming back to earth, and the coming back of the Sun toward the earth in declination, needed some object to represent them in the sky. The Crab does not move directly forward, as other creatures are wont to do, but has a backward, sidewise gait. Its motion thus most fittingly represents the backward motion of the Sun.

Nor is it without significance that the preceding compartment in the zodiacal circle, which is touched by this gate of the above, is Gemini, the section ruling thought. As the Key-phrase to Cancer is, **I Feel**, we have quite appropriately, Thinking and

Feeling in immediate contact with the highest point of the celestial circle, and thus leading to the heavenly gate.

Thoughts enter into compounds which are harmonious or discordant according to the Feeling at the time they were brought together. If the feeling was that of discord, the thoughts so united tend to attract into the life the very opposite of heaven; they attract misfortune and distress. But if the feeling which accompanied their union was of a pleasant turn, to the extent such harmony was present do the thought-cells then composed, work to attract fortune and happiness into the life.

A similar process is at work with lower forms, in fact, wherever life exists such processes are at work; although the states of consciousness experienced can hardly be dignified by the name of thought. Yet life-forms on every plane, and in every stage of progress, have experiences which are registered in their finer forms as states of consciousness.

These states of consciousness, however lowly and simple they may be, constitute the experiences of that form. They are registered in the astral counterpart, and combine to form the psychoplasmic cells of that finer body; and these, in turn, determine the experiences which will be attracted to it.

Whether lowly or highly evolved, whether to a single cell of protoplasm or to an educated man, every experience that comes to a life-form adds just that much energy to its finer body. As a man, when hypnotized, or under psychoanalysis, can recall any experience or thought of his past, so the four-dimensional body of every organism is a complete record of all that has happened to it, and its mental and emotional reactions to these occurrences.

Thus it is that every form of life is moving forward toward the acquisition of such abilities as will fit it to perform the particular function in the cosmic scheme of affairs, that it has been called into differentiated existence to fulfill. It attracts to it, by virtue of its original polarity, the type of experiences that afford it the proper trend in education. It does not have just the same experiences that some other does; because it is not being educated to fill the same cosmic position.

Its experiences in one form of life, however, give its thought-cells, or unconscious mind, ability to handle certain situations. It learns how to gather together the material elements and build a certain kind of physical body. And then, when the body dies, as seen in Jacob's dream, it ascends to heaven; that is, passes to the astral spheres.

In this astral realm there are other opportunities for experience and progress. Life is never stationary; it is ever moving, always gaining new experiences, whatever may be the plane. These experiences, however, are of a different sort. They are four-dimensional experiences; experiences also of reorganizing what has been gained in the preceding physical body.

Then, when the vibratory conditions are right, the life-form which has continued its progress on the astral plane, is attracted again to earth, descends the ladder as in Jacob's dream, to enter another physical form; a physical form which is a step in advance, perhaps a long step in advance; due to its assimilation of previous experiences.

Successively, it ascends to the astral plane and then returns to earth, as the angels moved up and down; but each physical form, due to its acquired experiences, is a step in advance, and each ascent to the astral is a more conscious existence. Birth and death and birth again are the rungs of the ladder which lead man to his spiritual estate; and the gate through which he must pass to enter that estate is the gate of parenthood.

The benefits of parenthood, if its offices are well performed, are not confined to those conferred upon the offspring. Like most of the better things of life when given, the giver receives an equal advantage. As iron when cold gives forth no glow, yet becomes luminous with light when sufficiently heated, and thus imparts a motion to a substance finer than the physical, that is, to ether; so the warm sympathies of parenthood transmit their energies to substance still finer than the astral and tend to the construction of a truly spiritual form.

To the extent feelings and emotions are present which have for their chief concern the welfare of others, do they displace thoughts and emotions which revolve around the self, such as are represented by the Giant Bear; and to the extent the tender emotions of the family ties find expression do they displace the domestic discord of the Giant Crab.

Greek legend says that while Hercules was performing one of his great labors, battling with Hydra in the Lernean marshes, a huge Crab attempted to drag him down through seizing him by the foot.

Many another worker has similarly been hampered in life's struggle through domestic misunderstanding. Strife and discord in the home have a peculiarly effective way of confusing the mind and retarding effort. They are powerful to pull the individual down. But domestic harmony is equally as effective to raise him up. The text, therefore, becomes: **Parenthood Tends to Displace Selfishness With those Tender Affections that Most Quickly Strengthen the Soul and Build the Spiritual Body.**

The Misfortune of Old Dog Tray

—Long have the bards sung of the Inconstant Moon, whose face each night is different from the last; who rules the ever-changing ocean tides, and in the birth-chart of man is found in that department of his life most given to ebb and flood. Might we not expect, then, that the Moon's own decanate of the Moon's own sign, Cancer, should picture in constellation and in story, some spiritual doctrine relating to family life, which the sign as a whole governs, as influenced by unjustified change?

And we should have a right to expect, I believe, that the teaching should chiefly revolve around a danger to be avoided, rather than an advantage to be won; because when the Sun enters this particular decanate, or 10 degree section of its path, it undergoes its greatest derogatory change. Until it reaches the point pictured among the constellations by Canis Minor it increases in power, the days get longer and longer; but the moment it touches the Little Dog decanate it begins to fail; its power diminishes, and the days become shorter and shorter. Its life is no longer what it used to be.

It should not be inferred from this, however, that people born from **June 22 to July 2**, are less faithful in their family vows than others. Their love of home and their devotion to it is even remarkable. The changeableness to which they are subject relates to their feelings. Their emotions are like the tides of the sea, flowing in during one period, shortly to turn and flow out during the next. Although the message the constellation conveys points to the dangers of moral laxity, the trait which most clearly distinguishes those born when the Sun is here is stated by the Key-word, which is **Moods**.

Cancer is the first of the watery signs, and thus relates to baptism. That is, the Sun, as symbol of deific power, as it makes its annual pilgrimage, must go into, and come out of, the water sign Cancer before it can return to its own home in the nest sign, Leo. It is not the sign of death, but in a natural birth-chart rules the conditions at the end of life; and thus signifies, as baptism does, a readiness and willingness to enter upon a new and higher form of life, a willingness to enter the Father's fold.

When the ancients sought to find an emblem of the Savior in the sky, most naturally they selected the brightest of all the stars, the great star Sirius, which was venerated especially in Egypt because it gave warning of the flooding of the Nile, which in turn made possible the raising of crops, and thus gave new life to the people.

This star, in turn, had its own announcer. Sirius comes first in zodiacal longitude, which determines the order of its pictorial succession; but due to having a northern rather than a southern declination, Procyon, the Little Dog Star, to people of the northern hemisphere, always puts in an appearance above the horizon first. When the Little Dog Star appears it is known that the Great Dog Star shortly will follow. The baptizing star, chief luminary to picture the water-decanate of the most watery sign of all the zodiac, thus announces one still greater who is to come.

The great baptizer of Bible times, John preached incessantly against moral transgression, saying; "And now also the axe is laid unto the root of the trees; every tree therefore which bringeth not forth good fruit is hewn down, and cast into the fire." In fact, he lost his life through pointing out to Herod the evil which would follow his domestic sins.

Herod's brother Philip had a wife. But instead of treating her as a sister, Herod violated the sanctity of his brother's home by taking this woman and marrying her himself. The wife he thus obtained by breaking up his brother's home was called Herodias; and by her subsequent conduct we may be sure that she not merely sanctioned this proceeding, but also chiefly engineered it.

She was that type of woman who obtains her ends through craft and subtlety, to whom loyalty is unknown, and stops at no sin nor violence to prevent her ambitions being thwarted.

Therefore, when John remonstrated with Herod on the evil thing he had done, and placed the proper measure of blame on Herodias, she schemed and plotted to take his life. And it is not amazing, as the power of the Sun is cut off as soon as it reaches the family decanate of the family sign, that John lost his head through a plot involving the whole domestic group.

Herod, mindful of the wishes of the people, who rightfully regarded John as a very holy man, had no intention of killing him. But Herodias had a daughter who danced very well, and she conceived the idea of using this daughter to have John destroyed.

When Herod's birthday rolled around, therefore, and he had invited high captains and other notables of his realm to be present at his home, he was desirous of impressing them through affording excellent entertainment. He was more than pleased, consequently, as things began to get a bit dull, when just at the right moment, the daughter of Herodias put in an appearance and danced so engagingly that all were loud in their praise.

As pride welled up within him, and rather off his guard with the excitement of the celebration, he swore an oath that he would give the girl anything she asked, even to half his kingdom. It had not occurred to him that she would make some unreasonable demand. But when, instigated by her mother, she did betray his spirit of generosity, to have failed to keep his oath would have lost him the esteem of all those present.

Therefore, when the girl asked for the head of John, to save his own face, he ordered it brought to her, that she might carry it to her wicked, plotting mother on a platter.

Herod may not have been a model man, but like Old Dog Tray, he had to take the blame also for the transgressions of his close companions.

The Old Dog Tray story is told in many lands. He was not at heart wicked, just a dog with certain weaknesses of character, too easily influenced by his associates. He had never killed a sheep in his life, and had no intention of thus betraying the trust placed in him by his master.

But there were other dogs that had no such scruples. They lay about all day, taking it easy and warming themselves while they dozed in the sun. But when darkness fell they gathered into a roving marauding band, scouring the countryside in search of sheep to kill, on which they feasted, returning to their homes before the break of day.

Tray was not a murderer of sheep, but he loved company, and on a particular night when many sheep were killed had gone along, more for the sake of companionship than with any thought of adventure. By this time the owners of the sheep had become so thoroughly aroused that they had placed a watchman to observe which dogs left their homes at night to join the outlaw pack. Tray was absent from home, and was seen to join the others before the crime took place. He, therefore, was rounded up and paid the penalty of death, along with the guilty rest.

Long before the time of Herod another Hebrew king, Ahab, had a wife whose name has come to be used as a synonym for infidelity and wickedness. Jezebel influenced Ahab to commit all manner of evil, and it was prophesied, therefore, that she should die and that the dogs should eat her flesh; a prophecy that in due time was fulfilled, as related most dramatically in Second Kings.

The dogs that thus devour are the emotions which ever accompany wickedness. The feelings which are present as the companions of thought determine the type of compound which is formed in the thought-cells of the structure of the finer body.

Treachery, sooner or later, brings a reward of sorrow through the events attracted by the thought-cells thus formed. Hate gnaws at the very bones of the hater, attracting malice from others, and through its action on the ductless glands, destroying the mineral balance of the body.

Ever-changing moods and fretful inconstancy within the domestic circle attract a train of woes that consumes the energies and leads eventually to some disaster.

The Greeks portrayed the devouring effects of unhallowed emotions quite clearly in their story of Actaeon. This legendary person had fifty dogs with which he hunted in his leisure time. One day, as with his dogs he came out of the forest into the vale of Gargaphia, quite by accident he discovered Diana, the Moon, bathing there with her nymphs.

Instead of beating an immediate retreat, as modesty dictated he should, his emotions overcame his finer nature. But Diana perceiving his approach, thereupon transformed him into a stag. In

this stag the dogs could not recognize their master, but considering it their natural prey, they tore him quite asunder.

The Law of Affinity is inexorable. That which we have within ourselves, and that only, do we attract from our environment. The discord may be due to weakness, as it is represented in the story of Actaeon, rather than to malice; yet whatever its cause, if it is a portion of the character, built into the finer body through emotional associations, it will attract a similar discord from without.

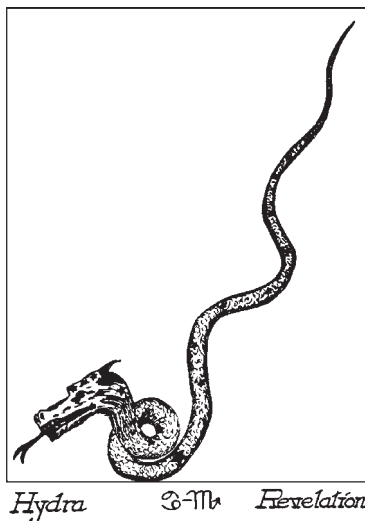

Figure 5-1

Second Decanate of Cancer

We can not do injustice to another, or like Herodias, harbor thoughts of revenge, without building into ourselves the nucleus of the very condition thought about. The plot, the very wish that injury may befall someone, builds cells of a similar quality within ourselves, which, because of their discordant composition, because given a feeling of malice, not only work from the four-dimensional plane to bring about the injury contemplated, but due to their essential vicious nature, also work to attract misfortune to ourselves.

Both the ductless glands of the physical body and the thought-cells of the four-dimensional body, take their orders as they come. It is not within their ability to reason and make decisions; only to obey. If, therefore, the thoughts are evil, or the emotions run wild, they act as thus directed, unaware that destruction follows to their master. **The text which the decanate thus suggests is: The Wages of Sin Is Death.**

The Snake Which Had Too Many Heads

—The people whom we meet from day to day, not less than those with whom we make a casual acquaintance, leave us with a distinct impression of their characters. Certain points of strength stand out, and certain points of weakness. Even those we most admire not infrequently have special traits that lessen their personal attractiveness.

We have all met the perennially apologetic individual, I am sure. The one who has ability sufficient for accomplishment, but who is fearful to make the attempt. When called upon to take some small responsibility he shrinks from it, asks that someone better qualified should do the work, or if he accepts it, makes it plain that, although he will do his best, he feels himself unqualified. Our psychologists have a label for this complaint. They call it an inferiority complex.

Closely akin to him, although quite the opposite in his expression, is the braggart. His pleasantest pastime consists in telling people how great he is, what wonders he can do. He is always the hero of his own stories. Whatever he does, be it really great or small, the part he has had to play is given undue prominence in the telling. Because inside himself he feels inadequate he ever thus presents to others a false front, in the effort to impress them with his own superiority. But psychologists say this attitude also is in reality the expression of an inferiority complex.

A third type of person we all know—in fact, we can not completely avoid him—actually believes himself of quite superior stuff to other individuals. He is ever eager to appear before the public, but when he does, as the current sporting expression goes, he always plays to the grandstand rather than offer support to his associates in their team work. He strives for the plaudits of the multitude rather than seeking satisfaction in more obscure but worthy service. The psychologists say such an individual is afflicted with a superiority complex.

Other traits of character there are also, perhaps a hundred of them, that derive from these main stems; branching out as ugly heads to mar the symmetry of action. Yet it were an unprofitable thing to draw attention to these defects, which in greater or less degree we find so common, were it not that in olden times they apparently were so well understood, and that the only remedy so far discovered is set forth most clearly in the story of the constellated Hydra.

Although, according to the mythology of the Greeks, Hydra originally had a hundred heads, only one of them was immortal. It may be assumed, therefore, that the head yet to be seen on the constellated figure is this deathless one.

Likewise, it has been found by modern psychologists, through wide experience with hypnosis, psychoanalysis and innumerable specially devised tests, that there is one head, or governing attribute within the unconscious mind of man which ever dominates the soul; which never is relinquished, and which never takes a second place so long as life shall last. More commonly it is referred to as the desire for significance. It is the inner urge to be and to accomplish.

Within each form of life there is a vital urge, an impulse that causes it to cling to life, to struggle onward, to climb upward, to express itself and to maintain its own identity at whatever may be the cost. In human terms we speak of the group of thoughts thus expressing as the Power Urges. They are mapped by the Sun in a chart of birth.

Because this urge for significance is chiefly that which impels the individual to struggle to survive, and without which he relinquishes his hold on life, it is that factor within the human mind which resists most strongly the effort to remove it, or to cause it to take a subordinate place. When it is quoted that self preservation is nature's first law, it is implied, as psychologists have found to be the case, that the individual holds most tenaciously to the importance of himself.

In his contact with the outside world, however, this sense of his own power and importance often suffers considerable shock. Especially in the childhood home is he surrounded by those whose abilities are greater. These through their attitude may cause the child to feel quite inadequate to meet that which is expected of it. Regardless of its abilities, for the child's experiences are not wide enough to afford a basis of sound comparison, its repeated failure to live up to its own expectations, which are those implied by the attitude of others, may give rise to a chronic feeling of inferiority.

On the other hand, the child who is constantly told how bright he is, whose parents place him in the limelight on every possible occasion, and in spite of mediocre performance give him unstinted praise, develops an undue feeling of his own importance. Too limited in experience to judge by outside standards, as his home and parents constantly offer the suggestion that he is made of better stuff, he accepts their statement as the truth and nourishes a chronic feeling of superiority.

Because in childhood the mind is more plastic and impressionable than at any later date, the suggestions offered by parents and others in the home are of far more importance, as a rule, in the development of chronic states of feeling as regards its own significance, than the experiences of a later date.

Yet whether the objective mind and certain thought-cells of the unconscious mind accept the suggestion of superiority or that of inferiority, there is always a central nucleus of the unconscious mind— those thought-cells most closely allied to the individuality—that never do accept the suggestion of their own inferiority.

In spite of any evidence to the contrary they hold tenaciously to the attitude that the individual is significant in the scheme of things, that he possesses qualities of value, that in reality he is not an inferior being. They hold to this tenaciously, because when this inner attitude is displaced, when this Power Urge nucleus of the individuality accepts defeat, when the soul itself admits its lack of worth, no longer is there any hold on life, nothing left which makes an effort to survive.

When, therefore, there has been developed through any experiences, of which the usual source is the home, a chronic feeling of inferiority, the individuality thought-cells of the unconscious mind refuse to accept this and devise various subtle ways by which to save their face.

The apologetic person, in the Power-Urge section of himself, expects greater things of himself than of others. He feels that he should be more perfect than the common run of mankind; hence he apologizes because of his performance, though quite as good, or better than the performance of others. He shrinks in fear from responsibility because if he did not make a great success of it, this would be a shock to his interior sense of superiority.

The boastful individual, because of his desire for significance, which in actual life he fails to attain, compensates by trying to impress others with his superiority. He presents himself as he would like to be. But while this may fool the central cells of his unconscious mind, it seldom fools the public.

The person with a superiority complex, after he leaves the parental roof and faces the world, still feels superior; but, because he fails to mold circumstances as he believes he should, his unconscious mind must ever find new alibis, for this lack of success. His failure to accomplish more than others, to save the face of his central unconscious mind, is ever laid to hard luck. He never gets an even break with others. He thinks himself imposed upon, and that his merits are never properly rewarded.

These types are only three of the more easily recognized misadjustments, of the hundred that might be mentioned by which the unconscious mind compensates by subterfuge for failure to make a correct appraisal of its own relation to life.

To readjust these mental factors was one of the twelve great labors of Hercules. The huge sea serpent, Hydra, pictures the Revelation-decanate of Cancer, where the Sun is located from July 2 to July 12. This creature of the middle-decanate of the home-sign, according to Greek legend, not only had a hundred heads, but even as

when a complex or a repression of the human mind is violently slain it crops out in other types of expression, when one of the sea serpent's heads was cut off, two other heads immediately grew to take its place.

Hercules solved the problem of these abnormal growths by securing the aid of a companion, such a companion as befits a home. When he clubbed off one of the unseemly heads, Iolaus seared it over with a hot iron to prevent another from growing.

The final head, however, was immortal, as is the desire for individual survival and significance. Wisely, therefore, instead of attempting its annihilation, Hercules buried it under a rock, symbolic of the "rock of ages," the Pole Star, Truth.

Whatever may be the unseemly desires within the unconscious mind, they can not successfully be repressed. Merely to deny them expression is to have them show two different heads where there was one before. But their energy can be utilized, and made to perform constructive work by applying the hot iron of discrimination, sublimating it through wise appraisal which directs it to find full expression in more highly acceptable ways.

Quite correctly the Individuality of man refuses to consider itself inadequate, inferior and of no consequence. The soul of each was brought into existence with a definite and essential work to do. Quite correctly also desires for expression refuse to subside. Whatever their nature they represent energies which diverted can be turned to constructive use.

Any attempt to annihilate a desire, to merely ignore it, or to suppress it, fails, because the energy is still within the finer body and must express either in acceptable or unacceptable ways. The text therefore is: **Not Through Slaying Desire, but Through Sublimating It to a Higher Plane of Manifestation Does Man Make Soul Progress.**

The Ship Which Brought Them Safely Home

—If we turn back the leaves in the book of earth's past, before long we reach pages in which fact and tradition are so inseparably blended that one can not be discerned apart from the other. To perceive where one ends and the other begins thus often becomes a hopeless task. This seems particularly true in reference to the various accounts of the flood.

One who has stood on high mountains in various regions of the land and observed close to their summits—or further down where erosion has failed to remove them as it has on top, scouring them off down to the granite core—various rocks of sedimentary origin, realizes that there is some foundation for the story of the great inundation. There are but a few choice spots in all the world that show no evidence of having been at some time in the past at the bottom of sea or lake or ocean. Sandstone, limestone, shale, and all their innumerable derivatives are formed only in the presence of water.

Gradual subsidence of certain areas accompanied by gradual elevation of others may account for much of this; but there is evidence also of occasional cataclysmic change. Yet when we contemplate these, especially of modern geologic time, the accurate history of the rocks grows dim and human tradition emerges as of more significance.

Traditions of a widespread flood are almost universal. Linked with the story of creation as written on the oldest cuneiform tablets known is an account of it. American Indians have their version of the story; and the *Tro-Cortesianus*, one of the three Maya books which alone escaped Spanish vandalism, being smuggled into Europe, links it with the sinking of an ancient land from which we inherit stellar wisdom. A translation of this Maya document reads:

“In the year 6 Kan, on the 11 Muluc, in the month of Sac, there occurred terrific earthquakes which continued until the 13 Chuen without interruption. The country of the hills of earth—the land of Mu (some translate this Atlantis)—was sacrificed. Twice upheaved, it disappeared during the night, having constantly been shaken by the fires of the underneath. Being confined, these caused the land to rise and sink several times in various places. At last the surface of the earth gave way and the ten countries were torn asunder and scattered. They sank with their 64,000,000 inhabitants 8,060 years before the writing of this book.”

Quite similar in their purport are the accounts contained in the *Timaeus* and *Critias* of Plato, where the civilization of Atlantis is mentioned and the story is told of its sinking, as related to the Greek law giver, Solon, by an Egyptian priest. After describing it in much detail, and asserting that the world had been many times scourged both by fire and by water, the priest told Solon of the sinking of the western land in a single night some 9,000 years before.

These times of greatest cataclysm, according to the stellar traditions of the past, take place when the equinoctial pointer, which is the index to evolutionary progress, reaches the stations of most critical change in its backward circle of the stars. These points are the dividing line between the fixed fire of Leo and the movable water of Cancer, and the opposite position of the zodiac where the fixed air of Aquarius joins the movable earth of Capricorn.

These two points reached annually in the journey of the Sun mark the extremes of temperature. The hottest weather of the year commonly occurs about July 23, when the Sun moves from Cancer into Leo; and the coldest weather of the year usually may

be expected about January 20, when the orb of day leaves Capricorn to enter the sign of the Man.

The Vernal Equinox in its movement through the signs, however, goes in the reverse direction, so that it moves from Leo into Cancer, from fire into water, from the decanate of the red-hot crater into the decanate pictured by a ship.

When the Equinox thus crosses from fixed fire into movable water, and the Sun at the time of the Vernal Equinox goes down in the west as if submerged, the Waterman rises in the east, triumphant, and starts pouring water from his urn down upon the earth in torrential floods. And as timing this event, the Pleiades, which are often called the doves, are then directly overhead.

According to the latest and most refined astronomical calculations, the complete precessional cycle requires 25,868 years, instead of the round number, 25,920 years, which the ancients more commonly employed. If, therefore, as both tradition and the pictures in the stars hold forth, the period when stresses and strains are such as to make watery cataclysms probable relates to the passing of the Vernal Equinox from the decanate of Crater in Leo into the decanate of the Ship in Cancer, the dates are not difficult to ascertain.

Taking 1881 as the date of the Equinox passing from Pisces back into Aquarius—that is, 30 degrees back from the place where in ancient times it had been ascertained that the commencement of the circle of stars coincided with the commencement of the circle of signs—it must have passed back into Cancer from Leo just five signs earlier, and will again reach such a point seven signs later.

Five-twelfths of 25,868 gives 10,778 years before 1881, or 8,897 B. C. as the date of the last such period of watery cataclysms. And seven-twelfths of 25,868 gives 15,085 years after 1881, or 16,971 A. D. as the next such period. On these dates, at least, at the commencement of the astronomical year, as Crater goes down in the ocean and the Pleiades are overhead, the Waterman comes up with his urn as if to pour torrents down upon the earth.

The traditions and stories of this olden flood, wherever they are found, are linked with the wickedness of men. This wickedness is not of the usual kind, but always has to do with strange and abnormal psychic phenomena. Atlantis sunk, so the tradition goes, because of its devotion to magic of the blackest sort. Those who had gained the ability to use occult forces no longer used them for the welfare of the people, but chiefly to gain in power for themselves. The populace was enslaved by unseen forces.

In the time of Noah also, a similar condition obtained. The sixth chapter of Genesis relates incredible things about the diabolical influence upon the lives of the people of beings that rightfully belonged to a different plane.

Those who go to the seance room expecting to surrender control of themselves to entities about which they have no knowledge should again read this ancient story. The ship, or ark, picturing the **Research** decanate of Cancer, where the Sun may be found from **July 13 to July 23**, indicates that the etheric sea of such a situation favors the production of strange creations; but it also indicates that it is safer not to become immersed in this Psychic Research sea.

Warned by their knowledge of the stars, the wiser ones of Atlantis are said to have departed to foreign shores. Likewise warned was Noah, and as the account makes clear, neither he nor his family took part in the current psychic abominations.

Instead, they ever kept alert, always avoided those who followed practices that included loss of self control. Their souls were stable and sound, like the Grecian ship which carried Jason and his companions on the famed Areonautic Expedition for the recovery of the Golden Fleece.

This Golden Fleece of eternal life, symbolized by the ruler of gold, the Sun, in its exaltation, the sign of the Ram, is well worth sailing for, well worth all the Research that may be devoted to learning how it may be secured. But it is not to be obtained by loss of self-control, and not by a complete discard of caution.

There is a right way to investigate the conditions and possibilities of the unseen realms, those regions where man must make his future home. But when the ark first touched the land Noah did not throw caution to the wind and rush forth. First a raven and then a dove were sent out that the conditions which there prevailed might be learned without danger. Nor did Noah remove the cover of the ark until, without chance of being drowned, he had ascertained that the earth was dry.

Not birds, but radio waves, are now used as messengers. The nervous system of man is an organic receiving set, over which he can receive communications from other planes. With properly developed poise he can tune in and out much as he desires, and without the danger of some other entity in control.

If, as when the raven was sent from the ark, no message is received, or if it be inimical, if he retains poise he can tune off the station. But if, instead, he steps from his steady bark and permits dark waves of unknown origin to sweep him off his feet, so that, no longer is he able to determine what he can do, he has relinquished his ship of safety.

The right and the wrong way to accomplish a given thing may seem closely allied. Particularly may this seem true in the field of Research so long as that which is desired seems identical. Yet the result to the individual of using the correct method of approach is the difference experienced by those who entered the ark, or departed on board ship from the land of Atlantis, and those who felt the full force of the deluge.

Argo encourages rather than disparages the effort at research into the forces and regarding the entities of the invisible plane; a tendency outstanding among those born while the Sun is in the section of its annual cycle thus pictured. But it also offers wise council as to the method by which such voyages can be attempted in safety.

Each mariner should keep his hand firmly on the helm. The text, consequently, is:
**Poise is the One Safe Haven of the Soul, therefore, “Under All Circumstances
Keep An Even Mind.”**

Chapter 6

Serial No. 76
Original Copyright 1935
Elbert Benjamine

Copyright
Church of Light
August 2002

Is There a Santa Claus?

Chapter 6

Is There a Santa Claus?

When Samson Lost His Strength

—Daniel had quite an adventure in a den of Lions and the Greek Hercules was compelled to strangle such a beast, but at a still more ancient date heroic Samson tore one quite in two, at the time when love first came into his life To picture that section of the sky where the Sun holds forth in all his courage and all his strength from **July 23 to August 23** each year, the section which in the natural chart of man relates to offspring, to pleasures, to gambling, and to affairs of the heart, the ancients chose the Icing of beasts, the dauntless lion.

Samson was one of those unfortunates to whom our sympathies go out, present in every community and in every period of the world, who loved not wisely but too well. He was a good chap, but always unfortunate in his love affairs.

His intentions, as a youth, were honorable and just. He met a young woman who found favor in his sight, and being in love with her, sought in honor to make her his wife. But his parents were opposed to such a match. This woman was of a different faith, they wanted nothing to do with her, and so Samson's troubles began.

A Lion, related astrological to the house of pleasure, is a universal symbol of desire. If the desire be spiritual the creature is represented in its beneficial sense, as when Christ is termed a Lion of the tribe of Juda; but if the desire be gross, such as leads to destruction, the beast is shown antagonistic, as when the devil is mentioned in the Bible as a roaring Lion.

Thus when Samson in love with the girl, was met by a young lion which roared against him, it is to be inferred, especially as his parents disapproved, that he was beset by passions which raged within. But, as is set forth at considerable pains, his life up to this time had been without blemish in thought or action, his mother being carefully instructed even before his birth.

The young Lion thus was easily conquered, and whatever his thoughts for the moment may have been, they were quickly vanquished by those of a highly spiritual kind. No type of nourishment is quite so high in its symbolical significance as honey ruled by Venus, and made from the nectar of flowers. It thus represents a spiritual food.

Genius in every age and clime has been inspired by love. As the love is exalted so does genius soar to higher levels of expression. Love has creative power, therefore Samson, having again talked with the girl of his choice and exalted by his adoration, partook of spiritual nutriment, tuned in on energies which brought him spiritual strength, as symbolized by the honey he found and ate, which the bees had made in the carcass of the roaring lion he had slain.

The conversion of the roaring lion into honey with which he fed his soul, and which also proved acceptable to his parents, is expressed by psychologists of the present day as the sublimation of desire.

As already pointed out, in practical astrology the sign Leo is related alike to love affairs, to gambling and to entertainment. Therefore it was quite in order, from a symbolic point of view, that the culmination of Samson's first love affair in marriage should be celebrated with a feast to which other young men were invited, and that this, in turn, should lead to gambling.

The riddle proposed by Samson, on which the wager was laid as to its correct solution, is the riddle with which every person is confronted, and on the solution of which depends his life's reward. Samson knew the solution of the riddle; but as events later transpired they show, like many another, that he did not always practice what he knew.

With the thought in his mind of the lion he had slain, out of which he had obtained honey, he said to those who came to his entertainment, "Out of the eater came forth meat, and out of the strong came forth sweetness."

In the sense of Samson's riddle only those who have can give to others; and those who have the energy to benefit their associates must acquire it from some already existing source when the vegetables from the garden are eaters; for they consume water and minerals from the soil and carbon from the air. This is generally recognized; but in the second part of his riddle Samson went beyond the commonplace. Not the observation that only those of outstanding abilities are able to be of much help in the progress of the world as such. But when he implied that spirituality, as symbolized by the honey, depends upon strength, he sets forth a great truth.

Moses made use of material wealth for spiritual purposes. But here is a teaching that desires, even the roaring desires which Samson met on his visit to the Philistine woman, can so be used. In fact, the implication is that desires such as are symbolized by the lion are the source from which spiritual powers most readily can be derived.

The Key-phrase of Leo is, **I Will**, and people born when the Sun is in this sign commonly exhibit more than the average amount of that fixity of purpose which goes by the name of will power. Yet power of will itself is dependent upon ability to keep the desires focused on the objective to which once they were so strongly attracted that a decision to follow some line of conduct toward their realization was made. Therefore, the stronger the desires are which an individual has, the greater will be his will power if he can keep them, instead of running wild, turned into some particular channel of his choosing.

In order to accomplish this there must be the willingness, when occasion requires, to face disagreeable situations. Such willingness is called courage. Courage is of different kinds. Samson had the courage to meet physical peril of the most dangerous sort; but not the courage to resist the pleading of a woman, even though it meant his certain ruin.

For that sweetness which comes from the strong, which is the manifestation of spiritual growth, the desires must not be diverted from their lofty aim through wavering in the face of obstacles. To desist, to give in to another knowing such yielding to be wrong, is moral cowardice. In spite of Samson's physical courage he was a moral weakling; for when his newly acquired wife tormented him to tell her the secret of his riddle, after a time he grew so weary of her complaining that he took the line of least resistance and told her all.

She, telling those who sought to solve the riddle, caused him to lose his wager. And although at some later date, linking the common rulership of love affairs and gambling, some one coined an ameliorating phrase that to be unlucky at cards is to be lucky in love, Samson's experience, like common observation, brings its complete refutation. He lost not merely the gambling stake, but his wife as well.

One might think that one experience of this kind would have been enough for Samson. Yet in our daily contacts of life such failure to profit by experience is a matter of common observation. A certain weakness is so strong, as the birth-chart reveals, that the individual makes the same blunder over and over again. It is one of the functions of astrology to indicate how this can be avoided.

In Samson's later, and even more disastrous love affair, the source of his strength, the cause of its loss, and how at last it was regained are set forth still more clearly. But this clarity is present only when hair, which like honey is ruled by Venus, the planet of love, is recognized as a common object used in universal symbolism.

When Delilah implored Samson to tell her the secret of his strength he tried by means of subterfuge to throw her off the track. He told her that if he were bound with seven green switches he would be unable to break them. So she bound him thus, and called as if shouting to his enemies; but he broke the switches with the greatest ease.

As she continued to nag him for his want of trust in her, later he said that if he were to be bound with new ropes he would be unable to free himself. But when she trussed him up with such strands, and called to his enemies who lay in readiness to capture him, these also he broke like threads.

Then he told her that if she were to weave the seven locks on his head it would render him helpless. Yet when she had done this, and fastened him by the hair to the loom, and he awoke, he went away, carrying the pin of the weaving beam, with no more difficulty than he had before.

Finally, however, the moral cowardice of the man caused him to yield to her entreaties, and he told her all he knew; that his strength was in his hair. So she shaved his head and his strength departed from him. She called his enemies. They put out his eyes, placed him in fetters, and made him do the grinding in the prison house.

The seven locks of hair which she shaved from his head are of the same symbolic significance as the honey taken from the lion's carcass; for both hair and honey are ruled by the planet of love. But here, instead of acquiring spiritual energy through the sublimation of his desires, he is represented as having lost the energies he already possessed through moral cowardice.

The seven locks which were shaved from his head were symbols of great desires, which, so long as present furnished the energy for tremendous undertakings. But when, through lack of courage to resist that which deflected him from his purposeful course of life, he permitted himself to be shorn of desire, in other words, when he gave up to the importunities of life, his strength went from him.

Yet later, when his hair grew long again, symbolizing desires that could be converted into will, and they had taken him into a house where his enemies were collected that they might have fun with him, he pushed down the pillars, bringing their destruction along with his own demise. The text thus follows: **Any Accomplishment Truly Worth While Requires the Exercise of Courage.**

Fire and Brimstone Which Came Out of the Sky

— In form, the cup placed in the sky is similar to those vessels used in ancient times, and in many regions of the earth today, for holding burning coals. This heat producing quality is quite understandable in light of the constellation's use to picture the fiery decanate of the fixed fire sign, the 10 degrees through which the Sun must pass from **July 23 to August 3**, when commonly the days are hottest.

Therefore it represents the fiery furnace into which, as related in Daniel 3, Shadrach, Mesach and Abednego were cast; the furnace which, for their special destruction, had been heated seven times hotter than was the ordinary custom.

So hot was it, and so great was the haste of Nebuchadnezzar to have these men—who fell not down in worship when all the people heard the sound of cornet, flute, sackbut,

psaltry and all the other kinds of music which Leo rules—consumed in flames, that those who threw them in perished of its heat. As the desires which Leo rules, when their associates are bad, burn the flesh and sear the soul, so did the unregenerate worshippers of lust perish by the fiery furnace.

But the three companions who refused to bow the knee to sensual pleasures, who still earlier with Daniel had refused defiling food, had formed spiritual associations for their desires. Thus when Nebuchadnezzar looked into the furnace where they had been cast, instead of men who had been bound and thrown into the flames, as desire is wont to bind and burn its own, he saw the three walking about unhurt, and with them was a fourth, who appeared like the Son of God.

In very truth, it is that with which desire associates that determines its power to injure or protect. If its associations are spiritual, as those of the three companions are revealed to have been, it consumes and destroys as related in this story from the Bible.

Still further back in Bible times, but not back so far as Noah, the cities of Sodom and Gomorrah perished because of licentiousness. They were wiped out not by flood, but by fire and brimstone from heaven. Yet even as Shadrach and his companions escaped unharmed, so did Lot and his two daughters escape the holocaust of that time.

This again recalls the universal tradition that the world at times is swept by floods and at other times by fire. The period of such cataclysms, according to the stellar doctrine of the past, is when the Vernal Equinox moves backward from the fixed fire of Leo into the movable water of Cancer; or when it passes back from the fixed air of Aquarius into the movable earth of Capricorn.

Either as to the time or the particulars of the two types of cataclysms we have nothing more definite than tradition. But that some such cataclysms really did occur, wiping out early civilizations, there is increasing and positive evidence to show.

At the time this is being written (1935) the latest such conclusive evidence is that furnished by the explorations of F. A. Mitchell-Hedges in Central America. There he has found thousands of relics— which have been presented to the Museum of the American Indian, New York, and to the British Museum, London—of a civilization infinitely older than that of the Maya or of the Inca.

While a different culture from that of the Maya or the Inca, the similarities caused the British Museum in an official statement to express the opinion that it is an ancient culture from which the ancient forms of culture were differentiated over Central America.

The director of the Museum of the American Indian, Heye Foundation, New York, wrote Mr. Mitchell-Hedges in part:

“Your own observations, and the United States Government surveys in Nicaragua, prove conclusively that at some remote period a tremendous earth movement of cataclysmic force must have taken place in that part of the world . . . and your excavations have actually unearthed the cultural artifices of a prehistoric people that existed prior to the great earth movement . . . and your discoveries open up an entirely new vista in regard to the ancient civilization of the American continent.”

Mr. Mitchell-Hedges says his research has revealed that at some remote time a great land area stretching eastward from Central America sank and was engulfed by the sea, and that during this gigantic geological readjustment a portion of what had been sea-bed was heaved upward to become land of considerable height within the area now known as Central America.

Volcanic action of magnitude must have accompanied this cataclysmic change, during which his evidence goes to show, a great and cultured race of men were destroyed. A few, fleeing to the tops of mountains and upland, were able to survive for a time on the newly made islands, where they left behind the imperishable objects of their own handicraft, from which Mr. Mitchell-Hedges, with the support of the two great museums mentioned, is endeavoring to reconstruct their life story.

As to the date at which this pre-Mayan civilization existed, he believes it flourished not later than 15,000 B. C., and possibly that it dates back of 25,000 B. C.

It is not a legitimate function of tradition, even of stellar tradition, to set dates of events in the past that should be left to the painstaking research of archaeologists. Yet it may not be amiss to determine the date when, according to stellar tradition and the pictured constellations, the last period of great cataclysms by fire took place. If Mr. Mitchell-Hedges is correct in his opinion that the cataclysm of which he finds the remains happened over 15,000 years ago, this would take it back of the time of the period of floods, back of the time when the Equinox passed from Leo into Cancer. Therefore, we should look to the opposite point; to the time when the Vernal Equinox passed from the fixed air of Aquarius into the movable earth of Capricorn.

Such a position not only indicates that whatever happens to the water it is the land which moves first, but that when the Equinox thus crosses from fixed, air into movable earth, and the Sun at the time of this Vernal Equinox goes down in the west as if submerged, the Fiery Furnace, Crater, rises in the east, triumphant, and starts pouring fire down upon the earth. And as timing this event, the Pleiades, which are often called the doves, are then directly on the midheaven not at sunset, but at the rising of the Sun.

According to the latest and most refined astronomical calculations, the complete precessional cycle requires 25,868 years, instead of the round number, 25,920 years, which the ancients more commonly employed. If, therefore, as both tradition and the pictures in the stars hold forth, the period when stresses and strains are such as to make fiery cataclysms probable relates to the passing of the Vernal Equinox from Aquarius back into Capricorn, the dates are difficult to ascertain.

Taking 1881 as the date of the Equinox passing from Pisces back into Aquarius—that is, 30 degrees back from the place where in ancient times it had been ascertained that the commencement of the circle of stars coincided with the commencement of the circle of signs— it must have passed into Capricorn just eleven signs earlier, and will again reach such a point one sign later.

Eleven-twelfths of 25,868 gives 23,712 years before 1881, or 21,831 B. C. as the date of the last such period of fiery cataclysms. And one-twelfth of 25,868 gives 2,156 years after 1881, or 4,037 AD as the next such period. On these dates, at least, at the commencement of the astronomical year, as the Man goes down in the ocean Crater comes up and so turns as if it were pouring fire and brimstone down upon the earth.

In the various stories from out of the past in which this fiery furnace figures many who are subject to licentiousness perish, but others more pure in heart are saved. It is not the zeal with which they live that causes the destruction of some; for neither Lot nor Shadrach and his companions, were negative people; but their zeal was directed constructively. It is not the finding of pleasure, but the seeking for pleasure in the wrong things, that leads to dissolution.

Because action flows so spontaneously and without friction toward those things in which pleasure is found the most successful way of defeating the pull of forbidden desire is to cultivate a still keener pleasure in more beneficial things. When the pleasure to be found in these is greater, the thoughts will turn in this direction, and the forbidden impulses will die for want of nourishment.

The attitude toward nearly everything in life has been conditioned through the experiences associated with it. To the extent the experiences with a certain type of activity have been painful does thought of it bring distaste to the mind. To the extent its associations have been pleasurable, do these become linked to it in the mind as an inseparable part of it, exerting a distinct attraction.

Through following the methods indicated by an understanding of this principle it is possible to cultivate a distinct liking for almost anything. There are always many phases of a thing, which if sought for, can make it appear in a pleasurable light. Even the thought of the advantage of having a will power strong enough to continue what otherwise is a distinctly unpleasant activity, may, and often does, so strongly associate the activity with thoughts of satisfaction that the activity in time becomes a pleasure. In fact, it is only through the advantages that are associated with it that people commonly learn to take pleasure in hard work.

People born while the Sun is in this first decanate of Leo commonly have a desire for, and some ability in Rulership. The text derived from Crater is: **To Learn to Like Anything, Associate With It as Many Pleasurable Thoughts and Sensations As Possible.**

**Why Santa Claus Comes
Down the Chimney**

—The very first glance at a chart picturing all 48 of the ancient constellations, such as that illustrating Lesson No. 71, brings to the attention that two of the constellations, quite far apart in the sky, portray the same mythological creatures. Part horse and part man, the only difference between Centaurus, which pictures the Sagittarius-decanate of Leo, where the Sun may be found from **August 3 to August 13**, and Sagittarius, which pictures the sign where the Sun may be found from November 22 to December 22, is that Centaurus is armed with a shield and spear, while Sagittarius has a cloak and uses bow and arrow.

This identity of the pictured forms at once suggests that the ancients who placed these pictures in the sky to convey information in terms of universal symbolism, desired that these two sections of the heavens be closely linked in the teaching they wished to give. It certainly is not coincidence that one larger and one smaller section of the zodiac should be represented by similar creatures; or that those chosen should indicate the human qualities carried by a horse. Rather, especially as the huntsman and the spearman face as if each were traveling toward the place of the other, it signifies that there is a movement of the same type of influence from one station in the zodiac to the other.

We are bound to infer, therefore, that the teaching signified, and the traditional story left to give more detail, includes a movement, a carrying from one place to another else why the horses' legs?— and that its comprehension requires several stations in the zodiac, the two most important being those pictured by the roving horsemen.

If we follow the simplest and most obvious method, which is that always employed by those who traced these doctrines in the sky, it will lead us to commence with Sagittarius because it pictures 30 degrees, and is therefore more important than Centaurus which pictures only 10 degrees of space. We may be sure, however, that a child or children will play a part in the story, because the smaller influence relates to the middle-decanate of Leo, which has natural rule of children.

Sagittarius, ruled by Jupiter, and the Sagittarius decanate of Leo, also having Jupiterian rule, are known to relate to gifts. Astrologers say that what Jupiter brings comes freely as the result of good-will rather than through work as is the case with Saturn.

Hence it is that immediately after the Sun leaves the Sagittarius sign in winter is the time when gifts are made. Christmas is not on the day when the Sun reaches its farthest declination south, which is the day when it crosses from the manger of the horse to the manger of the goat, because for three days it remains at this lowest, most southern, point before starting back to bring new life and light into the world.

Giving it three days grace after December 22 insures that on Christmas day the Sun will be moving northward in declination and that the days will have started to get longer. They will thus continue to lengthen until June 22, when the Sun reaches the topmost point of the home sign, Cancer.

The topmost part of a home is commonly the chimney. Therefore the Sun, in coming to the home from the place where Jupiter brings his gifts on the line dividing Sagittarius and Capricorn in winter, must touch it first at the highest spot, the chimney. And to reach it, he of course comes through the air.

In vain you will search the Bible for mention of Christmas tree or Santa Claus; yet that they are linked traditionally with the Centaur picturing the middle-decanate of the section of the heavens relating to children seems certain; for on that day when they are prominent it is said a child was born. Born in a stable underground as the Sun yet represents; for it has reached its lowest point when between the horse and goat, from which time it starts to gain new strength.

Santa Claus, like the horsemen in the sky, one of which relates to the time of winter's cold and the other to the heat of summer, portrays two seasons of the year. His garb is chiefly red; for as representing the constellated Centaur is he not next the fiery furnace, Crater, where the heat glows fiercest? Yet also, to denote the snow of winter, the trimming of the garb is spotless white.

The gifts he brings at Christmas time are tokens of still greater gifts to come, they are the promise that abundance will follow after the time of winter dearth when the heat from the Sun will have had time to ripen crops again. Still ahead, even though the days have started in their lengthening, is a period of privation and cold. Stored supplies may become exhausted, giving rise to dark despair; yet even at the entrance of this period does he give promise of better days to come.

In his jovial manner and rotund figure he expresses the Jupiterian quality of Sagittarius, from which the Sun has just moved at Christmas. This is the sign of religion. And even as Santa Claus brings promise of material gifts; so religion brings an equal cheer and promise of spiritual blessings after the hard dark days of earth are done. Yes, the days are darkest about Christmas time. They are like those other days when hope so fades that nothing seems worth while. Therefore is it fitting that there should be joyous news of a happy future life.

Santa, however, not merely represents Jupiter's winter sign, but also a decanate of Leo, sign ruled by the Sun. And anyone who has viewed the radiant rising Sun on a cold and frosty morning will remember the resemblance to Santa's red circle of a face.

Yet the youngsters of the land, whose special joy he is, would not recognize the rotund fellow if divested of his whiskers. They are an essential part of his makeup because at Christmas time the Sun has just moved into Capricorn, and chin whiskers are the especial adornment of a goat.

Horses customarily draw sleighs, therefore Sagittarius and Centaurus well could qualify; but as still more significant of the cold bleak winter days, reindeer are now used to take their place. They are more accustomed to ice and snow.

Before this sleigh—which coming from Sagittarius, the Jupiterian sign of abundance, is filled with good things to overflowing—can get to the fireplace, Crater, it must land on top the house at Cancer. And thus really does the Sun. For after touching the highest point it reaches, which is where it enters the home-sign Cancer, it immediately starts descending, as if going down the chimney, until it passes into the decanate pictured by Crater.

It does not tarry in this fireplace, or hottest decanate of the zodiac, however, but at once moves into the decanate pictured by Centaurus, the other horseman of the sky. The feet, it is true, are ruled by Pisces. But ask any small boy or girl—such as is ruled by the Leo section of the sky—if it is enough to hang up the mere feet of stockings on Christmas evening. If I remember rightly, there is usually a hunt for stockings that are long and ample, such as come well up on to the thighs. And it is the legs thus covered by the longer hosiery that Sagittarius rules, and of which its decanate in Leo also must partake.

The horseman of Leo is not the gift, but the one who brings it; for it is the Sun at this time of year that ripens the grain in the field and the fruit on the trees. The gifts which the traveler from the north thus brings, while related to the children of Leo, are pictured in the next sign to it, in the harvest sign, Virgo. It is really the Virgin Mother, not Santa Claus, from whom the gifts more directly come.

The lady of the sky holds a palm frond in one hand and heads of wheat in the other; while Hercules, who pictures the middle decanate of the Virgo sign, holds in his hand the branch of a tree adorned with fruit.

The fruit thus shown is the fulfillment of the promise made at the time when the nights were longest, just as the Sun turned back from its farthest distance away. This promise was not made by using a tree when it was filled with fruit; because such are hard to find at Christmas time. It was made by using a tree symbolic of perpetual life, by using an evergreen tree. The fruit to come, when ripened through the heat of the Sun in Leo, was represented by presents on that tree. And it was spangled with stars and bedecked with lights as a token that the Sun, thus moving through the firmament, was on the way to dissipate the winter's darkness.

At this Yuletide time of year, still further to connect the passing of the Sun from Sagittarius to the Centaurus decanate of Leo, the sign of love affairs and pleasure, it is the custom to hang mistletoe with the privilege of kissing whomsoever passes under it.

The mistletoe, like the Christmas tree, is of evergreen foliage, and thus symbolically promises everlasting life. But because it grows above the earth, apparently too pure and holy to touch the physical soil, it came to have a special spiritual significance. Its berry fruit, formed without polluting contact with the loam of earth, came to be looked upon as derived from an immaculate conception.

Kissing under the mistletoe even in times not remote was a solemn and binding ceremony. It was the token of a chaste affection and the promise of marriage. More

than that, it was the promise that out of the love then expressed should develop a new and more spiritual type of life.

Such a life of spiritual endeavor, as Santa Claus and Centaurus clearly teach, is dependent upon what is done for others. It is the effort to give, rather than the effort to take, which promises a spiritual harvest.

After all, in the realms of the future, after we shall have passed from this mundane sphere, the physical objects men set their hearts upon will have less value than the tinsel and gilded baubles with which they decorate the Christmas tree.

Those born while the Sun is in the **Reformation** decanate of Leo are often more energetic to bring beneficial changes. The text is: **It Is More Blessed To Give Than to Receive, and to Receive In Full Measure We Must First Give of That Which We Already Have.**

Why the Crow Turned Black

—One needs to know something of the habits and characters of crows and ravens to discern what the ancients must have had in mind when they placed one of these noisy, thieving, carrion-eating birds in the sky. Corvus is the name yet employed by naturalists to distinguish the genus embracing both birds, which are so closely allied that they are distinguished in the field chiefly through the noise they make. A raven has a coarse and croaking voice, while a crow vocalizes in a loud and raucous caw.

One who is familiar with the ways of crows and ravens could be sure that they would never be used as universal symbols of any commendable trait or habit. Their one claim to admiration is their unparalleled ability to look out for themselves.

Because they are destructive to crops, pulling the new sprouts of grain from the ground, and because in the cattle country of the West they do not wait for a crippled creature to die, but pick out its eyes and help themselves to its flesh as soon as they find it defenseless, relentless war has been waged against them by man. Yet so cunning are they that, with every hand raised against them, they are now more numerous than ever.

Before going further into the habits of crows, it should be explained that people born while the Sun is in the Corvus decanate of Leo, from **August 13 to August 23**, are no more apt than other people to partake of the undesirable crow-like qualities. It is true that they have great Ambition, and as a rule are exceptionally able to take care of themselves. But it is only the occasional individual who permits this Ambition so to dominate him that he comes to have no regard for the feelings and rights of others, and uses them unscrupulously to realize his aims.

Yet it was the function of the constellated pictures not merely to reveal those things which should be done, if one were to live the most satisfactory type of life, but also to point out the dangers along the way. And one of these dangers, to which many people are subject, and to which those born while the Sun is in the last decanate of Leo are particularly exposed, is portrayed by the character of the raven or crow.

When Noah, in the ark, badly wanted information, because the raven is so keen an observer he sent one forth to get it. It saw the condition, but instead of reporting back to Noah it flew to and fro. It took good care not to perish, but neither did it return to the ark, and to find out what he wanted to know, Noah had to send out a dove.

Even the feeding of Elijah was characteristic of the propensities of the bird. As related in First Kings, 17, there was great drought in the land, so that everyone was hard pressed both for food and water. Elijah had established a hiding place from his enemies by the brook Cherith; "And the ravens brought him bread and flesh in the morning, and bread and flesh in the evening; and he drank of the brook."

Where the ravens found the flesh is open to discussion; but bread already baked does not grow on bushes, even in the promised land. The only way they could have obtained the bread was to steal it. And as they are noted for such pilfering the inference is that they grabbed it when its owner was not watching, or at least without the owner's consent. Thus while Elijah benefited, someone else in this land of food shortage was deprived. Yet no blame can be attached to Elijah; for there was nothing to indicate he knew to whom the food rightfully belonged, or where to return it.

As the constellation shows this racketeering bird, he has alighted on the back of the water serpent, Hydra, and is in the act of tearing a piece of the living flesh from it, as in the cattle country of the West he works on stricken sheep.

Hydra is the longest of the constellations. It pictures the middle decanate of the sign of the home, Cancer; but also embraces in its length all four of the constellations relating to the different kinds of companionship; that is, companionship in the home, companionship in love affairs, companionship with employees, and companionship in partnership and marriage. We may be sure, therefore, that the characteristic which the ancients sought to portray by Corvus is one which quite commonly and quite painfully attacks and destroys these human associations.

Perhaps to get a clearer insight of this matter it will be well to turn to the Greeks. According to their account, Apollo, the Sun, was deeply in love with Coronis and was jealous of her conduct. This jealousy developed into a desire to spy upon her; and as most fitted to do such unethical gum shoe work, especially where love affairs are concerned, he selected a raven, which in that day was still of purest white.

Those who surreptitiously pry into the conduct of their associates seldom learn anything complimentary to themselves. It was almost a foregone conclusion, therefore, that the scandal mongering raven would find something unsavory to tell. Although he partakes of other and forbidden food, chiefly he is a carrion eater. The more rotten the repast the better he likes it. So, true to his nature he came back to

Apollo with gossip aplenty. His loudly wagging tongue took gross delight in relating, with spicy embellishments, all the details of a love affair between Corona and Ischys the Thessalian.

It might have happened today, with all their pictures in the tabloids, so true to common observation was the outcome. The malicious carrying of tales, the prying of inquisitive noses into what are no concern of theirs, all too often wrecks the budding of some fine affection; or, as in this case, brings grief and tragedy where peace and happiness should have laid their heads. Apollo, enraged at the reports of his sweetheart's infidelity, shot her through the heart.

The crow, of course, had nothing to gain but his own malicious satisfaction. Nor commonly is there any benefit to those who exaggerate the misconduct of others. It is a pity, therefore, that as the poet has suggested, the whole scandalmonger crew can not be painted red or blue, that all might know them; for something similar happened to the crow, and ever since. that day he has been compelled to wear a cloak of black.

Because gossip which relates the amatory experiences of others is so common, as witnessed by the yellow news sheets, as well as by neighborhood propensities, more people should be informed as to its origin. Freudian literature makes it plain that those who find a suitable outlet for their own creative energies are never given to such gossip. They are very little interested in the love escapades of others because their own love natures have been completely satisfied.

In thinking about any experience there is a certain thought participation in it. In telling about the conduct of another, whether that conduct be commendable or the reverse, not only the one who does the telling, but also the one who listens, vicariously takes some part in the experience. Were this not true the movies would languish for want of patronage.

People go to the movies, and read fiction, chiefly to gain experiences vicariously for which they inwardly yearn, but which their lives are too narrow to permit. That which constitutes the strongest longing in their unconscious minds, is that which they enjoy most on the screen.

The office clerk whose most gallant act during working hours is to make entries in a book, inwardly longs for adventure. He is denied action and excitement in his life, and he goes to the movies to get them. He identifies himself with the dashing hero, delights in his valorous exploits, takes part in the downfall of the villain, and glories in the justification of those misunderstood. He goes home with a certain sense of satisfaction because a repression has been released.

The shopgirl whose life is devoted to pleasing customers over the counter, and who inwardly longs for romance, thrills with vicarious joy when the handsome hero on the screen, after surmounting terrific obstacles and facing dangerous hazards, at length triumphant, clasps the fair heroine to his manly breast. Nor should she be censured. To love and be loved is an imperative command of nature. Nothing is finer than honest love. And the shopgirl, identifying herself with the heroine, is able thus to realize in some measure a longing which is both beautiful and natural.

But the scandalmonger deals not with honest affection and in heroic and commendable actions. His tales are about illicit love. In telling and in hearing about, the morbid affairs of others, he takes part in them vicariously. Although he does not recognize this, and is the first to deny it, his unconscious mind identifies himself with the transgressor. Just as the office clerk finds some relief for his honest desire for adventure; just as the shopgirl is able somewhat to satisfy her honest desire for romance and glamour; so the gossip, through tale bearing and tale listening is able to satisfy his desire for illicit, licentious, and ignoble conduct.

As a crow or raven feeds largely on putrid flesh, so those who revel in relating the unseemly conduct of others feed their souls on rotten food. Their desire to discuss the vileness of others can only be interpreted as a desire on the part of their unconscious minds to do these same things, if they but possessed the courage.

To the extent an individual talks about and thinks about that which is rotten, is this an expression of rottenness within himself. Those who are clean have a desire to keep away from filth. They do not revel in the sinfulness of others. Furthermore just as the clerk who identifies himself with the hero, cultivates within himself a delight in valiant and honorable action; and just as the shopgirl who identifies herself with the sweet and admirable heroine, cultivates within herself pleasure in womanly conduct of the same high standard; so does the scandalmonger cultivate within himself an increasing relish for moral carrion.

Repressed desires, even though unrecognized objectively, can not be kept from finding some expression for their energy. And as the raven became black because he carried a black story, so that which is thought about adds its thought-images to the soul. The text thus follows: **Man Tends To Become That Which He Most Talks About and Most Thinks About.**

Chapter 7

Serial No. 77
Original Copyright 1935
Elbert Benjamine

Copyright
Church of Light
August 2002

Why Eve Was Tempted

Chapter 7

Why Eve Was Tempted

The Tree Which Grew In the Garden of Eden

—If we turn back the pages of the Bible to the time when man first appeared on earth we find him inhabiting a garden.

One whole 30 degree section of the zodiac, where the Sun may be found from **August 23 to September 23**, was set aside by those who anciently studied the stars as representing just such a garden, and as having an influence over the fruit of the trees and the grain of the fields. It is the harvest sign, Virgo.

Were this not recognized to be the case, both in olden and in modern times, certain passages of Genesis would be astounding; such as where it relates that Adam and Eve heard the voice of the Lord God walking in the garden in the cool of the day.

Yet viewing this occurrence in the light of ancient stellar wisdom there is nothing obscure about it. It quite definitely locates the garden among the constellations, for, in the sense that there is yet more light than darkness, more heat than cold, all the time the Sun is in the garden sign, Virgo, it indicates that the Sun has not yet gone into the winter signs. Yet when the Sun moves out of this garden sign into Libra it will be in the cold half of the year, when the nights are longer than the days. As Virgo adjoins, but is not one of, the winter signs, when the Sun is in the harvest sign quite appropriately may be termed the cool of the day.

Virgo is an earthy sign; and out of the ground of this garden the Lord God made to grow every tree that is pleasant to the sight, and good for food, and also the tree of life as well as the tree of knowledge of good and evil. Yet because of certain actions on his part, man was not permitted to partake of the tree of life; and consequently to find it we must move across the zodiac to one of the decanates of the opposite sign. But man did partake of the tree of good and evil, through the advice of Eve; and thus the woman in the sky still holds the palm branch in her hand.

The sign Virgo, however, has rule not merely over gardens where dates grow on palm trees, but over labor and harvests of all kinds. Therefore, when Adam, and the woman who was called Eve because she was the mother of all living, were thrust from the parental environment to shift for themselves, it was said that in order to live they must till the fields and raise crops, not all of which would be wheat, as thorns and thistles also are mentioned. Furthermore, to keep warm they had to make clothing.

All of these things required just such labor as the zodiacal sign rules; and people still sweat to get the bread they eat; such bread as is signified by the ears of wheat held in celestial Virgo's hand.

It seems, from what is said in this third chapter of Genesis, that before man partook of the fruit which Eve offered him he was unable to distinguish good from evil. This same fruit is characteristic of this section of the sky, for Virgo, more than any other sign, confers the ability to discriminate. In fact, the Key-phrase for the sign is, **I Analyze.**

People born when the Sun is in Virgo are inveterate askers of questions, always wanting to know how things work. It was quite in character, therefore, that Eve should discuss the merits of the tree with the serpent, or with anyone else who would talk with her about it. She wanted to know all there was to know about the tree and about everything else. And after talking it over with the serpent she decided, after all, that the tree of knowledge was good for food, pleasant to the eyes, and to be desired as making one wise.

The implication is plain that she decided knowledge is worth all it costs. She paid the price, but she acquired that which Virgo most desires; for after they had eaten, the Lord God said, "Behold, the man is become as one of us, to know good and evil."

There are many things that man inherits, many things that come as gifts without cost, but knowledge is not one of them. No one can be given knowledge; it must be acquired. And the only method of acquiring it is through a process similar to that which Adam and Eve and their offspring followed after eating of the so-called forbidden fruit. That is, through a wide variety of contrasting experiences.

There is but one basis for consciousness, and that is the perception of relations. Whenever the mind, or soul, is unaware of relations it is in a state of coma.

In order for the soul to be aware of those relations which make it conscious, it must contact relative conditions. Such relative conditions are present only in association with substance. And to the extent the experiences have wide diversity in kind, and great range in intensity do they afford the materials out of which knowledge may be acquired.

We can know nothing whatever of coldness apart from our experiences with things which vary in degree of heat which they possess. We can know nothing of sweetness apart from our experiences with things which are less sweet and more sweet. If we have had some experience with that which is bitter and that which is sour, it gives us a better knowledge of the significance of sweetness when we contact it.

Our knowledge can be widened through reading books, or by hearing of the experiences of others. But this is only possible to the extent we have had experiences of our own, in contact with substance, with which to compare the experiences and information related to us.

The soul before its incarnation on the physical plane is depicted as Adam, without knowledge or responsibility, and, therefore, in a state bordering on unconsciousness. If it was to acquire that wisdom expressed in the Bible, "And the Lord God said, Behold, the man is become as one of us, to know good and evil," it had to have a broad basis of experience upon which to build. The entrance into physical conditions gave it the opportunity for such acquisition.

We have here, consequently, the answer to the so frequently asked question why man must undergo incarnation in physical form, must work and struggle, must have pain and hardship, and go through other experiences. Without such experiences he could not acquire the knowledge and power which enables him to participate in divine attributes. Such participation is clearly set forth in the Bible when it states that man was made in the image of God.

Everyone, of course, is quite familiar with the story of the immaculate conception, and how the Virgin Mother, warned of the enmity of Herod, fled for a time into the land of Egypt. And a somewhat similar mother was honored in various ancient lands long before the Christian era, and was pictured in the sky. In Egypt, for instance, where she was called Isis, there were yearly pageants in her honor, with processions of virgins who carried sistrums in their hands.

In America during ceremonies of similar purport certain of the Indians on the sidelines, all during the dance, shake white gourds filled with seeds. These rattles, identical in shape and significance with the sistrum, are used to signify the mother principle, which was held in highest esteem as indicated by Virgo being pictured with the wings of an angel.

Furthermore, the Hopi Indian girl of marriageable age wears her hair carefully dressed on either side of her head in a form to represent a squash blossom. Such a flower symbolizes both that she is a virgin and that she has potentialities for motherhood. She is not permitted to wear this distinctive headdress after she marries.

This use of a flower to symbolize the potentialities of motherhood, curiously enough, is still retained, along with a wide variety of other symbolisms of the primitive people of America, in our playing cards. On the Queen of Spades, which is the card corresponding to the zodiacal sign Virgo, in addition to the blossom held in one hand, which is common to the other queens, she bears in her other a lighted torch, to indicate that she has conceived by the solar power, or if you prefer, by the Holy Ghost.

Egypt was ever considered by Bible characters as the land of darkness. And as the seed of squash and bean and corn which the Indian placed in the ground had to remain in hiding for a period before the earth could bring forth, and as the Virgin persecuted by Herod sojourned for a time in the dark land of Egypt, so also the Sun, immediately after its station in the sky pictured by the Virgin, must pass across to the dark half of the year for a time, where the nights are longer than the days.

Virgo is an earthy sign, and to those who understand the stellar doctrine, the Sun's entrance into this sign symbolizes the descent of the soul into matter. Such traditions are among the oldest in Egypt and Chaldea. Quetzalcoatl of the Aztecs was also thus virgin born, as was Montezuma-of the Pueblo Mojave and Apache Indians. Thus was it taught that Mother Earth is the place of the soul's gestation; and that after the preparatory development which is supplied by the earth—after it has partaken of the fruit of the tree of good and evil which alone enables it to acquire knowledge—it will be born into a more glorious life.

Furthermore, because this is the harvest sign, in addition to revealing the necessity of the trials and tribulations of earth to teach us wisdom, and that after such necessary preparation there will be a passing from the physical to be born into a new and better life on a higher plane, it teaches that as we sow so shall we reap.

At all times we are sowing in the soil of our own consciousness. We are building thoughts into ourselves of various kinds. These thought-cells, in turn, when sufficient energy has been supplied them to give them strength, work to attract events of a similar quality into the life. The text therefore becomes: **If a Man Sows Discordant Thoughts He Will Reap Painful Experiences, But if He Sows Thoughts of Harmony He Will Garner Success and Happiness.**

Ariadne Gives Theseus a Clew of Thread

— When viewing Bootes, the Husbandman in the sky, picturing the harvest-decanate of the harvest sign, through which the Sun passes each year from **August 23 to September 2**, one can not but wonder once again how much must be attributed to coincidence, and how much of ancient lore was actual knowledge. The chief star in the constellation is mentioned in Job 38:32, “Canst thou bring forth Mazzaroth in his season? or canst thou guide Arcturus with his sons?”, as if, like turning the zodiac to bring any desired season, the control of Arcturus were an impossible task.

We are hardly warranted, I suppose, in believing that the ancients knew anything of the terrific speed with which a few of the stars travel. Yet Arcturus is classified as one of those “runaway stars” which have a speed so great, according to Simon Newcomb, the great astronomer, as to be beyond control of the other bodies in the firmament. Job might well ask about this swiftest of all the brighter stars, traveling 89 miles a second, or of the son, one of the stars of the Great Bear, which is smaller but moves at even greater speed, by what agency could they be guided.

Although Arcturus was chosen for another and quite as romantic reason to open the Century of Progress Exposition in Chicago in 1933, because this exposition was held in honor of, and to display, labor-saving devices and scientific progress garnered during the previous hundred years, no better star could have been selected to symbolize the exposition than this chief star in the constellation picturing the mental and harvest decanate of the mental and harvest sign Virgo.

Its speed is typical of the new forms of locomotion displayed in the exhibits. And in addition to the sickle which the Husbandman carries to indicate the reaping of the harvest, the spear which he holds in the other hand indicates that the devices thus acquired have slain, let us hope forever, the sweatshop Minotaur nourished by child labor.

The harvesting of the energy of Arcturus, rather than that of some rival in brilliancy, late in May, 1933, to close the switches that turned on the lights which formally opened the exposition, was prompted ostensibly by the circumstance that the light, which fell upon the photoelectric cells at the eye-end of the telescopes at four different observatories, left the Husbandman star at about the time the previous Chicago World's Fair was held in 1893.

From this miracle of modern science we can with advantage turn to the first miracle recorded by Saint John, the significance of which also, we may be sure, is revealed by its correspondence in the sky. Virgo, the sign of the mother, is adjacent to Libra, the sign of marriage. And it will be remembered that the mother of Jesus attended a marriage. Servants also are ruled by Virgo and His mother instructed the servants to do whatever He should ask of them.

In its annual circuit of the heavens, as indicated by Bootes, the keeper of the vineyard, it is when the Sun enters Virgo that the harvest ripens and the water drawn from the earth into the grapes swelling on the vine is converted into juice which is suitable for wine. The decanate thus pictured by the Vineyardist is the earthy-decanate of an earthy sign, and thus closely allied to stone. As Virgo also is the sixth sign of the zodiac, the six water-pots of stone which Jesus commanded the servants to fill with water, and which He converted into wine of excellent flavor, indicate that this event, and those transformations within the character of man which correspond to it, are pictured by the constellation Bootes.

Thus the turning of water into wine by the Sun each fall, and the miracle performed by Jesus, both convey a spiritual teaching. Even steep hillsides and rocky soil may be utilized in raising grapes. So also, even when circumstances offer scant footing, and hard, rough obstacles are on every hand, it is possible to cultivate the finest traits of character.

Jesus did not ask the servants to go to the village and get some special materials out of which to make the wine. He used that which already was at hand. Nor is it necessary for those who develop the powers of their souls to seek special settings or unusual circumstances. All the materials necessary for the finest flavor of soul growth are everywhere present; and can be changed into spiritual qualities of the finest vintage.

In fact, even as the wine which Jesus formed out of what happened to be handy was of finer flavor than that which had been made under special conditions, so the spiritual qualities which can be derived from the proper attitude toward everyday experiences are of superior merit to those acquired through going into retirement or amid other surroundings which many consider most favorable to their development.

While the constellation Bootes thus explains the significance of the miracle of changing water into wine in six pots of stone, this miracle does not reveal the significance of the spear which the Vineyardist holds in one of his hands. Its meaning can better be comprehended through a story from the Greeks, a story in which also a woman, typical of celestial Virgo, takes a prominent part.

It seems that in the time of Minos, second king of Crete, there was a monster, half Bull and half Man, called the Minotaur, which was confined in a celebrated labyrinth. The Bull part, of course, refers to the rule of Taurus over money, and the Man part to the science and knowledge of Aquarius. In modern words, it was the monster of commercial exploitation.

To keep this monster pacified it was necessary each year to import some of the fairest youths and maidens from Athens for the Minotaur to devour. Among one such consignment of Athenian youths sent to the island was Theseus, who already had been successful in catching and killing, in his home land, a wild bull, called the Bull of Marathon. He had made up his mind to get rid of this Cretan monster also; and it was for this purpose that as Bootes he carries the spear which is pictured in the sky.

But just as at the present day the whole problem of money is involved in a maze of conflicting doctrines and opinions, from which the most skilled economists seem unable to free the world, so a problem of equal importance to vanquishing the greedy Minotaur was that of being able to find the way out of the labyrinth once the monster had been slain. It was a difficulty which gravely puzzled Theseus.

It so happened, however, that Minos, king of Crete, had a daughter, Ariadne, who fell in love with Theseus as soon as he landed on Cretan soil. Pictured as Virgo in the sky, she had the Virgo trait of keen analysis. And it was she who devised the means by which, should her sweetheart triumph in his conflict underground, he should not wander about in the maze of bewildering caverns until he starved, but would be able to find his way back into the light of day.

She furnished him with a clew of thread—an incident which to this day makes the term clue significant of a hint which followed leads to the solution of a mystery or an intricate problem—one end of which she fastened at the opening of the cave. As he descended the long and tortuous passage he unwound the thread. As was to be expected, after a time he encountered the vicious Minotaur, which rushed suddenly upon him. But he was armed with the spear, which still he carries in the sky, and after a terrific battle the monster was slain.

Then came the task of finding his way back to where his beloved Ariadne anxiously awaited him. Carefully, as he walked and as he climbed over jagged rocks and

worked around corners where the network of passages interlaced, he reeled in the line, ever following it through the darkness, never losing the sense of its touch.

Great was the joy of Ariadne when at last he appeared again above the ground, and great was the joy of the Athenians, who no longer would be compelled to sacrifice the fairest youths of their land to the demands of this hideous creature.

But is not every individual faced with very much the same type of conflict which confronted Theseus? Very few, indeed, are free from the attack of economic necessity. Nor can one remain passive and expect to escape unscathed. Financial demands are not to be ignored; they must be met, and it is better to meet them courageously, as Theseus did, with the spear of critical analysis, which is a weapon specially designed for those born when the Sun is in this Bootes section of the sky.

Are we not all confined, as Theseus was, within a labyrinth of conflicting doctrines? Most of these are blind passages, leading nowhere through the dark. Theories abound, crisscrossing each other in a network so intricate that unless one has some clue to guide one to the light, about all that can be done is just to wander about. amid darkness and confusion.

The Key-word for the decanate is **Achievement**; and the achievements of Theseus were great; but they were made possible only by that clew of thread which is the chief Virgo attribute, that is, by the power of discrimination. It is only through exercising the powers of discrimination to the utmost, only by following the thread thus discerned through careful analysis, that gradually one can extricate himself from the darkness and the confusion of false paths, to emerge into the full light of Truth.

It is this faculty which may be used to guide one through the intricate passages of life, which also can be used to determine the possibilities of the experiences encountered along the way.

Whatever the events that may be attracted into the life, it is possible to convert them into real values for the soul. The meeting of obstacles may be used to develop initiative and resourcefulness. The losses which occur may be used to build up fortitude. Difficulties when overcome teach how responsibilities can be carried. And thus each experience holds a lesson which can be used in later achievement.

Bearing upon these lessons the text associated with the constellation is: **From Every Event of Life the Soul May Extract Value, Even as the Verdant Vine Transforms Indifferent Waters into Rich and Sparkling Wine.**

The Twelve Labors of Hercules

—One of the common tenets of astrology, ancient and modern, is that the influence of Saturn tends to attract work and heavy responsibilities. When, therefore, those of the olden time wished to comment in terms of universal symbolism upon the importance of labor, it is quite consistent that for the purpose they selected the Saturn-decanate of the sign of labor. The Sun moves through this middle-decanate of Virgo from **September 3 to September 13**.

Following the method of universal symbolism still further, which demands that the big influences in life shall be portrayed by equally large pictures, they traced, to represent that labor is essential to all worthwhile accomplishment, a man of heroic proportions in the sky. Hercules, mightiest of all the laboring men, has a constellation of vast extent.

Like Samson, who toiled grinding the grain held in the hand of Virgo while he was in the prison house, Hercules was successful in a number of valorous exploits, and was led to ultimate disaster through an unfortunate love affair. Like Samson also, whose final triumph was aided by two pillars, against which he pushed, placing one hand on each; the two pillars of Hercules perform a function in the Greek version of the ancient story. But the chief claim to renown was the performance by Hercules of his twelve great, and self-imposed, labors.

No sign of the zodiac is bad, and no sign of the zodiac is good. No one sign can be singled out as better or worse than the rest. Each has its own special possibilities for good and its own special possibilities for evil. Every sign has its best qualities and its worst qualities, which are different than the best qualities and the worst qualities of other signs.

Thus is the work required of those born under the influence of each sign different than that required of those born under the other signs; but in all cases it consists of diverting the energies which might manifest through the less desirable qualities of the sign into channels which enable them to express through the better qualities of the sign.

The best quality and the worst quality of any sign express the same general type of energy; but express it through different avenues. It is almost, or quite, impossible to convert the type of energy or the character qualifications denoted by one sign into those of another sign. But it is not a difficult matter to divert the undesirable expression of the energy or character into the desirable expression of the energy or character of the same sign. This is the work which Hercules undertook, and accomplished.

As there are twelve different signs, representing the deep-seated characteristics of the twelve different types of people, and as Hercules undertook to demonstrate how the worst quality could be diverted into the best quality for each of these types, he thus had twelve different labors to perform before he had finished.

While these twelve great labors, which illustrate to the individual how to convert the weaknesses peculiar to his character into expressions of strength, are the most

noteworthy tasks accomplished by Hercules, he had a wide variety of experiences in connection with other endeavors.

It is through experience that man learns how to do things. And as the experiences of Hercules in performing his numerous tasks were so extensive, the Key-word given to this section of the sky is **Experience**. Those born while the Sun is in this decanate usually have a wide range of happenings in their lives.

If a day were to be set aside from all the year to honor the sacredness of work, to be correct in its astrological correspondence, it would have to be one of those during which the Sun is in the Hercules section of the zodiac. If, instead, festivities were instituted to eulogize political personages, we should expect them to be observed on Sunday. If they were to encourage art, we should expect Friday to be selected. Thursday would be more fitting to celebrate the attainment of wealth.

But the Moon rules the common people; those who sweat and toil and hope for jobs; and thus Labor Day falls on Monday, the day of the Moon, while the Sun is in that section of the sky pictured by the greatest toiler of which we have tradition.

Although Samson slew a thousand men with the jawbone of an ass, perhaps the most remarkable of his works was his use of foxes to destroy the crops of those who had treated him unjustly. Foxes, of course, in ancient times as well as in those more modern, are universal symbols of shrewdness and cunning.

When the cunning of one nation is pitted against the cunning of another, or shrewdness against shrewdness, as often we have witnessed the efforts of people, each to gain an unfair advantage over the other, there is sure to be ultimate disaster. The inevitableness of the destruction of the fruits of human labor which follows such antagonisms, either among people or among the thought-groups within the finer body of man, is well illustrated in the story of Samson's foxes.

It seems that the Philistines were harvesting their grain; some of it still standing and some of it cut and placed in shocks. To avenge himself upon them Samson caught 300 foxes, paired them off, with the tails of each two united by a firebrand one end of which was tied to each of the tails.

The worst quality of the sign Virgo, of which Samson represents the middle decanate, is criticism. And the mental qualifications for keen criticism, as well as those for unfair bargaining, are well represented by a fox. Criticism, however, may be either constructive or destructive. It may point out a more advantageous way of doing something, a better line of conduct to be followed, in which case if the criticism is sound it may be helpful and constructive.

On the other hand, more frequently than not, pointing out weaknesses without indicating how they may be strengthened, and fault-finding in general. This type of criticism often is engaged in by political opponents, by factions within an organization, and by people in their domestic associations.

When people are subject to such destructive criticism they are likely to reply in kind, and the heat of the controversy may be like a burning brand between them; the final consequences, so far as destructive to the fruit of labor, being quite similar to that so vividly described in the Bible as the result when Samson lighted the firebrands between the tails of the foxes and turned them loose.

The foxes ran frantically through the standing grain setting it afire. They tried to find shelter in the shocks of grain that had been cut and awaited to be taken to the threshing floor. And when the fields were thus ablaze they fled to the vineyards and olive groves hoping to find refuge from their torture. Instead, these also were ignited, so that the crops of the year, of all kinds, went up in flames. Nothing was left to the Philistines to show for their toil.

Such is the observed result of destructive criticism. It kindles the fires of hatred and destroys whatever labor already has accomplished. It is a consuming influence which leaves nothing in its wake but bitter ashes. And it is just as destructive when directed against self as when applied to the endeavors of others.

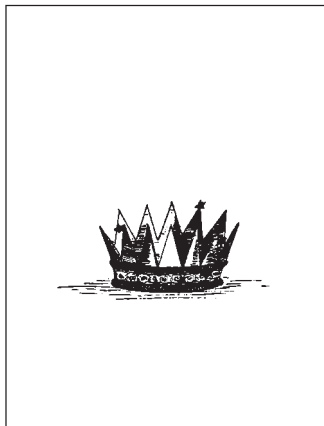

CORONABERE Renunciation

Figure 7-1

Third Decanate of Virgo

The constant calling attention to the faults and imperfections of any person, including oneself, brings the image of the undesirable action or quality before the unconscious mind. When we think about a thing we are supplying it with thought-energy. Therefore, the more we think about an undesirable thing the stronger it becomes within our unconscious mind. Traits of character feed upon the attention given them.

This does not signify, of course, that we should ignore our weaknesses nor neglect to strengthen them. But finding fault, especially when such criticism arouses an emotional reaction, merely impresses the defect more strongly, through the power of suggestion, upon the unconscious mind, and makes it more difficult to overcome. Children who are continually criticized by their parents are receiving strong suggestions which increase the difficulty of adhering to a better line of conduct. And, likewise, the more we find fault with ourselves, the more we feel dissatisfied with ourselves the more powerful becomes the thing within ourselves which causes the

dissatisfaction. If it gains enough strength through such internal dissension a consuming fire is lighted within which, like Samson's foxes, destroys the fruit of effort.

Constructive criticism, on the other hand, while recognizing a weakness as such, or that a type of conduct is unworthy, does not dwell upon this aspect of the matter. Instead, it concentrates its attention and energy upon the correct line of conduct or the proper way to strengthen the observed weakness. The thought-energy thus flows into and feeds the action which is desired instead of its opposite. In this manner not only is the mental image of the thing desired strengthened, but the image of the undesired thing is weakened through lack of thought nourishment.

In self-culture it is quite as important to feel satisfaction when the best is done as to recognize when one is living below one's possibilities. If more is expected than lies within the powers to accomplish, there will be certain failure and accompanying dissatisfaction. This feeling, in turn, directs energy into channels which are destructive, and lessens the ability in the future.

On the other hand, it is quite as easy for some individuals to feel that they are living up to their possibilities when they are living far below them. Their appraisal of their abilities is too low, and they have a feeling of satisfaction from accomplishment which is much less than it should be. Yet even this does not signify that they should be critical of themselves in the destructive sense; but merely that they should recognize that they should strive for a more lofty goal.

Because we learn to do through effort directed at accomplishment the text is: **Perform Conscientiously Whatever Work Comes to Thy Hand, and Because of Thy Experience, Greater Things to Perform Will Be Given Thee.**

How Job Triumphed Over His Afflictions

— Because illness and affliction so frequently burden the life of man we have a right to expect that those who formulated the spiritual doctrines of the past, which were intended to explain the significance of events and how to take advantage of them, should have commented on these tribulations in their symbolic writing in the sky.

It is true that the constellation Virgo, and the story of the punishment of Eve for partaking of the tree of experience which conferred knowledge set forth in sufficient detail the advantages of material incarnation with its variegated contacts, including labor and displeasures. But it would seem that trials and pain were sufficiently important in the lives of most that they should receive more explicit mention; and this they do, for the last decanate of the harvest sign gives them vivid portrayal.

Let us in imagination place ourselves in the position of those who drew the pictured figures in the heavens, and consider that it was their intention to symbolize in most fitting fashion the tribulations which beset most lives. First of all, the most appropriate section of the zodiac must be chosen, and in making this selection the tenets of practical astrology would be consulted.

Virgo in a natural birth-chart rules the house that governs not only work, but also illness and servitude, the most common afflictions of human life. When the Sun is in this sign it is moving toward the Autumnal Equinox where days and nights are equal, and after crossing which the forces of death prevail and the nights become longer than the days. The forces of Light are still triumphant while the Sun remains in any part of Virgo, but the closer the Sun draws to the next sign, Libra, the weaker becomes the power of Day, and the more is Night able to inflict its encroaching power of evil upon the solar waning strength.

The last decanate of Virgo, where the Sun may be found from **September 13 to September 23**, therefore, is the most appropriate place in all the zodiac to represent the afflictions to which man is heir, and his persecution at the hand of fate. The writer of Revelation seems to have recognized this when he speaks of the pain accompanying birth, commencing the 12th chapter thus: "And there appeared a great wonder in heaven; a woman clothed with the sun, and the moon under her feet, and upon her head a crown of twelve stars."

Having selected the place of tribulation in the zodiac, if it were desired to indicate that the proper attitude toward such afflictions would adequately be rewarded, the next step in starry portrayal would be the selection of some object significant of high honors attained. A crown is such an object, used throughout the ages as a reward for victory or as a mark of distinction. Thus was it used to denote the triumph over the afflictions symbolically associated with this last decanate of the summer signs.

Bearing in mind that the Sun takes just ten days to pass through this decanate of tribulations pictured by a crown, not of twelve stars, as poetically expressed by St. John the Divine, but of twelve iron spikes, it would be difficult to explain the significance of this section of the zodiac, or the ancient teachings regarding it, more concisely than he did in Revelation 2:10.

"Fear none of those things which thou shalt suffer; behold the devil shall cast some of you into prison, that ye may be tried; and ye shall have tribulation ten days: be thou faithful unto death, and I will give thee a crown of life."

It is unnecessary here more than merely to point out that the Sun each year dies on the Autumnal Cross of Libra, even as the Son of Man gave up His life on Calvary; or that preceding this far-reaching tragedy the gentle Nazarene was vilely persecuted and made to wear a crown of thorns, of similar purport to Corona Borealis placed by the ancients in the sky to mark the tribulations of the Sun before it temporarily succumbs each year to the forces of darkness.

The fruits of life, whether they be tares or wholesome grain, are harvested from experience. What that harvest shall be is not determined by the nature of the experiences, but by the mental and emotional reaction toward them; for both the physical conditions attracted in the future, and the spiritual values garnered, are dependent upon the seeds of thought thus sown and tended in the finer form and heading into character. In the final winnowing all except the golden grain of character is blown away as tares and chaff.

Constellated Virgo teaches the advantage of physical life if man is to acquire that variety of experience which enables him to gain wisdom. In addition to the character weaknesses of each sign, which Hercules shows how to overcome, each zodiacal sign also is associated with its own particular type of affliction.

The illness that one sign brings is not the same as that indicated by another. The loss attracted by one sign when it is discordant, is not the same type of loss which another sign brings when acting as an affliction. Thus are there twelve different sets of

difficulties attracted from without which man should understand.

To represent these, the crown used to picture the reward of character triumphing over tribulations was given twelve spikes of hard, unyielding iron; one spike for each type of affliction. Such is the significance of Corona Borealis.

Because the call of duty so frequently when followed leads to the relinquishment of fond desires, and because those born while the Sun is in this last decanate of Virgo so frequently must hear this call, the Key-word appropriately is **Renunciation**.

One whole book within the Bible is devoted exclusively to a discussion of the spiritual teachings which those still more ancient sought to picture as the Northern Crown. In the Book of Job many wise sayings relative to life and its problems can be found; and the story of the afflicted hero is replete with sage advice.

Job was an unusually devout man who had prospered exceedingly in all ways and gave constant praise to God for his many blessings. But there came a day when the sons of God came before the Lord, and as so frequently happens on earth when good people gather together, Satan came among them “And the Lord said unto Satan, Whence comest thou? Then Satan answered the Lord, and said, From going to and fro in the earth, and from walking up and down in it.” Thus was such an answer given as might be expected at this day.

In the course of the conversation which followed, the Lord pointed out to Satan what a fine, upstanding man Job had proved to be. But Satan, like some people, who glory in tearing apart the merits of all who receive commendation, was unwilling to admit the worthiness of anyone. He contended that Job was a good man because the Lord had taken care of him and given him everything he wanted; but that if these things were taken from him his holiness would soon depart. So it was arranged that a test be made, with Satan to have power over him in all ways except that he must not touch his body.

Thereupon, in one catastrophe after another, Job lost his property and his children, until he had nothing left. But with the wisdom of those conversant with Spiritual Alchemy he maintained that these things were merely given to him to use so long as it served the Lord's good purpose.

Satan was much chagrined at the outcome of the trial, and as might be expected of Satan, he whined around that it had not been a fair trial, that in any proper test the man's health also must be subject to affliction, for, after all, it was not much of a blow, no matter what a man lost, so long as he kept hearty and well.

Thus was it arranged for a second trial in which Satan should do anything he desired to Job so long only as he spared his life. Then it was that Job's friends turned against him, that he broke out from head to foot with boils, and that one misery after another came to afflict him, and in his wisdom he gave voice, among other things, to this oft' quoted thought:

“For the thing which I greatly feared is come upon me, and that which I was afraid of is come unto me.”

In addition to the chemical reaction to the emotion of fear, which in Job’s case seems to have depleted his adrenaline supply to a point where he was unable to resist infection, to fear a thing is to hold its image vividly in the mind and to feed that image mental energy. It thus creates a thought-form which has a certain power, acting from the four-dimensional plane, to attract into the life the thing thus thought about.

In his time of affliction Job’s friends held forth the oriental doctrine that man’s lot in this world is determined by his morality, and that the Lord must be punishing him thus for grievous sins. But Job held that even the afflictions he suffered were for some good purpose.

If individuals are undergoing training to fit them each for a different function in the cosmic organization, each will attract to himself just those experiences he needs to develop the required abilities. Accomplishment of any kind implies the ability to overcome difficulties. People who have never had hard problems to solve are unable to solve hard problems when suddenly presented.

Afflictions, therefore, as Job discerned, are not bestowed by heaven to punish man for sin, but to indicate that he has a lesson to learn. When he has learned this lesson he will be able to triumph over the affliction, as Job did in the end; for Job was healed, and the Lord gave him twice as much as he had before, and he lived a long and prosperous life. The text thus indicated is: **He Who Would Live the Life of the Spirit, Here and Now Upon this Earth, Seen and Known of Men, Must Have Fortitude in Times of Adversity.**

Chapter 8

Serial No. 78
Original Copyright 1935
Elbert Benjamine

Copyright
Church of Light
August 2002

The Marriage in Heaven

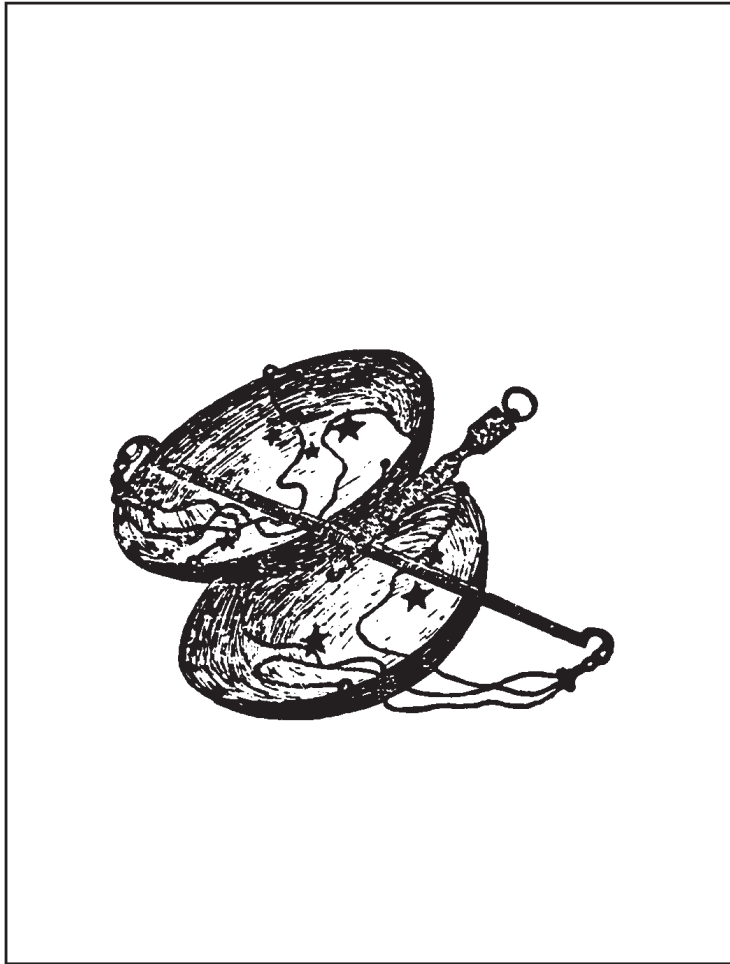

LIBRA



I Balance

Figure 8-1

Zodiacal Sign Libra

Chapter 8

The Marriage in Heaven

In the Judgment Day

— Sacred literature from various lands makes us familiar with the idea of a day of judgment on which the kindlier deeds are weighed against those harsh to determine the rewards of the soul in the after-life. Almost every religion teaches that in proportion to man's adherence to its moral code shall his future be free from tribulation.

To picture in the sky this process of weighing the good against the evil, no more easily recognized symbol could be found than the Scales. But in addition to the purpose of their use, the Scales also present to view two dissimilar entities united by a common purpose; two spirits, as it were, represented by the circular pans, each dangling free to move in its independent orbit, yet both united by the beam to which they are attached. The Scales, therefore, is also a most fitting universal symbol of marriage. Those who so carefully traced the constellated glories in the sky to make this universal symbolism still more obvious and complete, would also seek to place the picture in such relation to the zodiac that the position of the Sun at the point so designated, should both indicate a union representing marriage and a balance of two nearly equal, but divergent forces.

The most familiar union, and the most familiar balance between contending forces, are night and day. So common to our lives are they that they space and regulate the hours of our endeavor. We awaken and we sleep at their behest. Light becomes a symbol of life and activity, and darkness of sleep or death.

Those days in which the hours of darkness exceed the hours of light may well, therefore, be placed in one pan of the annual scales, and those in which the hours of light preponderate may fill the other. Thus day and night are weighed in Libra's Scales; and the Autumnal Equinox marks the point where summer and winter signs are married, one-half the zodiac balanced against the other.

The Sun thus moves out of the harvest sign where the grain was cut, into the place where it shall be valued. The Produce of the fruitful period of the year is weighed, and the wholesome kernels are separated from the chaff. Such estimating of its worth, either of crops from the field or those from the span of life, most fittingly takes place

when the vital forces, as symbolized by the Sun, have succumbed to those of cold and darkness.

The Jewish people, retaining the old time significance of this period of the year—although their calendar in modern times has been permitted somewhat to go astray—still honor the passing of the Sun each year into the sign of the Scales. This custom dates back to Leviticus 24, where it is commanded “Speak unto the Children of Israel, saying, In the seventh month in the first day of the month, shall ye have a Sabbath, a memorial of blowing of trumpets, and holy convocation.” The year, of course, began with the Vernal Equinox, and Rosh-ha-Shanah is thus held the first of Tishri, or Libra.

As the day is still religiously observed, a quotation from the Jewish Encyclopedia in reference to its significance will not be amiss:

“Rosh-ha-Shanah is the most important judgment day, in which all the inhabitants of the world pass for judgment before the creator as sheep pass for examination before the shepherd. Three books of accounts are opened on Rosh-ha-Shanah wherein the fate of the wicked, the righteous, and those of the intermediate class are recorded. The names of the righteous are immediately inscribed, and are sealed ‘to live.’ The middle class are allowed a respite of ten days till Yom Kippur to repent and become righteous; the wicked are blotted out of the book of the living.”

One of the most important qualities of the human mind is the ability to weigh evidence and from a comparison of diverse factors to pass sound judgment. Every day of our lives we are called upon to make minor decisions, if of no greater importance than the amount and kind of food to be eaten, and on rare occasions to pass judgment which affects the fate of human lives.

In racial tradition, one man above all others stands out as the symbol of unusual wisdom. As wise as Solomon, has come to express the very essence of discrimination; and while this Jewish king exhibited the keenness of his mind on many another occasion, it was a certain decision he rendered which first proclaimed that the wisdom of God was in him. It related to two contending women who stood before him for judgment.

Without doubt this is the most famous trial in the whole of human history.

To understand its celestial significance it must be recalled that the sign of the harvest, Virgo, pictures an unmarried woman, and that she stands in the sky immediately before the Scales where judgment must be passed. Where the Sun passes from Virgo into the sign of the Scales, as previously indicated, is where the wheat is separated from the chaff and the value of the harvest ascertained.

Thus were there brought before Solomon two unmarried women, each of whom, nevertheless, had had a child. Yet as in threshing there is both sound wheat and worthless chaff, so was the harvest, or child, of one woman alive, and the child of the other woman dead.

According to the story related to Solomon, the two women lived together in one house which certainly must have been the case if both were phases of Virgo—and a child was born to each, the difference in the children's ages being but a matter of three days. Through the carelessness of one woman, the life of her child was crushed out in the darkness. This also is significant; for it is at this point that the Sun each year dies through the increasing weight of night.

One woman claimed it was the other woman's child who died, and that the other woman arose at midnight and finding her child dead, had stealthily removed the living child from the first woman's bosom, and replaced it with the child that had died. But when the light came in the morning, the woman who had remained asleep, finding the child in her arms dead, also perceived that it was not her own, but the child of her companion in the house.

This story and this accusation the other woman stoutly denied; and both women loudly proclaimed the living harvest as her own. Thus stood they before King Solomon, each disputing the right of the other to the infant.

Summer and winter are divided, one from the other, not only at Libra, but also at Aries; an invisible line, called a colure, cutting the sky between the Vernal Equinox and the Equinox of Fall. The first of Aries marks the place where days and nights are equal in the spring, and the Scales marks where they are equal in the fall. And the sword held in the hand of Perseus has its tip almost on the line right across the sky from the judgment seat.

This militant sword of Aries often is used as the symbol of cutting asunder of the celestial circle in spring, just as the cross as frequently is used to signify the waning strength of the Sun in fall; and, after all, even as summer and winter are but inversions of the relation of night to day, so also in its form does a sword present the inversion of a cross.

Solomon, therefore, called for a sword to be brought to him and commanded, after the manner in which the equinoctial colure divides the zodiac at the point marked by the Scales, that the living child should be divided in two, one half to be given to one woman and the other half to the other.

To this procedure one woman readily agreed, but the other would not consent. Virgo, in human anatomy, rules the bowels, and the Bible states: "Then spake the woman whose the living child was unto the king, for her bowels yearned upon her son, and she said, O my lord, give her the living child, and in no wise slay it."

When she had said this, Solomon at once perceived that she was the real mother of the child, and the child was not slain, but awarded to her.

Libra is the home sign of Venus, the planet of love; and in his wisdom, Solomon weighed the love of the women who came before him, and, convinced that love seeks to preserve the object of its affection and not destroy, passed judgment accordingly. A life was not sacrificed, but delivered to its rightful owner.

It was this same doctrine that love lies at the foundation of life, here and hereafter, and that the harvest of years must eventually be judged on the basis of kindness and compassion, that in later days was set forth by the Nazarene as the commandment to his followers to love one another.

Turning now from the teaching in reference to judgment, it should be noted that in the marriage of summer and winter the forces are not exactly equal; for each year there are seven more days of preponderating light than of preponderating darkness. Evil certainly is present in the world, but if the celestial correspondence holds true, it is not of equal strength with the good. Like summer and winter, they may be closely balanced in power, but if we could look close enough we should find that in the long run the good has a little advantage, and that consequently the world does make spiritual progress.

And followed far enough, this doctrine set forth in the starry symbolism of the Scales, where the Sun may be found each year from **September 23 to October 23**, reveals the use of evil, as well as signifying the paramount importance of love in human life.

The Key-phrase of this section of the sky is, **I Balance**. Those then born find a harmonious partnership especially important; and because in such a marriage spiritual qualities are engendered it gives this text: **Not By One Alone May the Highest of All Be Reached, But By Two United Souls Who Are Exalted By the Sweet Reverberations of Holy Love.**

Wisdom and the Serpent Fire

—At the side of Virgo, the celestial Eve, the wise men of the east pictured the serpent, which is reputed to have tempted her. Virgo joins Libra, the sign of marriage, and Serpens portrays the marriage-decanate of this marriage sign, through which the Sun moves each year from **September 23 to October 3**. It therefore represents, with a more precise significance, that point in the heavenly circle where summer and winter signs are joined in marriage.

When positive and negative forces thus fuse and blend, yet at the same time their opposite pull is not exactly balanced, action results which takes the spiral form. Because such a spiral does not return upon itself, as does a circle, it is the typical motion of evolution.

Thus it is that when the 179 days of winter darkness are married to the 186 days of summer light, the result is not a perfect equilibrium between ignorance and knowledge, but a spiral which ever rises, even though slowly, away from darkness and toward more light, much as the front spiral formed by Serpens in the sky lifts its head to a plane above its body.

Because of its wave-like motion of travel, its coiling, and its phallic significance, the snake has been used throughout the world as the symbol of virile power and creative action. Hence it came to be the emblem of the Sun, the source of such creative energy. Instead of using the head of a lion for the sign Leo, therefore, its accepted astronomical hieroglyphic is simply a conventionalized snake.

This serpent of the first decanate of the marriage sign, however, expresses something more than virility and desire; for near its head, and another near its tail, may be seen loops which present to view the spiral. It is indicated, therefore, that the creative powers have been used, or enter into a combination, to produce a form which tends to progress, or is retrogressive.

At all times the surface of the earth presents a marriage of light and shadow, one half being in the sunshine and the other half in night. Yet these areas of light and shadow are not constant, but move as the earth turns on its axis. Furthermore, due to the inclination of the earth's equator to the apparent path of the Sun, the lighted half of the surface of the earth moves to the northward half the year, and to the southward the other half, the perpendicular Sun tracing the outline of that spiral to which we owe the seasons.

Sun and Moon among the orbs are typical of the Father and Mother principle. While the Moon revolves around the earth, the earth revolves around the Sun, making the Moon's path not a circle, but a wavy line in form like that of Serpens in the sky. At New Moon the Sun and Moon are united, and from thence on things of earth expand and grow, the united Solar-Lunar energies working in the direction of progress, as indicated by the higher plane held by the Serpent's head. From Full Moon to New, having reached the region of divorce, things diminish and weaken, as indicated by the tail of the snake crossing a higher level than its body.

That which happens in the sky also must happen on the earth: and the two halves of the Moon's cycle in reference to her spouse, the Sun, represent two things common in marriage. The product of the union may be a force, or evolutionary movement, which carries the pair higher and higher in their spiritual aspirations and practical endeavors. Such is pictured in the constellation by the loop near the Serpent's head, which lifts it well above the body, where it is adjacent to the signs of light, the signs which mark the warmth of summer. Or it may result disintegratively, in a movement which carries them ever down to lower depths, as clearly shown by the loop far down in winter, which gives supremacy to the Serpent's tail.

The Far East brings us a doctrine of the serpent fire, and it is to be regretted that it has so greatly permeated our West, as many have suffered damage in trying to follow it. In reality, it is one of the questionable oriental temple practices. But when in Numbers 21, reference is made to fiery serpents, the obvious inference to be drawn is that the people Moses led likewise had contacted this serpent fire doctrine, which then as now was a common portion of the perverse temple practices of oriental priests.

The Israelites had journeyed from Mount Hor by way of the Red Sea, to make a detour around the land of Edom, and were bitterly discouraged. The manna on which they fed while wandering in this wilderness, because it fell from heaven, is symbol of spiritual nutriment. As such it well represents the spiritual food husband and wife feed each other in the form of loving thoughts and high ideals. It is thus in direct contrast to the selfish purposes for which the oriental priests arouse and use the serpent fire.

It would seem, therefore, as the story is given in the Bible, those led by Moses turned away from love and kindness and adopted the perverse notions of another race.

“And the people spake against God, and against Moses, Wherefore have ye brought us up out of Egypt to die in the wilderness? for there is no bread, neither is there any water: and our soul loatheth this light bread.

“And the Lord sent fiery serpents among the people, and they bit the people; and much people of Israel died.

“Then in their dire extremity, they turned once again to Moses and begged his help.

“And Moses made a serpent of brass, and put it upon a pole, and it came to pass, that if a serpent had bitten any man, when he beheld the serpent of brass, he lived.”

Because brass is a marriage, or fusion between copper, ruled by Venus, and another metal, the universal symbolism of many ancient lands made use of it to signify a union based on love. The brazen serpent, therefore, which Moses raised upon a pole, has the same significance as that other more precise scriptural passage; “Be ye therefore wise as serpents, and harmless as doves.”

It denotes that Moses taught his followers true wisdom in the use of the energies generated in marriage, and made them aware of the importance of love as the guiding principle, even as both doves and copper are under Venus’ rule.

So long as they sought to rouse and use the serpent fire for the attainment of selfish ambitions, they tuned in on the spiral loop pictured near the Serpent’s tail; and it carried them down to destruction and death. But when in wisdom they learned to utilize the powers engendered by holy love for the attainment of lofty aspirations and human betterment, they tuned in on the spiral loop pictured near the Serpent’s head, and it lifted them up, higher and ever higher, into those regions of spiritual life denoted by the adjacent signs of summer.

The utilization of this love principle for the advancement of the race was an important part of the Stellar Religion handed down from Atlantis and Mu which found its way to various peoples. But perhaps no others gave it the supreme importance as did the Maya of Mexico and Central America. As a dominant note of architecture, to be found on bas relief and balustrade wherever jungle permits the unearthing of a temple, there is to be found some representation of the feathered serpent.

Because birds fly above the earth, their feathers became the symbol of that which belonged to the spiritual plane. Therefore to portray the thought expressed in the sky by the loop near Serpent's head, the Maya adorned a snake with feathers. In such a manner, even as did the brazen serpent raised on a pole above the sordid earth of the wilderness, did they symbolize that the energies of marriage were to be devoted to the development of spiritual powers and nobler characters; to indicate, that is, that the Serpent moves in a higher, more idealistic realm.

In any marriage which is real, the closeness of companionship adjusts the vibratory rates of each quite completely to the other. A condition is maintained which commonly is called rapport, each, that is, tuned in upon the other. Thus do the thoughts and desires flow freely back and forth, each feeding the mate with spiritual food or spiritual poison.

In any form of mental treatment, the image held in the mind of the person sending the thought is impressed upon the person receiving, and tends to make changes in the pattern of his life and actions according to its design. This is the fundamental principle in all forms of absent or other mental healing.

If, therefore, the image held in the mind of the mate is an ideal, embodying nobler, more spiritual attributes, and this image is constantly vitalized by the emotional energy of a tender and adoring love, it becomes the most powerful influence known to develop, in the one thus treated, the spiritual attributes of character. And when each, in marriage, thus holds the image of the other in higher states than this, the spiritual evolution of both is vastly hastened and a high development of character assured. This was the teaching of the feathered serpent.

But on the other hand, when married partners live in an attitude of finding fault, each with the other: when bitterness and strife creep in, and their thoughts go forth in resentment and discord, the one receiving the image thus vitalized is powerfully influenced toward developing the obnoxious traits thus mirrored, and the inharmonious forces injected into his finer form tend to disrupt and lead to failure and moral dissolution.

As picturing the balance-decanate of the sign of the balances, Serpens relates to marriage of opinions as well as to the marriage of people. Usually in any vital issue the views of opposite factions are extreme. Usually also, where there is strong contention, a compromise is more satisfactory than the triumph of either. This gives to the decanate its Key-word, **Policy**, and leads to the text: **In Matters of Philosophy and in Matters of Action the True Course Usually Lies Somewhere Between Advocated Extremes.**

The Battle With the Dragon

—Krishna of India, according to the legends of that land, sought out and slew a noisome dragon whose poisonous breath withered the crops, bred famine, and whose movements through the countryside left death and destruction in its wake. In

legendary Christendom it was St. George who played the role of valiant hero, and after long and violent battle, succeeded in leaping on the back of the scaly monster and driving his great two-handed sword straight through its wicked heart.

As Draco, this vicious creature from out the vastness of the past still is pictured in the northern sky, winding its slimy length with a turn about the Pole Star as if to strangle Truth, and with another turn about the ecliptic pole, in a mighty endeavor, it would seem, to wrench the Sun from its more accustomed path. So fearsome is it to the sight that nothing else is needed to convince it symbolizes nothing good; and this first impression is further verified by the explanation set forth in Revelation, 20.

“And I saw an angel come down from heaven, and having the key of the bottomless pit and a great chain in his hand. And he laid hold on the dragon, that old serpent, which is the Devil, and Satan, and bound him a thousand years, And cast him into the bottomless pit, and shut him up, and set a seal upon him, that he should deceive the nations no more, till the thousand years should be fulfilled: and after that he must be loosed a little season.”

This word, Satan, is derived from Saturn, the planet having special affinity for loss and sorrow, for evil and selfishness, for despair and desolation. It has its exaltation in the Libra sign, of which the middle decanate is pictured by the starry Dragon, and olden people held that his home domain was the bottomless pit, where his victims stewed amid the smoke and heat of a never-ceasing fire of smoldering brimstone.

As it is a decanate of the sign of marriage which the Dragon pictures, it is quite obvious that universal symbolism points to some destructive union, both in the sky and on the earth, as the influence which the pictured reptile thus explains. Nor is its heavenly significance far to seek; as not only in ancient times, but at the present day, the ephemeris gives the positions of the Nodes of the Moon, which still more commonly are called, the Dragon's Head and the Dragon's Tail.

The Moon in its orbit around the earth does not follow the same path which apparently is taken by the Sun. This apparent path of the Sun is called the ecliptic. The orbit of the Moon is at an angle of a little more than 5 degrees to the ecliptic, so that even when the Sun and Moon are exactly in the same zodiacal degree, the same east-west position, they may still be several degrees apart in a north-south direction. As the diameter of the Sun or Moon is only about half a degree, the effect, so far as a shadow is concerned, is as if an object were slightly west of a house in the morning, but ten times the width of the house to the north or south of it.

The two points, or nodes, where the orbit of the Moon cuts the apparent orbit of the Sun are called the Dragon's Head and the Dragon's Tail. When the Sun in the zodiac is farther from the Dragon's Head or the Dragon's Tail than 13 degrees at the time of Full Moon, the Moon can not be eclipsed: but when it is within 9 degrees of either of these two places, a Lunar Eclipse must take place.

When the Sun at New Moon, that is, when Sun and Moon are married, is farther than 19 degrees from the Dragon's Head or the Dragon's Tail, no eclipse can take place; but when this union of Sun and Moon occurs within 15 degrees of either of these Nodes, a Solar Eclipse is always present.

Thus it is that the relation of the Sun to the Dragon's Head or Tail determines whether or not an eclipse takes place. And an eclipse, particularly an eclipse of the Sun, indicates some disaster in the region where it is visible. Symbolically, the Sun is then being devoured by the Dragon, or in case of a partial Eclipse, the Dragon gnaws at the disc of the Sun; a symbolism that is still taken literally by, and produces terror in, the more ignorant peoples of eastern lands.

In China, where the populace spend far more energy in ceremonies to prevent misfortune than in observances to attract the good, the most dramatic spectacle of the year is the pageant and play wherein the Dragon is met and finally vanquished. This oriental version of the St. George episode is a gorgeous affair, rich in setting, artistically presented.

As a precedent for the most approved of western plots, a fair damsel in distress arouses the sympathy of the gathered throng. This meek and virtuous maiden arrayed in loveliest silk, wears also decorations which proclaim her to be the goddess of the Moon, and as such the spectators give her welcome.

Not long is her lovely presence upon the stage, however, before disaster threatens. From his lurking place within the shadows, a huge and scaly monster writhes out; a Dragon, exhaling fire. The smell of burning sulphur fills the air. The Moon goddess flees in terror, but finds her retreat cut off. She is hemmed in, crowded into a corner, and the vile reptile's jaws have opened to seize her, when, with a shout and a rush, the hero comes upon the scene.

In raiment resplendent with glittering gems, he is dressed to take the part of the refulgent Sun. The Sun god dashes to the rescue, and the monster thus attacked turns its attention to him. The fumes stifle the hero, the smoke from the creature's nostrils blind him, the fire scorches his cheeks and the hair on his head. Terror grips the hearts of the spectators; for if the monster wins, the world is lost.

This demon from the pits of hell almost gets the hero down. The Moon goddess, from the corner where in dread she crouches, utters an awful scream. and holds her out-turned hand before her eyes to shut the too terrifying spectacle from her gaze! The fate of the universe is weighed in the balance!

But no! The hero only slipped, he is not completely down. He recovers himself, and with a mighty sidestep avoids the crushing weight, then vaults upon the scaly back and drives home his great two-handed sword.

The Dragon is dead. The Sun god is triumphant. He gathers to himself the lovely goddess of the Moon, marries her then and there, and they live happily ever after.

No less seriously do the Hopi Indians of Arizona consider the influence of the celestial Dragon. In their legends also, an eclipse is attributed to the Dragon devouring Sun or Moon. And their snake dance is the traditional ritual by which, among other things, the effect of a possible eclipse upon their crops can be avoided. They believe, as astrologers do, that where the shadow of a solar eclipse falls, is apt to be a region visited by pestilence, by catastrophe or by famine. And as their most frequent calamity is crop failure due to drought, their chief ceremony is staged particularly to prevent this evil.

A picture of the Hopi snake dance reveals that the reptile carried in the dancers' mouth is in form the same as the symbol commonly used for the Dragon's Head or Dragon's Tail. He does not hold it in his mouth while he dances to prove his bravery; but to symbolize the eating of the Sun or Moon by the Dragon.

The agriculture tribe who further south in Arizona built that famed house of many rooms, the pueblo of Casa Grande, also had a careful respect for the Dragon in the sky. The Sun is in the Independence-decanate of Libra, pictured by this monster, from **October 3 to October 13**. And a hole was bored, by this people, through the many walls to the interior of the vast dwelling, so aligned that the rising Sun on October 7, when in the Draco decanate, and again on March 7, when in the Andromeda decanate, would shine through and cast its beams upon the central sanctuary.

The union of Sun and Moon to ancient peoples was the symbol of the union of the Ego and the Soul, that is, of mind and spirit. The Moon has ever been the symbol of the indwelling soul. The Dragon, on the other hand, represents the environmental forces which tend to develop the reptilian traits of character, the cruel instincts and ruthless selfishness which shut out the light of spirit, and thus eclipse the soul. To the extent, therefore, an eclipse is total does it present a spectacle representing the soul or spirit devoured and destroyed by the powers of darkness associated with the struggle with physical environment.

We perceive now why Yom Kippur, which is ten days after Rosh-ha-Shanah, and thus when the Sun enters the Draco-decanate, is the most sacred of Jewish observances. Kippur means the atonement, the setting at one, the reconciliation of two parties, just as Sun and Moon are reconciled and united as one at New Moon, unless an eclipse is present. When there is an eclipse the light, or good, is devoured by darkness, or evil. This signifies the destruction of the soul, unless the powers of darkness and of evil, symbolized by the Dragon, are vanquished and the final atonement made.

The whole purpose of evolution, up to the state of man, is through combat with environmental conditions and the struggle for physical survival, to Develop the selfish instincts and the animal qualities of the soul. Difficulties are not overcome by weakness, nor is accomplishment made without aggression and courage. Those who permit the competitors for food, for mate and for shelter to force them to one side are not fulfilling the highest purpose of physical destiny.

But when, and to such extent as, the abilities and possibilities developed in the fierce struggle of its animal past are turned to purposes which have for interest the welfare of all, does that soul cease to function on the plane of brute, and rise to something which we term divine. It has thus triumphed over the Dragon, and its atonement is complete.

When it thus has reunited with its Ego, and the dark peril is past, it can find no joy in the pain or discomfort of any living thing. The text thus emerges: **Deal Justly, Even With Thy Enemies; For it is Better to Suffer Evil than to Retaliate With Vengeance**

Little Red Ridinghood

—When the masters of an ancient day traced a wolf in the sky it is quite certain they had in mind those qualities which then and now this creature most commonly is known to express. A wolf is a cunning beast, using its mind, as the mental-decanate of the partnership sign would indicate. It is aggressive and cruel, runs in packs when that is an advantage, and hesitates not to kill and devour such a partner when it becomes so weakened or crippled as to be unable to defend itself. Thus does a wolf stand as the universal symbol of ruthlessness.

Picturing that section of the celestial circle where the Sun may be found each year from **October 13 to October 23**, the Wolf, Lupus, is directly across the zodiac in antagonism to the Ram. Sheep thus constitute its natural prey, and to stalk them the predacious beast resorts to many a cunning device. At the time of year so designated the days are shorter than the hours of darkness, and wolves chiefly do their depredations under cover of the night. Although they are the terror of the shepherds, seldom are they to be seen in light of day, or do their killing in the open. Instead, they resort to subterfuge, which makes the passage of St. Matthew clear:

“Beware of false prophets, which come to you in sheep’s clothing, but inwardly they are ravening wolves.”

The best commentary which has come down to us, perhaps, as to the full significance of this Wolf of heaven, and what its teachings are, is to be found in the wide-spread and symbolical story of Little Red Ridinghood.

From your nursery days you will remember, I am sure, that the grandmother of this nice little girl was ill. As a dutiful granddaughter should, Little Red Ridinghood went to pay the old lady a visit, taking with her some cookies which she felt her ill relative would enjoy.

Little Red Ridinghood, quite unmistakably, as the hero of the tale, must represent the human soul. The grandmother who was ill, and whose house was by the road at the other side of the wood, represents those people in the world who suffer afflictions of various sorts, and who are too weak and helpless to be able to defend themselves. They thus are symbolized by a helpless woman because the Moon is the ruler of

women and of the Domestic Urges, those impulses which incline not merely to the care of home and children, but also to the care of the helpless old, and to ministering to such others as misfortune makes it impossible for them to care for themselves.

The road along which Red Ridinghood went, with her basket of cookies on her arm, ran through the forest of human contacts which flanks the path of every life. There were flowers, and butterflies, and beautiful birds to give interest and pleasure to her self-appointed task, and so full of joy was she with it all, that she sang a merry little melody as she danced along toward her work of mercy.

Then all at once, out from behind the bole of a giant tree where he had been hiding, stepped a wolf. Red Ridinghood was badly frightened, but she knew there was no use to run, as the wolf could easily overtake her. So she said, "Good morning Mister Wolf, what a fine day it is !"

And the Wolf, although very hungry, thought to himself: "Before I eat her, I will find out where she is going and what she intends to do, as this may lead me to something else I want."

So the Wolf said, "Good morning, and where are you going so happily, and what do you carry in that fine basket on your arm ?"

He spoke so pleasantly, as people are wont to do when they seek to gain the confidence of others, later to despoil them, that Red Ridinghood was quite disarmed, and thought she had misjudged him in her first impression that he was intent on evil. So she told the Wolf all about her grandmother, where she lived, and that there were cookies in the basket, which she was taking in the hope to give the dear old lady a better appetite.

The Wolf then thought to himself, as predatory people do, that it were better not to act too hastily, but to lay a cunning plan by which he might gain for himself every possible advantage, even though it meant more loss and misery to others.

The old lady, according to Red Ridinghood's account, was ill in bed and quite helpless. It would be an easy matter to make a meal from her, in the manner customary to his pack to kill and devour such members as became too weak to defend themselves. After that, he could wait for the little girl, get the cookies, and devour her too. In this manner, he would be able to gorge himself with food and more completely satisfy his lust for blood.

He therefore smiled at Red Ridinghood, bade her good day pleasantly, and started down the road in the opposite direction from which she was going, so that she should have no suspicion he had any thought of her harm. But as soon as he was out of her sight, he made a wide, swift detour through the forest back to the road ahead of her, and ran swiftly to the house, where he made the expected meal from the ill old lady.

It was not literally a case of a wolf in sheep's clothing, but figuratively it became so; for no sooner did he finish with grandmother and lick his bloody chops, than he donned her garments and climbed into bed to doze, all prepared to look as much like the late departed as possible.

When Little Red Ridinghood came to her grandmother's house, she knocked lightly on the door. This awakened the Wolf from his after dinner nap, and as soon as he had adjusted the white cap as nicely as possible on his head, he called, "Come in."

Said Little Red Ridinghood, as she entered the room, "My! Grandma, what a deep voice you have."

Replied the Wolf from the bed, "All the better to call you in."

Walking toward the bed, to deliver the basket of cookies, the little girl noticed how unusual her grandmother appeared, and said, "But, Grandma, what bright eyes you have."

Said the Wolf from where he lay, "All the better to see you with."

Then the child noticed the ears, where they stuck out from under the white nightcap, "And, Grandma, what big ears you have!"

Answered the Wolf, growing quite excited by now, "All the better to hear you with."

In his excitement he had opened his mouth quite wide, displaying its red cruelty, and Red Ridinghood, by now thoroughly alarmed, exclaimed, "Grandma, Grandma, what great teeth you have!"

"All the better to eat you with," shouted the Wolf, as he threw off his disguise and leaped from the bed.

In another bound he would have had the terror-stricken little girl by the throat; but some passing woodsmen had overheard the hoarse voice of the Wolf, and had stopped to listen further, and now dashed into the house, axes in hand.

Even as he made the leap for the child's white throat an axe cut the Wolf down, and shortly nothing was left of him but the pieces.

Predatory interests, cruel and ruthless, still speak to the public through the press, pulpit and radio, in a voice they endeavor to disguise as that of general welfare, but which in reality has for its purpose the influencing of all who will listen to come closer that they may more easily be despoiled.

Their eyes are bright with avarice and greed, quick to note the slightest opportunity by which others can be placed at a disadvantage.

They listen with big wolfish ears to the trend of popular interest, that they may utilize it for the benefit of their own self-seeking and human-destroying schemes.

Their rapacious mouths are armed with teeth of war, pillage and destruction. Blood lust is upon them, and the suffering of sweat-shop, of child labor, and of armed strife brings forth no thought of sympathy.

But after a time the woodsman's axe always cuts them down. Those who live through deceit and cunning, who exploit their fellowman, are inexorably doomed to final expiation.

The Wolf as pictured in the sky no longer takes his toll of blood. No longer is he able to hide his wickedness behind the cloak of lawful practice and social respectability. He has met, not the woodsman's axe, but the spear thrust of Centaurus. His tail and ears are drooped, his legs are crumpled under him, tongue protrudes, and the blood of death drips from his mouth. He has reached the certain fate of those who prey on others.

Little Red Ridinghood escaped destruction; for she was on an errand of mercy. She was building thoughts of peace and joy, of good will, and of compassion for others, into her finer self. The human soul thus fortified may be despoiled of earthly things, but nothing can destroy its spiritual life, or filch its spiritual treasures.

It should not be thought that those who are born when the Sun is in the Lupus decanate are more given to cunning exploitation of others in the interests of themselves. But it does seem that those then born, when they do turn their energies to such despoiling, more quickly are called upon to pay a dreadful penalty. It is the observation of this that gives the decanate its Key-word, **Expiation**.

But aside from astrological considerations, anyone who cultivates within himself the ruthless cunning and heartless cruelty of the Wolf, can not but attract disaster to himself in time. The thought-cells of his finer body, given practice in cruelty and despoliation, sooner or later receive such stimulation as is necessary to cause them to work quite as energetically from the four dimensional realm, to attract similar misfortunes into the life of the one who gave them birth.

Where the thoughts and desires find no sympathy and no consideration for the well being of others, even though the intelligence and body are human the soul is that of the Wolf. All should understand this text: **It is Impossible for a Man to Injure Another Without Himself Being Injured, or for a Man to Benefit Another Without Himself Being Truly Benefited.**

Chapter 9

Serial No. 79
Original Copyright 1935
Elbert Benjamine

Copyright
Church of Light
August 2002

The Scorpion and the Eagle

Chapter 9

The Scorpion and the Eagle

When the Scorpion Grows Wings

—There is a creature of the desert which lives in the arid dust, hiding from the light of day under sticks and stones, preying upon other living things. It has claws with which to grasp, a cruel mouth with which to bite, and in addition, a deadly weapon where least to be expected, a venomous sting at the end of its tail. This creature is the treacherous Scorpion.

No other animal, perhaps, exhibits such intensity in its love making, and none is more jealous and cruel once its desires are satisfied. The male and female Scorpion, preceding the nuptial union, clasp hands in ecstasy, and each in rapt admiration of the other stands immobile for as much as a night and day. The enthrallment of the other's touch seems, for the time being, to lift them to such heights of bliss that they are oblivious of the world and passing time. They are entranced by the wonder of it all. Desire so permeates their bodies as to render them motionless.

Yet when finally the spell is broken, and fertilization has taken place, a monstrous change in attitude occurs. In members of this and allied tribes, such as the spiders, the female is the larger. And it is as if, satiated by the long embrace, she were consumed with jealousy of a future rival, driven to frenzy by the thought her mate might desert her for another. This, at any cost, and at any cruelty, she is determined to prevent. She, therefore grasps her erstwhile lover, and despite his frenzied struggles, his mute entreaties, and his attempts to recall to her the beauties of their recent honeymoon, she tears him limb from limb and devours him completely.

Those, therefore, in the ancient past, who wished to portray in the sky the intensity, the power, the cruelty and the vileness of the destructive side of sex, could have selected no more fitting universal symbol than the Scorpion. The oldest seals and boundary stones of Mesopotamia bear the picture of this constellation; and it is one of the symbols to be seen on the Arkansas Astrological Stone, reproduction of which is to be found in lesson No. 71.

All energy, wherever manifest, is the result of the interaction of positive and negative potencies, and broadly speaking can thus be considered as an expression of sex. That is, mental action and spiritual aspiration, as well as physical movement, are dependent upon desire; upon the utilization of energies on a higher vibratory level which if permitted to express on the Scorpion plane would manifest as cruelty and lust. Religion also is the sublimation of the love impulse, and all art and appreciation of beauty are its manifestations in a realm above that of the brute.

Because creative ability can express on an infinite variety of levels, it would not be feasible to represent each separate plane of its manifestation. Yet it would not convey the correct information if its expression were portrayed merely on the cruel, lustful and destructive level so well represented by the dastardly Scorpion.

Religion being a sublimation of the impulse which on a lower stratum leads the individual to seek a mate, the only Eagle among the constellations portrays the second-decanate of the religious sign, Sagittarius. Yet tradition maintains that the Eagle is also the symbol for the higher side of Scorpio; and in symbolizing the four quadrants of heaven, instead of the Scorpion being used to represent the Scorpio quadrant, the Eagle invariably has been employed. That is, the four fixed signs of the zodiac, as representing the whole celestial circle, are always pictured as a Man, a Bull, a Lion and an Eagle; the Scorpion never being shown.

The Eagle is the bird which it was believed flew higher than any other creature. At least, in its upward soaring it ascends until completely out of sight. Moving thus upward into heaven, it came, quite naturally, to be considered the universal symbol of the highest spirituality. Thus in the Scorpion the ancients sought to convey the idea of the lowest and most vile; while in the Eagle they saw the symbol of those most exalted spiritual heights to which it was possible for man to attain.

This creative energy, manifesting on innumerable planes and permeating both the highest and the lowest in the universe, was expressed by the Mound Builders who left the Arkansas Astrological Stone as the zigzag bolt of lightning. They Pictured it as coming from out the Scorpion constellation in the sky, descending to vivify the productive powers of man.

The Hopi Indians of our Southwest, however, living in a region where lightning is a constant source of danger, where trees and dwellings are frequently struck during the numerous summer thunder-storms, where life is forfeited to this menace from the sky, regarded the lightning not so much as the symbol of the sexual power, as the manifestation of its destructive use. Instead of picturing the Scorpion, they pictured the lightning. And to indicate the constructive trend of the sexual force they used, as Old World peoples did, the Eagle.

Strangely enough, their ceremonies in which the destructive lightning is used to indicate the lower Scorpio attribute, and the Thunderbird, which is an Eagle, is used to portray the higher side, coincide most perfectly with our knowledge of the co-ruler of Scorpio, knowledge which we have gained only since the discovery of the Planet Pluto, early in 1930.

This most remote member of our planetary family not only has an affinity for the Scorpio sign, but in a violently marked manner it expresses, in its observed influence upon human life, both extreme characteristics of the sign. It may partake of the highest or the lowest, belong to the light or the shadow, produce glorious life or ignoble death.

In such Hopi ceremonies, therefore, as have for their object the over-coming of evil and the prevention of destruction, the Thunderbird commonly plays the leading part. It is he who at the winter solstice, for instance, after a struggle, dispels the darkness, brings back the Sun, and gives to earth the light.

These ceremonies, in which the Thunderbird takes part, are held in a kiva, or chamber beneath the ground; for Pluto, the planet of Scorpio, rules the underworld. This underworld, however, is not merely the ignoble region of the desert Scorpion, but also the high empyrean of blue in which the upward soaring Eagle is lost to sight. That is, it is the invisible world, the realm of the after life, divided into a realm of light and a realm of darkness, into heaven and hell, into the abode of the good and the dwelling place of the wicked.

The kiva, therefore, into which the Indians go to hold communion with the dead, to get in touch with their ancestors and to perform their more sacred rites, is built underground to symbolize that region where the spirits of the departed dwell. That is, such constitutes an appropriate surrounding for the Thunderbird to express his peculiar powers; for in all lands Scorpio is recognized not merely as the sign of sex, but also as the abode of Death.

In Central Asia the constellation still is known as the Grave Digger of Caravans; and Greek mythology tells us that invincible as Orion seemed, he was finally vanquished by a Scorpion. Juno presided over marriage and was the patron of women distinguished for their virtue. It was she who sent the Scorpion to bring the downfall of Orion, who had incurred her displeasure. True to its nature, it lay concealed in the ground, and stung him in the foot as he passed.

As the foot represents understanding, and as nothing defeats understanding more quickly than passion, the significance of this story is obvious; that he was vanquished through unwise devotion to sex.

Orion sets in the west, goes down to defeat, just as Scorpio rises triumphant in the east. And it will be remembered that Phaeton also met grief through his encounter with the Scorpion, which sank its sting into the flank of one of his steeds as he strove to guide them through the heavens.

From the commencement of this sign, to the first of Aries, where the Sun is released from the signs of winter is a distance of five months. This circumstance, together with the knowledge that on its inversive side Scorpio rules those forces and entities which most torment mankind, makes Revelation 9:3-5, understandable:

“And there came out of the smoke locusts upon the earth: and unto them was given power, as the scorpions of the earth have power. And it was commanded them that they should not hurt the grass of the earth, neither any green thing, neither any tree; but only those men which have not the seal of God in their foreheads. And to them it was given that they should not kill them, but that they should be tormented five months: and their torment was as the torment of a scorpion, when he striketh a man.”

Because, as psychologists have discovered, the sex impulse is the seat of most of those insistent desires which when suppressed lead to a wide variety of nervous and mental complaints, and because the mating urge is so strong a force wherever life manifests, the Key-phrase given Scorpio, where the Sun may be found each year from **October 23 to November 22**, is, **I Desire**.

Its energy is either creative or destructive, light or darkness, and can express in any field. Creative writing calls it into use, all art is its expression, the orator can sway his audience little without it. Yet whether it takes the upward trend, carrying its user on the back of the Eagle into rarer atmospheres, or sinks him in the mire of grossness and dissipation, depends upon his Desires. These give the trend which the energy must take, and the energy carries him along wherever it goes. If Desire is in the direction of refinement, charged with aspiration to something better, his progress is assured. If it is toward the sensual it pulls him down.

Desires become surcharged with emotion, and emotion tunes the nerves and etheric body in on invisible energies of a similar vibratory rate. This leads to the text: **Through Sex Man Contacts the Inner Planes, Drawing into Himself According to His Mood, the Finest Energies that Vivify the Spaces or the Grossest Forces from the Fetid Border Spheres.**

The Man With Whom Jacob Wrestled

— When the ancient wise ones traced the spiritual teachings regarding the sex-decanate of the sex-sign Scorpio in the sky, they selected a man, Ophiuchus, and represented him as engaged in a life-or-death struggle with Serpens, symbol of that energy generated through the union of polar opposites, which pictures the marriage-decanate of the marriage-sign Libra. Thus intimately united in the sky, an interlocking and inseparable pair, are pictured sex and marriage.

Man's likes and dislikes, and therefore his habitual actions, are conditioned by his experiences; but back of any experience in human form are certain irrepressible drives, such as the desire to live, the desire for significance, and the desire for reproduction. These fundamental drives are inherent in all life, providing the force which impels it to struggle and to attempt to move forward. They can not be obliterated in any living thing; for they are essential constituents of life itself. But their expression, in their attempt to seek satisfaction, is conditioned by experience.

As furnishing energy which can be used not merely to satisfy the urge of sex, but also to secure significance, which in human life becomes self-esteem, and to secure food and other advantages, the reproductive drive is of great importance in the life of every human being. So important is it that the ills resulting from its suppression have given rise to a whole literature. The Freudian doctrines of the unconscious mind and the practices of psychoanalysis revolve almost entirely around the struggle of man to adjust himself to the demands of sex.

While not the only struggle man is called upon to make—for does not Orion engage his environment in mortal combat?—yet the proper conditioning of his sexual impulses is so important a matter to every living person, that the ancients felt the need of picturing it in association with the sex-decanate of the sex-sign, where the Sun may be found from **October 23 to November 2**. Ophiuchus wrestles with the generative snake.

Not always are we fortunate enough to possess a story from the ancient times which reveals the triumph over difficulty, and another which as well imparts the cause and result of defeat. But relating to Ophiuchus we have both, one a story from the Bible, and another a legend from the Greeks.

Genesis 32, relates that Jacob, after sending his wives and sons over a brook was left alone: “And there wrestled a man with him until the breaking of day. And when he saw that he prevailed not against him, he touched the hollow of his thigh; and the hollow of Jacob’s thigh was out of joint as he wrestled with him.”

Ophiuchus does not wrestle with a man, but with the serpent of generation; and in all the old star atlases he is pictured as somewhat crippled in the struggle, his thigh being out of joint.

The thigh is ruled by Sagittarius, the sign of religion, one decanate of which is pictured by an eagle, indicating the sublimation of sex energy. Thus, as the story is told, we are led to infer that there was a maladjustment due to religious views. But to go on with the Bible story:

“And he said, let me go for the day breaketh. And he said, I will not let thee go, except thou bless me. And he said unto him, What is thy name? And he said Jacob. And he said, thy name shall be called no more Jacob, but Israel: for as a prince hast thou power with God and with men, and hast prevailed.

“And Jacob asked him, and said, Tell me, I pray thee, thy name. And he said, Wherefore is it that thou dost ask after my name? And he blessed him there.

“And Jacob called the name of the place Peniel: for I have seen God face to face, and my life is preserved. And as he passed over Peniel the sun rose high upon him, and he halted upon his thigh. Therefore the children of Israel eat not of the sinew which shrank, which is upon the hollow of the thigh, unto this day: because he touched the hollow of Jacob’s thigh in the sinew which shrank.”

The only man in the sky who wrestles is Ophiuchus, and he is likewise the only man among the stars whose thigh is shown to be out of joint. It is the creative energy with which he struggles.

As the thigh is so specifically mentioned, and as Serpens is pictured crossing it, it would appear that religion, which is ruled by Sagittarius, and which corresponds to the thigh, has suffered a misadjustment in its relation to the problem of sex.

In various oriental lands, and among the priests and devotees of certain occidental religions, those who turn to a religious life are required to take a vow of celibacy. Likewise, it seemed to Paul, that great leader in establishing Christian institutions, that married life and religion were in deadly opposition. He seems to have been a woman-hater who was successful in imposing his own private views as to the degrading effect of marriage upon a multitude of followers. As a consequence nunneries and monasteries flourished, and the priesthood were not permitted to form family ties.

We do not need to agree with the views of the Freudian school of psychiatry, but merely to read the history of the mystical manias and mass obsessions which so persistently have pervaded nunneries and monasteries, to become convinced that enforced celibacy is a source of danger to the mind. And practically all schools of psychology of the present day agree that some maladjustment in the sex life is back of the majority of cases of neurosis, and back of much psychosis.

The urge for reproduction is one of the most insistent drives of every form of life. Nature has taken every pain to make this urge so strong as to be irresistible. That is, she has provided in each organism for the generation of a specific kind of energy in a volume sufficiently great that it can not be prevented from expressing. This insures the perpetuation of the race. The effort, in the manner advocated by St. Paul, to keep it from expressing has never been successful. The energy is never merely stored up within the human body. It invariably finds an outlet.

Suggestion is powerful, and under certain religions the suggestion is repeatedly given the child that sexual desire is iniquitous and that only those ignoble and depraved have such intense feelings.

The child thus indoctrinated also must satisfy another fundamental drive which is equally strong. The desire for self-esteem. Yet if he admits, as he enters adolescence, that he has insistent sex desires, because of false training this implies to him that he is a degraded creature, that God disapproves of him, and that he probably will ultimately simmer in hell. These thoughts are so repugnant to him that he is unwilling to believe he has such iniquitous impulses. His constant suggestion to himself, and also frequently the suggestions of those in his environment, is that he could not possibly have such disgraceful urges. And the unconscious mind, accepting the suggestion of his spotless purity, builds up an evasive mechanism which will satisfy him that this is true. He is as unaware that he has sexual impulses as a hypnotized subject, told a stick is a cigar, is unaware that he is not smoking tobacco.

The unconscious mind, with all its resources, is powerless to obliterate any of the fundamental drives of life. The most it can do is to divert them from one channel into another.

Yet the sex urge can express fully and with complete satisfaction, while maintaining physical and mental health, on a wide variety of levels and through diverse creative channels. The love-life, for instance, can be elevated to the plane of regeneration in which the physical no longer feels a need, that need being replaced by a fusion and interchange of finer forces. Or the sex urge can be diverted completely into the creation of literature, art, music, or social service work.

It is only when the creative energy is not expressed through some creative channel that, under the implied suggestion that it has no existence, it expresses itself under disguise as some of the numerous symptoms of neurosis, psychosis, or erratic behavior, with which psychoanalytic literature has made the public familiar.

Jacob seemed to have the difficulty that many people have in adjusting his reproductive desires to the demands of his religion. He wrestled with the problem, as Ophiuchus is yet observed to be doing until he solved it. This caused him some affliction, and he never succeeded in adjusting it to his early religious convictions, as implied by the shrunken sinew in the hollow of his thigh. Yet that he finally did make a satisfactory adjustment, even from the standpoint of his later religious convictions, is to be inferred from the statement that the Sun, which is a symbol of virility and vitality, halted upon the part of his body having religious significance, that is, upon his thigh.

And as always is the case, when he had made the proper adjustment, so that he was able to divert his creative energies into channels of accomplishment which were socially acceptable and beneficial, this adjustment blessed him. He then had at his disposal to use for a worthy purpose a volume of energy not possessed by less fortunate men.

Laocoon, in the Greek story, was not so fortunate in making the adjustment. It was at the siege of Troy, and the enterprise required that a wooden horse—symbol of religion, just as was Jacob's thigh—should be moved into the beleaguered city. Laocoon, who was a priest of Apollo (Sun) opposed the admission of this horse. As a punishment for this attitude two enormous serpents were sent to attack him while he with his two sons was offering a sacrifice to Neptune. Coiling around the men, the serpents crushed all three to death.

Of the two roads, one of which is demanded by Neptune, octave of Venus, the planet of love, instead of sublimation, Laocoon chose suppression. He was unable to adjust his creative desires to his religious views, as symbolized by the wooden horse. Instead, therefore, of being blessed, as was Jacob who defeated the serpent and sublimated his desires to a higher plane of expression, he was crushed and strangled by them in an attempt at their annihilation.

Resourcefulness, which is the Key-word of the decanate, follows the ability to divert the sex-energy into proper channels. As a constructive and acceptable outlet for the energy must be found, we have this text: **Continual Kindness Between the Sexes Generates a Power by Which the Heights may be Scaled.**

The Altar of Cain and Abel

—The Altar upon which sacrifice is made by priest and devotee is repeatedly mentioned in the symbolical stories current in various lands. In religious observances of the past it has ever held a position of importance, particularly in those religions in which the propitiation of astral entities forms an essential part of the ceremonies.

The departed friends and ancestors come under the astrological rule of the eighth house, pictured by Scorpio; but elementals and various other astral entities, particularly those which attempt to deceive or enslave their votaries, come under the rule of the twelfth house, pictured by Pisces. To have significance where both the house of death and the house of astral entities are concerned, in selecting the appropriate place for Ara, the Altar in the sky, the ancients allotted it, therefore, to the Pisces-decanate of Scorpio.

To reveal its true significance, it could picture a decanate of no other sign than Scorpio; for sacrifices are made either to the light or to the darkness, to true religion as represented by Sagittarius, or to blind and erroneous belief as indicated by Pisces, the other sign which Jupiter, the religious planet, rules. Or to state it more precisely, sacrifices are made to the beast in man, pictured by the vile and treacherous Scorpion, or to the angel in man, pictured by the high-soaring Eagle.

Pluto, the co-ruler of Scorpio, has dominion over the invisible world, over both the spiritual heavens and the astral hells. One side of its influence enables the individual to contact the highest realm of all, and the other brings the individual into touch with the most degraded and terrifying wickedness. Scorpio, according to tradition, is the Great Deceiver. Consequently, when opportunity offers for the inversive influence of Pluto to get in its work, true religion and spiritual aspirations are given such a twist as to lead the devotee into folly and wickedness under the belief he is practicing that which is good in the sight of God.

It was customary, for instance, among the ancient peoples of Mexico, at prescribed times astrologically ascertained, to bring to the priests for sacrifice upon the Altar, fruits and flowers. Flowers, of course, are the reproductive parts of plants, and thus ruled by Scorpio; and the fruits are the issue, containing the seeds which permit of a new generation. This ceremony, from which is derived the custom of hanging May Baskets, signified the knowledge that the purpose of incarnation on earth is to develop the seeds of spirituality, that the experiences of earth can be used to unfold the beauties of the soul, even as blooms the flower; and that the desires of the devotee to devote all his resources, as symbolized by his offering, to the development of those

qualities which make him a better citizen of the universe, lead to the highest happiness.

Whatever the sacrifice on the Altar might be, if it were burnt, the smoke ascending, and the aromas permeating the air, symbolically conveyed the idea that the motives and desires were carried into the invisible world, attracting intelligences of a quality corresponding to the nature of the sacrifice, who, it was believed, would assist the individual in attaining that for which the sacrifice was offered.

For instance, as related in Numbers 22 and 23, Balak desired to employ Balaam to bring a curse upon the Israelites, and sent word to him: "For I will promote thee unto very great honor, and I will do whatever thou sayest unto me: come therefore, I pray thee, curse me this people."

When finally Balaam was persuaded to come to Balak, he was taken to a high place where he could see all the people, that he might bring a curse upon them: "And Balaam said unto Balak, Build me here seven altars, and prepare me here seven oxen and seven rams. And Balak did as Balaam had spoken; and Balak and Balaam offered on every altar a bullock and a ram."

Here we have an effort typical of the inversive side of Pluto, showing that the employment of a magician to bring a curse upon those it was desired to destroy was not uncommon in Bible times. But in this instance the effort failed, Balaam at the last instant refusing to pronounce the curse, and saying: "Surely there is no enchantment against Jacob, neither is there any divination against Israel."

In ancient Mexico, as the above incident from the Bible indicates was the case among the Semites, there were those who worked under the inversive side of Pluto, who attracted to themselves not the eighth house influence so much as the twelfth house denizens, and used them, and were used by them, to do injustice and to work evil.

Gradually, and subtly, as such underhanded forces always work, these Priests of the Shadow gained dominion over the religious observances of the land. After a battle, with the blood lust still upon them, it seemed to the populace quite the fitting thing that prisoners of war should be offered as a sacrifice upon the Altar, instead of the customary fruits and flowers. Especially so, as the priests told them that thus would the strength of the victims be inherited so it could be used against future enemies.

Once the custom was established of making human sacrifices, it was easily extended to imply a demand by the gods for more and more victims. If prisoners of war were not forthcoming, individuals from the populace must be selected, otherwise the anger of the gods would be visited upon the nation. And in time of national crisis, still more victims must be had, in order to avert the threatened peril.

Mass murder, such as that practiced by modern racketeers with machine guns, is typical of the lower influence of Pluto, co-ruler of the sign of Death. The more cruel and bloodthirsty a killing is, the better it corresponds to this ruthless side of Scorpio. The Aztec Priests of Darkness, therefore, when they gained supremacy, devised a particularly horrifying method of human sacrifice. The victim was spread-eagled,

face up, on the Altar, each hand and leg held by a priest. Another priest, after appropriate magical invocation to the gods (bloodthirsty elementals of the twelfth house), with a single slash of a stone knife ripped open the victim's breast, and with the other hand tore the living, palpitating heart from the shrieking man or woman; then held the bloody trophy aloft as an offering to invisible beings and for the assembled populace to see. If the victim died before his heart was jerked from his agonized body the sacrifice was considered ineffectual.

To go still deeper into the teachings of the Altar in the sky, let us consider the story of the first two children born on earth. Genesis 4, relates that Cain was a tiller of the ground; by which is probably meant that his interests were material. Abel, on the other hand, was a keeper of sheep. Instead of being earth-earthy in his inclinations, it is implied that, like Aries, the fiery exaltation of the Sun, his zeal and enthusiasm were for immaterial things.

Cain, with his purely physical outlook on life, offered as his sacrifice to the Lord, the fruits of the ground. That is, he seemed to think, like certain men at the present day, that he could buy spirituality. Instead of turning the creative energies within himself into channels which would develop refinement of feeling, and energize action which was above the plane of brute, he merely worked hard to acquire material possessions, and turned a portion of these over as a religious tithing.

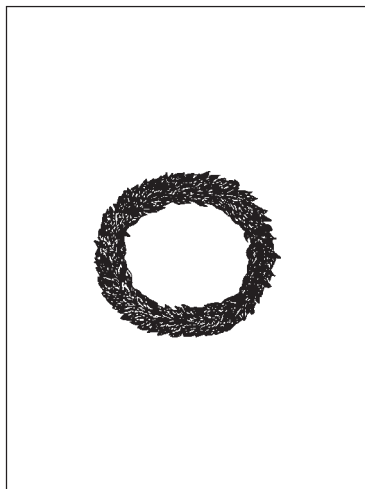

CORONA AUSTRALIS T63 Attainment

Figure 9-1

Third Decanate of Scorpio

Sheep are symbols of creative energy. This energy is of animal origin. When Abel, therefore, brought in the firstlings of his flock and the fat thereof, and offered them as a sacrifice, the implication is that he sacrificed the animal part of himself, and turned his creative energies into channels which would not express the gross, but would develop refinement and conduce to those actions which prove spirituality.

In other words, Cain was quite willing to sacrifice his material possessions; but he made no effort to change the brute within himself into something more acceptable. That this is the correct interpretation subsequent events seem to prove; for jealousy is one of those destructive emotions which are fed by the energy of unregenerate Scorpio. When he was reproved for his manner of living, instead of taking it in good part, he became angry that his brother should have had better fortune than himself.

The Altar pictures a decanate in the sign of Death. Yet even though Abel was slain, he had contacted the Eagle side of Pluto. Cain, however, in his anger, contacted the Scorpion side, and his energies, flowing into destructive channels, wrought the death of Abel. Truly, the energies of Scorpio go aloft like the Eagle, or sink into the earth. To the extent they are present they must express.

The entire teaching which the ancients sought to convey by Ara, where the Sun may be found each year from **November 2 to November 12**, is condensed in Cain's reply

when the Lord asked him where was his brother, Abel: “And he said, I know not: Am I my brother’s keeper?”

Responsibility is the Key-word for the Ara-decanate, and the Cains of earth always disclaim responsibility for that which befalls their fellowman. Although they occupy human forms they still function on the brute plane where fang and claw, and a total disregard for the welfare of others are dominant factors. But every Brother of the Light must forever renounce such an attitude, which attracts the twelfth house astral entities. Those who would attract help and guidance from the truly spiritual must assume Responsibility for contributing all within their power to the welfare of others.

Like Abraham, as related in Genesis 22, instead of killing after the manner of the Aztec Priests, when his own son was tied a victim on the wood of the altar, he must sacrifice the animal within himself, the creative Ram, turning its energies to the service of God. In no other way can spirituality be attained. Hence the text follows:

By Sacrificing His Animal Thoughts, Desires and Pleasures Upon the Altar of Aspiration to Higher Things Man Comes into Possession of Intellectual and Spiritual Pleasures that Yield a far Keener Delight.

The Adept’s Laurel Crown

—It was the custom of the ancient Greeks to crown the victors in the Pythian games with a wreath of laurel. It was also used by them as a mark of distinction for certain high offices; and later came to be employed to denote academic honors, from which the European custom arose of calling the poet or artist who won the highest place, the laureate, such as the poet laureate; that is, the poet who by his excellence had merited the crown of laurel. It is such a crown, Corona Australis, which pictures the attainment-decanate of Scorpio.

Scorpio is ruler not merely of the energy of sex, but also of death; and the placing of the universal symbol of highest attainment where it represents the Cancer-decanate of Scorpio implies that the victor thus designated is the master of the energies of his creative functions, and that the scope of his powers is not confined to the material world, but extends into the realm where reside those commonly denoted dead. He has, while still in the flesh, attained immortality, and is able to work both on the external plane and in the realms of disembodied life.

The Sun is in the decanate of the Southern Crown from **November 12 to November 22**, and the adjoining sign into which it moves when it leaves this decanate is Sagittarius, the religious sign, the sign of benevolent Jupiter. To pass through the section of the zodiac pictured by the Crown takes the Sun ten days, and while so doing it is still in the sign of Death, Scorpio, and thus subject to the influence, not

merely of the spiritual side of Pluto, the co-ruler of the sign, but also to the dark afflictions of its inversive side. The victory over these Brethren of the Shadow, the period of the Sun's passage through this decanate, the significance of it as belonging to the sign of Death, and the nature of the Crown which is gained as a reward for the victory, all are mentioned in Revelation 2:10:

“Fear none of these things which thou shalt suffer; behold, the devil shall cast some of you into prison, that ye may be tried; and ye shall have tribulation ten days: be thou faithful unto death, and I will give thee a crown of life.”

It is also mentioned in I Peter in a manner which makes its significance obvious: “Feed the flock of God which is among you, taking the oversight thereof, not by constraint, but willingly; not for filthy lucre, but of a ready mind; Neither be lords over God's heritage, but being examples to the flock. And when the chief Shepherd shall appear, ye shall receive a crown of glory that fadeth not away.”

These two Bible commentaries on the nature of the work by which the Southern Crown can be gained make it quite clear that force and compulsion, which are typical of the inversive side of Pluto, are to be avoided. Neither is fear to be countenanced, even when danger threatens. The individual, by his thoughts, feelings and actions must serve as an example of correct living, that other men may observe and do likewise. The energies must be devoted to helping others to the utmost extent, to feeding the flock as Peter states it; but not because of expected recompense—filthy lucre—but of a ready mind, that is, because there is a deep and abiding desire to benefit to the utmost all with whom there is contact.

Those, therefore, who undertake the winning of this Southern Crown, token of the highest attainment which is possible to life on earth, must adopt as the pattern of their lives the effort to contribute their utmost to universal welfare. They must realize that they are workmen in the cosmic organization, with a responsibility to universal society; that the universe does not run itself, but depends upon the wisdom and initiative of its various intelligent cells; and that they each have a definite function to perform in furthering the fulfillment of the Divine Plan.

Any aspirant to the universal Laurel Crown must make this conception of his responsibility to all other life-forms so completely a part of his character that every decision he is called upon to make will habitually be weighed, and every thought, emotion and action decided, by considering which contributes most to cosmic welfare.

When, after due thought and analysis, he has decided that a particular line of endeavor, or a specific attitude toward events, or some accomplishment, is in the direction of the universal good, he must then not merely have the skill, but also the energy, courage, and fixity of purpose to carry his decision into action, and to make its end a reality. That is, if he is to make any real attainment, he must possess will power.

It is here that the energy denoted by Scorpio plays an important part, particularly when the individual reaches that state in his progress where he is able to work not merely on the physical plane, but on the inner plane as well. The habit of not making a decision until it is ascertained if the object sought is within the scope of the abilities and if it is worth the effort, and then, once having made a decision never permitting anything to prevent it being carried out, develops that fixity of purpose which is essential to the exercise of a powerful will. But a powerful will, in addition to fixity of purpose, must have available an abundant energy which can be brought to bear in the carrying out of any decided upon course of action.

If, therefore, the individual has advanced far enough along the path toward adeptship that he is able not to suppress, but actually to sublimate and transmute the energies of Scorpio, so that they may be directed into channels which are decided upon, this gives him a reserve energy supply which it is possible to use on any plane for any purpose.

Needless to say, the use of such surplus energy to the disadvantage of others immediately attracts the Legions of Darkness, ruled by the inversive side of Scorpio, and ultimately brings the enslavement and downfall of the one so using it. But its use as an energy to support the will in undertakings which have for object the advancement of the race, enables work to be accomplished that would be impossible without it, and tend toward true spirituality.

Yet with or without this additional energy supply, which is available to the adept who has attained the Laurel Crown, the benefit any individual can be to cosmic society is limited by his knowledge, and his abilities at the time. Those, therefore, who strive for the Crown of Adeptship, seek also to increase their knowledge; for unless they understand the purpose of the Divine Plan they are in no position to aid in its realization; and unless they know how to help people, their efforts in that direction are fruitless. They also strive at all times to develop their abilities- for to the extent abilities are present can that which is known to be desirable accomplishment be realized.

The world of material science offers a certain type of information which can not be neglected. A knowledge of physical laws is a great advantage to anyone who undertakes important work. But such knowledge quite neglects the action of those invisible forces and the existence of invisible realms which have an even more important bearing upon human life and destiny, both here and hereafter.

The one who seeks the Crown of Life, therefore, undertakes to make himself as completely familiar as possible with all the occult forces of nature. In addition to the type of information which the common educated person is expected to possess, he makes himself thoroughly familiar with the occult sciences.

He finds in astrology a method of gauging and determining the trend of invisible forces as they exist at any given time; and this gives him the best possible information as to when and how to direct his energies to attain the best results. The manner in which thoughts unite to form the thought-cells of which his astral body is formed gives him the key to character building, and enables him to convert energies received from the planets into channels that attract to him the desired conditions. The invisible vibrations of selected environments also, when understood, can be utilized to make his life far more effective than otherwise it would be.

But aside from the acquisition of knowledge of the operation of all these invisible energies which commonly are called occult, and the utilization of this knowledge for human betterment, the one seeking the supreme Crown of earthly life also develops certain capacities and abilities within himself which relate to the use of the psychic senses and the development of higher states of consciousness.

If he is to adapt his life on earth to maximum usefulness, he must also be familiar with the conditions and requirements of that life in which he and others must function after the change called Death. He recognizes that earthly life in human form is but one link in an endless chain of existences; and that if it is to perform its highest function, it must fit the Individual for the succeeding phases of existence. To know what will be advantageous in that after life, and also to contact those of greater wisdom than himself who there dwell, it becomes advantageous to him to be able to explore it and to contact its conditions and intelligences.

He does not attempt to do this through the unreliable channels of irresponsible mediumship, which tend to break down the will; but through developing the senses of the astral body so that he can see and hear and feel, and even travel, on the astral plane much the same as he does on the physical. In this manner, as he makes progress, he in time becomes as familiar with the conditions and people of the next plane of life as he is with the conditions and people of the physical world. Pluto, ruler of Scorpio, relates to both planes, and those who attain the Crown live consciously and function on both planes at will.

Holding to the pattern of life which calls for maximum service for the common good, they acquire knowledge of occult laws, and develop their abilities to use occult forces, in a constant endeavor to increase the scope of usefulness. Their attitude and efforts lead to the text: **Men Should be Esteemed Not Because of their Race, Color, Sex, or Ancestry, but for What they have Accomplished for the Common Good. The True Monarch is He Who Renders Greatest Service to His Fellow Man.**

Chapter 10

Serial No. 80
Original Copyright 1935
Elbert Benjamine

Copyright
Church of Light
August 2002

The Bow of Bright Promise

Chapter 10

The Bow of Bright Promise

The Luck of the Horseshoe

—In northern Arizona, over rough country to the east of Grand Canyon National Park, is a great arch of stone, carved by the forces of erosion, known to the world as Rainbow Bridge. To it for centuries past the Indians have made pilgrimage, holding it to be a symbol given to them by the Great Spirit, a religious token to which in reverence they pay homage. It is the bow of bright promise, wrought in imperishable rock, a crystallized replica of the many-hued bow to be seen after rain when once more the Sun is shining.

The Archer, Sagittarius, where the Sun may be found from **November 22 to December 22**, also holds a bow, and aims its arrow straight at the treacherous Scorpion's heart, ready to prevent further depredations, and guarding humanity against its invasive legions. This Bowman of the sky pictures the sign of Religion, the so-called sign of the Higher Mind, which has rule also over teaching, long journeys, publishing and all public expression of opinions.

The Bow was known as a beneficent religious symbol early in the Bible days. Jupiter, the planet of religion, known in astrology as the greater benefic, having chief power to protect from danger, is the ruler of the sign Sagittarius. Therefore, when the earth had been ravaged by flood and all flesh destroyed, except that which had entered the ark with Noah, and a token was desired by which those whose religious devotion had saved them, that no more would such destruction take place on earth, the most appropriate symbol of divine protection that could have been selected would pertain to Sagittarius. The Bow is such a universal symbol:

“I do set my bow in the cloud, and it shall be for a token of a covenant between me and the earth.”

The protection and good luck which Sagittarius, the hunting Horseman, is able to bring to those whom he favors is also indicated in the present-day custom of hanging a horseshoe over the door. A horseshoe in form is a Bow. But because it is used on the foot of a horse it takes on the significance of understanding as well as Jupiterian good fortune. That is, symbolically it denotes the sound judgment which the activities of the Higher Mind promote, in addition to the benevolent influence of the major benefic.

This matter of the Higher Mind and the Lower Mind, because it so frequently is referred to in occult literature needs some explaining. As a matter of fact there are not two minds, but only one. Nor does this refer to objective consciousness and subjective consciousness, as do Castor and Pollux. Instead, it refers to the motives and aims of the mind, or soul. There is really no distinction between the term soul, mind and character. They are the same thing, and embrace all the experiences, including those derived from mental activities, which are retained and organized within the finer forms.

The motives which prompt the thoughts and the actions which they direct, however, can be divided into two categories quite as much in opposition as are the signs Gemini and Sagittarius. The motive may be self-centered, having no concern as to how others will be affected. This need not impair the intelligence. And frequently work done solely from this motive in the end proves a boon to humanity.

Thus an inventor may have no thought of whether his invention will conduce to human good, such as a labor-saving machine, or to human destruction, such as a more effective type of gun. His sole aim may be to produce something which will bring him a lot of money; and he may care not one whit how it affects the human race. Such an attitude betokens a dominance of the Lower Mind. But in spite of his indifference to the welfare of others, he may find it more easy and profitable to invent something which will benefit humanity.

The healer may have no interest in getting the patient well. He may be interested merely in moneymaking. He is dominated by the Lower Mind. But if his great desire is to alleviate suffering and to benefit his patients; if he looks upon the financial rewards of his profession as affording him a livelihood through which he can be of greater benefit to others than he could be if he were without money, this indicates that the Higher Mind is dominant.

Even a priest or preacher may be actuated in the choice of profession chiefly by the dictates of his Lower Mind. He may view the matter from the selfish standpoint, not of the occupation in which he can be of most service to his flock, but as the avenue through which, with his special talents, he can do the utmost for himself.

Almost anything or any ability that can be used for the benefit of the world, can also be used for the benefit of its possessor at the expense of others. The findings of material science, for instance, give the knowledge and facilities for making the world a better place in which to live. But often they are not used for the benefit of the race, but as a means by which the few can oppress and exploit the many.

Research, study, and thought are ruled astrologically by the third house, and thus are related to Gemini, the sign of the Lower Mind. But when the results of research, study and thought are given to the world through publishing, preaching or teaching, this public expression is ruled by the ninth house, and is related to Sagittarius, the sign of the Higher Mind. The implication is that the wide dissemination of information is advantageous to the race.

Yet while Sagittarius rules the Higher Mind, or Divine soul, it is only the human part of the sign that has this significance. Chiron, one of these half-man half-horse characters of Greek mythology was famous for his knowledge of music, medicine, and shooting; and taught mankind the use of plants and medicinal herbs. He was a great instructor, and taught such heroes as Jason, Medeus, Hercules, Aesculapius and Achilles.

He also, as a fitting end to a completely noble career, took the place of Prometheus, and underwent the agony of having his liver devoured daily that the hero who had conferred the greatest possible boon on mankind might be free. Prometheus, who in the sky is Pictured as Andromeda of the middle-decanate of Pisces, in his zeal to serve mankind had stolen the divine fire from heaven. That is, he had enabled mankind to attain spiritual illumination.

The great discernment when the Higher Mind is developed gives to this sign the Key-phase, **I See**. But the sporting, animal side, which nourishes the Animal Soul, shuts its eyes to everything that interferes with its desires. It is heedless and impulsive, as is illustrated by the Greek story of Eurytion, who was one of the Sagittarians.

Being invited to the marriage of Pirithous, he became intoxicated with wine, and, although when sober, a jolly good fellow, such as Sagittarians usually are, under the influence of wine he attempted violence to the bride. The other Centaurs who had gone to the wedding party with him, and who also were drunk, thought that a good idea, and each grabbed a woman. In the resulting brawl a number of them were slain.

Across the zodiac from north to south is a wall, or colure, which divides the signs in which the days continue to grow shorter, as they do from June 22 to December 22, from the signs in which the days continue to grow longer, as they do from December 22 to June 22. This wall, or chimney as it is sometimes called because it runs from Capricorn down to the sign of the house, Cancer, touches the horse sign Sagittarius on one side.

It seems, as related in II Kings 9, that Jezebel, for the time being no longer practicing witchcraft, had come under the influence of the sporting side of Sagittarius. When Jehu entered the city she, "Painted her face, and tired her head, and looked out at a window."

It is evident she was attempting to make a feminine conquest, but the religious convictions, the human side of Jehu was too strong; and as inevitably happens to those who exalt their own pleasures above the pain and suffering they cause others, these lower Sagittarian expressions, as symbolized by horses, destroyed her:

“And he said, Throw her down. So they threw her down: and some of the blood was sprinkled on the wall, and on the horses: and he trode her under foot.”

Science, which observes how nature acts, and classifies these observations in formulas which are called laws, is under Gemini. But when these sciences which have classified knowledge are used as a basis for a pattern of life, the resulting design is called a philosophy, or religion, and then comes under the dominion of Sagittarius.

The Higher Mind then perceives, as the result of correlating the sciences and bringing to bear upon them the inner vision which it customarily uses, that the universe is not an insensate machine, but a living organism, the various entities comprising it constituting the cells, each cell and each group of cells, with its own particular function to perform. Furthermore, it perceives that the cosmic whole is moving in a definite direction, developing constantly a more complex structure, with a specific, although ever expanding accomplishment as its aim. There is Divine Plan.

The Higher Mind endeavors, in as great detail as possible, to grasp the significance of this Divine Plan. And then it strives to understand where, to the best possible advantage, it can fit into this Plan as a constructive factor. It assays its various abilities and possibilities to discover how these may be used to forward the movement of universal progression. And having determined the line of effort it should follow to be of greatest use, it sets to work to render that service.

Thus the expression of true religion is perfect or imperfect according to the abilities, and according to the correctness of the insight into what needs to be accomplished in the furtherance of the universal scheme. This conception is set forth in the text: **True Religion is the Discernment of the Divine Plan and a Conscious Cooperation in its Fulfillment.**

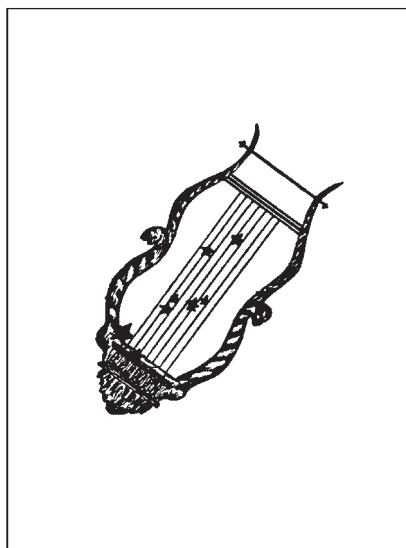

LYRR ♐ - ♐ *Devotion*

Figure 10-1

First Decanate of Sagittarius

The Harp on which the Angels Play

—It was by no accident that the Crown which implies the Great White Throne and the Harp on which the angels play are so located in heaven that they picture adjoining decanates of the celestial circle. And if we consider Sagittarius as ruling not only far travel, but also the highways on which such travel is made, then the Sun, ruler of gold, in this sign gives rise to the thought of golden streets. Thus do we have a zodiacal origin of an after life and a Crown or throne relating to the last of Scorpio, to

streets paved with gold, and to angels playing eternally on harps before the throne, as indicated by the next decanate, by Lyra, picturing the Sagittarius-section of the sign of religion.

The intimate relation existing between both religion and the underworld of Pluto, co-ruler of Scorpio, and between harmony and this invisible realm, is set forth in the Greek story of Orpheus and his lost bride Euridice. Pluto, ruler of the sign of sex, on its higher, or Eagle side, relates to perfect union, to regenerate marriage, and to the union of true soul mates. On its inversive, or Scorpion side, it relates to separation, to antagonism and to dissolution.

The harmonies within ourselves are chiefly set in motion by our thoughts, and as the Harp pictures a section of the sign ruling the Higher Mind, and as thoughts are ruled by Mercury, Greek legend quite appropriately held that the famous Harp on which Orpheus could play so sweetly that rivers ceased to flow and savage beasts forgot their wildness, was given to him by Mercury.

Orpheus, the master harpist of all time, married his ideal, his soul mate, Euridice, to whom he was tenderly devoted. Apparently, however, their adjustment was not so successful as that which the Biblical Jacob made; for the serpent with which Ophiuchus still wrestles bit Euridice. Instead of attaining the Crown, which pictures triumph over the sign of Death, she was bitten by the serpent, died, and passed to the realm of Pluto.

Orpheus was disconsolate. He could not reconcile himself to the loss of his beloved mate. Therefore, to recover her, he made a visit to the infernal regions. Taking his Lyre along, he played so sweetly that the wheel of Ixion stopped, the stone of Sisyphus stood still, Tantalus forgot his burning thirst, and even the Furies relented. More important still, so enraptured did Pluto become with the music, and so moved by the depth of Orpheus' sorrow, that finally he agreed to restore Euridice to him. This reunion of Orpheus and his lost Euridice is one of the most touching incidents of legendary lore.

In the story, first of all we have set forth that the abuse of sex is destructive, even when those married are ideally suited each to the other. It led to the death of Euridice.

Then there is set forth the power of harmonious thoughts engendered by love to find the object of its affection, even across the border line of death. The invisible realm of Pluto can be contacted and controlled through the harmonies engendered by pleasant emotional states and loving thoughts more successfully than in any other way.

Ixion was tied to a wheel in hell, that continually whirled around, keeping him in perpetual torture. Sisyphus, in the infernal regions, was condemned to roll a stone to the summit of a hill; but the stone always rolled back, thus making his punishment eternal. Tantalus, in the underworld was in a pool of water which flowed from him whenever he attempted to take a drink, causing him perpetual thirst. But the music of Orpheus had so powerful an influence in the region where these condemned souls were undergoing punishment that their torture ceased.

Those who have attained the Laurel Crown of adeptship not only work upon the physical plane, but often also use their abilities to release from suffering those who have passed to the after life in a state of mind which keeps them in torture. The suicide, for instance, often, like Ixion, is tied to the wheel of the mental images which caused him thus to try to flee from reality. By taking his own life he hoped to free himself from a distress which seemed too great for him to bear. But he merely transferred his suffering to another region. Round and round he goes with the images of the awful conditions from which vainly he hoped to escape.

Pluto, as the story goes, in permitting the reunion of Orpheus with his long lost soul mate, imposed one condition, that the musician was not to look behind him until he was out of Pluto's realm. Orpheus promised to obey this instruction. But as he was traveling upward and neared the region of the upper world, Euridice following at his heels, he forgot his promise, and looked back at his cherished bride, whereupon she vanished, never more to be seen.

This looking back, of course, as in the story of Lot's wife who turned to a pillar of salt, is the turning of the thoughts to a contemplation of the conditions and experiences of the past. This tunes the individual in on the old desires, sets in motion the vibrations of the past, and again attracts to him the external conditions from which he is fleeing. If we are to enjoy a condition of greater harmony and bliss, and if we are to prevent separations similar to those which have occurred in the past, we must avoid thinking the thoughts, and thus entering the vibratory conditions, that in the past have resulted in discord and separation. But Orpheus, in spite of the admonition of Pluto, could not refrain from again contemplating Euridice in the same manner he had considered her in bygone times; he looked back at her, and again she left him, this time gone forever.

The result of this separation, of contacting the disintegrating or antagonistic side of Pluto, is dramatically set forth in the tragic ending of Orpheus. The female Scorpion, symbol of the inversive side of Pluto, when her lust is satisfied, tears her mate to pieces and devours him. Orpheus, after the loss of Euridice, separated himself from the rest of mankind. This offended the Thracian women, and during the celebration of the orgies of Bacchus, enraged at his coldness, they set upon him, tore his body to pieces and threw his head into the Hebrus. Having lost love, and with no desire left to cooperate, which desire Pluto rules, the disintegration of Orpheus was to be expected. Love is the one great integrating force.

In Bible times, Saul was accustomed to be troubled by obsessions. Morbid thoughts would occupy his mind, and these would so tune him in on the discordant side of Pluto that astral entities would take possession. I Samuel, 16, relates:

“But the spirit of the Lord departed from Saul, and an evil spirit from the Lord troubled him. And Saul's servants said unto him, Behold now, an evil spirit from God troubleth thee. Let our Lord now command thy servants, which are before thee, to seek out a man, who is a cunning player on an harp: and it shall come to pass, when

the evil spirit from God is upon thee, that he shall play with his hand, and thou shalt be well.”

Thus was the Crown, as represented by the King, and as indicating a decanate of the sign ruling those in Pluto’s realm, brought into association with the **Devotion**-decanate of Sagittarius, where the Sun each year may be found from **November 22 to December 2**, pictured by the Harp.

“And it came to pass, when the evil spirit from God was upon Saul, that David took an harp, and played with his hand: so Saul was refreshed, and was well, and the evil spirit departed from him.”

David, among the constellations, is pictured with his harp as one of the Twins, which rule the hands; but the Harp itself, as a separate constellation, quite appropriately depicts the most religious decanate of the whole zodiac. Of this harp a master wrote:

“Harp divine, whose strings the angels tune and set in motion sweet waves of music that vibrate round the spheres, and bring to man the tidings of his once celestial state, that says in tones of heavenly sweetness to faint and struggling souls Look up and onward, thy spirit calls thee home. God Jehovah is, and thou must be.”

But in the case of Saul his thoughts were so morose and savage that the inspiration, or vibratory level of intelligence, he often tuned in on was discordant. Instead of tuning in with prayer and devotion he tuned in with anger and revenge. And following the law which governs contacting the invisible realm, he thus came into rapport with entities of the same general vibratory level as his thoughts, and of the same desires. They were malignant, and finding the avenue thus open to them, they took possession of the king.

The one way to cure a condition of this kind is to stimulate thoughts of an entirely different character. When the dominant thoughts are harmonies this immediately cuts off all approach of unseen entities whose essential nature is discord. When the thoughts are elevated, as sweet music has an influence to raise them, to noble aspiration, it tunes the consciousness in on a corresponding invisible plane, and automatically cuts off any association with evil spirits.

When thus understood, the method which was applied by David to soothe the troubled spirit of Saul, and thus cure his obsession, is the most approved and successful method that can be applied to such cases today.

It also explains much of the value to be derived from devotional exercises and prayer. Devotional exercises accompanied by appropriate music are a great help to tune the feelings and emotions in on the plane of intelligence corresponding to such high emotional states. If they perform their office properly, this raises the consciousness to a much higher plane than is its customary vibratory rate. It brings the consciousness into touch with invisible entities on the inner plane who are higher in spirituality and in wisdom than the devotee, and enlists their help.

Discouragement and feelings of self disapproval keep the mind tuned in on the lower states of Pluto's realm. But faith and devotion tend to enable the individual to rise above all such sordid and discordant feelings, so that they, for the time being are no longer troublesome, no longer attract discordant intelligences from the invisible. Like the music of David's Harp, faith and devotion soothe and lift the thoughts. For as the text states: **On Every Plane Harmony is Life and Discord is Death.**

The Eagle Takes a Trip to Heaven

—Of all creatures it was believed that the Eagle flew highest, and thus was the explorer of heaven. He was the bird of Jove, the bearer of his Thunder, the one who, when a cup bearer was needed for the king of the gods, was sent forth and brought back the youthful Ganymede. Quite appropriately, therefore, was he placed in the sky where he would picture the **Exploration**-decanate of Sagittarius, in which each year the Sun may be found from **December 2 to December 12.**

When Jupiter, ruler of Sagittarius, lay concealed in the cave at Crete, to avoid the fury of his father, Saturn, Aquila brought him nectar that his hunger might be satisfied. And the Rig-Veda states that it was this Eagle which brought the Soma juice to India.

The cup in which Aquila carried the spiritualizing juice to India, and which it was the duty of Ganymede to keep handy that Jove might quaff and assuage his thirst, relates to the first-decanate of the pleasure-loving sign Leo. It thus pictures the love-affair decanate of the love-affair sign; the region of the sky where desire burns with its hottest flame. Both wine and soma juice are intoxicating. They are stimulants, even as desire is stimulating and causes action to flow spontaneously and without hindrance toward those things in which most pleasure is found. The more intense the pleasure, the more readily does action take the direction of its fulfillment.

The Eagle now pictures the middle-decanate of Sagittarius. But tradition also associates it with the sex-sign Scorpio. When sex takes wings and soars on the pinions of regeneration to the utmost heights, it moves from the house of Death, from Scorpio, over into the house of Religion. In fact, it is only under the influence of religion, of the desire to spiritualize sex, that this transmutation takes place. Yet the religious aspirations expressed by Sagittarius, in turn are due to the sublimation of the love impulse. The Thunderbird of our Southwest Indians expresses this not less than the classical bird of Jove.

Love or desire is the motive power behind every action. It also stimulates every thought. Activity takes, therefore, the direction of the strongest desire; that desire so well symbolized by Crater, which is Jove's cup of wine and the goblet which carried the oriental soma juice.

The wine or soma is the stimulant; the desire which gives rise to action. Yet whether that action be powerful or weak depends not merely upon the stimulant, upon the desire, but also upon the amount of energy which is available. A weakened swimmer

may intensely desire to save his life; but unless there is sufficient energy available, he will be unable to make the shore. Desire alone is not sufficient for accomplishment; otherwise there would be more successful men and women. Desire can only direct such energy as is available into a definite channel of activity.

Scorpio is the great energy reservoir. It contains an energy which must be expressed through some channel. Since life began on earth those who have yielded to the mating impulse have left offspring, and those who have resisted the impulse to mate have been sterile. That condition remains today. Nuns and celibate priests seal the death-warrant on the Perpetuation of their strain. Those who successfully resist reproduction leave no biological heritage; they die out. Thus do only those racial strains survive in which the impulse to mate overcomes any artificial prejudice to remain barren.

Natural selection has thus, since life on earth began, been building up the power of the reproducing energy until it has gained such strength in every normal human being that it will not be denied expression. Yet nature has dictated no rigid channel through which alone this creative energy must flow. The extent to which it can be sublimated and made successfully to flow through more spiritual channels is an individual problem. All creative work, however, tends to afford it some expression; and many find it possible so fully to transmute into more spiritual endeavors that other expression is unnecessary to a completely satisfactory life adjustment.

Such spiritualizing of the Scorpio energy, expressing it on the higher side of Pluto, is pictured by the Eagle. The cup of Desire is the stimulant, but the Thunderbird, which is associated with Jove's lightning, affords the energy which is thus carried to the place where Religion dwells.

Nectar, ruled by Venus, the planet of love, symbolized the spiritualized essence of love. Saturn, the cold and crystallizing influence of selfishness is, quite naturally, bitterly opposed to the generous, free-hearted and benevolent Jupiter. To the extent this self-seeking influence of Saturn is present are the unselfish impulses of Jupiter in danger. The best way to escape such danger is for the benevolent tendencies to keep away from those seeking only the interest of the material self. So doing, the Higher Mind and Religious Life are fed with the nectar of a spiritualizing love, carried to them by the energy of the Eagle.

As portraying an ideal sex influence, the Eagle is uncommon among birds. With a few exceptions our feathered friends are either polygamous, like the barnyard fowls, or mate only for a single season. But the Eagle, used by the ancients to represent the most spiritual influence of sex, such as conforms to the true Religious Ideal, mates for life. It thus represents that higher side of Pluto in which not only are the energies sublimated to a higher plane of expression, but in which those who are ideally suited one to the other, true soul mates, are united.

In their hunting habits, so strong of wing are they that they go, like the soul in dreams, exploring in far distant places, but always returning to their home, to which they are singularly attached. And the house which Sagittarius rules, the ninth mansion of the birth-chart, has dominion over dreams, and over all forms of astral travel. It is the house of long journeys, not merely of the body, but also of the mind.

When the mind explores the universe, even as Sagittarius is a dual sign, so also are the reports which it brings back into the region of objective consciousness of two distinct types. The one type reports the reality of the condition actually contacted. It holds itself strictly to an accurate account of what has been seen and heard, and what has happened. Yet life would sadly miss one of its most alluring phases if it had no power to create, no power to visualize something not yet a reality of substance, but which, under suitable circumstances might become so. In addition to reporting reality the artist, the composer, the writer, the inventor, and all who bring to life its highest joys, must have imagination.

Without imagination the mental life is sterile. But through its use the individual is able mentally to picture the condition or action which finds fulfillment for some desire. The first step in the objective realization of some wish is the formulation of that which is to be sought.

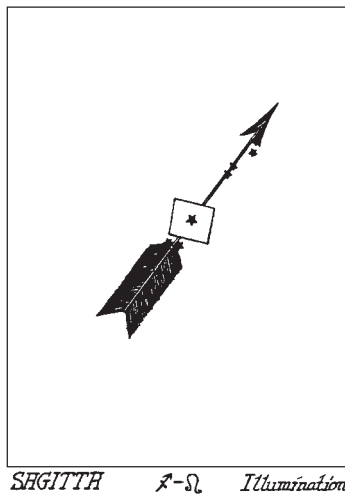

Figure 10-2

Third Decanate of Sagittarius

This image making power of the mind not only aids us to the concrete realization of our desires, but plays an important role in enabling us also to obtain some emotional satisfaction merely through associating with the mental images of the thing desired. People read fiction to enjoy vicariously the adventures of the hero and heroine, that is, to find satisfaction for impulses and desires which the practical requirements of objective life forbid. The thrills they long for, but dare not gain through action in the world of reality, they are able to indulge sufficiently to feel satisfied by going to the movies.

According to the dictum of scenario land, if you would produce a picture of unusual success, you must enable the audience to experience, through the screen actors, that which is most lacking in their own lives and which at the same time they most desire.

These images of things desired and of the things to be avoided permit an easier emotional response when seen upon the stage or screen, or presented from the pages of a book. The author has performed the labor of creating visual images, and of skillfully arranging them in a sequence that will arouse the desired emotional response. But each individual possesses and exercises, in some degree, this ability to form fantasies within his own mind.

This building of mental images through which the individual has experiences and feels emotions is carried over into the time of sleep. Such experiences are called dreams. All people have dreams.

In the waking state the mind travels from one series of experiences to another, constantly receiving new impressions or comparing those already received. And in the state of sleep it is no less active, moving from experience to experience, from sensation to sensation, without cessation.

Because the impact of physical environment, and the necessity of perceiving it correctly if the organism is not to suffer injury, tends to a habit of mind in the waking state in which commonly it concerns itself more with reality than with images of its own creation, most people in their waking hours do only a small amount of day dreaming. Within limits, however, it is optional whether the mind is engaged with fantasies or with realities.

In the sleeping state, because there is no such imperative necessity to keep the mind alert to realities, the common habit is chiefly to permit it to wander in fantasies. Nearly all people do, however, at times, direct their attention in sleep to actual happenings. Their dreams then give them warnings, or apprise them of conditions that later are recognized. The extent to which in sleep the mind becomes absorbed in images of its own creation is largely a matter of habit and training. That is, there is no necessity for the mind to engage in fantasy thinking during sleep, no more so than in the waking state. Either waking or in sleep both types of mental activities are open to it.

More difficult than perceiving realities while asleep is the work of bringing them into the memory of every-day consciousness. Yet through training the individual can bring back the reports of his explorations on the inner plane. This leads to the text: **In Sleep the Soul Wanders on the Wings of its Desires to the Region Most Attractive to it; Let that Region, therefore, Be the Highest.**

The Arrow that Slew the Cyclopes

—Sagittarius is the constellation of the Higher Mind and of Religion. Lyra depicts the method by which this mind tunes in on higher planes of existence and responds to inspirational harmonics from such upper spheres; while Aquila represents the power of the soul to free itself from the limitations of physical environment and travel to inner worlds, there to search for information. We may expect the third decanate of the sign, therefore, where the Sun may be found from **December 12 to December 22**, to portray still another high mental activity; and this it does; for Sagitta relates to **Illumination**.

This constellation is represented by an arrow, apparently let fly by the celestial Archer. Swifter than the horse of the Bowman, swifter even than the Great Dog represented, the middle-decanate of the Lower Mind, Gemini, the Arrow symbolizes the speed of thought, its unswerving aim, and its ability to strike the mark. As shafts of light penetrate the darkness, so do the higher powers of the soul pierce the clouds of illusion.

While the Sun is in this Arrow-decanate, the hours of darkness so increase that we have the shortest days of the year just at its end. Directly across the zodiac, where Gemini and Cancer join, is the decanate of the Giant Bear, typifying various other ancient giants such as the Cyclopes. These were the sons of Coelus and Terra, that is, of heaven and earth. They were three in number, Arges, Brontes and Steropes, and they occupied themselves in Vulcan's workshop, where they forged the thunderbolts used by the king of the gods, who benevolently rules the Sagittarian sign.

These thunderbolts, which thus they manufactured, represented, as yet they do to the Indians of our Southwest, the destructive use of the Scorpion's power, instead of its constructive use, such as is denoted by the Eagle or Thunderbird. And the Cyclopes who forged them represent **Reason**, which is the Key-word of the decanate where the Sun climbs highest, the place in the zodiac pictured by the enormous Bear.

These Cyclopes each had but a single eye, located in the middle of the forehead. They were several because Reason is employed in all the various material sciences. Yet in such work but one viewpoint is tolerated, the single eye which can perceive only the happenings and relations of the physical world. The Reason of material science is totally blind to the still more important factors and influences of the inner plane. It takes no account of them, and scoffs at their very existence.

Instead, therefore, of constructing a plan of human life which takes into account the persistence of the soul after the dissolution of the physical body, and the responsibility of each soul for the welfare of other souls in an eternally progressive scheme of existence, it forges doctrines of soul annihilation, thunderbolts which destroy all hope of life on other planes than this. One after another, physical facts are cited to prove all religion is superstition, that there can be no world other than the one which can be seen with the Cyclops eye, that great eye of physical discernment which materialism maintains is the only source of valid information.

Even as at the time of winter solstice, when the Sun has reached the end of the Sagitta-decanate, the nights are longest, so do the positive utterances of those who reason from the viewpoint of materialism cast a pall of darkest gloom over the struggling soul. For three days the Sun remains at this same darkest declination before starting back toward the north with its illuminating promise of life for another year; and of Cyclopes, therefore, there are three. But they were exterminated, according to Greek mythology, these three single-eyed giants, by Sagitta, the arrow sped from the bow of Apollo, god of the Sun.

Not force, not physical movement or physical action, dissipates darkness; but it is exterminated by the presence of light. Such light, the beams of which pierce the blackness of physical night, is represented by the celestial Arrow.

Wisdom alone, such as the speeding Arrow brings, however, is not all sufficient to the progress of the soul. Light it must have as a guide to action if that action is to lead to progression; but the action itself which permits the perpetual unfolding of its powers, requires another factor. As a companion to Wisdom, as its polar opposite, both of which in co-operation make evolution possible, there is Love. Love and

Wisdom are the avenues through which alone the advancement of the soul is made.

Therefore, while Sagitta stresses the importance of Wisdom, in the traditions of this heavenly arrow Love has not been overlooked. Mythology holds, not only that it is the arrow of the Sun, but also the one shot from Dan Cupid's bow. By this is implied that in true Illumination feeling, as well as knowledge, plays an important part; that it is more than an intellectual perception, that Love joins hands with Wisdom.

In the Hopi Indian ceremony of calling back the Sun, a ceremony held at the winter solstice just when the Sun has reached the end of the Sagitta-decanate, arrows which are violently thrown into a mound of earth by the Thunderbird man play an important part. And when Elisha lay dying, and Joash asked help of him before he departed, that their enemies might be defeated, mention is made of the horseman, that is, of Sagittarius, of the three—before the light begins to triumph over darkness after the Sun has reached the solstice—and of the arrows. II Kings 13, relates:

“And Joash the king of Israel came down unto him, and wept over his face, and said, O my father, my father, the chariot of Israel and the horsemen thereof. And Elisha said unto him, Take bow and arrows. And he took unto him bow and arrows. And he said to the king of Israel, put thine hand upon the bow. And he put his hand upon it: and Elisha put his hands upon the king's hands.”

“And he said, Open the window eastward. And he opened it. Then Elisha said, Shoot. And he shot. And he said, the arrow of the Lord's deliverance, and the arrow of deliverance from Syria: for thou shalt smite the Syrians in Aphek, till thou have consumed them. And he said, Take the arrows. And he took them. And he said unto the king of Israel, Smite upon the ground. And he smote thrice, and stayed.”

That from which men seek deliverance, as Joash sought deliverance from the Syrians, is the darkness of misconception. When the arrow of the soul pierces the illusions imposed by physical limitations, it then perceives the road it must follow to reach the desired spiritual attainment. But unaided Reason is quite inadequate to furnish this illumination. If sufficient light is to be had to see the way clearly an inner faculty of understanding must be brought into play.

When Reason, the one-eyed Cyclops, intrudes its presence, it quite effectually prevents that which spiritual men of all ages have referred to as Illumination. This state of consciousness is an identification of the individual with the knowledge sought. Instead of thinking about it, he feels the truth within himself. Yet such inner feeling can not gain recognition so long as ordinary mental processes are active. They must be routed, laid to rest, or otherwise vanquished, before the inner contact with the desired information can be felt.

In the use of any of the senses, even those of physical sight and hearing, we tune in on some particular aspect of a thing. That is, our eyes tune in on the light reflected from a surface, or our ears tune in on certain molecular vibrations. In this manner we recognize certain phases of physical existence. But when Illumination takes place, we tune in on the thing quite completely, on its inner character and its qualities. Identifying ourselves for the time with it, we know it from the inside and the outside in all its essential vibrations, and this gives rise to a knowledge of certainty about it.

The astral body has various senses, such as clairvoyance, clairaudience and psychometry, with which to perceive objects and occurrences from the four-dimensional plane. Yet the employment of these inner senses is not Illumination, it is merely the use of more effective organs of perception to get impressions about things. Such impressions, while more comprehensive than those gained through the use of the physical sense organs, only include certain aspects of the thing under consideration.

When, however, the individual can completely tune himself in on the subject of his attention, he so identifies himself with it that there is no sense of separateness; he seems to be that thing and to know all there is to know about it, both inside and outside. This information, or knowledge, instead of coming through the inner sense organs, is felt as if it were a light flooding the utmost recesses of the soul; hence its name of Illumination.

One should not conclude from this that those who experience true Illumination are never in error. Like all other information, to reach objective consciousness it must pass from the unconscious to the conscious mind. Therefore, whether the information comes through the physical senses, through Reason, through the astral senses, or through Illumination, it is always subject to the influence of any opinions or emotions that have a dominant power within the unconscious mind. These control the avenues through which the information must pass to reach objective consciousness.

If the information, however correctly received and true, does not meet the approval of these dominant unconscious factors providing such are present—they act as censors. The information can not pass them and reach the conscious mind until it conforms to their standards. For this reason information received through any channel should be checked as to accuracy in as many ways as possible.

Nevertheless, whether it is permitted to pass from the unconscious to the conscious without censorship or not, Illumination is the most satisfactory and comprehensive way of securing knowledge. To thus tune in on the desired information requires great concentration, hence the text: **Concentration is the Arrow that Pierces the Illusions of Matter and Makes Possible High Accomplishment.**

Chapter 11

Serial No. 81
Original Copyright 1935
Elbert Benjamine

Copyright
Church of Light
August 2002

News From the Summerland

Chapter 11

News From the Summerland

And Jacob Stole From Esau

—The solstices are those points in the zodiacal circle where, for a short time, the Sun stands, or stops moving in declination, and soon turns back to move by declination in the opposite direction. That is, on June 22 the Sun has reached its highest northern declination and the days consequently are longest, and on December 22 the Sun has reached its lowest declination and the days are shortest.

These days are much more easily ascertained than are the equinoxes, where the days and nights are equal; for on the longest day of the year the shadow cast by a stake at noon is shortest, while on the shortest day of the year the shadow cast by a stake at noon is longest.

The difference in the angles cast by the shadow on the longest day and by the shadow cast on the shortest day is, of course, the angular distance the Sun moves from its farthest south declination to its farthest north declination; and this divided by two gives the inclination of the ecliptic, or Sun's path, to the equator. By such shadows recorded at noon on the longest day and shortest day of the year the Chinese, in 1100 BC, ascertained the inclination of the equator to the ecliptic.

Slightly more than two hundred years before the Christian era, Eratosthenes, who had been brought from Upper Egypt to act as custodian of the Alexandrian Library, recorded similar measurements from the top of the library building at Alexandria. There he found the angle of the shadow at the summer solstice to be 7 degrees, 12 minutes. Six months later, at the winter solstice, the shadow showed an angle of 54 degrees, 54 minutes, 39 seconds. The difference, 47 degrees, 42 minutes, 39 seconds divided by two, gave the inclination of the ecliptic to the equator as 23 degrees, 51 minutes.

Then to the distance, 7 degrees, 12 minutes, that the Sun was south of Alexandria at the summer solstice, he added the distance thus found that the Sun was north of the equator at the solstice—23 degrees, 51 minutes, and some seconds which gave him the latitude of Alexandria as 31 degrees and a little more than 3 minutes. Present-day refined instruments give it as 31 degrees, 12 minutes, which is a difference of less than 12 miles from that obtained by Eratosthenes through the use of shadows.

It was because the day of the solstice could so easily be ascertained merely by watching the shadow of a stake, that the Aztecs, and those who possessed the same calendar system, began their year, not at the equinox, but at the winter solstice. The winter solstice, rather than the solstice of summer, was chosen because it was then that the days commenced to lengthen, the Sun having reached its lowest station, and a new period of increasing light was born.

Capricorn, which the Sun enters at the winter solstice, is an earthy sign; and as the Sun is then lowest in declination, this position often is referred to symbolically as a tomb or cave. Thus it is that Mithra, the Persian god of light, is held to have been born in a cave; and Jesus remained three days in the tomb before the stone was rolled away and he emerged. Pawnbrokers, who follow the footsteps of Jacob in taking advantage of the weaknesses and misfortunes of others, also display the three golden suns as the emblem of their trade; pledges being entombed until redeemed.

When the Sun has remained three days at its lowest declination, it then starts climbing, and continues to climb during the next six months until it reaches the pinnacle. This persistent tendency to climb, the ambition to mount higher and higher, is one of the chief characteristics of people born while the Sun is in Capricorn, from December 22 to January 20; therefore, the ancients who traced the starry figures in the firmament, to portray this attribute of both Sun and people born in the sign, employed the picture of a Goat, an animal which customarily moves to the mountain tops.

In addition to vaunting ambition, however, the natives of Capricorn also possess a flair for diplomacy. They are able to employ whatever is at hand to the best advantage, which gives to the sign its Key-phrase, **I Use**. And they are equally at home, and can adapt themselves to, any environment. Therefore, the ancient constellation represents not a common Goat, such as travels merely on the land; but one with the tail of a fish, which enables it, when occasion requires, also to live in the water.

The Greeks called the constellation Pan. And the legend is that one day Pan, with some other deities, was feasting near the bank of the Nile, when suddenly the dreadful giant Typhon came upon them. In order to escape they all were compelled to assume a different shape. In this camouflage Pan took the lead, Capricorn like, and plunged into the river, the part of his body under water becoming the tail of a fish and that part remaining in the air retaining the form of the Goat.

Typhon is the Egyptian conception of Saturn, the planet governing Capricorn. It is the planet of fear; and the fright which Pan experienced upon the appearance of Typhon, that is, the fright of Capricorn at Saturn, has been associated with a name which perpetuates the legend of the obsessing terror of those who fled a danger which was largely imaginary, on the bank of the Nile; for from this occurrence is derived the word Panic.

Astrologers hold that the best quality of Capricorn is **Diplomacy**, such as symbolized by the half fish half goat; but when this ability is abused it becomes the worst quality

of the sign, which is Deceitfulness. This use of false pretense to aid the ambition to climb to wealth and power is set forth quite clearly in Genesis 27.

Already had Jacob taken advantage of his brother's necessity to deprive him of his birthright; for in this story he represents the Capricorn influence and Esau represents the Sagittarius type: "And the Lord said unto her, Two nations are in thy womb, and two manner of people shall be separated from thy bowels; and the one people shall be stronger than the other people; and the elder shall serve the younger."

When the Sun is at the winter solstice the days of increasing darkness are thus separated from the days of increasing light, and Sagittarius is older than Capricorn in the sense that the Sun passes through it first; yet in worldly matters Capricorn is more shrewd and thus gains the advantage. Furthermore, "Esau was a cunning hunter, a man of the field," a typical outdoor Sagittarian; while, "Jacob was a plain man, dwelling in tents," with the Capricorn flair for trading and the desire to advance himself among people.

Isaac, the father of both young men, loved the generous spirit of his elder son, Esau, and when he was about to die called him: "And he said, Behold now, I am old, I know not the day of my death: Now, therefore take, I pray thee, thy weapons, thy quiver and thy bow, and go out into the field, and take me some venison."

But word came to Jacob, the Capricorn brother, that his father was about to bestow his blessings upon Esau; and advised by his mother, he sought by some cunning means to gain the blessings that rightfully belonged to Esau, as he by other artifice had acquired his brother's birthright. Instead of using venison, such as the Huntsman had gone to secure, he brought to his mother two good kids of Goats, ruled by Capricorn, from which to make the savory meat to please his father.

To still further deceive his parent, who was blind, when he brought the savory meat to him: "Rebekah took goodly raiment of her eldest son Esau, which were with her in the house, and put them upon Jacob her youngest son: And she put skins of kids of the goats upon his hands, and upon the smooth of his neck.

"And he came unto his father, and said, My father, I am Esau thy firstborn; I have done according as thou badest me: arise, I pray thee, sit and eat of my venison that thy soul may bless me. And Isaac said unto his son, How is it that thou hast found it so quickly, my son? And he said, Because the Lord thy God brought it to me. And Isaac said unto Jacob, Come near, I pray thee, that I may feel thee, my son, whether thou be my very son Esau or not. And Jacob went near unto Isaac his father; and he felt him, and said, The voice is Jacob's voice, but the hands are the hands of Esau. And he discerned not, because his hands were hairy, as his brother Esau's hands: so he blessed him."

When, therefore, Esau returned with the venison which he had been sent to get, his father was compelled to say: "Thy brother came with subtlety, and hath taken away thy blessing."

The sign of selfish Saturn is divided from the sign of benevolent Jupiter only by a thin line called the solstitial colure. The one sign relates to business and the acquisition of worldly goods and honor, the other to religion and the spread of useful information. We meet both types of people every day; the Esaus who are more than willing to work hard merely to please, who joy in the happiness of others; and the Jacobs, sly, cunning, scheming, caring nothing for the pleasure or welfare of others, but only by fair means or foul to gain an advantage and to further selfish ambition.

Such injustice will prevail so long as it is permitted. Therefore it is the task of those who have the interests of humanity at heart to devise means by which these selfish interests which grind down the poor and prey upon the helpless shall be prevented from their depredations. With such a significance the story ends with a prophecy concerning Esau: “And it shall come to pass when thou shalt have the dominion, that thou shalt break the yoke from off thy neck.”

Only at its worst does Capricorn relate to deceit. On its better side it relates to beneficial use. The text therefore, is: **Every Environment Offers Opportunities for Spiritual Advancement, and He who Makes Good Use of His Present Circumstances for Spiritual Ends Will Attract New Opportunities.**

News From the Summerland

—If Jesus was born at Christmas, as popular tradition holds, the Sun in His birth-chart was in the first-decanate of Capricorn, pictured by the migrating Swan. It had then just passed the colure where the days are shortest, and having had the three days at its lowest declination, had started back north again, bringing, as does the Swan, the promise of a new cycle of light and warmth.

At the opposite end of the colure is the point where the Sun six months previously had entered the watery sign Cancer, turning back from its northward journey as it entered the water. This going down, or decrease of declination, into the water at the summer solstice is typical of the ministration of John the Baptist. According to Luke 1, John the Baptist was six months older than Jesus, and therefore must have been born in the Cancer sign.

Furthermore, from the birth-sign Cancer on the length of daylight decreases, while from the birthsign Capricorn, where Jesus was born, the length of daylight increases; a condition recognized and made use of by John in the symbolism of his prophecy as recorded in John 3:30, “He must increase, but I must decrease.”

As the Nazarene brought the glad tidings, “Peace on earth, good will to men,” so the graceful Swan is first of the migratory birds to return in spring, when its appearance indicates, to those who know the way of nature, that ere long the tender shoots of grass will thrust through the soil, that verdant leaves will adorn the trees, and scarcity which marked the winter cold will give place to a more abundant season.

Swans are reared from downy youngsters in the icy regions of the north. But grown to adult size, at the approach of winter they take their departure from that region which so well, with its bleak hardness and cruel perils, symbolizes the environment which we call the earth.

Like some friends we have known, loved ones who already have passed, they leave the scenes of their early hardships, and wing their way to sunnier skies. As the stone was rolled away from the sepulchre, or lowest point of the Sun's descent, giving the promise of a future life, so also at their appointed time, do the Swans again return. Snow-white in purity, the most graceful of all that fly, with wide expanse of wing, nothing so readily suggests angels. Message bearers, coming from a brighter realm than this, bringing news of loved ones, and telling something of the surroundings there, where we too will live before many cycles of the Sun.

After all, in basic essentials, the conditions of the after life, which are promised by Cygnus, the flying Swan, are similar to those of this. There we shall live and work and love, not just as we do here, but with added abilities and with vastly greater facilities of expression. To the properties of existence with which we have become familiar, there is added another dimension. And this immensely increases the range of movement, thought and feeling. Everything is speeded up, given an intensity not known on earth, and instead of the slow process of physical adjustment, by which things here are brought to pass, in that realm the dynamic force is thought.

To build anything on the physical plane we require the application of energy to slowly moving physical substance. It takes considerable time, usually, to collect the various materials and properly to assemble them in the desired form. But, due to the peculiarities of a four-dimensional plane, the substance of the astral world can instantly be molded into any desired shape through the application of the energy of thought. A house thus built on the astral plane through visualizing and imparting thought-energy to it, is there quite as solid, perhaps more durable, and as useful for a home or office, as a similar building of concrete or brick on the three-dimensional plane.

The immediate responsiveness of the environment to the power of thought is probably the most striking feature of life in the realm where the soul finds itself immediately after it passes through the tomb.

By this same process can be built a private heaven or hell. Not that the wicked person can get away from the thought-cells which he has built into himself, and which attract him to an environment corresponding to their nature. But if certain images are so energetically impressed on the individual in his life that they dominate his consciousness, these images will surround him after death until he awakens to a realization of their true nature and origin.

The reports of those who have been in the after life only a short time are seldom very enlightening. One must live on the physical plane many years to know much about it. Even in the course of a lifetime the ordinary individual is acquainted intimately with only a small section of the globe, with only a little scientific knowledge, and with only a few of the happenings here. And while on the astral plane the reports of the astral senses may be consulted, which have a wide range, yet the regions of that four-dimensional world are so immense and varied that any comprehensive, even though general, knowledge of them can be gained only at the expense of considerable time and energy.

Yet those who have been on the inner plane for many years, who are investigative by temperament, and who apply themselves diligently to obtaining precise information about conditions as they there exist, do occasionally, like the migrating swans, come back as messengers to enlighten us.

Their reports, and the investigations of those still attached to the flesh who have journeyed to that realm, advise us that money is of no value there. Neither is false pretense nor sham. Everyone is known and esteemed for his real character and abilities, not for their semblance. And the only currency of any value there is that of service to the common good. Those who by their efforts contribute to the welfare of others, by that token possess a wealth reserve which they can draw upon. This they display in their characters, and perceiving which, others are pleased to render them willing assistance.

Having pointed out the two conditions that seem most strange from an earthly standpoint—that thought does things directly, rather than merely acting as a guiding force, as here; and that money has no value—it should, perhaps, be indicated in what way the after life is most strikingly like the one with which we are most familiar.

On the earth plane action is always in the direction of the strongest desire. That is, what we do is determined by those desires which are stronger than the combined influence of other desires which tend to prevent it, or tend to move us in other directions.

Furthermore, even while on earth, the thought-cells of the astral body which have been built by experiences and thoughts, attract to us environmental conditions and events which have a corresponding nature and corresponding harmony or discord.

It is this power of desire, and the influence of the thought composition of the body, which seems to be the most striking similarity between life on earth and life in the four-dimensional world. In that world, of course, all action being speeded up, the result of desire is more quickly apparent.

On the physical, one desires strongly to go some place, and after considerable time spent with some physical form of transportation—walking or riding—one arrives at the designated spot. But on the astral one desires strongly to be in the place and one is instantly there, provided its vibratory rate is not without the range of that which one is able to develop within himself. That is, one can thus immediately move to any

location or environment on the plane where he is able to function.

In the after life when an individual's desires are too low to find expression on the plane or level where commonly he functions, if they are maintained, the individual drops to a lower world where such thoughts can find expression. If they are vicious and evil enough, he may find himself in the so-called astral hells. But if they are higher than the plane on which normally he functions, if they are maintained, they ultimately will raise him to a higher world, a heaven, as it were, where their full expression is possible.

Whether from the standpoint of the physical world, or from that of the after-life worlds, the most important things of life are man's thoughts, desires and ambitions; for here and hereafter they are the factors determining his destiny.

To many people the after life seems a vague and nebulous region. Not because it really is so; for it is more vivid and intense and real than earthly existence; but because that which we personally have had little contact with tends to seem less concrete than those things with which we are familiar.

Had you endeavored to describe to the people of 100 years ago the world as it appears today you would have been met both by incredulity and by a total inability to comprehend what you were talking about. Moving and talking pictures would have seemed as amazing to them as the thought-created environment of the astral world seems to those who have had no experience with it. Automobile and airplane travel would have startled them as greatly as the across the planes travel of those in the four-dimensional realm. The radio and television would have seemed as improbable as the thought-transference method which is common to the astral plane.

Far places and unusual conditions, even those of Mongolia or the South Sea Islands, always seem hazy and unreal to those who have never visited them. So also, to most, does the scenery of the astral region seem bizarre and unbelievable. Yet it is not a weird region. It is a place where, with certain marked improvements, life is lived very much as it is lived on earth.

The Swans, returning from the south, like messengers bringing information from this after life, do not fly in loose flocks, but in well defined V-formation. The Key-word for the decanate represented by the Swan, where the Sun may be found from **December 22 to January 1**, therefore, is **Organization**. And the text is: **Under Certain Conditions the Stone is Rolled From the Entrance to the Tomb and Man Consciously Exchanges Ideas with Those Who Have Entered the Chamber of Death.**

The Dolphin Makes a Rescue

—Not only does Saturn, the planet of Capricorn, rule the grave, but it is when the Sun is in this earthy sign of Capricorn that it reaches its lowest point in the annual cycle, representative of the tomb. All three decanates, therefore, quite consistently, give some teaching in reference to the condition encountered after the stone has been rolled from the entrance of the tomb at the winter solstice, and the soul has left its tenement of clay and passed to more congenial realms. While, therefore, the constellation picturing the middle decanate of the sign, where the Sun may be found each year from **January 1 to January 10**, represents a Dolphin, it is not surprising that in various lands it is also known as a coffin. Among nations familiar with the Bible it is more commonly referred to as Job's Coffin.

The Dolphin, which is the picture of the constellation in the sky, is always represented as a beneficent sea dweller which performs good deeds and rescues from death those who are persecuted, especially those who are martyrs to some just cause. It is due to these legends, and to the observation that those born when the Sun is in this decanate often take up some worthy cause and work ardently for it in spite of its unpopularity, that the Key-word of the constellation is **Martyrdom**.

There are three Greek legends which give the outstanding teachings which the Dolphin was placed in the sky to reveal. One relates to the administration of strict justice in the after life; one pertains to the reunion of loved ones in that realm; and the other to the importance of harmonious thoughts as a means of attracting those who on the other side of life will assist the one who has passed from earth life to make a quick and satisfactory adjustment to the new conditions.

It is related that the famous poet Hesiod was slain and his assassins, in order to escape retribution, threw the body into the sea. They supposed this would be the end of the matter; but the Dolphins, who are the friends of poets and all who are benefactors to the human race, recovered the body and brought it to the shore, where it was found by Hesiod's friends. These then gathered together, and using the poet's own dogs trailed the murderers until they were captured; then threw them into the sea so that they should receive as punishment exactly the same kind of death they had caused the famous poet.

It is not always possible, in the after life, to make complete restitution to the person who has been wronged. But before much advancement can be made in that realm, injuries to others must be paid for, if not directly to them, at least by rendering some commensurate service to society. Unless we are willing to pay for our transgressions, their persistence as factors in our finer bodies weights us down, Saturn-like, so that we drop to lower vibratory spheres. As progress consists in moving to higher levels, and such movement is accomplished through refinement, these self-centered, destructive, and therefore downward pulling vibrations must be sublimated into those which are constructive and uplifting.

Repentance, like most other activities, can be approached from either a negative or a positive direction. All make mistakes, all take actions which later they regret. Under these conditions the negative approach is to feel sad and despondent, to dwell on the effect of the mistake and to feel miserable because it was made. Yet this sackcloth and ashes method of repentance is disastrous to the individual, and because it unfits him for constructive work in the universal scheme, still further injures society. The discords he thus cultivates attract to him misfortunes, and these hamper him and make him less effective in that which he should do.

The true way of repentance, either here or hereafter, is the positive approach in which the error is acknowledged, but is not dwelt upon in thought, nor permitted to cause mental anguish. Instead, the individual recognizes he has injured someone, or retarded the progress of society. He therefore focuses his attention, desires and efforts on paying this debt to society through doing something for the individual injured, or at least for society, which will be of as much benefit as he has caused harm.

Another Greek legend narrates that Neptune was very much in love with the goddess Amphitrite and greatly desired to marry her. This goddess, however, had taken a vow of perpetual celibacy, and consequently refused his proposal. Neptune, after pursuing his courtship in vain, finally called to him the Dolphin and told him his difficulties. Acting as a mediator, the Dolphin succeeded in persuading the goddess to marry the Sea-god, and as a reward was placed in the sky as one of the constellations.

Neptune in astrology is the octave expression of Venus, the planet of love. The love he rules is not the ordinary Venus type, but an expression which is devoid of the physical element; an ideal love which, rather than express in physical marriage turns to celibacy. Yet when those who thus love are able to sublimate their affections, so that they express as a complete circuit of energy which flows between the two, blending completely their thoughts and feelings, as pictured by the ribbon binding the two fish which Neptune rules, they are more truly married, in the inner sense, than those who enter merely physical matrimony.

Life in its various expressions tends to move from lower levels of expression to higher levels of expression. This is not merely true of the aims of action and the acquisition of ideas, but is equally true in emotional expression.

According to the findings of psychology the normal love life passes through well defined evolutionary stages, moving from an expression which is suited to the infant's capacity, to such heights and complexity as the individual is capable. These successive levels are now so well recognized that they each have been given definite names by which they commonly are recognized in psychological literature.

The infant's affectional interest, quite naturally, centers about himself. This level of the emotional life is called the Narcissus stage. As the infant develops there is a transference of his love from himself to a parent. This level is called the Oedipus stage. The third level is when the growing child transfers his affections from members of the family circle to some person of the same sex outside the family. This stage usually just precedes the change at the end of adolescence. The fourth transference, which normally occurs as the youth approaches maturity, is toward some member of the opposite sex. This stage is the level of marriage. The fifth transfer should not be from husband or wife, but merely a widening of the affectional interests to include the children, which normally are now a part of the family.

Neptune, however, when its influence is powerful in the birth-chart, is never content with this fifth level, or state of affectional expression. Up to this point Venus has dominated the love life; but it is here, if progress is to continue, that Neptune exerts his power.

The children grow up, marry, and have homes of their own. Thus the sixth level of expression of the love life expands the affectional interest to embrace humanity at large, and causes the individual to work as if he were responsible for its welfare. And if the proper transference is made, husband and wife are not less in love, but more so. Yet the physical aspect of union has been left behind, and instead, an inner exchange of energies takes place. This is the regenerate union, which is excluded by physical union.

Therefore, when the Dolphin persuades the goddess who has taken a vow of perpetual celibacy to unite with Neptune, it is indicated that after man has passed through the tomb he can rejoin his mate; but that, unless he remains in the lower spheres of the astral world, his affectional expression will not be similar to physical marriage, but will be that complete blending of finer forces which is even more satisfying, and which when accomplished on earth is termed regenerate marriage.

It seems, according to still another Greek story, that Arion, the famous lyric poet and musician, who was a native of the island of Lesbos, went to Italy with Periander, tyrant of Corinth. There he attained both high honor and great riches through following his profession.

After making such a success, it was quite natural that he should desire to return to his old home for a visit, and he embarked on a ship to make the journey. The sailors on the ship, learning of his wealth, determined to murder him and get possession of it. But just before they put him to death they granted him a last request; that he might play on his lute. The music attracted a number of Dolphins, and as soon as he was sure these were present, Arion jumped from the vessel into the sea, and one of the Dolphins immediately took him upon its back and carried him safely to land.

Paralleling this, there are those of the invisible world who, if we will but tune our thoughts to them, will be ready to help us make the adjustment to the after death life. Those who die in terror, those who with no preparation meet sudden death, and those

who are unduly attached to physical things, often are difficult to help for some time after their passing.

Commonly the individual after leaving the physical body falls asleep. This may be a long sleep, as in the case of an earth-bound soul, or it may be but a moment's lapse of consciousness. But during it the individual moves in his astral form to the level and place where his new birth takes place. This is not the environment where later he will find himself, but a transitional region. It is here he awakens into a knowledge that he has entered a new life.

His home on the inner plane is the type of environment which he has built for himself by his thoughts and desires while on earth. It may be a place of great beauty and harmony. On the other hand, if his thoughts have been filthy, so will his astral home reflect filth. If he has been cold and heartless, squalor will mark his after-life home, until he gets a more expansive attitude.

The text associated with Delphinus therefore is: **Man, by His Thoughts, His Emotions, and His Actions on Earth, Builds for Himself a Home in a Higher Realm where He Will Dwell After Passing From the Physical Plane.**

When Venus Met Typhon

—In ancient Sumeria the plots of land on which produce was raised were laid out, much after the manner of farming land today, in rectangles. The corners of these areas, to provide means of identifying ownership, were marked with boundary stones. These boundary stones, among other things, commonly bore an astrological symbol.

Thus it was, following the still more ancient custom of regarding that which is on earth as a replica of that which is in the sky, that they also sought to plot the heavens in a somewhat similar manner. While recognizing its spherical shape, they established corners, each corner marked by a first magnitude star, so that it was laid out as a great rectangle. The spring corner of the sky was marked by Aldebaren, the summer corner by Regulus, the fall corner by Antares, and the winter corner by Fomalhaut, a lonesome star rising far to the southeast, to be seen only close to the southern horizon. These four markers were later known as the four Royal Stars.

Fomalhaut marks the head of the Fish, Pisces Australis, which is pictured drinking, and swimming in, the water which flows down from the urn of Aquarius. Aquarius is the Man of the sky. Not only does he pour down an influence upon the earth, which is eagerly absorbed by Pisces Australis, but with one hand he measures the place and power of the heavenly bodies. That is, he represents not only the intelligence of those who have passed beyond the tomb, but also the energies of the signs and planets which descend from above to influence the life and destiny of man on earth.

The joining of the sign of the one who Knows, Aquarius, to the stream of planetary energy pouring down upon man, indicates not only that, like the Fish, man on earth is subject to this invisible flood, but that he should use his intelligence to take advantage of it. How this may be done is set forth in the universal symbolism of the Greek legend of Typhon and Venus.

Typhon is the Egyptian portrayal of Saturn, the planet of selfishness which rules Capricorn, one decanate of which is pictured by the Southern Fish. Venus is the planet of love, the influence of which is the natural antidote for the influence of Saturn. According to the legend, Typhon made horrible advances to the beautiful goddess of love, and to escape him she transformed herself into a Fish which now may be seen in the southern autumn skies.

A fish lives in the water, symbol of the emotions, and love must have an emotional environment to thrive. There is but one manner in which we can escape the Typhon of selfishness, and that is through love. Whenever and wherever there is absence of love of someone other than the Self, to that extent does love of Self take charge, with all its terrible implications. If, therefore, we are to escape Selfishness it is imperative that we acquire love of others, such as is symbolized by the Fish immersed in the humanitarian stream.

Yet there is a still more technical significance to this transformation which took place when Saturn and Venus met. Thought trends and planetary vibrations both utilize astral vibrations, and are quite similar in their power to affect the finer body of man. That is, certain groups of thought-cells are given additional energy, and therefore can perform additional work, whether the energy supplied them comes from the planetary vibrations of Saturn or the thought-vibrations of Saturn quality. The same thing is true of the influence of all the other nine planets.

Astrologers find, therefore, that the most effective manner of counteracting the undesirable influence of any planet is to cultivate a type of thinking which forms a natural antidote to it, that is, the vibrations of which either cancel out the influence of the planet, or combine harmoniously with it to form beneficial thought-cells which attract favorable events instead of the misfortunes which would have been attracted if the planetary influence had gone unnoticed.

To be more specific, the ancient initiates, as well as modern astrologers of the more enlightened class, looked upon planetary influences not as indicating inevitable events in the life of the individual, but as astral weather conditions which if not recognized tended to cause the individual to be attracted to the indicated event. If the invisible environment, such as the Southern Fish is seen to be swimming in, was harmonious, a knowledge of the direction of its flow would enable the individual to move with the fortunate tide and attain a success that otherwise would be impossible. But if the stream were adverse, if it represented a period of stormy astral weather, proper preparation usually would enable the individual to pass through the period uninjured.

There were three methods advocated by which planetary energies could thus be brought under control. These embraced the use of Rallying Forces, the employment of Conversion, and the application of Mental Antidotes. It is this latter method, which has the widest range of application, and can be used by the untrained individual as well as by those of special skill, which is indicated in the story of Venus and Typhon.

When there is an adverse influence from the planet Saturn, the best thing that the individual can do to counteract it is to cultivate a line of thinking and activity which is ruled by Venus. The thought energies having the Venus vibratory rate are of such a nature that when they unite with the Saturn vibrations they tend to produce a compound within the thought-cells of the astral body which has no inimical influence. Furthermore, the Saturn thought-element and the Venus thought-element quite readily enter into a very beneficial mental compound if they are thought about in association in a pleasant manner.

Venus and Saturn are only one pair of Mental Antidotes; for each planet is naturally related to some other planet in such a way that the vibrations of the two, or the thoughts which they rule, tend to unite in a harmonious compound very readily. Neptune, the octave of Venus, is also a mental antidote of Saturn. That is, not only does harmonious thinking of the Venus or Neptune type overcome the inimical influence of Saturn; but when the planetary influences of Venus or Neptune are discordant, this discord, and the misfortune otherwise attracted, can most readily be counteracted through cultivating harmonious Saturn thinking.

In the same manner thoughts of the Mars type most readily enter into harmonious compounds with those of the Moon or Pluto type. The Jupiter discords may most readily be annulled by cultivating thinking of the Mercury or Uranus type. This signifies also that when the Moon is afflicted the best type of thinking is that of a harmonious but aggressive nature; and that when Mercury is afflicted the best antidote is to cultivate the hail-fellow-well-met attitude, and the benevolence of Jupiter.

There is also a Bible story which revolves around the Southern Fish. It relates that Peter at one time was hard pressed for money with which to pay taxes. Relying upon the higher powers, he cast a hook into the water and drew forth a Fish which held a piece of money in its mouth, of sufficient value to meet the urgent need.

Those who take up some worthy work, especially if it be of a type which is encouraged by the better individuals of the inner plane, always find that they are under a somewhat similar protective influence. This does not mean that they will always escape danger, for the conditions may be such at times that those on the inner plane can not make their influence properly felt. This is not due to lack of desire on their part; but to the mental attitude of the one they wish to help, or to environmental conditions, which shut them off from him. It is then as if the Southern Fish were to desert the stream in which he normally lives, and for the time being is stranded.

Almost, or quite, every person who has become devoted to carrying out some noble work on the physical plane which has the support of invisible brethren, can relate experiences in which, when a crisis arose, he has been helped in a manner no less startling than was Peter when he so badly needed money. And it is significant that, as related in Matthew 17:27, the coin was not for the purchase of food, but for a purpose which comes under the same astrological rulership as friends on the inner plane; for both the dead and taxes are ruled by the eighth house of a birth-chart.

Yet even when the conditions for exchanging ideas with such friends on the inner plane are perfect, the amount of information that can thus be acquired by one on earth is dependent upon his mental capacity. Should an equation in differential calculus, for instance, be given to an individual not well versed in mathematics, it would be so meaningless to him that he probably would pay no attention to it. To bring things from the unconscious, which is necessary in such communication, there must be a bond of association between them and things already known and in the objective consciousness.

Those on the inner plane who have advanced in character and in wisdom band together in societies and groups, formulate better methods of living and higher standards of conduct, and make the endeavor to project these ideals to people yet on earth. The ideals of earth are thus received by those who are advanced enough here to receive them, from minds on the inner planes. For this reason, and because those born from **January 10 to January 20**, while the Sun is in the third-decanate of Capricorn, are particularly receptive to such exalted ideas, the Keyword of the Pisces Australis section of the zodiac is **Idealism**.

While such ideals, and valuable information, may be broadcast from the inner planes to all the earth for anyone who is receptive to pick them up; usually some one individual on the earth becomes the one through whom they are given to the world. This individual, through his basic character vibrations and intellectual interests, has an affinity for the ideals and knowledge given. His subsequent thinking about them and teaching them, keep him in the stream of vibratory influence flowing from those on higher levels, much as the Southern Fish lives in and absorbs the stream from the Aquarian urn. Thus the text becomes: **From the Inner Planes it is Possible For Man to Attract Any Information Whatsoever He is Capable of Utilizing.**

Chapter 12

Serial No. 82
Original Copyright 1935
Elbert Benjamine

Copyright
Church of Light
August 2002

In the Reign of
Aquarius

Chapter 12

In the Reign of Aquarius

Man Comes of Age

—To picture the eleventh sign of the zodiac, which in a natural birth-chart rules the house of friends, the ancients used the figure of a Man. This man, with his left, or receptive, hand measures the influence of the heavens by means of a 24 hour gauge; while his right, or executive, hand is engaged in pouring down upon the earth, from an urn, the flood of wisdom thus acquired. Because Aquarius expresses the highest type of intelligence developed on the earth the Key-phrase of this section of the zodiac where the Sun may be found each year from **January 20 to February 20** is, **I Know.**

It was long believed, and is now in process of being verified, that when the Equinox, which is the pointer of the Great Cycle of 25,868 years, just as the Sun is the pointer in the annual cycle of 365 1/4 days; when the Equinox should enter Aquarius, the sign of Knowledge, that the human race under that influence would make tremendous strides in science, in philosophy and in practical living. The Equinox moves backward through the circle of zodiacal constellations, not due to any movement of the Sun, but due to a wobble of the earth which causes the pole of the equator to move in a small circle about the pole of the ecliptic.

The earth is known to have five major motions. It rotates on its axis, bringing night and day. It revolves in an annual orbit around the Sun, producing the seasons. The Sun, accompanied by the earth, is moving at the rate of twelve and one-half miles a second toward the dividing line between Hercules and Lyra. The fourth major motion is that of the whole Milky Way System, or galaxy, which is turning, like a pinwheel, about its center in Sagittarius. By this motion the Sun and earth traveling at the rate of 150 miles a second, take 240 million years to complete one orbit about the galactic center. The rate of travel of the fifth major motion, by which the earth, Sun and all the billions of stars of the galactic system are carried along, is as yet unknown.

It will be seen that while the Sun, along with other suns, moves around a center in 240 million years, that this has nothing to do with the precession of the equinoxes. The precession is caused by the pull of the Sun and Moon on the bulging equator of the earth, which is not in the same plane as that in which the members of our solar system perform their revolutions. The gyration of the earth's pole as the result of the pull on the equator causes the point where the Sun each year crosses the equator to move backward through the circle of stars.

Signs of the zodiac are always just 30 degrees in extent. The constellations which picture the signs may be more or less than 30 degrees in extent. Cancer, for instance, covering only about 15 degrees, while Virgo covers about 50 degrees. Furthermore, there being no exact record of the boundaries of these constellations, they are not well defined, but only approximate.

When, therefore, the Equinox is said to have backed into the sign Aquarius, that does not mean that it has moved back to a point where some of the stars in the constellation Aquarius are located; because no one knows within a degree or two what stars should be included in the outline of the constellation. Instead, it means that the Vernal Equinox has moved back 30 degrees from the correspondence of the First of Aries among the constellations; because the sign Pisces (not the constellation Pisces), through which it has moved, by its very definition of being a sign, must contain 30 degrees along the ecliptic.

As the whole cycle by which the equinox moves through the 12 signs takes 25,868 years, the date when the Equinox entered Aquarius by the back door and the Aquarian Age started could be determined precisely by adding one-twelfth of 25,868 years, or 2,156 years, to the date when the First of Aries among the constellations coincided with the First of Aries among the signs.

Unfortunately, there is no undisputed record of the date when the First of Aries among the constellations thus coincided with the First of Aries among the zodiacal signs. We can not, for this purpose, elect the western boundary of the constellation Aries, because no one knows precisely where that boundary should be, or whether the picture as it appears on the maps of today is of the same size and contour as it anciently was. Thus there is no precise astronomical observation by which can be determined when the Aquarian Age began.

It would appear, however, that the First of Aries among the constellations must lie very close to the most brilliant and conspicuous star in the constellation Aries. This star, Alpha Arietis, now has a Right Ascension of 2 hours, 3 minutes. That is, the Vernal Equinox has moved back not quite 31 degrees since it was on the meridian occupied by this bright star in the head of the Ram. Calculating at the rate of precession by Right Ascension, in 1881 the Vernal Equinox was just about 30 degrees along the ecliptic west of the meridian of Alpha Arietis, so that if this star be used as a starting point for the circle of constellations, the Equinox backed into Aquarius just about 1881.

In determining the time of the commencement of the Aquarian Age, as it is mere assumption that Alpha Arietis is the starting point in the circle of stars, we are faced with a problem similar to that of determining the hour of birth of a person when the precise time has not been recorded. It is essentially a problem of rectification, such as all astrologers are familiar with in their natal astrology practice.

Within the time limits which for other considerations seem reasonable, the most satisfactory method of rectifying a birth-chart is through the comparison of the events which have happened in the life with the positions found in the chart, and with the progressed aspects. And by the same token, rather than make calculations from Alpha Arietis, or from other equally uncertain starting points, it seems better to ascertain the commencement of the Aquarian Age from a consideration of events which clearly are not of the type which are characteristic of Pisces, through which for more than 2,000 years the Equinox moved by precession.

Aquarius is a scientific sign, and during the past 50 years science has made greater advances than during the 2,000 Piscean years. Its ruler, Uranus, governs invention, psychology, electricity and the study of the stars. It has been within the past 50 years that the world has adopted electricity as an important source of power, that inventions have revolutionized industry, that astronomy has extended its boundaries from our solar system to the measurement of stars and other universes, and that psychology has come to be recognized as a subject that should be taught in our schools.

There is traditional basis also for considering that the Aquarian influence over world affairs started in 1881; but, as anyone familiar with Aquarius can hardly believe that present-day activities are actuated by the mere Belief of Pisces rather than by the Knowledge of Aquarius, to present other evidence would be to use space that can better be utilized in pointing to the most important developments which, now we are in the Aquarian Age, shortly will be with us.

Because Religion forms the pattern of human conduct, its significance is even greater than that of the industrial and scientific advancement now to be seen under way. Science, which is classified information, gives power to accomplish. But whether that power will be used for the benefit of the race or will enable the few to subjugate and exploit the many, is a religious consideration. It depends upon the attitude toward life whether selfishness shall rule, or the humanitarian spirit which characterizes the finer side of Aquarius.

Whether we like it or not, now that the world has moved into the astral current of Aquarius all institutions resting on a foundation of mere Belief will disintegrate. The orthodoxies of the Piscean Age are irrevocably doomed. Energy spent tearing them down is wasted, because their falsities already are disappearing, dissolving like the morning mists, faster than those who are enlightened can disseminate true knowledge to take their place.

All the facts that material science has to offer must fit snugly into the religion of the Aquarian Age. Not that the unsubstantiated theories of materialists should be included; for fashions in scientific theories change as often as do the styles in women's clothes. But all those things which have been proved a part of physical reality must be included.

Yet in addition to the facts accepted by the materially minded there is a vast field of carefully verified truths relating to planetary influence, relating to the development and use of other than physical sense organs, relating to the conditions that are present after the dissolution of the physical body, and having to do with the basic purpose of life itself. This information also, however wide its range and varied its character, and regardless of its conflict with preconceived ideas, must fit smoothly into the Aquarian religion.

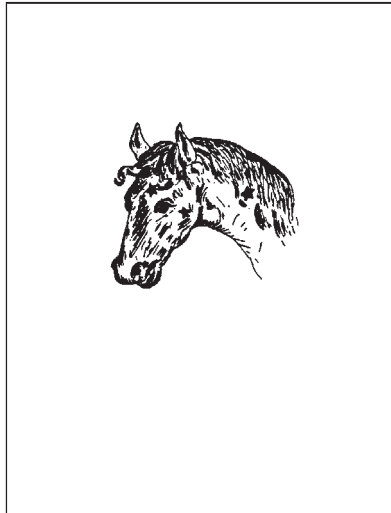

EQUULEUS ~-~ *Originalty*

Figure 12-1

First Decanate of Aquarius

All obtainable information must be organized into a single consistent structure and made practical in application. And as the zodiacal sign pictures a Man, this religion must provide man with the best possible method of meeting every contingency of his life. There is a best way to act under even circumstance wherein the individual finds himself, and this religion should be so comprehensive and yet so explicit that those who adopt it will have no difficulty in determining what is the best course of action under the conditions that confront them at any particular time.

Because knowledge of astrology is essential as a guide to such best course of action, and because astrological relations, through their correspondence with things on the earth and within the mind are the avenues to the more comprehensive Knowledge required by the Aquarian religion, the religion thus formulated should be called The Religion of the Stars. And as this religion is based on that wisdom which expresses the Aquarian spirit of altruism, the text associated with the constellation is: **Do and Think Unto Others as You Would Have Them Do and Think Unto You.**

The Significance of Horse Sense

—A horse immediately suggests two things, speed of travel and ability to carry a rider. The head of a horse, the animal's body missing, conveys the thought that the intelligence factor is to be considered rather than the physical propensities. To have Horse Sense is phraseology with which most people are familiar, even though it is not a refined expression. It indicates such a correct appraisal of circumstances that action of practical value can be based upon it. Yet the full significance of the Horse Head, Equuleus, as a universal symbol employed by the ancients to convey information, is not apparent until it is remembered that the sign Aquarius rules astrology, and that Equuleus pictures the astrology-decanate of the sign.

To be more explicit, the planet Uranus rules astrology, and the Aquarius-decanate of Aquarius is specially under his dominion and thus has an unusually close affinity for the starry science. Furthermore, individuality and inventive ability, wherever found in marked degree, denote the Uranus or Aquarius influence. Hence the Key-word for this section of the sky where the Sun may be found each year from **January 20 to January 30** is **Originality**.

Those who feel that they have so complete a grasp of the laws and principles through which nature operates that nothing can transpire not explained by the text-books used in formal education, jump to the conclusion that astrology is “exploded” merely because they do not perceive how it works, and because their teachers have so informed them. Yet such as so glibly proclaim there is nothing to astrology are free to admit—at least our foremost astronomers have thus admitted—that they have never tested the science out experimentally, and, in fact, would not know how to go about it to set up and read a birth-chart. Utterly unfamiliar with the rules, and often attributing to astrologers claims to omniscience which no well versed astrologer ever makes, they merely echo what happens to be academic fashion.

Horse Sense, which the general populace often possesses in greater degree than those who are bound by the tenets of formal schooling, demands that before condemning anything as untrue it should be tested out in actual experience. Theories are very fine, but the man in the street who has had numerous practical contacts with life, has come to realize that the accepted theories of the schools often fail signally in actual practice. He, therefore, is much less willing than the college professor to discountenance something just because he has no ready explanation for it. Following the dictates of experience, his Horse Sense informs him that the best way to find out if a thing works is not to theorize as to its possibility, or probability, but to actually test it out in practice.

Thus we find a peculiar situation in our land; the so-called learned schoolmasters denouncing the public because, more and more, that public is coming to lean on astrology for help. And the public, in spite of the condemnation of the schoolmasters who depend merely upon theories in such matters, gaining more and more confidence in astrology, because they have had the opportunity to test it out through actual experience. If a thing actually works and is decidedly helpful, the man in the street is not unduly concerned whether or not it breaks the conventional traditions of scholastic opinion.

Such gain in the popularity of astrology is made in the face of the unusually severe handicap that those who know almost nothing of the science, who are really astrological quacks through their flamboyant advertising are able to draw people into their clutches and give them misinformation under the astrological banner.

Because the public has had so little opportunity in the face of academic condemnation, to become informed as to what can and what can not be done with astrology and as to what constitutes a correct birth-chart, or even that it should be progressed if the time and nature of events likely to be attracted are to be given, it is easy for rank charlatans to flourish under the pretense they are astrologers, and to fleece the public of money. This also makes it very easy for the academic upholder of conventional tradition apparently to disprove the claims of astrology. All he has to do is to answer the advertisements of those who for a dime will tell your fortune from the cradle to the grave. To these he gives his birth day and birth year, such seldom even asking for the precise data necessary to erect a correct birth-chart. Then when he has collected a series of readings from these ten-cent advertisers, he has all the evidence he needs that astrology is false.

He does have, it is true, plenty of evidence that those who advertise to give something of immense value for almost nothing are charlatans. But he need not go to the get-rich-quick pretenders to astrology to prove this. He could learn it from a dozen other types of get-rich-quick advertisements found in the same periodicals from which he obtains the addresses of the fake astrologers.

But even with an array of such evidence he does not convince the man in the street, because that man already has learned that if he goes to a doctor, a dentist, or to any other professional man who makes exaggerated claims, and whose omnipotent services can be procured for a mere pittance, that he will be defrauded. He has learned not to expect something for nothing; and that in employing professional services of any kind it is necessary to consider reliability; and that those who have established themselves through merit do not advertise in the P. T. Barnum manner.

Primarily the birth-chart is a map of the astral body of the person then born. As a photographic negative bears the impress of light-waves reflected from the thing photographed, so the birth-chart pictures what the astral body of the individual then born contains.

This astral body holds within its organization all the experiences and mental states that the soul has had up to the time of human birth; these organized into stellar cells and stellar structures which form the character. The astral body, which the birth-chart maps, is thus a form built by mental and emotional states; and it is the function of the birth-chart to convey to the astrologer precise information regarding these mental factors and their relation one to the other as affecting the abilities and character, and therefore the destiny.

The relation existing between the most active, or dynamic, thought-built structures in the finer body, are mapped by aspects between the planets in the birth-chart. Relationships that are thus so constant and powerful build a line across the astral form, from one group of mental factors to another, and this line, which is mapped by an aspect, acts as an aerial to pick up energies which are broadcast from each of the planets involved in the aspect. Thus are those more pronounced factors of the character supplied with additional energy from their four-dimensional environment.

Whether that energy when received adds harmony to the astral body, or adds discord, is determined by the way the mental factors were organized, which is mapped by the aspect.

Thus from a consideration of the character, which is mapped by the birth-chart, it is possible to determine the natural abilities, and the normal trend of the events attracted; for these are shown by the organization of the character. This does not mean that the individual can not develop abilities other than those shown in his birth-chart; but that experiences before human birth already have developed certain types of ability, and he can utilize these natural talents with great ease. To develop qualities which are not shown in the birth-chart requires great expenditure of energy, for it means building into the character qualities which have had no previous existence there.

Furthermore, the birth-chart, in mapping harmonies and discords, reveals whether or not the individual will attract fortune or misfortune if he engages in a certain occupation. Thus it is the function of the birth-chart to reveal not only the natural talents, but also under what surroundings the individual can use them to be of greatest benefit to himself, and to be able to contribute his utmost to the advantage of the world.

When, according to definite ratios, the planets in the sky move forward to make progressed aspects, these release energies within the astral body of man in such a manner that temporary lines are built across the astral body. These lines act as temporary stellar aerials which pick up in unusual volume the energy broadcast from the planets mapped by their terminals. Whether the new energy thus picked up, radio fashion, and added to the thought-cells of the astral body, are harmonious or discordant, and to what extent, is revealed by the particular aspect.

As such stellar lines, or aerials, leading across the astral body, terminate in certain compartments of the finer form, each of which contains the thought-cells relating to specific departments of endeavor, it can be known what phase of the life will be affected by this new energy, which gives unusual activity to certain thought-cells. This does not mean that the individual shall submit to foreshadowed misfortune in this department of life; but it does indicate that unless he does something about it things will happen in a certain way.

They will happen in the designated way because the four-dimensional cell-life within the compartment receiving the additional energy will start working from their four-dimensional plane to bring events to pass that correspond to the way they feel, and in relation to their department of life.

A progressed aspect thus indicates, not what will happen, but what will happen if nothing is done to prevent it; and it also indicates what should be done to prevent the event thus foreshadowed if the event is not desired, and what to do to get more benefit from the event if it is of a type which is beneficial.

Common Horse Sense, such as is pictured by the Horse Head, Equuleus, demands that the individual shall take advantage of all knowledge which will enable him to make a greater success of his life. The text therefore is: **Next to Love, Man's Most Useful Companion is Knowledge, and in Particular the Knowledge of the Manner in which the Planets Influence Human Life and Destiny.**

On the Wings of Pegasus

—The next decanate to the one which relates to the employment of horse sense is also pictured by the fore parts of a horse. The head, which implies intellect, is pictured; and in addition the front legs. Unlike those horses of earth which keep their feet upon the ground, this one also is equipped with wings. The intelligence which it represents consequently must be such as soars to other than physical realms.

The travel-decanate of Aquarius, where the Sun may be found from **January 30 to February 10** each year, is represented in the heavens by famed Pegasus, the Flying Horse.

When, according to the Greek story, Perseus had slain the Gorgon Medusa and cut off its head, he mounted on wings furnished him by Mercury, and sped homeward carrying the awful monster's head. It was blood which dripped from this symbol of the imagination falling into the ocean, that is, imagination vitalized by emotion, from which Pegasus sprang; a powerful steed whose other name is **Inspiration**.

All poets, it is said, before they can attract the Muse, first must drink at the fountain created by a blow from the hoofs of Pegasus. It seems that Pegasus in flying over Mount Helicon struck the ground sharply with his hoofs, and water instantly gushed forth; the sparkling clear spring of Hippocrene. **Inspiration**, which is the Key-word of the Gemini-decanate of Aquarius, pictured by the Flying Horse, does not flow without a definite contact with the earth. That which the unconscious mind perceives, before it can come into objective consciousness, must be touched, or associated with, something already in the objective mind. Only through such physical association can it be externalized on the physical plane.

Neptune is the planet which rules all forms of dramatic ability. It is related that Neptune tamed Pegasus and gave him to Bellerophon, son of the King of Ephyre, to aid him in conquering the Chimaera. This was a sea-monster composed of incongruous parts, the origin of the word chimera, which signifies foolish or wildly fantastic creations of the imagination.

If Neptune were to succeed in the production of high art, these incongruities of the imagination must first be slain. Pegasus, representing Inspiration, aided in overcoming such vain and discordant fancies, as he is said always to aid those whose work—poetry, painting, fiction, scenario or music—presents true dramatic worth.

Such drama does not appeal directly to the intellect, but to the emotions. And the source of the ability to produce it lies not so much with the intellect as with a more

primitive method of thinking which employs feeling rather than ideas. It is the method of thinking which, because it has been so long in existence, is employed largely by the unconscious mind.

The use of well-defined concepts, such as commonly are expressed in words, is the last biological development of earth. It is confined to members of the human race. Such intellectual processes are not intimately associated with body states, but deal with relations through the use of special symbols that enable things to be examined and compared in the mind. These symbols permit of that type of mental activity called reasoning.

Life, however, existed on the earth hundreds of millions of years before this type of intellectual endeavor developed. And all that time it was face to face with the necessity of successfully adapting itself to its environment. New circumstances continually arose, calling for correct appraisal of conditions, and for appropriate actions, if it were to survive.

The protoplasmic cell coming into contact with something without itself which provided food or other advantage, experienced a feeling which in a more developed state we call pleasure. Coming into contact with an outside condition which tended to destroy it, there was experienced that which in a more developed state we call pain.

The pleasure or pain experienced under any special condition resulted in action, more or less appropriate, which gave an advantage or led away from danger. The feeling also conditioned the organism, so that under the same conditions again it would move in the same way with even greater alacrity. Pleasure and pain not only stimulate to initial action, but establish a habit of moving in the same manner when the feeling is again present.

The soul or character, which now occupies and functions through the body of a human being, has in its past organized and lived in association with, countless lower forms of life. Progressively it has learned to handle such forms, advancing from a simple organism to one more complex as it gained in experience, and therefore in ability. All of this knowledge, all of this ability, all of this mentality, which it has acquired through its entire progressive existence, is stored in the astral body, or unconscious mind.

Since entering human life this unconscious mind has been in contact with the special symbols used in modern language. It has been trained for only a few short years in the employment of concepts, and in the process of reasoning. Such use of the intellect is a very late thing, something which has had opportunity to impress it for a matter of a few years only. The language of feeling, however, especially that expressed through the sympathetic nervous system, is as old as its first appearance in any life-form on earth.

The vegetative functions of the body, the regulation of the ductless glands, and, in fact, all but a few of our actions, are directed by the unconscious mind not through the intellect, not through the brain, but through the process of feeling. This language of feeling is that to which the unconscious mind has been accustomed for ages, and it employs other symbols than those modern ones which we term words.

If, therefore, we are to tap the reservoir of the unconscious mind, instead of directing our attention to cerebral processes, we must learn to recognize and interpret the language of feeling. And the artist who, through any medium of expression, arouses appropriate response from others must be able to express himself in a manner not so much to intrigue the intellect as to appeal to the feelings, and this he must do by employing language which is recognized by the unconscious mind.

To analyze, in terms of the intellect, a beautiful sunset or a musical melody; to pick it to pieces to discern its ingredients; is to destroy it. Such things appeal to the unconscious mind and use a language which by its symbolism arouses feeling. We are moved by feeling because for millions of years it was the only language which organisms were able to recognize.

Therefore, if we are to make available what the unconscious mind recognizes, or what it may gain through its exploration of the unseen realms, we must not limit it to the language of intellect, to which as yet it is so unaccustomed, but must learn to recognize the language which it preferably uses. By all means, the critical function of the intellect should not be abandoned; for it is a necessary tool in clear-cut discernment of reality. But in addition, we should cultivate the ability to recognize the feeling language of the unconscious mind and to interpret it.

To do this, attention must be paid to impressions, to feelings, and to symbols. When the unconscious mind is given to understand that dependence is being placed upon it to gather information, or to perform work, it will make an effort to do as required. It was accustomed for ages to being the exclusive agent for reporting to the organism conditions which were important to its welfare. But since it has organized a human form this function has been taken over almost exclusively by the intellect. It has formed the habit, therefore, of making no special effort to give reports or to gather information. But if this duty is turned over to it again in large degree, it will again become active, and can acquire knowledge to which intellect alone could never aspire.

Through practice, the nervous system can be made sensitive to vibrations, and to the impressions through which the unconscious communicates with the conscious mind. If such states of feeling are closely watched, and their reports later checked against actual events and conditions, as often as possible, the feeling method of thinking will again come into use to supplement the intellectual method of thinking. The unconscious mind will then find an avenue through which it can impart whatever information it possesses, or can acquire, to the objective consciousness.

Just how much Inspiration owes to what already is within the unconscious mind, how much to what it gains through astral travel, and how much to disembodied human

beings on the inner plane, who communicate their thoughts, varies with the individual and with circumstances. Yet all three methods are open to the mind which habitually uses both intellect and feeling in its efforts.

Those who lecture, or give messages from a public platform, often rely very largely upon the Inspiration they receive from the audience. The unconscious minds of all those present constitute a reservoir of information which is widely varied and of considerable range. If the platform worker is sufficiently receptive, the thought-waves coming from the various members of his audience enable him to tune in rather fully on their unconscious minds. He thus has available for his use not only the information which they are aware of possessing, but vast funds of knowledge stored in the unconscious mind of each of which the individual possessing it has no objective knowledge.

In addition to such mundane sources of Inspiration, those who become intensely absorbed in some subject, in their sleep, or voluntarily without sleep when they know how, frequently travel to regions on the inner plane where others are interested in, and engaged in investigating, very much the same thing. In this astral travel they have the opportunity to exchange news with others more advanced, and the information thus gained is brought back either consciously, or stored in the unconscious mind to be drawn upon as their feelings and thoughts, while the attention is directed to the subject, permit.

The text is: Under Special Conditions, while Still Maintaining Physical Life, it is Possible for Man to Free Himself from the Physical Body, to Visit the Homes of the Dead, to Enter the Halls of Learning, and to Bring Back in Full Consciousness the Knowledge Gained in Higher Spheres.

The Sad Experience of Jonah

—The legendary stories about giants such as Goliath, the Cyclopes and the Titans have their explanation in the zodiac in that point where the Sun reaches highest, the summer solstice; and their application to the life of man in reference to the ruthless use of reason and the development of selfish greed. These giants, however, are not pictured in the sky, but are known only through their relation to zodiacal position. They are destructive attributes which loom large upon the world's horizon. Yet there is another attribute which is even more far reaching, which is still more powerful for evil, and which is even more difficult to vanquish than these various types of selfishness. Its common name is Discord.

When the ancient wise men sought to picture in the heavens the force, or principle, which is most inimical to life, which attracts to man failure and disease, and which places the greatest obstacles in the way of progress, they looked about for some appropriate symbol. Because it is the emotional, or feeling, element which determines whether there is harmony or discord, and as water symbolizes the emotions, it was quite to be expected that they should select some creature living in

the water. This denizen of the deep, as discord is a distortion of that which is pleasing and symmetrical, is required to be frightful and unnatural; and because it was to picture so vast an influence, it must be large as well as terrifying.

Cetus, the Sea-monster, is such a creature, the distortion of a whale; and commensurate with the importance of the influence it represents, it has been made the largest of all the constellations.

There are many sources of discord in human life. Planetary influence affords one important supply. Thus it is quite fitting that the universal symbol of Discord should picture one decanate of the sign which relates to astrological influences. The thoughts afford the initial supply of discordant energy to the finer form; and it is thus again appropriate that Discord be placed in association with the sign of the Man.

From the standpoint of prevalency and potency there is no source of Discord in human life that can compare with that generated in the nuptial relations. Hence, recognizing that unions not based on love afford the conditions most favorable to building Discords into the astral body, Cetus was placed in the sky where it would picture the marriage-decanate of the sign Aquarius, in which the Sun may be found each year from **February 10 to February 20**.

Not in relation to the close association of marriage, which permits the discordant thoughts of each most readily to reach and affect the finer body of the other, but as indicating the general effect of Discord, the story of Jonah is enlightening.

Jonah had been given certain work to accomplish which he feared to do. That he shirked doing it was bad enough, but in addition he also harbored the Discords of remorse. The emotional disturbance resulting is well symbolized by the sea which was whipped by a tempest; for Jonah had embarked on a ship in the endeavor to escape that which God had called upon him to do.

When Jonah had been cast into the sea, a voluntary sacrifice to save the other men on the ship, the waters immediately calmed. Yet he continued in Discord three days, as indicated by the three days during which he remained in the belly of the Sea-monster. If Pisces, in which the Fish swim, be considered the sea wherein Jonah was thrown, the Sun must pass through its three decanates after the one pictured by Cetus before it reaches Aries, where the water comes to an end. When Jonah, after suffering from the Discord of a disturbed conscience, resolved his inner conflict by deciding to do that which he deemed to be his duty, he was released from the belly of the Sea-monster; that is, he was freed from Discord.

In the story of Andromeda, it was the boastful pride of her mother, Cassiopeia, that placed her in a position of distress. As so many in the world today are not responsible for the Discord which has overtaken them, so was Andromeda the victim of her mother's scheming ambition. The rock to which she was bound represents the materialism which demanded the sacrifice of her own spiritual aspirations to the false ideals of her associates.

Here we are concerned with Andromeda only to note that the Sea-monster, Cetus, who was sent by Neptune to devour her, is the type of monster which today destroys so many of our youths and maidens. It represents the Discords engendered, and fed from one person into the finer body of the other, when marriage is not a mutual love union, but a matter of material expediency. She was saved from this horrible death only by the arrival of her own Prince Charming, by Perseus, who loved her tenderly and made her his bride. That is, it was the harmony of true love and rightful marriage that saved her from the destruction of Discord.

On all planes of life Harmony is Life and Discord is Death. The health of the physical body is determined by the amount of harmony between the dynamic thought-structures of the astral body. The vibratory relations of the various thought organizations, one to the other, within the finer body reproduce themselves as functional and organic strength or weakness within the physical form. Thus it is in Stellar Diagnosis, to determine the predisposition to disease, the birth-chart is examined for its heaviest Discords. The most powerful Discord in the birth-chart is always the disease toward which there is the most pronounced predisposition.

That is, the most powerfully discordant aspect in the birth-chart maps the most pronounced discordant relation between the thought groups within the astral body. That such aspects thus reveal the diseases toward which there is a predisposition is not a matter of theory, but something which has been learned through the statistical study of thousands of birthcharts. The charts of 100 persons who have suffered from each disease are collected. Always there are similar pronounced discordant aspects in all the charts. These when tabulated in terms of percentage reveal the Birth-chart Constants of the particular disease.

This does not signify that any person in whose birth-chart these constants appear will inevitably suffer sooner or later from the given disease; but it does indicate that people who do not have these Birth-chart Constants in their charts will not have the disease; and that those who do have them will need to exercise precaution if they are to escape. Precautionary measures usually can be taken to prevent the development of the disease; but if its Birth-chart Constants are present, that person has weaknesses in his astral body which are reproduced in his physical body that will cause him to have the disease under conditions where another person not possessing these Discords would escape.

In such statistical work, in which the Discords within the finer body are determined which enable a given disease to manifest, the chart is also Progressed for the date when the disease first was noticed to be present. In this manner, using charts of 100 persons suffering from a particular disease, the temporary Discord that enables the disease to develop is also learned. This progressed aspect, which manifests as a temporary stellar aerial which picks up and adds additional discordant energy to the cells of the astral body that relate to the disease, then tabulated in terms of percentage, is called the Progressed Constant.

When the birth-chart contains the Birth-chart Constant of a particular disease and a time arrives when the Progressed Constant also is present, this warns the individual that he must use exceptional precaution to avoid conditions under which the disease commonly develops. and that he must use initiative to develop energies within himself, and conditions within his environment. which will prevent the disease from getting a foothold.

It is one of the functions of astrology to indicate just what the danger is, when it will be most prominently present and what should be done to prevent the affliction which the Birth-chart Constant and the Progressed Constant indicate is likely to develop.

Disease of the physical body is only one type of affliction to which man is subject. Yet all the other afflictions. such as financial loss. business failure, loss of loved ones, antagonisms from others; whatever misfortunes to which the individual may be heir, in a similar manner are mapped by Birth-chart Constants and Progressed Constants in his chart of birth.

These constants thus mapped, which show the nature of the misfortunes to which there is a predisposition. and the times when they are likely to develop. map specific Discords within the astral body. That is, whatever ill befalls the individual is always attracted by specific Discords within himself. And if he would free himself from them, even as Andromeda escaped, he must reorganize these discordant energies into harmonies.

These birth-chart aspects and progressed aspects merely map mental factors in the astral body; they are not the cause of the Discords. Furthermore, not only do the thoughts and feelings which originate with the individual have a power to build thought-structures such as attract good fortune or misfortune, but the thoughts and feelings of those with whom rapport is more or less completely established also feed similar energies into the finer form.

In the married state husband and wife are so closely associated that the thought energies and emotional energies of each find ready access to the astral body of the other. Thus they give each other mental treatments under the conditions of a close association which is most favorable for making the mental treatment effective. The avenues are open for the most ready exchange of finer energies.

Nor does the mere avoidance of marriage prevent the development of Discord. The basic urge for reproduction is so strong a factor in all normal life that the attempt to stifle it commonly leads to that form of Discord denoted by the Key-word of the decanate, which is **Repression**. Yet if marriage is to be beneficial the energy exchange must be harmonious. Hence the text is: **The Monster Which Demands the Sacrifice of the Fairest Youths of the Land is Discord in Marriage.**

Chapter 13

Serial No. 83
Original Copyright 1935
Elbert Benjamine

Copyright
Church of Light
August 2002

The Tree of Life

Chapter 13

The Tree of Life

The Eternal Tie That Binds

—Virgo represents the Garden of Eden. The exercise of the critical faculty, which is within its special province, is the way to the Tree of the Knowledge of Good and Evil. Yet information alone, no matter how comprehensive, is not sufficient to attain everlasting life, as the Bible clearly implies in Genesis 3:22:

“And the Lord God said, Behold, the man is become as one of us, to know good and evil: and now, lest he put forth his hand, and take also of the tree of life, and eat, and live forever.”

The Bible then abruptly changes the subject. Having indicated that there is a Tree of Life, partaking of which man might live forever, it leaves man to his own ingenuity to find where it is located. Yet to anyone conversant with the ancient stellar doctrine that eternal progression depends upon both Love and Wisdom, and with the first principles of astrology which reveals that Polar Opposites, such as Love and Wisdom surely are, always occupy opposite stations in the zodiac, there could be no mystery where the Tree of Life must be located in the sky. It must lie across the zodiac from the Tree of Good and Evil.

Virgo holds a branch from the Tree of Good and Evil in one hand, and Hercules, picturing the middle decanate of the sign, holds another branch from that tree, on which the fruit yet hangs. The polar opposite of Virgo is Pisces. Pisces, because more appropriately it pictures the process by which eternal life is gained, and because a tree would not be a suitable emblem in the water where the Fishes swim, does not show a tree; but two of its decanates do. The Pisces-decanate of the sign presents a scepter made from the branch of a tree, held in a ruler's hand. That is, he is king over life and death. And the last decanate of the sign is pictured by a queen, who holds a branch of a palm tree in her hand, very much as does Virgo.

Furthermore, Pisces is the sign where the physical cycle of life ends. If there is to be still further life, such as indicated by the new cycle commenced in Aries, those processes which lead to revitalization should be commenced before the time of transition thus indicated. These are the processes so clearly indicated by the ribbon which binds the two Fishes of Pisces into an indissoluble union.

Specialization of parts—mechanics, statesmen, agriculturists, writers, artists, etc.—is familiar to us in that complex organization which we call our social system. And we also are familiar with the fact that two elements united often produce a chemical compound with possibilities tremendously more significant than the same two chemical elements possess when not so united.

We may be sure, therefore, that the ancient masters who traced the constellations in the sky did not unite the two Fishes of Pisces into a single system without having information of profound import to convey. They are not united rigidly, as are the cells of the physical body, but by a long ribbon which permits each Fish to move about without undue restriction from the other. Each thus seems to be permitted the exercise of its own initiative; but belongs to a system from which it can not separate.

Before attempting further to trace the significance of this universal symbol, let us see what the Greeks had to say about the constellation Pisces. It is related to a watery sign, and thus to the emotions. It is the exaltation of Venus, the goddess of love: that is, love finds its highest expression through Pisces. And it is ruled by Neptune, the upper-octave expression of Venus. Such expression, if it be true to the upper-octave significance, relates to interior states which physical manifestations of love are unable to penetrate. They have their significance chiefly where the astral body is concerned.

The Greek legend is that Venus and her son Cupid one day were strolling along the bank of the river Euphrates, when quite unexpectedly Typhon put in an appearance. To escape this selfish monster, typical of Saturn, Cupid and Venus leaped into the water and transformed themselves into the two Fishes. To commemorate this event the Pisces Fishes were placed in the sky.

Venus and Cupid represent love. The Fishes into which they were transformed are denizens of the water, and thus signify emotions. While love has a binding power, the ribbon by which the two Fishes are united, to be true to the rulership of Neptune, must represent an actual invisible energy which unites them, but which does not greatly hamper the movements of either.

Love manifests on various planes or levels. But on the human plane, when there is natural harmony between the inner natures—that is, vibratory affinity between the finer bodies—and love has developed between the two persons of opposite sex, they easily and rather constantly tune in on each other's vibratory rates. Depending largely upon the activity of their inner forces and the state of their spiritual development, a circuit, or endless belt of energy forms between them. That is, there is a continuous current of astral energy circulating between them, much as there is a circulation of blood through the physical body of the individual.

This circuit is indeed a current of life, possessing amazing potentialities. These potentialities are commensurate to the height of the basic vibratory rates of the two between whom the circuit flows, and to the amount of energy generated by their love, each for the other. Not uncommonly those in love experience the blend of forces which if unbroken develops into this current. Some also are aware that such a current

is in existence. But, as it belongs chiefly to the inner plane of life, mental discords tend to break it, and physical sensations tend to dissolve it.

It must be cultivated if it is to persist; and that cultivation must be along the line of developing and maintaining intense and tender love, each for the other. Grosser feelings and passion will effectually destroy this fine belt, or ribbon. It is sensitive to all lower expressions, and thrives on feelings which relate more to spiritual states than to those physical.

Selfishness, portrayed by the giant Typhon, is so restrictive in its influence that when it is present even in minor degree, and even when not related to the object of affection, it tends to destroy this endless belt of love. To maintain it those whose love has reached a plane where it can form such a ribbon of spiritual potentiality must expand their affections to embrace all creatures. The desire to destroy another, to deprive another of that which is justly his, or to in any way cause suffering to any living thing, tends to disrupt this fine ribbon by which the loving souls are joined.

The knot where the ribbons uniting the two Fishes are tied represents the Ego which is common to both souls, and which is the eternal spark of Deity by which they are energized. Thus the two souls and their Ego form a distinct system, which when so organized becomes a true spiritual cell in the cosmic body. Such a soul-mate system, or spiritual cell, has a distinctive form on the inner planes; and when made permanent is commonly referred to as an angel. It then no longer belongs to four dimensional existence, but by virtue of its new capabilities is typical of the truly spiritual, or five-dimensional plane.

The two souls comprising the angel do not lose their identity; no more so than Venus and Mars lose their identity because they both belong to the solar system. Liberty of action on the part of each soul is still retained; but before they are thus permanently united in a single five-dimensional form—as the two Fishes with their ribbon have a single form and yet each Fish has wide liberty of action—they must have come into a realization of their Cosmic work.

As an angel they perform the function in the cosmic scheme for which they have been specially educated by their experiences; and in this work they have complementary abilities. That is, each supplies certain talents, those of both together enabling them to do their Cosmic Work.

We may be sure, therefore, that those capable of uniting through the endless belt of finer energies that ultimately will provide the form of such an angel, will not have diverse or conflicting interests. Such divergent interests, through centering the mind strongly on different things, tends to disrupt or dissipate the endless belt of energy flowing between two people. Where the interests are, or an objective of attainment, in that direction the finer energies tend to flow. That is, the energies flow wherever the attention is directed. But when the interests of both are centered on the same things there is no dividing of the energy stream, and the forces of both flow along a single channel. This strengthens the bond between them.

The conditions which are most favorable, when the natural requirements are present, for strengthening the endless belt of finer energies between those who are deeply in love, are the desire to be as helpful and beneficial to all creatures as possible, having a common work by which this is chiefly accomplished, and the cultivation of tenderness and sympathy one for the other.

Neptune, the upper-octave planet ruling Pisces, is idealistic in his expression. Therefore, those who cultivate this highest expression of love on earth find it advantageous to idealize all they do. Whatever they do which they feel to be worthy, in the doing they keep the image of their loved one before them and feel that they are doing that thing, not because of duty, but for the sake of the other one. All that is accomplished is thus done for love. And the love motive becomes so powerful, under such cultivation, that hardships are not recognized as such, all life is filled with joy, and great accomplishment results.

The joy coincident with the establishment of the endless belt of love is only a small feature of its advantage; for its power to accomplish, working from the four-dimensional plane when loving and constructive thoughts are carried by it, is truly amazing. Herein lies a force which makes Faith, even of the size of a mustard seed, able to move mountains. The Sun is in the decanate pictured by the Fishes from **February 20 to March 21**. Its Key-phrase is, **I Believe**, and the text is: **Love is the Tree of Life, and its Fruit is Universal Brotherhood.**

The Two Keys of St. Peter

—Cepheus signifies a rock, and the constellation in the sky designated by this name pictures the King of Ethiopia on his throne, with one foot upon the immovable Pole Star, representing Truth. Both Sagittarius and Pisces are dual signs, and both through Jupiter, which is the ruler of one and the co-ruler of the other, have some significance in matters of religion. Joseph, whose, “Bow abode in strength,” represents Sagittarius, the duality of which is symbolized by his coat of many colors. It is this coat which Cepheus, or Pharaoh, whom Joseph served so well in the land of Egypt, still holds in one of his hands.

Pisces, the decanates of which are pictured by the king, queen and princess of Ethiopia, is the sign of imprisonment, deceit and secret enemies. It belongs to the dark half of the year. Joseph, representing the sign of dreams and prophecy, Sagittarius, told his dreams to his brethren, and these, in true 12th house fashion—for it is through its natural rule of the 12th house of a birth-chart that Pisces signifies these things—conspired secretly to destroy him. They took from him his coat of many colors, with which to deceive his father, and threw him into a pit, representing the sign Capricorn, lowest position of the Sun, into which this luminary moves immediately after it leaves Sagittarius.

Sagittarius is the sign of long journeys, hence Joseph when removed from the pit was taken to a far land. Pisces, through the 12th house, rules imprisonment and involuntary servitude; and not only was Joseph sold into slavery, but due to the

perfidy and deception of Potiphar's wife, while in Egypt he was thrown into prison. And even, while still in Egypt, desiring to bestow a favor upon his brethren, he did it through deception. He concealed the money they paid him in the sacks of grain sold to them, and in addition concealed his cup in the sack of Benjamin, that he might have an excuse for detaining him.

The Pharaohs of Egypt were not only the rulers of this land of darkness, but they also were the religious potentates, some of whom had undergone initiation. It was the common thing for them to consult with their high priests, even as Pharaoh called upon Joseph to give him council, in all important matters based upon conditions which would arise in the future. The priests who thus advised the ruler were versed in both astrology and in such divination as gained Joseph renown.

Peter, of New Testament mention, is a name which, like Cepheus, means rock. And it was upon a rock that Peter was commanded to found his church. In the sky this is, of course, the rock of ages, otherwise known as the Pole Star, which changeth not; the symbol of eternal Truth. Cepheus thus not only represents Pharaoh, but in a later story pictures Peter, whose foot, or understanding—and Pisces rules the feet—must rest on Truth; and who holds the keys to hell and heaven.

These keys, by which Understanding of the Truth may be gained, are not pictured in Peter's hand, but adorn the crown Placed on his head. They are shown as seven little spheres, representing the septenary of planets. They are placed on his head because the head is the region representing intellect; and it is the comprehension of the significance of these seven types of energy that opens the gate to an Understanding of Truth, which in turn permits entrance to the higher realms of being.

Peter, as shown in the sky, in addition to Joseph's coat of many colors which he grasps in one hand, also has an implement of power in the other. Understanding alone does not open the heavenly gates. That understanding must be applied in action. Therefore, he holds aloft a scepter, of a form symbolizing the virility and energy of the Sun, a symbol of the same import as the Common Gavel of Ancient Masonry.

Thus does this ruler of life and death, of the external world and the astral kingdoms which belong to the 12th house, indicate that he both knows the Truth, and that he applies that knowledge in appropriate action. The scepter of power indicates creative energy under control, and directed as the ruler wills. The control of energy such as the scepter represents indicates that scepter to be one symbol of the Tree of Life.

Joseph and Pharaoh are not only linked, as types of Sagittarius and Pisces influences, in the Old Testament; but in addition to the Keys which Peter holds, the New Testament in Revelation mentions a Book of Seven Seals. Sagittarius, as natural ruler of the 9th house, the house of publishing, relates to books; and the seven seals are the impress which the seven planets make upon the Book of Nature. Yet this book, which rightfully belongs to Sagittarius and not to Pisces, when mentioned in Revelation is associated with the constellation Cepheus: "And I saw in the right hand of him that sat on the throne a book written within and on the backside, sealed with seven seals."

Cepheus, or Peter, pictures the Pisces-decanate of the sign which has rule over the astral plane and its denizens. Sagittarius is the sign of religion, seeing clearly and expressing benevolently. Pisces has a religious significance also; but it tends to rely on blind belief; for it is the sign of secret things and of self-undoing. It is because the denizens of the astral plane through the Pisces tendencies have been able to impress their ideas upon the human race, causing it to place Faith in those things which are to the advantage of these selfish astral entities, that the race during the Piscean Age was so bound and fettered by its religious misconceptions.

To state the matter in another way, the unseen enemies of mankind belong to the 12th house, ruled over by Pisces. Elementals and earth-bound discarnate human beings are close to the vibratory level of the earth, and are best able to contact it through the conditions represented by Pisces. Through the deception they are able to practice they can in some measure control the trend of human events, and themselves gain a satisfaction for their own desires. Obsession relates to this section of the zodiac, as do mystical manias and religious fanaticism; these being extreme expressions of the influence of such astral entities upon human life.

Pisces, however, is a dual sign; and in the higher expression of its attributes it founds its beliefs upon the very Rock of Truth. The astral plane holds entities which practice deception upon the people of the earth whenever they find those who are negative enough to be impressed. But it also, on its higher levels, provides a dwelling place for noble souls who have made extensive research on various planes of being. These, when opportunity offers, transmit facts they have learned to their neophytes upon the earth.

The knowledge and beliefs of those on earth are determined to a much greater extent than most realize by the influence of the invisible world. Not only do invisible entities impress their thoughts and desires upon those who unwittingly tune in upon their vibratory rates; but planetary energies stimulate thought-cells within the four-dimensional body of man, and these attract events and prompt to action. We can not say, as some Orientals do, that the physical world is maya, or illusion; for its energies also cause changes in the astral world; but we must acknowledge that most physical events and conditions trace their immediate cause to happenings on the astral plane.

We can not know the whole Truth if we ignore the physical world; but as the astral persists after the dissolution of the physical; as its sensations, experiences and scope are so much more vast than those of the physical; and as the immediate stimuli of physical movement are chiefly astral in origin; we can perceive the reason that prompted the ancients to place the constellation picturing Verity in that section of the zodiac which more than any other relates to the astral plane. The Sun is in this Pisces-decanate of Pisces from **February 20 to March 1 each year.**

Not only is the character of each life-form on the earth, that determines its destiny, embraced by the organization of its astral form; but the character so organized is that which persists beyond the dissolution of the physical. Man lives in his astral body, in

fact, is chiefly an astral organization, while still in the flesh. And the same organization continues to live on the four-dimensional plane beyond the tomb. Real life and real death, therefore, such as Peter holds dominion over, relate to the four-dimensional plane which is more closely associated with Pisces than with any other sign.

Verity, which is the Key-word of the constellation, is an accurate comprehension of the facts and their relations to each other. Such recognition of Truth permits actions that make a successful adaptation of the life-form to the conditions by which it finds itself surrounded. The keys which unlock the door of Truth also, therefore, unlock the doors of heaven and hell; for action based on falsehood and deception, such as one side of Pisces governs, leads to discord and destruction; while action based upon Verity, which the other side of Pisces governs, leads to harmony and eternal life.

Because all things in nature in their essential vibratory rates correspond to astrological influences, these astrological correspondences, such as are symbolized by the seven little globes in Peter's crown, are the Positive Key to that knowledge, which is essential to progress and to everlasting life. As a feminine complement to this positive key, to assist in unlocking the mysteries of the universe there is also a Receptive Key. This is embraced by the Tarot.

The golden key is the understanding of planetary law; for the character of each thing contacted is completely mapped by its astrological vibrations. The silver key is a duplicate of the one of gold, except that its action is feminine and passive, bearing the same relations to the latter that woman bears to man. In fact, the Tarot is to Astrology what the Moon is to the Sun. Astrology and the Tarot are known to initiates as the Two Keys. They are the Keys to Verity, the real keys for which Peter is renowned.

The text therefore is the Hermetic Axiom: **“As it is above so it is Below, and that which is Below is Like unto that which is Above.”**

Prometheus Defies Convention

—Paracelsus, according to all accounts, was the greatest physician of his day, performing cures where all the other doctors failed. Jesus offered harm to none except the cheating money-changers in the temple, healed the sick, and taught love and kindness. If one were less versed in the power of convention to bind all to old methods, and to persecute any who dare depart from what has been customary, it might be supposed that these great benefactors had been praised by their contemporaries. How Jesus fared need not be told; and Paracelsus was driven from place to place, his life constantly in danger from the members of his own profession, and was finally killed by ruffians believed to be in the pay of those whose outmoded methods of healing were less successful than his own.

On frequent occasions when machines have been introduced into some industry, those engaged in it have staged riots and broken the labor-saving devices. They believed that the machines would displace them; which was true if they were unwilling to learn how to handle the machines. A more successful method of healing also would take the livelihood from many members of the medical profession, as with less illness their services would no longer be needed; yet if they were progressive their energies could to advantage be turned into other equally valuable channels of human service.

It is almost impossible to advance any new method by which the human race can be benefited without this new method displacing the service, or at least affecting it, of some whose livelihoods depend upon it. And it is equally impossible to advance any new idea of importance by which the race can be benefited without it affecting the prestige of a large group of people who pose as authorities, or who hold some position of power which would be endangered if the new idea were to be generally accepted.

Progress is thus always gained only through conflict. In fact, progress consists of overcoming obstacles. And where human customs and human ideas are concerned the obstacles which cause the most acute conflict are prejudice and self-interest.

A thousand patents have been registered from successful models, and yet the labor-saving devices they represent, and the improvements in many lines which they could bring, lie dormant. These patents have been purchased by those who have money already invested in less useful things which would be displaced if better ones were placed upon the market. And to an even greater extent are ideals of high value to the human race suppressed by those with whose profits or prestige their adoption would interfere.

We need not think that the ridicule heaped upon Louis Pasteur when he advanced proof of the activities of bacteria in certain diseases, or the persecution of Galileo when he revealed the discoveries of his telescope, are new expressions of the antagonism of conservatives for those progressive. Even in a flock of birds, if one bird begins to act in an unprecedented manner the other birds become annoyed, and if the one departing from convention does not desist, the others birds set upon it, and either kill it or drive it from their midst.

Whether in that ancient time when the constellations first were given outline in the sky, or at the present day, if one were intrepid enough to break sharply with conventions, the least that could be expected was imprisonment. Throughout the ages those who have bestowed the greatest blessings on mankind have found themselves chained to the stone walls of dungeons. To depart too markedly from current practice or current belief, no matter how absurd it was, has always meant courting punishment.

Because such Self-Sacrifice has commonly been prompted by that sense of Universal Brotherhood which the higher side of Pisces promotes, and because Pisces, through its 12th house affinity relates to imprisonment and crime, the

ancients placed Andromeda, the Chained Lady, in such a position as to picture the middle decanate of Pisces, where the Sun may be found each year from **March 1 to March 11**.

The Key-word of the decanate, **Self-Sacrifice**, is set forth in the universal symbolism not only of the story of Andromeda, but in that of Prometheus also. In the case of Andromeda the coast of her native land was being ravaged by the Sea-monster, Cetus. This was through no fault of the fair princess; but had been brought on by the arrogance of Cassiopeia, her mother.

Cassiopeia had incurred the wrath of Neptune, who was quite justified in resenting her claim to be more beautiful than the Nereides, nymphs of the sea; and Neptune, ruler of Pisces, had sent the Sea-monster to bring destruction to her land. Jupiter, planet of religion, was appealed to in an effort to save the country; and he decreed that only through offering her daughter as a sacrifice to the Sea-monster could Cassiopeia atone for her sin. Andromeda, therefore, not because she had transgressed, but to save her fellow countrymen from death, was chained to a wave-washed rock in the sea for Cetus to devour.

We who are interested in presenting The Religion of the Stars to the world, bringing, as it were, the fire from heaven that all may benefit thereby, find the story of Prometheus even more significant. Prometheus, in the first place, was out of favor with the gods because he ridiculed some of their exaggerated pretensions. He was very much in the position of some of us who have actually traveled on the astral plane and had opportunity to observe the conditions there. He did not believe in the current ideas; no more than we believe the materialists who say that when the body disintegrates the soul exists no longer; nor the orthodox who say that a soul who transgresses must suffer eternal torment in hell and that heaven is devoid of useful occupation.

Those now who make actual demonstrations that the soul survives the dissolution of the physical body, and those who make actual demonstrations that the planets affect the life and destiny of man, are somewhat in peril of imprisonment. The materialist says the soul of man does not exist after the physical is gone, and can not come back. The orthodox says that it does exist somewhere. But if you stage a demonstration to prove that the so-called dead still persist and have recognizable personalities, you open yourself to persecution. A city ordinance—depending on the city—may demand that if you do, or if you help some unfortunate person through giving astrological advice, you must go to jail.

Prometheus, however, was not to be deterred through fear of gods or men from actions which he felt convinced would benefit the human race. Like the valiant souls of all ages who are responsible for the world's progress, he was willing to sacrifice his own interests if thereby mankind might be benefited. So, with the assistance of Minerva, he climbed the heavens and stole fire from the chariot of the Sun, and brought it down to earth, that man might have its use.

This so provoked Jupiter that he ordered Prometheus chained to a rock, even as Andromeda may now be seen chained, where a vulture was to feed on his liver. His liver thus consumed by day, grew again during the night, never entirely exhausted.

As the liver plays so significant a role in this story, it should be explained that the ancients as well as we moderns place this organ of the body under the rule of Jupiter, the planet which rules the 9th house in a natural birth-chart, and thus also religion and public expression. The liver of Prometheus, on which not the fearless eagle fed, but the carrion eating vultures who live from the profits of religious corruption, represents that priceless heritage which alone permits a healthy race; the freedom to publicly express philosophical and religious convictions.

Both in ancient and in modern times the favorite method by which enemies of the public, such enemies as the 12th house rules, gain their ends and keep mankind in slavery to their own selfish advantage, has been to persecute the apostles of Truth, and to suppress the dissemination of correct information. It has been proclaimed that truth crushed to earth shall rise again. So also the liver of Prometheus, preyed upon by the human vultures who place a censorship on the dissemination of knowledge, and who purposely distort all information given to the public, grew again.

Those who attempt to enlighten the world always find it a painful process. Throughout the ages it has been the custom to imprison those who revealed the corruption of those in high places. The inquisition flourished to prevent facts being broadcast that would show the falsity of certain religious doctrines. Periodicals thrive chiefly upon their advertising, and an article or story which reveals some unpleasant truth about a product advertised in them can not get beyond the editorial desk. Radio stations commonly will not permit facts to be broadcast which tend to offend certain interests of power.

Yet Andromeda was not devoured by the Whale-monster. Instead she was rescued by Perseus, her Prince Charming, and had a happiness she could not have hoped for had she not endured Self-Sacrifice. And while Prometheus suffered for a time for gaining fire by which those of earth might live in greater comfort, he too eventually was released. Kind Chiron, representing the Higher Mind of Sagittarius, ruler of the 9th and of public expression, volunteered to take his place. And still later Hercules killed the vulture and he too was freed.

When the critical faculties of Hercules, picturing one decanate of Virgo, more widely are brought to bear upon the suppression and distortion of information, we may be sure that the vultures who misinform the public will no longer be tolerated. Furthermore, even while Andromeda and Prometheus were persecuted for their services to the public good they were being amply rewarded, as all who endure misfortune for the benefit of the human race are always rewarded, through building into themselves those qualities which ultimately would permit them far greater freedom in celestial realms than those could have who permitted injustice to thrive unmolested.

Thus does the text become: **He Who Sacrifices His Own Desires for the Welfare of Others Draws Down the Divine Fire from Heaven and With It Kindles the Highest Potencies of His Own Soul.**

The Cloak of Death or the Tree of Life

—The last decanate of the zodiac, where the Sun may be found each year from **March 11 to March 21**, represents the end of the cycle of physical life. Among the constellations this point from which the transition is made to a new cycle is pictured by Cassiopeia, the Lady in the Chair, who with one hand removes the cloak which represents the physical body, and with the other holds aloft a branch from the Tree of Life.

Of all regions of the zodiac, the Scorpio-decanate of Pisces thus pictured has closest affinity with both the higher and the lower astral spheres in relation to the condition of existence immediately following physical death. It is here, as the soul leaves the physical body, symbolized by the removal of the cloak, that it experiences in full measure the effect of the astral circuit so well represented by the ribbon binding together the two Fishes of Pisces. This circuit, depending upon its quality and attachments, may become a shackle, such as that by which Andromeda is chained, or it may in truth become the Tree of Life, such as Cassiopeia holds.

The alternative revealed by this decanate, the Key-word of which is **Vicissitudes**, is well set forth in the stories relative to this woman. As one queen, her inordinate pride, selfish ambition and attachment to worldly honors caused her daughter, Andromeda, to be chained to the rock for Cetus to destroy. But in another story, she is the queen who furnished her two children, Helle and Phryxus, with the Ram of the Golden Fleece, which was to carry them from danger into safety.

The Bible also portrays this celestial constellation in alternate roles; in the Old Testament as Potiphar's wife, whose Scorpio desires, and secret enmity when her advances were repulsed, caused Joseph to be placed in prison; and in the New Testament by Mary Magdalene, out of whom went seven devils, and whom Jesus loved. John 11:5: "Now Jesus loved Martha, and her sister, and Lazarus."

When the Sun moves across the celestial equator at the time of the vernal equinox, at that moment it leaves the garment of winter darkness—that is, the longer nights than days—in the hands of Cassiopeia, marking the decanate from which it thus takes exit. This garment of winter symbolizes the physical body of man which is left behind when he passes to the next life. And this episode is still further explained by the cloak which Joseph left in the hands of Potiphar's wife when he fled her importunities.

As related in Genesis 38, Joseph had been given complete charge over Potiphar's affairs. He was in a position of trust and responsibility, and as nearly always happens to those who gain positions of power and influence, he was approached by one who used great pressure to influence him to betray that trust. Joseph might have lived now and had the same experience, so typical is it of present-day methods of disposing of one whose integrity becomes annoying to the corrupt who are in power; Genesis 12:

“And she caught him by his garment, saying, Lie with me: and he left his garment in her hand, and fled, and got him out. And it came to pass, when she saw that he had left his garment in her hand, and was fled forth, that she called unto the men of her house, and spake unto them, saying, See, he hath brought in an Hebrew unto us to mock us; he came in unto me to lie with me, and I cried with a loud voice: And it came to pass, when he heard that I lifted up my voice and cried, that he left his garment with me, and fled, and got him out.”

When Joseph was placed in jail, due to the false charges of this woman of 12th house affinity it also suggests the circuit of energy pictured by Pisces by which those in love are bound into a single soul-mate system; and that if such a circuit is to result in greater freedom and power, rather than in greater bondage, it must have a vibratory rate which is uplifting and spiritual in quality, such as tender love and unselfish affection tend to generate. That is, if it is to provide the energy of the Tree of Life, rather than bind to lower astral regions, the circuit must raise the lovers to new heights of feeling, and stimulate new endeavors for the welfare of the race.

The circuit also can be formed between two people on a level that opens them to the influence of the lower astral plane. This results in the generation of great force; but the force so generated is confined in its effects to the things of a phenomenal nature, being unable to affect the finer substance of the higher astral spheres. That is, the ribbon of Pisces, unless generated by a fine and exalted type of love, tends toward imprisonment rather than to greater freedom. As is always true, that which can be used for good can also be used for evil. And this circuit, when built on a lower, coarser level, while giving great magical ability, tends in the direction of Death rather than in the direction of Life.

It then performs the same function as the circuit in a seance room when those present take hold of hands and sing. It generates a circuit of astral energy of great force, and also liberates etheric energy in volume. But the astral energy flow thus established, is of a vibratory rate corresponding to the elementals and other entities of the astral spheres closest to earth. These denizens of the realm signified by the house of self-undoing in a birth-chart, find such a circuit of energy of their own plane a stream that enables them to move into the astral bodies and in contact with the etheric energies, of those through whom the current flows. They are carried by the current wherever it goes, and as it goes through the bodies of those comprising the circle, they are able to bring their influence to bear directly upon the etheric energies and nervous systems of those thus contacted.

With a contact so fully established, either through a seance circle or through a circuit established between two lovers whose desires are on the level of those of Potipher's wife, these 12th house astral entities are able to use both the etheric energies generated and the astral energies present, to bring things to pass on the physical plane. The energy may be used for healing, for influencing other persons to do as those on the circuit desire, for demonstrations of phenomena, or for the purpose of selfish magic.

On such a circuit, however, because it has affinity through its vibratory rate with lower astral entities, whenever the attention of those generating the energy is relaxed, this enables the denizens of the lower astral to take control and use the circuit for their own purposes, of which those from whom the energy is drawn have no knowledge.

Gradually, as the circuit continues, and gains strength, those who furnish the energy tend to lose control of it or even of its manufacture. The etheric component is felt by them racing through their nervous system. And its too great withdrawal from the vital reservoir of the body leaves them depleted and with an aching spleen. They still may direct it occasionally to some purpose of their own; but for the most part, even while they sleep, it is used by low astral entities to further their own ends in influencing the trend of thought and events on earth.

These 12th house entities, enemies of the human race, use the force thus placed at their command to impress upon sensitives wherever they can be contacted, ideas which tend to prevent an understanding of true spirituality, and which tend relentlessly to draw these sensitives into their power. And in time those who furnish the current, through having it constantly directed by the astral denizens to that end, lose all power to direct its flow, and are chained by it, and must do henceforth the bidding of their astral jailers.

Yet the same principle, a circuit of energy such as the ribbon of Pisces represents, when used upon a higher, unselfish plane, exalted by ecstatic feelings of tender love, instead of imprisoning, becomes the Tree of Life. It is true that on this more spiritual level it brings those on the circuit into contact with the intelligences of this higher region. But these are too wise and too unselfish to desire to use the energies thus made available to control either those on the circuit or to demonstrate amazing phenomena on the physical plane.

Thus it is that the circuit lifts or lowers those on it to the level of the after-life world corresponding to its vibratory rate. If that rate is low it brings intimate contact with low astral intelligences; but if that rate is high, it brings equally close contact with exalted intelligences of the higher astral planes. And these never take control. The information they impart is given merely as advice, with full liberty on the part of those receiving it to accept or reject.

Furthermore, when the energy of the circuit is that of an unselfish and spiritual love, in which all animal qualities and desires have been sublimated and true regeneration has taken place, it gives the ability not only here, but in the after life, to penetrate the higher spheres and to there enter upon the Cosmic Work.

It then becomes not such an influence as Mary Magdalene was under at first; for, according to St. Luke 8:22, she had at one time been possessed of seven devils; just such a condition as the lower circuit in connection with the 12th house influence tends to attract. But Mary Magdalene was loved by Jesus, who cast the devils out of her. After this she became one of those who ministered to him at the cross, and who on going to the tomb which he had left, was told by the angel there to herald the resurrection to all the world. Instead of the devils which once she had had, having tuned in on a spiritual circuit in which unselfish love was dominant, she had partaken of the fruit of the Tree of Life.

Such a spiritual circuit, among other things, permits of passing to the next life in full consciousness. Thus the text with which the circle of constellations closes is: **Man May Pass from This Life to the Next, Even Through Death, With No Greater Break in His Affairs than Would be Occasioned by Leaving His Acquaintances in One City and Taking up His Activities in Another City Amid a Different Group of Friends.**

Book 8

Copyright
August 2002
Church of Light

Horary Astrology

Chapter 1

Serial No. 86
Original Copyright 1930
Elbert Benjamine

Copyright
August 2002
Church of Light

How To Erect A Horoscope

- 1 _____ (Name)
- 2 _____ (Month) (Day) (Year)
- 3 Place _____
- 4 Latitude _____
- 5 Longitude _____

DOMINANT FACTOR

- 6 Time of Birth _____ (Daylight Saving)
- 7 Correction for Standard Time _____
- 8 Time of Birth _____ (Standard Time)
- 9 Correction for Mean Time _____
- 10 Local Mean Time of Birth, A.M or P.M. _____

FIRST KEY PROBLEM

- 11 Noon _____ 12:00
- 12 Local Mean Time _____
- 13 L.M.T. Interval _____
- 14 Sidereal Time _____ (Noon)
- 15 _____
- 16 _____
- 17 L.M.T. Interval _____
- 18 S. T. (Uncorrected) _____
- 19 Correction, 9.86s per h. for E.G.M.T. Int. _____

- 20 Sidereal Time _____ (Of Birth)

SECOND KEY PROBLEM

- 21 Standard Time of Birth _____
- 22 Hrs. E. or W. of Greenwich _____
- 23 E.G.M.T. _____
- 24 Noon _____ 12:00
- 25 E.G.M.T. _____
- 26 E.G.M.T. Interval _____ (Indicate plus or minus)

ADDITIONAL FACTORS

- 27 Constant Log _____
- 28 Limiting Date _____ (Including year)

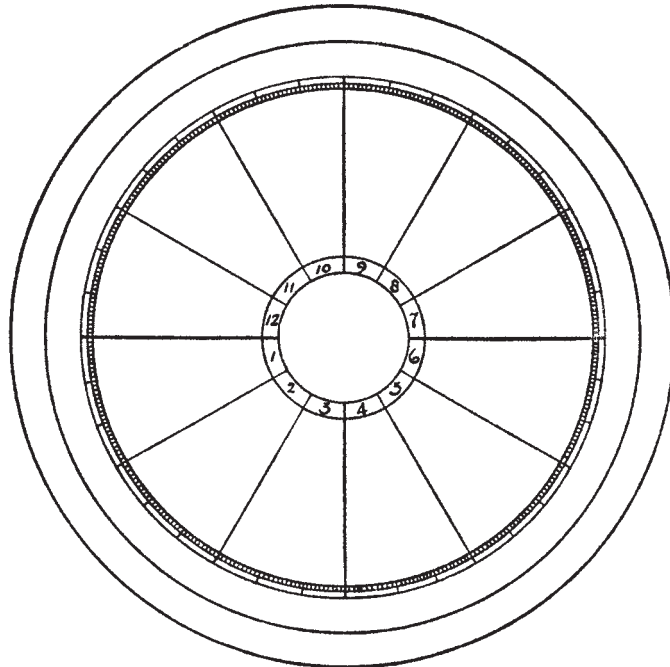

MOV.	FIX.	MUT.	FIRE	EARTH	AIR	WATER	ANG.	SUC.	CAD.
PER.	COMP.	PUB.	LIFE	WEALTH	ASSOC.	PSY.	ABOVE	EAST	RET.
DECLINATIONS									
		☉	☽	♃	♀	♄	♅	♁	♁
	☉								
	☽								
	♃								
	♀								
	♄								
	♅								
	♁								
	♁								
	♁								
	♁								
	♁								
	♁								
	♁								
	♁								
	♁								
	♁								
	♁								
	♁								
	♁								
	♁								
	♁								
	♁								
	♁								

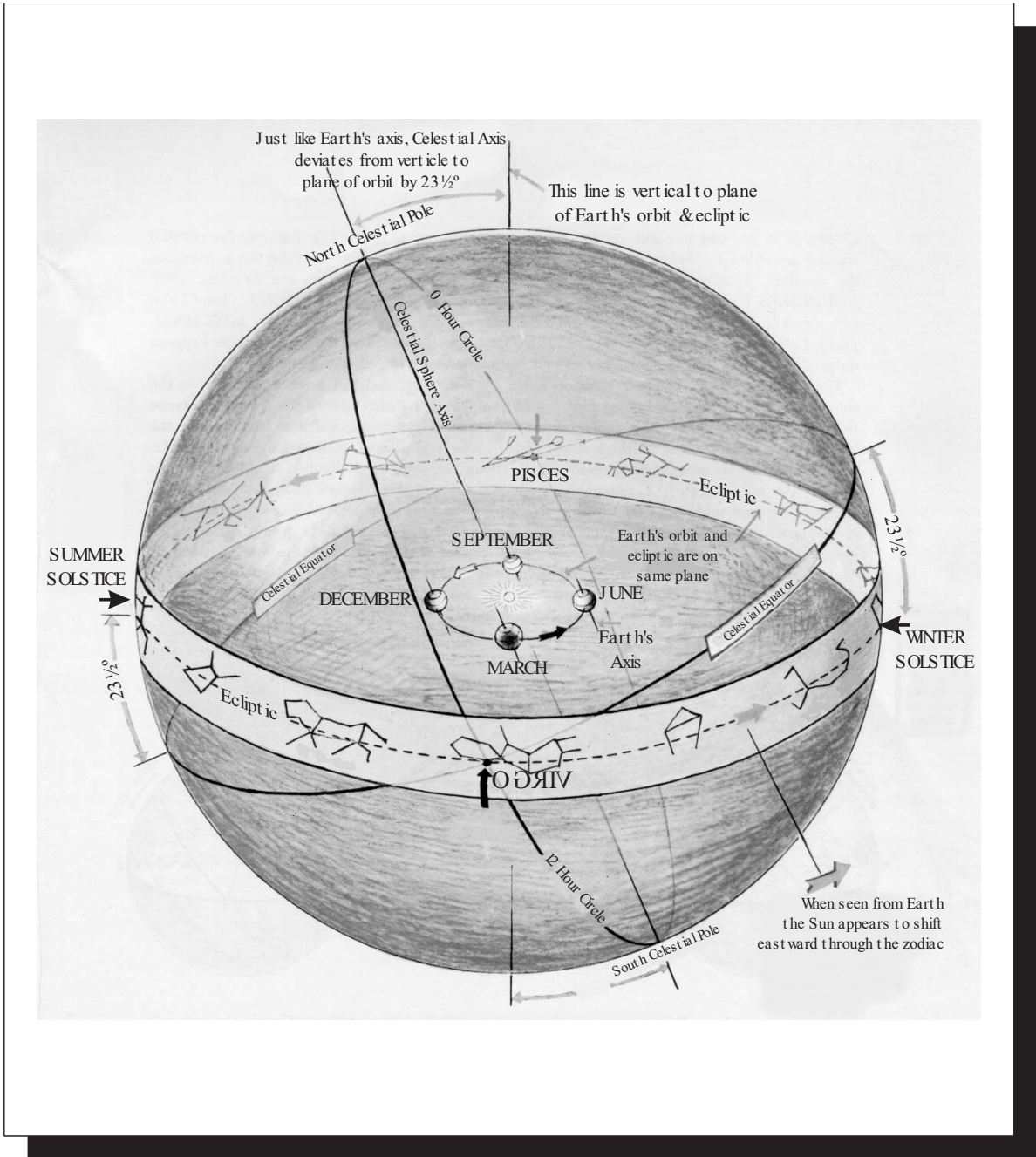

Earth's Orbit inside Celestial Sphere

TABLE OF HOUSE CUSP DECLINATIONS

♈	N	♉	♊	N	♋	♌	N	♍
♈	S	♉	♊	S	♋	♌	S	♍
Deg.	Dec.	Deg.	Deg.	Dec.	Deg.	Deg.	Dec.	Deg.
0	0:00		0	11:28		0	20:09	
1	0:23	29	1	11:49	29	1	20:22	29
2	0:47	28	2	12:11	28	2	20:34	28
3	1:12	27	3	12:31	27	3	20:46	27
4	1:36	26	4	12:52	26	4	20:57	26
5	1:59	25	5	13:12	25	5	21:08	25
6	2:23	24	6	13:32	24	6	21:18	24
7	2:47	23	7	13:52	23	7	21:29	23
8	3:11	22	8	14:11	22	8	21:39	22
9	3:34	21	9	14:30	21	9	21:48	21
10	3:58	20	10	14:49	20	10	21:57	20
11	4:22	19	11	15:07	19	11	22:06	19
12	4:45	18	12	15:26	18	12	22:14	18
13	5:08	17	13	15:45	17	13	22:22	17
14	5:32	16	14	16:03	16	14	22:30	16
15	5:55	15	15	16:20	15	15	22:36	15
16	6:18	14	16	16:38	14	16	22:42	14
17	6:41	13	17	16:55	13	17	22:49	13
18	7:04	12	18	17:12	12	18	22:54	12
19	7:27	11	19	17:29	11	19	23:00	11
20	7:49	10	20	17:45	10	20	23:04	10
21	8:11	9	21	18:01	9	21	23:08	9
22	8:34	8	22	18:16	8	22	23:12	8
23	8:56	7	23	18:32	7	23	23:16	7
24	9:19	6	24	18:47	6	24	23:19	6
25	9:41	5	25	19:01	5	25	23:22	5
26	10:02	4	26	19:16	4	26	23:23	4
27	10:25	3	27	19:30	3	27	23:24	3
28	10:46	2	28	19:44	2	28	23:25	2
29	11:07	1	29	19:57	1	29	23:26	1
	11:28	0		20:09	0		23:27	0

Declination of Angles Referred to in Footnote #4

Table I. Signs and Their Opposites.

No.	Symbol.	Opposite No.	Symbol.
1.	♈	7.	♎
2.	♉	8.	♏
3.	♊	9.	♐
4.	♋	10.	♑
6.	♌	11.	♒
6.	♍	12.	♓

III. Table of Longitude.

60 seconds	{ ^{''} }	make 1 minute,	marked '.
60 minutes	{ ['] }	make 1 degree,	marked °.
30 degrees	{ [°] }	make 1 sign,	marked S.
12 signs	{ ^S }	make 1 zodiac	
360 degrees	{ [°] }	make 1 circle	

IV. Table of Time.

60 seconds	{ ^s }	make 1 minute,	marked m.
60 minutes	{ ^m }	make 1 hour,	marked h.
24 hours	{ ^h }	make 1 day,	marked D.

Table II. Symbols of Planets.

No.	Symbol.	Name.
1.	☉	Sun
2.	☾	Moon
3.	☿	Mercury
4.	♀	Venus
5.	♂	Mars
6.	♃	Jupiter
7.	♄	Saturn
8.	♅	Uranus
9.	♆	Neptune
10.	♇	Pluto

Other Symbols

11.	♁	Dragon Head
12.	♂	Dragon Tail
13.	⊕	Part of Fortune

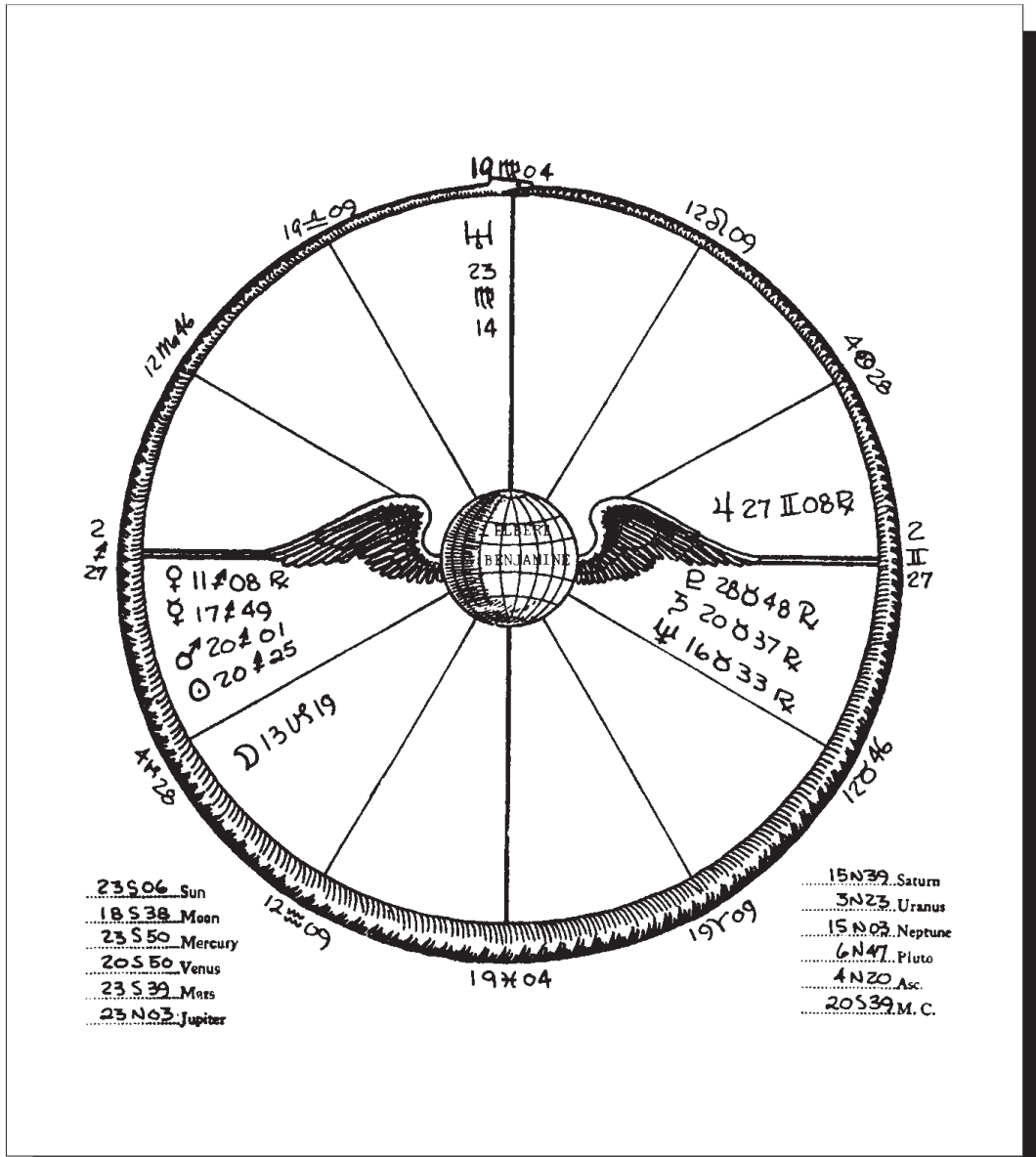

C.C. Zain Birthchart,
 Author of the 21 Brotherhood of Light Lessons

Accuracy:

Research has shown the necessity of correcting birth charts for precision. This process involves finding ALL the house cusps to the exact MINUTE for exact Sidereal Time (page 21) and exact Latitude (page 144, Chapter 8 in this book). ALL house cusps will then show the exact minute on them. Just as a scientist uses the most accurate methods available even if his data is incomplete; so should the astrologer strive for precision and accuracy in every chart. Final examinations with charts will not be considered correct until this is done.

Comprehension:

Additional explanatory material has been added in the margins to aid the student's understanding of the chart construction process. For some students, however, it may be easier to delay a more in depth understanding and simply apply the step by step rules to each

Chapter 1

How To Erect A Horoscope

IN erecting a horoscope there are simple problems of two separate kinds. The first set of problems maps the positions of the signs of the zodiac in relation to the earth. The second set of problems maps the positions of the various planets in relation to the zodiacal signs.

These problems are quite distinct from each other because the positions of the zodiacal signs are calculated from **Sidereal Time**, while the positions of the planets are calculated from **Equivalent Greenwich Mean Time**. Most of the trouble experienced by beginners arises from failing to remember that the kind of time used for mapping the zodiacal signs is not the same as the time used for mapping the planets.

Both the Sidereal Time of Birth and the Equivalent Greenwich Mean Time of Birth are derived from still a third kind of time, called **Local Mean Time**. Because it is necessary first to find the Local Mean Time before either of the other kinds of time can be ascertained, and therefore before either sign positions or planet positions can be computed, I call the Local Mean Time the **DOMINANT FACTOR**.

From this Dominant Factor, or Local Mean Time, the Sidereal Time of Birth is calculated. Because this Sidereal Time of Birth is the key to the positions of the zodiacal signs, I call Finding the Sidereal Time of Birth the **FIRST KEY PROBLEM**.

From this Dominant Factor, or Local Mean Time, the Equivalent Greenwich Mean Time Interval is calculated. Because this Equivalent Greenwich Mean Time Interval is the key to the positions of the planets, I call Finding the Equivalent Greenwich Mean Time Interval of Birth the **SECOND KEY PROBLEM**.

Yet before attempting the actual work of erecting a horoscope the student should know what a horoscope is, what data is required to erect it, the meaning of the symbols commonly employed, and how to add and subtract both Longitude and Time. These can be conveniently handled as **PRELIMINARY EXPLANATIONS**.

It should now be clear that erecting a horoscope divides itself according to the natural sequence of the work into four well marked divisions that are based upon) **PRELIMINARY EXPLANATIONS, DOMINANT FACTOR. FIRST KEY PROBLEM, and SECOND KEY PROBLEM.**

In the complete work there are eleven separate processes or steps. When you become accustomed to them some of these steps will be passed over so rapidly as hardly to be noticed; yet unless short cuts are used these eleven steps are always taken in the erection of a complete horoscope.

The time for which the chart is erected may be before noon or it may be after noon, the place may be east, or it may be west, of a standard meridian, or there may be other variations. In this one lesson I have taken into consideration all the various conditions and circumstances an astrologer is apt to meet, and have formulated rules and given examples having reference to them all. You will find twenty-seven rules.

So many rules, and the examples illustrating them, may give you the impression that erecting a horoscope is a formidable task. Yet as a matter of fact, in the erection of any one chart only a part of the rules are used. Even the following of the eleven necessary steps quickly becomes almost automatic, and you will soon do most of the calculations mentally about as quickly as you can conveniently enter the results in the map.

Instead of being a complicated task, all that is really necessary to erect a horoscope is the knowledge that the signs are placed in the map from the Sidereal Time of Birth, that the planets are placed in the map from Equivalent Greenwich Mean Time Interval of Birth, that both of these different times are computed from the Local Mean Time of Birth, and the use of addition, subtraction, and common sense.

PRELIMINARY EXPLANATIONS

The word horoscope is derived from Greek words meaning hour view. It is a map of the heavens showing the positions of the planets and zodiacal signs as viewed from some particular place at some particular time. There are, therefore, three distinct factors necessary for the erection of a horoscope of birth of a child or other event:

A—Astronomical data from which the positions of the signs and planets may be calculated.

B—The place of birth from which the heavens are to be viewed.

C—Time of birth—Year, Month, Day of Month, and Time of Day, A. M. or P. M.—when the heavens are thus to be viewed.

(A) The necessary astronomical data for calculating the positions of the signs and planets may be found in an Astronomical Ephemeris for the year of birth. Astronomical ephemerides commonly cover but a single year each, and may be had for each year since 1850.

JANUARY 2000

☽ TOTAL ECLIPSE, 00 Ω 26, INTENSITY 1.326, 21 JANUARY, 4h 45m

Day Jour	S. T.			LONGITUDE for 0h																								
				☉	☽	♃	♄	♅	♆	♁	♂	♁	♂	♁	♂	Ω True												
	h	m	s	°	'	"	°	'	"	°	'	"	°	'	"	°	'	"	°	'	"	°	'	"				
Sa 1	06	39	51	09	51	30	07	17	04	01	57	07	00	58	27	34	25	14	10	24	14	47	03	11	11	26	03	59
Su 2	06	43	48	10	52	40	19	18	30	02	40	02	10	28	21	25	16	10	23	14	50	03	13	11	28	03	56	
M 3	06	47	45	11	53	51	01	12	47	04	14	03	23	29	08	25	19	10	22	14	53	03	15	11	30	03	52	
T 4	06	51	41	12	55	01	13	03	08	06	48	04	35	29	54	25	22	10	21	14	56	03	17	11	32	03	46	
W 5	06	55	38	13	56	12	24	52	08	07	22	05	48	00	41	25	25	10	20	14	59	03	19	11	35	03	44	
Th 6	06	59	34	14	57	23	06	42	11	08	57	07	01	01	27	25	28	10	19	15	02	03	21	11	37	03	42	
F 7	07	03	31	15	58	33	18	35	14	10	32	08	14	02	14	25	32	10	19	15	06	03	24	11	39	03	40	
Sa 8	07	07	27	16	59	44	00	33	08	12	07	09	27	03	00	25	35	10	18	15	09	03	26	11	41	03	39	
Su 9	07	11	24	18	00	54	12	37	46	13	43	10	40	03	47	25	39	10	18	15	12	03	28	11	43	03	39	
M 10	07	15	20	19	02	04	24	51	10	15	20	11	53	04	33	25	43	10	18	15	03	30	11	45	03	40		
T 11	07	19	17	20	03	14	07	15	42	16	56	13	06	05	20	25	47	10	17	15	18	03	32	11	47	03	42	
W 12	07	23	14	21	04	23	19	53	55	18	33	14	19	06	06	25	52	10	17	15	22	03	35	11	48	03	43	
Th 13	07	27	10	22	05	31	02	48	37	20	11	15	32	06	53	25	56	10	17	15	25	03	37	11	50	03	44	
F 14	07	31	07	23	06	39	16	02	27	21	49	16	45	07	39	26	01	10	17	15	28	03	39	11	52	03	44	
Sa 15	07	35	03	24	07	46	29	37	40	23	28	17	58	08	26	26	06	10	18	15	31	03	41	11	54	03	44	
Su 16	07	39	00	25	08	53	13	35	26	25	07	19	12	09	12	26	11	10	18	15	35	03	44	11	56	03	44	
M 17	07	42	56	26	09	58	27	55	19	26	46	20	25	09	59	26	17	10	19	15	38	03	46	11	58	03	43	
T 18	07	46	53	27	11	03	12	34	45	28	26	21	38	10	45	26	22	10	19	15	41	03	48	12	00	03	42	
W 19	07	50	49	28	12	08	27	29	48	00	07	22	52	11	31	26	26	10	20	15	45	03	50	12	01	03	42	
Th 20	07	54	46	29	13	11	12	30	22	01	48	24	05	12	18	26	34	10	21	15	49	03	53	12	03	03	41	
F 21	07	58	43	00	14	14	27	30	59	03	30	25	18	13	04	26	40	10	22	15	52	03	56	12	05	03	41	
Sa 22	08	02	30	01	15	17	12	31	58	05	19	26	19	13	05	28	48	10	23	15	55	03	57	12	07	03	41	

Sample Ephemeris

The data for determining the relation of the heavens to the particular place may be found by consulting a Table of Houses for the Latitude of the place. A Table of Houses is good for any year, and need only approximate the latitude of birth.

Raphael's¹ ephemeris contains not only the positions of all the planets for mean noon, Greenwich, for each day of the year covered, but also contains an aspectarian, a table of houses for several important places, and a table of proportional logarithms.

(B) The location of the place for which the horoscope is erected may be ascertained by consulting a common atlas or geography and finding its Latitude and Longitude. Longitude is expressed in ° (degrees), ' (minutes), and " (seconds) E (east) or W (west) of Greenwich. Latitude is expressed in °, ', and ", N (north) or S (south) of the equator. Where unusual precision is required geocentric latitude is used, but the latitude of the common map is precise enough for all ordinary purposes.

(C) There are various systems for recording time which are or have been in use. Unless the time used is known, a correct chart cannot be erected. This matter of what kind of time was used at any given date is of utmost importance, but is so complicated that it requires a special volume for treatment. Such a volume is published entitled, World Daylight Saving Time.

As the astronomical data given in the ephemeris is calculated for Mean Time, unless the time of birth is given in terms of local mean time it becomes necessary to convert the recorded time into local mean time.

1 Used at the time of this writing. Other ephemerides work as well as Raphael's, as long as they have pertinent information such as declinations.

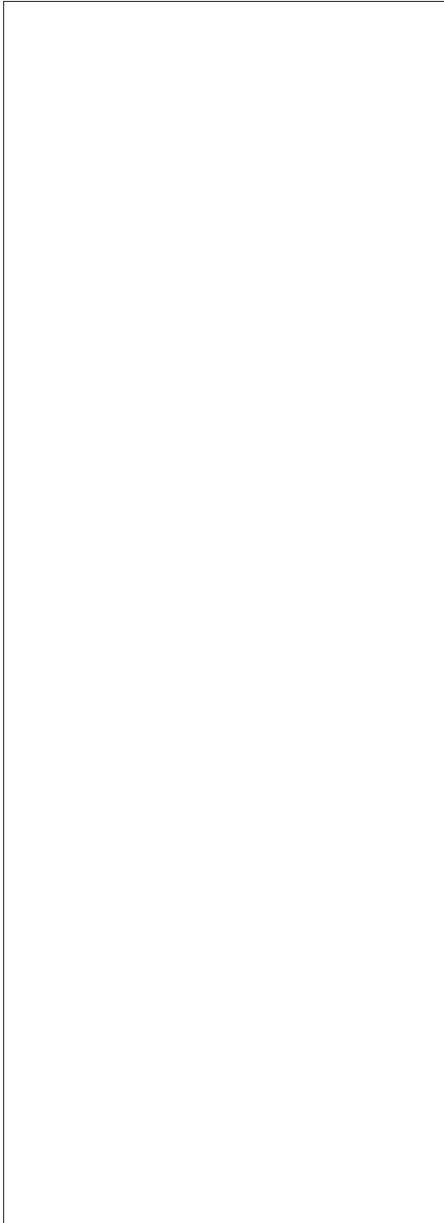

The use of local mean time requires that every place having a different longitude should have a different time. As this is a nuisance, Standard Time is now used in most parts of the world. In the United States the country is divided into four Standard Time Zones each containing 15° longitude. The Standard Meridian for Eastern Time is 75° , or 5 hours, west; the Standard Meridian for Central Time is 90° , or 6 hours, west; the Standard Meridian for Mountain Time is 105° , or 7 hours, west; and the Standard Meridian for Pacific Time is 120° , or 8 hours, west. Eastern Canada has a further zone, called Atlantic Time, which is but 4 hours west.

Theoretically, all places $7\frac{1}{2}^\circ$ east and $7\frac{1}{2}^\circ$ west of a standard meridian should keep the same time. As a matter of fact, railroad divisions and natural boundaries greatly influence the actual place where time changes are made. Furthermore, the dividing line where such changes of time take place has not remained constant, but has shifted along with railroad changes and the development of certain regions. The map on page 11 of this lesson, gives the zones and places of time change as they exist at the present time. But if a birth is near these places of time change, much pains should be exercised to ascertain just what time was used in recording the birth.

Standard Time was adopted throughout the United States, theoretically, Nov. 18, 1883, at Noon; and in Great Britain in 1880. Actually it was not used in many places until considerably later. Previous to these dates each place used its own time, the Local Mean Time. On all dates after the adoption of

Sample Atlas Page

Standard Time, when the time given is that of the ordinary watch or clock, it becomes necessary to convert this standard Time to Local Mean Time.

To still further complicate matters, during and following the great war, daylight saving time was adopted in many countries. It was in general use in the U. S. during 1918 and 1919, and is still used in some sections of the country. As if this were not confusion enough, in some towns in the eastern U. S. at the present, there are two kinds of time in use. Daylight Saving Time has been made legal, but as it so complicates schedules, the railroads continue to use Standard Time. To get the time of birth right, inquiry must be made as to which time was used in the record.

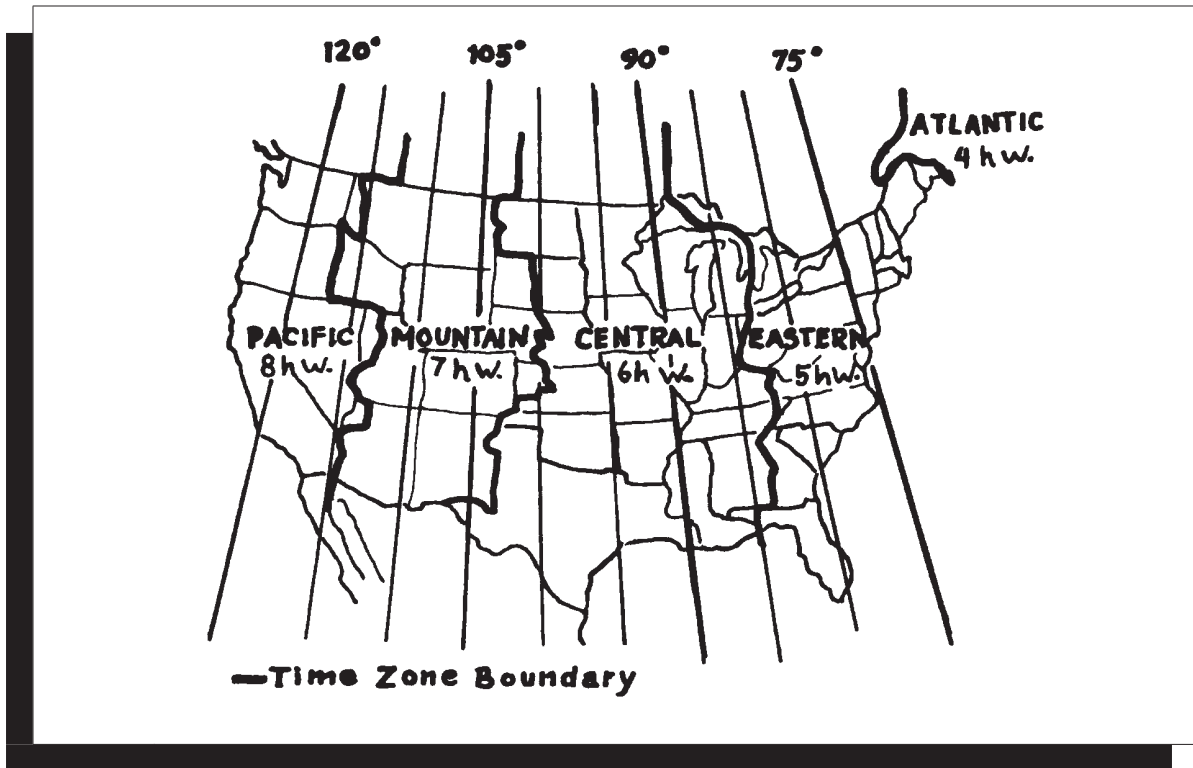

The U. S. used Daylight Saving in 1918 from March 31 to October 27, and in 1919 from March 30 to October 26 but where continued the change date varies. When the birth is timed by Daylight Saving, it becomes necessary to subtract one hour from the clock time to get the Standard Time. Then in the usual way, Standard Time may be converted into Local Mean Time.

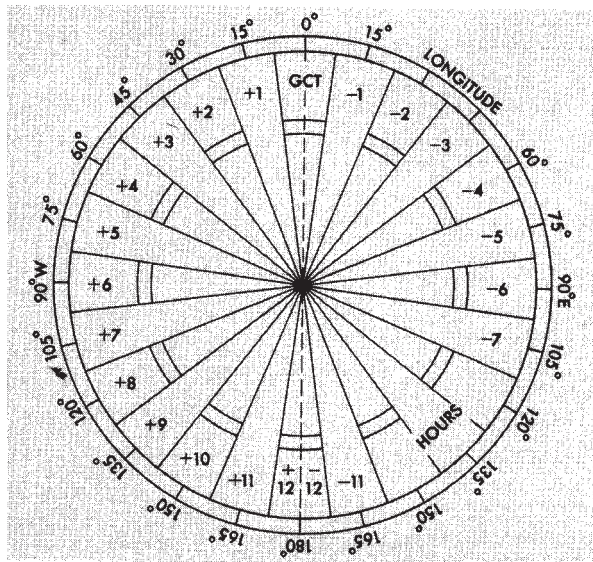

Time Zone Diagram

*Numbers outside circle are longitudes of the standard meridians.
Numbers inside are corrections in hours to universal time.*

Then again, in some countries, notably Russia, the Julian Calendar was used up to the time of the Revolution in 1917. Even here there are exceptions, as some places on the Black Sea used the calendar of their neighbors. When, however, the date is given Old Style, as it was reckoned in Russia, it must be converted into the Gregorian Calendar, or New Style, because the ephemeris is calculated New Style. This is done by adding 12 days to Old Style dates occurring in the 19th Century, and by adding 13 days to Old Style dates since 1900. Thus, Jan. 2, 1916, Old Style, is the same as Jan. 15, 1916, New Style. The horoscope, consequently, should be erected for Jan. 15.

How to recognize astronomical symbols, and the signs that always occur opposite each other.

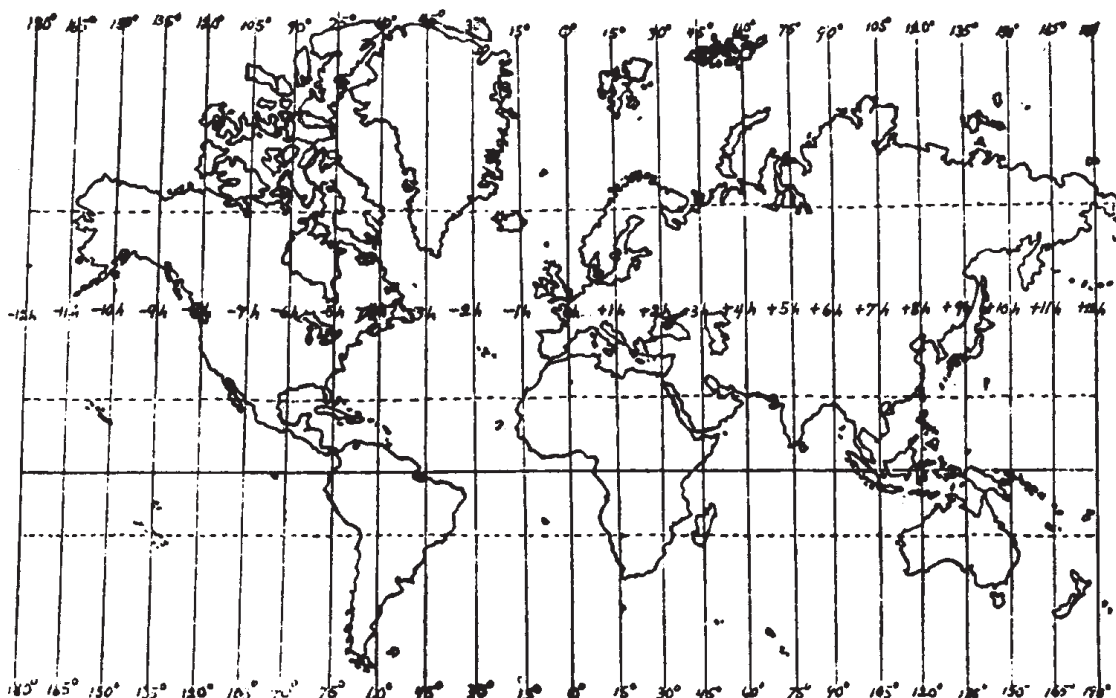

The time at Greenwich (E.G.M.T) is later than in America, and earlier than in Asia, Australia and in Europe.

Table I (page 5) gives the names of the zodiacal signs, the symbol for each sign, the number of each sign in the zodiac (not its vibratory number), and the signs that are always opposite each other. This table should be **thoroughly memorized**.

Table II (page 5) gives the names of the planets, the symbol for each planet, and—with the exception of the Sun which is given first because most important—the order of their speed through the zodiac, the Moon being fastest in motion. This table also should be well memorized.

Geographical longitude and celestial right ascension (R.A.)² are expressed in °, ', and ". Zodiacal longitude is expressed in S, °, ', and ". **Table III** (see Table page 5) gives the necessary data. It should be memorized.

2 For plotting the positions of fixed stars, which may be far north or south of the zodiac, Right Ascension is more convenient than zodiacal longitude, and is chiefly used in astronomical works; but is not employed in erecting a birthchart, nor in progressing the planets.

**How to add and subtract
Longitude, Right Ascension, Mean
Time and Sidereal Time.**

Rule 1.

—**To add Long. or R.A.** Add the " , and if the sum exceeds 60" subtract 60" from it, the remainder being " and each 60" being called 1' and added to the ' column.

Add the ' including that carried over from the column and if the sum exceeds 60' , subtract 60' from it, the remainder being ' and each 60' being called 1° and added to the ° column. Add the ° , including that carried over from the ' column, and if the sum exceeds 360° subtract 360 from it. The remainder being ° , and each 360° being called a circle and discarded.

Example (1). Given Perth, W. Australia, with a long. 115° 54' E. and St. Johns, Newfoundland, with a long. 52° 42' W to find how far in long. they are apart.

$$\begin{array}{r}
 115^{\circ} 54' 00'' \quad \text{E} \\
 +52^{\circ} 42' 00'' \quad \text{W. to be added.} \\
 \hline
 168^{\circ} 36' 00'' \quad \text{apart is the Answer}
 \end{array}$$

Rule 2.

—**To subtract Long. or R.A.** Subtract " from " , and if the minuend be too small, borrow 1' from the ' column, and calling it 60" add to the minuend " column. Subtract ' from ' , and if the minuend be too small borrow 1° from the ° column and calling it 60' add to the ' in the minuend. Subtract ° from ° and if the minuend be too small add the full circle of 360° to the ° in the minuend to make subtraction possible.

Example (2). Traveling in a westerly direction from San Francisco with a long. of 122° 26' W., how far is it in long. to Buenos Aires with a long. of 58° 18' W.?

$$\begin{array}{r}
 58^{\circ} 18' 00'' \\
 \underline{360^{\circ}} \quad \text{add degrees in a circle.} \\
 418^{\circ} 18' 00'' \quad \text{equals new minuend.} \\
 -122^{\circ} 26' 00'' \quad \text{subtract} \\
 \hline
 295^{\circ} 52' 00'' \quad \text{equals the Answer}
 \end{array}$$

Mean Time and Sidereal Time are expressed in h (hours). m (minutes), and s (seconds). Table IV, giving this, should be memorized.

Rule 3.

—**To add Mean Time** proceed as in adding long. except that if the total sum exceeds 12h, 12h should be subtracted from it, calling the difference P.M. of the same day if A.M. was given, or A.M. of the following day if P.M. was given.

Example (3a). Given a mean time of 11h 58m 32s A.M. Jan. 6, to find the mean time 6h 23m 52s later.

11h 58m 32s	A.M. Jan. 6
+6h 23m 52s	add for correction
<hr/> 18h 22m 24s	
-12h	subtract
<hr/> 6h 22m 24s	P.M. Jan. 6 is the Answer

Example (3b). Given a mean time of 10h 24m 31s P.M. Jan, 6, to find the mean time 8h 42m 35s later.

10h 24m 31s	P.M. Jan. 6.
+ 8h 42m 35s	add
<hr/> 19h 07m 06s	
-12h	subtract
<hr/> 7h 07m 06s	A.M. Jan. 7 is the Answer

Rule 4.

—**To subtract Mean Time** Proceed as in subtracting long. except that if the minuend be too small in h, 12h must be added to it, and the difference is then P.M. of the day before if A.M. time is given, or A.M. of the same day if P.M. time is given.

Example (4a). Given a mean time of 8h 42m 36s A.M. Jan. 6, to find the mean time 10h 38m 56s earlier.

8h 42m 36s	A.M.
+12h	add
<hr/> 20h 42m 36s	
-10h 38m 56s	subtract
<hr/> 10h 03m 40s	P.M. Jan. 5 is the Answer

Example (4b). Given a mean time of 7h 37m 22s P.M. Jan. 6, to find the mean time 9h 21m 58s earlier.

$$\begin{array}{r}
 7\text{h } 37\text{m } 22\text{s} \quad \text{P.M.} \\
 +12\text{h} \quad \underline{\hspace{1cm}} \quad \text{add} \\
 19\text{h } 37\text{m } 22\text{s} \\
 - 9\text{h } 21\text{m } 58\text{s} \quad \text{subtract} \\
 \hline
 10\text{h } 15\text{m } 24\text{s} \quad \text{A.M. Jan. 6 is the Answer}
 \end{array}$$

Rule 5.

—**To add or subtract Sidereal Time (S.T.)** proceed as with mean time except that when the sum is in excess of 24h, 24h must be subtracted, the remainder being the required S.T.; and when the minuend is too small to permit subtraction, 24h must first be added to it.

Example (5a). Given a S.T. of 19h 24m 29s. to find the S.T. 6h 4m 31s later.

$$\begin{array}{r}
 19\text{h } 24\text{m } 29\text{s} \\
 +6\text{h } 04\text{m } 31\text{s} \quad \text{add} \\
 \hline
 25\text{h } 29\text{m } 00\text{s} \\
 -24\text{h} \quad \text{subtract for correction} \\
 \hline
 1\text{h } 29\text{m } 00\text{s} \quad \text{Is the Answer}
 \end{array}$$

Example (5b). Given a S.T. of 4h 27m 18s, to find the S.T. 5h 41m 28s earlier.

$$\begin{array}{r}
 4\text{h } 27\text{m } 18\text{s} \\
 +24\text{h} \quad \underline{\hspace{1cm}} \quad \text{add} \\
 28\text{h } 27\text{m } 18\text{s} \\
 - 5\text{h } 41\text{m } 28\text{s} \quad \text{subtract} \\
 \hline
 22\text{h } 45\text{m } 50\text{s} \quad \text{is the Answer}
 \end{array}$$

Rule 6.

—**To add Zodiacal Longitude** proceed as in geographical longitude except that if the sum exceeds 30°, subtract 30° from it, each 30° being called One Sign and added to the sign column. If the signs exceed 12, subtract 12S from the sum, being careful to note that Pisces is both sign 12, and sign 0.

Example (6). Given Pisces (12S) 28° 4' 29". to add 4° 16' 33" to it.

$$\begin{array}{r}
 12\text{S } 28^\circ 04' 29'' \\
 + 0\text{S } 04^\circ 16' 33'' \quad \text{add} \\
 \hline
 13\text{S } 02^\circ 21' 02'' \\
 12\text{S} \quad \text{subtract} \\
 \hline
 1\text{S } 02^\circ 21' 02'', \quad \text{or Aries } 2^\circ 21' 02'' \text{ is the Answer}
 \end{array}$$

Rule 7.

—To subtract Zodiacal Longitude proceed as in subtracting geographical longitude except that if the minuend be too small in S, 12S must be added to it, and if too small in °, 30° (1S) must be borrowed from the S column.

Example (7). Given Aries 4° 32' 16", to subtract 20° 33' 19" from it.

$$\begin{array}{r}
 1S\ 04^{\circ}\ 32'\ 16'' \\
 +12S \\
 \hline
 \text{add} \\
 13S\ 04^{\circ}\ 32'\ 16'' \\
 -\ 20^{\circ}\ 33'\ 19'' \\
 \hline
 \text{subtract} \\
 12S\ 13^{\circ}\ 58'\ 57'' \text{ or} \\
 \text{Pisces } 13^{\circ}\ 58'\ 57'' \text{ is} \\
 \text{the Answer}
 \end{array}$$

DOMINANT FACTOR	
6	Time of Birth _____ (Daylight Saving)
	Correction for _____
7	Standard Time _____
8	Time of Birth _____ (Standard Time)
	Correction for _____
9	Mean Time _____
	Local Mean Time of _____
10	Birth, A.M. or P.M. _____

from
subt

THE DOMINANT FACTOR

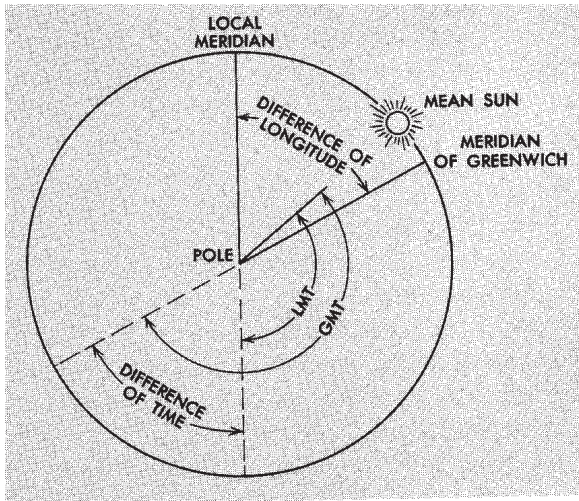

Difference of Local Time Between Two Places Equals Their Difference in Longitude

STEP 1. How to Find the Local Mean Time.

—One complete revolution of the earth on its axis, which is the time between two successive transits of the sun’s semi-diameter across the same meridian, measures 24 hours. In the complete revolution the 360° of geographical longitude measuring the earth’s circumference pass under the sun at meridian. Dividing 360° by 24, gives 15° that pass under the sun at meridian every hour. Dividing this hour of 60 minutes by 15 gives 4 minutes as the time required for 1° longitude to pass under the sun at meridian.

Thus in the prevalent method of reckoning, the Standard Meridians of Time, starting at Greenwich, are exact multiples of 15° E. or W., there being a difference of just 1h in time between successive Standard Meridians. A glance at the maps on pages 11 and 12 will indicate these various meridians and time zones.

Now if the place for which the chart is to be erected is exactly on one of the Standard Meridians the Local Mean Time (L.M.T.) is the same as the time recorded by the clock. But since standard time came into use, if the place is either E. or W. of a standard meridian, the clock time must be converted into L.M.T.

Clocks west of a Standard Meridian are FAST. Clocks east of a Standard Meridian are SLOW. And as 1° longitude is the equivalent of 4m time, as shown above, the number of ° E. or W. of the Standard Meridian may be converted into time merely by multiplying by 4 and calling the result minutes.

Rule 8.

—When Standard Time is given to find the L.M.T. at a place west of a Standard Meridian multiply the ° distant from the standard by 4, calling the result minutes, multiply the minutes by 4 to get seconds, and subtract from standard time.

Example (8). Given a standard time at San Francisco of 5h 00m A.M., to find the L.M.T. San Francisco is 122° W. 26" long. The Pacific Standard Meridian is 120° W. Difference in long. is 2° 26'.

$$2^{\circ} 26' \times 4 \text{ gives } 9 \text{ minutes } 44 \text{ seconds.}$$

FIRST KEY PROBLEM

11 Noon _____ 12:00

12 Local Mean Time _____

13 L.M.T. Interval _____

14 Sidereal Time _____
(Needs)

15 _____

16 _____

17 L.M.T. Interval _____

18 S. T. (Uncorrected) _____

19 E.G.M.T. Int. _____
Correction, 9.86s per h. for

20 Sidereal Time _____
(Of Birth)

$$\begin{array}{r}
 5\text{h } 00\text{m } 00\text{s} \text{ A.M.} \\
 \underline{-9\text{m } 44\text{s} \text{ subtract}} \\
 4\text{h } 50\text{m } 16\text{s} \text{ A.M. L.M.T. is the Answer}
 \end{array}$$

Rule 9.

—When Standard Time is given to find the L.M.T. at a place east of a Standard Meridian multiply the $^{\circ}$ distant from the standard by 4, calling the result minutes, the minutes by 4 to get seconds, and add to the standard time.

Example (9). Given a standard time at New York of 5h 32m P.M., to find the L.M.T. New York is 73°W . $57'$ long. The Eastern Standard Meridian is 75°W . $00'$. Difference in long. is $1^{\circ} 3'$. $1^{\circ} 3' \times 4$ gives 4 minutes 12 seconds.

$$\begin{array}{r}
 5\text{h } 32\text{m } 00\text{s} \text{ P.M.} \\
 \underline{+ 4\text{m } 12\text{s} \text{ add}} \\
 5\text{h } 36\text{m } 12\text{s} \text{ P.M. L.M.T. is the Answer}
 \end{array}$$

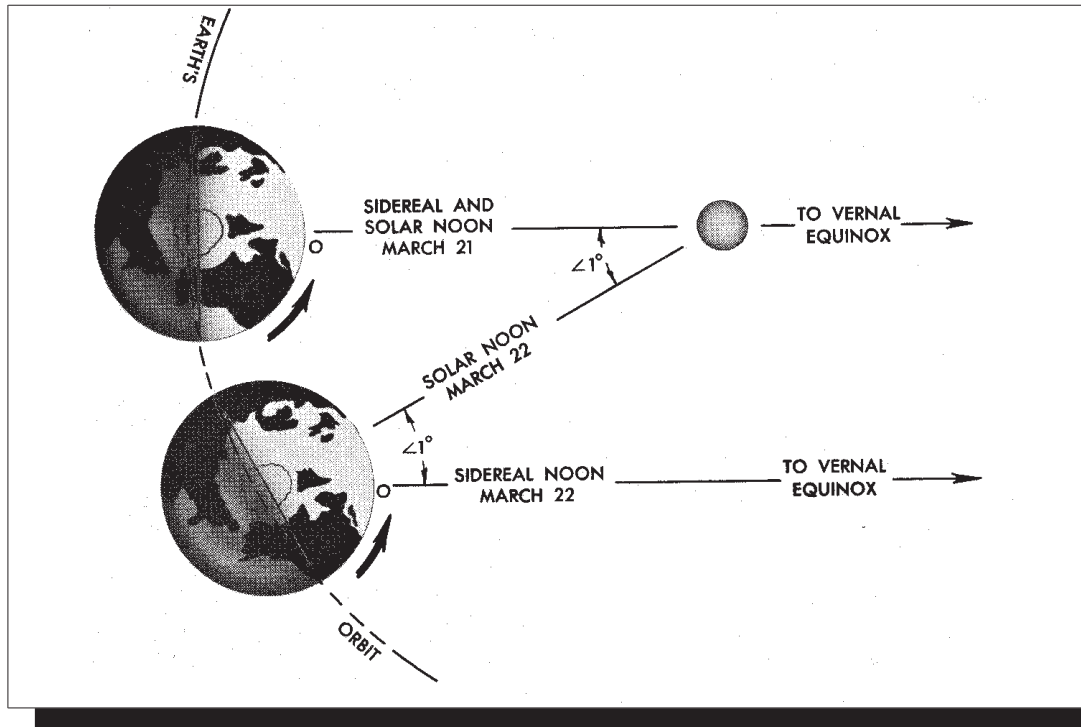

Line 19 Correction:

Because the earth rotates at a rate of 1° in 4 minutes, the solar day is longer than the sidereal day by a little less than 4 minutes ($3^{\text{m}} 56^{\text{s}}$). A correction of 9.86 secs per hour of EGMT ($3^{\text{m}} 56^{\text{s}} \div 24^{\text{h}} = 9.86^{\text{s}}$) must be made.

FIRST KEY PROBLEM

SIGNS ON HOUSES

STEP II. How to Find the Sidereal Time of Birth.

—The celestial equator is the projection of the earth's equator in the heavens. There are 360° in the celestial equator. To measure any circle a starting point is necessary. The starting point for measuring along the earth's equator is the Meridian of Greenwich. The starting point for measuring along the celestial equator is the point where the sun crosses it each year moving north in the spring of the year. This point is the vernal equinox called 0° Aries.

The distance E. or W. of Greenwich as we have seen may be expressed in °, ', and ", or in h, m, and s. So, likewise, the distance E. or W. of 0° Aries may be expressed in °, ', and ", and so expressed is called Right Ascension (R.A.). Or it may be expressed in h, m, and s, and then is called Sidereal Time (S.T.). R.A. in the heavens corresponds to geographical longitude. Sidereal Time is the distance along the celestial equator from 0° Aries expressed in Time. The S.T. at noon of any day represents the distance of the point on the celestial equator from 0° Aries that is on the Mid Heaven (M.C.) at noon of that day.

Knowing the S.T.—distance from 0° Aries in time—on the M.C. at noon, and that the whole celestial equator must pass the M.C. in 24h, it is easy to calculate the S.T.—distance from 0° Aries—that is on the M.C. at any moment of that day. The INTERVAL of time since noon added to the S.T. at noon, or the INTERVAL of time before noon subtracted from the S.T. at noon, must give the required S.T. This is the exact distance of the point on the M.C. from 0° Aries.

The Sidereal Time at noon for each day at Greenwich is given in the ephemeris for the year in which the date occurs.

Rule 10.

—**To find the Sidereal Time when the L.M.T. is after noon**, consult the ephemeris for that year and day and to the S.T. there given for noon add the L.M.T., or INTERVAL after noon. For greater precision see correction below.

Rule 11.

—**To find the Sidereal Time when the L.M.T. is before noon**, consult the ephemeris for that year and day and from the S.T. there given for noon subtract the INTERVAL between the L.M.T. and noon. For greater precision see correction below.

Correction of Sidereal Time for Precision

—As Sidereal Time increases at the rate of approximately 4 minutes a day where precision is required a correction of 9.86s (roughly 10s) per hour must be made both for longitude from Greenwich, and for the INTERVAL between L.M.T. and noon. The separate correction for L.M.T. is best performed by always ADDING 9.86s per hour to the INTERVAL between L.M.T. and noon. The separate correction for longitude may best be performed by adding 9.86s per hour to S.T. if west, and subtracting 9.86s per hour from S.T. if east, longitude.

It is easier in actual practice to make BOTH corrections at one operation after finding the E.G.M.T. INTERVAL (Step IV) by adding 9.86s per hour that the INTERVAL E.G.M.T. is past noon to the S.T., or subtracting 9.86s per hour that the INTERVAL E.G.M.T. is before noon from the S.T. See Lesson No. 36.

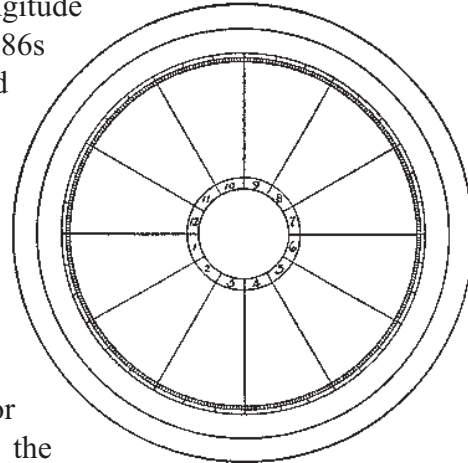

For the sake of clearness of detail the examples here perform the two corrections separately.

Example (10). Given a L.M.T. of 5h 36m 12s P.M. Jan. 2, 1920, at New York, to find the Sidereal Time.

5h 36m 12s	L.M.T	
+ 55s		to correct. interval
5h 37m 07s		
+18h 43m 20s		S.T. correction (See ephemeris)
24h 20m 27s		
+ 49s		correction for longitude
24h 21m 16s		
- 24h		subtract day
0h 21m 16s		True S.T. is the Answer

Example (11). Given a L.M.T. of 4h 50m 16s A.M. March 4, 1920, at San Francisco, to find the Sidereal Time.

12h 00m 00s	noon any day	
- 4h 50m 16s		L.M.T., subtract
7h 09m 44s		minus interval of <u>time</u>
+ 1m 11s		to correct interval
7h 10m 55s		corrected interval

$$\begin{array}{r}
22\text{h } 47\text{m } 47\text{s} \quad \text{S.T. Mar. 4, noon} \\
- \quad 7\text{h } 10\text{m } 55\text{s} \quad \text{subtract int.} \\
\hline
15\text{h } 36\text{m } 52\text{s} \\
+ \quad \quad 1\text{m } 20\text{s} \quad \text{correction for longitude} \\
\hline
15\text{h } 38\text{m } 12\text{s} \quad \text{True S.T. Answer}
\end{array}$$

HOUSE CUSPS

STEP III. How to Place Signs and Degrees Upon House Cusps.

—The dividing line between one house and another is called its cusp. The houses are numbered in example chart No. 1 (see page 2).

Rule 12.

—In a table of houses for the latitude of birth find in its column the S.T. of birth. Opposite this time, or its nearest approximate, will be found the sign and degree to be placed on each house cusp from 10th to 3rd. When these have been entered into the chart on their appropriate cusps, place the same degree of the opposite sign on the opposite house cusp. Signs opposite each other are given in Table I.

Example (12) Given a S.T. of Birth at New York of 0h 21m 16s, to place the zodiacal signs and degrees in the chart.

New York is 40° 43' N. Latitude. Consulting the table of houses for this latitude given in Raphael's ephemeris I find the nearest S.T. given as 0h 22m 02s. Opposite this S.T. under column marked 10, I find 6°, and looking up this column I find this to be of the sign Aries. I therefore place 6° Aries on the cusp of the 10th house in the chart.

Opposite the same S.T. I find 13° Taurus on the 11th house cusp, 21° Gemini on the 12th house cusp, 23° 24' Cancer on the 1st house cusp, or Ascendant, 13° Leo on the 2nd house cusp, and 6° Virgo on the 3rd house cusp. And I place them thus in the chart.

For the 4th house cusp I look in Table I of opposite signs and as Libra is always opposite Aries I use 6° Libra. For the 5th house cusp I use 13° Scorpio, as Scorpio is opposite Taurus; on the 6th I use 21° Sagittarius because Sagittarius is opposite Gemini; on the 7th I use 23° 24' Capricorn because Capricorn is opposite Cancer; on the 8th I use 13° Aquarius because Aquarius is opposite Leo; and on the 9th I use 6° Pisces because Pisces is always opposite Virgo. Example chart No. 1 has been corrected by Rule 13.

Inserting Missing Signs

—Frequently the same sign will be found on more than one house cusp. When this occurs other signs are missing. These may be found by counting the signs in their regular order. They should then be entered on the map in the middle of those houses where they fall by their natural sequence in the diac.

Tables of houses may be had giving the use cusp to the nearest tenth of a degree. here great precision is required the exact nute on any house cusp may be found by following rule:

Rule 13.³

—**To find the exact ' on any house cusp:**

Look in a table of houses for the latitude of th. Find **(a)** the difference between the arest and the next nearest S.T. of birth.

nd **(b)** the difference between the True S.T. of birth and the nearest S.T. of birth. Find **(c)** the difference between the cusps corresponding to the nearest and the next nearest S.T. of birth. Then (a): (b) :: (c): ?

Multiply (b) by (c) and divide the product by (a). If the True S.T. of birth is more than the nearest S.T. add; if less, subtract. Example 13. To find the exact ' on the Ascendant when the S.T. of birth at New York is 0h 21m 16s.

0h 22m 02s	nearest S.T.
- 18m 21s	next nearest
03m 41s	or 221s (a)
0h 22m 02s	nearest S.T
- 21m 16s	true S.T
0h 00m 46s	(b)
4S 23° 24'	nearest cusp
- 4S 22° 40'	next nearest
0S 00° 44'	(c)

SECOND KEY PROBLEM

Standard
21 Time of Birth _____

Hrs. E. or
22 W. of Greenwich _____

23 E.G.M.T. _____

24 Noon _____ 12:00

25 E.G.M.T. _____

26 E.G.M.T. Interval _____
(Indicate plus or minus)

ADDITIONAL FACTORS

27 Constant Log. _____

28 Limiting Date _____
(Including year)

on
wh
zo

ho
W
mi
the

4
bir
ne
Fi

³ See “Chart Erection Short Cuts and Examples” (last chapter in this book) for latitude correction notes.

⁴ For mapping the character, and the type of events which the thought-cells so mapped tend to attract, a chart with the nearest degree on the Ascendant and Midheaven is precise enough. But when it is desired to progress the positions of the chart to determine WHEN energy from a certain planet will be added to a group of thought-cells in sufficient volume to attract a specific event, it is essential that the Ascendant and Midheaven, which are treated as planets, should be calculated to the exact minute of zodiacal longitude.

To Work a Problem In Proportion

—As the product of the means is equal to the product of the extremes, when the two inner terms are given multiply one by the other and divide the product by the outer term. When the two outer terms are given multiply one by the other and divide the product by the inner term. The result is the answer. Such problems are taught in grammar school, and are essential to astrological work.

221 (a) :46 (b) ::44 (c): ?
44 X 46 equals 2024
2024 divided by 221 equals 9'

4S 23° 24'
- 9' subtract

4S 23° 15' or, Cancer 23° 15' is the Answer

South Latitude

—Tables of houses for north latitude may be used for places in south latitude by adding 12h to the S.T. and using the degrees thus found, but placing opposite signs on the house cusps. Detailed examples of this will be found in lesson No. 36.

SECOND KEY PROBLEM

PLANETS IN SIGNS

STEP IV. How to Find the E.G.M.T. INTERVAL

Rule 14.

—To find the difference in time between the place of birth and Greenwich, multiply the ° distant in longitude from Greenwich by 4, calling the product minutes, and multiply the ' by 4, calling the product seconds. Convert into hours and minutes.

Example (14). Given a long. of 73° W 57' (New York) to find the difference in time from Greenwich.

73 X 4 equals 292m. 57 X 4 equals 228s. 292m divided by 60 equals 4h, plus 52m remainder. 228s divided by 60 equals 3m, plus 48s remainder. 4h 52m plus 3m 48s equals 4h 55m 48s. Ans.

Rule 15.

—Divide the ° by 15. The quotient is hours, the remainder multiplied by 4 is minutes.

Example (15). Given a long. of $118 \frac{1}{4}^\circ$ (Los Angeles) to find the difference in time from Greenwich.

$118\frac{1}{4}$ divided by 15 equals 7h. The remainder, $13\frac{1}{4} \times 4$ equals 53m. 7h 53m, Ans.

Rule 16.

—To find the E.G.M.T. when the place is west of Greenwich, add the difference in time to the L.M.T., when the place is east of Greenwich subtract the difference in time from the L.M.T.

Example (16a). Given a L.M.T. of 5h 36m P.M. and a difference in time of 4h 56m W. (New York), to find the E.G.M.T.

$$\begin{array}{r} 5\text{h } 36\text{m} \quad \text{P.M. L.M.T.} \\ + 4\text{h } 56\text{m} \quad \text{add} \\ \hline 10\text{h } 32\text{m} \quad \text{P.M. E.G.M.T. is the Answer} \end{array}$$

Example (16b). Given a L.M.T. of 10h 02m A.M., and difference in time of 54m E. (Berlin), to find the E.G.M.T.

$$\begin{array}{r} 10\text{h } 02\text{m} \quad \text{A.M. L.M.T.} \\ - \quad 54\text{m} \quad \text{E. Subtract} \\ \hline 9\text{h } 08\text{m} \quad \text{A.M. E.G.M.T. is the Answer} \end{array}$$

Example (16c). Given a L.M.T. of 4h 50m A.M., and difference in time of 7h 53m W. (Los Angeles), to find the E.G.M.T.

$$\begin{array}{r} 4\text{h } 50\text{m} \quad \text{A.M. L.M.T.} \\ + 7\text{h } 53\text{m} \quad \text{W. add} \\ \hline 12\text{h } 43\text{m} \\ - 12\text{h } 00\text{m} \quad \text{subtract} \\ \hline 0\text{h } 43\text{m} \quad \text{P.M. E.G.M.T. is the Answer} \end{array}$$

The Interval E.G.M.T. is the number of hours and minutes after noon, called a PLUS INTERVAL, or the number of hours and minutes before noon, called a MINUS INTERVAL. Thus in the above examples the E.G.M.T. Interval of (a) is plus 10h 32m, of (c) is plus 0h 43m. But if the E.G.M.T. is before noon, it must be subtracted from noon to get the Interval, and the result is then a Minus Interval. Thus in the above example (b) find the Interval.

$$\begin{array}{r} 12\text{h } 00\text{m} \quad \text{Noon} \\ - 9\text{h } 08\text{m} \quad \text{A.M. E.G.M.T.} \\ \hline 2\text{h } 52\text{m} \quad \text{Minus Interval is the Answer} \end{array}$$

**STEP V. How to Find
the-Constant Proportional
Logarithm.**

—A table of proportional logarithms is a decimal mathematical table simplifying difficult problems in proportion. The Constant Logarithm is the number found in a table of proportional logarithms corresponding to the E.G.M.T. Interval.

Rule 17.

—**To find the Constant Logarithm** look in a table of diurnal proportional logarithms and find the figure corresponding to the E.G.M.T. Interval.

Example (17). Find the Constant Log. for an interval of plus 10h 32m. Interval is 10h 32m. Looking in the table of proportional logarithms in the back of Raphael's ephemeris I look down the column marked 10h until it intersects with the horizontal column marked 32m. There I find .3576. Ans.

**STEP VI. How to Find the Daily
Motion of Any Planet.**

—In recent years the swifter planets have their daily motion given for each day in the latter part of Raphael's ephemeris.

Rule 18.

—**To find the daily zodiacal motion of any planet**, consult the ephemeris for the two days between which the E.G.M.T. occurs and subtract the less longitude from the greater in the regular order of the zodiacal signs.⁵

Example (18). Find the daily zodiacal motion of the Moon Jan. 2, 1920.

$$\begin{array}{r}
 3S\ 08^{\circ}\ 31'\ 47'' \quad \text{Jan. 3} \\
 -\ 2S\ 23^{\circ}\ 43'\ 38'' \quad \text{Jan. 2} \\
 \hline
 0S\ 14^{\circ}\ 48'\ 09'' \quad \text{Is the Answer}
 \end{array}$$

5 Pluto's position is given in Raphael's ephemeris starting 1934, and in the Pluto ephemeris for earlier years. Call the days between ephemeris positions (a), the days between ephemeris date and required date (b), the minutes Pluto moves between these two positions (c), and the motion of Pluto during required interval (d). Then (a): (b) :: (c) (d). Thus using the Pluto ephemeris, during the 30 days (a) from December 16, 1919, to January 15, 1920, Pluto moves 35' (c). The interval between January 2 and January 15 is 13 days (b). 35 multiplied by 13 and divided by 30 gives 15' as the motion of Pluto during this interval. As it is retrograde, add these 15' to the place of Pluto January 15, and it gives the longitude of Pluto January 2, 1920, as 6 Cancer 36 R.

Rule 19.

—**To find the daily declination motion of any planet**, consult the ephemeris for the two days between which the E.G.M.T. occurs, and if both are either N. or S. declination subtract the less from the greater; but if one is N. and the other S. declination, add the given declinations. If the declination is given only every 2nd or 3rd day the result must be divided by 2 or by 3 to get the daily motion.

Example (19a). Find the daily declination motion of Mercury Jan. 2, 1920.

$$\begin{array}{r}
 \text{S.}22^{\circ} 51' \text{ Jan. 3} \\
 \underline{-\text{S.}22^{\circ} 39' \text{ Jan. 2}} \\
 0^{\circ} 12' \text{ daily motion is the Answer}
 \end{array}$$

Example (19b). Find the daily declination motion of Venus Apr. 14, 1920.

$$\begin{array}{r}
 \text{S.}0^{\circ} 14' \text{ Apr. 14} \\
 \underline{-\text{N.}0^{\circ} 15' \text{ Apr. 15}} \\
 29' \text{ daily motion is the Answer}
 \end{array}$$

STEP VII. How to Find the Proportional Logarithm of the Daily Motion of a Planet.

Rule 20.

—**To find the proportional logarithm of a planet’s daily motion** look in a table of proportional logarithms and find the ° and ´ corresponding to its daily motion.

Example (20). Find the prop. Log. of the Moon’s daily motion Jan. 2, 1920. Daily motion (example 18) 14° 48´ 9". Neglecting the 9" I consult the table of logarithms in Raphael’s ephemeris and where the column 14° intersects with 48´ I find .2099. Ans.

STEP VIII. How to Find the Motion of Any Planet for the E.G.M.T. Interval.

Rule 21.

—**To find the distance traveled by any planet during the Interval**, add the Constant Logarithm to the Logarithm of the Daily Motion. This gives the log. of distance traveled during the Interval.

Example (21). How far in longitude does the Moon travel on Jan. 2, 1920, during a plus interval of 10h 32m?

$$\begin{array}{r}
 10\text{h } 32\text{m is } \quad .3576 \quad \text{Constant log.} \\
 14\text{h } 48\text{m is } \quad \underline{+ .2099} \quad \text{Log. of daily mot.} \\
 \quad \quad \quad .5675 \quad \text{Log. of Interval}
 \end{array}$$

Looking in table of logarithms I find that .5675 gives 6° 30' which is the Answer.
Note: In using logarithms always use the nearest approximate figure.

STEP IX. To Find the Zodiacal Longitude of the Planets at Birth.

Rule 22.

—To find the zodiacal longitude of a planet when the Interval is plus, add its travel for the interval to the place given in the ephemeris for noon. When the Interval is minus, subtract its travel for the interval from the place given in the ephemeris for noon. *If, however, the planet is retrograde (marked R at top of column in ephemeris) reverse this, and subtract for plus interval, and add for minus interval.*

Example (22). Find the zodiacal longitude of the Moon Jan. 2, 1920, when there is a plus E.G.M.T. Interval of 10h 32m.

$$\begin{array}{r}
 2S\ 23^{\circ}\ 43'\ 38'' \quad \text{noon} \\
 + \quad \quad 6^{\circ}\ 30'\ 00'' \quad \text{mot. int.} \\
 \hline
 3S\ 00^{\circ}\ 13'\ 38'' \quad \text{or Gemini } 0^{\circ}\ 14'
 \end{array}$$

STEP X. To Find the Declination of the Planets at Birth.

Rule 23.

—To find the declination of a planet when the Interval is plus, add the declination for the interval to the noon declination if the declination is increasing, subtract if decreasing. When the Interval is minus, subtract the declination for the interval from the noon declination if the declination is increasing, add if decreasing. If the declination changes from N to S or S to N, this must be allowed for.

Example (23). Find the declination of the Moon Jan 2, 1920, when there is a minus Interval of 2h 14m

$$\begin{array}{r}
 N\ 18^{\circ}\ 44' \quad \text{noon} \\
 - \quad \quad 0^{\circ}\ 16' \quad \text{interval} \\
 \hline
 N\ 18^{\circ}\ 28' \quad \text{Answer}
 \end{array}$$

The declination of any house cusp, the Moon's Nodes, or the Part of Fortune is always that of the Sun when it is in the same sign and degree.

January 2, 1920
 New York, New York
 5:32 p.m. E.S.T.

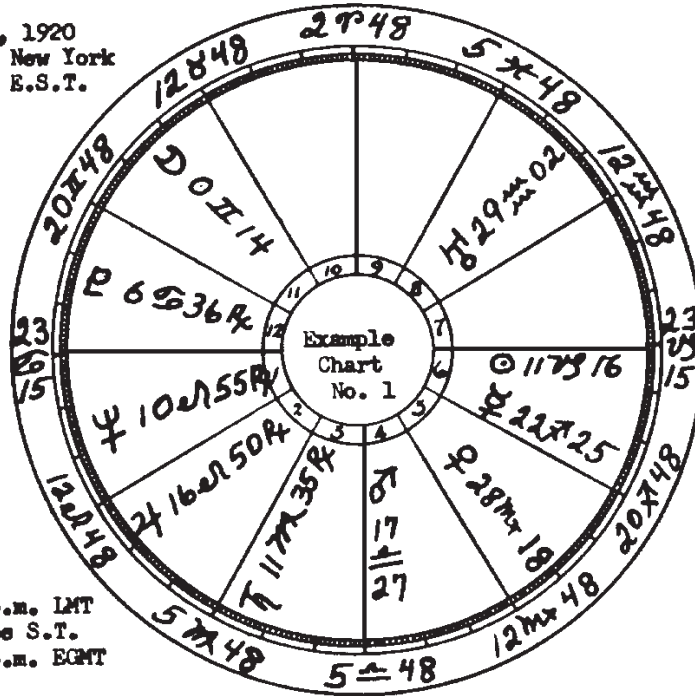

5:36:12 p.m. LMT
 0h 21m 16s S.T.
 10h 32m p.m. EGMT

Declinations	ASPECTS												
	☉	☽	♃	♄	♅	♆	♁	♂	♃	♄	♅	♆	Asc
22558	☉	☽	♃	♄	♅	♆	♁	♂	♃	♄	♅	♆	Asc
19N29	☽			♃	♄			♁		♂	♃	♄	Asc
22544	♃				♄	♅			♁				Asc
17521	♄				♅	♆	♁	♂			♃	♄	Asc
5503	♅					♆	♁	♂	♃	♄			Asc
16N34	♆							♁					Asc
8N54	♁								♂				Asc
12S30	♂									♃			Asc
17N28	♃										♄		Asc
19N23	♄											♅	Asc
2N18	M.C												
21N26	Asc												

Example Chart 1

Rule 24.

—To find the declination of any house cusp, the Moon’s Nodes, or the Part of Fortune, look in the ephemeris for the position of the Sun in the same sign, degree and minute, and use this declination ⁸

Example (24). Find the declination of the Ascendant when Cancer 23° 37’ is rising

July 16, 1920, shows the Sun in Cancer 23° 37’ , and on that day it also has declination N 21° 23’ , which is the Answer.

STEP Xa. How to Find the Zodiacal Longitude of the Fixed Stars, the Dragon’s Head and Tail, and the Part of Fortune.

—The zodiacal positions of the fixed stars may be had from tables made for that purpose. As they move only 1 ° in about 72 years their places may be had by inspection. The house positions of the stars, however, for those having considerable latitude, require the use of trigonometrical calculations.

Example: What important Fixed Star is nearest the Asc in longitude when Cancer 23° 13’ rises? Looking in Dalton’s “Sixteen Principle Stars” I find on Jan. 2, 1920, the star Procyon in Cancer 24° 41’ 8".

The Dragon’s Head is the Moon’s north Node, the Dragon’s Tail is its south Node. The North Node is calculated from its place as given in the ephemeris as if it were a planet, and the South Node is always the same degree of the opposite sign.

Example: Find Moon’s Nodes for Jan. 2, 1920, for a plus E.G.M.T. Interval of 10h 32m. Looking in ephemeris for Jan. 2, I find the North Node in Scorpio 22° 17’ . The South node, therefore, is Taurus 22° 17’ .

8 **Declination of the Angles:** Find (a) difference between nearest and next nearest long. In table (next page). Find (b) difference between nearest long. In table and long. Of Angle. Find (c) difference between declinations corresponding to nearest and next nearest long. In table. Problem by Logs: (b) minus (a) plus (c) equals (d) — correction to be made. Add correction to nearest decl. In table if nearest long. Is smaller than long. Of Angle; if larger, subtract.

Find decl. Of Ascendant 23° Cancer 15’.

Log. (b) 1.9823 0° 15’

Log. (a) 1.3802 1° 00’
 .6021

Log. (c) 2.1170 0° 11’

Log. (d) 2.7191 0° 03’

Subtracting 3’ from 21° N29’ gives 21° N26’ as the Answer.

The Part of Fortune is a point on the ecliptic (zodiac) as far removed from the Ascendant by longitude as the Moon is removed from the Sun by longitude.

Rule 25. To find the Part of Fortune, from the sum of the zodiacal longitudes of the Ascendant and Moon subtract the zodiacal longitude of the Sun. This difference is the longitude of the Part of Fortune.

Example (25). Find the Part of Fortune Jan. 2, 1920, for a plus E.G.M.T. Interval of 10h 32m.

4S 23° 13'	Long. Asc.
+ 3S 00° 14'	Long. Moon
<hr style="width: 100%; border: 0.5px solid black;"/>	
7S 23° 27'	Sun
7S 23° 27'	"
+12S 00° 00'	Add zodiacal circle
<hr style="width: 100%; border: 0.5px solid black;"/>	
19S 23° 27'	
+10S 11° 16'	Longitude of Sun
<hr style="width: 100%; border: 0.5px solid black;"/>	
9S 12° 11'	or Sagittarius 12° 11' is the Answer

STEP XI. How to Place the Planets in the Chart.

Rule 26.

—The declination of each planet N. or S. having been calculated, it should be placed opposite its symbol in a column at one side of the chart. See Example Chart No. 1.

Rule 27.

—The zodiacal longitude of each planet having been calculated, start with the Ascendant. Remember the degrees recorded are those above the horizon in this case, hence if a planet has less degrees of the same sign it must be placed above the house cusp in the 12th, but if it has more degrees it must be placed in the chart below the Asc. Then proceed around the chart in the order of sequence of the houses entering the planets in their signs, placing those having less degrees than the house cusp next back toward the Ascendant, and those having more degrees than the house cusp in the house farther removed from the Asc. following the proper order of sequence of houses.

The Moon's Nodes, Part of Fortune, and Fixed Stars having little latitude may be placed in the chart in the same manner. Fixed Stars having much latitude must be entered by R.A. and Dec. (See Dalton's Fixed Stars.)

Note: As in thousands of birthcharts erected and progressed to the date of some event, The Brotherhood of Light Research Department has found no instance where a Fixed Star, the Moon's Nodes, or the Part of Fortune has been required to explain either the character of an individual or any event that has happened to him, we make no use of them. It must be remembered that the positions in a chart of Uranus, Neptune and Pluto were unknown to earlier astrologers, who doubtless became aware of influences apart from the seven naked eye orbs, and accounted for them as best they could.

Chapter 2

Serial No. 87
Original Copyright 1930
Elbert Benjamine

Copyright
August 2002
Church of Light

Strength and Aspects of The Planets

Table of Essential Dignities								
Planet	Rule Home	Detriment	Exaltation	Degree Exalt.	Fall	Degree Fall	Harmony	Inharmony
☉	♌	♎	♑	19	♍	19	♈	♁
☽	♋	♏	♍	3	♌	3	♉	♁
♀	♁	♈	♎	15	♌	15	♌	♏
♁	♁	♏	♈	27	♁	27	♎	♌
♂	♏	♁	♋	28	♎	28	♌	♏
♄	♈	♁	♎	15	♏	15	♏	♌
♃	♏	♁	♍	21	♑	21	♁	♈
♂	♏	♁	♁	7	♈	7	♍	♑
♃	♈	♁	♈	18	♁	18	♎	♏
♂	♏	♁	♌	17	♎	17	♑	♍

Table of Accidental Dignities			
House	Very Powerful	Powerful	Very Feeble
I. X. VII. IV.	XI. VIII. IX. XII.	II. III.	V. VI.

Table of Aspects and Their Orbs								
Symbol of Aspect	Name of Aspect	Number of Apart	Succeedent Houses Planets	Succeedent Houses Orbs	Angular Houses Planets	Angular Houses Orbs	Cadent Houses Planets	Cadent Houses Orbs
☉	Conjunction	0°	10	13	12	15	8	11
♋	Semi-sextile	30	2	3	3	4	1	2
♌	Sextile	60	6	7	7	8	5	6
♍	Square	90	8	10	10	12	6	8
♎	Trine	120	8	10	10	12	6	8
♏	Inconjunction	150	2	3	3	4	1	2
♐	Semi-square	45	4	5	5	6	3	4
♑	Sesqui-square	135	4	5	5	6	3	4
♒	Opposition	180	10	13	12	15	8	11
♓	Parallel		1	1	1	1	1	1

M.C. and Asc. have the same orb as planets in angles.

HOW THE ASPECTS EXPRESS

- I. Conjunction, 0° , expresses through PROMINENCE.
- II. Semi-Sextile, 30° , expresses through GROWTH.
- III. Sextile, 60° , expresses through OPPORTUNITY.
- IV. Square, 90° , expresses through OBSTACLES.
- V. Trine, 120° , expresses through LUCK.
- VI. Inconjunct, 150° , expresses through EXPANSION.
- VII. Semi-Square, 45° , expresses through FRICTION.
- VIII. Opposition, 180° , expresses through SEPARATION.
- IX. Sesqui-Square, 135° , expresses through AGITATION.
- X. Parallel, 0° declination, expresses through INTENSITY.

Chapter 2

Strength and Aspects of the Planets

THE student of astrology should realize that every horoscope, instead of being a combination of mystical symbols, is in fact a map of actual vibratory currents which are operating at the time for which it is erected. These vibratory currents constitute the inner-plane weather. It has been conclusively demonstrated by many universities which have carried out innumerable experiments in extrasensory perception and psychokinesis that inner-plane energies do not conform to physical laws. The outer-plane weather not only influences life on earth, but also inanimate objects, as illustrated by mountain chains being worn down and carried into the ocean. However, when velocities exceed that of light there can be no atoms or molecules. Thus the inner-plane weather, which has velocities exceeding that of light, influences both animate and inanimate objects through non-physical laws which may be discovered, not by theory, but by observing how things actually react to different types of inner-plane weather.

Astrological currents constitute the inner-plane weather, the ten outstanding types being the vibratory currents radiated by the ten planets, each having its own characteristic influences. And to understand individual reaction to the inner-plane weather mapped by astrological positions it should be recognized that most of the actions of human life spring into existence, not as a result of premeditation, but due to habitual reaction to feeling, which in turn is powerfully influenced by the planetary energies which at any time are added to certain thought-cells of the unconscious mind.

Psychology teaches us that at least 99% of all men's actions are promoted by the unconscious mind. The unconscious mind, as fully explained in the lessons on Esoteric Psychology, is an organization of thought-elements into thought-cells and thought structures. This organization persists in the same astral substance that carries the vibrations of planetary influence. And not only does a birth-chart map the arrangement and volume of energy of different types possessed by these thought-cells, and therefore the individual's character, but the progressed aspects map the time when groups of these thought-cells acquire sufficient additional planetary energy that they have enough psychokinetic power to attract events of a corresponding nature.

As already indicated, man is not the only thing influenced by the stars. Each physical object has an astral counterpart that is constantly affected by vibrations of astral substance that reach it from celestial bodies. In turn, the astral counterpart profoundly affects the physical. And as thoughts are essentially organizations in astral substance they too respond to such astral vibratory rates. Currents of astral force not only bring changes to man's physical body, but they stimulate the trend of his thinking, and impress their power upon everything by which he is surrounded.

Every horoscope is a map of such astral currents showing four important factors: (1) The Tone, or Rate of Vibration, of each stream of planetary force. This depends upon its wave-length and frequency. (2) The Tone Quality of the current from each planet. While the aspects map the chief harmonies and discords, minor and quite distinctive harmonies and discords arise from the medium, or Sign the planet occupies. (3) The Power, or Volume of energy coming from each planet. While each aspect, through the joining of energies, adds to a planet's Power, much also depends upon the Direction from which the energy reaches that point on earth for which the chart is erected. (4) The Aspects indicate the chief Harmonies and Discords. These depend upon the angles at which the streams of energy meet each other.

Having such a chart of astral currents, and being aware of the particular thing receiving these vibrations, it is possible to estimate the reactions to their influence. Because these reactions constitute events, this makes accurate prediction of trends possible.

1. The First Requisite for judging any horoscope Natal, Stellar Diagnosis, Mundane, Weather, or Horary—is to know the particular Tone, or rate of vibration, radiated by each of the planets, and what the observed effects are of these vibrations upon life. Just as colors, musical tones, etc., depend upon electromagnetic wave-lengths or wave-lengths of physical substance, so each planet radiates a given wavelength and frequency in astral substance which we call its Tone. The effect of each planetary Tone is given in lesson No. 47 (See Serial Lesson Key).

Of the 10 planets only 4 are harmonious or discordant due to their own nature. Venus is harmonious, adding harmony equal to $\frac{1}{4}$ the power of each aspect it makes. Mars is discordant, adding discord equal to $\frac{1}{4}$ the power of each aspect it makes. Jupiter, the major benefic, adds harmony $\frac{1}{2}$ the power of each aspect it makes. And Saturn, the major malefic, adds discord $\frac{1}{2}$ the power of each aspect it makes. The other 6 planets are neutral insofar as harmony or discord is concerned, their harmony or discord being determined only by their essential dignity and the aspects they form.

2. The Second Requisite for judging any horoscope is to know the Tone Quality of each Sign and Planet in the chart. The Nature and Tone Quality of each of the 12 Signs is fully explained in lesson No. 46 (See Serial Lesson Key). This Tone Quality of a sign influences each planet found in the sign in a somewhat different manner. This is due to the particular planetary tone and the characteristic resonance of the sign.

The zodiacal signs act as sounding boards, or instruments, from which the planetary vibrations reach the earth. Each is a definite section of the astromagnetic field of force which surrounds the sun. Due to this definite position in a field of force, the tension of the astral substance through which the vibrations of a planet must travel is different in each sign, and varies to a less extent even in the different decanates of the same sign. This property of the astral substance of a sign may make it a harmonious sounding board for transmitting the vibrations of some of the planets, but a discordant sounding board for transmitting the vibrations of other planets.

Furthermore, when one planet is in the home sign or exaltation sign of the other planet at the same time the other planet is in the home sign or exaltation sign of this planet, the resonance thus created tends to be the most harmonious of any due to the sign Positions of planets. Such sign relationship between planets is called MUTUAL RECEPTION. Observation indicates that the departments of life ruled by houses occupied by planets thus in mutual reception tend markedly to assist each other. Planets do not need to be in aspect with each other to be in MUTUAL RECEPTION.

The power, harmony or discord of any birth-chart or progressed planet, aspect, sign or house can be precisely calculated. Explanation of how to make These calculations is given in Course XVI, Stellar Healing But here only certain comparisons will be made. Power is measured in astrodynes, harmony in harmodynes, and discord is discordynes. Planets in MUTUAL RECEPTION gain $\frac{1}{2}$ the harmony given neutral planets when in an angle and making the perfect trine.

It has experimentally been determined that a planet not only sets up vibrations in the sign it occupies, but also in certain other signs. These special signs are so sympathetically tuned to the planet that they vibrate to it no matter where it is located. They are keyed to the tone of the planet, and respond to its vibrations, much as a musical instrument keyed to a particular tone will respond to that tone when struck on another instrument, even when the other instrument is at a distance.

These signs that persistently transmit the vibrations of a given planet, whether or not the planet is in them, are said to be Ruled by that planet. When the planet is in one of these signs it Rules, it is said to be at HOME.

The sign that a planet rules transmits easily the constructive characteristics of the planet when the planet is in it. A planet at HOME thus gains the harmony given neutral planets when in a succedent house and making the perfect semi-sextile. When a planet is in the sign opposite its home, which is called its DETRIMENT, it thus gains $\frac{1}{7}$ the discord given neutral planets when in a succedent house and making the perfect semi-square.

The vibratory quality of the signs ruled by a planet is markedly influenced by any modification in the vibration of the planet. If it sounds from some other sign that does not permit harmonious expression, this discord is also called out in the signs ruled by the planet. That is, the signs ruled by a planet respond to the vibrations that actually reach them. and these vibrations are given a harmonious or a discordant trend, not merely by the aspects of the planet, but also by the sign in which the planet is located.

When a planet is not in the sign, but rules the sign, and the sign is on the cusp of a house, the sign through resonance gains $\frac{1}{2}$ the planet's power, harmony or discord. If the sign is not on the cusp of a house, but is an intercepted sign, it gains through resonance $\frac{1}{4}$ the planet's power, harmony or discord.

The most refined influence exerted by a planet however, is not when it is at home, but when in another sign which not only permits it to express its energy fully, but which due to the peculiar quality of its astral substance, lends itself particularly to the expression of the finer and more intense vibrations of the planetary tone. This other sign, which only transmits the planet's vibrations strongly when the planet is in it, yet which lends itself singularly to the highest expression of the planet's qualities, is called the planet's EXALTATION. A planet in its exaltation thus gains $\frac{1}{2}$ the harmony given neutral planets when in a succedent house and making the perfect sextile. When a planet is in the sign opposite its exaltation, which is called its FALL, it thus gains the discord given a neutral planet in a cadent house and making the perfect semi-square.

The ancients held that there is also a particular degree in the Sign of Exaltation in which the planet exerts a better influence than in any other degree of the zodiac. Modern observation tends to confirm this. When a planet is in this particular degree which is called its DEGREE OF EXALTATION, it gains $\frac{1}{2}$ the harmony given neutral planets when in a succedent house and making the perfect trine. When a planet is in the degree opposite its degree of exaltation, which is called its DEGREE OF FALL, it thus gains the discord given neutral planets when in a succedent house and making the perfect semi-square.

There is also another sign in which a planet gains a little harmony, but only half as much as when at home. This sign is called its HARMONY. A planet in the sign of its harmony thus gains $\frac{1}{2}$ the harmony given neutral planets when in a succedent house and making the perfect semi-sextile. When a planet is in the sign opposite its harmony, which is called its INHARMONY, it thus gains $\frac{1}{4}$ the discord given neutral planets when in succedent houses and making the perfect semi-square.

By his general knowledge of the nature of each planet and each sign, the student becomes able approximately to determine the harmony or discord of a planet in any sign; for as a rule a planet is harmonious in a sign the nature of which is similar to its own, and discordant in a sign having dissimilar characteristics. But as this has been experimentally ascertained by others, it is well to memorize the signs in which each planet has its Home, Exaltation, Harmony, and also its Degree of Exaltation. From these the Detriment, Fall, Inharmony, and Degree of Fall can be ascertained by using the opposite factor in the zodiac. This harmony or discord of a planet due to being able to express its own true nature by occupying a sign or degree which forms a favorable or unfavorable sounding board for transmitting its vibrations is called the planet's ESSENTIAL DIGNITY. The table on page 34 gives the Essential Dignities of the planets, and should be well memorized.

3. The Third Requisite for judging any horoscope is to determine the Power, or Volume, or Quantity of force exerted by each planet in the chart. Each planet always vibrates to one particular tone, or Key; the Quality, or resonance being determined by the Sign it occupies; and the other harmony or discord depending largely upon the aspects it makes. Each aspect it makes increases its Power, which also is markedly influenced by the direction from which its stream of energy reaches the point on earth for which the chart is erected.

The reason the astral energy flowing from a planet does not reach all points on the earth in equal volume is probably due to the amount and density, as well as the movement, of the earth's astral substance it must penetrate. Relative to the Sun's position, the astral substance of the earth has areas of different pressure, or density, even as there are regions of different density in the earth's atmosphere caused by the sun. The trade winds, for instance, are an example of such sun-produced different atmospheric densities.

It is as if the earth were an auditorium into which the vibrations of the planets must penetrate from the outside; and that at regular intervals there were open doors, at other intervals small windows, and at other places thick walls, through which the planetary tones must pass. The twelve sections, or areas of different astral densities about the earth, called Mundane Houses, have been explained fully in lesson No. 47 (See Serial Lesson Key).

While the type of harmony or discord called the Quality of the planetary energy depends upon the Sign it is in, and the other harmony or discord, aside from that derived from the essential nature of the planet, depends upon the type of Aspects it makes, the Power, quantity or amount of energy it exerts depends upon the Aspects it makes and the Houses of the horoscope it occupies. All the planets pass through all the houses of a horoscope in the interval of 24 hours; but they remain days, and some of them many years, in each zodiacal sign. This house position of a planet, because of its short duration, is technically spoken of as its accidental station. Thus the Volume, or lack of it, due to a planet's position by House is called its ACCIDENTAL DIGNITY.

This Volume of energy exerted by a planet in each of the 12 Mundane Houses has been determined experimentally. As a general rule—the rule being handed down from ancient times—any planet in an Angular House exerts a Very Powerful influence, any planet in a Succedent House exerts only Average influence by power, and any planet in a Cadent House exerts Very Feeble power. But experience proves there are exceptions to this rule. Nevertheless, it will be found that an Angular House is more powerful than the Succedent, and a Succedent than a Cadent, House of its own quadrant of the Heavens.

The Power of a planet in any of the angles is greater than in any of the other houses, without exception; and the nearer a planet is to the Cusp of a house the more Power it exerts in that house. The most powerful houses for a planet are the 1st and 10th houses. The volume of energy received from a planet in either of these houses is

about the same. Next in volume of energy is the 7th house; and the feeblest of the angles is the 4th house. A planet in an Angle may always be considered VERY POWERFUL.

Next in Power are the 11th, 8th, 9th, and 12th, in the order named. A planet in the 8th or 12th has a less fortunate trend, as a rule, than if in the 9th or 11th, but we are here considering the Volume of Force, not its ability to attract fortunate events. A planet in the 11th, 8th, 9th or 12th house of the horoscope may always be considered MODERATELY POWERFUL.

The 2nd house is somewhat more powerful than the 3rd, but planets in the 2nd and 3rd houses should always be considered FEEBLE.

The 6th house is the feeblest position in the entire chart, the 5th house having little more volume. Planets in the 5th or 6th houses of a chart, aside from their aspects, are VERY FEEBLE.

The table on page 34 gives the ACCIDENTAL DIGNITIES of planets when found in the various houses of a horoscope.

4. The Fourth Requisite for judging any horoscope is to determine to what extent each planet's rays are harmonious or discordant, and in what particular way the harmony or discord manifests. The essential nature of the four of the 10 planets, and the essential dignity of each planet, contributes to this; but the chief factors are the aspects the planet makes. In lesson No. 41 it is fully explained how the streams of astral force from the planets converging at definite angles set up vortices, or whirls, of astral substance, and thus—as does the outer-plane weather—affect life. These whirls are produced only when the streams of force converge approximately at certain angles. And the nature of the whirl produced by streams of planetary force meeting at one angle is different from the whirl produced by planetary streams meeting at other angles. These angles, from which planetary energies meeting are known to produce whirls of a definite character, are called ASPECTS.

The aspects which have a proved effect are ten in number, and are mentioned in lesson No. 47 (See Serial Lesson Key). It is found that rays of planetary force converging at half a right angle, a right angle (90°), a right angle and a half, and twice a right angle, produce whirls in astral substance that are decidedly destructive in nature, but that the momentum of the whirl is different in each of these aspects, and consequently the destructive forces operate differently.

It is found that rays of planetary force meeting at a trine (120°), a half trine, and one-fourth of a trine, produce whirls in astral substance that are constructive in nature; but the modes of constructive activity differ with each aspect.

As do all the mentioned aspects the other three—conjunction, inconjunct and parallel—add Power to the planetary force of the planets involved, but so far as harmony or discord is concerned they are neutral. Of themselves they are neither constructive nor destructive.

It might seem, from a cursory examination of the subject, as planets move north and south of the ecliptic, or path of the sun, that in calculating aspects this celestial latitude should be considered and the angle of the aspect determined upon a spherical basis. So to determine the aspects would make necessary a trigonometrical calculation for all planets not having the same North or South Latitude.

Experience proves, however, that the latitude of a planet—its distance from the ecliptic—need not be considered in calculating aspects. The ecliptic, or path of the sun, is the place of polarization in the field of force of our solar system; and planetary vibrations tend to travel parallel to the plane of the ecliptic rather than to cut across it diagonally. Therefore, the Zodiacal Degree or Degree of Declination which a planet occupies always indicates the direction in the heavens from which its vibrations reach a given spot, and all aspects, with the exception of the parallel, should be calculated from Zodiacal longitude, without regard to celestial latitude. The parallel disregards celestial latitude, but it is calculated from the declination, which is the distance from the celestial equator. This rule applies to Progressed Aspects as well as to aspects in the birth-chart.

I. A Conjunction is the aspect formed when two planets are approximately in the same degree of the zodiac. It is one of the three most potent aspects. The rays of astral energy radiated by the planets in conjunction travel almost identically the same path, each making it easier for the energy of the other fully to manifest. Thousands of charts analyzed by The Church of Light Research Department indicate there is no real basis for the teaching of some writers regarding either a planet “Combust” or a planet “Cazimi.” Instead, the closer the planet is to a perfect conjunction with the Sun, the more its characteristics manifest. Jupiter or Venus always adds harmony to a planet in conjunction with it; and Saturn or Mars always adds discord to a planet in conjunction with it. But whether for good or ill, a conjunction always gives more power to both planets involved, and makes the things signified by each a prominent factor.

A planet is combust when it is within $8^{\circ} 30'$ of the Sun. According to some writers, when a planet is combust its influence is burnt up and destroyed, and it is considered to be a great affliction, the planet being weakened. They also say that a planet “Cazimi” is greatly strengthened. A planet is cazimi when it is within $17'$ of the Sun’s center. As the disc of the Sun occupies approximately half a degree, a planet cazimi sends its rays to the earth along lines quite identical with those of the Sun insofar as the zodiacal degree occupied is concerned, and the result would be some power. But we have never found a planet’s influence to be weakened by being in conjunction with the Sun. On the contrary, we have found that a planet in conjunction with the Sun invariably exerts a stronger influence in a birth-chart than when not aspecting the Sun.

When any planet is in conjunction with the Sun we have found it thus becomes a strong factor in molding the life and character of the person then born. As Mercury is never over 28° from the Sun, it is in combust in about one-fourth of all charts, and in a degree of combustion in about one-third of them. Venus is never more than 48° from

the Sun, and as a consequence is combust in at least one-seventh of all charts, and in a degree of combustion in about one-third of them. We do not think any planet is weakened by being near the Sun, and point to the charts of Theodore Roosevelt (lesson No. 95 [See Serial Lesson Key]), Thomas A. Edison (lesson No. 19 [See Serial Lesson Key]), Louis Pasteur (lesson No. 5 [See Serial Lesson Key]), Ewart Wm. Gladstone and Dr. Alfred Russel Wallace as examples picked at random who have Mercury combust in their birth-charts. Innumerable other birth-charts can be given of those with unusual brilliant minds who have Mercury combust.

The fortune or misfortune signified by a conjunction, either in the birth-chart or by progression usually is largely the result of the person's own character and actions than that of the compelling force of environment beyond his control. The one word that best expresses the most pronounced influence of a Conjunction is **PROMINENCE**.

II. A Semi-Sextile is the aspect formed when two planets are approximately 30 zodiacal degrees apart. This is a feeble harmonious aspect. Its constructive whirl manifests as a mildly benefic cooperation between the things signified by the two planets. It does not bring favors without effort, nor does it signify unusual abilities. It indicates rather those opportunities that are not obvious, but which can be created through initiative, and slowly developed and expanded into something worth while.

It signifies abilities and opportunities which are largely overlooked by less successful people, which are nevertheless present, but require a large amount of energy directed to them to bring them to fruition. Whatever good is signified by the semi-sextile, either in the birth chart or by progression, requires careful cultivation to bring it out, and is a matter of gradual expansion. The one word that best expresses the most pronounced influence of a Semi-Sextile is **GROWTH**.

III. A Sextile is the aspect formed when two planets are approximately 60 zodiacal degrees apart. This is a quite harmonious aspect. Its constructive energy manifests as adaptation to environment; there being such ability and opportunity as are signified by the two planets. It does not point to favors forced upon one, but both the ability to acquire the things signified and the opportunity to do so. The sextile aspect does not place fortune, health, fame and love in one's lap without effort; but it denotes a happy co-operation between the abilities of the individual and the opportunities that present themselves whereby if he applies himself he may attain favors signified by the planets.

Whatever good is signified by the sextile, either in the birth-chart or by progression, requires that opportunities be grasped as they present themselves; for if not quickly utilized they soon will pass and be beyond recall. The one word which best expresses the most pronounced influence of a Sextile is **OPPORTUNITY**.

IV. A Square is the aspect formed when two planets are approximately 90 zodiacal degrees apart. This is a quite discordant aspect. The destructive energy of this astral maelstrom acts in a violent manner. Uncontrolled, it manifests in harsh, rash, explosive bursts of energy that tend to tear up and destroy all its contacts. It signifies

positive lack of adaptation to environment, and consequent conflict. It brings acute crises, and temporary periods of struggle between the things signified by the two planets.

Because of its abruptness, students sometimes conclude that the square is worse than the opposition. It certainly does act with more violence, and it frequently leaves nothing of value in its wake. The opposition, on the other hand, usually deprives of one thing while leaving another. Yet the square, according to my observation, has not the certainty, the power, nor the persistence of the opposition. The two aspects bring about events that are decidedly different, and bring them about in quite different ways.

Whatever discord is signified by the square, either in the birth-chart or by progression, results from incompatibility between the things signified by the two planets stirring up energy that periodically gets beyond control. A square brings acute conflict and violent antagonisms that cause radical changes. Yet it should not be forgotten that any form of energy, if properly controlled, can be used constructively.

Practice is said to make for perfection, and certainly men learn to surmount difficulties by constantly being confronted with the necessity of surmounting them. Thus we find that the great men of the world invariably have squares in their birth-charts. They have plenty of trials and conflicts, but they make each a stepping stone to attainment, learning the technique of overcoming obstructions, and turning the destructive energy into constructive lines. The one word that best expresses the most pronounced influence of a Square is **OBSTACLE**.

V. A Trine is the aspect formed when two planets are approximately 120 degrees apart in the zodiac. This is the Best aspect. A trine signifies not only the abilities and opportunities bestowed by the two planets, but also such favors as come with very little effort. The good that comes through the trine comes easily and spontaneously. The abilities so signified grow naturally rather than being acquired with difficulty, and the opportunities are forced upon one without being asked for. Because the things denoted by the trine come so easily, they are often unappreciated.

Trines signify good qualities in the character because where they are concerned there is no temptation. But too many trines never produce a strong, virile character, for there are too few obstacles to overcome, and too little struggle necessary. Character is developed through overcoming obstacles, not in permitting others to remove them so the path will be easy. Whatever good is signified by the trine, either in the birth-chart or by progression, comes without commensurate effort. The one word that best expresses the most pronounced influence of a Trine is **LUCK**.

VI. An Inconjunct is the aspect formed when two planets are approximately 150 degrees apart in the zodiac. It is a neutral aspect in so far as harmony or discord is concerned, tending to be harmonious only when Jupiter or Venus is involved, and tending to be discordant only when Saturn or Mars is involved. Its energy manifests

in much the same manner as the conjunction and parallel, except that it has less force. Its strength is the same as the semi-sextile.

The obstacles it brings when Saturn or Mars are involved are not too difficult to surmount, and the opportunities it brings when Jupiter or Venus are involved require initiative to make much of them. Either in the birth-chart or by progression, the evil denoted by an inconjunct is easily converted into an advantage, and the good it signifies must be cultivated to prove of value. The aspect itself has the tendency to bring the things denoted by the two planets into some prominence, but to force them apart rather than together. The one word that best expresses the most pronounced influence of an Inconjunct is **EXPANSION**.

VII. A Semi-Square is the aspect formed when two planets are approximately 45 zodiacal degrees apart. This is a moderately discordant aspect. The destructive denoted manifests as uncertainty and vacillation. It sets up oscillations between the things denoted by the two planets. In human life it causes anxiety, hesitation, worry, criticism and many recurring abrasions, rather than cataclysmic disruptions. The evil it signifies is usually due to the cumulative effect of the little discords in the environment.

Either in the birth-chart or by progression, it tends toward changes. The discord it attracts, however, may usually be turned to advantage by overlooking the small annoyances and using them as spurs to greater effort. The one word that best expresses the most pronounced influence of a Semi-Square is **FRICTION**.

VIII. An Opposition is the aspect formed when two planets are approximately 180 zodiacal degrees apart. Though acting in a less cataclysmic manner than the square, because of its persistence and power, this is usually considered the Worst aspect. The energies of the two planets, when so situated, meet each other head-on, and refusing to mingle, boil back along the lines from which they came. The result is that the qualities of both planets are brought into great prominence, even as they are in the conjunction. Consequently the greatest abilities that men possess are mapped by the conjunction and the opposition. The opposition confers the quality of each of the two planets in maximum degree; and because of this a majority of the great names of history have oppositions in their birth-charts.

Great men invariably have great opposition to overcome or they would not be considered great. The opposition aspect attracts this. There is a constant antagonism between the things represented by the two planets. This constant struggle for supremacy between the two planets does not act abruptly, nor in acute crises like the square aspect, but develops slowly and unrelentingly. It has an inexorable quality. The issue cannot be avoided. A choice must be made between one of the two opposing factors, and this choice involves the necessity of losing one of them.

This disintegrative action proceeds slowly and inflexibly, and invariably tends to separate completely the things denoted by the planets. Either in the birth-chart or by progression, the opposition signifies conditions more immediately forced upon one by environment and apparently beyond control, that makes the choice of one thing a

necessity for renouncing another apparently desirable thing. It is a slow, inflexible rending asunder. The one word that best expresses the most pronounced influence of an Opposition is **SEPARATION**.

IX. A Sesqui-Square is the aspect formed when two planets are approximately 135 zodiacal degrees apart. This is a moderately discordant aspect, equal in strength to the semi-square. The energy of this discordant aspect has not the force of the square, or does it signify circumstances so important or antagonistic. Its action usually is to break up existing conditions rather suddenly, and thus pave the way for effort along somewhat different lines.

It acts in quite sharp and disruptive intervals. It calls for more decision than the semi-square, but is not so persistent and long drawn out. Either in the birth-chart or by progression, it signifies changes, either mental or physical, of a nature indicated by the planets; but these changes usually can be made an asset if accepted gracefully, for they open up new conditions. The word that best expresses the most pronounced influence of a Sesqui-Square is **AGITATION**.

X. The Parallel is the aspect formed when two planets occupy approximately the same degree of Declination, either both North or both South, or when one is North and the other is South of the celestial equator. This is the only aspect considered in the Hermetic System of Astrology which is not calculated by degrees in the zodiac. Even as the zodiac is divided by the equinoctial colure into positive and negative polarity, so in a somewhat similar manner the Equator divides our stellar auditorium, the astral substance immediately surrounding the earth, into positive and negative halves.

When two planets are an equal distance from the equator, either north or south, they set up synchronous vibrations within the earth's astral substance that have an effect somewhat like those produced by a conjunction in the zodiacal signs. That is, they tend to facilitate the manifestation of the full tones of both.

Jupiter and Venus will make any planet with which it is parallel more fortunate, and Saturn or Mars will make any planet with which it is parallel more unfortunate. The parallel from any of the other six planets increases the power, commensurate with the conjunction, but does not appreciably affect its harmony or discord. A birth-chart or progressed parallel may express through the house of the chart ruled by either of the planets involved in the parallel. But usually at the time there are other aspects present, even though these other aspects may involve planets not ruling the house influenced.

The influence of a parallel is not so precise nor so well defined as a conjunction. In its manifestation it is slower in development and more easily converted into energy of some other trend. Either in the birthchart or by progression, the parallel signifies qualities and conditions that develop slowly and that give gradual force to the things signified by the two planets. The one word that best expresses the most pronounced influence of a Parallel is **INTENSITY**.

The particular kind of a whirl in astral substance produced by each of the 10 aspects is most perfect in its form, and manifests its own peculiar kind of energy in strongest degree, when the aspect is the exact number of degrees designated for each. A whirl of a given design in water, air, electromagnetic field, or astral substance, however, is not the product of currents meeting at one single angle, any more than the color red is the product of a single number of vibrations in the electromagnetic field per second. There is a limited range of vibrations all producing what we call red, though of different shades, until they finally merge into another color.

The expression of a given aspect is strongest and clearest when the aspect is perfect, but the aspect will still manifest its peculiar energy, though less distinctly, as the number of degrees recedes from the perfect aspect, until its own distinctive kind of energy shades into that of the next aspect. With an occasional exception, such as when a powerful trine overrides and dominates a not too precise sesqui-square between adjacent aspects there is a space where the tendency to form one kind of whirl is neutralized by the tendency to produce another kind; just as in colors certain rates of vibration produce a shade that makes it difficult to say whether it is red or orange, being a blend of both.

It has been determined through exhaustive research how many degrees removed from the perfect aspect that an aspect manifests its own kind of energy with sufficient distinctness to have an appreciable effect upon life. The number of degrees away from the perfect aspect that a planet manifests even a slightly characteristic quality of the aspect is called its orb of influence, or merely ORB.

Not only do progressed aspects have a much more limited orb, but there is a marked difference in the way they operate at the margin of the orb. A great deal of research demonstrated that the orb of any progressed aspect is one degree from the perfect aspect, and that at the outer limit of this one degree orb the aspect has $\frac{1}{2}$ the power it has when perfect; but that in a birth-chart aspect the influence tapers off gradually from its peak power, when perfect, to no power at the outer margin of its orb.

One of the most important, and at the same time most difficult, considerations in every judgment from a horoscope is that of Orb of Influence. It may be well enough to say that as a general rule an orb of 5 degrees either way from a planet should be allowed; but students who use the full 5 degrees for the semi-sextiles in feeble houses, and limit the orb of influence to 5 degrees in oppositions from angular houses will find their judgment sadly at fault. They will never be able to render that fine discrimination that takes the science from the realm of broad generalities and gives to it the nicety and precision that are the marks of expert craftsmanship.

The Orb of Influence Table of each of the aspects when formed from succedent houses, from angular houses, and from cadent houses. It is the result of more than 50 years' experience judging horoscopes and the collaboration of the Research Department of The Church of Light.

The student need not memorize this table, but should commit the following considerations to memory: Under average circumstances an orb of 2° is right for the

semi-sextile and inconjunct between planets, and 3° when Sun or Moon is party to the aspect. For semi-square and sesqui-square, allow an orb of 4° for the planets, and 5° when Sun or Moon is party to the aspect. For the sextile, allow an orb of 6° between planets, and 7° when Sun or Moon is party to the aspect. For the square and trine, allow an orb of 8° for the planets, and 10° when the Sun or Moon is party to the aspect. For the conjunction and opposition, allow an orb of 10° between the planets, and 13° when the Sun or Moon is party to the aspect. For the parallel, an orb of 1° is correct.

As the volume of a planet's stream of energy reaching a given spot depends upon the house position, the student will find that he must allow a slightly larger orb when one or more of the aspecting planets occupies a powerful house, and an orb slightly less when both planets occupy feeble houses. The orb allowed should be that of the planet with most power due to being a luminary or occupying a powerful house.

It should be memorized that for the conjunction, opposition, square or trine, when the planets, one or both are in angles, 2° should be added to the average orb given; and when neither of the planets is in an angle or succedent house, but both are in cadent houses, 2° should be subtracted from the given orb. With the sextile, semi-sextile, semi-square, sesqui-square and inconjunct, when one of the planets occupies an angle, 1° should be added to the average orb given, and when both are in cadent houses, 1° should be subtracted from the average orb.

Calculating All the Aspects that occur between the planets in any chart is a very simple matter when undertaken in a systematic manner. An example of this is given in lesson No. 88 (See Serial Lesson Key). Always start with the aspects of the Sun, as most important, than those of Moon, Mercury, Venus, Mars, Jupiter, Saturn, Uranus, Neptune and Pluto, in the order given in Table II of lesson No. 86. The aspects must always be calculated the shortest distance between the planets, and never in the contrary direction from that usually followed by the planets as they move through the zodiac. Always calculate from the planet that will enable you to count ahead in the natural order of the zodiacal signs, as it is the number of zodiacal degrees apart and not the number of houses that make an aspect.

Planets Occupying Approximately the Same Degree of Any Sign Are Always in Aspect

—If they are in adjacent signs they are semi-sextile, if two signs part they are sextile, if three signs they are square, if four signs apart they are trine, if five signs apart they are inconjunct. Movable signs are always in square or opposition to each other, and taken collectively are known as the Movable Cross. Fixed signs are always in square or opposition to each other, and taken collectively are known as the Fixed Cross. Mutable signs are always in square or opposition to each other, and taken collectively are known as the Mutable Cross. When two planets are in approximately the same degree of one cross they are conjunction, opposition, or square.

When two planets thus are in opposition and a third planet is square to both, it is called a T-square. Such a combination maps much energy, which if not diverted attracts misfortune.

When two planets in opposition are both square to two other planets in opposition, thus making a complete cross, it is called a Grand Square. This is the most malefic combination that can occur in a chart.

The signs of any one element are always in trine, and when two planets occupy approximately the same degree of different signs of the same element, or triplicity, they are always in trine. When both of the two planets which make a trine to each other are also trine to a third planet, so that approximately an equilateral triangle is formed, it is called a Grand Trine. This is the most benefic combination that can occur in a chart.

Conjunctions always occur when planets are adjacent, and parallels when they occupy approximately the same degree of declination. A glance will reveal any of the above aspects and combinations.

The Only Aspects Difficult For The Beginner To Perceive

—These are the semi-square and the sesqui-square. The degree occupied by a planet forming either of these aspects must always be approximately half a sign more than that occupied by the planet counted from. Therefore add 15° to the place of the first planet and notice if any other planet occupies approximately this degree in any other sign, not overlooking the fact that a planet in the last degree of one sign may be approximately in the same degree as a planet in the first degree of another sign.

When a planet is found in such a place, notice if it is in a sign that is either a sign and a half, or four signs and a half, distant. If the former, it is a semisquare. If the latter, it is a sesqui-square. But if it is two signs and a half, three signs and a half, or five signs and a half, distant, it is in a position of little consequence and should be neglected.

Chapter 3

Serial No. 88
Original Copyright 1930
Elbert Benjamine

Copyright
August 2002
Church of Light

First Seven Steps In Judging Any Horoscope

DECLINATIONS

8° N 38'	○
14 S 47'	▷
3 S 27'	⋈
1 S 14'	♀
11 S 09'	♁
19 N 05'	♃
11 N 23'	♅
10 S 36'	♁
18 N 04'	♃
19 N 37'	♅
21 S 01'	M.C.
16 S 04'	Asc.

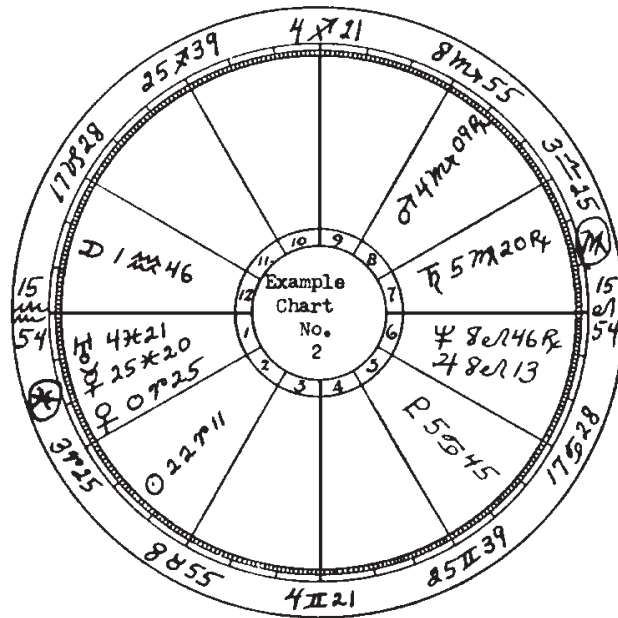

Example Chart #2

April 12, 1920
 Meeker, Colorado.
 3h. 00m. A.M., Standard Time,
 107W56. 40N02.

L.M.T.: 2h. 48m. 16s. A.M.
 S.T.: 16h. 9m. 28s.
 E.G.M.T.: 10h. 00m. 00s. A.M.
 E.G.M.T.: Interval, - 2h. 00m. 00s

MOV.	FIR.	MUT.	FIRE	EARTH	AIR	WATER	ANG.	SUC.	CAD.
3	4 Asc	3 MC	4 MC	1	1 Asc	4	4	3	3
PER.	COMP.	PUB.	LIFE	WEALTH	ASSOC.	PRY.	ABOVE	EAST	RET.
5	4	1	4	3	1	2	3	5	3

CHART NO. 2		ASPECTS											
	○	▷	⋈	♀	♁	♃	♅	♁	♃	♅	♁	MC	ASC
○		□	-	•	♁	•	♁	∟	•	•	♁	*	
▷			*	*	□	♁	•	♁	•	*	*		
⋈				♁	•	♁	•	♁	•	Δ	•		
♀					•	Δ	•	Δ	□	Δ	∟		
♁						□	*	Δ	♁	Δ	♁	•	
♃							♁	•	♁	♁	♁	•	
♅								♁	•	♁	♁	•	
♁									♁	•	♁	•	
♃										♁	•	♁	•
♅											♁	•	♁
♁												♁	•
MC													•
Asc													

TABLE OF APPROXIMATE DAILY MOTIONS			
♁	59' 8"	♃	4' 59"
♁	13° 10'	♅	2'
♁	1° 23'	♁	42"
♁	1° 12'	♃	22"
♁	33' 28"	♅	15"

Chapter 3

First Seven Steps In Judging Any Horoscope

OBSERVATION indicates that many astrological practitioners follow no definite system in delineating a horoscope. Like beginners usually do, they have a tendency to wander aimlessly from one indication in the chart to the next that happens to strike their fancy. A study of such delineations, and the opportunity to witness the result of such lack of method among students who visit our classes, has convinced us that any astrologer will find it a distinct gain in precision, and in the amount of detail he can extract from a chart, if he will adopt some regular order of sequence in which to consider the various factors that enter into a delineation.

The system here presented is the result of many years of teaching astrological delineating in classes. The beginner will find that following some such system will greatly shorten his period of apprenticeship and hasten the day when he becomes a master craftsman. There, no doubt, may be other good systems that may be followed. The one here presented is equally applicable to any chart—Horary, Mundane, Natal, Diagnosis, or Weather Predicting. It is presented as the system we have found in our class work to give the best results when used either by beginners or by astrologers of long years standing.

Planetary Distribution and Aspects

—Before taking up these first seven steps in judging any horoscope it should be explained how a table of planetary distribution is made, how all the aspects in a chart may be ascertained, the significance of planets being in certain sections of the chart, and the significance of their being fast, slow, stationary, or retrograde in motion; as each of these things has a very definite meaning.

When the student becomes proficient the planetary distribution will be noted at a glance and tabulated mentally. But the beginner would do well to make a table of distribution (See Sample Student Chart Blank), in which is shown how many planets are in each zodiacal quality, how many are in each zodiacal triplicity, how many are in angular, succedent and cadent houses, and how many are above the horizon. In this tabulation the Ascendant and the Midheaven should be considered as if they were planets.

He should also make a table of all the aspects in the chart, such as that given above Table VIII. When he becomes more proficient in noting aspects, he will be able to discern at a glance all the aspects of any particular planets. In our advanced classes, we do not consult a table of aspects, unless we are calculating the astrodynes, discordynes or harmodynnes of a chart, as the student is expected to see at once all the aspects a planet makes.

Calculating the Aspects

—In making such a table, as in judging the figure, better results follow the use of a definite system. Therefore, in calculating the aspects in example chart No. 2 (frontispiece), let us commence with the Sun. As it is in Aries 22°, we look for conjunctions, squares and oppositions by referring to the Movable Cross. Venus is in a movable sign, but not within the 13° orb given the Sun's conjunction in succedent houses. Mars is not in a movable sign, but Scorpio 4°, which is but 12° from Libra 72°, the place of the Sun's opposition. It is thus within orb, and exerts slightly the influence of the Opposition.

The Moon is in Aquarius 1°, which is within 9° of Capricorn 22°, the place of the Sun's square. It thus slightly exerts the influence of the Square.

Next we look for trines by noting planets in the same Triplicity. Our table of distribution shows there are 5 planets in fiery signs. Venus in a fiery sign, as ready noted, makes no aspect to the Sun. Jupiter and Neptune lack 14° of being the same degree as the Sun, and as the Sun's orb for the trine from succedent houses is but 10°, they are not within orb.

Overlapping Aspects

—Trine aspects sometimes grade into sesqui-square aspects quickly, and where the aspect is from the Sun in an angle the orb of the trine overlaps the usual orb given for the sesquisquare. In all such instances the more powerful aspect operates to the full extent of its orb, and therefore should be given preference by narrowing the orb of the weaker.

To find the sextiles we look two signs removed either way. There is nothing in Gemini, but the Asc. is 15° Aquarius, hardly making the sextile to the Sun or the orb is 7° and this relation is a few minutes less than 7°. The semi-sextiles we look for in adjacent signs. There is nothing in Taurus, and Mercury in Pisces is just beyond the 3° limit of the Sun's orb for this aspect in succedent houses.

For the inconjunct we look 5 signs distant. Saturn is in Virgo, but the orb is too great.

Next to find the semi-squares and sesqui-squares we add 15° to the place of the Sun, giving us 7°. Looking about the chart we discover that Uranus, Jupiter, Neptune and Saturn are all near this degree. Uranus is a sign and a half, and has the influence of the Semi-Square.

Neptune and Jupiter are three signs and a half and thus in no important aspect to the Sun. But Saturn is four signs and a half, and consequently exerts the influence of the Sesqui-Square, as does also the M. C.

The Sun's declination is $8^{\circ} 38'$, and as no other planet has approximately this declination the Sun has no Parallel.

Now taking up the aspects to the Moon, as its aspect to the Sun has already been recorded, we proceed to the other planets. The orb for oppositions in cadent houses is 11° . Neptune and Jupiter are in the opposite arm of the fixed cross, and exert the influence of the Opposition.

Mars is in another arm of the fixed cross and exerts the influence of the Square.

Trines there are none, but Venus in Aries and the M. C. in Sagittarius are near the same degree two signs removed. They therefore exert influence of the Sextile. Mercury also, in Pisces 25° , is within orb of the Sextile.

Uranus is near the same degree in the adjacent sign, and exerts the influence of the Semi-Sextile.

Saturn in an angle has an orb of 3° for the inconjunct, and thus forms no aspect to the Moon. Neither are there semi-squares, sesqui-squares nor parallels.

As possible aspects of Mercury to Sun and Moon have already been considered, we next consider its relations to the other planets. It is well within the orb of the Conjunction with Venus. It makes no oppositions, but is Trine M. C. Nor does it make any squares or inconjuncts. It is, however, Sesqui-square both Jupiter and Neptune.

Venus makes no oppositions. Its possible aspects to Sun, Moon and Mercury have already been considered. It is also Trine Jupiter, Neptune and M. C., Square Pluto, and Semi-Square Asc.

In like manner we proceed in their proper order of sequence to find the aspects of the other planets, the Asc. and M. C., and tabulate them as shown on Sample Student Chart Blank Aspect Grid.

Planets Fast and Slow

—Planets, including the Asc., sometimes move faster than their average motion and are then called Fast. They also sometimes move slower than their average motion and are then called Slow. In a table of houses the M. C. is usually tabulated for every degree. A glance at a table of houses when erecting a chart will indicate if the Asc. is moving faster than the M. C., for if the interval between the two consecutive Ascendants is greater than one degree it is Fast in motion, but if the interval between two consecutive Ascendants for the latitude given is less than one degree the Ascendant is Slow in motion.

Table VIII gives the approximate average daily motion for all the planets, and as the daily motion of each is always computed in erecting a chart, it takes but a moment to determine if a planet is fast or slow, and to what extent.

A planet Fast in Motion brings the capabilities, opportunities, qualities and events signified by the planet into manifestation at a comparatively early date. On the other hand, a planet Slow in Motion retards the development of the qualities and possibilities shown by it, and delays the events it indicates.

The Ascendant rules the personality, and the Mid Heaven rules that part of the environment conducing to honor, responsibility to society, and business advancement. We find, consequently, that when the Ascendant is slower than the M. C. that the personality fails to develop fast enough to take advantage of all the possibilities for progress that are presented. The environment makes demands faster than the personal qualities unfold that enable these responsibilities to be handled in the most effective manner. But when the Ascendant is faster than the M. C., we find that the personality develops rapidly enough to more than keep abreast of opportunities. The full force of the personality expresses itself Early in life if the Asc. is Fast, but Late in life if the Asc. is Slow.

Retrograde Planets

—Due to the relative motion of the earth there are times when certain planets apparently move backward through the zodiac. When so moving a planet is called Retrograde. It is then marked in the ephemeris where it appears with an R at the head of its column.

The qualities, abilities and events signified by a retrograde planet are all present as if the planet were direct in motion, except that they are repressed or hindered, and thus have the utmost difficulty in expressing themselves. In natal astrology a retrograde planet indicates that there is a repression of the nature of the planet and the department of life that it rules through which the feelings and desire for action are dammed up within. In the sense that there is an impediment to adequate expression a retrograde planet is an affliction.

But in a natal chart it is an affliction that can be relieved. The affliction is not due to such discords as are indicated by aspects. It is due to the attitude of the unconscious mind toward certain conditions that arise in the life. Certain thoughts and emotions that should normally find expression, through being linked up with early painful emotions, or with various taboos, are kept in the background along with the emotions and taboos with which they accidentally have been associated. Thus the whole personality is often sadly warped. But it need not remain so, for with the release of the repressions it quickly becomes normal. These matters are fully explained in Courses 5 and 9. A retrograde planet signifies a **Repression**.

Stationary Planets

—When a planet direct in motion turns retrograde, or a planet retrograde turns direct in motion, there may be an interval of several days in which the planet appears to have no zodiacal motion. It is then called a Stationary planet. The change from retrograde to direct motion is marked in the ephemeris by the letter D in the column occupied by the planet. If a planet is stationary this will be seen when calculating its place, and should be noted in the chart by placing the abbreviation Sta. after the planet.

Such a stationary planet indicates that the things it signifies have great permanence, stability and endurance. They may be altered only by extraordinary effort, or by unusual conditions. Qualities and abilities so indicated are unyielding and persistent. Whether for good or evil, that which is ruled by a stationary planet is **Enduring**.

Elevated Planets

—The term elevation is used to signify how high or low in the chart a planet is situated. The highest point in the chart is the M. C. The lowest point is the Nadir. A planet above the earth—in the six upper houses of the chart—expresses itself in such a manner that it is noticed by others, and gets ample credit or discredit, as the case may be. Planets below the earth give just as much ability but do not express their qualities in a manner that draws public attention to them.

The higher, or more elevated, a planet is in the chart the easier it is to give full publicity to the affairs signified by it. Likewise, the lower, or less elevated, a planet is in the chart the greater the difficulty in drawing public notice to the things so signified.

People born with many planets above the earth are always given ample credit for whatever abilities are signified by these planets. People born with many planets below the earth are seldom given credit for the abilities they possess because the qualities denoted by the hidden planets—those below the horizon—do not manifest in a manner to be recognized by people in general. Thus the most elevated planets in the chart are always important in that they signify the qualities that receive full public recognition. Elevation means **Publicity**.

Planets East

—Life itself constitutes the interaction between an organism and its environment. Through this interaction either organism or the environment, or still more commonly both, are modified. But some organisms instead of being merely molded by environment, exert a power that modifies markedly the environment. Some men, for instance, shape their surroundings to their own needs, while others, perhaps equally

successful are formed and shaped and directed almost entirely by the various conditions by which they find themselves surrounded.

Those who have many planets on the east side of the chart impress environment with their personalities and powers. That is, the virility of a planet to impress the qualities it rules upon environment is pronounced when the planet is on the east side of the chart. Therefore, a planet in house X, XI, XII, I, II, or III tends to **Mold Circumstances**.

Planets West

—On the other hand those who have many planets on the west side of the chart are more influenced in life's course by the action of people and by their surroundings. The virility of a planet to impress the qualities it rules upon environment is not pronounced when the planet is on the west side of the chart. Therefore, a planet in house IV, V, VI, VII, VIII, or IX tends to be **Molded by Circumstances**.

The planets are not responsible for the events and conditions attracted

—It should be clearly recognized that causes of events and conditions result from the hereditary equipment as mapped by the birth-chart plus the conditioning energy received from reactions to environmental conditions since birth.

The planets are not responsible for the events and conditions attracted. It is easier for a child to be born when the streams of astral energy from the planets are such, as indicated by their positions in the sky, that they flow through—rather than crosswise of—the stellar-cells and stellar structures of the child's astral body. The child is born when the astral currents of his environment, as shown by the birth chart, correspond as closely as practicable, to the thought compounds and thought structures of his astral body.

Each of the ten planets in the birth chart maps the chief structure in the astral body of one family of thought-elements. The aspects between the planets reveal which thought-elements have entered into combination, one with the other, in the formation of compounds, and how these compounds have been formed. The prominence of a planet in the birth chart shows the amount of desire energy possessed by the thought-cells and thought structures it maps. And the amount of desire energy thus shown indicates how much work, both three-dimensional and four-dimensional, the thought group is capable of, and consequently how important will be the events which it brings into the life.

The events themselves, to the extent they are noticeably either more fortunate or less fortunate than the normal trend of the life, are attracted only at such times as the thought-cells relating to the department of life affected receive new energy. This new energy gives the stellar-cells thus involved additional power to work from the

four-dimensional plane, to stimulate objective thoughts of a similar nature, and to influence the physical conduct.

The more common sources of such additional energy supplies are mapped by the progressed aspects of the planets. Planetary energy picked up, radio fashion, by the aerial developed across the astral body when a progressed aspect is formed, is made available for the use of the thought-cells and stellar structures at the terminals of the aerial. But the event is not attracted by the new supply of planetary energy thus made available; it is attracted by the thought activities then stimulated. The stellar-cells work with such intelligence as they possess, and with the energy supply thus made available, to bring vents of a certain nature into the life.

A detailed explanation of thought-cells and their activity will be found in Courses 5 and 9.

The First Step in Judging Any Horoscope is to note the **Power** of the figure by consulting the *planetary distribution among the houses*. If many of the planets are in angles it is a powerful figure and noteworthy things may be expected of it. If many of the planets are in cadent houses and none are in angles it is a feeble chart and will exert no great influence in any direction. If many planets are in succedent houses it is of average power, as is the case if the planets are rather evenly distributed among angular, cadent and succedent houses.

Any planet found in an angle will exert a power sufficient to make it a very important factor in the delineation. Thus in the chart on the frontispiece there are four planets in angles, making of it a very powerful chart. Three planets are in succedent houses and three are in cadent houses. In any chart the first thing should be to determine the amount of energy present. Nothing is accomplished without energy. In this chart four out of the ten streams of energy come through those houses where they exert maximum volume. Power depends upon Volume.

The Second Step in Judging Any Horoscope should be to note the **Quality of influence** manifested by the signs the planets are in by consulting the planetary distribution among *movable, fixed and mutable* signs. Many planets in movable signs indicate great activity and a pioneer spirit. Many planets in mutable signs indicate power of adaptation to whatever environment is present. Many planets in fixed signs indicate determination, rigidity and attention to detail.

In noting the distribution of the planets among the Qualities the Ascendant and M.C. should be considered as if they were planets. Thus in the chart on the frontispiece the fixed quality preponderates. Five of the twelve influences are in fixed signs, four are in mutable signs and three are in movable signs. Therefore, this chart indicates a rigid determination not to be swerved from any plan that has once been formed. Quality determines Adaptability.

The Third Step in Judging Any Horoscope should be to note the **Triplicity of influence** manifested by the signs the planets are in. This is done by consulting the planetary distribution among *Fire, Air, Water and Earth* signs. Many planets in

fiery signs indicate much zeal and enthusiasm. Many planets in airy signs indicate intellectuality and vacillation. Many planets in watery signs indicate sympathy, emotion and receptivity. Many planets in earthy signs indicate practicality.

In determining the distribution of the planets among the elements the Asc. and M.C. should be considered as if they were planets. Thus in the chart on the frontispiece, there are five planets in fiery signs, indicating initiative, enthusiasm and aggressive energy. Two planets in air and four planets in water show there is both thought and feeling. There being but a single planet in an earthy sign reveals that practical and material methods receive subordinate consideration. Triplicity reveals Temperament.

The Fourth Step in Judging Any Horoscope should be to note the **departments of life** accentuated by the planets. This is accomplished by observing the Society, the Trinity, and the more restricted field of Expression of each mansion, denoted by the houses in which the planets are found.

The stream of energy radiated by a planet largely reaches the earth through the particular house it occupies. Very much less of its energy reaches the earth through the sympathetic vibration of the sign it rules but does not occupy, and thus through any house it actually is not in.

To state the matter more clearly, the amount of energy converted into any particular department of life is determined by the number and power of the planets occupying the house of the horoscope ruling that department of life. Houses of the horoscope not occupied by planets are therefore much less important. They but transmit the lesser energy derived from the sympathetic relation of the sign on a house-cusp to a planet. Because of the total of life's energies so large a portion flows through a house occupied by numerous planets, such a house represents a department of life of unusual significance. In fact the more numerous the planets in a house, the more significant does that department of life become. Numerous planets in a house make their department of life Important.

In lesson No. 47 (See Serial Lesson Key) the four Trinities, the three Societies, and the Department of Life governed by each house are explained in detail. If many planets are found in Personal houses it signifies that much of life's total energy is diverted to personal concerns. If many planets are found in Companionship houses it denotes that much of life's total energy is absorbed in contact with others. If many planets are found in Public houses it indicates that much of life's total energy is expended in activities that come before the notice of the public. Thus in the chart on the frontispiece there are five planets in personal houses, indicating that a major part of the energies of life is directed to personal affairs.

If many of the planets are in the trinity of Life, the chief interest is in living. If many of the planets are in the trinity of Wealth, the chief interest is of a business nature. If many of the planets are in the Trinity of Association, the chief interest is the relation to others. If many planets are in the trinity of Psychic Influence, the chief interest is in secret things. Thus in the chart on the frontispiece there are three planets in the trinity

of wealth and four planets in the trinity of life, indicating that life and wealth are predominating factors in the previously determined personal interests.

The Fifth Step in Judging Any Horoscope should be to note the nature of the planetary energy transmitted through each house without regard to aspects. For fine craftsmanship, because each planet exerts a different tone quality in each sign, the sign occupied by the planet must be also included in this consideration. It is of course possible to describe the influence of each of the ten planets in each of the twelve signs. Books may be had that go into such detail. They have their value, but it is more satisfying and practical to estimate such details of influence from a knowledge of the nature of the sign and a knowledge of the nature of the planet together with a knowledge of the Essential Dignities of the planet. Signs are treated in lesson No. 46 (See Serial Lesson Key). Planets are discussed in Lesson No. 47 (See Serial Lesson Key). And Essential Dignities are given consideration in lesson No. 87 (See Serial Lesson Key).

House-Cusp Orbs

—It seems certain that a planet commonly exerts its most powerful energy through the house it actually is in. If it is a progressed planet it exerts its most powerful energy through the house into which it has progressed.

This energy is most powerful near the cusp of the house it is in, gradually decreasing its influence on the department of life ruled by the house as the planet moves further into the house, being weakest just before it crosses over the next cusp in proper sequence.

Where the cusps of the M. C. and Asc. are concerned—the one acting as a broadcasting antenna and the other as a ground-wire—these function after the manner of planets. Consequently a planet well over into the ninth house exerts an influence on the M. C. if it is within orb of a conjunction aspect with it, and a planet well above the Asc. in the 12th house will have an influence on the Asc. if it is within orb of a conjunction aspect with the Asc. The orb of the M. C. and the Asc. is the same allowed a planet in an angle.

Probably due to lack of precision in timing births and thus locating improper degrees on the various house-cusps, with the observed affect of planets as many as 10° from the M. C. into the ninth house and as many as 15° from the Asc. in the twelfth house, an opinion has gained some ground that when a planet is within 5° of a house-cusp it not only exerts an influence over the things ruled by the house it is in, but begins to have some influence over the things ruled by the other house.

Yet as the result of many thousands of charts in which not only the birth-chart influence, but also the influence of the progressed positions of the planets have been studied by The Brotherhood of Light Astrological Research Department, including a vast number in which the effect of a progressed planet moving through one house and

over the house-cusp into another house has been observed, we have been forced to the conviction that one house is divided from another by an abrupt partition.

Chief Ruler of a House

—Where there is but one planet in a house, it is usually the chief ruler of that house. The planet ruling the sign on the cusp of the house, because the sign sympathetically transmits some of the energy of the planet ruling it no matter where this planet is located, is a secondary ruler of the house, or co-ruler. Where there are several planets in a house, because the wave of influence increases in power over the things ruled by the house as the cusp is approached, the planet nearest the cusp of that house is commonly considered the chief ruler, and the other planets in the house as secondary ruler, or co-rulers. Of these co-rulers, those closer to the house-cusp have a stronger influence over the things of the house than those farther from the house-cusp. Yet any of these planets in a house have a stronger influence over the things ruled by the house than does the planet that is co-ruler merely because it is ruler of the sign on the cusp of the house.

For precision, the amount of power a planet has over a house depends upon the number of astrodynes which could effect the house. When a planet is not in a house, but rules the cusp sign, it has to have twice as many astrodynes as a planet which actually occupies the house to have the same influence. If the cusp ruler has more than twice as many astrodynes as the planet in the house, it is then considered the chief ruler of the house.

Sun

—Whatever house is occupied by the Sun is strongly vitalized, and becomes an important house as influencing motives. The Sun represents the individuality and the center of vital force. Therefore, the house it occupies indicates the department of life in which, to a great extent, the individuality is submerged. From this standpoint it becomes a dominant motive in the chart. Thus in the chart on the frontispiece as the Sun is in the 2nd it is indicated that money considerations are an important motive. The department of life ruled by the house occupied by the Sun is conducted with **Vigor**.

Moon

—Whatever house is occupied by the Moon is thereby made receptive and changeable. The things so denoted are in process of gestation, and are subject to constant small variations. Thus in the chart on the frontispiece the Moon is in the 12th. This indicates many little disappointments and a never ending variety of psychic impressions. The department of life ruled by the house occupied by the Moon is subject to **Fluctuation**.

Mercury

—Whatever house is occupied by Mercury becomes the subject of mental effort. The mind expresses itself readily where the things so denoted are concerned. Thus in the chart on the frontispiece Mercury is in the 1st, indicating much thought about personal matters, and facility in expressing personal opinions. The department of life ruled by the house occupied by Mercury is subject to **Thought**.

Venus

—Whatever house is occupied by Venus has a strong influence upon the affections, and through it an appeal to the affections can readily be made. The things denoted by this house tend to prosper not through effort and initiative, but through kindnesses received because of grace of manners and received through following the line of least resistance. Thus in the chart on the frontispiece Venus is in the 1st. This gives a spontaneous and charming personality. The department of life ruled by the house occupied by Venus is subject to **Gratuities**.

Mars

—Whatever house is occupied by Mars indicates a section of the life in which forcefulness and energy are expressed. Whatever it indicates in the way of advantage is gained through initiative and combat; and if loss is indicated, there is much struggle associated with it. There is always strenuous activity in connection with the things ruled by the house occupied by Mars. Thus in the chart on the frontispiece, as Mars occupies the 8th, there is signified a struggle over the partner's money. The department of life ruled by the house occupied by Mars is subject to **Strife**.

Jupiter

—Whatever house is occupied by Jupiter indicates a section of the life in which there is plenty. Jupiter withholds not the things denoted by the house he occupies. When severely afflicted by aspects much difficulty may arise over the things denoted by this house, but in some manner a way will be found to pull through with head above water, even though in extreme cases failure may be escaped only by a hair's breadth. Thus in the chart on the frontispiece Jupiter is in the 6th, indicating both the ability to recover from illness and to profit from work and employees. The department of life ruled by the house occupied by Jupiter is subject to **Abundance**.

Saturn

—Whatever house is occupied by Saturn indicates a section of the life in which there is dearth and laborious effort. The advantages that Saturn brings, even when he is

well aspected, are well earned. Saturn withholds the things signified by the house he is in or makes them difficult to obtain. They are obtained at a sacrifice of something else worth while. Thus in the chart on the frontispiece Saturn in the 7th indicates dearth where partners are concerned. This means that whatever advantages are gained from partners are more than paid for in added work and responsibility. The department of life ruled by the house occupied by Saturn is subject to **Poverty**.

Uranus

—Whatever house is occupied by Uranus denotes things about which radical tendencies are likely to manifest. In the section of life indicated by such a house there are sudden changes and developments of an extreme nature, either constructive or destructive. Yet whatever good is signified in one direction is accompanied by some lesser disadvantage in another field, and whatever evil is signified in one direction is accompanied by at least a small measure of good in some other relation of life. As Uranus is in the 1st of the chart on the frontispiece some eccentric turn to the personality is indicated. The department of life ruled by the house occupied by Uranus is subject to **Eccentricity**.

Neptune

—Whatever house is occupied by Neptune is influenced by subtle and visionary factors. There is something elusive and mystical about the section of life denoted by this house. About the things so denoted the imagination weaves pictures, and these mental pictures influence the attitude toward reality. Thus in the chart on the frontispiece Neptune is in the 6th, indicating a tendency to picture an illness that in actuality does not exist. The department of life ruled by the house occupied by Neptune is subject to **Illusion**.

Pluto

—Whatever house is occupied by Pluto is subject to inner-plane influence, either for good or ill. In its activities will be found facilities for co-operation with others and for contacting groups of people. To the extent Pluto is afflicted will undue pressure be brought to bear by others to compel such action as they desire relative to the things the house rules. Thus as in the chart on the frontispiece Pluto is in the 5th, compulsion will play its part where speculation, children, love affairs and pleasures are concerned. The department of life ruled by the house occupied by Pluto is subject to **Coercion**.

The Sixth Step in Judging Any Horoscope should be to note the house actually occupied by the planet ruling the sign on the cusp of each of the twelve houses.

Not only is there an intimate connection between the house upon the cusp of which a given sign is found and the house occupied by the planet ruling that sign, but the

things of the house occupied by the planet have a certain power over the things merely ruled by the planet's sign. In a human controversy that results in violence, if the violence takes place in the home of one of the individuals, this individual has a certain legal advantage. Thus also a planet away from its home sign places the things it rules by sign under the influence of the things represented by the house it actually is in. In relation to the things represented by the sign on a house cusp ruled by a planet, the things ruled by the house a planet actually occupies exercise an influence of Authority.

Intercepted Signs

—Sometimes it is found that there is an intercepted sign in a house. It should always be considered as co-ruler of the house together with the sign on the cusp of the house. The qualities expressed by the sign on the cusp of the house, however, manifest more freely than those denoted by the intercepted sign. The qualities of the intercepted sign are present, but they require stress of circumstances to bring them into expression. Therefore, in judging a house, both the planets in an intercepted sign and the planet ruling this sign should be considered, as well as the sign on the cusp and its planets and ruler. Intercepted signs represent qualities that are Latent.

Now as the first house denotes the personality, the house in which the planet ruling the sign on the Ascendant is found indicates a department of life having much interest for, and influence over, the person.

Thus if the ruler of the 1st is in the 2nd, it indicates that he has an interest in money, and that money is an important influence over his life. If the ruler of the 1st is in the 3rd, it indicates that he is interested in his brethren and in education, or reading, and that these things influence his life. If the ruler of the 1st is in the 7th, he will find himself in partnership, and influenced in his actions by such partners.

If however, the ruler of the 2nd is in the 1st, it indicates that money matters are largely dependent upon his own personal efforts. If the ruler of the 2nd is in the 2nd there is natural aptitude in money matters. If the ruler of the 2nd is in the 3rd the finances are greatly influenced by kindred, short journeys, and education.

Books may be had in which the influence of the ruler of each of the twelve houses, when in each of the twelve houses of the chart, are given in detail. Such books have a value. But in practical work it is enough to remember:

When a planet is in the house it rules by sign it gives much independence to the thing ruled by that house. When a planet is in the 1st house, the things signified by the house which the planet rules by sign are largely subservient to personal inclination. When a planet is in the 2nd house they are somewhat controlled by money matters. When a planet is in the 3rd house they are somewhat subservient to kindred and education. When a planet is in the 4th house they are influenced by the home environment. When a planet is in the 5th house they are subject to children, pleasures and speculation. When a planet is in the 6th house they are under the influence of

work, employees and illness. When a planet is in the 7th house they are somewhat controlled by partners and the public. When a planet is in the 8th house they are subservient to legacies and the partner's money. When a planet is in the 9th house they are influenced largely by philosophy and publicly expressed opinion. When a planet is in the 10th house they are directed by business relations and considerations affecting the reputation. When a planet is in the 11th house they are subservient to friends. When a planet is in the 12th house they are influenced by secret sorrows and psychic influences.

The Seventh Step in Judging Any Horoscope is to note the prominence of each planet and the number and nature of the aspects received by it. Each aspect indicates streams of energy—meeting at an angle that produces a definite whirl, constructive or destructive. It indicates a definite association between the departments of life ruled by the planets forming the aspect.

If a planet has few aspects, it may exert a very strong influence along one particular channel, but its range of influence is limited. If a planet has many aspects it indicates a large variety of influences centering about the departments of life ruled by that planet. The more aspects a planet has, the greater the number of influences brought to bear from other departments of life upon the department of life ruled by the planet. The Strength of each department to Influence the things denoted by the planet receiving the aspect depends upon the Strength of the aspect and the planet forming it. But the Nature of the influence depends upon the Nature of the aspect and the planet making it.

Thus if the Sun receives many aspects it signifies that many things in life have an influence over the vitality and upon the things ruled by the house the Sun is in. If the Moon receives many aspects it indicates mental capacity along many lines, and many conditions affecting the constitution, as well as numerous conditions affecting the houses ruled by the Moon. If Mercury receives many aspects it indicates a wide range of mental activity, and the ability to express thought along many lines, as well as many influences brought to bear upon the things signified by the houses ruled by Mercury. Many aspects to Venus indicate many things influencing the affections; many aspects to Mars, many things stimulating the energies; many aspects to Jupiter, many things influencing expansion and growth; many aspects to Saturn, many things influencing contraction and responsibilities; many aspects to Uranus, many things tending to radical changes of view; many aspects to Neptune, many things affecting the ideals and the imagination; many aspects to Pluto, many things influencing toward or away from spirituality and many things influencing group activities and co-operation. And in each of these instances the things signified in the chart by the houses the planet rules are affected.

The Prominence of Each Planet

—A planet is prominent in proportion to the volume of its particular type of energy which the individual or condition mapped by the chart is able to express. By its

prominence in a natal chart a planet indicates the amount of activity the thought-cells of the unconscious mind having an energy characteristic of the planet can express. This shows not only the power of the dynamic thought structure mapped by the planet to attract conditions of this type into the life, but also the power of the common thought-cells mapped by the houses whose cusps are ruled by the planet to attract corresponding conditions into the life. This is important in vocational selection, for instance, as many vocations require association with the department of life ruled by one or more houses. Thus a doctor or nurse must have an active sixth house, and a bookkeeper or stenographer must have an active third house.

The natural aptitude for a vocation, other than this house activity, depends on the volume of energy the unconscious mind can command of the types signified by specific planets. An individual can use only so much Mars or Saturn or other types of energy as he possesses, and the prominence of the planets indicates how much energy of each planetary type he can command. If he is to build or destroy he must use the type of energy mapped by Mars; if he is to organize or systematize he must use the type of energy mapped by Saturn; if he is to express geniality and good will and engender similar attitudes in others, he must use the type of energy mapped by Jupiter. Also, to the extent a planet is prominent will events, including associations and diseases, characteristic of that planet be attracted into the life by the activity of the thought-cells of the unconscious mind thus mapped.

Every aspect a planet receives indicates additional energy which the thought-cells mapped by it are able to express. Other things being equal, however, a planet in an angle indicates more energy than one not in an angle, and the nearer the cusp of the angle it is the more energy is indicated. Furthermore, as the thought-cells mapped by the Sun, Moon and Mercury directly contact the electromagnetic energies of the body, a planet in aspect to them maps thought-cells able to express much energy.

While other aspects to it may be numerous enough and powerful enough to make a planet prominent, as a general rule followed in statistically determining the Birth-chart Constants of vocations, diseases, and the predisposition to definite events, only planets in an angle or aspecting with a reasonable degree of closeness, the Sun, Moon or Mercury are considered Prominent. However, for precision, the only sure method of determining the Prominence of a planet in relation to a particular chart is to calculate its astrodynes.

The Best House and Best Planet

—Because in natal astrology the Best House in the chart indicates the department of life from which a given expenditure of effort brings the greatest advantages, and because in other branches of astrology it indicates the department from which most favors may be expected, it should always be ascertained. And as the Best Planet indicates the environmental associations that are most fortunate, it also should be noted. It is particularly significant in vocational selection, and in the selection of surroundings favorable to health. The nature of the planets, the signs they occupy, the

volume of their energy, and the aspects they make all enter into this consideration. Commonly, Venus and Jupiter in a house are taken for the best influence. Venus adds $\frac{1}{4}$ harmony and Jupiter adds $\frac{1}{2}$ harmony. But in the last analysis, a precise point can be ascertained by calculating the harmodynes and discordynes. The House and the Planet carrying the most harmodynes will be considered the most fortunate in the chart.

The Worst House and Worst Planet

—Because in natal astrology the Worst House indicates the department of life that causes the most difficulty, and in other branches of astrology it indicates trouble, it also should be ascertained. And as the Worst Planet indicates the environmental associations that are most unfortunate, it is important to note it, so that these things may be avoided. Here, also, the nature of the planets, the signs they occupy, the volume of their energy, and the aspects they make must all be considered. Ordinarily, both Mars and Saturn are taken as the worst influences because Mars adds $\frac{1}{4}$ discord and Saturn adds $\frac{1}{2}$ discord. But in the last analysis, the Worst House and the Worst Planet are those that carry the most discordynes. How to calculate the astrodynes, discordynes and harmodynes of an aspect, planet, house or sign is explained in Course XVI.

Chapter 4

Serial No. 89
Original Copyright 1931
Elbert Benjamine

Copyright
August 2002
Church of Light

The Doctrine of Horary Astrology

Chapter 4

The Doctrine Of Horary Astrology

ALTHOUGH horary astrology conforms to scientific principles in all its parts, it is less rigid than natal astrology; for natal astrology is not only an exact science, but its methods are less dependent upon the personal equation. When a child is born, the time of birth can be ascertained with positiveness and exactitude by any person present; but when an idea is born, the personal equation of the one to whom the idea comes may, under certain circumstances, make it very difficult to determine the exact moment of its birth.

The proper timing of the birth of an idea, the birth of a proposition, or the birth of a question depends upon the sympathetic relation of the human mind with the astral world. That this relation is quite dependable is evidenced by the accuracy of the results obtained through the use of horary astrology. Nevertheless, because horary astrology depends upon a mental reaction to a condition existing in the unseen world, it is essentially not so much an exact science as a method of divination. Yet what it lacks in positiveness of method it more than compensates for in wealth of detail.

Just what I mean by the greater positiveness of natal astrology may be illustrated thus: Any person born when Mars is rising on the eastern horizon, no matter where he is born or of what people, is warlike and combative in comparison to others of his race. Likewise, in a horary chart, if Mars is found on the eastern horizon, the person asking the question is warlike, or was in a combative mood at the time the question was asked; PROVIDING the Proper time for erecting the figure has been selected. But to determine the time when the question was brought completely into the mind places dependence upon a mental experience. And a mental experience is less positive, as subject to impartial verification by others, than the physical birth of a child Therefore, horary astrology is not as exact a science as natal astrology.

Follow the Rules

—Recognizing this, many beginners in the science make a grave mistake which detracts from their ability to give correct decisions. They feel that because the data upon which it rests is more subject to the personal equation, that they may ignore rules to a greater extent and rely upon intuition. As a consequence, they flit from one

section of the chart to another, with little regard to orderly sequence, and do not hesitate to violate such rules as conflict with their impressions.

But I have yet to know a practitioner of horary astrology upon whose judgment reliance can be placed consistently, day after day, who departs from the rigid rules in favor of his impressions. Those who do not firmly adhere to the rules may give wonderful readings at such times as their own chart and the world chart favor it; but they fail miserably and importantly at those times when their own chart and the world chart are afflicted. Yet the astrologer who learns the rules and never, under any circumstances, departs from them, can give an accurate and reliable reading even when his own chart and the chart of the world are all upset. Under these adverse circumstances, when he goes beyond the rules and relies upon psychic impression for more details, he may be in error. But, because by following the rules he has eliminated much of his personal equation, in all important respects his readings are consistently reliable.

My advice to any student, as derived from the many years horary astrology has been taught in The Church of Light class-rooms, is to cultivate the ability to get as great a wealth of detail as possible beyond the strict letter of the rules given; but always to apply the rules in a careful, thorough, and systematic manner: and never, under any circumstances, render a judgment contrary to the rigid rules of the science.

Nor should the horoscope be considered merely as a mystical design. On the contrary, whatever the status of the data upon which it is erected may be the chart itself is a positive and exact map of actual forces. It shows, with all the precision of exact science, the direction from which streams of energy, of designated quality and volume, flow to the world. These streams of energy, which can not be seen by the human eye, are quite as real and far more important than the electromagnetic waves, which likewise invisible, flow from the sun simultaneously with the appearance of sun-spots, and often cause serious electrical storms on the earth.

The Astral Environment

—Now if we increase the temperature of a room sufficiently, those in it will begin to think about opening the doors and windows, or about discarding some of their clothing. If a man partakes copiously of alcohol, he becomes abnormal both in thought and action. If a man is thrown into deep water, he thinks of swimming. Place him on a horse, and he thinks of riding. And any number of other incidents can be cited to illustrate that man's thoughts and actions are greatly influenced by his environment.

Yet the physical is but a small part of his total environment. Quite as important, in influencing his thoughts and actions, are his astral surroundings; and particularly those streams of energy that flow from the planets and impinge upon his finer body. They cause changes in his astral form, and these are registered as sensations by the soul, which is commonly termed the unconscious mind.

Because the astral body has certain sensations, the unconscious mind has certain thoughts; just as when the physical body, as illustrated above, registers certain sensations, there are appropriate objective thoughts. Yet psychologists have conclusively proven that most of man's thinking is done below the threshold of objective consciousness, in the unconscious mind. They have demonstrated that a majority of man's actions and decisions, instead of being determined by pure objective reason, rise into his objective consciousness as thoughts, impulses and inclinations, from the region of his unconscious. And thus it is that man's thoughts, as well as his actions, are so largely modified by his astral environment, as it exists at any particular time.

These thoughts that enter, or reside within, the unconscious mind, are not mere nothings. They are real organizations of astral substance. They obey the well known Law of Association, which controls all mental processes. They combine to form a plan, a question an enterprise or an idea. through definite attractions. That is, to state it briefly; the power of any thought to influence other thoughts depends upon the amount of energy it possesses and the completeness with which lines of association have been formed between it and the other thoughts.

If we consider any given thought, then, and suppose that additional energy is supplied to it by a stream of force of like quality from some planet, it will be seen that its power, for the time being, is greatly increased. It, therefore, has greater ability to combine with other thoughts. And if several thoughts receive such additional energy from the planets at the same time, all will have additional combining power, and due to their temporary strength, they will be likely to move together as a plan, a question, or an idea.

With so much energy at its command this plan, question, or idea then probably will make itself prominent in the objective mind. But the important circumstance of this process, in so far as horary astrology is concerned, is that by determining the quality and nature of the streams of force that give such a plan, question, or idea power enough to become a cause of serious consideration, we thereby determine the quality and nature of the thoughts so energized. Furthermore, by considering the relationship of these energies we can also determine whether or not the plan, question, or idea is harmonious or discordant. In fact, the whole astral relationship is laid bare.

The First Factor

—To explain the basic principles upon which horary astrology rests requires a review of the properties of the astral world, a more detailed account of which may be found in lesson No. 40 (See Serial Lesson Key). Thus, while not all things in the astral world have physical counterparts, all thoughts, objects and conditions of the physical world have a duplicate in the astral. Furthermore, events and conditions that occur upon the astral plane tend to reproduce themselves, in so far as the physical environment with which they are associated is capable of such reproduction, UNLESS, before the physical environment has time fully to respond, other and

contradictory changes take place in the astral environment which annul the first influence.

As explained in lesson No. 118 (See Serial Lesson Key), the soul on the inner plane can look along the world-lines of things and perceive them as they existed in the past or as they will exist in the future. Also as velocity there is greater than that of light, there is freer interaction between thoughts and entities on this astral plane.

If a serious question, or a proposition, or an event, arises on the physical plane, we may be sure, therefore, that the same question, or proposition, or event as first arisen on the astral plane.

And this brings us to the first factor of basic importance in horary astrology. For if the proposition or question has arisen seriously in the unconscious mind, this has already, before the matter has reached the objective consciousness, directed the unconscious mind to all the factors and conditions related to it. And the unconscious mind, because it occupies the inner plane and uses the senses and superior conditions of that plane to apprehend the various conditions, mirrors these various factors in detail in their correct relations.

The desire of the unconscious mind to know about the matter has focused its attention on all the factors as they exist in the astral world, and they are present in the soul much as the image of a future picture is reflected in the “finder” of a camera. They have been brought to a focus all in their proper relation, but they only foreshadowed the future picture; for the picture may never be taken, the exposure never made, and the film never developed. Thus when we earnestly ask a question, we may know that already the unconscious mind has imaged the picture in its “finder.” Unless there are compelling circumstances, if our inspection shows the light to be bad, the background poor, too much movement, or for any cause the composition to be unpleasing, we may decide not to make the exposure; for we know the picture would be a poor one. If, however, the exposure is to be made in spite of conditions, the “finder” of the unconscious mind shows just what the developed picture will look like.

The Second Factor

—Now why did we ask this question just at this time? Well, if two or more thoughts receive, at the same time, strong stimulation from planets prominently situated, there may be enough energy present to amalgamate them into a plan. If the relation between the planets thus stimulating the thoughts is harmonious, as shown by their aspect, this would favor a harmonious alliance between the thoughts; and a plan that is harmonious in all its parts would result. But if the relation between the two planets thus stimulating the thoughts is discordant, through their being in bad aspect, a discordant condition would be present between the thoughts; for the energy received would be inharmonious and disintegrative.

When sets of thoughts thus amalgamate into a plan, or into a definite desire for specific knowledge, if there is sufficient energy present, they rise from the unconscious into the objective mind. In the objective mind they set up a mental disturbance; but except when there is accessory energy of a similar nature from the planets to give them the required force, the plan is not clear and there is no deep desire for a correct answer to a question.

We may be quite certain, therefore, that whenever a plan has been completely formulated, or there is a deep desire for a correct answer to some question about our affairs, that the state of mind so stimulated is due to additional energy, received by the mental factors thus brought to our attention, from their corresponding planets. The fact that these mental elements have the power to intrude themselves into objective consciousness so disturbingly, indicates that they have acquired, just at this time, an accessory energy supply.

Furthermore, and of even greater importance, the relation of the mental factors thus stimulated by planetary energy is the relation of the planets thus stimulating them into activity. Consequently, by a study of the relationship between the planets at the time a question or proposition becomes clearly defined in the mind we can learn the relation of the mental factors that are most active at the time. This then, is the second of the two factors upon which horary astrology rests.

As it is important that this principle be fully comprehended, let me state the matter somewhat differently: A question, for instance, may be present in the mind in a hazy sort of way for days and weeks; but when the planets in the sky reach stations where they hold the same relation to each other that these mental factors do, these mental factors receive enough additional energy, each from its corresponding planet, to give it clear and precise form in the objective mind. If, therefore, a chart of the heavens be erected for the exact moment a serious question takes complete form, it pictures the relation of the various mental factors within the unconscious mind of the person asking the question.

How the Factors Operate Together

—Here we have, then, the two factors that explain just how and why a horary chart, when correctly timed and interpreted, will solve a problem relating to events past, present and future.

The first factor is that an earnest desire to know something indicates that the unconscious mind of the person asking the question has been focused upon the problem, and has perceived the various images relating to it, as they exist in the astral world. These images, which are apprehended by means of the superior senses of the astral body, are of astral records of the past, of present interrelations, of past and present relations moving toward combination in the future, or having already combined on the inner plane, but having as yet had insufficient time to externalize.

The problem, however, does not present itself to the objective mind when the unconscious first turns itself to it, because it does not have enough energy to link up with the images already in objective consciousness. Instead, just as a photographer awaits the appearance of the sun from behind a cloud before attempting to see how the picture appears in the “finder,” so likewise, the image of the factors shadowed in the unconscious mind at first lacks the power to make itself felt strongly in the conscious mind. But when the sun shines brightly in the case of the photographer, and when the planets reach the proper positions in the case of one who unconsciously is pondering a question, energy of sufficient intensity then becomes available to give the image distinct objective form.

This brings us to the second factor; which is that a question or proposition that is present in the unconscious mind does not rise clearly into objective consciousness until the planets and signs are so situated that they correspond to the various elements of the matter, and thus add sufficient energy to them that they are thrust up into the objective mind. Thus it is that a proposition or serious question is never born in the objective mind until the planets correspond to its various elements and relations; no more so than that a child will be born and live until the astral vibrations set up by the planets correspond to the astral vibrations within its astral form.

A Horary Chart Maps Three Things

—A horary chart, then, is a map of three distinct, but sympathetically related, things. It is a map of the heavens at the time and place a question is clearly formulated. It is a map of the most active mental factors within the mind of the person asking the question at the time the question is asked. And, because these mirror the various conditions relating to the question, as perceived on the astral plane by the soul, it is a map of the various factors involved in the question.

The problem of the horary astrologer, therefore, is through a careful comparison of the harmony, discord and other relations that exist between these actors, to discern the nature of the past, present and future developments of the matter asked about. He has before him a map of the heavens; but this is also a map of certain related things as they exist on the astral plane. If he discerns, from this map, that several objects are moving toward a given point, he becomes aware from their rate of movement that in about so long a time they will meet. And from the properties of these things, their velocities, and the angle of their approach, he discerns whether they will meet harmoniously or discordantly. From this he can predict, with much certainty, the various results.

Now it may be that the one making the inquiry is under obligation to take and develop the picture, so to speak. It may be necessary for him to embark upon a certain enterprise whether it is pleasant or not. Or it may be that he has an option in the matter, and need not take the picture unless it is apt to prove pleasing. Therefore, the

astrologer should be able to give him an accurate preview, that he may know in advance just what the finished picture, or venture, will be like.

Furthermore, in case he is so situated that he can not avoid taking and developing the picture, even if in the preview it appears distressing, the astrologer should be able to show him all the details that will help him get the best results from a poor view. The astrologer has watched body, taking and developing of so many pictures that have been mapped by planetary positions that he should be able to advise whether or not the venture is worth the attempt, if attempted what the result will be, and how to get the best result if the attempt be made.

The Time of the Question

—It is always better to take the time when a question or proposition first is clearly present in the mind. If a proposition of any kind is presented, either personally or through the mail, the moment its import becomes clear is the time for which the chart should be erected. In case his time cannot be ascertained, it is customary to use the time when the question first becomes clear to the astrologer. The experience of a host of astrologers indicates that this latter method is reliable in a general way; for at this time, also, the matter considered is supplied with sufficient energy to make it manifest strongly. But when the time of its first clear formulation in the mind is known, this is the time that invariably should be used. It is the true birth of the question.

Personal Description Given By Planets

SUN: A strong vital body, above average size, light complexion, very dignified.

MOON: Tending to shortness and weight, pale complexion, wide forehead, listless.

MERCURY: Lean, nervous, sharp features, small eyes and ears, hair brown.

VENUS: Plump and handsome, tending to light complexion, mirthful, affable.

MARS: Wiry, robust body, strong muscles, ruddy complexion, hair with reddish tinge.

JUPITER: Large and ample body, sanguine or fair complexion. jovial, with much self-esteem.

SATURN: Large bones, looks raw-boned even when not tall, dark, serious, grave.

URANUS: Tall, slender, angular, brilliant eyes, erratic, argumentative.

NEPTUNE: Tendency to weight, oval features, large, dreamy eyes, pleasant appearing.

PLUTO: Average height, strong muscular body, deliberate but dynamic personality capable of expressing much force.

Personal Description Given by Signs

ARIES: Middle stature, spare, strong body, bushy eyebrows, dark hair, rather swarthy.

TAURUS: Short, thickset, dull complexion, large mouth, dark hair and eyes.

GEMINI: Tall, long arms, light complexion, brown hair, quick in action.

CANCER: Middle height, upper parts larger, small mouth and face, pale, milky eyes.

LEO: Breadth and size to stature, large head, light hair, ruddy complexion.

VIRGO: Average, compact body, brownish or fresh complexion, dark hair.

LIBRA: Tall and well formed, clear complexion, sparkling eyes, hair brown or black.

SCORPIO: Middle height, thick set, corpulent, hooked nose, dark hair, ruddy or swarthy complexion.

SAGITTARIUS: Above middle height, high forehead, long nose, sanguine complexion, hair brown.

CAPRICORN: Slender rather than stout, thin face, black hair, dark complexion.

AQUARIUS: Stout, well set, fair hair, sanguine complexion, pleasant.

PISCES: Tending to shortness, fleshy, pale face, brown or dark hair, fishy eyes.

Technical Terms

—In addition to descriptions of personal appearance, to deal concisely with the different persons and things of horary astrology, it is necessary to give them names. The student should become thoroughly familiar with these terms:

The person who asks the question is called the **Querant**

The person who erects and judges the figure is called the **ASTROLOGER**.

The person or thing about which the question is asked is called the **QUESITED**.

The planet ruling the house that denotes any person or thing is called the **SIGNIFICATOR** of that person or thing.

Any planet sharing the rulership of the house denoting any person or thing is called the **CO-SIGNIFICATOR**.

The planet actually in a house is Chief ruler of that house and Chief Significator of the person or thing denoted by that house; and the planet ruling the sign on the cusp of

that house is then the Co-ruler of the house and Co-significator of the person or thing denoted by the house. This is true in all branches of astrology.

If there is more than one planet in a house, the planet nearest the cusp of the house is usually the Chief ruler of the house; the other planets being Co-rulers with the planet ruling the sign on the cusp of the house.

The planets in the house have more rulership over the house than the planet ruling the sign on the cusp of the house. This is true in all branches of astrology.

In horary astrology the First House and the Moon are always taken as Significator and Co-significator of the Querent. The Querent, or person who asks the question, is always represented by any planet, or planets, in the first house, by the planet ruling the first house, and by the Moon as a Co-significator.

If the Astrologer is the Querent, asking the question as well as judging it, he is represented by the Significator of the Querent, as just given. But if the Astrologer is not also the Querent, he is signified by the seventh house and its ruler.

When Not to Pass Judgment

—A horary chart is said to be Radical when it is capable of being correctly and safely judged.

A figure erected for the exact time of the commencement of any enterprise or event is always a Radical Figure; because it will give correct information. But in a horary question, if less than 3 degrees of any sign, or more than 27 degrees of any sign, be found upon the Ascendant, it is usually better not to try to judge the figure. When less than 3 degrees rise, it indicates that the question is undergoing gestation and is not as yet completely formed. Therefore there is insufficient data upon which to base a correct answer. When more than 27 degrees rise, the question as formulated has been outgrown by new conditions, and these as yet have not been fully grasped by the unconscious mind. The question as asked, therefore, is obsolete, and cannot be answered from the figure. However, if the Ascendant and the planets it contains, together with the sign the planet ruling the sign on the Ascendant is in, describe the Querent's personal appearance accurately, the figure may be considered Radical in spite of too Few or too many degrees rising.

As the 7th house signifies the Astrologer, unless the question relates to the 7th house in particular, when the 7th house is found much afflicted it is often better not to give judgment; for it shows dissatisfaction with the judgment given by the Astrologer and possible trouble for him. Even when the question is a 7th house matter, if nothing but affliction is shown for the 7th house, the Astrologer should proceed with caution, as it indicates little ability on his art to give satisfaction.

Mutual Reception

—Two planets are said to be in mutual reception when each occupies the sign which is the exaltation or the home of the other. Thus if Saturn is in Leo and the Sun is in Capricorn, they are in mutual reception. If Jupiter is in Capricorn and Mars is in Cancer they are in mutual reception. When two planets are thus in mutual reception they tend to benefit each other through mutual aims. If at the same time they are in evil aspect, there will be an affliction commensurate with the aspect; but in spite of the aspect, each sets up vibrations in the sign that is the natural medium of the other, and thus renders the other assistance.

Mutual reception implies that among some of the things ruled by each planet there will be co-operation. It does not annul the effects of a discordant aspect between two planets. The aspect, good or evil, will work out to its full extent in terms of some of the things ruled by the planets; but the mutual reception will bring about a co-operation between other things so ruled; even if it be an unconscious and unwilling co-operation.

Mutual reception should be noted in natal astrology; and is especially important in horary astrology, as it often indicates whether certain things will pull together or fly asunder.

Dragon's Head and Tail, Fixed Stars and Part of Fortune

—The part of fortune is a point on the ecliptic as far removed from the Ascendant by longitude as the Moon is removed from the Sun by longitude. The dragon's head and tail are the Moon's nodes.

Where the orbital paths of two heavenly bodies intersect is called their nodes. As none of the other planets move in the same plane as the orbit of the earth, each of their orbits must cut the orbit of the earth at two points. Therefore not only the Moon, but each of the planets also, has both an Ascending Node and a Descending Node.

If nodes are to be used as sensitive points, logic would indicate that the nodes of all the planets, as well as those of the Moon, should be used.

From the standpoint of non-astrological divination, as explained in lesson No. 119 (See Serial Lesson Key), the more numerous the symbols present from which ESP may take its choice to give the correct impression to objective consciousness the better. But from the standpoint of the Hermetic System of Horary Astrology only those factors should be employed which experience proves actually add accessory energy to the thought-cells of the unconscious mind.

Although many Church of Light ministers who have attained outstanding reputations for accuracy in the practice of horary astrology have started by using the part of fortune and the Moon's nodes, it became apparent to them as they gained greater

proficiency that these symbols in a chart were a hindrance to the reliability of their work. A vast amount of statistical work in natal astrology and over a quarter of a century of checking in -lass the predictions of students of mundane astrology, together with the experience of these highly proficient horary astrologers, impels me to recommend that fixed stars, part of fortune and Moon's nodes be omitted from all astrological charts.

The Houses in Horary Astrology

—Probably the most common source of error in horary astrology is a failure to select the house to which the question properly belongs. The astrologer should not be content merely to accept the question as it is given to him; but should carefully interrogate the Querent until he finds out just what it is that he really wishes to know. The Querent may talk about property, or business, when the real thing in the back of his head is money. The question, on the face of it may appear, therefore, to relate chiefly to the 4th house, or to the 10th house; when in reality it is chiefly a 2nd house question in which the 4th or 10th merely indicate a source of revenue.

I cannot emphasize too strongly the necessity for reformulating the question when necessary, so that its true significance is at once apparent and it can be assigned to its proper house. And as all possible events and affairs come under the rulership of some of the houses, any possible question about events and affairs can be answered:

FIRST HOUSE: Everything to do with the personality; health, length of life, temperament and disposition, and personal prowess.

SECOND HOUSE: Wealth, personal property, profit and loss, cash.

THIRD HOUSE: Brethern, neighbors, short journeys, private studies, science, news, rumors, cousins, newspapers, periodicals, letters, messengers, land transportation, and thoughts.

FOURTH HOUSE: Home, environment, father, domestic affairs, lands, mines, real estate, houses, hidden things, lost articles, crops, the grave, cities and towns, end of life, and end of any matter.

FIFTH HOUSE: Love affairs, children, courtship, theaters, all places of amusement, pleasures, gambling, speculation, hazards, schools, wealth of father, and wealth of city or town.

SIXTH HOUSE: Sickness, labor, servants, Inferiors, tenants, farmers, small cattle and poultry, aunts and uncles, foods, army and navy, and ceremonial or other magic performed by the Querent.

SEVENTH HOUSE: Marriage, war, partnership, contracts, sweethearts, public enemies, defendant in a law suit, the astrologer, the physician, the opposing party, those met in public, any person inquired about not denoted by one of the other houses, such as a stranger, or a thief when there is a theft.

EIGHTH HOUSE: Death, legacies, partner's money, disembodied entities, and real or personal property when in escrow.

NINTH HOUSE: Long journeys, books, publications other than periodicals, advertising, public teaching and public expression of opinion, schooling, philosophy, religion, dreams, visions, and legal matters.

TENTH HOUSE: Business affairs, power, rank, position, superiors, the executive head of any enterprise, honor, credit, reputation, profession, and mother.

ELEVENTH HOUSE: Hopes, wishes, friends, counselors, acquaintances, praise, friendly criticism, and mother's money.

TWELFTH HOUSE: Private enemies, large cattle, disappointments, sorrows, psychic influences, magic either white or black performed by another, detective work, prisons, hospitals, charitable institutions, and self injury.

Things Are Brought to Pass in Three Ways

—In a great many of the questions proposed to an astrologer there will be found, either as the chief or as a secondary issue, the desire to know whether or not something will happen. Thus, when the main question relates to the advisability of making some business deal, the Querent nearly always also wishes to know whether or not the deal will be made. Or if the main question is as to marriage, or relating to a journey; in addition to wishing to know if the action should be taken, nearly always there is present a desire to know if, providing the step seems advisable, it can be brought to pass. If the figure shows that the enterprise, whatever it may be, will never mature, it is desirable to know what the causes, persons, or events are that hinder it, and why, and in what manner they frustrate it. But if the event will happen, it is equally desirable to know how it may be brought about, by whom, and in how long a time.

There are three different ways by which it is shown that an event will come to pass; and the student should make himself thoroughly familiar with these three ways; for upon his ability correctly to discern them hinges his success or failure in horary astrology.

1. By Aspect

—When the significators of the two or more parties to a transaction, or the significators of the factors that must be brought together to produce the event, are found within orb, and applying to any aspect of each other; and this aspect becomes complete before either receives or forms an aspect with another planet—which may be seen by inspecting the ephemeris—it is a testimony that the event will transpire.

The strongest aspect to bring a thing about is the Conjunction of the significators. The Conjunction and the Parallel bring matters to pass with ease or difficulty,

according to the aspects received from other planets. But they bring things to an issue.

When matters are brought about by a Trine they mature with ease, and the event proves beneficial.

When matters are brought about by a Sextile there is a favorable opportunity that will yield good results if grasped; and it may be brought to pass without difficulty.

When matters are brought to pass by a Semi-Sextile they are usually slightly favorable if they can be consummated; but much initiative is required to bring them about; and they will not come to pass unless there are additional testimonies.

The Inconjunct seldom brings matters to fruition. The matter is talked about and thought about, and then dropped.

The Opposition aspect sometimes brings an event to pass, though more often not. If it does come to pass it will prove unfortunate, and much difficulty and contention will arise out of it.

The Square aspect frequently brings things about; but it shows many obstacles to overcome. The difficulties experienced will be fully equal to the gain derived, and the results will not be as good as expected.

The Semi-square and Sesqui-square seldom bring matters to maturity. They show much worry and bickering and little difficulties arising; and either the matter is then permitted to drop, or if there are other helping testimonies, it comes to maturity, but is a source of annoyance, and very little good comes from it.

When the significators occupy Powerful Houses the event is more likely to happen; for there is plenty of energy present concerning the matter. When they occupy Feeble Houses it is much less apt to transpire; for there is insufficient energy present, and it comes to naught through indifference.

If the significators are Essentially Dignified it assists in bringing the matter to pass, and makes it more favorable than it otherwise would be.

Mutual Reception between significators applying to an aspect is a strong testimony that the event will transpire. Mutual reception, if the significators are not at the same time in aspect, tends to bring the significators together, but alone is not of sufficient power to bring the event to pass.

If one or more of the significators is Retrograde the matter may be brought to pass, but it will never manifest all that is expected of it.

Gauging Time

—To determine how long before the matter will be brought to pass, the nature of the matter, and its reasonable time limits, must be considered. Then pay particular attention to the signs the significators are in. If in movable signs, the matter will be

brought to pass quickly; if in mutable signs, after a moderate time; if in fixed signs, only after much delay. And the significator that applies, indicates the party or thing most active in bringing the matter to pass.

In matters that naturally mature very quickly, when the significators are in movable signs, call the number of degrees the aspect lacks of completion, hours. When in mutable signs call the number of degrees apart, days. And when in fixed signs, call the number of degrees apart, weeks. But in matters that mature less quickly call it days, weeks, and months; while in matters that naturally mature very slowly call it weeks for movable signs, months for mutable signs, and years for fixed signs.

When one significator is in a movable sign and another in a fixed or mutable sign, the time may be gauged by striking an average. However, in all timing by this method, it will be found when the significators are fast in motion that the event will transpire at an earlier date than that just given, but when the significators are slow in motion that the thing will mature somewhat more slowly than the time indicated by using the signs alone.

If, before the aspect is fully complete, one of the significators turns Retrograde and the aspect is not fully formed, that party will back down, or the things denoted by the retrograde planet will take a radical turn about, and the event will not come to pass. If, before the aspect between the significators is perfected, some other planet comes to a complete aspect to either of them, it indicates the interference of a third party or thing—which will be shown by the things which the interfering planet signifies—that comes into the transaction and prevents its maturing as it otherwise would. The significator first receiving the complete aspect from the interfering planet indicates the person or thing first affected by it.

If, before the aspect between the significators is perfected, one of them must pass to a different sign, it shows some change in affairs before they are brought to maturity. The matter is thus shifted to a new basis; and if the significators are in Feeble Houses, or in adverse Essential Dignity, and the aspect is not a very strong one, the matter will not come to pass. But if the significators are in Powerful Houses, or Essentially Dignified, and the aspect be a strong one, the matter will come to pass; but not as at first formulated.

Void of Course

—When a planet makes no aspect with another planet before it passes from the sign it is in, it is said to be Void of Course. When the Moon is void of course, the matter is seldom brought to maturity. If the figure is not Radical, through having less than 3 or more than 27 degrees of a sign rising, the matter seldom matures. Any enterprise undertaken when the Moon is void of course; or when less than 3 or more than 27 degrees are rising; is seldom a success. It is either premature or out of date.

If the significators are not within orb of aspect with each other, or if they are separating from the aspect instead of applying, the event will not transpire; except there is Translation of Light, or Collection of Light.

2. By Translation of Light

—When the significators are separating from an aspect, and some other planet forms an aspect to one of the significators and then moves to a complete aspect with the other signifier, it is called Translation of Light. It indicates that a person or thing comes in as a go between, or agent, and reconciles the significators and thus causes the event to transpire. The nature of the go-between is indicated by the things ruled by the planet that translates the light.

3. By Collection of Light

—When the significators are not within orb of an aspect to each other, or are separating from an aspect, if both form a strong aspect to the same planet, this planet indicates a common acquaintance, or a common cause, working to bring them together. If the planet that thus Collects the Light, through aspecting both significators, is powerful by accidental dignity, or strong by essential dignity, and the aspects are powerful, it will bring the factors together and the matter will be brought to a conclusion. If it is a weak planet and without dignity, an effort will be made to reconcile interests, but it will fail. If the aspects that collect the light are benefic, there will be little difficulty experienced. If the aspects are malefic, there will be difficulty and trouble; and unless the collector of light is very powerful, it may not be brought to pass. When one of the aspects is good and the other discordant, there will be some trouble and some success, the final result depending upon the power of the collector.

Chapter 5

Serial No. 90
Original Copyright 1931
Elbert Benjamine

Copyright
August 2002
Church of Light

Questions Relating to the First Six Houses

TABLE OF EXAMPLE CHARTS

Chart No.	HOUSE CUSPS					
	MIDHEAVEN	ELEVENTH	TWELFTH	ASCENDANT	SECOND	THIRD
4	27 55 47	01 77 02	00 52 00	23 52 40	21 24 26	23 47 17
5	20 77 51	20 52 49	14 24 32	04 47 24	06 29 37	14 55 09
6	28 79 52	25 55 00	01 77 28	18 52 32	15 22 50	07 55 20
7	17 47 40	08 29 18	01 55 46	06 34 36	24 77 04	24 52 54
8	13 29 47	06 55 47	08 34 34	25 77 26	29 52 47	22 22 47

Chart No.	POSITIONS OF PLANETS									
	☉	☽	♁	♂	♃	♅	♁	♁	♁	♁
4	03 22 28	04 27 56	02 22 09	22 52 39	21 52 34R	11 52 50	05 27 06	05 34 35	09 52 06	06 52 25
5	28 52 01	16 55 51	21 24 43	26 24 57	02 29 19	11 27 21	20 27 16	01 34 56	13 52 35	08 52 47R
6	12 52 30	14 77 06	29 52 23R	21 52 28	11 24 58	25 52 14	10 27 53	04 34 32R	11 52 20	08 52 06
7	15 27 01	14 52 13	14 27 01	03 52 05	02 47 01	02 27 33	15 27 01	03 34 11R	12 52 31	08 52 41
8	13 22 20	11 29 22	24 22 21	05 22 17	21 52 20	13 52 20	05 27 31	05 34 40Sta	09 52 19	06 52 39

Chapter 5

Questions Relating To The First Six Houses

BY common consent astrologers have adopted a condensed method of presenting the elements of any astrological chart. Each chart is indicated by an Arabic numeral at the left. This numeral appears twice; once at the left of the line in which the houses are tabulated, and once at the left of the line in which the planets are tabulated. Following this number, which designates a given chart, the sign and degree upon the cusp of each of the houses, from the 10th to the 3rd, are given in the same horizontal line, but in a column directly below the Roman numeral which indicates the house. The number of the chart is then used again in a separate table in which the sign and degree occupied by each of the planets are given in the same horizontal line, but in a column directly below the symbol of the planet. This method enables the elements of many charts to be tabulated in a small space.

To use such a table, the signs and degrees should be copied into a blank horoscope chart, so that they occupy the house-cusps indicated. Then upon the opposite house-cusps place the same sign and degree of the opposite sign. And finally, always being careful to use only the elements in the same horizontal line to the right of the chart number, the degrees and minutes of each planet should be noted, and the planets entered in the chart, just as in erecting a horoscope.

On page 80 will be found a table containing the elements of five different charts, and the elements of four more will be found on page 96. As these lessons were written, and the charts erected, in 1920, the planet Pluto¹ is not included; for it was not discovered until ten years later. These are example charts which will be used to illustrate the proper method of judging horary questions; and consequently, should be copied into blank maps for the purpose of study. Furthermore, as in each instance the data is given upon which they are erected, it is advisable for the student to erect the charts and compare his work with the charts so copied. This gives him twelve distinct charts in the first six lessons of the course, by which he can test his ability to make the calculations properly.

1 Correct Pluto positions were added to the Table.

What Is My Question About?

—When a horary chart is radical, it is usually possible by inspecting the chart, yet without being told, to determine the nature of the question asked. This is accomplished by noting the houses in which the significator and cosignificator of the Querent are, and the houses occupied by any planets strongly aspecting them. Thus in example chart No. 1 (lesson No. 86 [See Serial Lesson Key]), as a horary question, I would look to the house the Moon is in and the houses occupied by any planets making powerful aspects to the Moon; for the Moon in this chart is both cosignificator of the querent and ruler of the Ascendant. Neptune is the chief significator, and ruling the 9th indicates some thought of a journey; but its aspects are weak.

The Moon, on the contrary, has powerful aspects. As it is in the house of friends, I would say the question chiefly relates to friends. It has just passed the opposition of Venus in the house of children and love affairs, and the square of Uranus in the house of legacies and the partner's money. One could safely judge, therefore, that the question relates to a friendship which has been severed (opposition signifies separation) due to the influence of a child or a love affair. This situation has placed an obstacle (square signifies obstacle) in the way of receiving a legacy, or money from a partner.

In example chart No. 2, page 48, because the querent has so many significators, as shown by three planets in the 1st, the question is a complex one, involving many factors. Yet because the ruler of the Ascendant is in the 1st, the question is primarily concerned with personal matters.

The other factors chiefly relate to the personal life, and are shown by the houses ruled by the various cosignificators of the querent. The ruler of the Ascendant in the 1st, indicates concern about the health. Mercury, ruling the 4th and coruler of the 5th and 7th, in the 1st, indicates concern about the home, children and husband. Venus, ruling the 3rd, and coruler of the 8th, in the 1st, indicates concern about relatives or travel, and about the husband's income. The Moon, cosignificator of the querent, being in the 12th, indicates that the querent was greatly restricted at the time the question was asked. The most significant thing about the chart, however, is the presence of two traveling planets, Mercury and Uranus, in the 1st. From this I decide the thought uppermost in the mind at the time the question was asked is about some contemplated change by which the restrictions shown by the position of the Moon may be removed.

The question actually asked was: "Will I change my residence?" This, on the surface of it, is a 4th house question; but further interrogation brought to light that the change of residence was prompted by the greater desire to attain other ends; greater freedom, more abundant health and better opportunities for children and husband.

In example chart No. 3 (lesson No. 89 [See Serial Lesson Key]), the question at once is seen to revolve about the 3rd and 9th; for one significator of the querent is in the house of journeys and publishing and the other is in the house of travel, writing and study. The significator of the querent is Mars, ruling the house of money and the house of partnership. One may safely say, from inspecting this chart, yet without knowing anything about the querent or having been told anything about the question, that he was contemplating either writing or travel for the purpose of making money, and that there was a partnership involved. The Moon separating from square Saturn in the 11th, indicates he has recently lost a friend. The Moon applying trine Neptune, indicates successful promotion of the enterprise; and Venus applying to a conjunction of the Sun, coruler of the 11th, will bring him friends of influence who will give him adequate support.

Climate, Kind of Country, Land, Part of City and Part of Home Ruled by the Zodiacal Signs:

ARIES: Part of country; a hot dry climate, sparsely settled, moderately high and rugged. Land where pebbles and boulders are numerous, fields that are freshly plowed. Part of city; the manufacturing district, hardware stores, repair garages and auto service stations. Part of home, doorways, roof, and tool-room.

TAURUS: Part of the country; a cold, dry climate; low, level country without brush or woods, pastures where cattle feed. Land in which seed has just been planted. Part of city; banks, safes, vaults, cash registers, and places where money and securities are kept. Part of home; store-rooms, trunks, places where personal property is securely kept.

GEMINI: Part of country; a temperate climate, thickly settled, or a city or town, moderately high, and where the wind blows. Land rather rolling and covered with grass, small trees and shrubs; or where crops have just come through the ground. Part of city; railroad yards, street cars, newspaper and periodical offices, libraries, automobiles and aeroplanes, nail boxes, post offices, telephone and telegraph systems. Part of home; the telephone, halls, windows, writing desk and places where books and papers are kept.

CANCER: Part of country; a wet, cool, climate, along the ocean beach, or where small, active streams flow. Land of a rich, sandy loam in creek or river bottom, or near the ocean. Part of city; reservoirs, water pipes and hydrants, running water, hotels and the main residential district. Part of home; bath-room, laundry, and main living room.

LEO: Part of country; a hot, dry climate, rather low with level stretches, tending to desert conditions. Land that is left wild, or kept for the purpose of sport and amusement, such as golf courses. Part of city; theatres, schools, playgrounds, parks and places of amusement. Part of home; the nursery, furnace room, place where pots and kettles are kept, and all places where fire is used.

VIRGO: Part of country; a cold climate of moderate rainfall, moderately elevated. Land devoted to grain fields, orchards, or other crops. Part of city; public works, grocery stores, produce markets, agencies, restaurants and cafeterias. Part of home; the pantry, garden, dining room, sick room, and outhouses where chickens or small animals are kept.

LIBRA: Part of country; a temperate climate, high and dry. Land rather thickly settled and divided into numerous plots, or where there are towns and villages. Part of city; stores where wearing apparel, jewelry and finery are sold, show windows, and all places where nice things are on display. Part of home; wardrooms, bedrooms, balconies, porches, chinaware and silverware.

SCORPIO: Part of country; a damp, sultry climate, rather low than high, away from the ocean and in a valley between hills. Land where there are bogs, hot springs, quagmires, swamps, stagnant water and muddy ground. Part of city; drug stores, doctor's offices, morgues, slaughter houses, sewers and cesspools. Part of home; medicine shelves, the toilet and the sewer.

SAGITTARIUS: Part of country; a hot, dry climate in a mountainous country, moderately high. Land covered with woods. Part of city; churches, lecture halls, court houses, lawyer's offices, book stores, book publishing establishments and places for meeting for community welfare workers. Part of home; upstairs rooms, the chimney, cow barns, stables and the private garage.

CAPRICORN: Part of country; a cold climate with considerable snowfall, well up in the rugged mountains where there are rocks and brush, but few large trees. Land suitable for mining, where the soil is poor and weeds and thorns in abundance. Part of the city: the city hall, chamber of commerce and the business district in general. Part of the home; the office, the attic, the cellar and all dark places.

AQUARIUS: Part of country; a temperate climate, neither low nor high, with very changeable weather, thickly settled, including cities. Land not rugged, yet with an artistic view, and chiefly used for human habitation. Part of city; art stores, furniture stores, electrical stores, radio stores, electric lighting systems, and places where automobiles, airplanes and radios are sold and their accessories obtained. Part of home; the electric light, radio, reception room, parlor, stairs, chief furniture, and the artistic things on the wall.

PISCES: Part of country; a cool, rainy, foggy climate, moderately low and much broken, shut in on all sides by hills and cut up by ravines. Land about fishponds or through which large rivers or small sluggish creeks flow, or about large lakes, or where there are cool springs of water coming from the ground. Part of city; hospitals, jails, poorhouses and public charities. Part of home; sinks, pumps, cisterns, well and gas system.

Public Interest Questions

—In a question which is of interest to the general public, rather than of special importance to the individual who asks it, such as, “Will the U. S. go to war?”, “Will taxes be higher next year?”, “Will the criminal be caught?”, “Will congress pass the bill?”, “Will the candidate be elected?”, the querent is not represented in the chart. Instead, each house takes on its common significance, the first representing the people, the second representing money, the ninth representing the courts, etc., and the question belongs to, and should be answered from, the houses and their rulers thus commonly significant of the affairs chiefly involved.

First House Questions

—Questions relating to health, and to personal affairs generally, belong to the first house. A common first house question is, “Shall I have better success by remaining where I am or by going to some distant place?”

In such a question the 4th signifies the present home, or location, and the 3rd indicates the neighboring environment. The 10th signifies a foreign home, and the 9th its neighboring environment. The 4th and 3rd houses beneficent, therefore, gives success by staying close to the present environment; while the 10th and 9th houses beneficent gives success by going to a distant place. Consequently, note which of these two departments of the chart is more favorable, and advise the querent to reside in the section where the best influences are shown. If the chart indicates that the querent should go elsewhere, yet at the same time there is an evil aspect between his significator and the cosignificator of the 10th or 9th, the move should be delayed until a more favorable time. If there is no aspect between these significators, the move is not likely to take place. But if the significators are applying to good aspects of each other, he should make the change in the near future.

Favorable Directions and Environments

Because there is some confusion in regard to this, I should here emphasize that in the Hermetic System the signs have no influence over direction. All directions are designated solely by noting the direction in the chart of the house containing the significator.

The signs, instead of pointing out directions, indicate the kind of environment. This is of primary importance also in natal astrology; because it enables one to pick the most favorable gem, name, number, color, business, location, and even the most beneficial human associates. This is made possible because any thing, person or environment, ruled by a sign, through its proximity, adds energy both to the sign and to any planets located in the sign. A planet thus in a sign is more greatly intensified by association with the things ruled by that sign than is the planet that rules the sign but is located elsewhere.

For example, in chart No. 3, to give the Sun and the 9th house greater activity, a Leo environment would help but slightly; not nearly so much as a Cancer environment, because the Sun is actually in Cancer in the 9th. The chief influence of a Leo environment would be to accentuate the power of Jupiter in the house of friends. And while a thing ruled by Mercury would somewhat influence the 9th, because Mercury rules its cusp; this would have much less influence over the 9th than something ruled either by the Sun or Venus, because these are actually in the 9th. Furthermore, something ruled by the Moon would primarily accentuate the 3rd house, where the Moon is located, and only to a much less extent stimulate the 10th, the cusp of which is occupied by the sign Cancer.

Association with the things ruled by a planet or sign, merely gives the planet or sign increased energy; but does not change the quality of its energy. Therefore, to live in a vicinity ruled by a sign in which there is an unfortunate planet, is to increase its power for malignity; but to live amid conditions ruled by a sign in which there is a fortunate planet, is through affording it additional energy, to increase its power to benefit of the life. The various environments ruled by each of the twelve signs have already been given in his lesson.

A first house question that includes such a consideration is, Where should I go to have greatest success?

Now the Ascendant is directly east of the querent at the time the question is asked, and any planet in the Ascendant sheds its rays to him from the east. A planet on the M.C. is above, but also directly south of him. A planet on the Descendant sends its rays to him from the west; and so on. By traveling in the direction from which such a planet sends its rays to him, the querent comes more under the influence of that planet's vibrations. Thus if Saturn is in the 11th (example chart No. 3), he increases the power of Saturn in his life by traveling southeast. Or, if Uranus is in the 5th, the influence of Uranus is intensified by his traveling northwest.

This being the case, to take advantage of favorable influences, the querent should always go in the direction signified by that planet in the chart which has the best influence over the particular condition he desires. Thus, in the example chart No. 3, if the desire is to go to the place where health will be best, the querent should go a little west of south, where Venus and the Sun are located, and should choose a location by the seashore; for Venus is the best planet for health in this chart. It rules the Asc., and is conjunction the Sun, which governs the vitality. By going to a Cancer environment, the seashore, this benefic quality would be intensified; for the Sun and Venus are in Cancer.

But if the desire is to select the place where the greatest financial success as a writer could be attained, the preference should be given to the southeast; more south than east, where Jupiter is found; for Jupiter is in trine to the Moon in the house of writing, is coruler of the house of writing, is a money planet, and is sextile to Mars, significator of the house of money.

Yet of even greater importance, usually, than the direction in which the querent should go, is the kind of environment he should choose after making the move. Thus in the removal just considered the querent should locate in a Leo environment; for Jupiter is in Leo, and such surroundings will permit Jupiter to express fully. In this case, then, the most favorable location would be rather low, level country, tending to desert conditions. In such a situation, where the climate tends to be hot, living close to a school or park would assist Jupiter to attract the best financial opportunities, and lead to greatest success.

Another very important first house question is, “Will my health improve ?”

In all questions of health, either in horary astrology or in natal astrology, pay particular attention to the Sun and Moon, called luminaries, and to the Asc. and any planet therein. The stronger and better aspected the Sun, Moon and Asc., the better the health in general will be. The weaker and more afflicted the luminaries and the Asc., the poorer will be the health experienced.

If the significator or cosignificator of the querent is in the 6th, or is powerfully afflicted by a planet in the 6th, illness is indicated of the nature of the afflicting planet and the sign it occupies. If the significator or cosignificator is separating from an evil aspect, and applying to a good aspect, the health is poor but will improve. The recovery will be more speedy if the significators are in movable signs, but slower if in fixed signs. But when the significator or cosignificator of the querent is in the 8th and applying to an evil aspect of a malefic planet, such as Mars or Saturn, or when applying to a severe aspect of a planet in the 8th, and at the same time the Sun, Moon and Asc are much afflicted and receive no good aspects from benefics, such as Venus and Jupiter, the querent will die.

By noting, in a question of health, the aspects from which the significator and cosignificator are separating, the periods of past illness may be told and their nature described. And by noting the aspects to which the significator and cosignificator apply, the health that may be expected in the future may be determined, and the nature and cause of each change made known. Then, by using the rules for timing events, IS given in lesson No. 89 (See Serial Lesson Key), the time when the various changes in health will take place can be predicted.

Example chart No. 4, page 80, was erected for May 24, 1920; 4:00 P.M. P.S.T. Redding, Calif. 34N34 122W24. The question was, “What health may I expect in the near future?”

Venus is significator of the querent. The Moon is cosignificator of the querent. Mars, ruler of the 6th, 7th and 2nd, being conjunction the Asc., indicates that illness, partner and money are exerting an acute influence upon the querent. The significator, Venus, in the 8th, separating from the inconjunct to Mars, indicates some concern in the immediate past about death. The Moon, as cosignificator, in the 11th, indicates that the querent is closely associated with friends. The Moon, as cosignificator also of the 10th, indicates the friends to be quite absorbed in business; and not particularly concerned about the querent except for business purposes. The Moon is separating

from the square of Sun and Mercury, indicating severe affliction to the health in the near past; probably a nervous breakdown, as the afflicting planets are in Gemini, and Mars on the Asc. denotes extreme activity.

The next aspect made by the Moon is in the conjunction with Saturn, indicating grave affliction to the health through depleted vitality; bowel trouble being indicated by Saturn in Virgo. Saturn also is the ruler of the 4th, governing the end of life. Next, the Moon immediately applies to the opposition of Uranus, showing disruption of the electromagnetic forces of the body, and indicating, through its position in Pisces, a seriously impaired circulation. The Moon thereafter applies to semi-square Mars, indicating inflammatory conditions, and then to semi-square Asc., showing other disturbances. No help is shown from the benefics. This chart, therefore, indicates that the querent has been seriously ill in the past, has not yet recovered, and will shortly die.

A Caution

—I would, however, caution all against rendering a verdict of death either to the one who is to die, or to those intimately associated with him. Such a judgment has a depressing effect upon the afflicted person, and through the force of suggestion may well hasten the result. And such a thought held even by a friend of the afflicted person, though unknown to the latter, nevertheless carries the weight of a mentally delivered suggestion. It is usually possible to couch the language in which a judgment is given in such terms as to other encouragement and constructive suggestion, while at the same time rendering a truthful judgment and preparing the querent for eventualities.

Either in natal astrology or in horary astrology it is much better to refuse to give judgment than either to misstate the conditions or to give the querent adverse suggestions. An astrologer is not privileged to falsify; but he does have the privilege of leaving many things he knows unsaid.

Second House Questions

—In all questions of wealth, either in horary astrology or in natal astrology, pay particular attention to Jupiter and Saturn, and to the ruler and coruler of the 2nd. In a chart where money is shown to be gained or lost, the planet showing the gain or loss will also indicate the method by which such condition is brought to pass. Pluto shows gain or loss through mass production, group activity, co-operation or coercion. Neptune shows gain or loss through promotion and schemes; Neptune never makes money through hard work. Uranus indicates gain or loss through sudden and unexpected events, through inventiveness, new methods, electrical appliances, occult forces, and the ability to sway and influence others. Saturn shows gain or loss through shrewdness, caution, organizing ability, or perseverance; and to the accompaniment of much hard work. Saturn may deny money, or he may cause its

loss, but he never squanders it. Jupiter shows gain or loss through patronage, the handling of other people's possessions, and through the favors of circumstances, or their apparent favors. Mars shows gain or loss through mechanical things, and through aggressiveness and initiative. Whatever Mars brings or takes away is accompanied by strife. Mars may, or may not, give money, but he never hoards it. The Sun shows gain or loss through the influence of politics, or people in power, and through circumstances in general. Venus shows gain or loss through social contacts, through the opposite sex, and through the artistic and beautiful. Mercury shows gain or loss through agencies, writing and travel. The Moon shows gain or loss through the common people, through commerce, and through domestic interests.

A common second house question is, "Will the debt due me be paid?"

The debtor, or other person, unless a relative or intimate friend—in which case the house denoting such relative or friend should be observed—is represented by the 7th, and his money by the 8th. If the debtor be an intimate friend or relative, his money is represented by the next house following the house which represents him. If the significator or cosignificator of the querent, or the significator or cosignificator of the 2nd, apply by aspect to, or have translation of light or collection of light with, either the significator of the 7th or the significator of the 8th, it indicates the matter will be taken up for settlement.

If the aspects thus forming between the significators of the querent and his money and the debtor and his money are evil, an unsatisfactory settlement will be made. But if the aspects thus forming are favorable, the debt will be paid in full. If the significators are not brought together by aspect, translation or collection of light, no particular effort is shown on the part of the debtor to make any kind of settlement.

Another second house question is, "Shall I be rich?"

Judge chiefly from the aspects of any planet in the 2nd, and from the position and aspects of the ruler of the sign on the cusp of the 2nd. If the significator of money receives a strong and benefic aspect from Jupiter, it shows the power to acquire wealth. If the significator of money receives a strong and benefic aspect from Saturn, it indicates the ability to save wealth. Great riches require the favor of both these business planets. Good aspects from Jupiter and evil from Saturn show gain followed by loss. Good aspects from Saturn and evil aspects from Jupiter indicate power to retain, but poor ability to gain. The aspects of the other planets to the significator of money all assist or hinder, each in the manner above stated. The luminaries well aspected is also a great help in money matters, as it indicates favors both from those occupying position and the common people; both of these conditions assisting in the gain of wealth.

One of the most useful second house questions is, "Will the proposition make me money?"

It is better to set the chart for the exact time the proposition first became clear; though if this be neglected the question may be asked later, at the time the urge is felt for

solution. If the significators and cosignificators of the querent and his money are favorably aspected and apply to a favorable aspect, translation, or collection of light, to the significator of the proposition, money will be made out of it. If the significator of the proposition—if a business, the 10th, if publishing, the 9th, if speculation or hazard, the 5th, if real estate, the 4th, etc.—is well aspected and the significator of the querent applies to a good aspect of the significator of his money, or if there is a benefic translation or collection of light between these two significators, money can be made out of it. But if the aspects formed between the various significators given above are evil, either no money will be made from it, or not enough to recompense for the trouble. Where the testimonies conflict, the amount of gain or loss and its cause is shown by the planets making the aspects.

Example chart No. 5, page 80, was erected for Oct. 21, 1920, 9:20 A.M., P.S.T., Ryepatch, Nev. 40N30 L18W15. The chart was set up for the exact time a proposition was presented to buy a building which had been used as a warehouse. The question was asked, “Will the proposition make me money?”

The querent is signified by Mars, with Jupiter and Moon as cosignificators. Mars is separating from sextile Uranus, indicating the occult study in which he querent had been engaged. Jupiter is applying to a semi-sextile Neptune, ruler of the 4th, bringing the real estate to him, and applying to a conjunction Saturn, significator of the querent’s money. The Moon is in the house of writing, separating from the opposition of Neptune. The deal, as I saw it, should not have been attempted; but already, as this aspect disclosed, he had signed the papers, and could not withdraw.

The Moon next applies to semi-square Mars, showing friction; then to a square of Mercury and Venus in the house of disappointments, indicating a series of obstacles and disappointments in regard to the deal. Because Venus rules the house of friends, it was predicted that some friend upon whom he depended would disappoint him; but because Moon also applies to the trine of the Sun in the 11th before leaving the sign, that some other friend would come to his rescue in time to save him from complete disaster. This judgment was verified in detail.

Third House Questions

—Questions relating to brethren, studies, thoughts, writing, news and short journeys belong to the third house. A common third house question is, “Shall I agree with my neighbor?”

In such a question, note the aspects between the significator and cosignificator of the querent and the ruler and coruler of the 3rd house. If the aspects are malefic, disagreement is indicated. Those aspects between the significators that are separating indicate conditions past and those applying indicate the conditions in the future.

A very important third house question is, “Is the news true?”

When possible it is better to erect the figure for the exact time the report was first heard. The ruler and coruler of the 3rd represent the news. The house occupied by the ruler of the cusp of the 3rd indicates the department of life through which the querent is influenced by the news. A movable sign on the Asc.; Mercury, the Moon or the significator of the news in a movable sign; all tend to indicate that the news will later be contradicted. A fixed sign rising; Mercury, the Moon and the significator of the news in a fixed sign; all tend to give the report permanence and reliability.

Mercury severely afflicted tends to show the news false. If the affliction is from Neptune, it is an exaggeration, if from Uranus it is an invention pure and simple, if from Saturn it is designed to deceive for some crafty, selfish purpose, if from Jupiter it arose in a jest, if from Mars, from enmity, if from Venus, through imperfect knowledge, if from the Moon, through idle gossip. Good aspects to Mercury tend to confirm the news as true. The general nature of the news, for good or ill, is shown by the various aspects of the planets to the significator of the news. The effect of the news upon the querent is shown by the significator of the querent and its aspects; particularly any aspect between the significator of the querent and the significator of the news.

It is sometimes also desirable to know the condition of an absent brother or sister. In such a chart, the cusp of the 3rd represents, and its ruler is significator of, the brother or sister. The next house to the 3rd which is the 4th, represents the brother's money, the 5th, his neighbors, the 6th, his home, and so on around the chart. The house occupied by the ruler of the 3rd, counting the 3rd as the 1st of the brother, indicates his present interests. Thus the 9th house of the chart indicates his partners. But to find the direction in which the brother is, from the querent, note the quadrant of the chart occupied by the ruler of the 3rd, and judge the brother to be in the direction commonly designated by this quadrant of the chart.

A very common third house question is, "Shall I take a short journey?" In all questions of travel, writing and study, pay particular attention to Mercury and Uranus. When the significators of the querent and the significators of the 3rd are free from serious affliction, it is safe to take land journeys; and if they are well aspected such journeys will prove successful. If the significators of the 1st and 3rd are much afflicted, serious difficulties will be encountered. If there is an application by aspect, translation or collection of light between the significators of the querent and the significators of the 3rd, the journey will be taken.

As an illustration merely, because the question was actually about money, let us ask, using example chart No. 5, page 80, "Shall I take the journey?"

Mars separating from sextile Uranus in the 3rd shows an opportunity in the recent past for a trip. Jupiter in the 9th, cosignificator of the querent, also inclines to a journey. Mercury, a travel planet, conjunction Venus, indicates some happy friendship resulting from travel. But as these two planets are in the house of disappointments, and the next aspects of the Moon are to semi-square Mars and then to square Mercury and Venus; the trip would not be without some trouble, and would

prove disappointing. The Moon in opposition to Neptune indicates glowing anticipations which would not be realized.

Fourth House Questions

—Questions relating to the environment, domestic affairs, mines, real estate and lost articles belong to the fourth house.

Any article lost, strayed, or stolen, the whereabouts of which are unknown to the querent, is designated by the fourth house. If the hidden thing belongs to a friend, it is designated by the 2nd; if to a brother, it is designated by the 6th; and so on; for the 2nd house of the chart is the 4th house of a friend, and the 6th house of the chart is the fourth from the 3rd, or brother. Then note the part of the chart in which the ruler of the cusp of the 4th is located, and judge the article to be in that direction from the querent. But the kind of a place in which the article is located is indicated by the sign in which the ruler of the 4th, ruler of the lost article, is found.

If there is a benefic application by aspect, translation or collection of light, between the significator of the party to whom the article rightfully belongs and the significator of the article, it will be recovered; the means being shown by the planets and their aspects. If the application between significators is evil, either it will not be recovered or will cost more to recover than its value. If no such application, either benefic or malefic, be present, it will not be recovered.

In a question relative to buying real estate of any kind, the 4th represents the property and its value to the querent. If the significators of the property are malefic and badly aspected, the property has little value and will be a source of annoyance. If the significators of the 4th are benefics and well aspected, the property is of good value. The house and sign in which the ruler of the cusp of the 4th is found, together with its aspects, and the 4th house, give the

facts concerning the property. The seller of the property is signified by the 7th, and the property's value to the seller is signified by the 10th. Planets in the 10th, or the ruler of the 10th well aspected and free from affliction, indicates a high price. A malefic in the 10th, or evil aspects to the ruler of the sign on the 10th, indicates that the property is an annoyance to the seller, and that he will sell cheaply. The facility with which the bargain may be brought to a close is shown by the relation of the significators of the querent to the significators of the 7th.

Example chart No. 6, page 80, was erected for August 4, 1920, 11:10 P.M., M.S.T.2 Denver, Colorado 39N45 104W59. The question was, "Will my oil land produce oil?"

The significator of the querent in the 4th indicates the nature of the question. The cosignificator of the querent (Moon) in the 12th, separating from trine Neptune and the Sun, show restrictions placed upon the querent by real estate investments. Neptune is the planet of oil, and in the 4th indicates the hope of finding oil on the land.

Mercury, ruler of the 2nd and coruler of the 5th, in opposition to the M.C. indicates that the querent has jeopardized his business through placing money in the property, and that it is a hazard, as the 5th is involved. The Sun and Neptune are well aspected by the Moon, however, showing the property to be valuable. Venus is square the Asc., showing the property to be an obstacle to the querent at the time the question was asked. But the next aspect of the Moon is trine Venus, bringing the querent benefit from the property, and the aspect immediately following is Moon trine Jupiter, Jupiter being in the house of the property's wealth, the querent's 5th. I conclude, therefore, that the land will yield a producing oil well; and that the querent will find it a very good investment, not only for himself, but also for his partners; for Venus applies to conjunction Jupiter, ruler of the partner's money. Although the square of Sun and Neptune to Mars in the 6th, ruler of the 7th, indicates that the inefficiency of workmen will cause some loss, and that some difficulty arise with partners, the property will yield excellent returns.

Fifth House Questions

—Questions relating to pleasures, speculations, children and love affairs, belong to the fifth house. In such questions the ruler and coruler of the 5th indicate the conditions surrounding the amusement, pleasure, speculation or child asked about, and their aspects to the significators of the querent, their influence upon him. The fifth house has rule over the stock-market and all gambling.

A common fifth house question is, "Shall I have children?"

In such a question note the sign ascending, the sign on the cusp of the 5th, the sign the ruler of the cusp of the 5th is in, and the sign the Moon is in. If these are fruitful—Cancer, Scorpio, and Pisces—it is a testimony of children. If these are moderately fruitful signs—Taurus, Gemini, Virgo, Libra, Sagittarius and Aquarius—it argues neither for nor against children. If they are barren signs—Aries, Leo and Capricorn—the testimony is to deny children. The Moon or benefics in the 5th indicate children. The Sun or malefics in the 5th indicate that there will be no children or that they will not be reared. The number of children, where children are shown, is indicated by the number of aspects formed by the chief significator of the 5th. The 11th also should be given some consideration; for it indicates the children of the marriage partner.

Example chart No. 7, page 80. was erected for Sept. 7, 1920, 6:50 P.M. E.S.T., Chicago, Ill. 41N52 87W39. The question was, "Will children bless my married life?"

A fruitful sign rises, the Moon is in a fruitful sign, a fruitful sign is on the cusp of the 5th, and the ruler of the cusp of the 5th is in a fruitful sign; indicating a natural tendency to have a large family. The Moon separates from semi-sextile Neptune, significator of the querent, and applies immediately to sextile Mercury, Sun and Saturn, indicating that the querent will have children in the near future. Three

children are shown distinctly by the three aspects, and owing to the abundance of fruitful testimonies the querent would probably have more than three. As the aspect from Moon to the significator of the querent is slightly fortunate, and the aspect from Moon to the three planets is fortunate; these children will prove a great blessing. The ruler of the 1st in the 6th indicates the querent to be in uncertain health at the time the question was asked. After completing the three aspects mentioned, the Moon applies to semi-square Mars and semi-square Jupiter, indicating that children born after the first three would cause more trouble and be more difficult to raise.

Sixth House Questions

—Questions relating to servants, sickness, labor, small live stock and foods, belong to the sixth house.

To determine the nature, duration and seriousness of an illness, a chart should be erected for the exact time when the patient first perceived his illness. If this time is not known, the chart may be erected for the time the question first becomes clear. The significators of the 6th indicate the illness, and by their aspects, good or bad, give testimony to its seriousness. But even more importance should be placed upon the significator of the person ill and the luminaries, giving judgment as illustrated under the first house question, “Will my health improve?”

The heaviest afflictions to the significators of the querent indicate the birth chart constants of the disease. What disease is thus indicated by the birth chart constants is set forth in Course 16, *Stellar Healing* and in *Body Disease and Its Stellar Treatment*².

In a question of hiring a servant, or leasing to a tenant, the significators of the 6th represent the servant or tenant. A benefic in the 6th shows a kindly disposed person, a malefic, one not so genial. The aspects to the significators of the 6th show much concerning him, and the aspects between the significators of the querent and the significators of the tenant or servant indicate to what extent he will agree with the querent.

Example chart No. 8, page 80, was erected for June 4, 1920, 2:06 A.M., E.S.T., New York City 40N43 73W57. The question was, “Is this person a desirable tenant?”

Mars is chief significator of the querent, and the Moon is his cosignificator. Mars is likewise chief significator of the tenant, showing him to be an aggressive person. The ruler of the 1st in the 6th shows the tenant would dominate the querent. Mercury is cosignificator of the tenant, in Gemini, in the 3rd, separating from the trine of Mars; showing good will between the tenant and the querent in the past. The Sun in the 2nd, trine Mars, indicates that the tenant would pay well. He would, however, be difficult

2 Out of Print. Much of the research material found in this book can be found in Course 16 Stellar Healing.

to get along with, and very determined to have his own way in all things. The Moon applying square Mars shows that ultimately there would arise difficulties with him. Movable signs on the angles, the tenant signified by a traveling planet, and a planet in a movable sign, and the Moon in a movable sign, all indicate that the tenancy would be of short duration. This tenant would not prove of permanent value, but would be willing to pay well for the time of his tenancy.

Chapter 6

Serial No. 91
Original Copyright 1931
Elbert Benjamine

Copyright
August 2002
Church of Light

Questions Relating to the Last Six Houses

TABLE OF EXAMPLE CHARTS

Chart No.	HOUSE CUSPS					
	MIDHEAVEN	ELEVENTH	TWELFTH	ASCENDANT	SECOND	THIRD
9	01 77A 07	03 22 02	29 22 20	20 77A 59	21 77 05	25 27 27
10	03 22 00	01 77A 27	25 77A 10	13 77 58	17 27 47	26 22 55
11	10 27 15	03 22 11	03 77 29	18 77 42	24 27 32	19 22 57
12	01 77 26	22 77 35	13 27 51	10 22 45	29 77 07	05 27 39

POSITIONS OF PLANETS

	☉	☽	☿	♀	♂	♃	♄	♅	♁	♆	♇
9	27 77A 28	03 27 35	06 22 59	18 22 51	10 77 28	05 77A 16	16 77A 37	02 77 46R	12 22 54	08 22 45	
10	09 22 19	01 77 41	00 22 26R	17 22 22	10 77A 14	24 22 31	10 77A 31	04 77 39R	11 22 12	08 22 02	
11	00 77 21	18 77 53	16 77A 44R	06 27 21	26 27 28	16 77A 15	23 77A 13	01 77 48	13 22 45R	08 22 29R	
12	22 77 09	01 22 16	25 77 19	00 77 22	04 77A 09R	08 22 13	05 77A 20R	04 77 21	08 22 46R	05 22 45	

Chapter 6

Questions Relating To The Last Six Houses

IN horary astrology a great variety of questions belong to the seventh house; for in every question in which someone else is inquired about, unless he quite definitely belongs to one of the other houses, or unless it is a public interest question, as was explained in lesson No. 90, this person is signified by the 7th. Thus, in general, the 7th ever represents the other person, the one about whom the querent is concerned.

Seventh House Questions

—Questions relating to some person not definitely denoted by one of the other houses belong to the seventh house. A common seventh house question is, “Should I marry?”

In a horary question regarding marriage, even as in natal astrology, there are three distinct factors to be considered: (1) The general fortune or misfortune brought by association with the opposite sex. This is determined in the chart of a man by the strength and aspects of the Moon. In the chart of a woman it is determined by the strength and aspects of the Sun. (2) The general success in all affectional matters, as well as in love and marriage, including those with children and friends of both sexes. This is determined in the chart of either a man or woman by the strength and aspects of Venus. (3) The general success with partners; including business partnerships, domestic partnerships, and all other partnerships with either sex. This is indicated by the strength and aspects of the signifiers of the 7th.

If the Sun in a chart for a woman, or the Moon in a chart for a man, is well aspected, it indicates general harmony with the opposite sex. But if the Sun is afflicted in a chart for a woman, or the Moon in a chart for a man, little harmony is shown through association with the opposite sex, either in or out of marriage.

If Venus is well aspected and in a sign where essentially dignified, it indicates general success where the affections are concerned, though not necessarily with the opposite sex. If Venus is weak by sign and severely afflicted, there is little success in any affectional matter, with the opposite sex or others, in marriage or out of it.

If there is a benefic (Jupiter or Venus) in the 7th, not seriously afflicted, or if there is no planet in the 7th and the ruler of its cusp is a benefic and unafflicted, it indicates

there is much success as a rule in partnerships, though not necessarily so in marriage. If there is a malefic (Saturn or Mars) in the 7th, afflicted, or if there is no planet in the 7th and the ruler of the cusp of the 7th is a malefic much afflicted, it indicates there is little success in any kind of partnership, marriage included.

Consider these three factors and weigh all the conflicting testimonies one against the other. If the majority of the influences are favorable, the querent should marry. If the majority of the testimonials are unfavorable, the querent should not marry. When the chart shows somewhat favorable for marriage, note the Sun in a woman's chart, and the Moon in a man's chart. The first application of the Sun or Moon, as the case may be, denotes the first opportunity to marry, the second application by aspect, and so on. Therefore, if the first application of the Sun in a woman's chart or the Moon in a man's chart, is to a good aspect of a benefic planet, the first opportunity should be grasped. But if the first application is evil and the second application is good, the first opportunity should be passed by, and the second one grasped; and so of other applications.

Applications to semi-sextile, inconjunct, semi square and sesqui-square lead to thoughts of marriage, but unless there are other strong testimonies these seldom bring marriage about. In noting the opportunities shown, only the aspects to which the Sun or Moon applies before leaving the sign it is in should be considered; for the aspects made after it leaves the sign it is in relate to quite different conditions, which makes judgment very difficult.

Now before passing to the next question, it should be clearly stated that the planet occupying the 7th, and the ruler of the cusp of the 7th, indicate by their nature and aspects, the kind of persons and the fortune with them, there is a tendency to attract in partnerships. But, subservient to this general partnership fortune, the planet to which the Sun or Moon, depending upon whether a woman or a man asks the question, makes application, more specifically describes the person and harmonious or inharmonious qualifications, of the one there is opportunity to marry. Furthermore, the house occupied by the ruler of the cusp of the 7th, indicates the conditions and circumstances under which the future husband or wife will be met. That is, if the ruler of the 7th is in the first, the future partner will come to the querent about some personal matter, etc.

The question is frequently asked, "Shall I marry the person I have in mind?"

In such questions note if the significator of the querent applies to the significator of the 7th, either by aspect, translation or collection of light. If such is the case, there is every reason to think they will marry; but if not, they will not marry. If this application between significators is good, it shows the marriage will take place without serious hindrance or trouble. If the application is evil, there will be much difficulty before it is brought about. Where the marriage is shown to be prevented, the person or condition that hinders it may be determined from the interfering planet, or other condition in the chart that shows the matter will not reach completion.

Such a question is purely one of partnership, and the prospective partner is signified by the rulers of the 7th and their aspects. Thus if Neptune is the chief significator of the 7th, he is an idealist and dreamer; if Uranus, he is a crank or inventor; if Saturn, an elderly and serious person, and so on.

Then the aspects to this significator of the 7th indicate whether the prospective husband or wife is fortunate or unfortunate, and the various tendencies, virtues and vices. If the significator of the 7th is in the 1st, it indicates the partner-to-be loves the querent more than the querent loves him. But if the ruler of the 1st is in the 7th, the querent loves the prospective partner more than he loves the querent. And if the chief significator of the querent is better dignified than the chief significator of the partner, it indicates the querent is of better station; but if the chief significator of the 7th is better dignified, judge that the prospective partner has the better social position.

Another 7th house question is, "Where is my husband (or wife) from whom I am separated, and what is he (or she) doing?"

Judge the absent party to be in the direction from the querent denoted by the direction in the chart occupied by the ruler of the cusp of the 7th house. Judge that he is in an environment signified by the sign in which the chief significator of the 7th is found. Consider that he is most interested in those things denoted by the house in which the ruler of the cusp of the 7th is found, counting the 7th as his 1st, the 8th as his 2nd, etc. The strongest aspect to the chief significator of the 7th shows what he is engaged in. Thus if the strongest aspect is from Mars, he is in a dispute; if from Saturn, he is engaged in toil; if from Mercury, he is studying or traveling.

In case of theft, the thief is shown by the 7th, and the direction in which he is hiding is shown by the direction in the chart of the ruler of the cusp of the 7th. The kind of a place where the thief is, and what he is doing, are determined as in the case of the absent husband. The place where he had hidden the stolen property, however, is denoted by the ruler of the cusp of the 4th, as explained in lesson No. 90 (See Serial Lesson Key).

It is sometimes asked, "Does my lover care for another than myself?"

The 7th house denotes the lover (5th the love affair), and if the chief significator of the 7th is in close aspect to several planets, it indicates there are several affectional interests, or possible suitors. If these aspects are separating, it indicates that such interests are waning, and are largely interests of the past. But if these aspects are applying, they show interests that are maturing.

Aspects between the significators of the querent and the significators of the 7th, indicate the interest between the querent and the lover; and if such aspects are stronger and better than other aspects to the chief significator of the 7th, it shows the lover cares more for the querent than for any other. If the chief significator of the 7th is in a fixed sign, it indicates these affectional interests are enduring; but if in a movable sign, that they are transitory. The nature of the planets aspecting the chief significator of the 7th describes the nature of the various possible suitors; the sign in

which found that suitor's general environment, and the aspects of the planet his virtues and vices, his leanings and tendencies.

A very important question, whether asked about individuals, armies, or nations, is, "Will they fight?"

If there is any application by aspect, translation or collection of light, between the significators of the 1st and the significators of the 7th, there will be some decisive action, either through arbitration or combat. If this application is through good aspect, translation or collection of light, they will settle by arbitration; but if evil, they will fight.

Contests, Political Elections and Games

—Whenever there are two contending parties, the person, not a contender, who asks the question, steps to one side, and the Moon is not considered his significator, nor is he given a place in the figure. On the contrary, the chart then set up is divided between the two contending factions, the six houses on the east side of the chart representing the first party, and the six houses on the west side of the chart representing the opposing party.

In such a chart the 7th house is the 1st house of the opposition, and the 4th house is the 10th house of the opposition. If, then, the planets on the east side of the chart show more strength, ability and luck than those on the west side, the first party will win the contest; but if the planets on the west side of the chart show more strength, ability and luck than those on the east side, the opposition will win. That is, the more powerful half of the chart represents the victor.

The first thing, then, in deciding which side will triumph, is to determine which side is represented by the east side of the chart and which side by the west. Such a chart may be erected for the moment the contest begins, or it may be erected for the moment a horary question is asked. If the chart is set up for the moment the contest begins, because he takes the initiative, the challenger is represented by the east side of the chart and his opponent by the west side. When there is a champion, it is customary for him not to issue challenges, but to accept or reject them. But regardless of who is champion, the person who issues the challenge is represented by the east half of the chart and the one who receives the challenge is represented by the west half of the chart.

But in baseball games, football games, and college contests there usually is no definite challenger in the sense that there is a champion who must defend his title. In such a contest, the home team, because it is more closely identified with the person asking the question, is represented by the east side of the chart, and the visiting team by the west side of the chart. Yet when there is no well defined challenger and defender, or home team and visiting team, or where the contest is between political candidates neither of whom already holds the coveted office, there is still a way by

which the sides of the chart may be allocated. In such cases the wording of the question should be closely noted. Then the first party mentioned, because the chief interest is in this party in the mind of the asker of the question, is represented by the east side of the chart, and the second mentioned party is represented by the west side of the chart.

When only one side of a contest is mentioned, the other side is nevertheless implied. Thus if it were asked, "Will Chicago win the ball game?" Chicago would be represented by the east side of the chart and the unmentioned opposition would be represented by the west side of the chart. The weather, and the various other circumstances surrounding a game, are signified by the 5th house of the chart as erected.

A contest is really a 10th house question, because the victory, or honor, or credit, belongs to the 10th house. But the 1st house, representing the contestant himself, is also very important as indicating his luck and personal prowess. Therefore, in judging the relative power of the two sides of the chart, pay particular attention to the 1st and 10th where the first party is concerned; and to the 7th and 4th where the opposition party is concerned; for the 7th is the 1st house of the opposition, and the 4th is the 10th, or honor house, of the opposition.

Planets, except the malefics, on the east side of the chart, and particularly if in the 1st or 10th, favor the first party; but if on the west side of the chart, especially in the 7th or 4th (opponent's honor), they favor the opponent. Yet if these planets are much afflicted, it detracts from their power to help. Malefics, or quite severely afflicted planets, on the east side of the chart, particularly if in the 1st or 10th, weaken the first party and show poor luck; but if on the west side of the chart, especially in the 7th or 4th (opponent's honor), they show misfortune for the opponent. The personal prowess and the honor are thus considered as in a natal chart.

But in addition to this, there should be given much weight to the control each party has over himself and his honor, and over his opponent and his opponent's honor. This principle is set forth in lesson No. 88 (See Serial Lesson Key) under "The Sixth Step In Judging Any Horoscope." It is important enough to be included as one of the seven outstanding steps in judging any figure, and is particularly significant in judging a contest.

Thus, if the ruler of the 1st is in the 1st or 10th, or if the ruler of the 10th is in the 10th or 1st, it shows that the first party is master of his own personality and honor; but if the ruler of the 1st is in the 7th or 4th, or if the ruler of the 10th is in the 7th or 4th, it indicates that his opponent exercises an authority over him. Likewise, using the 7th as his opponent and the 4th as his opponent's honor, if the ruler of the 7th is in the 7th or 4th, or the ruler of the 4th is in the 4th or 7th, it shows that the opponent is master of his own personality and honor. But if the ruler of the 7th or 4th is in the 1st or 10th, it indicates that the first party has an authority over either the personality or the honor of his opponent. That is, if the ruler of the personality or honor is found in the house that rules the personality or honor of the other, it gives the other power over them.

And it is better to have these rulers on the side of the chart that they rule, as when they are on the side of the chart indicating the opponent they lose their freedom. Thus in all contests it is important not merely to gauge the strength of each side of the chart against the other, but also to note whether, by house position, one side has authority over the personality or honor of the other.

Furthermore, in a contest of short duration, such as an athletic contest, the turning points in the contest and the direction they take, are often shown by planets carried by the diurnal rotation of the earth to the conjunction of the 1st, 10th, 7th or 4th house-cusp. A planet having more degrees in the zodiac than such cusp, is carried to the conjunction of the cusp at the rate of about four minutes for each degree removed from the cusp. Thus if the 10th shows Virgo 1 degree, and Saturn is in Virgo 16 degree in a prize fight, if it lasted sixty minutes, the challenger at that time would probably be knocked out.

When, during a conflict, a malefic crosses the cusp of the 1st or 10th, the challenger, home team, a first party, is apt to have a difficult time; but if the malefic crosses the cusp of the 7th or 4th the champion, visiting team, or second party, suffers reverses

But when a benefic crosses the cusp of the 1st or 10th the tide of luck turns in favor of the challenger home team, or first party; and when a benefic crosses the cusp of the 7th or 4th, the element of luck is in favor of the champion, visiting team, or second party. When such aspects form often marks the victory of one and the defeat of the other of contending Example chart No. 9, page 96, was erected for Sept. 20, 1920, 10:25 A.M., Pacific Standard Time San Francisco, California, 37N47 122W26. This chart was sent to The Brotherhood of Light Astrology class in Los Angeles, and was judged by the class the following Monday evening. The question was, "Who will be elected president of the U.S., Senator Harding or Governor Cox?"

The east side of the chart, containing 7 planets, represents Senator Harding. The west side of the chart containing only the doubtful planets Uranus, Pluto and Neptune represents Governor Cox, as he was the second person mentioned in the question. The east side of the chart, and therefore Harding has much strength; but the west side having no benefits in it, nor Sun, Moon, nor Mercury, shows decided weakness.

The ruler of the 1st in the 1st, shows that Harding has authority over his own personality, but the ruler of the 7th in the 11th, shows that Cox is somewhat under the power of Harding's friends. The ruler of the 10th is on the east side, and the ruler of the 4th is on the west side; but Jupiter, Saturn and the Sun in Harding's house of honor give it greater power than Uranus in the house of honor of Cox. The class, without hesitation, decided that Harding would be elected.

Races

—The Brotherhood of Light endeavors to discourage gambling. Gambling encourages the pernicious trait of trying to gain something at the expense or loss to another; and panders to the weakness of desiring to have wealth without contributing

valuable service to society in exchange for it. Gambling is decidedly unspiritual. Yet races are not different in some respects from wars, political contests, and other trials of strength and speed which it is often decidedly to the advantage of society to be able to determine the outcome of in advance. That unspiritual people gamble on contests is just another illustration that whatever can be used for a good purpose can also be used for an evil one.

I have no inclination to write a treatise on playing the races; but I will say, from my observation of the many very extensive systems that have, from time to time, been placed on the market, that horary astrology is the equal of any I have seen in the reliability of its results.

When the interest becomes keenly centered on one particular horse, automobile, aeroplane, boat, or whatever is racing, so that the urge is strongly felt to know about this individual, the question may be asked, "Will this individual win the race?"

This individual, then, is represented by the east side of the chart, as erected for the time the question was asked; and the whole field against him is represented by the west side of the chart. The figure is then judged as above instructed for any contest. If the chart shows he will not win, at a later date the interest may be absorbed by another contestant, and the question asked about him, and another chart erected. But unless this urge is spontaneous, and not forced, it is better not to try to pick the winner if the first one picked is shown to fail.

Stock Market and Basic Commodity Market

—Each stock and each commodity has an astrological ruler, and no doubt a system can be worked out by which, through the aspects and movements of its ruler, the advances and recessions in price of the particular stock or commodity can be forecast. But any such attempt requires intensive and laborious research by a specially qualified person. And horary astrology gives greater reliability than most of the systems that can be purchased.

When the impulse becomes unusually insistent to know whether or not a certain stock or commodity is a good buy, ask the horary question, "Will this stock or commodity (naming it) prove a good speculation?" If there is a strong impulse to sell, ask, "Shall I sell this stock or commodity (naming it)?"

In either case it becomes a fifth house question, which a chart erected for the time the question was asked should answer. The fifth house rules the stock or commodity, because it is a speculation. The 1st rules the person who asks the question, and the 2nd rules the money that will be made or lost in the venture. Judgment is made accordingly.

Eighth House Questions

—Questions about death, legacies and other people's money, belong to the eighth house.

In contemplating a business transaction or partnership it is often advantageous to know whether or not some person has money. To determine this the question may be asked, "How much money has the person I have in mind?"

In this question the 7th and its significators represent the person inquired about, and the significators of the 8th, his money. Then consider the nature of the significators of the 8th and each planet aspecting them. An evil aspect from Saturn to the significator of the 8th indicates he is poverty stricken; a good aspect, that he is careful of what money he has. A good aspect from Venus shows he has money enough for comfort; a bad aspect, that he spends too much for finery and display. A good aspect from Mars indicates he is successful in making money, but that he spends it freely; a bad aspect, that he is spendthrift and always in need of money. A good aspect from Mercury indicates he makes money through his subordinates; a bad aspect, that he loses through ill-placed confidence in them. A good aspect from the Moon indicates he gains wealth by many small transactions; a bad aspect, that there are numerous little drains on his purse. A good aspect from the Sun indicates large financial gains; a bad aspect, that there are large losses. A good aspect from Jupiter shows great wealth; an evil aspect, that he uses poor judgment in handling such money as he has.

An eighth house question of some importance to those who believe in spirit communion is, "Shall I act upon the advice of a certain alleged spirit?"

The 8th and its significators indicate the spirit, and the 10th (3rd from the 8th) his advice or message. If the 8th holds a malefic, or the ruler of the cusp of the 8th is seriously afflicted, the spirit has little power of any kind for good. In all questions relating to the dead and to seance rooms, if the 8th is seriously afflicted, no good will come to the querent from spirit entities. If the 8th is favorable, it shows a kindly interest upon the part of the spirit; but if seriously afflicted by Mercury or Saturn, it is a lying spirit, and if by Mars, it is a spirit who wishes ill. However kindly disposed the spirit is indicated to be, if the 10th is afflicted, it indicates his advice is poor and should not be followed. But if the 8th is not seriously afflicted, and the significator of the 10th receives good aspects and is unafflicted, the advice or message is true, and should be followed.

A common eighth house question is, "Shall I receive the expected inheritance?"

The nature and amount of the inheritance are shown by the significators of the 8th. If there is an application by aspect, translation or collection of light between the significators of the 1st and the significators of the 8th, some inheritance will be received. If such application be benefic, the legacy will be received in full and without difficulty. But if the application is malefic, there will be much trouble, and

unless some of the applications be good, only a part of the expected legacy will be received.

Example chart No. 10, page 96, was erected for August 1, 1920, 4:30 P.M. Mountain Daylight Time, Denver, Colorado, 39N45 104W59. The question asked was, "Shall I receive the legacy?"

Jupiter is chief significator of the querent. Jupiter is in the 8th, indicating concern about a legacy, and that the legacy has considerable influence in the querent's life. Five planets in the 8th, indicate several possible legacies. The Moon, cosignificator of both the querent and the 8th indicates fluctuation in the relation of the querent to legacies; and separating from inconjunct Mercury, coruler of the 7th, and apply to conjunction Uranus in the 3rd, indicates some determined effort on the part of a relative to secure the legacy, and that the news of this effort will come as a surprise to the querent.

Leaving Uranus, the next aspects of the Moon are the trine to Pluto and inconjunct the Sun in the 8th, bringing the legacy into action; and then the Moon comes trine Mars in the house of friends, showing that friends will give advice and assistance in securing it. Immediately after this the Moon applies to the opposition of Saturn in the house of law, and ruler of the house of money, indicating money spent by the querent trying to secure the legacy. And finally the Moon makes the inconjunct of Neptune in the 8th, indicating that expectations will not be fully realized. The querent, therefore, after a legal struggle and the expenditure of considerable money, will gain a part, but not all, of the legacy.

Ninth House Questions

—Questions in regard to advertising, publishing, foreign travel, legal matters and public opinion, belong to the ninth house.

Law suits and lawyers are shown by the 7th; but when it is desired to know to what extent the court or the jury will be favorable or unfavorable to the querent, the significators of the 9th show their disposition.

In a question of public opinion, the public is represented by the 7th; and their thoughts about the judgment and mental qualifications of the querent are shown by the 9th; while the material and professional honor of the querent is shown by the 10th. If, therefore, there is a good aspect between the significators of the 1st and 9th, the public will place great confidence in what the querent writes or says; but if such aspects are evil, his opinions will have little weight with the public. If the significators of the 9th are in fixed signs, it indicates such opinions will be lasting, but in movable signs, that they are transitory and soon forgotten.

In a question of publishing, teaching, or lecturing, the greater the strength and the more good aspects received by the significators of the 9th, the more success is shown. The various aspects of the planets to the significators of the 9th show the kind of

people who read the publication, or listen to the speech; if from Saturn, farmers and serious people; if from the Sun, people of station and authority; if from Jupiter, those of wealth, etc. The kind of aspect, in each case indicates with what favor or otherwise they receive it. The opposition shows antagonism, the square indicates anger, etc.

If there is no aspect between the significator of the 9th and the significator of the 1st, the author will receive little recognition. A publication also may be a great success from the standpoint of popularity, and yet bring the author little or no money. To determine if money will be made from the publication, the significators of the 2nd, as well as those of the 9th, should be considered. If there are good aspects between the significators of the 2nd and 9th, and the significators of the 9th are strong and well aspected, the publication will be a financial success; and if at the same time there is a good aspect between the significators of the 1st and 9th, or between the significators of the 9th and 10th (honors), the publication will make the querent widely and favorably known.

Example chart No. 3, (page 64), was erected for June 28, 1920, 12:23 P.M., Standard Time, Bloomington, Ill. The question was, "Shall I travel abroad and write for publication?"

Mars, chief significator of the querent, in a movable sign, is ruler of the house of money, and semisquare both Saturn and Moon. Venus, the cosignificator of the querent, is in the house of foreign travel applying to trine Uranus, conjunction the Sun, and sextile Saturn. The Moon, also cosignificator of the querent, is in the house of writing, separating from square Saturn, applying sextile Asc., and trine Neptune in the 10th. Both 9th and 10th houses hold planets receiving good aspects, indicating success abroad.

The planets in the 9th apply mostly to good aspects, showing success in publishing. The ruler of the 2nd somewhat afflicted, will bring considerable expenditure of money. The trine aspect of Uranus to the planets in the 9th will cause the publication to be read widely by the radical element; and, as Mercury, coruler of the 9th, is inconjunct Uranus, the influence of this radical element will result in considerable expansion. The inconjunct aspect of the Moon to the planets in the 9th, and trine Mercury, show the publication will be read by the common people, and by them favorably received. The sextile of Saturn to planets in the 9th indicates the publication will be read by farmers, and quite favorably received. The coruler of the 9th (Mercury) in the 10th, well aspected, and the coruler of the 10th well aspected, while Mars is not strong by sign and applies to no good aspect; indicate the querent will gain much more in the way of reputation and influence by the venture than in actual cash. I judge the venture will be only slightly satisfactory from a financial point of view; but a decided success in gaining favorable publicity.

Tenth House Questions

—Questions relating to honor, business and credit belong to the tenth house. A common tenth house question is, “In what business should I engage?”

The significators of the 10th represent the business. Note what planet most strongly benefits the significators of the 10th, and choose business associations denoted by that planet. The ruler of the 10th shows the business the querent desires to follow, but if it is weak and afflicted he should not choose this business, but the one signified by the planet most favorably aspecting the significators of the 10th, or most favorably aspecting the degree on the cusp of the 10th.

Having determined the things with which in business he should associate, he should next select the best method to follow in the business, as suitable to his abilities, by noting the ruler of the 1st. If the ruler of the first is Pluto, it gives ability to handle groups and in mass production; if Neptune, psychic ability and dramatic talent; if Uranus, originality and oratory; if Saturn, agricultural and mining ability, if Jupiter, salesmanship and professional ability; if Mars, mechanical ability; if the Sun, ability to direct others; if Venus, artistic talent; if Mercury, ability in writing, and as an agent. He should then employ this kind of talent, shown by the ruler of the 1st, in following the kind of business whose associations are shown by the best planet aspecting the ruler of the 10th or cusp of the 10th. thus, if the business associations are shown by the Moon, it signifies commerce, or dealing in liquids. And if at the same time Mars is ruler of the 1st, it indicates success through manufacturing liquids; but if Mercury is ruler of the 1st, it indicates success through an agency for liquid goods.

One of the most important 10th house questions is, Should I engage in the business I am contemplating?

The contemplated business is indicated by the 10th. If the significator of the 10th is benefic and well aspected, it indicates the project is a good one. If the significator of the 10th is a malefic, or much afflicted, it indicates the project is a poor one. However meritorious the business is, if the significators of the 1st afflict the significators of the 10th, it will cause the querent much trouble if he enters into it, and he will meet with opposition and obstacles. If the significators of the 2nd afflict the significators of the 10th or the degree on the cusp of the 10th, or if the significators of the 2nd afflict the significators of the querent, the business will prove a financial loss, even though there may be gain in other ways. If the business is shown to be a good one, and either the significators of the 10th or the significators of the querent are in good aspect to the significators of the 2nd, it indicates the querent can make good money out of the business, and he should be advised to engage in it.

In a question of fame or notoriety, if Pluto is the chief significator of the 10th, the querent will receive recognition from gangsters or welfare workers; if Neptune is significator of the 10th, from mystics and promoters; if Uranus, from cranks and

inventors; if Saturn, from old and conservative people; if Jupiter, from people of wealth; if the Sun, from people of authority; if Mars, from soldiers, mechanics and surgeons; if Venus, from society people and artists; if Mercury, from writers, lecturers and young people; if the Moon, from the common people at large. If the significators of the 10th in such a question are well aspected, it indicates fame; but if afflicted, it indicates notoriety of an undesirable nature.

Example chart No. 11, page 96, was erected for November 22, 1920, 2:38 P.M., Pacific Standard Time, Reno, Nevada, 39N32 119W48. The question as asked was, "Should I engage in the business I contemplate?"

The Moon is chief significator of the querent. The Moon, common cosignificator of the querent, in the 1st, shows the querent to be quite free to decide the matter without outside pressure. Mars, coruler of the 1st, in the 10th, shows the querent to be very anxious to enter some business and to know about this one. Mars receives a trine aspect from Saturn in the house of work and as coruler of the 10th, indicating that the business would bring the querent much labor, and that he has ability to do the work in a proper manner. Mars, however, is square the Asc., indicating that the querent would find the business an obstacle (square means obstacle) to his health and personal desires. The Moon, chief significator of the querent, is separating from a favorable aspect to Neptune, and the inconjunct Jupiter and Mercury, and applying square to Mars; indicating that the querent has much more to lose by the business than to gain. Venus, ruler of the 2nd, is weak by sign, and makes no strong, good aspects, showing that very little money would be made from the enterprise. He should not engage in it.

Eleventh House Questions

—Questions relating to friends, hopes and wishes belong to the eleventh house. A very common eleventh house question is, "Shall I realize that for which I hope?"

In such a question consider the significator of the 11th as the thing hoped for. If the significators of the querent apply by aspect, translation or collection of light, to the significators of the 11th, the hoped for thing will be realized. If no such application occurs, the hoped for thing will not be realized. If the application formed is favorable, it signifies the thing hoped for will be realized without much difficulty, but if the application is by evil aspect, it indicates that there will be hindrances and obstacles to overcome of the nature of the aspects, and that the matter will be but partially realized. The significators of the 11th, together with the house in which the ruler of the cusp of the 11th is found, indicate the nature of the thing hoped for. If the significators of the 11th are severely afflicted, it indicates that the thing hoped for, when gained, will prove an affliction; but if the significators of the 11th are well aspected and strong, it indicates that the thing hoped for, if gained, will be a great benefit.

Another important eleventh house question is, "Will the friendship of the person I have in mind prove beneficial?"

In such a question the friend is indicated by the significator of the 11th. The friend's chief influence is denoted by the house in the chart in which the ruler of the cusp of the 11th is found. The planets by which the friend is signified indicate his nature, and the aspects to the significators of the 11th, his virtues and vices.

If the significators of the 11th are weak and much afflicted, he has not the ability to help the querent much. If the significators of the 11th are strong and well aspected, the friend has much ability to help the querent, if he but cares to do so. If the significators of the 11th are in good aspect to the significators of the querent, it indicates that the friend desires to favor the querent; and if there is favorable application by aspect, translation or collection of light between them, he will help the querent. If there is an adverse application by aspect, translation or collection of light, between these significators, it indicates that instead of being helped, the querent will be injured by the friend.

Example chart No. 1, lesson No. 86, was erected for January 2, 1920, 5:32 P.M., Standard Time, New York City. As an illustration let us suppose it to represent a horary question in which was asked, "Will the friend I have made benefit me?"

The Moon, cosignificator of the querent, in the house of friends, indicates the querent is much more interested in the friend than the friend is in the querent. The Moon is chief significator of the friend, and Venus his cosignificator. Venus is in the 5th, indicating that the friend's chief influence over the querent is in reference to the querent's speculations, children and love affairs. Venus is in the sign of Scorpio, applying to a square of the unconventional planet, Uranus.

The Moon is separating from the opposition Venus and square Uranus, indicating some unpleasantness with the friend in the near past over children or affectional matters, which resulted in a separation from the friend. This separation had some adverse influence over a legacy, or over money expected from a partner. The Moon applies to the sextile of the M.C indicating that the querent should be concerned no further about the friendship, as nothing may be expected of it; but should instead devote his attention and energy to business matters.

Twelfth House Questions

—Questions relating to psychic forces, secret enemies and imprisonment, belong to the twelfth house. A common twelfth house question is, "Will my enemy succeed in injuring me?"

If the ruler of the cusp of the 12th is in the 1st, it gives the querent an advantage over his enemy, but if the ruler of the cusp of the 1st, or the Moon, is in the 12th, it gives the private enemy the advantage. If there is no aspect between the significators of the 12th and the significators of the 1st, no injury is shown. If there are good aspects between the significators of the 12th and the significators of the 1st, efforts to injure will result in advantage to both rather than in injury to either. If the significators of the 1st are in evil aspect to the significators of the 12th, some injury is shown. If such

aspects are separating, it shows the injury to be past; but if applying by aspect, translation or collection of light, it is yet to come. If the significators of the 1st are stronger and better aspected than the significators of the 12th, the enemy will receive the greater injury; but if the significators of the 12th are stronger and better aspected than those of the 1st, the querent will receive the greater damage.

Example chart No. 12, page 96, was erected for April 12, 1920. 3:00 A.M., Central Standard Time, Omaha, Nebraska, 41N15 95W57. The question was, "Shall I be sent to prison?"

Uranus, ruler of the cusp of the 1st, in the 1st, indicates that the fate of the querent, in large measure, depends upon his own conduct. The Moon, cosignificator of the querent, is in the 12th, separating from sextile Venus and applying sextile M.C and to the square of Mars, ruler of the house of the courts. It then passes on, after some weak aspects, to the opposition of both Jupiter and Neptune. The trine of the chief significator of the 1st, Uranus, to Mars, ruler of the 9th, shows that the court and the jury will favor him; yet the square of the Moon to Mars indicates that he will not go entirely free, but will be convicted for a short term. He must go to prison, but the time served will be comparatively of short duration.

Horary Astrology's Greatest Usefulness

—Horary astrology attains its most consistent value when used to supplement natal astrology. In motoring through the United States, it is customary to procure a map which shows all the highways of importance. And thus also the natal chart and its progressed aspects afford a road map showing the important routes, and which it is best to take to avoid detours, washouts, and various kinds of difficulties.

But the amount of detail which either such a motor nap or that furnished by the natal chart and progressed aspects affords, is limited. When the motorist needs to drive about some city, to be able to find the points of interest, or places of business he desires to visit, he needs a city map. Likewise, when there are details not revealed by the birth-chart and progressed aspects which it is desirable to know, the astrologer needs horary astrology.

But to interpret horary charts in the detail often desired. the astrologer should be as familiar as possible with the facts which have been ascertained through statistical and other studies relating to natal astrology. For instance, if the first house question relates to how the health can be improved, he should base the information set forth in the book, *STELLAR DIETETICS*¹. to draw upon If the question relates to the vocation, he should be able to connect up the association most benefiting the tenth, and the first house ability, with the information set forth in. *HOW TO SELECT A*

1 Our of Print. See Course 21, *Personal Alchemy*, Lessons number 221-225.

VOCATION², based on the actual analysis of 3,000 charts of those following 30 different vocations. If the question relates to what will happen to the individual, he should be able to link up the significators of the first house with, WHEN AND WHAT EVENTS WILL HAPPEN³, based on the progressed aspects in 2,000 birth-charts when 20 different types of events actually occurred. And if the question relates to the nature of an illness, he should be able to bring the information to bear based on the statistical analysis of the birth-charts and progressed aspects of 100 persons at the time they had each disease. now being collected and set forth in BODY DISEASE AND IT'S STELLAR TREATMENT⁴. In other words to use horary astrology most effectively requires the widest possible scope of reliable astrological knowledge.

2 Out of Print. Much of the material referenced in this work has been incorporated into the 21 Brotherhood of Light Course Books.

3 *ibid.*

4 *ibid.*

Chapter 7

Serial No. 92
Original Copyright 1931
Elbert Benjamine

Copyright
August 2002
Church of Light

How to Select the Best Time for Any Undertaking

Table XI

The approximate time of sunrise, sunset and length of Planetary Day Hour for each month in latitudes 30°, 40° and 50° north. For Southern Hemisphere, use same time but opposite months to those given.

	April & September			May & August			June & July		
	30°	40°	50°	30°	40°	50°	30°	40°	50°
Latitude									
Sunrise A.M.	5:41	5:33	5:21	5:22	5:04	4:40	5:02	4:35	3:55
Sunset P.M.	6:19	6:27	6:39	6:38	6:56	7:20	6:58	7:25	8:05
Length hour	1h 03m	1h 04m	1h 06m	1h 06m	1h 10m	1h 13m	1h 10m	1h 14m	1h 21m
	October & March			November & February			December & January		
Latitude	30°	40°	50°	30°	40°	50°	30°	40°	50°
Sunrise A.M.	6:19	6:27	6:39	6:38	6:56	7:20	6:58	7:25	8:05
Sunset P.M.	5:41	5:33	5:21	5:22	5:04	4:40	5:02	4:35	3:55

This table gives length of day hour only. For the night hour (between sunset and sunrise) use the day hour of opposite month. This month is just above or just below. Thus for the night hour of April use the day hour given for October.

From tables XI and XII the planetary hours of any day of the year may quickly be found with precision enough for all practical purposes.

Table XII

Planetary rulership of each hour of each day of the week reckoned from sunrise, noon, midnight & sunset.

<i>DAY HOUR:</i>	<i>Sunrise</i>	<i>2nd</i>	<i>3rd</i>	<i>4th</i>	<i>5th</i>	<i>6th</i>	<i>Noon</i>	<i>2nd</i>	<i>3rd</i>	<i>4th</i>	<i>5th</i>	<i>6th</i>
<i>Sun.</i>	☉⇒	♀⇒	♃⇒	♄⇒	♅⇒	♆⇒	♁⇒	☉⇒	♀⇒	♃⇒	♄⇒	♅
<i>Mon.</i>	♃	♅	♆	♁	☉	♀	♃	♅	♆	♁	♁	☉
<i>Tues.</i>	♁	☉	♀	♃	♄	♅	♆	♁	☉	♀	♃	♄
<i>Wed.</i>	♃	♄	♅	♆	♁	☉	♀	♃	♄	♅	♆	♁
<i>Thurs.</i>	♆	♁	☉	♀	♃	♄	♅	♆	♁	☉	♀	♃
<i>Fri.</i>	♀	♃	♄	♅	♆	♁	☉	♀	♃	♄	♅	♆
<i>Sat.</i>	♅	♆	♁	☉	♀	♃	♄	♅	♆	♁	☉	♀
<i>NIGHT HOUR:</i>	<i>Sunset</i>	<i>2nd</i>	<i>3rd</i>	<i>4th</i>	<i>5th</i>	<i>6th</i>	<i>MidN</i>	<i>2nd</i>	<i>3rd</i>	<i>4th</i>	<i>5th</i>	<i>6th</i>
<i>Sun.</i>	♆⇒	♁⇒	☉⇒	♀⇒	♃⇒	♄⇒	♀⇒	♃⇒	♄⇒	♅⇒	♆⇒	♁
<i>Mon.</i>	♀	♃	♄	♅	♆	♁	♅	♆	♁	☉	♀	♃
<i>Tues.</i>	♅	♆	♁	☉	♀	♃	☉	♀	♃	♄	♅	♆
<i>Wed.</i>	☉	♀	♃	♄	♅	♆	♄	♅	♆	♁	☉	♀
<i>Thurs.</i>	♄	♅	♆	♁	☉	♀	♁	☉	♀	♃	♄	♅
<i>Fri.</i>	♁	☉	♀	♃	♄	♅	♃	♄	♅	♆	♁	☉

From Table XI, find the length of planetary hour for month and latitude, and the time of sunrise and sunset. Using Table XII to ascertain the appropriate starting point, add the length of the previously determined planetary hour as many times as is necessary to reach the sought after time of day. For example: Find the planetary hour rulership for 2 PM, Tuesday, October 3rd at 30°latitude.

From Table XI it is determined that the length of the planetary hour is 57m. (Note this is a day hour.)

Go to Table XII. Using Noon as the starting point (2 PM falls between Noon and Sunset), add 57m as many times as required to reach 2 PM. The interval between Noon and 12:57 PM is ruled by Jupiter. The interval between 12:58 and 1:54 is ruled by Mars. The sought after time of 2 PM falls in the interval between 1:55 and 2:51, therefore 2 PM is ruled by the Sun.

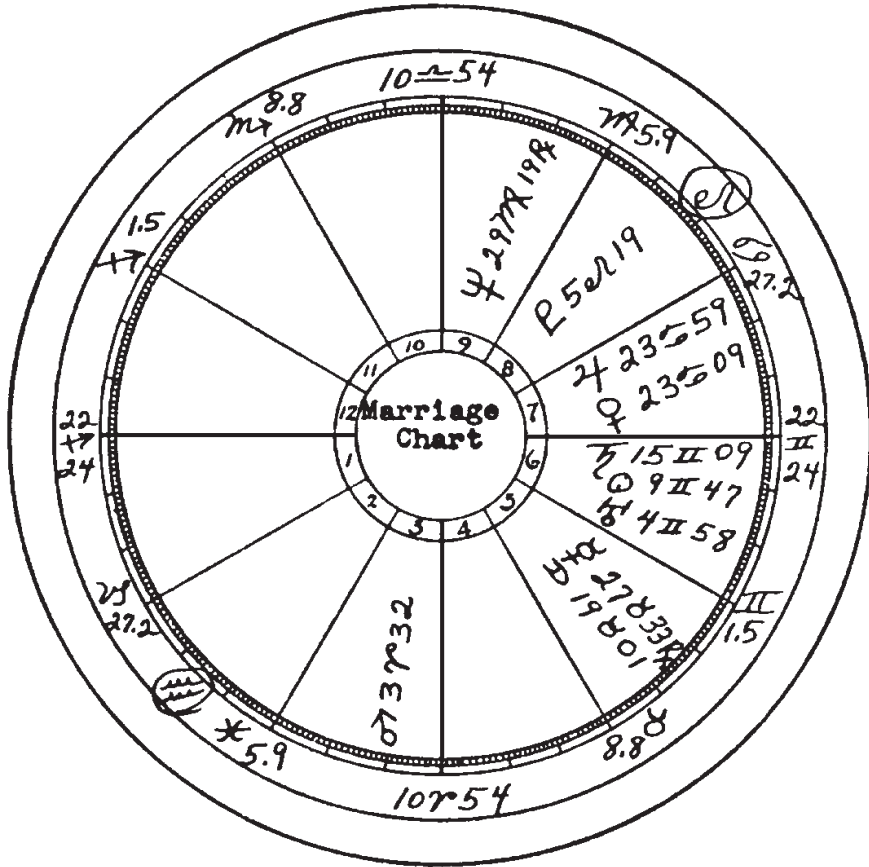

Example Of Successful Marriage Chart

Mar 31, 1943 115W 36N10 7:45 P.M. Pacific Standard Time

Chapter 7

How to Select The Best Time For Any Undertaking

ALTHOUGH, “To everything there is a season, and a time to every purpose under the heaven,” only an astrologer is competent to select such a time.

From the standpoint of astrology, the beginning of a project is its birth: the launching of a ship indicates its life, the signing of a contract shows what will eventuate from it, the acceptance of articles of incorporation and by-laws by the board of directors reveals the fortune of a corporation, and the laying of the cornerstone of a building determines its fate. Thus from a chart erected for the time and place of the commencement of any enterprise can be learned the vicissitudes and duration of its life, and from the progressed aspects that form in such a chart can be determined the time and nature of the events which will be attracted to it.

Events, like creatures, are both conceived and born. When a proposition first becomes clear in the mind is the moment of its conception. Its birth is when it first commences to assume independent physical shape. A child may be taken from its mother before gestation is complete, at a time when the planets are favorably placed, and if it lives the chart of its birth shows its life and possibilities. Yet in spite of picking a favorable relation among the planets for the operation, if there is too great variance between the nature of the child and these planetary positions, the child will die at birth. An event, likewise, may be forced and stillborn. But unless it is such a forced delivery, its birthchart indicates its failure or success.

First of All Consider Physical Environment

— An impossible venture started under the most favorable planetary conditions will fail because it is still born. Likewise, one may start the most promising enterprise at the wrong time and a venture that under normal conditions would be an unusual success is smashed on the rocks of adverse winds and tides. In neither natal astrology nor selecting favorable times, can we ever afford to overlook the power of physical environment. Inner plane influences exert a well defined force. But also physical conditions offer, at different times, various degrees of resistance to inner plane

forces. The result on the external plane is always the algebraic difference obtained by subtracting the resistance of physical environment from the inner plane forces.

That a venture may not be stillborn, therefore, the first thing is to examine the resistance of physical environment. Neglecting this, and considering only inner plane forces, one might pick a time when the Moon is in Pisces, decreasing in light and well aspected, just as winter is coming on, to plant potatoes. Such an enterprise will be stillborn, because potatoes, due to physical conditions, should be planted in the spring. But if one chooses a time when the Moon is located as stated at the season of year potatoes are usually planted, and gives them ordinary care, there will be a much larger yield than if they were planted while the Moon is increasing in light in Aries.

Next Consider Progressed Aspects

—The birthchart of the person expected to profit by the enterprise, and the progressed aspects in his chart, are of far more importance than any other astrological factor in selecting a proper time. They show with much certainty, physical environment not being tremendously adverse, whether or not the venture can have a proper birth. If the positions of the planets in the natal chart and the progressed aspects at the time show he can make no success of the enterprise either the venture will shortly die, or it will pass from his hands only to benefit another. If, as explained in Course 10, an inspection of the natal chart and progressed aspects reveals that the enterprise may successfully be launched, a time properly chosen for its commencement will insure it much greater success than it otherwise would have. And even when the progressed chart shows little prospect of success, the matter will be much less likely to fail if an otherwise auspicious time is chosen to make the start.

Selecting the Day

—To the extent circumstances permit a time should be chosen when a progressed aspect in the birthchart favorable to the enterprise is well within one degree of perfect. It is safer to have it within one-half of one degree of perfect and better that the aspect is applying rather than separating.

Either to take advantage of favorable progressed aspects, or to avoid discordant progressed aspects, or because of circumstances relating to the physical environment, there is usually a time limit within which a given venture must be started. This determined, the next step is to select, within such period, the most auspicious day.

To do this the planet having most influence over the venture should be determined: Jupiter for business, Saturn for real estate and agriculture, Venus for love, Mercury for writing and travel, etc., as later given. Then take the ephemeris for the year in which the venture is to be started and look over all the aspects within the time limit.

The object is to select that day on which the planet corresponding to the nature of the enterprise is well aspected, and at the same time there are as many good aspects and as few adverse aspects as possible. As will be explained later, in selecting the proper day particular attention also should be paid to the Moon, the sign she is in, the next aspect she makes, and whether increasing or decreasing in light.

Selecting the Exact Moment

—Having tentatively, at least, selected the day which appears most propitious to the venture, the next and final step is to select the hour and minute of that day when the house ruling the enterprise in the erected chart shall be subject to unusually favorable conditions. If the matter is a business enterprise the tenth and second should receive special consideration, etc.

The object is to give this house just as favorable a setting as possible, and so to place afflicting planets that they have as little influence over the things pertaining to the venture as possible. In this arrangement of the planets in the houses, a planet in the house ruling the venture is a far more vital and potent influence than if it merely rules the sign on the cusp of the house. When possible, therefore, to give life and energy enough to the enterprise so that it will not stagnate, it is well to have a favorably aspected planet actually in the house ruling the venture.

A certain amount of trial and error often enters into this matter of finding the best house positions for the planets on the selected day. A good way to start is to note the signs occupied by the various planets as given on the selected day in the ephemeris. Then turn to a table of houses for the latitude of the place where the venture is to be started, and looking down the columns which give the degree and sign on the cusp of each house, find a degree of a sign occupying the cusp of the house ruling the venture that will place well-aspected planets in that house, or at least give a well-aspected planet as ruler of the cusp of that house. And it is better still to have a favorable planet in the house and a favorable planet ruling its cusp. Using the Sidereal Time in the left-hand column which gives this house-cusp, copy the other house-cusps into a blank map, thus erecting a chart for this sidereal time. Then as a trial, without calculating the minutes, place each planet in the chart as found in the ephemeris on the chosen day. If this chart shows certain serious drawbacks, try others with the planets situated in different houses, until the best combination for the matter at hand has been determined for that day.

In judging of the merits and demerits of these trial charts the map should be considered in all its details. Every house and planet is significant, but of course the house ruling the matter is of most importance. Thus if it is a business proposition it is well to have Jupiter well aspected, and it is essential that the tenth house and its ruler are not seriously afflicted. If at the same time money is to be made from the venture, the significators of the second should also be well aspected.

The whole chart should be gone over thus: Consider the 1st house as the life and health of the venture then started; the 2nd as the money that will be made from it; the

3rd as its neighboring environment; the 4th as its residence; the 5th as its hazards; the 6th as the labor involved; the 7th as its partners and opponents; the 8th as the people's money associated with it; the 9th as the advertising it gets; the 10th as its honor and business success; the 11th as its well wishers; and the 12th as the disappointments it will have.

In such charts the aspects formed to the Ascending degree and M.C. should not be overlooked; the Ascendant as influencing the life and personality, the M.C. as influencing the success and credit. To illustrate, let us suppose a ship is launched when the 10th house and 2nd are favorable, but the 1st house is occupied by Mars, and the Ascending degree is afflicted. Such a ship would always find a cargo awaiting her, and every trip completed would yield good financial returns; but she would be in constant danger of loss by fire, explosion, or other accident; and would burn up or run on the rocks as soon as appropriate progressed aspects became perfect in the chart. For a proposition to be healthy it is necessary that the 1st house be strong and not greatly afflicted.

When a chart has finally been selected on the chosen day, the next thing is to determine the time of day when the houses and planets are thus situated, so the venture may be timed by a watch to be started with this birthchart.

In placing the signs on the house-cusps the sidereal time for the chart has already been noted. If not, consulting a table of houses will indicate it. Then note down the sidereal time at noon on the selected day. If the sidereal time for the chart selected is less than the sidereal time given on that day for noon, subtract it from the sidereal time at noon. The difference is the LMT Interval before noon, which subtracted from noon (12:00) gives the A.M. Local Mean Time. If the sidereal time for the chart selected is greater than the sidereal time on the chosen day, the sidereal time for noon must be subtracted from it. The difference is the LMT Interval after noon and is thus P.M. Local Mean Time. When a zero hour (midnight) ephemeris is used, the LMT Interval is before or after the zero hour (midnight).

Where great precision is required the correction for the increase of sidereal time at the rate of 9.86s per hour should be included in the final calculation of the chart, just as it should be included in any precise birthchart. With the LMT known, the chart should be erected using the EGMT Interval—or if an ephemeris computed for some other meridian than Greenwich is used, using the Equivalent Standard Meridian Mean Time Interval—to find the exact degree and minute occupied by each planet, just as in erecting any other birthchart.

To find the time of day, as timed by a watch, it becomes necessary to convert the LMT into Standard time, or perhaps into Daylight Saving Time if this is being used. To find the Standard Time, rules 8 and 9 of lesson No. 86 are merely reversed. Thus if west of the standard meridian add the difference in time from the meridian and if east subtract the difference in time from the meridian, to or from the Local Mean Time already found, to get the Standard Time. If the watch used registers Daylight Saving Time, to the Standard Time so found it becomes necessary to add one hour to get the

proper time for starting the venture by the watch. These various simple mathematical calculations will be made clear by referring to lesson No. 86.

At the front of this booklet will be found the chart an astrologer selected for the day and time of his own marriage. It will be noted that, to give as much harmony as possible to the house of marriage, he placed the two benefics there in conjunction aspect, and both sextile Mercury and Moon in the fifth house. The life of the venture is indicated by Jupiter ruling the cusp of the first house, the business success by Venus ruling the cusp of the tenth, etc.

At the front of lesson No. 18 will be found the chart selected for the birth of The Church of Light as a corporate entity, and the chart selected for establishing The Brotherhood of Light ESP Research Department.

The time limit, due to the passing of an anti-astrological ordinance, for selecting a chart for the Church was quite limited, otherwise the T-square of Pluto in the house of opponents and the public (seventh) in opposition to Saturn in the first, and both squared by Uranus, could have been avoided.

As it was, we placed the religious planet, Jupiter, ruler of the cusp of the first, in the house of churches (ninth), giving it as many harmonious aspects as possible, two other planets in the ninth trine the Moon in the first, and a good strong tenth house.

For the Brotherhood of Light ESP Research Department, we wanted the upper-octave planets as powerful as possible and as well aspected. Pluto rising and Moon conjunction Uranus, and both trine Neptune accomplished this. Uranus is the planet of research, and it dominated the chart. The house (third) significant of the mental activity used in research is occupied by the ESP planet, Neptune. While the inner plane planet, Pluto, in the house of life (first) is afflicted by Jupiter, it conciliates the opposition of Neptune and Saturn, being trine Saturn and sextile Neptune.

Less Significant Influences

—In reference to selecting a favorable time for doing something, the most important influence of all is that denoted by the Major Progressed aspects in the birthchart, the next most important is that denoted by the Sub-Major Progressed aspects in the birthchart, then come the Minor Progressed aspects in order of importance, Followed by the Transits and aspects made by the planets in the sky, and finally of least significance the planetary hours. Progressed aspects, including Transits, are fully explained in Course 10.

Not only in reference to them, but in reference also to the aspects of the planets in the sky, as shown by the ephemeris for the particular period under consideration, it is

important for the individual to determine from an inspection² of his birthchart his ruling planet, his best planet, his worst planet, his best house and his worst house.

The ruling planet is the planet which is most prominent and heavily aspected in the chart, and thus is shown to have the greatest and most constant influence over the life. The best planet is the one that indicates the kind of things that bring the most fortunate conditions into the life. The worst planet is the one weakest and most afflicted, and thus indicates the kind of things that bring the greatest misfortune into the life. The best house is the house of the birthchart showing the strongest and most fortunate influences and the least discord. It may be the house containing the best planet, or it may not; for the house containing the best planet may also contain an afflicted planet. This house represents the department of life from which may be expected the greatest favors. The worst house is the house of the birthchart showing the greatest discord. It may, or it may not, be the house occupied by the worst planet; for the house containing the worst planet may also contain a harmonious one. This house represents the department of life from which may be expected the most trouble.

When the time of day of an aspect has been found, or is noted in an aspectarian, at the place for which the ephemeris is computed, this time of day may be converted into the Standard Time (common watch time) of any place west of the Standard Time meridian used by the ephemeris maker by subtracting the number of hours west of it corresponding to the Standard Time Meridian at the place where the aspect is to be ascertained. Thus if the aspect is given for Greenwich Mean Time, for the eastern states subtract 5 hours, for Chicago and vicinity 6 hours, for Denver and vicinity 7 hours, and for the Pacific Coast 8 hours, from the time given to find the time by the watch. If the place is east of Greenwich the number of hours east should be added to the time given for the aspect. And where Daylight Saving Time is in use, one hour must be added to the Standard Time so found to get the time as shown by a watch.

On those days, particularly near the time of day when the ruling planet of the birthchart (you) receives strong aspects, as shown in the ephemeris for the current year, good or bad propositions or events, depending on whether the ruling planet is harmonious or discordant in the birthchart, are more apt to come to the person.

Other things being equal those days, and near the time of day, when the Best Planet in the birthchart is well aspected in the current ephemeris is the best time for taking the initiative in any matter, and the time when a favorable impression on others is most easily made. Other things being equal those days, and near the time of day, when the Worst Planet in the birthchart is afflicted by aspect in the current ephemeris is the worst time to take the initiative in any matter.

2 See Course 16, Stellar Healing for a discussion of Astrodynes which give a mathematical analysis of dominant, best and worst planets, signs and houses.

Buying and Selling

—To sell to good advantage here should be a strong influence from Jupiter; for Jupiter inclines people to be liberal in their expenditures. To buy at a bargain there should be a strong influence from Saturn; as Saturn contracts and influences toward a cheap price.

Other than the influence of these two planets to expand or contract, in buying, selling, trading, or other dealing the positions in the heavens influence primarily the person taking the initiative. Therefore, either in offering to sell or buy it is well to have the planets as well aspected as possible; but if another comes to you with something to sell, or to induce you to sell, while the planets are badly placed, he will be in a poor position to make a favorable trade, and may force the transaction at a loss to himself.

Moon Positions Favorable to Sixty-Two Different Human Activities

—When planets come within orb of an aspect, while the aspect is applying the influence indicated by the aspect is on the increase. It reaches its greatest power when the aspect is perfect, and consequently, as the aspect separates from perfect, its power wanes. To take advantage of the full influence of an aspect, a time for action should be selected just before the aspect is perfect, but while very close to perfect.

The Moon has much influence over the affairs that come up from day to day in human life. Yet as there are ten planetary orbs, all of which have an influence, a complete and detailed picture can be had only from a birthchart carefully selected for that purpose. Ordinary activities, however, do not justify so much pains; even though many of them do warrant the trouble it takes to glance in an ephemeris and note the chief aspects present between the planets, in addition to the position and aspects of the Moon.

As illustrating applying and separating aspects, when the Moon has left a discordant aspect and its next application is a harmonious aspect is a better time to act than when the Moon is just past the perfection of a harmonious aspect and is next applying to a discordant aspect. When the Moon is past the discordant aspect, yet within orb of it, but applying to a harmonious aspect, a matter that then starts badly will tend to improve; but if separating from a harmonious aspect and applying to a discordant aspect, a matter that starts well tends to have a poor ending.

The conjunction aspect of Moon and Sun constitutes the New Moon. The opposition aspect of Moon to Sun constitutes the Full Moon. From New Moon until Full Moon the Moon is **INCREASING** in light. From Full Moon until New Moon the Moon is **DECREASING** in light. From the conjunction with the Sun until the first square aspect of the Moon to the Sun, the Moon is in the First Quarter. From the first square aspect of the Moon to the Sun until Full Moon, the Moon is in the Second Quarter.

From Full Moon until the Moon again makes the square aspect with the Sun, the Moon is in the Third Quarter. And from this square aspect of the Moon to the Sun until it again reaches New Moon, the Moon is in the Fourth and last Quarter.

The exact conjunction, opposition, first square, or last square, or for 24 hours before or after these aspects, is not a good time to start any matter; for the aspects are discordant and the project becomes diseased. This eliminates eight days from each month as unsuitable for starting any venture. For a proposition to have a strong vitality and long lease of life, continuing to grow for a lone time and reach full size, it should be started soon after (but not within 24 hours of) the New Moon. Publicity, and vegetables that are to make their crop above the ground, should be started, or planted, while the Moon is increasing in light. A business or other proposition that needs forcing to quick maturity should be started a short time before Full Moon. Things which are to be kept secret, and vegetables which make their crop below the ground, should be started, or planted, while the Moon is decreasing in light. If they need forcing, the start should be made shortly before (but not within 24 hours of) the New Moon.

Each planet has special rulership over certain matters; and its aspects, therefore, are specially important in relation to their activities. The Moon rules planting, husbandry, nursing and the home; and much experience has accumulated to prove that it has a powerful influence over affairs associated with them; and an influence which should not be neglected even in other enterprises. This explanation should make it plain that in presenting the following alphabetical list, the condition indicated in connection with a given relation of the Moon will follow only to the extent that other things not mentioned are equal.

—A—

Advertising, gets better results if displayed while the Moon is increasing.

Affectional Interests, prosper more if undertaken while the Moon is in Taurus or Libra and applying to a harmonious aspect of Venus.

Automobiles, purchased or repaired while the Moon is increasing and applying to a harmonious aspect of Uranus, or well aspected in Aquarius, give better satisfaction.

—B—

Baking, progresses better while the Moon is in Aries, Cancer, Libra or Capricorn; and rises better while the Moon is increasing.

Buildings, will better resist destruction if first dirt is turned, cornerstone laid, or otherwise commenced while the Moon is in Taurus, Leo or Aquarius.

Buying, can be completed at a lower price while the Moon is applying to a harmonious aspect of Saturn, or Saturn is otherwise well aspected.

—C—

Canning, should be done while the Moon is decreasing, and gives better results if the Moon is in Cancer, Scorpio or Pisces.

Cement, should be poured while the Moon is decreasing in Taurus, Leo, Scorpio or Aquarius.

Clothing, including jewelry, should not be bought or first worn while the Moon is in Scorpio or Leo, nor should cloth be cut while the Moon is in Leo; best signs are Taurus and Libra.

Credit Purchases, should be made while the Moon is increasing, as when decreasing the payments are harder to meet.

—D—

Debts, are more easily collected while the Moon applies to a harmonious aspect of Jupiter, or Jupiter is otherwise well aspected; but not when the Moon is in Taurus, Leo, Scorpio or Aquarius.

Dental work, should not be done while the Moon is in Aries or Taurus. Extractions should be made while the Moon is increasing and in Gemini, Virgo or Sagittarius; fillings and plate impressions, while the Moon is decreasing in Taurus, Leo, Scorpio or Aquarius.

—E—

Eggs, should be set to hatch while the Moon is increasing in Cancer, Scorpio or Pisces; Cancer is best. For quick maturity, the Moon should be in second quarter; for size, in first quarter.

Employees, should be hired while the Moon is applying to a harmonious aspect of Saturn, but not while in Scorpio or Capricorn. They remain longer if hired while the Moon is in Taurus, Leo or Aquarius.

Employment is more readily obtained while the Moon applies to a harmonious aspect of the Sun, or the Sun is otherwise well aspected.

Entertainments, are more successful while the Moon is increasing and applying to a harmonious aspect of Neptune, or Neptune is otherwise well aspected.

ESP, or other psychic endeavor, is facilitated while the Moon is in the second quarter, especially just as it comes to full, and while it applies to a harmonious aspect of Neptune or Pluto.

—F—

Favors, are more readily granted while the Moon applies to a harmonious aspect of Jupiter, or Jupiter is otherwise well aspected.

Fishing, is best three days before and three days after full Moon. Fish bite well while the Moon is in Cancer, Scorpio and Pisces, and on those days when the Moon makes the conjunction, square or opposition of the Sun.

Flowers, for fragrance and beauty should be planted while Moon is increasing in Libra or Taurus. For abundance of bloom, plant when the Moon is increasing in

Cancer, Scorpio or Pisces. Plant bulbs for seed while Moon is decreasing in Cancer, Scorpio or Pisces.

Fruits, picked while Moon is decreasing and not in Cancer, Scorpio or Pisces, keep better. Furniture, first used while Moon is in Taurus, Leo or Aquarius and applying to a harmonious aspect of Saturn, gives good service. For beauty, purchase while Moon is in Taurus or Libra. Grafting, pollinating, budding, etc., should be done while the Moon is increasing in Cancer, Scorpio or Pisces.

—G—

Grain, should be planted in the second quarter of the Moon in Cancer, Scorpio or Pisces. To keep well as for seed, it should be harvested just after full Moon while Moon is in Aries, Gemini, Leo, Libra, Sagittarius or Aquarius Hay, should be cut while the Moon is decreasing in Gemini, Libra or Aquarius; leaves shatter less when in Aquarius.

—H—

Hair, should be cut while the Moon is increasing For beauty it should be in Taurus or Libra, and if applying to a harmonious aspect of Venus, so much the better For luxuriant growth it should be in Cancer, Scorpio or Pisces. Treatments to increase growth should be started while the Moon is increasing in Scorpio, subsequent treatments while increasing in Cancer, Scorpio or Pisces

Healing, is more readily accomplished while the Moon is increasing and applying to a harmonious aspect of the Sun

Hedges, trimmed while the Moon is above the earth in the first quarter, especially while it is applying to a harmonious aspect of Venus or Jupiter, grow better.

—I—

Irrigation, is most satisfactory while the Moon is in Cancer, Scorpio or Pisces.

—L—

Legal Matters, are best commenced while the Moon applies to a harmonious aspect of Jupiter, or Jupiter is otherwise well aspected.

Livestock, should be timed to bear young a little more than 24 hours after new Moon while the Moon is in Cancer, Scorpio or Pisces.

—M—

Manicuring, is more satisfactory while the Moon is increasing in Libra, Gemini, Aquarius or Taurus. Do not cut ingrown nails while the Moon is decreasing.

Meat, killed while the Moon is increasing in Aries, Leo or Sagittarius keeps well. The joints cure better and there is less shrinkage.

Moving, while the Moon is increasing in Taurus, Leo or Aquarius insures a longer stay in the new location. Never move while the Moon is in Scorpio.

—P—

Painting, should be done while the Moon is decreasing, and in Taurus, Leo, Scorpio or Aquarius; Scorpio is best.

Parties, are better attended and enjoyed while the Moon is increasing, and in Libra, Taurus, Gemini or Sagittarius.

Permanents, last better if obtained while the Moon is in Taurus.

Posts, should be set while the Moon is decreasing and in Taurus, Leo, Scorpio or Aquarius.

Potatoes, keep longer if dug while the Moon is decreasing in Aries, Leo or Sagittarius, especially Leo; last quarter is best.

Pruning, should be done while the Moon is decreasing in Cancer, Scorpio or Pisces.

—R—

Renting, should be done while the Moon is applying to a good aspect of Saturn, or Saturn is otherwise well aspected. If it is to be permanent, the Moon should be in Taurus, Leo or Aquarius. To get a comfortable place, the Moon can be in Leo; for neatness and beauty, in Taurus or Libra.

—S—

Sauerkraut, tastes better when made just after full Moon while Moon is in Cancer, Scorpio or Pisces. Selling, can be accomplished more readily, and at a higher price, while the Moon is applying to a harmonious aspect of Jupiter, or Jupiter is otherwise well aspected.

Sheep, sheared while the Moon is increasing in Cancer, Scorpio or Pisces, especially when it is applying to a harmonious aspect of Venus, insures a better growth for the next shearing.

Shellfish, are best when caught at full Moon.

Shingling, should be done while Moon is decreasing, and in Taurus, Leo, Scorpio or Aquarius.

Shoes, should not be purchased or first worn while the Moon is in Capricorn or in discordant aspect with Saturn. They will give more comfort if the Moon makes a harmonious aspect to Neptune, or is well aspected in Pisces.

Sign Papers, when the Moon makes a harmonious aspect to Mercury, or Mercury is otherwise well aspected.

Speeches, including those given by radio, are better received while the Moon is increasing and is in Sagittarius, or when it applies to a harmonious aspect of Jupiter.

Spraying, should be done while the Moon is decreasing and in Aries, Leo or Capricorn.

Surgical Operations, are best performed when the Moon is two signs past the sign ruling the part of the body operated on. The humors of the body, and the tendency to hemorrhage and inflammation, tend to follow the course of the Moon. Thus the Moon will have ten signs to go before it again reaches the part of the body operated on. Never pierce with iron the part of the body ruled by the sign occupied by the Moon. Never castrate animals while the Moon is in Virgo, Libra or Scorpio.

—T—

Timber, cut while the Moon is decreasing seasons better, and will not warp or decay so readily if cut while the Moon is in Aries, Leo or Sagittarius. Avoid Cancer, Scorpio and Pisces.

Transplanting, should be done with the Moon located as for the original planting of the same thing.

Travel, when the Moon is in Gemini or Sagittarius and makes a harmonious aspect to Mercury, or Mercury is otherwise well aspected.

Trees, to live long and make good growth, should be planted while the Moon is increasing and in Cancer, Scorpio or Pisces.

—V—

Vegetables, that make their crop below the ground should be planted while the Moon is decreasing and in Cancer, Scorpio or Pisces. If larger growth is wanted, plant soon after full Moon. If quick tender growth is wanted, such as for turnips and radishes, use the last quarter.

Vegetables, that make their crop above the ground should be planted while the Moon is increasing in Cancer, Scorpio or Pisces. For rank growth, plant in the first quarter. But if quick tender growth is desired, such as for green corn, peas, string beans, tomatoes and melons, use the second quarter.

—W—

Weaning, should be done while the Moon is in Sagittarius, Capricorn or Aquarius, and it is better to have it decreasing.

Weeds, are best destroyed when cut while the Moon is decreasing, especially in Aries, Leo or Capricorn.

Winter Wheat, should be sown as soon after Full Moon as the Moon can be found in Cancer, Scorpio or Pisces. It needs a good root system.

Wire, should be stretched while the Moon is increasing in Taurus, Leo, Scorpio or Aquarius.

Write, when the Moon makes a harmonious aspect to Mercury, or Mercury is otherwise well aspected.

Ventures Ruled by the Planets

—The **SUN** rules people in authority, politicians, the government, the vital forces, the male sex, children, and speculation. In any action which involves the good will of those in authority, and in seeking a position or promotion, see to it that the Sun receives a good aspect from the Moon and is otherwise well aspected. All affairs concerning health and vitality should be commenced while the Moon applies either to the first sextile or to the first trine. The best times of day for any of these matters are the planetary hours of the Sun.

The **MOON** rules the common people, nurses, liquids, groceries, the home, music in general, and females. In any dealing where these are involved see to it that the Moon applies to good aspects, and is in a sign where strong. For wide and favorable publicity the Moon should be in the tenth, well aspected. The best times of day for such matters are the planetary hours of the Moon.

MERCURY rules writers, students, writing, printing, speaking, teaching, contracts, travel, and mental work in general. In any enterprise including one of these things see to it that the Moon applies to a good aspect to Mercury, and Mercury is otherwise well aspected. For any activity requiring fluency of speech, clear thinking, or an alert mind, choose a day when Mercury is well aspected. The best times of day for any of these matters are the planetary hours of Mercury.

VENUS rules artists, social matters, friendship, love, marriage, singing, dancing, art, finery, and has some influence over ready cash. For success in such activities see to it that the Moon applies to a good aspect of Venus, and that Venus otherwise is well aspected. Buy or make things requiring taste and artistic appreciation at such a time. The best times of day for such matters are the planetary hours of Venus.

MARS rules doctors and surgeons, mechanics, soldiers, warfare, machinery, the use of iron and steel, and building and manufacturing in general. When starting anything dependent on such things, see to it that the Moon applies to a good aspect of Mars, and that Mars otherwise is well aspected. The best times of day for such matters are the planetary hours of Mars.

JUPITER rules clergymen and professional work, legal matters, charities, banking, publishing, religion, philosophy, finances, people of wealth, goodwill, salesmanship, patronage, and general good luck. When commencing any activity dependent on such things see to it that the Moon applies to a good aspect of Jupiter, and that Jupiter otherwise is well aspected. The best times of day for any of these matters are the planetary hours of Jupiter.

SATURN rules miners, farmers, common laborers, hard work, business in general, mining, real estate, elderly people, agriculture, and secret and hidden things. When commencing any activity dependent on such things, see to it that the Moon applies to a good aspect- of Saturn, and that Saturn otherwise is well aspected. The best times of day for any of these matters are the planetary hours of Saturn.

URANUS rules lawyers and astrologers, unusual methods in business, astrology, occultism, invention, electricity and ingenious mechanisms, automobiles, radical ideas, exposures, reforms and agitation. When commencing any activity dependent on one of these things see to it that the Moon applies to a good aspect to Uranus, and that Uranus otherwise is well aspected. The best times of day for any of these matters are the planetary hours of Mercury.

NEPTUNE rules actors and psychics, feeling ESP, promotions, involuntary servitude, stock companies, utopian ideas, dramatic expression in all its mediums, aviation, submarines, gas, oil, drugs and poisons. When commencing any activity dependent on one of these things see to it that the Moon applies to a good aspect to Neptune, and that Neptune otherwise is well aspected. The best times of day for any of these matters are the planetary hours of Venus.

PLUTO rules those of great spiritual attainment, intellectual ESP, dictators, gangsters, spirituality, inversion, kidnapping, the inside of things, the inner plane and inner plane activities, coercion, radio, television, cooperation, groups, and group activities of all kinds. When commencing any activity dependent on one of these things see to it that the Moon applies to a good aspect to Pluto, and that Pluto is otherwise well aspected. The best times of day for any of these matters are the planetary hours of the Moon.

Planetary Hours

—Of less importance than the aspects present among the planets in the sky are the planetary hours. They are the least significant of the astrological influences we shall consider; yet people are called on to do things when the time limit is a day or even half a day, and there is no opportunity to select even a favorable aspect of the Moon. Also while Moon aspects are favorable, there often is opportunity to select in addition a planetary hour favorable to the matter at hand.

Planetary hours, as handed down from ancient times, are not of the same duration as clock hours; but each is an equal division of a given day measured from sunrise to sunset, or of a given night measured from sunset to sunrise. The planetary hour of any day measures exactly one-twelfth the time from sunrise to sunset; and the planetary hour of any night measures exactly one-twelfth the time from sunset to sunrise.

The first planetary hour after sunrise is always ruled by the planet that rules the day. Thus the first hour after sunrise on Sunday is ruled by the Sun; the first hour on Monday by the Moon, etc. The rulership of the planetary hours always follows each other in this order: Sun, Venus (or Neptune), Mercury (or Uranus), Moon (or Pluto), Saturn, Jupiter, Mars, Sun, Venus, Mercury, Moon, Saturn, etc., on through all the hours of the day and night, and through the next day, and on through the months and years without a break in the order of sequence.

A fact all too often overlooked by those using planetary hour books is that the time indicated is Local Mean Time. In using such books, and in using tables XI and XII at

the front of this booklet, the time obtained being Local Mean Time, before it becomes available for events timed by a watch this must be converted into Standard Time, or perhaps into Daylight Saving Time.

To get the precise time of the commencement and end of the planetary hours on a particular day, the time of sunrise and sunset must be found, and the interval between divided by 12 to get the length of each day hour, and the interval between sunset and sunrise divided by 12 to get the length of each night hour. But in tables XI and XII I have given a condensed table by which the approximate time of commencement of any planetary hour of any day in the year may be determined from about latitude 25° to latitude 55° . Both in this table and in planetary hour books approximate results only are attained; because there is a slight variation in the duration of the planetary hour from day to day and for each different degree of latitude. Nevertheless, the results obtained from these tables are close enough for ordinary purposes; and where more precision is required the precise time can be ascertained by calculating the exact time of sunrise and sunset as already indicated. The latitudes given in the table are 30° , 40° , and 50° ; but the intermediate latitudes may easily be determined by interpolating such differences as are necessary.

Example

If I live near latitude 40° north, and on Friday, during the month of August, a person comes to me with a proposition at 11:00 A.M. Local Mean Time, and I wish to know the planetary hour in which the matter was presented to me, I first turn to table XI. I there find that during August in latitude 40° sunrise occurs approximately at 5h 4m A.M., and that the approximate duration of the planetary hour is 1h 10m. Now 11:00 A.M. is within the planetary hour just before noon, which is, as indicated in table XII, the sixth planetary hour after sunrise. There are always six planetary hours between sunrise and noon, noon and sunset, sunset and midnight, and midnight and sunrise. I therefore look in table XII for sunrise, and follow across the page until I reach the sixth hour after, then ascend the column until I find the horizontal line following Friday. I there find the word Mars. It was a Mars hour.

Finding the Night Hours

—In using the tables for night (from sunset to sunrise) always use the duration of the day planetary hour for the opposite month, instead of the day hour for the month under consideration. The opposite month is given just above or just below in table XI. As night is the opposite of day, this should give rise to no confusion, and permits the table to be greatly condensed.

Example of Night Hours

Suppose I wish to find the earliest Jupiter hour on some Saturday night in December for selling something of considerable value to a prospect who can only be contacted over the dinner table. If I am in New York, Chicago, Denver, or Salt Lake City, I use the table for 40° latitude, and find from table XI that sunset occurs in December about 4:35 P.M. But as it is a night hour, I do not use the length of hour given under

December, but the one given under June, which is immediately above in the table. The approximate duration of the hour is there found to be 1h 14m.

I now look in table XII for sunset on Saturday. The first hour after sunset is there shown to be ruled by Mercury, the second hour by the Moon, the third hour by Saturn, and the fourth, which is the hour I am looking for, by Jupiter. Therefore, three full planetary hours of 1h 14m duration each must elapse after sunset before the commencement of the Jupiter hour. I multiply 1h 14m by 3, which gives 3h 42m. To 4:35 P.M. (sunset) I add 3h 42m. This gives 8:17 P.M. Local Mean Time as the commencement of the Jupiter hour, and as it lasts 1h 14m it lasts until 9:31 P.M. Local Mean Time. Then, to be able to time the dinner and the interview by my watch I convert this Local Mean Time into Standard Time. Thus the time by a watch at New York at the beginning of the desired planetary hour is 8:13 P.M., and the hour lasts until 9:27 P.M.

In All Cases When L.M.T. Is Given, to Find the Standard Time, use Rule 8 and Rule 9 of Lesson 86, but add when the place is west of the standard meridian, and subtract when the place is east of the standard meridian; just the reverse of finding the L.M.T.

Using Table XII, page 113

It should be noted that when midnight is passed the following day begins, and therefore from the line in the lower left-hand quadrant giving a certain day when midnight is passed it is necessary to drop down one line in the lower right-hand quadrant.

Thus the last hour on Saturday is ruled by the Sun, given on bottom line of lower left-hand quadrant; and the first hour (starting with midnight) of Sunday is ruled by Venus, given on second line of right-hand lower quadrant. The last hour of Sunday is ruled by the Moon, given on second line of lower left-hand quadrant; and the first hour (starting with midnight) of Monday is ruled by Saturn, given on 3rd line of right-hand lower quadrant. The last hour of Monday is ruled by Mars, given on 3rd line of lower left-hand quadrant; and the 1st hour (starting with midnight) of Tuesday is ruled by the Sun, given on 4th line of lower right-hand quadrant. The last hour of Tuesday is ruled by Mercury, given on 4th line of lower left-hand quadrant; and the 1st hour (following midnight) of Wednesday is ruled by the Moon, given on 5th line of lower right-hand quadrant. The last hour of Wednesday is ruled by Jupiter, given on the 5th line of lower left-hand quadrant; and the 1st hour (following midnight) of Thursday is ruled by Mars, given on 6th line of lower right hand quadrant. The last hour of Thursday is ruled by Venus, given on 6th line of lower left-hand quadrant; and the 1st hour (following midnight) of Friday is ruled by Mercury, given on 7th line of lower right-hand quadrant. The last hour of Friday is ruled by Saturn, given on 7th line of lower left-hand quadrant; and the 1st hour (following midnight) of Saturday is ruled by Jupiter, given on lower line of right-hand lower quadrant. Then the last hour

of Saturday is ruled by the Sun, and the rotation of planetary hours continues indefinitely.

Chapter 8

Serial No. 36
Original Copyright 1948
Elbert Benjamine

Copyright
August 2002
Church of Light

Chart Erection Short Cuts and Examples

Correcting House Cusps for Latitude of Birth

Find (a) the difference in °s and ´s between the house cusp for the nearest latitude to that of birth and the house cusp for the next nearest latitude to that of birth given in the table of houses..

Find (c) the difference in °s and ´s between the nearest and the next nearest latitude to that of birth given in the table.

Find (d) the difference in °s and ´s between the true latitude of birth and the nearest latitude given in the table.

By proportion:

Reduce each term to ´s, then multiply (a) by (d) and divide the product by (c). This gives (b), the correction for latitude.

By logarithms:

From log. (d) subtract log. (c), and to the difference so found, add log. (a). The result is the log. of (b), the correction for latitude.

When the true latitude of birth is less than the nearest latitude given in the table:

If the table shows the ´s decreasing with latitude, the correction is added. If the table shows the ´s increasing with latitude, the correction is subtracted.

When the true latitude of birth is greater than the nearest latitude given in the table:

If the table shows the ´s decreasing with latitude, the correction is subtracted. If the table shows the ´s increasing with latitude, the correction is added.

Research has shown the necessity of correcting birthcharts for precision. This process involves finding ALL the house cusps to the exact MINUTE for *exact* Sidereal Time (Page 21, Lesson 86)and *exact* Latitude (see above). ALL house cusps will then show the exact minute on them. Just as a scientist uses the most accurate methods available even if the data is incomplete; so should the astrologer strive for precision and accuracy in every chart.

Chapter 8

Chart Erection Short Cuts And Examples

THE principles and steps to be taken in erecting a horoscope for any time and place are explained in lesson No. 86 (See Serial Lesson Key). There are certain short cut methods that may be used under common circumstances, and alternate methods which some find make the work easier. These will be explained and used in some of the example charts.

Church of Light Student's Charts were designed to facilitate taking each of the essential steps in erecting a chart explained in lesson No. 86 (See Serial Lesson Key) in its proper sequence, and by presenting a blank line to be filled in following printed instruction as to the entry to be made on it to make it unlikely any required calculation would be overlooked.

On a Student's Chart there are thus 28 lines that may be filled in. As the chart was designed to take care of any contingency in chart erection, commonly a few of the lines, which do not apply to the particular chart under construction, are left blank. But for facility in learning to erect a chart according to the Hermetic System it is essential that the student know precisely what entry should be made on each of the 28 lines. For purposes of ready reference, on each of the 10 Student's Charts here reproduced a number has been inserted before each of these lines.

Line 1: Write in the name of the person, corporation, city, nation, planetary cycle or horary question for which the chart is erected.

Line 2: Write in the month, day of month, and year of birth.

Line 3: Write in the name of the place of birth.

Line 4: Write in the latitude of the place of birth.

Line 5: Write in the longitude of the place of birth. The latitude and longitude of a place may be ascertained from an atlas or map. Goode's School Atlas has an index giving the latitude and longitude of over 30,000 places in the world. Dornay's Longitudes and Latitudes throughout the World (except the United States) gives the precise latitude and longitude of 5,000 cities distributed through 187 countries, colonies and dependencies; and Dornay's Longitudes and Latitudes in the United States gives the precise latitude and longitude of all county seats, and all cities with

2,500 inhabitants or over in the United States. For a precise chart, the exact latitude and longitude of the place for which it is erected must be ascertained.

Line 6: Unless some other kind of time than Standard or Local Mean Time was used in timing the birth, line 6 is left blank. If Double Summer Time was used (as in mid-summer in England during World War II) this should be noted in entry of time on line 6. If Daylight Saving or War Time was used (as throughout the U. S. from 2:00 A.M., Feb. 9, 1942, to 2:00 A.M., Sept. 30, 1945; and during the summer only both before and since in various regions), it should be entered on line 6.

Line 7: Unless some other kind of time than Standard Time or Local Mean Time was used in timing the birth, line 7 is left blank. If Double Summer Time was used, write minus 2h on line 7. If Daylight Saving or War Time was used, write minus 1h on line 7.

Line 8: If the birth was timed by Standard Time write it on line 8 as so many hours and minutes A.M. or P.M. If the birth was timed by Double Summer Daylight Saving, or War Time, subtract line 7 from line 6 and write the Standard Time thus found on line 8. If the birth was timed by Local Mean Time (as was usually the case in Britain before 1880, and in the U. S. before November 18, 1883) line 8 is left blank. Every 15° of longitude east or west of Greenwich is called a Standard Time Meridian marking the middle of a different time zone. In the U. S. the middle of the Eastern Standard Time Zone (EST) is 75° west, the middle of the Central Standard Time Zone (CST) is 90° west, the middle of the Mountain Standard Time Zone (MST) is 105° west, and the middle of the Pacific Standard Time Zone (PST) is 120° west. After the Standard Time written on line 8 should be written the abbreviation for the Standard Time Zone within which birth took place.

Line 9: When the birth was timed by Local Mean Time line 9 is left blank. Otherwise find the difference in °s and 's between the longitude of birth and the Standard Time Meridian of the time zone within which birth took place. Multiply the °s so found by 4 and call the product minutes of time. Multiply the 's so found by 4 and call the product seconds of time. Write the minutes and seconds so found on line 9. If the longitude of birth was east of the Standard Meridian precede this time interval with a plus sign. If the longitude of birth was west of the Standard Meridian precede this time interval by a minus sign.

Line 10: When the birth was timed by Local Mean Time, leave lines 6, 7, 8 and 9 blank and merely write on line 10 the time of birth. Otherwise, if line 9 is plus add to line 8, and if minus subtract from line 8. Write the sum or difference on line 10 crossing out A.M. or P.M. to indicate if the birth was before or after noon.

Line 11: Nothing should be written on this line. The figure 12:00 signifies noon on the day of birth.

Line 12: If line 10 shows the LMT of birth to be P.M. line 12 should be left blank. If line 10 shows the LMT of birth to be A.M. the hours, minutes and seconds so shown should be written on line 12.

Line 13: If the LMT as shown on line 10 is A.M., subtract the hours, minutes and seconds on line 12 from the 12h 00m 00s (noon) printed on line 11, and write the hours minutes and seconds so found on line 13 with a minus sign preceding them. If the LMT as shown on line 10 is P.M., merely copy the hours, minutes and seconds so shown on line 13 with a plus sign preceding them. If a midnight (zero hour) ephemeris is used, before making entry on line 13 add 12 hours (the time interval from midnight to noon) to the hours, minutes and seconds otherwise to be entered.

Line 14: From an ephemeris for the day of birth copy on line 14 the hours, minutes and seconds of sidereal time there given.

Line 15: If line 13, and therefore line 17 is minus and greater than line 14, in order to subtract line 17 from line 14, 24h should be written on line 15. Otherwise line 15 should be left blank.

Line 16: Line 16 is left blank unless it becomes necessary to write 24h on line 15. In these instances the hours on line 15 should be added to the hours, minutes and seconds of line 14 and their sum written on line 16.

Line 17: Copy the hours, minutes and seconds of line 13, preceded by their plus or minus sign, on

Line 18: Add or subtract, as the plus or minus sign indicates, line 17 to or from line 14 (or from line 16 if an entry on it has been found necessary). Write the hours, minutes and seconds so found on line 18.

Line 19: If a chart is desired with house cusps within only one degree of precision, which is close enough for delineating, but not precise enough for calculating progressed aspects involving M.C. and Asc., line 19 may be left blank, and line 18 merely copied on **line 20** But if a chart with all house cusps calculated to the precise ' is desired (see Page 132), before making entry on line 19 it is first necessary to ascertain line 26.

Line 21: If the birth was timed by Local Mean Time, this time, A.M. or P.M. should be written on line 21. If the birth was timed by Standard Time, the words Local Mean should be crossed out and above them written the word Standard. Then the Standard Time of birth, A.M. or P.M. should be written on line 21.

Line 22: If the birth was timed by Local Mean Time the longitude of birth should be converted into hours, minutes and seconds of time by multiplying the °s by 4 and calling the product minutes, and multiplying the 's by 4 and calling the product seconds. The hours, minutes and seconds so obtained should be entered on line 22. If the birth was timed by Standard Time, merely write the number of hours of the Standard Time Meridian used in timing the birth on line 22. If the birth was in east longitude precede the hours, minutes and seconds on line 22 by a minus sign; if in west longitude by a plus sign.

Line 23: As indicated by the minus or plus sign, subtract line 22 from, or add it to, line 21. Designate if the result is A.M. or P.M.

Line 24: Nothing should be written on this line. The figure 12:00 signifies noon of the day of birth.

Line 25: If line 23 is P.M., line 25 is left blank. If line 23 is A.M. it is copied on line 25.

Line 26: If line 23 is P.M., its hours, minutes and seconds are copied on line 26 preceded by a plus sign. If line 25 is A.M., it is subtracted from line 24 (12h 00m 00s) and the difference in hours, minutes and seconds written on line 26 preceded by a minus sign. The minus or plus Equivalent Greenwich Mean Time interval of line 26 is the interval from which the sign, °, and ‘ occupied by each of the ten planets is calculated.

Back to Line 19: Each hour of line 26 is multiplied by 9.86 (approximately 10) and the product is called seconds, and the minutes of line 26 are divided by 6 and the quotient called seconds. The sum of the seconds so found, converted into minutes and seconds, is written on line 19 preceded by a minus sign if line 26 is minus, or preceded by a plus sign if line 26 is plus.

Back to Line 20: If line 19 is minus, subtract from line 18. If line 19 is plus, add to line 18. Write the hours, minutes and seconds so obtained on line 20. This is the Sidereal Time of Birth from which with the aid of a table of houses the sign, degree and minute on each house cusp of the chart may be calculated. If the chart is erected for a place in south latitude, 12h should be added to line 20, using the degrees thus found, but placing opposite signs on the house cusps.

Line 27: Look in a table of diurnal proportional logarithms for the number corresponding to the hours and minutes of line 26. Write this number on Line 27. This logarithm (d) added to the logarithm (a) of the daily motion of the planet on the day of birth gives the logarithm (b) of the °s and ‘s moved by the planet during the interval written on Line 26. If line 26 is minus, subtract the °s and ‘s so found from the sign, °, and ‘ of the planet’s position as given on the day of birth in the ephemeris. If line 26 is plus, add the °s and ‘s so found to the sign, °, and ‘ of the planet’s position as given on the day of birth in the ephemeris. If the planet is retrograde, add if line 26 is minus or subtract if line 26 is plus. The symbol of the planet should be placed in the chart followed by the °, sign, and ‘ so found, which is the zodiacal longitude at the moment of birth.

Line 28: If no progressions are to be worked, line 28 may be left blank. If working progressions is contemplated, the hours of line 26 should be divided by 2 and called months, and the minutes of line 26 should be divided by 4 and called days. If line 26 is minus, the months and days so found should be added to the year, month and day of birth. If line 26 is plus, the months and days so found should be subtracted from the year, month and day of birth. The calendar date so found, including the year, should be written on line 28. This Limiting Date (L.D.) is the starting point in calculating the major progressed positions on any calendar date, and in calculating the calendar date on which any major progressed aspect is perfect.

Finding the Precise ' on Each House Cusp

—If the table of houses does not give the house cusps for the precise latitude of birth, find the precise ' on the Asc. (and other house cusps if desired) for the nearest latitude to that of birth given in the table, then use the CORRECTION OF HOUSE CUSPS FOR LATITUDE OF BIRTH given on page 132. The precise ' on the M.C. is the same for all latitudes.

Find (a) the difference in minutes and seconds between the nearest and the next nearest Sidereal Time to that of birth (entered on line 20) in the table. This is always 4 minutes in American Astrology Tables.

Find (b) the difference in minutes and seconds between the True S.T. of birth (entered on line 20) and the nearest S.T. to that of birth in the table

Find (c) the difference in °s and 's between the same house cusps in the consecutive columns within which the True S.T. occurs for the nearest latitude to that of birth. For the M.C. this is always 1° (60') in Dalton's, AP, Raphael's and RC tables.

By proportion, reduce each term to 's, then multiply (b) by (c) and divide the product by (a). This gives (d) the distance the house cusp is from the nearest similar house cusp given in the table for the nearest latitude given in the table.

By logarithms, subtract log. (a) from log. (b), and to the difference so found add log. (c). The result is log. (d), the distance the house cusp is from the nearest similar house cusp given in the table for the nearest latitude given in the table. As the difference between log. (a) and log. (b) is the same for all house cusps, when this log. is once found, it can be used in finding any house cusps by adding to it log. (c), which may be different NOTE: When the resulting 's are very few occasionally in working a proportion by logarithms the nearest logarithm indicates a result which is 1' different than that obtained by direct proportion. In such instances the result obtained by direct proportion is more precise.

If the true S.T. (entered on line 20) is less than the nearest S.T. given in the table, subtract (d) from the house cusp given in the table. If the true S.T. (entered on line 20) is greater than the nearest S.T. given in the table, add (d) to the house cusp given in the table. This gives the precise ' on the house cusp for the latitude given in the table.

Timing Events Indicated by a Horary Chart

—For their research work during 1948, Elbert Benjamine and W. M. A. Drake undertook to find a more reliable method of timing events by horary astrology. They found, from the analysis of a large number of horary charts in which the time of the indicated event had been recorded after it had transpired, that the trend of a mental

event, such as impels the asking of a horary question about something in which one is deeply concerned, may be judged both as to what will happen and when it will occur in most respects as if the chart were elected for the commencement of some physical enterprise. Possibly because the Moon is chief ruler of the unconscious mind, and a horary question is an event deriving from the unconscious mind, the chief difference is that the Moon is co-ruler of the querent.

If the question involves some event or condition in the future, the timing of this event includes precisely the same factors which would be present in the birth chart of an individual or a physical enterprise at the time such an event occurred. If the birth chart of an individual, a physical enterprise or a horary question indicates that a particular event will not occur, progressed aspects will not bring it to pass. But if the birth chart indicates the event is probable, it will occur only during the period when there is a progressed aspect involving a planet characteristic of the general nature of the event, and a progressed aspect involving the ruler of each house significantly influenced. Such progressed aspects are effective only while within one degree of perfect.

The analysis of a large number of horary charts reveals that an insignificant event asked about—although usually there are also heavier progressed aspects present—may come to pass when each birth chart or major progressed significator merely receives a transit aspect.

To bring a minor event to pass—although usually there are also heavier progressed aspects present—there must be a minor progressed aspect and a transit progressed aspect to each birth chart or major progressed significator.

To bring a major event to pass, there must be a major progressed aspect involving each significator, and at the time it happens there must be a minor progressed aspect and a transit progressed aspect to one of the four terminals of each essential major progressed aspect.

If, when the question is asked, the significators are within one degree of perfect aspect, even though the aspect is separating, the event indicated by the aspect—which may be favorable or unfavorable—usually occurs, and commonly occurs before the aspect separates to more than one degree from perfect, just as in a natal chart the event attracted by progressed aspect may take place either before or after the aspect is perfect, but only while the aspect is within the one degree limit.

The progressed aspects in a horary chart indicate the time and nature of the various events affecting it during its life.

Example of P.M. Standard Time when place is East of Central Standard Time Meridian: Chart 14. The meridian for Central Standard Time is $90^{\circ}W$. $90^{\circ} 00'$ minus $87^{\circ} 39'$ (longitude of Chicago) gives the difference as $2^{\circ} 21'$. Multiplying 2 by 4 gives 8m. Multiplying 21 by 4 gives 84s. The sum is 9m 24s. As the place is east of the standard meridian, this 9m 24s must be added to the standard time to get the LMT of birth.

As the EGMT Interval is plus 8h 30m, the correction of S.T. is plus 1m 24s. S.T. as given in ephemeris for noon, plus LMT Interval, plus correction, gives the S.T. of birth as 6h 59m 45s. House cusps are calculated for this S.T., and the planets' positions for the plus 8h 30m EGMT Interval.

Example of A.M. Daylight Saving Time when place is West of Eastern Standard Time Meridian: Chart 7399. The nearest S.T. given in Dalton's table of houses to the 1h 30m 14s written on line 20 is 1h 28m 52s. The difference (b) is 1m 22s or 82s. The next nearest S.T. given in the table is 1h 32m 38s. The difference (a) between this and the nearest is 3m 46s or 226s.

In the same column for latitude 42 the cusp of the 12th house is given as 7.4 Cancer. As each tenth degree is 6' this is 7 Cancer 24. In the column for the next nearest S.T. the cusp of the 12th house is given as Cancer 8.1, which is 8 Cancer 06. The difference (c) is 42'. Multiplying (b) 82 by (c) 42 gives 3444. Dividing 3444 by (a) 226 gives (d) 15' to add to 7 Cancer 24, giving the 12th house cusp in latitude 43 as 7 Cancer 39.

The difference between the 12th house cusp in latitude 42 and in latitude 43 is .6 or 36'. The difference (d) between latitude 42:43 and latitude 43 is 17'. The difference (c) between latitude 42 and latitude 43 is 60'. Multiplying (a) 36 by (d) 17 gives 612. Dividing 612 by (c) 60 gives 10' correction for latitude to be subtracted from 7 Cancer 39, giving the precise 12th house cusp as 7 Cancer 29.

Travel of each planet during 15 minutes is calculated and subtracted from its noon ephemeris position.

Example of P.M. Standard Time when place is West of Mountain Standard Time Meridian: Chart 16. This is one of the rare instances in which the 's being few a house cusp obtained by direct proportion is 1' different than the same house cusp obtained by logarithms. Using Dalton's table of houses, the nearest S.T. is 23h 52m 40s and the next nearest is 23h 48m 59s. The difference (a) is 3m 41s or 221s. The difference (b) between the True S.T. of birth—23h 52m 24s—and the nearest S.T. in the table—23h 52m 40s—is 16s. For the M.C. (c) is 60', and for the Asc. in latitude 41 (c) is 46'.

Dalton's table of houses gives the minor house cusps to the nearest tenth of a degree, each tenth being equivalent to 6'. On the cusp of the second house the table for latitude 41 gives 7.0 Leo for the nearest S.T. and 6.2 Leo (6 Leo 12) for the next nearest S.T., a difference of 48'. By proportion, multiplying (b) 16 by (c) 48 gives 768. Dividing 768 by (a) 221 gives 3'. By logarithms, subtracting log. of 3m 41s (a) .8140 from log. of 16s (b) 1.9542 gives 1.1402. Adding to 1.1402 log. of 48' (c) 1.4771 gives 2.6173 which is a little closer to the log. of 4' than to the log. of 3'.

Subtracting both the 3' obtained by proportion and the 4' correction for latitude from 7 Leo 00 gives 6 Leo 53. By logarithms it would be 6 Leo 52.

Example of P.M. Standard Time when place is West of Pacific Standard Time Meridian: Chart 7400. The meridian for Pacific Standard Time is 120°W. 122° 26'

(longitude of San Francisco) minus $120^{\circ} 00'$ gives the difference as $2^{\circ} 26'$. Multiplying 2 by 4 gives 8m. Multiplying 26 by 4 gives 104s. The sum is 9m 44s. As the place is west of the standard meridian, this 9m 44s must be subtracted from the standard time to get the LMT of birth.

The nearest S.T. given in Dalton's table of houses to the 16h 43m 10s written on line 20 is 16h 41m 59s. The difference (b) is 1m 11s. The next nearest S.T. given in the table is 16h 46m 16s. The difference (a) between this and the nearest is 4m 17s. Subtracting log. (a) .7484 from log. (b) 1.3071 gives .5587 to be used in getting all house cusps.

Adding log. (c) for the 60' M.C. difference 1.3802 to .5587 gives 1.9389, which is the log. of 'd) 17' to be added to the 12 Sagittarius 00 shown in the table, giving the M.C. 12 Sagittarius 17.

adding log. (c) for the $1^{\circ} 37'$ Asc. difference for at. 38 given in the table 1.1716 to .5587 gives 1.7303, the log. of (d) 27' to be added to the 28 Aquarius 55 given in the table, making the Asc.- 29 Aquarius 22 for lat. 38. Adding the 7' correction for the 13' difference in latitude between 38 and 37:47 gives the Asc. 29 Aquarius 29.

Example of using Midnight Ephemeris for A.M. Standard Time when place is East of Pacific Standard Time Meridian: Chart 7401. The midnight ephemerides are really zero hour ephemerides with positions calculated for the midnight preceding (not following) noon of each given day. Both the LMT Interval entered on lines 13 and 17, and the EGMT Interval entered on line 26, therefore, must be ascertained as from the midnight (zero hour) preceding noon of the day of birth. This may be done merely by algebraically adding plus 12 hours to each of these two intervals as ascertained when using a noon ephemeris for the same date.

The correction of Sidereal Time entered on line 19 must be calculated from the EGMT Interval from midnight entered on line 26, and added to or subtracted from, as its sign indicates, the uncorrected Sidereal Time entered on line 18. The Sidereal Time so obtained, and entered on line 20, is used to ascertain the house cusps in the ordinary way.

The EGMT Interval from midnight entered on line 26 is used to ascertain the positions of the planets at the time of birth, from their positions given in the midnight (zero hour) ephemeris on the day of birth, in precisely the same manner as when using an EGMT Interval from noon with a noon ephemeris.

Example of P.M. Double Summer Time when place is West of Western Europe Standard Time Meridian: Chart 7402. When the time given is Daylight Saving Time, minus 1 hour is written on line 7 and subtracted from line 6 to get the Standard Time to be written on line 8 (see chart 7399). When the time given is Double Summer Time, minus 2 hours is written on line 7 and subtracted from line 6 to get the Standard Time to be written on line 8. In either case when the Standard Time has been ascertained, proceed to erect the chart for this Standard Time of birth in the customary manner.

Subtracting the A.M. 11h 36m EGMT of line 25 from the noon of line 24 gives the EGMT Interval of line 26 (d) as minus 0h 24m, the log. of which written on line 27 is 1.7781.

Subtracting the position of the Moon on July 6, 1945, from its position on July 7, 1945, gives its daily motion (a) as $14^{\circ} 13'$, the log. of which is .2274. Adding log. (a) .2274 to log. (d) 1.7781 gives 2.0055 which is the log. of (d) $14'$ which the Moon has moved during the 24m. Subtracting $14'$ from the noon ephemeris position of the Moon gives its birth chart position as 17 Gemini 57. Use the daily motion of each planet as (a), add its log. to log. (d) 1.7781, and subtract the travel so obtained (b) from its noon ephemeris position.

Example of P.M. Standard Time when place is West of Central Europe Standard Time Meridian: Chart 7403. When the Standard Time Zone is East of Greenwich the correction for mean time on line 9 is plus if the place is east of the Standard Meridian, and minus if west of the Standard Meridian, the same is if the place were in a Standard Time Zone west of Greenwich.

But when the Standard Time Zone is east of Greenwich the number of hours which it is east of Greenwich should be written on line 22 preceded by minus. As Central Europe Time is 1h east, the 1h written on line 22 is preceded by minus, and when subtracted from line 21 gives 5h 00m 00s P.M. on line 23, and plus 5h 00m 00s on line 26.

When the declinations are given only every third day, find the daily motion by declination by dividing the 3 day motion by 3. Use this to find the declination at Greenwich noon on the given day, and the log. (a) of the daily motion added to log. (b), written on line 27, to find log. (d) of its travel through interval and its declination at birth. Due to ununiform travel of a planet, occasionally there is a difference in the declination so obtained. The average daily movement of Mercury by declination between March 16 and March 19, 1920, is $22'$, but its motion between March 16 and March 17 is only $18'$.

Example of A.M. Local Mean Time when place is 19:50 East Longitude: Chart 7404. When the birth is timed by Local Mean Time, write this on line 10 and on line 21. Multiplying 91 by 4 gives 364 minutes. Multiplying 50 by 4 gives 200 seconds. The sum is 6h 7m 20s to be written on line 22. As the place was east longitude it should be preceded by minus. If it were west longitude it should be preceded by plus. House cusps are calculated from line 20, and planets from line 26, in the ordinary way.

House cusps have same declination as Sun when in same sign, $^{\circ}$, and $'$. Therefore, find declination of Sun in 9 Leo 48 as declination of M.C., and declination of Sun in 8 Scorpio 34 as declination of Asc.

August 2, 1920, Sun 17 N 47 is decreasing (a) $15'$ daily by declination. It is 9 Leo 51 and moving daily (c) $57'$ by zodiacal longitude. The difference between 9 Leo 51 and

9 Leo 48 (M.C.) is (d) 3'. Multiplying (a) 15 by (d) 3 gives 45. Dividing 45 by (c) 57 gives (b) 1' to be added to 17 N 47, giving the declination of M.C. 17 N 48.

November 1, 1920, Sun 14 S 26 is increasing (a) 20' daily by declination. It is 8 Scorpio 46 and moving daily (c) 60' by zodiacal longitude. The difference between 8 Scorpio 46 and 8 Scorpio 34 (Asc.) is (d) 12'. Multiplying (a) 20 by (d) 12 gives 240. 240 divided by (c) 60 gives (b) 4' to be subtracted from 14 S 26, giving the declination of the Asc. 14 S 22.

Examples of charts erected for South Latitude: For south latitude both the Sidereal Time written on line 20, and the EGMT Interval written on line 26 are ascertained exactly as if the place were in north latitude. The planets' places are calculated from the EGMT Interval written on line 26 exactly as if the place were in north latitude. But for obtaining the house cusps from the Sidereal Time written on line 20, 12 hours must be added, using the degrees and minutes on the house cusps found from the Sidereal Time thus obtained, but placing signs opposite to those thus indicated on the house cusps.

Chart 7405 has 5h 03m 19s found in the ordinary way written on line 20. Adding 12h gives the Sidereal Time as 17h 03m 19s. Calculating the house cusps in the ordinary way gives 16 Sagittarius 57 on M.C. and 10 Pisces 15 on the Asc. But instead, the same ° and ' of the opposite signs must be used, giving 16 Gemini 57 on the M.C. and 10 Virgo 15 on the Asc. The minor house cusps are handled in the same way.

Chart 7406 has 1h 57m 05s found in the ordinary way written on line 20. Adding 12h gives the Sidereal Time as 13h 57m 05s. Calculating the house cusps in the ordinary way gives 1 Scorpio 25 on the M.C., and 11 Capricorn 17 on the Asc. Using opposite signs gives 1 Taurus 25 on M.C. and 11 Cancer 17 on Asc. Minor house cusps as shown.

Book 9

Copyright
August 2002
Church of Light

Mental Alchemy

Chapter 1

Serial No. 95
Original Copyright 1936
Elbert Benjamine

Copyright
Church of Light
August 2002

The Inner Nature of Poverty, Failure and Disease

Chapter 1

The Inner Nature of Poverty, Failure and Disease

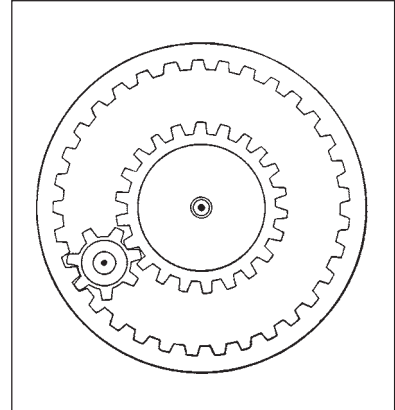

SO WIDELY RECOGNIZED has become the power of the mental attitude markedly to alter the conditions of physical life that one can find outstanding examples in almost any community. Few people are unacquainted with someone who has been cured of a bodily complaint, who has overcome a domestic trouble, or who has rapidly remedied a financial deficiency through the application of right thinking. Dozens of books have been written on the cure of poverty, on the triumph over failure, and on the attainment of wealth through mental methods; and the enormous sale of these books attests to the faith of a large section of the public in such doctrines.

Yet the careful investigator looking for unprejudiced evidence of the advantages to be derived from applying these doctrines can not help being struck by the fact that there are quite a number who claim to have followed rigorously the prescribed method who have received no benefit whatsoever.

Nor when we stop to think of it, could we expect anything else. No two people are the same, either in appearance, in the chemistry of their physical bodies, or in the thought structure of their astral forms. Every individual, being different from every other individual, presents a separate and individual problem. Yet in the popular methods of mental healing and spiritual healing—to mention but two of the names given to what is essentially the same process—the identical prescription is given to all who suffer from the same disease.

When it is considered how widely people vary one from the other, the wonder is that those who treat themselves, and those who give others absent treatment, have the amount of success they do from applying such happy-go-lucky methods. The undeniable fact that so many good results are obtained from haphazard procedure suggests wonderful possibilities for correcting human ills when right-thinking is applied in a truly scientific manner.

Physical foods, sunlight, rest from exertion, bathing and other material remedies can be applied scientifically and with best results only when there is detailed knowledge of the idiosyncrasies of the individual who is to be treated. The Battle Creek Sanitarium, for instance, by experimental checking has found that there is no single

article of human diet which is not poisonous to some individuals. The nerves of other persons can stand very little sunlight. Only a little bathing exhausts the vitality of others. And the matter of assimilation the experimental biologist sums up thus:

“The chemical elements of the outer world act on each individual in different ways, according to the specific constitution of his intestinal mucosa.”

Now the mind is an organization of thought-cells and thought structures in the astral body. It is nourished and built up by the experiences that it assimilates. Yet even as biologists find that the physical human body reacts according to the individual's special chemical composition and physiological adaptations; so we may be sure that the four-dimensional body, the organization of which constitutes the soul, the character and the mind, will react to a given thought or to a given thought treatment, not according to some rigid universally applicable standard, but according to its own special composition of mental elements, their combination, and the conditioning processes to which their past has subjected them.

If we are to attain to uniformly satisfactory results in the application of mental treatment either to ourselves or to others, we must have a detailed knowledge of the physiology of the unconscious mind, that is, of the astral body. We must learn how the mental chemistry of one person differs from that of another, and what effect will be produced by adding to it thought food of a particular kind in the process of mental treatment.

All Thought-Elements Are Built of Reproductive Desires and Nutritive Desires

—As set forth in Course 5, the unconscious mind, character, or soul, is the organization in the astral body. It is composed of psychoplasm, even as the physical body is composed of protoplasm and its secretions.

This psychoplasm, even as is true of the physical protoplasm, is composed of elements combined in compounds. All the thought-elements comprised in the psychoplasm of the astral body are, in turn, built up of the two primitive desires, the Nutritive Desire and the Reproductive Desire, which in turn are the negative and the positive expression of the Desire for Significance. That is, even as all 92 chemical elements are built up of electrons and protons, so are all the thought-elements built up of Nutritive Desires and Reproductive Desires.

Experiences and the accompanying states of consciousness organize the psychoplasm into cells—four-dimensional stellar-cells—which are analogous to the cells of the physical body. And these stellar-cells, or thought-cells as they also are called, are further grouped by the conditioning process of feeling into stellar structures. The cells and structures of the four-dimensional body are called “stellar” because the four-dimensional substance of which they are composed is readily acted upon by planetary energy, and the word astral means pertaining to a star. But, as to

become efficient in the use of thought for healing purposes we must have detailed knowledge of the four-dimensional body, before we discuss these more complex mental factors we should become familiar with the thought-elements.

Psychoplasm Is Built of Thought-Elements

— The chemistry of today classifies matter into 92 distinct elements. Each of these elements is given an atomic number, originally determined by its weight and only recently discovered to correspond to the number of electrons revolving, planet-like, around the nucleus. The nucleus of an atom consists of positive charges of electricity. The electrons are negative charges of electricity. And when I say that the atomic number of a chemical element represents the number of electrons, I mean that as Hydrogen is number 1 in the atomic table it has one electron revolving around its nucleus, as Helium is number 2 in the atomic table it has two such revolving electrons, as Lithium is number 3 it has three such revolving electrons, and so on up through the known elements to Uranium, which has 92. It is this number of electrons revolving like planets outside the nucleus which determines the chemical properties of the element.

Now we know that all the thought-elements are composed of Nutritive Desires and Reproductive Desires in a four-dimensional arrangement somewhat corresponding to the arrangement of the electrons and protons comprising the three-dimensional chemical elements. But we are not at present in a position to say in terms of valence or number how many units of Negative Desire are making their revolutions about the nucleus of Reproductive Desires in any of the mental elements.

The elements of chemistry are commonly arranged in a periodic table, which—even as once there were only seven planets known—when first formulated classified all the elements under seven groups; the elements of each group, or family, having properties in common. Then the original table of Mendelejeff was widened to embrace eight families, and finally, as the result of new discoveries was brought up to nine families. “Essentials of Chemistry,” by John C. Hessler, Ph.D., assistant director Mellon Inst., Pittsburgh, and Albert L. Smith, Instructor in Chemistry, the Englewood High School, Chicago, published in 1920 gives 9 families. This also was the number of astrological planets then known. But the discovery of Pluto in 1930 now gives the Sun 9 known planets, or ten astrological orbs.

In that text-book of chemistry, and in other late ones, the elements not only group themselves into families, but there is a division of each family into 12 series, or compartments, that show the properties of each family when these are exhibited by an element at different heights in the scale of atomic weights.

The time may come when it will be possible to say that a thought-element belonging to a certain family and to a certain series corresponds to the element hydrogen, another thought-element corresponds to nitrogen, and so on throughout the entire range of the 92 chemical elements. But such effort is as yet premature. Yet we do

know that the thought-elements arrange themselves into 10 distinct families which correspond strictly in vibratory quality to the vibrations of the 10 planets. And we know quite definitely from much experimental work in our Research Department, that a thought-element corresponding to any one of the 10 families can express with a resonance which relates it definitely to one of the 12 zodiacal signs.

The feeling, I AM, gives any thought, whatever its family, a resonance and therefore a trend of activity quite different from that given it by the feeling, I HAVE, the feeling, I THINK, the feeling, I ANALYZE, or any one of the other 12 in the series. The type of activity of any thought family, its essential vibratory rate, is retained no matter to which one of the series of 12 it belongs. But the method employed in its activity is determined by the one of the series to which its particular resonance relates it.

In lesson No. 40 I have shown that all physical substance is inter-penetrated by astral substance, and that there is a continuous interchange of energy between these two substances through the ability of each to impart motion to the ether. In lesson No. 52 I have shown, further, that a thought is an organization of astral substance. And in lesson No. 53 I have explained that intelligence in some degree inheres in all substances. In further corroboration of this view I can cite the "N-Ray" researches of the eminent French scientist, M. BeQueerl, and the scientific experiments of Jagadis Chunder Bose, Professor Presidency College, Calcutta.

In his book, "Response in the Living and the Non Living," Professor Bose shows that a bar of metal is irritable and sensitive somewhat like the human body, and that it may be poisoned or killed much as may a human being. His extensive experiments with plants are given in a volume entitled, "Plant Response." In regard to such response he says in his communication to the Royal Society, May 7, 1901:

"An interesting link, between the response given by inorganic substances and the animal tissues, is that given by plant tissues. By methods somewhat resembling that described above, I have obtained from plants a strong electrical response to mechanical stimulus. The response is not confined to sensitive plants like Mimosa, but is universally present. I have, for example, obtained such response from the roots, stems, and leaves of, among others, horse chestnut, vine, white lily, rhubarb, and horse-radish."

His later experiments, including those with animal tissue are described in his volume, "Comparative Electro-Physiology," from which I quote the following:

"Experiments have been described showing that the response of the isolated vegetal nerve is indistinguishable from that of animal nerve, throughout a long series of parallel variations of conditions. So completely, indeed, has that similarity between the response of plants and animals, of which this is an instance, been found, that the discovery of a given responsive characteristic in one case has proved a sure guide to its observation in the other, and the explanation of a phenomenon under the simpler conditions of the plant, has been found fully sufficient for its elucidation under the more complex circumstances of the animal."

The reason a living bar of metal, a living plant and a living animal or a living man gives responses to stimuli that are similar, except in degree of complexity and degree of intensity, is that the reaction of any life-form to an environmental condition is determined by the manner in which the desire energy of the thought-cells in its astral body has been conditioned.

Thought-Elements Are the Only Food the Astral Body Can Assimilate

—Every living thing possesses an astral body. This astral body has been built by the states of consciousness the various life-forms have experienced, through which the evolving soul, or unconscious mind, has passed thus far in its evolution. That is, as the experimental work just cited proves, all living things, even rocks so long as they are alive, are capable of some degree of feeling. It is this feeling acquired through past experiences that enables the form to respond in the manner it does, no matter how slight the degree, to changes in its environment. The feeling is a state of consciousness. And it is built into the stellar-cells of the astral body of the life-form as a tension, or desire, which conditions, or gives direction to, responses to similar situations in the future.

The life-form of every living thing thus possesses an unconscious mind, or soul, which is the organization in the astral body of the total experiences through which the soul has passed up to that stage. The astral body of any life-form is a thought-built body; states of awareness being the only food that can be assimilated by the four-dimensional form. Using the word thought in its more general significance to include any feeling, or state of awareness, each experience builds thought-elements thus into the astral body.

These thought-elements, as already indicated, belong to 10 different families which may have trends indicated by 12 different series. The series to which a thought-element belongs determines, when it is assimilated, to which zone of the astral body it will move. If it belongs to the I AM (1st) series it moves to the zone represented by the head. If it belongs to the I HAVE (2nd) series it moves to the zone represented by the throat. If it belongs to the I USE series (10th) it moves to the zone represented by the knees. For although head, throat, knees and feet are not actually present in the lower forms of life, nevertheless, their astral bodies have corresponding zones.

Assimilated Thought-Elements Move to the Proper Compartment

—Now bear in mind that there is an additional dimension on the four-dimensional plane. Thus also, in addition to 12 zones in the astral body, which have affinity with the 12 zodiacal signs, the astral body has 12 distinct compartments. Each compartment has an affinity with one department of life—that is, with health, with

means of acquiring sustenance, with home and shelter, with offspring with illness and work, etc. And the thought-elements of an experience when they enter the astral body are added to the psychoplasm of the particular compartment relating to their source of origin. If the experience relates to means of acquiring sustenance, such as money in a human experience, the thought-elements thus acquired are built into the structure of the 2nd compartment of the astral body. If the experience relates more directly to food, it is built into the structure of the 6th compartment of the astral body. Or if it has to do with a secret enemy or sorrow, it is built into the 12th compartment of the astral body.

Yet thought-elements when built into the astral body do not remain in the state of simple elements, no more so than when food is assimilated by the physical body do the chemical elements remain uncombined. In both cases the elements combine with other elements in the formation of compounds; these compounds in one instance forming the protoplasm of the physical body, and in the other forming the psychoplasm of the astral body. And in both the formation of protoplasm and the formation of psychoplasm, the manner in which the elements enter into such compounds as are formed is very important.

Harmonious and Discordant Mental Compounds

—All life-forms, from the simplest to the most complex, possess some ability to learn through experience. The feeling coincident with one experience is retained and has an influence upon the conduct when the organism is again brought into contact with a similar situation. This process through which all life-forms learn, being attracted by pleasure and repelled by pain, the psychologists call **CONDITIONING**.

According to the family and the series to which it belongs, each thought-element has its own type energy. It may belong to the family of Aggressive thoughts, in which case it possesses aggressive energy. It may belong to the Religious thoughts, and thus possess genial expansive energy. Or it may belong to any other of the 10 families of thoughts and possess energy of that characteristic type.

Yet the thought or sensation that gave rise to the mental element, whatever its type, also contained, in some degree, feeling energy. By means of the cyclotron at the present time in the University of California at Berkeley, and in other university laboratories, energy is actually converted into chemical elements of matter. Likewise the processes of consciousness convert mental energy into the thought-elements of which the astral bodies of all living things are composed. Yet accompanying this process there is always present, in some degree, the feeling of pleasure or pain, harmony or discord, which forms the **CONDITIONING ENERGY**.

It is this Conditioning Energy which is present at the time a thought-element is formed that determines the manner in which the thought-element, when it is assimilated by the astral form, combines with other thought-elements already there or which are assimilated at the same time.

There are 10 different manners in which almost any two of the thought-elements can combine, each method of combination being wholly determined by the quality of Conditioning Energy, or feeling, present when the thought-elements meet. This Conditioning Energy thus entering into the thought compound gives a specific trend to its desire. Desire is energy in a potential state straining to be released in a given activity; and a large part of the tension of a thought compound that thus seeks release in some activity is due to the pleasure or pain that was present when the thought-elements combined. Thus each of the 10 types of thought compounds, irrespective of the elements united in it, is given a name which designates the direction in which its desire energy strives for release.

A Separation Compound, for instance, is a union of thought-elements which has been so conditioned at the time they united in the astral body that their desires strive to express, and do express to the extent they have or acquire energy, in the direction of shoving things apart. A Luck Compound, on the other hand is a union of thought-elements which has been so conditioned at the time they united in the astral body that their desires strive to express, and do express to the extent they have or acquire energy, in the direction of those events we call good luck.

These thought compounds form the psychoplasm, which thus varies in different compartments of the astral body, and forms the substance of the various kinds of stellar-cells. That is, even as in the physical body there are nerve cells, cells that form the skin, cells that become the white blood corpuscles, reproductive cells, muscle cells, and so on, so are there cells of different kinds making up the astral body, their nature determined by the thought compound forming the psychoplasm entering into their composition.

Both Physical Cells and Stellar-Cells Have Independent Intelligence

—Every mental state, as psychologists have been at much pains to prove, is accompanied by an alteration of the physical body. Whether the objective consciousness is, or is not, aware of the tensions of desire energy in the thought-cells and in the thought structures of the astral body, these have an influence on the physical cells and upon the performance of more complex physical functions.

These stellar-cells of the astral body are not unintelligent. They retain whatever intelligence has been imparted to them at the time of their thought formation. In the association of the astral body with the lower forms of life before it reached the human stage, these stellar-cells and the stellar structures built of these stellar-cells, learned to perform certain activities. And as they now exist in the human astral body they continue to possess this ability acquired in the past. The physical human body commences with a single fertilized cell. This physical cell divides into two. Then each of the two again divides, and so on, until all the cells and humors making up the physical body are present.

Now although each of the billions of physical cells is derived from a subdivision of the single cell with which the body elaboration commenced, each type of cell as soon as it is thus formed through subdivision, knows exactly the function it is to perform in the human structure. The cells know what they are to do, and even if separated from the body, endeavor to carry out their special work. That is, both physical cells and stellar-cells, once formed after the pattern of a particular compound, have, and exercise, an intelligence that is independent of the body of which they form a part.

That physical cells exercise such independent intelligence has been demonstrated in laboratory experiments. White blood corpuscles, called leukocytes, will devour microbes and red corpuscles when living in a flask with the same energy they thus act to defend the organism against invading enemies while living in the human blood stream.

Epithelial cells are those that protect the organism from contacts with the outside world, such as the skin and the lining walls of the intestines. These cells have been cultivated for months, quite apart from the animal to which they belonged. There was no surface to protect; yet they understood their special job, and arranged themselves in a mosaic which would have protected a delicate surface if such had been present.

A few red corpuscles permitted to flow from a drop of blood into a liquid plasma, quite outside the body or blood stream of any animal, form a tiny stream which builds up banks either side of their flow. These banks cover themselves with filaments of fibrin, thus forming a pipe, through which the red cells move just as if in the blood vessel of an animal. Leukocytes come to the pipe and surround it with their membrane. Quite isolated from any living animal, red and white corpuscles thus know how to construct, and do construct when conditions permit, a segment of circulatory apparatus. No tissues to be furnished with oxygen and nutriment are present, nor is there a heart nor any real circulation. Yet the stellar-cells in association with these physical cells release their desire energies in the direction of performing the kind of work they have learned in the past; and toward which they have been conditioned.

Most organs of the body, also are capable of independent displays of intelligence. Our stomach, heart, liver, etc., are not subject to our voluntary control. By willing to do so we can not increase or decrease the caliber of our arteries, make our pulse beat fast or slow, nor regulate the contractions of our intestines. They are under the control of the unconscious mind. They obey its orders to the extent they have been conditioned to do so. But the exercise of the particular function they have learned to do is not dependent upon the unconscious mind. They have intelligence of their own which makes them capable, if wrongly conditioned, of rebelling against the orders of the unconscious mind, and which enables them, when severed from the body, yet given proper conditions, of still performing the function which they have learned correctly or incorrectly to do.

An intestinal loop, for instance, when removed from the body and provided with artificial circulation, performs its normal movements. A kidney the nerves of which

are cut, grafted to permit it opportunity for its particular work of filtering the impurities from the body, still performs this essential function.

If we are to have the detailed knowledge for the practice of Mental Alchemy, by which through proper thinking, the various ills of human life can be corrected, we must understand thoroughly that either a group of physical cells or a group of stellar-cells has a certain dependence upon the physical organism or astral organism of which it forms a part, yet at the same time also has the power of exercising its own particular type of intelligence apart from that organism. And we must understand that a physical organ, or a stellar structure composed of thought-cells, likewise performs its function as a part of the organic whole, yet is capable of doing the work for which it has been conditioned quite apart from the organism, and even in defiance of the desires of the organism.

Thought-cells or physical cells which are conditioned in that direction do work which is beneficial to the organism as a whole. Yet stellar-cells or physical cells which are conditioned to act in a manner derogatory to the organism as a whole, work for its destruction quite as energetically as they would have worked for its preservation had they been properly conditioned. The white blood corpuscles called leukocytes, previously mentioned, are the policemen of the body. They consume degenerating tissue and destroy foreign bodies in the tissues such as bacteria. Yet when wrongly conditioned by the presence of certain viruses—which are hardly larger than a molecule of albumin, and therefore make bacteria seem gigantic in comparison—these same leukocytes turn cannibal and devour the cells of muscles and organs and thus kill the infected animal in a few days.

Stellar-Cells and Stellar Structures

Work On Two Planes

—Stellar-cells and stellar structures have a dual field of operation. As the thought-cells and thought groups of which the unconscious mind is composed, they control all the activities of the body, even the manner in which tissue is replaced through physical metabolism. Those activities which are volitional engage the cooperation of the stellar structures in the astral body which have charge of these movements. That is, these thought groups in the four-dimensional form have become conditioned to act upon commands received from the region of objective consciousness. Through their exercise of complete control over all the physical activities the stellar-cells and stellar structures operate in the three-dimensional realm.

But in addition to this direct three-dimensional control, there is a less obvious, yet even more potent control of the life exercised by activities operating from the four-dimensional plane. Thought-cells and thought structures, like physical cells and physical organs have independent intelligence and capacities for independent action. And they work thus from the vantage point of the four-dimensional plane to bring

into the life such events and conditions as correspond to the way they have been conditioned.

Not only, therefore, are all man's physical activities determined by the thought-cells and thought structures which make up his unconscious mind, his soul, or his character; but every event and circumstance that comes into his life not due to his physical actions likewise is due in large measure to the four-dimensional activities of these stellar-cells and stellar structures. Thus is the thought organization of his astral body responsible both for what a man does and for the events that come into his life.

If, therefore, the habitual actions of any person are to be changed, or if his fortune in any respect— health, finances, affections, honor, or what not—is to be changed, he must alter the thought composition or thought organization of his astral body. To the extent the four-dimensional stellar-cells and stellar structures are altered will they release their desire energies along new paths, both on the four-dimensional plane and in prompting three-dimensional activities. It is the province of Mental Alchemy to indicate what changes should thus be made, and how best to make them, to correct the various ills that hamper life.

Thought Compounds Conditioned By Pain Are Responsible For Disease and Misfortune

—If some condition of life is thus to be corrected through the application of the proper thought remedy, the first step is to understand just what thought compound or thought structure in the astral body is responsible for the condition to be changed. Without such knowledge, if, like much metaphysical practice, we merely assume that a certain affirmation will alleviate the disorder, we are quite likely, through adding more energy to the thought organization responsible without changing it, merely to aggravate the condition.

Those thought compounds into which at the time of their formation was built the conditioning energy of pain, strive to release that energy in a similar manner. Their desires are as strong as the energy imparted to them through experiences coincident with their formation. But because they have been formed in a given way, the Law of Association makes it easier, and thus more pleasant for them, to release their energies in channels that are not in the direction of the welfare of the organism as a whole.

As explained in lesson No. 63, desire energy releases in the direction of whatever image is before the attention of the unconscious mind. Yet if the desire energy is discordant, it tends to attract the attention of the unconscious mind, or of thought groups in the unconscious, to images the opposite of those conducting to the welfare. It is easier to express discordant energy in the direction of discordant action, and to express harmonious energy in the direction of harmonious action. And all the ills of life are due, either to insufficient desire energy in the unconscious mind, or to the desire energy that is in the unconscious mind expressing, either on the

four-dimensional plane or on the three-dimensional plane, toward mental images that are discordant to the individual.

An unsatisfactory condition in the life, therefore, may be due to insufficient desire energy stored in the stellar-cells and stellar structures of the astral body. In this case there is simply not enough power to attract anything important, either fortunate or unfortunate. Not enough experience has added energy to the thought-cells. And thus the only way to attract more important events is to acquire experiences that will build, with the thought-elements added, more feeling into the astral body.

Disease, and all more active types of misfortune, however, are due to the three-dimensional and the four-dimensional activities of thought-cells and thought structures in the astral body which have been so conditioned that they find it easier to release their energies in working for conditions that are adverse to the individual. The thought-cause varies with the type of misfortune attracted. And, as will be set forth in lesson No. 96, we have quite definite information as to the type of thinking that is responsible for each of the common diseases and misfortunes.

This is the place, therefore, instead of discussing specific diseases, to emphasize that thought-conditioned desires, whatever their nature, are so much energy within the astral body, which if it can be Reconditioned, or directed toward mental images that conduce to the welfare of the individual, has determining power over the life.

Examples of Compensations

—When one organ or member of the body is destroyed the thought-cells within the astral body transfer their energy, in so far as they can, to some organ or member. If a leg is removed, for instance, the remaining leg grows much stronger than normal, in the effort to compensate for the loss. Or if one kidney is removed, the other one grows almost to twice the normal size, in the endeavor to perform the function of both.

Likewise, as explained in lessons No. 62 and No. 63, when one of the three Hereditary Drives or any other highly energized desire is blocked in its customary expression, it seeks and finds some substitute outlet. The desire energy of such an intense thought organization within the astral body is then said to COMPENSATE for its lack of opportunity to express in the manner desired by its thought group.

One group of thought-cells may be set against another group of thought-cells, causing an inner conflict. And when there is such inner strife, either, as explained in lesson No. 62, the individual Resolves the Conflict, perhaps through Sublimation, or as explained in lesson No. 60 he builds into himself a Repression which, as explained in lesson No. 63, forms a Complex. Such a Complex, not being able to release its energies as it desires, is forced to release them through some Compensating device.

Analyzing the manner in which Americans differ from other nationalities, Harvey O. Higgins and Edward H. Reede, M.D., have shown that American superiority in business and industry, and lack of superiority in literature and art, is due to a Puritan civilization which forced the conviction into the unconscious mind that any

expression of emotion (which is essential in artistic production) is undignified, and that both idleness and pleasure are sin. The Drive for Significance opposed such expressions so successfully that the Reproductive Drive was forced to find a channel of Compensation that was acceptable to this drastically imposed code of conduct.

When conflicts are not Reconciled the energies are not Sublimated, and although they escape by a substitute channel, this furtive slipping past the dominating group of ideas in disguise is accompanied by anxiety, fear and irritation. To this is attributed the proneness of the American to “bluff,” and his attitude of self-reliance and sensitiveness to foreign criticism. They are the natural make-believe compensations of the unconscious mind to a fear of inferiority induced by the teaching that he must conquer and suppress his instinctive desires. Americans, there can be little doubt, are victimized by haste, restlessness, anxiety and worry because of a psychic insecurity (expressing the Drive for Self-Preservation) developed through the religious doctrines of sinfulness.

These writers, analyzing the life of Theodore Roosevelt, indicate how two factors of his infancy so impressed themselves upon his unconscious mind as to dominate his whole life. The first of these factors was his idealization of, and love for, his father. He saw in his father a man of great might who stood fearlessly against the whole world. This image became so strong and so associated with pleasure that it tended to keep the attention of his unconscious mind riveted to it, with the result that whatever desire energies were released were diverted into channels leading to a realization, on his part, of that ideal.

The other factor was his early physical inferiority. The Moon (thoughts) opposition to Mars in his birth-chart gave him weak eyes, and Sun (thoughts) opposition Pluto impaired the vitality (see birth chart at front of lesson). Thus he developed an inferiority complex, a fear of cowardice, of weakness and of inefficiency.

A person with an inferiority complex always Compensates in some manner, because, as set forth in lesson No. 63, the unconscious mind will never relinquish the thought that in some respect it is superior. Pluto, the planet of drastic action, of dictatorship, of the “big stick” (an expression coined to express the drastic way in which Roosevelt enforced his decisions) is in the house of his father (4th), making powerful aspects. It rules the Universal Welfare thoughts, and thus did the ideal of his father, working for the benefit of the people (Moon sextile Pluto) become the model image through which his Compensating energy found expression.

To demonstrate that he was not the coward he feared to be, he learned to fight, became a cowboy, a wild west sheriff, a rough rider, and went on perilous trips of exploration and in pursuit of dangerous game. Of course, he was truly a brave man. But a complex, because of the emotional energy it contains, always tends to over-compensate. He was always seeking some opportunity to prove both his courage and his superiority, going far out of his way in such quests. Yet the father image was powerful enough to determine the line of Compensating outlet for the dammed-up energies. And the desire energies in the stellar-cells and stellar

structures of his astral body thus released were powerful enough that they carried him to the top in literature, as an authority on navy matters, as a naturalist, and into the chair of President of the United States.

Contrast this mode of Compensating for an inferiority complex with that of Mark Twain. He also was a child of inferior powers, but with a very different environment. His early life, instead of having before it an ideal to worship, a father with whom there was sympathy and understanding, was strikingly lacking in these respects. The fear of an avenging deity was early implanted in the boy's mind. Instead of an ideal of courage to stimulate emulation, he was confronted on every hand by examples of fear and failure.

Like Roosevelt, he sought to escape the restrictions placed upon him by physical inferiority, but the method of Compensating was different because of the images toward which his unconscious mind had been conditioned to give attention. He had early found that cleverness of speech gave him an advantage over his associates. Saturn (See his birth-chart at front of lesson) rising, representing powerful Safety thoughts in his astral body did not impel him to prove himself brave, as did Roosevelt, who had Mars, representing powerful Aggressive thoughts, rising. On the other hand, they led him to seek superiority through less dangerous channels.

Later in life, when he sought to attack authorized conventions, which was his method of Compensating in the release of energies stored up in his childhood through the tyranny exercised over him, he did not revolt openly as a more courageous man might have done. On the other hand, still dominated by the timidity forced into his unconscious through fear of everlasting punishment, he used his wit to flay such restrictions.

In his frantic effort to Compensate for his feeling of inferiority and the imminent disaster which his early religious training had implanted, Mark Twain's mind had early found an outlet through wit. He never reconciled his conflicts; but the energy released in Compensations was directed into images that led, not to utter futility, but to preeminence in the field of humorous writing.

Another man with repressions of a different sort was Billy Sunday. Four planets rising in the sign of sex, Scorpio, indicate tremendous energy in the Reproductive Drive. The Aggressive thoughts and the Religious thoughts (See his chart in lesson No. 96) were amalgamated, as indicated by the close conjunction of Mars and Jupiter; and both were almost exactly in opposition to Pluto, lord of the underworld, who in one aspect presides over heaven and in the other dominates the realm of hell.

This opposition from the Universal Welfare thoughts, ruled by Pluto, to Sunday's Personality (Asc.); and to the thoughts indicating on the one hand intense animal passions (Mars) and on the other intense religious devotion (Jupiter) was a terrific conflict between two well organized groups of desires. The Religious thoughts succeeded for the most part in preventing the Reproductive desires from expressing in the manner they craved. Yet throughout life the conflict raged; a conflict which Sunday projected from himself to the outward world. The sense of sin he felt within,

as he sensed carnal impulses which his desire for significance refused to admit belonged to him, seemed to be the sinfulness of others.

He was able to repress his reproductive desires, and the desire to destroy, mapped by Mars, from expressing in a recognizable way. But these same energies found a Compensating outlet through a lifelong struggle with the devil, a very personal devil, with whom Sunday could fight and vanquish before vast audiences. All the physical and mental violence stored in his thought structures disguised as working for Universal Welfare, could thus get past the dominating Religious-thought group, and find expression. On the rostrum these Religious thoughts applauded loudly when he coined unusual phrases to tell the devil just how mean he was; and their approbation knew no bounds when, wet with the perspiration of the tenth round, he flashed a quick right to old Satan's jaw, and knocked him out for the count.

Sunday gave a vast amount of attention to the devil; but his unconscious mind had the image of victory even more persistently before its attention. The release of desire energy, therefore, gave the devil image less power than the victory image. He would say that a man could slip back into hell with one hand on the door of heaven but in his own unconscious mind was the image that, nevertheless, Billy Sunday would triumph.

The noted evangelist never Resolved his Conflict, but he Compensated in a way that led the energies of his inner strife to perform a type of work in which, although such work is demoralizing to the race, he gained renown. The same tremendous energies, better understood as to their source and nature, could have as easily been diverted to a far, far more useful purpose.

Likewise those thought energies stored in the stellar structures of other people which, because they have entered into discordant compounds, manifest as poverty, failure and disease, when better understood, can be led through Reconditioning, to express not through some inferior Compensating device, but through acceptable and constructive channels which will manifest as abundance, success and health. This is the task of Mental Alchemy.

Chapter 2

Serial No. 96
Original Copyright 1937
Elbert Benjamine

Copyright
Church of Light
August 2002

Just How to Find the Thought Cause of Any Condition

Chapter 2

Just How to find the Thought Cause of Any Condition

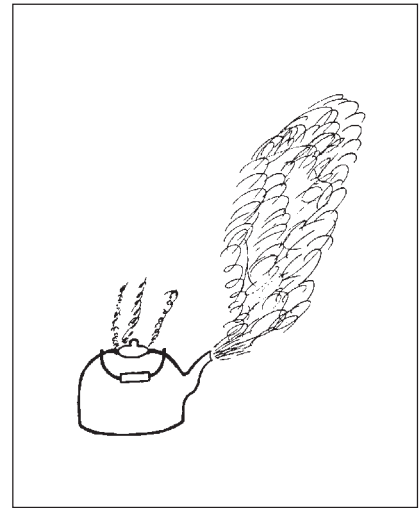

WHATEVER conditions, fortunate or unfortunate, are in the life have been attracted through three-dimensional activities prompted by, or the four-dimensional work of thought-cells of definite compounds within the astral body. If we are ever to have a different type of fortune in any department of life—health, finances, affection, honor, etc.—the compound of thought-elements within the stellar-cells affecting that department of life must be changed. And if we are to proceed intelligently toward making such changes in the psychoplasm and stellar structures of our astral bodies as will restore health or attain some particular type of fortune, we must first have detailed knowledge of the thought-cause of the condition to be remedied or augmented.

We now possess, as the result of a vast amount of work accomplished by the Brotherhood of Light Research Department, quite specific knowledge as to the thought-cause of most diseases of the physical body, and a wide variety of other conditions to be observed in human lives.

The planets by their house positions in a birth-chart map the family of thought elements that have been built into the astral body in association with each of the twelve distinct departments of life. They thus show what thought-elements up to the moment of birth have been built into the stellar-cells of the astral body in such a manner as to determine the kind of events and conditions that will be attracted into the life in each domain of its activities.

The planets are not responsible for the events and conditions attracted. It is easier for a child to be born when the streams of astral energy from the planets are such, as indicated by their positions in the sky, that they flow through—rather than crosswise of—the stellar-cells and stellar structures of the child's astral body. The child is born when the astral currents of his environment, as shown by the birth-chart, correspond as closely as practicable, to the thought compounds and thought structures of his astral body.

Each of the ten planets in the birth-chart maps the chief structure in the astral body of one family of thought-elements. The aspects between the planets reveal which

thought-elements have entered into combination, one with the other, in the formation of compounds, and how these compounds have been formed. The prominence of a planet in the birth-chart shows the amount of desire energy possessed by the thought-cells and thought structures it maps. And the amount of desire energy thus shown indicates how much work, both three-dimensional and four-dimensional, the thought group is capable of, and consequently how important will be the events which it brings into the life.

The planet Saturn, for instance, maps the Safety thought-elements. Whatever house of the birth-chart he occupies relates to poverty. If he is in the house of money it indicates that the Safety thought-elements are chiefly centered in the 2nd compartment of the astral body, which has to do with personal possessions. But Saturn is not responsible for the tendency to poverty thus mapped; for other persons familiar with such an individual will invariably be able to observe Safety thinking as a dominant habit of this individual in matters pertaining to personal property. While its influence from the four-dimensional realm is more pronounced, nevertheless, even in his objective thinking and habitual actions close acquaintances can not fail to note, where money is concerned, the Safety attitude.

Jupiter, on the other hand, maps the Religious thought-elements. Whatever house of the birth-chart he occupies relates to abundance. Thus if he is in the house of money it indicates that the Religious thought-elements are chiefly centered in the 2nd compartment of the astral body. But Jupiter is not responsible for the abundance. The Religious thought-elements in the compartment of the astral body relating to personal property are responsible for it. And any close acquaintance of an individual with this position in his chart can not help but notice, even in his objective thinking and habitual attitude toward money matters, the expansive, optimistic viewpoint characteristic of the Religious thought-elements.

To thus find, through observing the individual's habitual thinking, the cause of his disease is a laborious process. It is far more convenient, especially as the thought-cause of most conditions have already thus been worked out in considerable detail, to consult his birth-chart.

The positions in a birth-chart which indicate a predisposition toward a given condition or event are called the birth-chart constant. Each birth-chart constant really maps the thought compounds and their relations in the astral body at birth, which if later given additional thought-energy bring the condition or event into the life. A Birth-Chart Constant is the thought organization of the astral body at birth which gives a predisposition toward some particular disease or some particular fortunate event.

The events themselves, to the extent they are noticeably either more fortunate or less fortunate than the normal trend of the life, are attracted only at such times as the thought-cells relating to the department of life affected receive new energy. This new energy gives the stellar-cells thus involved additional power to work from the

four-dimensional plane, to stimulate objective thoughts of a similar nature, and to influence the physical conduct.

The more common sources of such additional energy supplies are mapped by the progressed aspects of the planets. Planetary energy picked up, radio fashion, by the aerial developed across the astral body when a progressed aspect is formed, is made available for the use of the thought-cells and stellar structures at the terminals of the aerial. But the event is not attracted by the new supply of planetary energy thus made available; it is attracted by the thought activities then stimulated. The stellar-cells work with such intelligence as they possess, and with the energy supply thus made available, to bring events of a certain nature into the life.

In addition to Birth-Chart Constants, which reveal the predisposition—due to the thought compounds in the astral body at birth—toward certain conditions, the Progressed Constants for a great number of events have been worked out statistically. These represent the type of thinking which when given additional energy brings the event into the life toward which the Birth-Chart Constant shows a predisposition.

Events, apart from the normal trend of the life, are attracted only at those times when thoughts of a particular type become unusually active. During the time when an important event is thus attracted through additional thought-cell activity, a close acquaintance usually can notice the change in the individual's habitual attitude. But, because these more than normal thought activities have been worked out in close detail for many varieties of events, it is more convenient to acquire this information from the Progressed Constant in its relation to the birth-chart.

In Course 16, Stellar Diagnosis and Stellar Healing, both the Birth-Chart Constants and the Progressed Constants for 160 different diseases of the body are given. In the Brotherhood of Light Astrological Reports are set forth—each based upon careful analysis of the charts of 100 individuals in whose lives the condition or event has been present—the Birth-Chart Constants and Progressed Constants of other physical diseases, and of a great many other events and conditions.

These Birth-Chart Constants and Progressed Constants are really statements, using the astrological factors that map them instead of less concise explanations, of the predisposing thought-cause, and the stimulating thought-cause, of the condition encountered. In order, therefore, that we may understand the thought-cause of a given condition, and thus know how to remedy or benefit it, we must give attention to the 10 different types of compounds and how they are formed. But, as each thought-element, no matter what compound it has entered, exerts its own characteristic four-dimensional activity, its tendency to promote objective thinking of a particular kind, and its prompting to certain methods of three-dimensional activity, we should first consider the necessities that developed, and the general method of expression, of each of the 10 thought-element families.

It was shown in lesson No. 60, in connection with each of the 10 families of thought-elements, how it was built up, as chemical elements are built from electrons

and protons, of Nutritive Desires and Reproductive Desires. Each element embraces factors which work for Self Preservation and other factors which work for Race Preservation. Instead of repeating what was there stated in general terms therefore, I will here mention more specific instances of conditions such as were responsible for building into the astral body the thought-elements of each family.

Power Thought-Elements

—To obtain food, the life-form often found it necessary to dominate certain territory. To secure the mate of his choice, and having secured her, to prevent her being stolen by a rival, it came to be a decided advantage to possess authority. And often it was a great advantage to the herd to have authority vested in a single powerful individual. Thus among wild horses in Western America the herd is ruled with tyranny by some stallion which has vanquished all rivals to leadership; and this stallion is brave to defend his remuda and cunning to lead it from the proximity of danger.

With community life established, this Drive for Significance became more than the mere seeking food and reproduction. It became the desire to have the respect of others. With man, it at first, no doubt, extended scarcely beyond the family circle. The power of authority exercised by the parents gave both themselves and their children certain advantages. And we find among the ancient Romans that power of the father extended to such proportions that he had the right to kill his own children and the children could own no property during the life of the father.

Authority extending further in tribal rule brought still greater advantages; and these advantages to the one in authority came to be a source of restlessness, discontent and ambition to others.

Power thoughts are the most deep-seated and persistent of all thought-elements. Professor Lombroso found, for instance, that men and women under hypnosis can be made to accept the suggestion that their sex has been changed; but will persistently resist the suggestion that their social status has been lowered. In human life these Power thought-elements mapped in the birth-chart by the Sun, are the source of pride, firmness, approbateness, conscientiousness and self-esteem.

As the positive, electric, etheric energy which gives vitality and recuperative power, the ability to govern and direct others, and the power to rise to a position which gives authority over others, are expressions of thought-elements of the Power family they can not be too abundant for welfare. People with weak power urges do not have long lives. All successful politicians have these thought-elements prominent.

Thinking about one's Significance is responsible for the fortune or misfortune that comes through attaining positions of authority or failure to attain them, and that comes through the good or bad influence of the male sex and of those who are in positions of power. Discordant thoughts about one's Importance are chiefly responsible for high blood pressure, infantile paralysis, pneumonia, and diseases of

the spine; and heart trouble, from which more people die than from any other disease, is entirely due to such thinking.

Domestic Thought Elements

—To provide sustenance and comfort for the young is one of the most commonly observed activities among most forms of life. The wings with which the maple tree endows its seed vessels is an example of the parent providing a food supply for its dependents, and enabling them to find a new and more favorable environment. The barbs of wild oats and rye are efforts of the parent plants to protect their young from devouring enemies.

Birds build nests of intricately woven fabric, insects hoard food, animals construct dens and lairs, to provide for their young; and all will endure labor, hardship and peril, and will fight to the death, in their interest. Such experiences in housing and rearing the progeny built Domestic thought-elements, mapped in the birth-chart by the Moon, into the stellar-cells of the astral body.

Mating and home conditions give rise to ideals and an appreciation of the sublime in human life; and to expressions of the emotions, not merely in human life but also among many birds and some insects, through the avenue of music. Birds more frequently sing not only while mating, but during the whole nesting period. The domestic urges that give love for home and offspring then overflow in song and vision of bliss. These thought-elements in the human astral body are the source of time, tune, sublimity and philoprogenitiveness. They are prominent in the astral forms of most successful musicians.

Domestic thought-elements express through the feminine, soothing etheric energy which is commonly called the constitutional magnetism. They indicate the most receptive region of the astral body, the place where impressions both from the external world and from the inner plane readily reach the unconscious mind, and thus influence the mentality.

Thinking about domestic conditions is responsible for the fortune or misfortune that comes through women and that comes through the influence of the common people. Discordant thoughts about domestic life are chiefly responsible for dropsy and often for stomach trouble and mental complaints. They also are present and contribute to eye and ear afflictions.

Intellectual Thought-Elements

—Insects, birds and mammals when they wander in search of food, find it advantageous to remember the locality of their home and the locality of previously found food and water. To recognize an enemy by sight or sound conduces to their safety. Thus has been developed the perception of form. And in the selection of material for home-building, perception of size and weight was born.

Color enters into the perception both of enemies and of food; insects and hummingbirds being attracted by bright flowers, and grazing animals by verdant foliage. Color also assists in the recognition of their mates. Memory of events conduces to securing food, as illustrated by domestic fowls that come to the call of the person who habitually feeds them, but flee the approach of a stranger. Eventuality also is exhibited by the horse which shies at a point along the road where a week previous he had been frightened. It is a factor of safety.

Birds and mammals recognize the call of distress, the danger signal, the food-supply call, and the mating song or noise. This is language in elemental form. And along with perception of qualities, such expression aids in realizing various desires. In human life these Intellectual thought-elements that have thus been built into the astral body, and mapped by Mercury in the birth-chart, are the source of eventuality, language, calculation and the recognition of size, weight, form and color.

The Intellectual thought-elements determine the habitual method of objective thinking, and thus what other thought-elements are being added to the compounds of the astral form. This thinking also tunes the etheric energies flowing over the nerves to corresponding rates of vibration so that they pick up, radio fashion, planetary energies of like quality and feed them into the astral body.

Thinking which is studious or expression which is ill-considered is responsible for the fortune or misfortune that comes through intellectual cleverness or its lack. Writers, lawyers and teachers who are successful have these thought-elements prominent. Discordant thoughts of this type, in which there is grinding concentration on some problem, is chiefly responsible for nervousness, neuralgia, neuritis, sciatica, hay fever, asthma, and some bowel complaints. Together with thinking about domestic conditions, they lead to mental diseases. And mental diseases are more numerous than all others combined. The hospitals in the U.S., for instance, contain nearly eight times more lunatics or feeble-minded than they contain consumptives.

Social Thought-Elements

—Some plants, such as the pepper tree (*Schinus molle*) so common as a California shade tree, bear staminate and pistillate blossoms on different individuals, and the male and female plants have nothing in common except at that time of year when insects or wind carries pollen from the male plant to the female blossoms. Yet other plants, such as those of the primrose family, have male and female associated in a single flower; and the composite family, including the asters and sunflowers, have found it advantageous to dwell in blossom colonies.

Among the scorpions and the spiders there is little social life; the Anna hummingbird deserts the female before the eggs are hatched; and some male mammals, such as the grizzly bear, associate with the female only for the purpose of reproduction, and they have no protracted companionship. Yet among other creatures there is a long period of companionship between the sexes which has survival values. Certain species of ants (among which as a rule the life of the male is comparatively short), for instance,

mate for life; as does the eagle and the ostrich among birds, and the lion and beaver among the mammals. Gulls and many other birds live in flocks, and antelopes and big horn live in herds.

Through experience with companionship and mating in lower forms of life the Social thought elements that now occupy the astral body of man were built into his finer form. They are mapped in the birth-chart by the planet Venus, and express as affection, friendship, mirthfulness, conjugality and inhabitiveness. Those who successfully express artistic talents have the social thought-elements prominent in their stellar bodies.

Thinking about mating, about companionship, about love and about affection in its various manifestations attracts into the life such fortune or misfortune as friendship and affection bring. Discordant thoughts energized by such emotions are responsible for much disease of the kidneys, of the venous blood stream, of the thyroid gland, of the internal or sex organs, and female trouble and the so-called social diseases. Often, however, in these complaints, aggressive thought-elements also play a part.

Aggressive Thought-Elements

—Every life-form, if it is to survive, must be able to meet and defeat those enemies from which it can not escape. Changing environment ever brings new obstacles; and to triumph over them, rather than perish through lack of attempt, requires initiative. To acquire food there must be incessant activity; and the demands of reproduction develop the quality of amativeness. Such constructive and destructive experiences in lower forms of life built into the astral body that now belongs to man form the Aggressive thought-elements.

They caused the cacti to grow spines and the rose to bear thorns. They gave to the bee its sting, and the venom behind pointed fangs in the rattlesnake and cobra. Hatred, anger, passion, and lust are their expression. Birds, beasts and men face peril and enter into deadly combat in search of food or to win a mate. The thought-elements so built into the astral body, mapped in the birth-chart by the planet Mars, are the source of amativeness, destructiveness, combativeness and alimentiveness.

Thinking about lust, destruction, construction, combat and strife brings into the life such fortune or misfortune as is brought by strife. Successful doctors, surgeons, soldiers, aviators, moving picture stars, mechanics, engineers, and all whose calling requires daring, initiative, aggressiveness, and constructive or destructive ability, have the Aggressive thought-elements prominent in their stellar bodies.

Discordant Aggressive thinking is responsible for more accidents than is any other type of thought. It is responsible for cuts, surgical operations, burns, infection, contagious diseases such as small-pox, measles scarlet fever and chicken pox, and is the most important factor in typhoid, blood poison, malaria, rheumatism, urinary complaints and some kidney trouble. Together with the Social thought elements it is responsible for the so-called social diseases.

Religious Thought-Elements

—Even many lower forms of life place implicit faith in their parents. And among gregarious animals the confidence in the ability of the leader to protect and find ample for their need becomes the beginning of hope. Reverence and veneration develop through obedience to such ruling authority, and looking to such higher power for guidance, protection and the satisfaction of wants. And quite naturally the social emotions, diverted into seeking the favor of the higher authority, take the form of devotion.

To acquire the favor of the leader, or higher authority, the spirit of tolerance toward other members of the group is cultivated, giving rise to good fellowship. The dog expresses these desires sublimated into a highly religious channel when he is willing to perish to save his master.

Various experiences in lower forms of life, in which tolerance and good will have taken part, and in which there was confidence in a higher authority, built the Religious thought-elements, mapped by the planet Jupiter in the birth-chart, into the human astral body. These thought-elements express as benevolence, good-cheer, veneration, hope, reverence and devotion. All successful doctors, and most of those who succeed in professional work, or who, like salesmen, depend upon the element of good will for patronage, have Religious thought-elements prominent in their stellar bodies.

Thinking about religion, good cheer, benevolence, joviality, and faith and confidence in Deity brings into the life such conditions as come through abundance, patronage, and the favors of those who have plenty of money and worldly goods. Discordant thoughts of this type are responsible for extravagance, for paying too great a price for purchases and for diseases which arise from an over abundance of something such as some acidosis, one type of diabetes, biliousness, catarrh, auto-intoxication, carbuncles and fatty tumors.

Safety Thought-Elements

—One of the outstanding abilities of all life-forms which survive is that which enables them to avoid harmful conditions and consequent destruction. Even in the mineral kingdom we find that a metal gives a spasmodic flutter when brought in contact with oxalic acid. Sensitive plants shrink when touched, and the growing leaf moves so that its under surface is kept away from the direct rays of the sun. Deer flee when pursued by wolves, and a child withdraws its hand when it comes too close to the fire. Squirrels and bees store food for winter, and man hoards money. The Safety thought elements thus expressed by him were built into his astral body through experiences such as mentioned while his soul was associated with lower forms. They are mapped in the birth-chart by the planet Saturn, and are the source of secrecy, acquisitiveness, covetousness, casualty and comparison. All successful lawyers,

managers, and others who depend upon system, order, and persistence for success—even policemen and top-notch musicians—have these Safety thought-elements prominent in their stellar forms.

Thinking about fear, caution, acquisition, greed, system, and selfish wants brings into the life all those conditions which come through lack and poverty or through systematic and careful planning and forethought. Discordant thoughts of this type, especially fear, greed, envy, and self-centeredness, are responsible for much loss and hardship, for privation and the necessity of working diligently for every advantage, for restrictions of various kinds and heavy burdens. Such discordant thinking always afflicts through deficiency, and is responsible for cancer, fibrous tumor, pellagra, atrophy, and constipation, and is chiefly responsible for tuberculosis.

Fear and selfishness are the most unprofitable things in the world; for the thought-cells so formed attract losses into the life and develop chronic diseases in the body.

Individualistic Thought-Elements

—When the common food supply becomes exhausted through flood or drought, ability radically to depart from old food habits may have enabled individuals to survive. When the authority exercised by the flock leader restricted opportunity thought-elements for reproduction, rebellion against that authority may have proved advantageous. And, as environment is constantly changing, the ability to make marked new departures from previous customs often conduced to survival.

Such experiences in lower forms of life built into the astral body of man the Individualistic thought-elements, closely allied to the intellectual thought-elements, but mapped in the birth-chart by the planet Uranus. These are the source of independence, originality, inventiveness, and unconventionality. Most successful lawyers, inventors, moving picture stars, astrologers, musical conductors, and others who must use originality in their work, have the Individualistic thought-elements prominent in their stellar bodies.

Thinking about independence, inventions, astrology, new ideas and radical departures from established custom brings into the life both the advantages and the disadvantages that come, always either directly or indirectly through human agency, suddenly, unexpectedly and often abruptly, taking away an old, or bringing a new acquaintance, and a radical change either in the physical or mental life.

Discordant thinking about such matters is responsible for some accidents, and for much of the sudden separations, and unforeseen sudden changes of fortune. It is responsible for appendicitis and paralysis, and is an important contributing factor to arthritis, infantile paralysis and nervous complaints.

Utopian Thought-Elements

—All creatures draw from their astral experiences certain impulses which cause them to strive for a more satisfying type of life. Apparently we witness a manifestation of this in the hunting dog which, lying before the fire after the day's chase, in his dreams pursues the quarry with quivering excitement, and perhaps thus accomplishes in wish fulfillment what he failed to do in actual life, Does the race horse dream of winning the race? Does the famished wolf have visions of fresh meat? Perhaps. At least we know that men have dreams by day, and others by night, in which they reach their heart's desire.

Such experiences, in which mental escape had been made from the harsh restraining walls of reality to a realm devoid of hardship, have built the Utopian thought-elements into the astral body. Fanciful and visionary as they seem, and often, as they are closely allied to the Social thought-elements, revolving around plans for the benefit of the whole of society, they nevertheless sometimes lead to action. All successful aviators, most psychics, many occult students and astrologers, and all who are successful in dramatic art, or in dramatizing their abilities and acting as promoters, have the utopian thought-elements prominent in their stellar bodies.

Day dreaming, idealistic visions, living in the imagination and fantasy thinking in general attract into the life such fortune or misfortune as comes through high expectations devoid of work, through promotion and get-rich-quick schemes, through dramatic ability, much psychic experience, and ideals which to most seem impractical. Discordant thinking of this kind is responsible for much bondage of various kinds, for psychic experiences, for much disappointment in the conduct of those who have been placed on a high pedestal, for poisoning and for a negativeness which encourages invasion by bacteria, and to the formation of moist pockets of infection, which may be quite hidden or may develop into ulcers. It often contributes to tuberculosis.

Universal Welfare Thought-Elements

—Specialization of parts and division of labor are to be encountered not only among the cells and organs which work together for the common good of the physical body, but also among the members of many plant and animal communities. Flowers of the composite family, for instance, quite commonly have ray-flowers ranged around the outside extending large banners to attract insect pollinators. Such ray-flowers often are sterile. They do their part for the community, and depend upon the disc flowers to perform the duties of reproduction.

The cooperation of bees and ants is so common knowledge as to need no comment other than to point out that bees will forfeit their lives for the benefit of the hive, and

ants for the welfare of the colony. Among mammals, beavers cooperate in dam building and in the storage of winter food, for the good of the group.

Experiences in cooperation, either for the benefit of a small and selfish group, or for the benefit of a wider membership, have in lower life-forms built into the astral body the Universal Welfare thought-elements, mapped in the birth-chart by the planet Pluto. These thought-elements, which may express either as spirituality or as inversion, are prominent in the stellar bodies of dictators, gang leaders, and those who are importantly associated with group movements of various kinds.

Thinking about the welfare of the group, or against the welfare of the group, brings into the life events which are drastic, and which are in some manner connected with the enforcement of the group will. Discordant thinking about the welfare of some group, or against such welfare, is responsible for events brought about by racketeers and gangsters, by antagonistic ganging up against the individual, and for the negativeness and degree of sensitiveness which encourages invasion by other organisms and which when the Intellectual thought-elements also are discordant, invites hives, hay fever and asthma.

The Type of Thought Compound Formed Depends Upon Conditioning Energy

—Thought-elements, like chemical elements, are capable of entering into a variety of different compounds, each expressing a characteristic activity toward the environment. Hydrogen and oxygen, for instance, when brought together under different conditions, unite in compounds having quite different chemical properties. Two atoms of hydrogen may combine with one atom of oxygen to form the life-sustaining fluid known as water. Or two atoms of hydrogen may combine with two atoms of oxygen to form hydrogen peroxide, which is not life-sustaining, but a destroyer of bacteria and a bleaching agent.

Oxygen combines with nitrogen in five distinct ways: Nitrous oxide, nitric oxide, nitrogen trioxide, nitrogen peroxide, and nitrogen pentoxide. Each of these compounds, formed of the same two chemical elements, exhibits distinct properties.

Nitrous oxide, commonly known as laughing gas, when inhaled at first produces a peculiar intoxication, followed by unconsciousness and insensibility to pain. But none of the other compounds of oxygen and nitrogen acts in this manner. Each compound has its own qualities.

Likewise, each type of the ten possible compounds in which almost any two of the thought-elements can unite, expresses properties which are quite distinct from the other types.

Observation of the lives of individuals who habitually think in a particular manner enables us to ascertain the type of thought-compound that expresses in a given kind of fortune or misfortune. People who think in a particular manner and have the kind

of fortune or misfortune which goes with that kind of thinking, also are found to have certain aspects in their birth-charts. Our Research Department has made a study not merely of the type of thinking, and whether it was harmonious or discordant, but has investigated thousands of lives and thousands of birth-charts in the effort to ascertain the particular conditions of harmony or discord that accompanied the thinking, which attracted into the life events having definite characteristics.

As a result of this extensive research, it seems quite conclusively proven that, even as certain conditions determine what compound will be formed when hydrogen and oxygen unite, or when oxygen combines with nitrogen, so there are definite conditions under which the thought-elements unite to form compounds, which when they express through the activities of the stellar-cells and stellar structures of the astral body, bring events into the life that, irrespective of the thought-elements combined, are well defined in their characteristics.

States of consciousness arising from experiences either physical or mental build thought-elements into the unconscious mind strictly in obedience to the Law of Association. Resemblance or Contiguity, or both, cause thought-elements of one experience to unite with thought-elements of another experience, or cause two or more types of thought-elements entering at the same time to be brought together in the formation of a compound. Many experiences embrace thoughts of more than one family; and these thought-elements being Contiguous—entering the astral body at about the same time—unite.

When thought-elements are thus brought into intimate association through Resemblance or Contiguity the type of compound then formed depends entirely upon the CONDITIONING energy present. That is, it depends upon the volume, persistence and intensity of the pleasure or pain accompanying the experience. Conditioning energy thus stored in the compound becomes the tension, desire, or URGE of the thought-cell then formed, to express through a similar channel of pleasure or pain. Such is the most pleasant expression for the thought-cell because to express in a manner contrary to its mode of formation would require a type of energy it does not possess. Yet while it satisfies its own longing through such expression, if that expression is discordant, it is inimical to the welfare of the individual.

The more intense the Conditioning energy with which the thought-elements are united, the more beneficial or detrimental becomes the action of the thought-cells then formed in reference to the organism of which they form a part. There are ten distinct types of compounds, each of which, because the conditioning energy entered into the thought-element union in that manner, expresses in thought-cell activities which are characteristic.

Prominence Compound

—Due to the frequency with which experiences embracing two or more thought-elements enter the life, these thought-elements may become present in the stellar-cell structure of the astral body in large volume. Although added to the stellar

form under circumstances of Contiguity—at nearly the same time—that cause them to form a compound, the Conditioning energy present in so far as pleasure or pain is concerned may be very weak. Such a compound is one of the most powerful that can be formed; but its activity as expressed through stellar-cells and stellar structures, being due to volume rather than to Conditioning energy, chiefly operates to bring into prominence the special abilities indicated by the thought-elements and the department of life with which associated. A dynamic stellar structure formed of such a compound is mapped in the birth-chart by the **Conjunction** Aspect.

Growth Compound

—Thought-elements united by the Conditioning energy of a steady feeling of mild pleasure in the experiences from which they are derived enter into a slightly harmonious compound, which in its expression through stellar-cell and stellar structure activities, promotes growth. Stellar-cells so composed work both from the four-dimensional, and the three-dimensional plane, to attract many small advantages for development. A dynamic stellar structure formed of such a compound is mapped in the birth-chart by the **Semi-Sextile** Aspect.

Opportunity Compound

—Experiences embracing two or more thought-elements in which these different types of thinking uniformly bring a feeling of pleasure, due to this strong and harmonious Conditioning energy, cause the thought-elements to unite in a compound which expressing through stellar-cells and stellar structures, draws opportunities into the life. Thought-cells of such composition work to bring favorable environmental conditions. Opportunity does not come by chance, but through the work of such four-dimensional thought groups. A dynamic stellar structure formed of such a compound is mapped in the birth-chart by the **Sextile** Aspect.

Obstacle Compound

—Difficulties may be approached in an attitude of joy that there is a chance to test one's strength, and of glory in triumphing over them. Or they may be approached with distaste, and with acute pain due to the conflict. When the Conditioning energy with which two or more thought-elements unite is that of painful struggle, the expression of the compound through stellar-cells and stellar structures invariably interferes with the adaptation to environment. It works to attract hindrances. Every obstacle in life is attracted by such compounds. It may be poverty, it may be ill health, it may be lack of education or opportunity, or it may be the antagonism of opponents; but whatever the obstacle is, it enters the life through the activities of compounds conditioned by violent discord. A dynamic stellar structure formed of such a compound is mapped in the birth-chart by the **Square** Aspect.

Luck Compound

—Thought-elements brought into mutual association through thinking of their objects with prolonged and enthusiastic pleasure enter into a union such as causes the stellar-cells and stellar structures embracing them to work diligently to bring the realization of desires in the departments of life with which associated. A thought compound thus highly Conditioned with pleasure energy brings into the life fortunate conditions such as are commonly attributed to luck. They enter into the psychoplasm of the most harmonious of all stellar-cells. A dynamic stellar structure formed of such a compound is mapped in the birth-chart by the Trine Aspect.

Expansion Compound

—The thought-elements built into the astral body when objects or endeavors are brought together in the experiences along with ideas regarding development, yet at the same time with no pronounced feeling of pleasure or annoyance, unite in a compound which is neither markedly harmonious nor beneficial. The Conditioning energy is slight, and such as it is, instead of expressing in prominence, because it revolves about development, tends to expression through the stellar-cells and stellar structures embracing the compound, in the direction of expansion. A dynamic stellar structure formed of such a compound is mapped in the birth-chart by the Inconjunct Aspect.

Friction Compound

—Irritations, little anxieties and the small abrasions of life furnish Conditioning energy which unites the thought-elements of the experiences in association with them into compounds the stellar-cells and stellar structures of which, because the energy has been built into them in that way, must express in the direction of attracting chronically annoying events. Stellar-cells of such psychoplasm work incessantly from the four-dimensional plane, and through the three-dimensional plane, to cause friction with others and to bring irritating circumstances. A dynamic stellar structure formed of such a compound is mapped in the birth-chart by the **Semi-Square** Aspect.

Separation Compound

—When the desires simultaneously pull in opposite directions, causing a decided feeling of distress because if one desire is realized the other must be relinquished, the thought-elements thus built into the astral body are united by one of the most powerful types of Conditioning energy. This struggle for supremacy between the thought-elements in expressing through the stellar-cells and stellar structures causes them to work persistently to force asunder the departments of life with which

associated. A dynamic stellar structure formed of such a compound is mapped in the birth-chart by the **Opposition** Aspect.

Agitation Compound

—Things are thought about pleasantly at one time which under other circumstances are thought about with a feeling of displeasure. The Conditioning energy with which the thought-elements unite is thus harmonious at times and at other times discordant. Because the Conditioning energy thus alternates, the compound in expressing through the thought-cells and thought structures embracing it, tends to break up pre-existing conditions and conduces to mental and physical agitation. A dynamic stellar structure formed of such a compound is mapped in the birth-chart by the **Sesqui-Square** Aspect.

Intensity Compound

—Long, although rather indefinite, association of thoughts and conditions of two or more types, builds thought-elements into the astral body in volume. But because the Conditioning energy is so slight, there being neither pleasure nor pain, the compound is rather loose in composition, but the stellar-cells and stellar structures embracing it have intensity of energy, due to volume. They thus rather powerfully attract the things of the departments of life with which associated. A dynamic stellar structure formed of such a compound is mapped in the birth-chart by the **Parallel** Aspect.

Chapter 3

Serial No. 97
Original Copyright 1937
Elbert Benjamine

Copyright
Church of Light
August 2002

Just How to Find a Mental Antidote

Chapter 3

Just How to Find a Mental Antidote

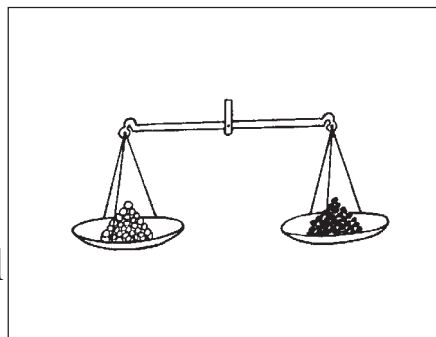

WHEN the chemist possesses a compound which is unsuited to his purposes, to change its composition so that it will have properties more favorable to the ends he seeks, he proceeds to do one of two things: Through the application of conditioning energy he rearranges the same elements; as when he applies heat to Hydrogen Peroxide, driving off a portion of the oxygen, and obtaining Water. Both Hydrogen Peroxide and Water are compounds of Hydrogen and Oxygen, but with distinctly different properties. Or, he adds one or more other element to the compound, which uniting with one or more element in the original, changes its character entirely. For instance, if he wishes to obtain Nitric Acid which is widely used commercially, he can add Water to Nitrogen Pentoxide.

Likewise, when it is desirable to change the composition of a thought-compound in the astral body, so that the stellar-cells and stellar structures formed of it will have an entirely different influence upon the events they attract into the life, the same two methods are available: Either, through the application of conditioning energy, the thought-elements of the compound are rearranged; the process being termed Conversion; or new thought-elements, termed Mental Antidotes, are added to the compound, which uniting with one or more thought-element in the original, changes its character completely.

Two thought-elements may have so pleasant an affinity for each other that whenever they are associated, by being in the same compartment of the astral body, they tend to unite in a compound. And because of this unusual attraction, when they are permitted thus to join, they develop spontaneously a certain amount of pleasant conditioning energy which thus enters the compound and influences the thought-cells and stellar structures formed of the compound. Thought-elements which thus tend readily to unite, and if no special conditioning energy is present, in uniting combine in a more or less harmonious compound, are said to be Mental Antidotes, each of the other.

Mental Antipathies also exist among the thought-elements. When the Aggressive thought-elements, for instance, occupy the same compartment of the astral body with the Safety thought-elements, although they do not readily combine, to the extent close association does cause them to enter into a compound, is there developed

merely through this association, painful conditioning energy which enters the compound and influences the thought-cells and stellar structures formed of the compound.

How Antidotes Act

—An increasing number of deaths are caused each year through the effect of carbon monoxide gas, developed through faulty combustion of fuel in automobile engines. An engine started, or left running, in a closed garage is responsible for some such deaths. Others are caused by the gas from imperfect connections, or from the exhaust, seeping up through the floor into the driver's compartment, or by the gas from a car on the road just ahead blowing back into the driver's face. As the gas is tasteless, odorless and colorless, the driver does not recognize his danger, is rendered unconscious, and permits his car to crash.

It can be shown, from ample statistical data, that the thought-cause which attracted the driver to the carbon monoxide danger, resided in a compound within his astral body in which the Utopian thought-elements were painfully united to other thought-elements. But the purpose here of introducing this quite modern danger, is to illustrate the effect of Antipathies and Antidotes when applied to the human system.

Carbon monoxide is not poisonous in the sense that arsenic, strychnine, and toxic compounds are. It is readily eliminated from the system when the living person is removed from the presence of an additional supply. Yet it requires a very diluted amount in the air we breathe to bring death.

The red blood corpuscles, although possessing consciousness, are quite unlike the white leukocytes. They are tiny sacks full of hemoglobin. And hemoglobin has a marked affinity for oxygen. During the passage of the red corpuscles through the lungs, they take on a load of oxygen, which a few moments later they deliver to the tissue cells, picking up, for the return cargo to the lungs, carbon dioxide and other waste products.

But hemoglobin has a much stronger affinity for carbon monoxide than it has for oxygen. When, therefore, the air contains even small amounts of carbon monoxide, this unites with the hemoglobin instead of the oxygen. Without a fresh supply of oxygen the brain can retain consciousness only a few minutes; and other organs of the body can function only a matter of hours. That is, the carbon monoxide acts as an antipathy, when it combines with the hemoglobin. The person suffocates just as surely as he would if for the same length of time he were under water. And the treatment to relieve the condition is to use a pulmotor, or artificial respiration, just as in drowning. In fact, he is drowning, and if revived before life ceases, he suffers no more ill after effects than had he been immersed in water.

When, by means of the pulmotor, or natural breathing if it has not been completely suspended, the red blood corpuscles are furnished again with a supply of pure air, in their contact with the tissues they gradually relinquish their carbon monoxide, and

the hemoglobin again combines with oxygen, carrying it from the lungs to the tissues. Pure air, even if it must be forced into circulation through the lungs by means of a pulmotor, is thus the natural Antidote for a dangerous carbon monoxide compound. Nothing else in the way of a remedy is required. If the heart continues to beat, circulating the blood, and plenty of pure air is furnished the hemoglobin of the blood, there is such a pleasant affinity between hemoglobin and oxygen, that they combine in a compound wholly beneficial.

In a similar manner, each family of thought-elements has both its Antipathy and its Antidote in certain other families of thought-elements. But because the practice of Mental Alchemy is to relieve distress, and to form such thought-compounds in the astral body as will attract, through the activities of the stellar-cells and stellar structures composed of them, more fortunate events, our interest is more pronounced in determining the Mental Antidotes and how to apply them. Just what these Mental Antidotes are has been handed down to us through tradition from remote antiquity; but they have been amply verified through extensive modern research and experiment.

Antidotes Should Be Applied to Both Compartment and Stellar Structure

—The state of consciousness accompanying any physical or mental experience builds thought-elements of one or more family into the psychoplasm of the astral body. The thought-elements thus added move to, and are assimilated by, the compartment in the astral body related to the department of life with which the experience is chiefly concerned. That is, if the experience has chiefly to do with money, they move to the 2nd compartment; if it has to do with love affairs, they move to the 5th compartment; or if it has to do with credit and honor, they move to the 10th compartment.

This tends to bring them into proximity with other thought-elements already occupying the same compartment in the astral body. Such casual association alone does not of necessity compel them to combine; but in the case of Mental Antidotes, the affinity is so strong that the slight additional association given by the purpose of applying a mental remedy is sufficient to enable these incoming elements to enter into the psychoplasmic compound of the stellar cells, thus changing their nature completely.

When the Mental Antidote for the particular affliction has been determined, it is then sound practice to cultivate harmonious experiences and harmonious thinking of its type in connection with the department of life—money, health, honor, friendship, etc.,—for which the mental remedy is needed.

But in addition to this, the antidote should be applied directly to the Dynamic Stellar Structure chiefly responsible for the difficulty. If the discordant Dynamic Stellar Structure attracting the misfortune is chiefly composed of Safety

thought-elements—mapped in the birth-chart by the planet Saturn—whenever Safety thoughts, feelings or impulses enter objective consciousness, it is good practice at once to think about and cultivate their antidote. That is, when fear, caution, acquisition, greed, or cold selfishness, are recognized in the thoughts or actions, other thoughts and actions should at once be cultivated relating to love, affection, art, beauty, and friendship, to take their place. The fact that the new set of thoughts and experiences are purposely developed to take the place in consciousness of the troublesome ones, associates them immediately with the thought-elements in the active thought-cells responsible for the difficulty.

Those very active groups of thought-cells forming a Dynamic Stellar Structure in the astral body, if they are the seat of a difficulty of any importance, are quite certain to influence not merely the experiences attracted, but also the objective thinking and feeling. And to whatever type they belong, whenever the experiences or thinking characteristic of them are present, if the experiences and thinking which constitute the Mental Antidote are then used in the effort to displace or alter them, these new thought-elements enter into combination with the ones causing the trouble.

The Dynamic Stellar Structure responsible for the difficulty to be remedied may be ascertained through a careful process of psychoanalysis: or through a careful observation of the habitual thought of the individual. The thought-cells of a stellar structure with energy enough to cause much difficulty in life, also are energetic enough to influence both unconscious trends of thought and the habitual objective thinking. But the most convenient method of determining the thought structure, the cells of which need a Mental Antidote, is through using the known Birth-Chart Constants in connection with the birth-chart.

But whatever method is used to discover the thought-cause of the condition to be treated, the Antidote should be applied to the thought-cells in the compartment affected in the astral body, by associating the Antidote as harmoniously and as persistently as possible with that department of life; and it should be applied directly to the Dynamic Stellar Structure through using it on all those occasions, which will be numerous enough to start with, when the thinking responsible for the difficulty gains recognition in consciousness.

Now let us consider, in the case of each family of thought-elements, just what thoughts and experiences should be sought, when it is the chief element in a discordant thought-compound, to afford the proper Mental Antidote:

Antidote for Discordant Power Thought-Cells

— When there is discord arising from a thought-compound in which the Power elements predominate, this is due to the influence of the other thought-element, or thought-elements, in the compound, and to the conditioning energy with which the elements combined. Therefore, the antidote for this other thought-element should be

added to the compartment containing the Power thought-cells, and to the Power Dynamic Stellar Structure.

To add them thus to the Power Dynamic Stellar Structure, whenever thoughts are present relating to pride, firmness, conscientiousness, self-approbation, self-disapproval or self-esteem, thoughts of the character of the antidote of the other thought-element in the compound should be entertained. Also, experiences should be cultivated of the nature of the antidote of this other, and discordant, thought-element in the compound, with the purpose in mind of adding harmony and strength to the feeling of importance and accomplishment.

There can not be too much of the Power thought-elements in the astral body; and a great deal of failure in the lives of most people is due not so much to the discord in association with the Power thought-cells as to their lack of energy. That is, thoughts, efforts and other experiences relating to significance have been too few, and lacking in intensity, in the soul's past to build up these stellar-cells and give them the activity necessary for high accomplishment.

Their prominence does not prevent difficulties, nor their characteristic type of diseases, if they are composed of discordant compounds. But it does give ability, to the extent these Power thought-cells have acquired energy, to overcome difficulties. Statesmen and those who lead or govern others often have gravely discordant Power thought-cells; but they always have unusually energetic Power thought-cells. Those with such discords attract one difficulty after another, but are able to dominate them, until the discord attracts a physical disease resulting in death. Important men, because of the prominent yet discordant Power Dynamic Stellar Structure, very frequently die of heart failure.

To illustrate what I mean, consider the birth-charts and lives of three of our presidents: Theodore Roosevelt (Birth-chart in lesson No. 95) with Sun in 10th, conjunction Mercury, opposition Pluto, and trine Moon, went out of his way to find difficulties; but his Power stellar-cells were so energetic that he steadily gained in authority; yet he died at a time in life when many men are in their prime. Warren G. Harding (Birth-chart in lesson No. 116), with Sun conjunction Mars and Saturn, opposition Moon, and trine Uranus, was unsuccessful as candidate for Governor, and as president died from ptomaine poisoning, typical of discordant Utopian thought-element compounds. Calvin Coolidge (Birth-chart in lesson No. 115), with Sun opposition Saturn, was frugal and accustomed to hardship, but the activity of his Power thought-cells gave him one political position after another, until he died from heart failure, typical of discordant Power compounds.

Almost any person who sets resolutely and intelligently about it can acquire some knowledge or ability that is outstanding in the community where he lives. He can do something that will secure the esteem of others, or at least, through benefitting the community, heighten his own opinion of himself. Working to such an end, if the difficulties are met with joy in accomplishment, this builds Power thought-elements

into the astral body, adding to the vitality and to the importance of the life. Such effort is well worth while to any person.

Antidote for Discordant Domestic Thought-Cells

—In the home, where women and dependents are concerned, and in relation to the common people, the individual becomes more receptive to impressions than in most other avenues of life. That is, he is more negative to such influences, and whatever harmonies or discords are present find easier access to his astral body, and build into it thought compounds possessing such conditioning energy.

It has been found through experiment and observation that the Aggressive thought-elements have a peculiarly harmonious and powerful affinity for the Domestic thought-elements. Aggressive thought elements, ruled by Mars, are the most positive and energetic of all; just as the Domestics, ruled by the Moon, are the least positive. When the Aggressive thought-elements are added to any compound containing the Domestic thought-elements, they immediately enter into combination with the Domestic thought-elements; and the resulting compound, unless at the time discordant conditioning energy is added through some painful association, tends to be of a highly beneficial character.

I believe no thought-compounds give greater courage and daring, or mental activity, than those formed by a union of the Aggressive thought-elements with the Domestic thought-elements. Such a compound is mapped in the birth-chart by an aspect between the Moon and Mars; and, while attracting strife and a tendency to accidents, even a discordant compound of these two thought-elements has great possibilities for accomplishment. In other words, they are such perfect antidotes, each of the other, that in any compound they provide activities that cause their stellar-cells to attract a certain type of good fortune.

As illustrating this peculiar quality even when in compounds that are otherwise not harmonious, Theodore Roosevelt (Birth-chart in lesson No. 95) had Moon opposition Mars; Admiral Richard E. Byrd (Birth-chart in lesson No. 63), who was the first man to fly over both the north pole and the south pole of the earth, has Moon opposition Mars; Amelia Earhart (Birth-chart at front of this booklet), first woman to fly the Atlantic, has Moon square Mars; Calvin Coolidge (Birth-chart in lesson No. 115) had Moon conjunction Mars; Benito Mussolini, Italian dictator (Birth-chart in lesson No. 2), has Moon conjunction Mars; and Franklin Delano Roosevelt (Birth-chart in lesson No. 204), has Moon conjunction Mars. These individuals all are noted for courage and daring as well as for high accomplishment.

To add these Aggressive thought-elements to the compartment of the astral body containing the Domestic thought-cells, this department of the life should be associated in the mind with activities which are deliberately undertaken for the protection of the weak and helpless and providing for those unable to care for

themselves; activities that call for initiative, courage, and combat. Even taking the part of a mistreated dog is a step in the right direction.

To add these Aggressive thought-elements specifically to the Domestic Dynamic Structure, whenever thoughts enter the consciousness that relate to difficulties in the home, to difficulties with women, or to difficulties with the common people; these should instantly and completely be displaced by thinking about some episode in the life in which initiative and courage were exercised. Or the thoughts may be turned to some contemplated activity which requires initiative and courage.

Commonly the thoughts arising from activities of the Domestic Dynamic Structure are of a quality that, even though tumultuous in their emotional content, as soon as the emotion begins to subside, they leave the individual in a state of passive acceptance of conditions. Such negativeness of attitude merely increases the power of the Domestic thought-compound to influence the life. And while it is poor technique to oppose any thoughts that are discordant to this negativeness; it is essential in correcting a Domestic thought-element difficulty with a Mental Antidote, that positive and aggressive, even war-like, thoughts should be substituted. When such Aggressive thoughts are thus substituted, their purpose of displacing the discordant Domestic thoughts is sufficient association to cause them to enter into combination with the thought-elements of the Domestic Dynamic Structure.

Antidote for Discordant Intellectual Thought-Cells

—The objective mind was evolved the better to adjust the organism to new situations through actions based upon examination and comparison. This process of examination and comparison when carried out by the objective consciousness, as well as the expression of the thoughts through speech or writing, is done at the expense of electrical energy generated in the brain-cells. That is, such thinking as adds Intellectual thought-elements to the astral body, is accompanied by vibrations of the physical brain cells, which in turn consume etheric energy.

The etheric energies thus set in motion flow from the brain as electric discharges over the nervous system, thus tuning the nerves in on corresponding astral vibratory rates, enabling them to pick up, radio fashion, such energies from the planets, from other radiating brains, and from the minds of those on the inner planes of life.

The more powerful the Intellectual thought-cells are in the astral body, even though combined in discordant compounds as indicated by inharmonious aspects to Mercury in the birth-chart, the more activity are they able to impart to the physical brain cells. Up to the capacity of the brain cells to stand the strain thus imposed upon them, even discordant Intellectual thought-cells are an asset to mental ability.

But because their activities imparted to the physical brain do thus so largely determine the habitual type of thinking and the habitual tendency of the nervous system to pick up broadcasted vibrations of a particular type and harmony or discord,

which in turn affect the life in various departments through feeding energies into the thought-cells in various compartments, it is of utmost importance that the Intellectual thought-cells should be harmonious.

Faith, and the reliance on a higher power, relieve the Intellectual processes of their tendency to carry the whole burden of responsibility for what happens in life. They enable them to relinquish activity about matters beyond their power, and to concentrate the etheric energies of the brain toward the solution of essential problems. Over activity of the brain uses up more electrical energy than the brain cells generate, and thus leads to depression. But steady, directed attention given to some selected problem leads to such exhaustion slowly in comparison to the irritation of numerous petty problems which come spontaneously, each one stimulating unregulated electric discharges over the nerves.

A benevolent attitude toward others, and a calm and abiding faith that things beyond personal control will work out for the best, or at least some firm philosophy that may be thought about adds the Religious thought-elements to the astral body. These antidotes should be added to the compartment of the astral body containing the Intellectual thought-cells through cultivating such benevolence, faith and philosophy in reference to the department of life they influence. And they should be added to the Intellectual Dynamic Structure through substituting such an attitude for the too insistent, or the discordant, thoughts that intrude in an effort to solve the problems which life constantly presents.

Antidote for Discordant Social Thought-Cells

— Love, affection and friendship, while not antagonistic to safety and self-interest, yet possess a vibratory quality which softens their hardness. Observation and experience show that excess of such emotional qualities, or their discords, are quickly and beneficially modified by the application of caution, system and forethought.

The Safety thought-elements are the mental antidote for the Social thought compounds. But in their application, if the resulting compound is to be truly harmonious, no element of selfishness, greed or fear should be allowed to creep in; for these discordant Safety thought-elements are so powerfully conditioned with discordant energy that they impart a loss-attracting activity to any thought compound into which they enter; even when combining with Social thought-elements if these also are discordant. Proper caution and foresight should be used not to attain an undue advantage, but in the interest of strict justice, in the use of the Safety thought-elements as an antidote.

Also, because the Social thought-elements, mapped in the birth-chart by Venus, are so negative, in addition to the mental antidote they need, when discordant, Power thought-elements harmoniously applied to the compound. That is, pride, firmness and self-esteem should also be cultivated in association with them.

To apply the Safety thought-elements to the compartment of the astral body containing the Social thought-cells, the things of this department of life should be thought about with much care in the effort to discern how each course of action will affect them; and how they will ultimately affect oneself. Their influence upon the self-respect in particular should be noted, and courses of action decided upon which will be just, but which will not detract from the feeling of Significance.

To apply the Safety thought-elements to the Social Dynamic Structure; whenever discordant thoughts arising from affectional matters enter the consciousness, these should be displaced by thinking intently about caution, system, order, and persistent effort in connection with some work or enterprise that enables these thoughts to afford a feeling of pleasure.

The fact that emotional matters tend to intrude, and these cold and careful thoughts are used to displace them, even though the Safety thoughts are about something else, is sufficient association to cause them to enter into the same compound. And if the thoughts dwell too persistently upon the emotional subject, while the thought-elements enter the proper thought-cells, they tend to become too charged with discord to give them a harmonious composition. The feeling at the time enables one to judge to what extent, in adding the thoughts of firmness and self-respect, as well as those of the Safety family to the compound, it is advisable to permit thoughts of the affectional object to be present.

Antidote for Discordant Aggressive Thought-Cells

—If it is in harmonious compounds, so that it will express in constructive activities instead of in those destructive, it seems impossible to have too much of the Aggressive thought-element in the astral body. Without it in ample quantity there is insufficient energy for worth while accomplishment.

But when as revealed by discordant aspects to Mars in the birth-chart, the Aggressive thought-cells contain painful conditioning energy, their activities are the source of strife, infection, accident and other misfortunes. Yet, as indicated already, they have a powerful and harmonious affinity for the Domestic thought-elements, which are their natural antidote.

To apply the Domestic thought-elements successfully to the compartment of the astral body containing the Aggressive thought-cells, thoughts of providing for the helpless, of making the domestic life more enjoyable for those in the home, and of taking care of their wants, should be associated with the department of life thus needing treatment. And to increase the potency of the process, some actual work, having for object the caring for the helpless or providing for their welfare, should be undertaken.

To add the Domestic thought-elements more specifically to the Aggressive Dynamic Structure, whenever thoughts relating to strife, or generated by lust, anger or the

feeling of antagonism enter the consciousness, a deliberate effort should be made to displace them with other thoughts relating to helping the weak and providing for the unfortunate. In this work of substituting Domestic thoughts, it will be found that the Aggressive thought-cells possess so much energy, once they are able to connect up strongly with the brain cells, as when lust, anger or irritation is present, that it is unwise to attempt to repress them.

Each individual should have some plan, project or work in which he finds spontaneous delight, and which at the same time contributes to the comfort of his family, or to the welfare of the old or young who are helpless. An active interest in some branch of social welfare work serves the purpose admirably. With such a Domestic thought interest already well developed, it is not difficult, when lust, anger or irritation begin to be felt to switch the thoughts to this interest; and to divert the Aggressive energies being released into channel of construction. That is, if the energy being liberated is used to build something, instead of to tear down, it performs a useful work. And when it is present in volume, as is always the case when there is anger or lust, it is sure to express either destructively or constructively. If it is given some constructive work, this diverts it from destructive activity. And if this work, either physical or mental, is undertaken for the benefit of children or others who are helpless, this adds the Domestic thought-elements to the Aggressive Dynamic Structure in the manner most suited to provide a satisfactory antidote.

Antidote for Discordant Religious Thought-Cells

—Placing too much reliance on faith, good luck and the protection of providence, instead of taking an adequate share of responsibility, is typical of the manner in which discordant Religious thought compounds express in the habitual attitude toward life. The stellar-cells embracing such compounds are mapped in the birth-chart by discordant aspects to the planet Jupiter.

While it unwise to ask the Intellectual processes to carry the whole burden of responsibility for what happens, it is equally in error to expect providence, or the good will of others, to shoulder the whole load. Yet there is so strong an affinity between the Religious thought-elements and the Intellectual thought-elements that whenever they are in each other's presence, unless they are associated painfully, they tend to combine in a pleasant and harmonious compound. Thus they are the natural antidotes, each of the other.

To apply the Intellectual thought-elements to the compartment of the astral body containing the Religious thought-cells, the things of the department of life thus affected by the Religious stellar-cells should be made the subjects of thorough study and careful analysis. The critical faculties should be brought into play to determine the best course of action in every situation when these things constitute a factor. Feeling should be made subordinate to reason based upon careful examination. Snap judgments should be avoided.

The old astrological books hold that an afflicted Jupiter, more than any other planet, destroys the judgment. This is not because Jupiter rules the judicial faculties, but because discordant Religious thought-cells are able to displace reason and the critical weighing of factors, one against the other, with wish-inspired impulse.

To apply the Intellectual thought-elements to the Religious Dynamic Structure requires that over optimism, the blind reliance on chance, and the tendency to permit things to take their own course in the hope that they will turn out all right, should be replaced by a careful examination of every situation in which impulse and enthusiasm urge either an action or inaction. Many situations will arise in which a critical analysis of all the factors will reveal that impulse and enthusiasm were leading in the right direction. But aside from preventing actions based on faulty judgment, such procedure associates the Intellectual thought-elements with the elements in the Religious thought-cells responsible for the impulse, faith, or optimism, and thus builds a new and highly beneficial compound.

In applying the Intellectual thought-elements, care should be exercised that no feeling of distaste for the labor involved arises; for their proper application requires concentration and, as electric forces generated by the brain cells are involved in the process, this rapidly consumes energy.

Antidote for Discordant Safety Thought-Cells

— In their expression the Safety thought-cells are heavy and laborious. If harmonious and constructive in trend they are among the most valuable assets of life; but even when thus fortunate they are decidedly more beneficial when brightened and given vivacity through adding to their compounds the cheery Social thought-elements, which are the natural antidote. Furthermore, all thought-cells to the extent they contain Safety thought-elements in their composition, are negative, and therefore can be benefitted by adding to them Power thought-elements. When the Safety thought-cells contain painful conditioning energy, as revealed by discordant aspects to Saturn in the birth-chart, they in particular need both their antidote and the Power thought-elements added to them.

To add the Social thought-elements successfully to the compartment of the astral body containing the Safety thought-cells, pleasant social contacts, musical entertainment, or artistic trends, should be cultivated in connection with the various things relating to this department of life. The effort should be toward getting as much cheer, amusement and pleasant emotion as possible out of these associations. At the same time, to offset the tendency to negativeness which is always a menace—for when present it permits control by thoughts, forces and environment other than of one's own choosing—there should be maintained, along with the pleasant emotion, a feeling of firmness, of energies slightly pressing outward, and of self-respect and significance.

To add the Social thought-elements more specifically to the Safety Dynamic Structure, a definite line of thought and action should be planned and followed, to be brought into use whenever fear, greed or worry is present in objective consciousness, and whenever there is a feeling of grief, disappointment or depression.

This plan of action requires the cultivation of some affectional interest which is not disappointing, the establishment of pleasing social contacts, or the development of an appreciation of music, art or poetry. If such associations are lively and merry, they are better than those that require reflection. That is, they should be in the nature of amusements or recreations, which have enough spontaneous attraction to banish the worry, disappointment, or other Safety thoughts from the consciousness.

Safety thoughts in particular, and to an extent other thoughts of negative quality, turn the interests of the mind upon the self. Hence it is requisite in causing them to enter into more favorable compounds that there is an interest outside the self which induces the energies to flow outwardly. And to insure that the energies do thus flow outwardly, instead of negatively permitting outside conditions to cause the flow to be reversed, it is good technique to maintain a feeling that the energies are slightly pressing outward, and to hold thoughts of power, vitality and self respect.

This negativeness which is common when Domestic thought-elements, Social thought-elements, Utopian thought-elements, Universal Welfare thought-elements, or Safety thought-elements are too prominent in the astral body is not confined to the stellar-cells but affects the electrical potential of the physical body markedly. The brain-cells generate electrical charges which make it positive to the rest of the body; the liver being the opposite pole, carrying the strongest negative charges. Fear, worry, grief, or other negative thoughts decrease this electrical difference between brain and liver, which means that they lower the vitality; for the vitality depends upon this electrical difference. It is quite possible to die of fear, worry or grief; for when the difference in electrical potential is no longer present, the battery that runs the body is dead, and the body can not function. Hence the necessity of applying the vitalizing Power thought-elements to keep the thoughts and brain from becoming too negative.

Antidote for Discordant Individualistic Thought-Cells

—The thoughts of the Individualistic family are an upper octave expression of the Intellectual thoughts, and have an equal capacity to tune the etheric energies flowing over the nervous system in on corresponding astral rates of vibration. And because they are upper-octave, and therefore have a shorter wave length, to the extent the Individualistic thought-elements are present in the thought-cell compounds of the astral body do they give the personal magnetism—which is etheric radiation—a quality and intensity which others pronouncedly feel. If the Individualistic thought-cells are powerful and harmonious, it causes others to be strongly, even violently, attracted; and gives the ability to sway others through magnetic power.

Orators who influence public opinion markedly always have prominent Individualistic thought-cells. On the other hand, if the Individualistic stellar-cells are powerful and discordant, as mapped in a birth-chart by a prominent Uranus receiving inharmonious aspects, it attracts others who exert an undue and unfortunate influence over the life. That is, whatever fortune or misfortune is attracted through the activities of the Individualistic stellar-cells is associated directly or indirectly with a human agency.

Yet, even though the effect on the nervous system liberates shorter wave lengths due to electrical oscillations, and these short wave lengths broadcast more powerfully than those released from the nitrogen of the protein fraction of the nerve cells by the action of the Intellectual thought-cells, the antidote is the same. It consists of applying the Religious thought elements.

To apply these Religious thought-elements to the compartment of the astral body containing the Individualistic stellar-cells, the things of this department of life should be viewed with a greater spirit of give and take; of greater tolerance for the views and shortcomings of others in reference to them, and with a broad and optimistic philosophy which places much reliance on higher powers to cause things to work out as they should.

To apply the Religious thought-elements more specifically to the Individualistic Dynamic Structure; whenever thoughts enter the consciousness as to the desirability of destroying the old for something new and untried; especially if the thought of existing conditions gives rise to a feeling of dissatisfaction; displace such thoughts by thinking about higher powers which all in their proper time bring these changes necessary for progress. Turn the thoughts from the dissatisfying condition to the highest type of religion that has been contacted, whatever it may be.

Antidote for Discordant Utopian Thought-Cells

—The Utopian thoughts also are upper-octave expressions. They are shorter wave lengths, but otherwise similar in characteristic, to the Social thoughts. But because they are negative they do not radiate powerfully from the nerves as do the Individualistic thoughts; but instead give the nervous system unusual sensitiveness to other vibrations. This magnified sensitiveness tends to a like magnification of the importance of what is received. That is, the activity of the Utopian thought-cells gives an undue reality to fleeting and evanescent impressions, and exaggerated expectations, whether these be beneficial or detrimental.

In addition to applying the Safety thought-elements as an antidote, because they are so negative, an effort should also be made to add the Power thought-elements to the Utopian thought-element compound.

To apply the Safety thought-elements to the compartment of the astral body containing the Utopian thought-cells, the things of this department of life should be

thought about with much care in the effort to discern how each course of action will affect them; a special effort being made not to magnify the importance of these influences, and thus to avoid ultimate disappointment. Also, their influence upon self-respect and significance should be studied, and a more positive attitude toward them should be cultivated.

To apply the Safety thought-elements more specifically to the Utopian Dynamic Structure; whenever ideas involving projects of great magnitude, or whenever impressions which seem of much importance enter the consciousness, these should be displaced by thinking carefully about what is, and what is not, practical in the light of past experience.

Discordant Utopian thought-cells, mapped in the birth chart by inharmonious aspects to the planet Neptune, in particular tend to a negative, dreamy state of consciousness to which should be applied both the hard, concrete, practical facts of the Safety thought-elements; and, to give more vigor, the vital, courageous, thoughts of application to detail as an aid to realizing a practical significance instead of attaining that significance only in the wish-fulfillment of imagination. Even the harmonious Utopian thought compounds will be benefitted by applying to them both the Safety thought-elements and the Power thought-elements in painstaking concrete endeavor; as always the Utopian thought-cells tend to gain satisfaction too largely through imagination.

Antidote for Discordant Universal Welfare Thought-Cells

—The thoughts of the Universal Welfare family are an upper-octave expression of the Domestic thought-elements. They are those of the family expanded to embrace a still larger group, which in its highest expression includes all living things, wherever found. The expression of the Universal Welfare thought-cells releases the highest frequency short wavelengths which lightning, when it tore asunder the pairs of nitrogen atoms of the atmosphere, stored in the nitrogen which became the nucleus of the nerve cells. These shortest of wavelengths developed in the brain and nervous system, while they do not affect the personal magnetism in the readily recognized way that those of the Individualistic thought-cells do, give the nerves both greater range in broadcasting and the most efficient type of receiving set to pick up broadcasts from other minds, whether those minds are incarnate or discarnate.

The nervous system is specially adapted to broadcasting and clear reception of thoughts; and is not so sensitive to impressions as when the slightly longer wavelengths of the Utopian thought-cells are the dominant influence. Because the natural antidote, the Aggressive thought-elements, are so positive, even though the Universal Welfare thought compounds are quite negative, they do not require the application of the Power thought-elements.

To add the Aggressive thought-elements to the compartment of the astral body containing the Universal Welfare thought-cells, some actively requiring positive

work and initiative should be undertaken in association with the things of this department of the life, which will benefit a large and deserving group. The Aggressive thought-elements are very easily applied to such discordant thought-cells, mapped in the birth-chart by inharmonious aspects to the planet Pluto, merely by going into some active campaign for the benefit of society as a whole, or some worthy part of it.

To add the Aggressive thought-elements more specifically to the Universal Welfare Dynamic Structure, whenever thoughts enter the consciousness relating to psychic difficulties, or to difficulties with some group, they should be immediately displaced by thinking about some episode in the life in which initiative and courage were exercised. Or the thoughts may be turned to some contemplated activity requiring initiative and courage. The difficulty, whatever it may be, should be completely banished from the consciousness by Aggressive thoughts that have for their object worthy attainment or construction of some kind. The circumstance that these thoughts are deliberately cultivated to supplant the discordant Universal Welfare thoughts is sufficient association to cause them to enter into the compound where these are located.

Chapter 4

Serial No. 98
Original Copyright 1937
Elbert Benjamine

Copyright
Church of Light
August 2002

Just How to Apply a Mental Antidote

Chapter 4

Just How to Apply A Mental Antidote

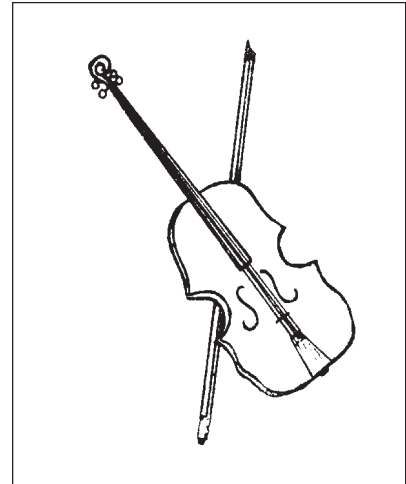

ALL organic activity, whether that activity expresses chiefly on the three-dimensional plane or chiefly from the four-dimensional plane, is due to releases of desire energies by the thought-cells and thought structures of the unconscious mind. Whether such releases bring events into the life which are fortunate or events which are disastrous is wholly determined by the direction in which the desires of the thought-cells and thought structures have been Conditioned to release their energies. The work of mental alchemy, therefore, is chiefly that of Conditioning and Reconditioning desires in such a manner that when they release energy it will be in a direction to attract only fortunate events.

Experience stores in the stellar-cells and four-dimensional structures energies of specific kinds. Some, belong to the Aggressive family, seek strifeful activity; some, belonging to the Religious family, strive for expansive activity; some, belonging to the Power family, impel to actions that influence significance; and so with the other seven families. We call this desire energy derived from a certain type of experience an Urge. And the nature of the Urges can not be changed. That is, we can not change a Power Urge into a Safety Urge, nor a Social Urge into an Intellectual Urge. Each type of thought-element always expresses through its characteristic type of thought activity.

But by association with another thought-element its desire-energy can be made to perform a quite different than usual type of work. Hydrogen, for instance, always expresses as hydrogen, and never as oxygen. Both are highly inflammable gases. When brought together under certain conditions they explode. Yet when otherwise Conditioned they unite as water, a combination which commonly is used to extinguish fire rather than to produce it. Thus also can thought-elements be joined to do a work that neither can do alone; and which both combined are not capable of performing except when they are properly Conditioned.

The joining of thought-elements so that they combine as a thought compound within the astral body, and thus become added to the psychoplasm of the thought-cells, is under the same law which governs all mental processes, that is, the LAW OF ASSOCIATION. Thoughts or mental images are related to each other only through

Resemblance or Contiguity. And all thinking, either by the objective consciousness or by the unconscious mind, is due to the affinity or antipathy of the desire energies of thought-cells and images released through a chain of ASSOCIATIONS in which Resemblance or Contiguity play the important part.

Either because they are in the same proximity of space or time, or because they are similar or dissimilar, mental images, thought elements, and other mental factors are united in the mind, and consequently when opportunity for energy releases occur, express their energies together. We thus remember one event because, through Resemblance or Contiguity, it is joined to another event or thought which has been before consciousness. And because we know that experiences thus enter into union with other experiences or with the thought factors already present in the unconscious mind according to this universal mental law, we know just what to do to cause a thought or experience to enter into a mental compound with another thought or mental factor.

Whenever we think about the likeness or unlikeness of something new before the attention to some experience, mental image, or thought that has entered consciousness on a previous occasion, we unite that which we are now thinking about to the earlier mental factor through Resemblance; and because now, in order to think about the resemblance both must be before consciousness, we unite them also through Contiguity. Even if the thought of similarity or contrast is absent, merely to think of the two experiences, images, or thoughts at the same time unites them by Contiguity.

As these are the only two ways by which thought factors are ever united, or thought-elements joined in a mental compound, it is obvious that when we desire to build a compound after a predetermined pattern we must employ one, or better still as giving a more powerful union both, of these two methods, That is, to cause a thought or mental image to combine with another thought or mental image, both should be thought about at the same time, and their similarity or dissimilarity considered in detail.

Whatever thoughts, therefore, have been built into the unconscious mind in the past, and now form a portion of it, can be made to enter into combination with any other family of thoughts merely through thinking about them at the same time, and comparing them as vividly and energetically as possible. In fact, whatever compounds now are present in the thought-cells and thought structures of the unconscious mind, and which are entirely responsible for the events which come into the life, have been formed in precisely this way. There is no other manner in which they can be formed.

But accompanying every experience, in addition to its family energy, that is, which designates it as Aggressive, Utopian, Intellectual, etc., there is the energy of feeling. And it is this Conditioning energy, this quality of pleasure or pain, which determines the direction in which the energy will work when it finds opportunity for release.

As explained in lesson No. 96, the type of compound formed when two thoughts are united through the LAW OF ASSOCIATION depends entirely upon, not the family energy of their thought-elements, but the quality and volume of feeling which accompanies their union. It is this feeling energy which Conditions their desires to strive to express in a certain manner. Each thought-element has its own manner of expression. But when united with other thought-elements it is the pain or pleasure, and its kind and intensity which determines whether, when it has opportunity to express according to its family, it desires, and consequently works for, those things which are detrimental, or for those which are beneficial.

There are ten different types of compounds into which it is possible for almost any two of the families of thought-elements to enter. They are thus different because the volume or quality of the pleasure or pain which accompanied their formation is different. But broadly speaking, they are classed either as harmonious compounds or as discordant compounds. Harmonious compounds are formed when the Conditioning energy accompanying their formation is that of pleasure. Thought-cells embracing such compounds work from the four-dimensional plane to attract fortunate events into the life. Discordant compounds are formed when the Conditioning energy accompanying their formation is that of pain. The thought-cells embracing such compounds work from the four-dimensional plane to attract unfortunate events into the life.

General Principles to Be Followed

—If, as readily can be demonstrated is the case, the power of thought-cells to bring into the life events which are unfortunate is not due to the families to which the thought-elements in the compound belong, but is entirely due to the energy with which the thought-elements were joined, it is obvious that if the Conditioning energy is changed the misfortune will be changed.

It is not the family energy which causes thoughts to join in a compound, it is the Conditioning energy, the feeling of pleasure or pain which is coincident with Resemblance or Contiguity. The LAW OF ASSOCIATION which governs all mental processes is the feeling which is present when mental factors are Contiguous or are Similar or Dissimilar. That is, the LAW OF ASSOCIATION is an expression of pleasure-pain relations. In various shadings and diverse degrees these are the only relations the mind can possibly recognize. Thoughts are the reproduction in consciousness of sensations, as is fully explained in lesson No. 57.

Whatever the Conditioning energy which accompanied the formation of a thought-compound, if that thought-compound is to be Converted into a compound the thought-elements of which are united by a different type of Conditioning energy, these elements must be treated with the feeling of pleasure or pain in volume and intensity sufficient to completely alter their relation one with another. Yet as their present form of union is determined exclusively by the feeling energy imparted to them at the time of formation, if feeling energy in greater intensity and volume, but of

another kind, can be applied to them it will, of necessity, break down the old compound and rearrange the elements in a new compound such as this latest and strongest Conditioning energy indicates.

Thoughts are not isolated units, but when thoughts of one family are present in consciousness, thoughts of some other family also commonly enter the consciousness through the LAW OF ASSOCIATION. Nor have the events of the past been isolated one from another. One kind of occurrence usually has been coincident with events which relate to another family of thoughts. Thus have the compounds within the unconscious mind been built. And because such compounds express in characteristic thoughts and actions, and because the most powerful of them are mapped by the aspects in the birth-chart, there are two methods by which the compound responsible for a condition in the life can be ascertained.

Careful observation reveals that the individual who customarily has one kind of fortune relative to a certain department of life habitually thinks about this department of life in a manner quite differently than does the individual who has another kind of fortune relative to it. I mean that close association with those who attain high honors shows that their usual manner of thinking about honor has been very different than those who merely desire high honors and never attain them. And that those who make a success of marriage, have a different attitude toward marriage and the domestic partner than do those who suffer severely through matrimonial relations.

Not only so, but at those particular times in the life when fortune or misfortune is attracted, those closely associated with the individual discern, even before the event has transpired, that the thoughts and attitude of the individual have changed. Even those events which apparently come out of a clear sky and with no warning, are immediately preceded by a change in the thought processes; and people taken into the person's confidence note the mental change that has taken place.

To illustrate by the disease which, next to heart trouble causes most deaths and so far has offered the most stubborn resistance to physical remedies: People who are subject to fear, envy, greed, grief, worry or extreme self-centeredness in their thinking are the only ones who ever have cancer. This does not mean that people who develop cancer are always selfish: for worry, grief, fear and sorrow often arise from an intense interest in others.

We know that only people who habitually have such thoughts are predisposed to cancer because of intimate observations of a great many such persons; and because we have analyzed the birth-charts and progressed aspects of 100 persons who developed cancer. We can not say that a person who has a prominent and afflicted Saturn in his birth-chart will have the disease known as cancer. But we can say quite definitely that a person in whose birth-chart Saturn is not thus prominent will not have cancer; and that he will not become a slave to worry, grief, fear, envy, greed or self-centeredness. In all the charts examined of those who have had this disease, there is not one without this powerful influence of Saturn. And extensive observation has

also indicated that only when Saturn is thus prominent does the person develop this type of discordant thinking.

When this birth-chart position is present, we are warranted in saying that the individual has a predisposition toward cancer, and that given certain conditions the disease will become a reality. Yet some persons who have a prominent and afflicted Saturn do not acquire the disease. That is, they never permit fear, grief, worry, or self-centeredness to dominate their thinking sufficiently that the disease gets a foothold.

We do know from ample observation that a prominent and afflicted Saturn indicates one who thinks about caution, safety and acquisition. The thought-compounds in which the Safety thought-elements are dominant are so active that there is almost a constant release of the desire energies of the thought-cells containing them. Thus the thoughts and actions are constantly colored by the desire for safety in its many forms. But these Safety Urges, which are so powerful that they can not and should not be repressed, if wisely directed can find an ample and satisfactory outlet through careful planning, system, order, persistence, elimination of waste and hard work. Yet when they are thus energetic, and no special training is imposed to divert them into strictly constructive channels, they easily acquire the habit of expressing as fear, worry, greed or self-centeredness. And if they do, the individual becomes definitely predisposed into the direction of cancer.

At the time cancer develops, there is always a progressed aspect to Saturn, within one degree of perfect; very frequently a progressed aspect to Saturn from the Sun. And from observation, we know when people come under a progressed aspect to Saturn, especially if Saturn is prominent and afflicted in the birth-chart, that responsibilities or losses are attracted which, unless some other trend of thinking is deliberately cultivated, bring fear, worry or grief.

In other words, we know quite positively that the planetary positions in the birth-chart which give a predisposition to cancer, also give a predisposition toward discordant and contractive thoughts of fear, self-centeredness, worry and acquisition. And at the time the disease develops these same discordant thoughts and emotions are more than usually dominant in the person's life. Clinical observers report that preceding cancer the patient almost always has suffered a loss, often where the affections are concerned, to which he is unable to become inwardly reconciled. He is unable to relinquish the desire for that which has departed.

We are justified, therefore, especially as these thoughts are recognized to have a profound effect upon the adrenaline secretions, and therefore upon the chemical composition of the humors in which all the cells of the body are bathed, in stating that fear, worry, greed, self-centeredness, and especially acquisitiveness which inwardly holds to that which has been lost, and grieves for it, are the thought-cause of cancer, and always are unusually dominant just preceding the development of the disease.

Or to take another familiar and easily observable example: Blood poison attacks only those who habitually have thoughts of anger, lust, irritation, or strife; and

immediately preceding such an attack those associated with the individual note that he is unusually prone to anger, irritation, lust or combat.

Although the observational work, and statistical research, has not been completed in reference to all the many types of happenings that are attracted into people's lives; the extensive work that has been done indicates that not merely covering the 160 diseases, the birth-chart and progressed constants of which are stated in Course 16, but that for all the more common events that people experience, both the habitual kind of thinking responsible for the event, and the thinking which became unusually active just preceding the event, and which attracted it at that time, can be pointed out in a similar manner.

Research work and statistical studies covering thousands of birth-charts, and the progressions present at the time events occurred, make it certain that whenever any event which is unusual enough to the individual to be considered important by him occurs in his life, there has been an increase in some corresponding kind of thinking.

The normal thought-cell activities for each of the twelve departments of life are different with each individual. These activities determine the normal, or usual, prominence and fortune of the life in each department. The amount of money earned, the honor attained, the health, or the success in love, normal to one individual may be far above that of another because his thought-cells are capable of releasing desire energies in sufficient volume, intensity and harmony to attract such fortune. They may even normally be above what another individual attains at the most fortunate time in his life. It all depends upon the thought-cell activity relative to the department of life.

But, whatever the normal fortune or misfortune, due to the habitual thought-cell activity and the habitual method of thinking which accompanies it, we now know that events which by the individual are considered important because they are somewhat better or worse than his normal, never come into his life except at a time when his thoughts are stimulated in a particular way, as mapped by a major progressed aspect leading into the house of the birth-chart ruling the department of life affected. And such a progressed aspect, as much observation demonstrates, is invariably accompanied by a definite change in the kind or intensity of the thinking, unless it is recognized and an effort made to think in a more fortunate manner. But when a different type of thinking is deliberately cultivated at the time, the event which otherwise would be attracted, does not come into the life.

To use cancer to illustrate, not merely the cause and prevention of that disease, but the cause and prevention of any other misfortune: The habitual worry, fear, anxiety, self-centeredness, or greed is the expression of thought compounds in the astral body in which the Safety thought-elements combined with a smaller amount of other thought-elements under the influence of distressing Conditioning energy. Because pain was built into the thought-compounds, whenever the desire-energy finds opportunity for release, either in thought or in action, it moves in the direction of discomfort.

As released in thought it expresses painfully as worry, fear, anxiety, greed or self-centeredness; and the new energy acquired from such objective recognition is added to the thought-cells from which they gained their impetus. Thus a vicious circle is formed, in which through the attention given their thought-expression, discordantly compounded stellar cells acquire additional energy with which to perform their type of work.

But if, whenever there is a tendency toward fear, anxiety, worry, greed or self-centeredness, the individual thinks about the matters that give rise to these thoughts harmoniously, developing a feeling of pleasure in using system, order, persistence and hard work to accomplish things which are beneficial to others, this feeling will gradually Recondition the Safety thought-elements within the compound. Then their desire energies will cease seeking to express in thought as fear, worry, and anxiety, and will seek to express through ambitions which are pleasantly linked with the welfare of others, and which are unassociated with discordant thoughts.

Furthermore, as the events attracted into the life are due to the work of the thought-cells on the four-dimensional plane, these Safety thought-cells will now, because of the harmonious desire energy they contain, work to attract into the life only conditions that are favorable to the individual, instead of the losses which they attract when they feel distress.

A thought-compound, whether chiefly of the Safety thought-elements or chiefly of some other thought-elements, commonly also contains the thought-elements of some other family. That is, the Safety elements may be combined with the Aggressive elements, the Power elements, or with any of the other elements. They have been built into the unconscious mind together. Such combinations are clearly indicated in the birth-chart, and also can be clearly recognized in the thinking.

That is, if the fear, worry, anxiety, greed, or self-centeredness, when it arises into conscious thought, relates to strife and combat, we may be sure the Aggressive thought-elements are inharmoniously present with the Safety thought-elements in the combination. If the fear, worry, anxiety, greed, or self-centeredness, when it enters the conscious thoughts is related to religion or philosophy, we may be sure the Religious thought-elements are part of the compound. If when it enters the conscious thoughts it is related to intellectual attainments, the Intellectual thought-elements are involved. If it is related to women and domestic problems, the Domestic thought-elements are present. If the thoughts of worry, fear, greed or self-centeredness have to do with superiors, the male sex and the exercise of authority, the Power thought-elements are part of the compound. If they relate to affectional matters, the Social thought-elements are involved; if they relate to ideals and visionary schemes, the Utopian thought-elements are involved; if they relate to independence of thought and action, the Individualistic thought-elements are present; and if they relate to cooperation or coercion, the Universal Welfare thought-elements are inharmoniously contained in the compound.

In the same way, if thoughts of anger, lust, irritation, or strife, when they arise into the conscious thoughts, relate to religion or philosophy, it indicates that the Aggressive thought-elements have combined with the Religious thought-elements; if when they arise into conscious thought they relate to women and the home, it indicates the Aggressive thought-elements are in a compound with the Domestic thought-elements. And in this manner, by recognizing the family to which the thoughts that possess the most feeling energy, and therefore indicate the most important element in the compound, belong, and about what they relate, as indicating the other family of thought-elements in the compound, can be determined the thought-elements of any compound through its expression in thought.

But these thought-compounds also are in definite compartments of the astral body. This determines the department of life experiences with which are responsible for the compound's formation, and the department of life affected by the release of their desire energies. Therefore, if the thought when it arises into consciousness is associated with the welfare of the physical body, this indicates it has its source in a compound in the first compartment; if the thought when it arises into consciousness is associated with money or personal possessions, this indicates it has its source in a compound in the second compartment; if it is associated with brethren or studies, it indicates it has its source in a compound in the third compartment.

In order to apply the principles of Conversion or Antidotes it is not necessary to possess a birth-chart or to know the progressed aspects at the time, although these are very helpful. The cause of difficulties in any department of life can be ascertained from the discordant thoughts which come into the mind when its affairs are before consciousness; the families of thoughts which thus arise into objective consciousness indicating the thought-elements within the compound causing the trouble.

To reach these thought compounds, therefore, it is only necessary to think thoughts with the purpose of using them to displace, or add to, other definite thoughts, such as to displace the fear of the Safety Urges, the antagonism of the Aggressive Urges, or the disruptiveness of the Individualistic Urges. The fact that the new thoughts and those of the old compound are in the consciousness simultaneously is sufficient, under the LAW OF ASSOCIATION, to cause them to unite. Or they may be reached merely by thinking about the department of life as affected by the thoughts held in consciousness. This adds them to the same compartment of the astral body. And as this thinking is done for the definite purpose of changing the thought compounds in this compartment, the new thought-energy and the new thought-elements are added to the proper compound.

Conversion

—Bearing in mind that Conditioning energy, that is, the feeling of pleasure or pain, is entirely responsible for the type of compound formed; when it is desired merely to rearrange the thought-elements within a compound without adding

thought-elements to it of another family, it is apparent that the essential thing is to add pleasant feeling energy to the compound in as much intensity and volume as possible. The thought-cells work the way they do because their compounds have been Conditioned by pain. Therefore, to get them to work just as energetically to bring fortunate events into the life, they must be thoroughly Reconditioned by pleasure.

While the characteristic trend of any family of thought-elements can not be changed, each family can express this characteristic trend either constructively or destructively. Therefore, the first essential in Conversion is to recognize both the destructive and the constructive thoughts that belong to the families of thought-elements within the compound to be converted. Then, whenever the thoughts enter consciousness expressing the destructive, or discordant trend, they should resolutely be converted, through as pleasant associations as possible, into thoughts expressing the constructive, and therefore, harmonious trend.

This process of diverting strong desires to release their energies in a manner characteristic of their own urge, yet through a better channel of expression, the psychologists call Sublimation. As explained in lesson No. 60, to sublimate a primitive desire so that it will find greater satisfaction in a socially acceptable expression, as many pleasurable qualities should be associated with the wished for expression as possible. And the Conversion of a thought-compound, so that the stellar-cells embracing it will work as desired, follows the same general principle. In either case there is a Reconditioning through making the new expression more highly pleasurable than the old.

The technique of Conversion is more difficult than that of Mental Antidotes, because whenever the department of life which is thus to be treated comes to mind there is a tendency, due to the thought compounds in it, to feel and think discordantly. And because whenever the thought families that need conversion come into the consciousness, their painful releases of desire energy tend to stimulate the same kind of thoughts which are responsible for their formation. That is, the thoughts and Conditioning energy which have been built into the thought compound, tend to release their energies in similar thoughts and similar feelings.

To overcome this difficulty, a distinct and intensely pleasurable emotion must be cultivated whenever one succeeds in substituting the harmonious and constructive expression of the thought family for its detrimental expression; whenever one succeeds in thinking harmoniously about the things represented by the two thought families in their relation to each other; and whenever one succeeds in thinking harmoniously about the department of life over which the thought compound has influence.

One, can not, however, just command oneself to feel a particular emotion with any assurance it will then be felt. Enjoyment is a Conditioned response. But each individual has various powerful desires straining for satisfaction, the release of

which, even through thinking about their fulfillment, is accompanied by a feeling of joy or intense pleasure.

It is also true that thinking about the realization of these insistent and irrepressible desires, whatever they may be, builds thought-elements relating to their family, into the thought compounds with which they are mentally associated. But as used in Conversion, their function is more artificially to prime the more stable Conditioning energy which is to be permanently built into the compound and rearrange its elements.

Everyone possesses ambitions or wishes the realization of which he believes would bring intense enjoyment. And it is no difficult matter to think that the constructive and happy expression of any thoughts and actions belonging to any family of thought-elements can effectually be made to aid in such realization. That is, recognizing that fear, greed, worry, anxiety and self-centeredness detract from health, efficiency and success; it is not difficult to perceive, and think about it, how careful planning, system, order, persistence, elimination of waste and hard work will assist to realize almost any fond hope. Or recognizing that anger, lust, irritation and strife attract enmity and opposition, it is not difficult to perceive, and think about, how initiative, courage and constructive measures will aid in the realization of almost any desires.

Nor is it difficult to perceive and think about, how the things relating to two thought families, in their relation to each other, if properly harmonized and blended to mutually aid each other, also can be made to assist in the realization of almost any desire. And thus through thinking about their blending while also thinking about the pleasure to be derived from the realization of the strong desire, this pleasurable Conditioning energy will be added to their union.

Or take any department of life, such as is mapped in a birth-chart by a definite house over which a certain planet has rule. It is not difficult to perceive and think about how a more pleasant and optimistic habit of thought in relation to it will assist in the attainment of some fond desire. Thinking about its affairs at the same time one thinks about the pleasure that could be derived from the realization of the fond desire, adds the Conditioning energy of the fond desire to the thought-compounds within the section of the astral body thus designated.

To apply the processes of Conversion, one must first determine the compound the thought-elements of which need to be Reconditioned. Next one should determine the constructive expression of these thought-elements, the manner in which they should be reunited harmoniously to give the desired result, and the department of life chiefly affected by them. Then should be formulated a plan by which through artificial association in the processes of thinking, the constructive expression can be associated with the pleasant realization of various strong desires: by which the proper combination of thought factors can be associated with the pleasant realization of these strong desires, and by which the department of life chiefly affected by the

thought compound can be associated with the pleasant realization of these strong desires.

These artificial associations, however, while adding both pleasant Conditioning energy and thought-elements to the compound, are not to be considered as the permanent habits of thought by which the Reconditioning is completed. They are just the priming.

After the habit has been artificially established of feeling pleasure in the constructive expression of the thought-elements, they will be so strongly Conditioned to feel pleasure when thus expressing, that there will be no need to continue to associate them with the realization of other desires. As explained in lesson No. 59, Sir Isaac Newton had no spontaneous attachment to numbers; but their association with the pleasant realization of strong desires finally developed a pleasure in the exercise of mathematical ability. Nor was Abraham Lincoln, as explained in lesson No. 59, born with a sympathy for all men. He acquired it through the artificial association of thoughts of other people with his love for one woman. Yet, when the feelings were once established, he required no thought of that early lost love to bring forth his kindness. He had become so Conditioned that the exercise of kindness toward all creatures was a source of constant joy.

**When the Discordant Stellar
Compound is Composed of Mental
Antidotes It Can Be Effectively
Changed For the Better Only By
Conversion**

—When the thought-compound to be changed is mapped in the birth-chart by Mars discordantly aspecting the Moon or Pluto, Jupiter discordantly aspecting Mercury or Uranus, or Saturn discordantly aspecting Venus or Neptune, as the thought-elements within the compound already are antidotes, what they need is to be changed in their mutual relations. Such change, even though in the process further antidotes are added to the compound, is chiefly that of Conversion.

Even without a birth-chart to afford guidance, the habitual trend of thought in reference to certain factors in the life will indicate when such mental antidotes have combined, through the discordant Conditioning energy coincident with their formation, in a detrimental thought compound. But however ascertained, due to the fact that the elements in the compound are mental antidotes. such discordant compounds are the easiest of all to change into harmonious compounds. Given a little encouragement, in the way of new and pleasant Conditioning energy, and such elements will rearrange themselves as desired. They yield most readily to the process of Conversion.

Mental Antidotes

—Mental antidotes are more easily applied effectively than the process of conversion, because the family of thoughts that are cultivated to overcome the difficulty is different, and consequently not already associated with discordant Conditioning energy where the special compound to be treated is concerned. When thinking and experiences of the nature of the antidote are substituted for the old type of habitual thinking and feeling, there is no pronounced resistance to any pleasure effort is made to develop.

In the endeavor to rearrange the thought-elements within a Safety compound, if that compound has had built into it much distress, it is difficult to think about the things to which it relates in terms of persistence, economy, hard work and system without at the same time experiencing the distress stored by past experiences in the compounds. By artificial association with other pleasurable releases of desire energy it is possible to do so, and thus alter the compound through Conversion. But this is less easy than to think about love, entertainment, social matters and friendship as contributing something highly pleasurable to the life, or even to the things related to the Safety compound.

As explained in detail in lesson No. 97, each family of thought-elements can express destructively, and thus attract misfortune, or it can express constructively, and thus attract good fortune. And in the application of mental antidotes, no less than in conversion, the thoughts and feelings should be exclusively those of the constructive side of the thought-element's expression. The difference between the two methods is not in the manner in which the thoughts are applied, so much as that the family of thoughts used to accomplish the desired work is not the same.

From a consideration of the events that have been experienced, from a consideration of the habitual thoughts, or from a consideration of the birth-chart and progressed aspects, the antidote that will alter in the desired manner the compound to be changed is selected. This antidote belongs to one of the ten families of thought-elements.

To do the work required of it, it must be applied along with a volume and intensity of pleasure; and as essential in this, the thinking must express only the constructive trend of the thought-families expression. That is, if the Social thought-elements are applied as antidote, experiences and trains of thought should be cultivated which relate to the joy and happiness of love or friendship, to feelings of elation in the contemplation of works of art, or rapture in listening to good music. Social relations which result in unpleasant emotions, or the contemplation of past experiences in which love has been unrequited or friendships have been broken, or in which sorrow has arisen from affection, should not be employed as antidotes.

Thus in selecting any antidote, only thoughts and experiences relating to the proper thought family should be used; and it is necessary through some means to acquire an unusual volume of pleasure in employing them. Yet one can learn to take a high

degree of pleasure in any type of experience or trend of thinking, by associating it as intimately as possible in the mind with thoughts of experiences which habitually give much pleasure.

Essentials in Applying Either Conversion or a Mental Antidote

—Whether the attempt is made to change a thought compound through merely rearranging the elements it already contains, as in conversion; or through adding to it another thought-element which, because of its natural and harmonious affinity for the element chiefly responsible for the discord, builds a new type of compound, which is the method of mental antidotes; certain factors are essential to success.

First of all, after careful analysis of the nature of the compound within the astral body responsible for the difficulty, or which for some reason it is desirable to alter, a definite kind of thinking must be decided upon which most effectively will bring about the desired change. And some method must be devised, by which this new line of thinking will become habitual, and it will always be remembered to use it when the old type of thinking which it is used to displace starts coursing through objective consciousness.

When muddy water is placed in a bottle, muddy water comes out in pouring, unless it is first changed. If disagreeable Conditioning energy is placed in a thought-compound, when the compound finds opportunity to express, disagreeable energies come out; that is, energies which impel to four-dimensional and three-dimensional actions which are unfortunate. Therefore in either Conversion or applying Antidotes the most important factor of all is that a high degree of pleasure accompany the experiences and thoughts which have for object the changing of the thought-compound within the astral body.

As one can not force oneself to feel intense pleasure in a given line of thought or given activity, to insure that the Conditioning energy which is applied to the thought-compound is intensely pleasurable, with as high a harmonious emotional content as possible, it is usually necessary at first artificially to associate the decided upon thinking and activity with the satisfaction of other desires which already are so conditioned that their release, even through thinking intently about their expression, gives rise to intense and pleasant emotions.

After a certain amount of practice of this kind, it will be found that the new mental attitude, new trains of thought, and new activities will give rise to the intense and pleasant emotions, without the necessity of thinking about the satisfaction of other desires.

They will acquire a pleasure all their own; so that their expression is habitually accompanied by pleasure such as builds harmonious Conditioning energy into the compound to which they are related.

This, therefore, either in Conversion or in applying Mental Antidotes, is the most important thing to be sought; that the individual after a time shall be able to think, and without artificial association to act as priming, the kind of thoughts he has selected to apply, and that they shall give rise to feelings well charged with pleasure.

In order that the thought-elements thus cultivated and thus charged with harmonious Conditioning energy shall reach and enter the compound within the astral body selected for alteration, the Law of Association is employed in three distinct ways.

1. When thoughts come into the objective thinking belonging to the family of thought-elements which are dominant in the compound to be changed, the new and selected type of thinking is immediately substituted for them. The selected thinking, substituted for the old, is thus added directly to the dynamic stellar structure requiring change.
2. Whenever thoughts come into the mind relating to the department of life chiefly affected by the compound to be changed, the new and selected thinking should be used. And opportunity should from time to time be cultivated to think of this department of life in association with the new and selected kind of thinking. Thus will this new thinking be added to the same compartment within the astral body in which the compound requiring change resides.
3. When the attention is attracted to the relation existing between those things in life signified by the two thought-elements of the compound, or between the departments of life which they chiefly influence, the selected kind of thinking should be associated with these things. This will add the energy and the thought-elements of the selected mental activity directly to the compounds the composition of which it is desired to alter.

Chapter 5

Serial No. 99
Original Copyright 1937
Elbert Benjamine

Copyright
Church of Light
August 2002

Just How to Heal Yourself

Chapter 5

Just How to Heal Yourself

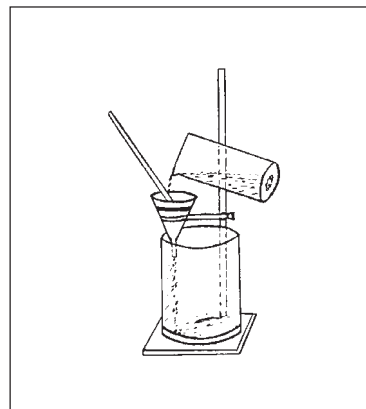

MORE commonly those who speak of healing refer to correcting merely the ailments of the physical body. But viewed from the broader standpoint of Mental Alchemy there are twelve distinct departments of each person's life, of which the health of the physical body is only one. What happens in each of these departments is determined by the volume of energy and the organization of the thought compounds, thought-cells and mental structures within the one of the twelve compartments of the unconscious mind relating to the affairs of this section of the total life. Health and disease, from this broader viewpoint, are terms equally applicable to each of man's outstanding relations with his environment.

If his relations with any section of his environment are unsatisfactory, this is a certain indication of inharmony or lack of power on the part of thought compounds within a definite compartment of his astral body. And the only way he can permanently insure more favorable conditions in this department of life—in physical vigor, in finances, in knowledge, in the home, in love, in work, in marriage, in collecting debts, in public expression, in honor, in friendship or in secret undertakings—is through such an alteration of the thought compounds within the compartment of his astral body relating to the department as will give them more energy or a more harmonious expression.

Manipulating the Physical Environment

—When the proper changes have been made in the compounds that form the thought-cells embraced within a certain compartment of the astral body, this Reconditioning of the desires of these thought-cells causes them to work from the four-dimensional plane to attract into the life those physical things most favorable to fortune in the corresponding department of life. Yet even before such changes have been completed, the individual can assist by an intelligent selection of the physical environment favoring a better fortune; for the most of the events and conditions of physical life are dependent upon physical things.

We can neither help or harm people unless in some manner we contact them, nor can they help or harm us without such contact. We can not acquire those possessions which give wealth unless we have access to material resources. We can acquire only a limited amount of information unless we are able to get assistance from books or from intelligences possessing information. Fortune in the home is dependent upon a domicile and people in it. Love affairs and children require human associations. Food is not manufactured from nothing; it grows and must be acquired. Marriage and partnership include human companions. Inheritance is usually considered in terms of physical things. Public expression, to be successful, requires certain material facilities. Honor is measured in terms of human relations. Friendships can prosper only if there are friends. And secret enemies are dependent upon beings other than ourselves.

Each of the twelve departments of life, as thus shown, is dependent for its health upon proper conditions in the physical environment. And if those most favorable environmental conditions are provided through intelligent effort, this takes a great burden from the task of the thought-cells within the unconscious mind.

These thought-cells, or stellar-cells, as they also are called, can move the physical environment either in the direction of fortune or misfortune only to the extent they possess or acquire energy. And with the same amount of energy at their command the degree in which they can move the physical environment depends upon the weakness of its resistance. The environment may be such that no amount of energy the thought-cells can muster can overcome its resistance and bring into the life some particular event. Or it may be such that almost no effort must be spent by the thought-cells from the four-dimensional plane to bring the event to pass. What happens on the physical plane is never dependent upon the four dimensional energies alone, nor upon physical environment alone; but upon the resistance, or its lack, of three dimensional factors to four-dimensional energies.

This means that in attaining health in any one of the twelve departments of life the physical factors should not be ignored. While true that, if the thought-cells governing the fortune in a department of life are given sufficient harmony they will attract, by their four-dimensional activities, the proper physical conditions to remedy the difficulty, yet they will require less energy to do the same thing if the proper physical conditions are provided through the exercise of objective intelligence.

Physical health, for instance, requires that certain physical elements be taken into the body in the form of food. In spite of any thinking one can do, if the food supply is deprived of calcium or vitamin D, or its equivalent in sunlight, nervous troubles will develop. The thought-cells can not manufacture calcium out of air. Without calcium to counteract and stabilize the influence of phosphorus and potassium the nerves become over tense, irritated, even inflamed. Or if there is an excess of magnesium and not sufficient calcium present to balance, the nerves become flaccid and the individual responds so slowly to stimuli that he is considered dull and inert.

The stellar-cells of the astral body, as explained in lesson No. 95, have whatever intelligence has been imparted to them at the time of their formation. And if the stellar-cells responsible for a bodily disease are properly Reconditioned and supplied with sufficient harmonious energy, they will impress the individual who needs calcium and vitamin D to acquire these necessities. But their four-dimensional work will be made vastly easier if the individual is aware he needs these elements and consciously takes steps to get them. In fact, if the individual exercising intelligence thus secures what he needs in the way of physical ingredients in his food, the Reconditioned stellar cells will require the expenditure of but a minimum of energy to be able to build a healthful physical body.

Or to take another commonplace example: Physiological chemists tell us that the human system requires four different protein compounds which it seems unable to manufacture from other proteins. Very little of one of these four, histidine, is contained in milk. Usually milk also contains less iron than the system requires. Therefore, unless proteins and iron are obtained from some source other than milk the blood of an adult becomes impoverished. An infant usually has sufficient iron stored in its liver to carry through the first year.

In the case of an individual suffering from anemia, for instance, the thought structures mapped in the birth-chart by Saturn, Neptune and Mars when properly Reconditioned would impress him to eat foods containing iron, a variety of proteins, some copper, etc. If they were unsuccessful, through not possessing enough energy to overcome the resistance of environment to his acquiring these materials, in getting him to eat foods containing these things, he would remain anemic in spite of all his thinking; for the hemoglobin of the red blood corpuscles is not composed of air, but of definite chemical substances. It is not the function of thought to manufacture iron which must be present in the hemoglobin to carry oxygen; but it is a function of proper thought to acquire the iron, with which to replace the daily loss through the wearing out of red blood corpuscles, from foods containing iron.

What has been said in regard to the physical requirements of bodily health is equally true in reference to the health of each of the other twelve departments of life. It is not the function of thought to manufacture wealth out of thin air. Wealth is derived from raw materials and natural resources, from processing these raw materials, or from services relating to these things or rendered to members of society. The Reconditioned thought-cells within the astral body that had their origin in experiences relative to wealth will work with what intelligence they possess to attract sources of wealth into the life. But if an individual should refuse such contacts, the resistance offered by such an environment would be too great for the energy they possess to overcome. Yet on the other hand, if the individual intelligently associated with those sources of wealth most harmonious to himself, the Reconditioned thought-cells would require very little energy to bring him wealth.

Just what the physical environmental conditions are which, at a given time most favor the attaining of desired results, or most hinder the development of an undesired event it is the function of the birth-chart and the progressed aspects to inform us. Yet

if already we are aware of the disease, in whatever department of life it manifests, even without a birth-chart we can get a rather clear picture of the type of thinking which is responsible for it. And this in turn will point not merely to the changes in thinking necessary for its correction, but also indirectly to the physical requirements with which the Reconditioned thought-cells must work to bring the better condition about.

In Course 16, Stellar Diagnosis and Stellar Healing, the Birth-Chart Constants and the Progressed Constants of 160 bodily diseases are given.

They are given, as determined from statistical studies of the birth-charts and progressed aspects of people thus afflicted in terms of the prominence and aspects of planets. But as a prominent planet maps a thought structure in the astral body which gives rise to an equal prominence in the kind of thinking denoted by the planet, and as an aspect maps the harmony or discord of the compound in the thought-cells, and thus the pleasure or pain of the thinking thus energized, both Birth-Chart Constants and Progressed Constants denote the specific family and kind of thinking which is responsible for the condition, whatever it may be.

Furthermore, the Birth-chart Constants which make for success in many vocations have been ascertained, and both the Birth-chart and the Progressed Constants which coincide with a wide variety of events; events which relate favorably and events which relate disastrously, to each of the twelve departments of life. These in turn indicate the family, volume and harmony or discord of the thinking which is responsible for each of these various events. And it is the function of the Church of Light Research Department to ascertain these Constants, and therefore the exact kind of thinking, which is responsible for each important condition and each important type of event which enter people's lives.

In connection with each condition and each event, whether it is beneficial or detrimental, there are environmental factors which assist the kind of thinking which is responsible, to attract the condition or event, or which hinders it. In Course 16, the type of foods which facilitate recovery from each of the 160 bodily diseases is briefly set forth. More specific information is given in lessons 222, 223, 224 and 225 of Course 21.

When a particular family of thought-cells acquires an additional supply of discordant energy, through a progressed aspect forming an aerial to pick up the corresponding planetary energy with much static, the release of desire energy by these thought-cells tends to cause the individual to neglect certain substances in his diet that are especially necessary at this time, due to the kind of thinking in which he indulges, to his bodily health. These special diet requirements have been ascertained. One does not need to know about progressed aspects to avail oneself of this knowledge, although this gives one greater precision in determining the need. If a person, for instance, indulges in fear, greed or worry, one may be sure he needs the foods recommended when Saturn is afflicted by progression.

The lessons on Stellar Dietetics, Nos. 153, 222, 223, 224 and 225, give the environmental factors in so far as food requirements are concerned, which under each type of bodily affliction is best calculated to assist the thought-cells to recover health. And in Course X, especially in lessons Nos. 111, 112, 113 and 114, are set forth in sufficient detail the kind of environmental conditions which offer the greatest resistance to the efforts of discordant thought-cells when they endeavor to attract various kinds of misfortune into the life, and the factors of physical environment which most readily aid the efforts of harmonious thought-cells to bring various kinds of good fortune into the life.

Instead, therefore, of expecting the thought-cells which have been Reconditioned through the process of Mental Alchemy to do all the work required to bring health to any of the twelve departments of life, their four dimensional labors should be facilitated by the conscious and intelligent selection of those physical environmental factors which most readily can be used by them in the attainment of the desired end. The Israelites are supposed to have rebelled when called upon to make bricks without the straw necessary to bind together the adobe. The easier you make the work required of the Reconditioned thought-cells, the more confidence you may have they will possess sufficient energy to accomplish it.

Using Rallying Forces As Aids In Reconditioning Thought-Compounds.

—As the events attracted into the life, including health and disease, relative to any one of its twelve departments, are determined by the resistance of the external environment to the four-dimensional activities of the stellar-cells in the corresponding compartment of the astral body, the more energy the thought-cells of a given compartment acquire, the more influence they have to attract events of importance. And at the time, as explained in detail in lesson No. 19, a temporary stellar aerial is formed, as mapped by a progressed aspect, affecting this compartment, the stellar-cells in it gain an additional energy supply with which thus to work toward attracting some event.

Whether the event attracted, or the condition affecting the health of the department of life, is to the benefit of the individual or to his detriment is determined by the pleasure or pain felt at the time by the thought-cells doing this four-dimensional work. This pleasure or pain, in turn, is determined by the manner in which the thought-compound within the stellar-cells was Conditioned at the time of their formation, as modified by the harmony or discord of the temporary energy reaching them. A discordant progressed aspect adds energy loaded with painful static to them, and temporarily Conditions them to act more detrimental than is their usual habit; while a harmonious progressed aspect adds energy of pleasing harmony to them, and temporarily Conditions them to act in a manner more beneficial than is their common custom.

It will not here be necessary to explain in detail how the nervous system, in response to the feelings which at the time are dominant, tunes in the electric energies flowing over it to pick up astral vibrations of a corresponding rate; nor how these energies from the planets, from the character-vibrations of objects and from the thoughts of people, because these nerve currents permeate every region of the body, reach all the permanent and temporary stellar aeriels, such as are mapped by birth-chart aspects and progressed aspects, and thus the thought-cells fed by these aeriels.

These matters are fully explained in lessons Nos. 198, 110 and 61, where it is further pointed out that so long as an individual keeps his consciousness and feelings tuned to one type of vibration these are the ones picked up and added as Rallying Forces to all the various thought-cells reached by aeriels. That is, so long as a certain feeling is dominant, the person is so completely tuned in on a specific wave-length that other wave-lengths of energy are not strong enough to make their influence felt at the receiving sets which transmit energy to the thought-cells. The only program received distinctly by any of the thought-cells within the astral body during such a time, is the one tuned in on by the intense feeling.

So far, therefore, as new energy supplies reaching the thought-cells are concerned, through inducing and maintaining the feelings he desires man can determine, in spite of progressed aspects, what these shall be. Yet thought-cells may, and often do, possess so much inharmony that any amount of temporary harmony reaching them as a Rallying Force is insufficient to cause them to act in a beneficial manner; and other thought-cells may, and often do, possess so much harmony that any amount of temporary discord reaching them as a Rallying Force is unable to cause them to act in a manner wholly detrimental. In fact, as determined by a vast amount of statistical work in connection with birth-chart positions and progressed aspects, the energy with which the compound was Conditioned at its formation is more important in determining the harmony or discord of the work done by the thought-cells when that energy is released than is the quality of such temporary energy as may be added to them.

Permanently to correct a serious disease in any one of the twelve departments of life it becomes necessary, through some process, more harmoniously to Recondition the thought compound in the stellar cells chiefly responsible for it. Yet the mere temporary adding of Rallying Forces, unless these are specifically directed to do that work, commonly does not sufficiently change the basic desires of the thought-cells; but only for the time increases their activity.

Furthermore, a Rallying Force is of a definite planetary type; that is, it belongs to the Aggressive quality, the Religious quality, the Power quality, etc. Consequently the energy it adds to a thought-cell group or thought-compound is of that quality and temporarily similar in effect to the thought-elements belonging to the same family. It should be selected, therefore, just as the thoughts are selected, with due reference to what specific type is required as a Mental Antidote or to effect Conversion. Then by associating it with thoughts and experiences definitely chosen for the purpose of altering the thought-compound, it can effectively be employed to give the required

energy to divert the desires of the thought-cells permanently toward activities fortunate to the individual.

Each individual, because of the particular thought-cell composition of his astral body and the stellar arials connecting his most active dynamic stellar structures, can acquire harmonious Rallying Forces belonging to certain thought families much easier than he can acquire the harmonious Rallying Forces belonging to other thought families. It may be that these most easily acquired Rallying Forces are not those specifically required properly to alter the thought-cells whose discordant compounds are responsible for his misfortune. In case they are not, he must cultivate the other sources of Conditioning Energy which are specifically required to make the alterations necessary to overcome the disease. But as a rule, even when of a character not specifically required in the treatment of the disease, because they are acquired in volume and in harmony with so little effort, and when thus tuned in on add harmonious energy to all the thought-cells, they can be made of great value in general to health and fortune.

Such Rallying Forces as are picked up, radio fashion, by the permanent arials mapped by birth-chart aspects, or by temporary arials mapped by progressed aspects, are not well defined thoughts, nor are they thoughts relative to any particular department of life. Instead, they are energies which give rise to intense feelings which are associated with whatever subject or department of life the person at the time is thinking about. To the extent, while a Rallying Force is present, whether induced volitionally or without intent, an individual thinks clearly and definitely about some particular thing, does the energy of the Rallying Force tend to Recondition in its direction the thought-compound in the stellar-cells relating to the department of life thus thought about. But such energy as is thus added to the compound is always of a definite planetary type. That is when one feels Aggressive one is adding Aggressive thought-elements along with the Aggressive Conditioning energy to whatever thought-compound the definite thoughts relate, even if they relate also to Safety or to Power.

Lesson No. 200 explains the details of tuning in on any selected planetary energy it is desired to use, whether there is, or is not, a strong aerial within the astral body of the proper length to pick it up. And lesson No. 201 gives considerable information on using the energies thus selected and tuned in on for healing purposes. The technique of tuning in is that of inducing and maintaining the feeling of the constructive energies of the selected planet. The technique of applying them is as vividly as possible to think of the things of the department of life to be healed, while the feeling is present. This will Recondition the compounds within the thought-cells relating to them.

As is fully explained in lessons Nos. 59 and 60, the energy of desires can be diverted through properly selected ASSOCIATIONS to flow in any channels decided upon. This applies equally to the desires of the thought-cells to work in a given way from the four-dimensional plane, as to the desires of which we are objectively conscious which relate to our three-dimensional activities. To hold certain thoughts definitely

in mind while feeling a certain emotion whether derived from a Rallying Force or from any other source, is to charge those thoughts with the specific planetary type of Conditioning energy of that emotion. The greater the intensity of the energy imparted to them, the more powerful to accomplish work do the thoughts associated with it become.

The Conversion of thought-elements within a thought-compound, or the adding of Mental Antidotes to the compound, is effective to produce an alteration in the compound in proportion to the volume and intensity of the Conditioning Energy added to, or developed within, the thought-compound to be changed. Mental Antidotes possess some spontaneous ability to generate pleasant Conditioning energy when added to a compound. But their Power to Recondition the thought-compound properly, and thus produce the healing result desired, is greatly increased if they are added along with a conscious feeling of intense pleasure. And the Conversion of a thought-compound through the rearrangement of its thought-elements requires the conscious use of pleasant Conditioning energy.

However, either in the application of Mental Antidotes or in the process of Conversion, if the compound is to be changed in the manner decided upon, this Conditioning energy can not be just any harmonious Rallying Force that the individual has special facility to generate. Usually such a harmonious, and easily acquired Rallying Force, will be found highly beneficial to the compound, because it is already Associated with the family of thought-elements which is most beneficially Conditioned within the person's astral body. Adding these harmoniously to any other thought-compound within the astral body thus is usually advantageous. But if the compound is to be altered in the most beneficial way, the harmonious Conditioning energy must belong to the planetary type of the thought-elements added or changed.

The Easiest Source of Harmonious Conditioning Energy

—While the most easily acquired Rallying Forces may not be the ones specifically required to heal some department of life which is diseased, they are, nevertheless—for instance, when they belong to the same planetary family as the mental antidote—sometimes the ones most needed, and they can always be made of great general value to the life. How they may be determined, therefore, should be understood.

Each person, because of the stellar arials stretching across his astral body, picks up certain planetary energies in volume and with less static, than he picks up other planetary energies. Because of these incoming energies, he finds it easier to feel intensely harmonious when tuned in on them than when tuned in on other planetary vibrations.

A planet in the birth-chart which is prominent and receives only good aspects, maps a powerful group of thought-cells which commonly receive over these aeries mapped by the aspects only harmonious energies. This group of thought-cells, therefore, whenever they find opportunity to release energy through connecting up with the electric currents of the nervous system, tend to tune the individual in, through the pleasant sensations felt, on the harmonious energies radiated by the planet. A well aspected planet in the birth-chart, therefore, maps a harmonious Rallying Force which is easily tuned in on, and can be used with less effort than can energies whose vibratory rates are not already an integral part of the character.

In particular, there are two configurations which when they do appear in a birth-chart indicate powerful sources of harmonious and easily acquired Rallying Forces. One is a Grand Trine, in which two planets in the chart are in trine aspect to each other, and both are in trine aspect to a third planet, making thus approximately an equilateral triangle of the stellar aeries stretching across the astral body. In those things represented by the Grand Trine the individual will be fortunate, because the thought-compounds in the dynamic stellar structure mapped by each planet are both harmonious and possessed of a high degree of energy.

Therefore, to the extent the person having such a Grand Trine devotes his energies to the things of the departments of life indicated by the compartments where these harmonious thought-cells reside will in his life encounter exceptionally good fortune. The stellar-cells will work energetically from the four-dimensional plane to attract favors and success to him relative to the matters associated with their formation. Our interest here in a Grand Trine, however, is that its spontaneous harmony and strength enables it so readily to be used as a source of beneficial Rallying Forces. It is easy to induce and maintain the pleasant feeling which in quality corresponds to one or more of its planets; and because there are stellar aeries in the astral body of proper length to pick up this energy readily and in volume, this makes powerful and beneficial Rallying Forces available with little effort.

The other planetary configuration which indicates a specially potent and harmonious source of Rallying Forces is a planet which, as often occurs, breaks up an opposition aspect between two other planets by making the sextile aspect to one and the trine aspect to the other. The opposition maps an aerial which picks up planetary energy loaded with separative static. But such an opposition also maps at each terminal thought-cells into which have been built a tremendous amount of energy. This energy, from both groups of thought-cells at the ends of the opposition, is tapped harmoniously by the group of thought-cells mapped by the planet making the sextile and the trine.

To the extent, therefore, the individual devotes his energies to the things of the department of life indicated by the compartment where reside the harmonious cells mapped by the Conciliating Planet, will his life encounter exceptionally good fortune. And as in the case of a Grand Trine, this Conciliating Planet which in this relation draws for power from the opposition, maps a source of powerful harmonious energy which may readily be tapped, and which tunes the whole nervous system in

on the harmonious vibrations radiated by the Conciliating Planet. Because the stellar aerals present in the astral body that lead to the Conciliating Planet are of a length to pick up its energy harmoniously and in volume, it is easy to maintain the feeling and thus acquire a steady supply of powerful Rallying Forces.

Not everyone, however, has either a Grand Trine or a Conciliating Planet in his birth-chart. But everyone has a Best Planet in his birth-chart, which maps the most harmonious dynamic stellar structure within his astral body, and this is the receiving set which has the greatest facility for tuning his nervous system in on powerful harmonious planetary energy.

Furthermore, when progressed aspects form, each, to the extent it is powerful, builds a temporary stellar aerial across the astral body. If such an aerial is of the length to pick up harmonious planetary energy, it also facilitates developing and maintaining the pleasant feeling of its planetary terminals. Of course, if these thought-cells at the terminals are of markedly discordant compounds, tuning in on the planetary energies corresponding to them will facilitate feeling discord and thus picking up, radio fashion, more discord. But to the extent either the permanent aerals mapped by aspects in the birth-chart, or the temporary aerals mapped by progressed aspects within one degree of perfect, are present which tend to pick up only harmonious energy, can they be utilized to assist in developing powerful Rallying Forces. That is, it is easy to develop and maintain the feelings corresponding to the planet, and thus persistently to tune in on its vibrations.

Reconditioning Thought-Compounds

—While as indicated, each individual has within himself stellar aerals which make it easier for him to develop and maintain a particular type of pleasant feeling, if some special thought-compound within his astral body needs Reconditioning in a definite way, in some manner harmonious feelings must be developed of a type corresponding to the Conditioning energy required for the alteration. That is, if it is pleasant Jupiter energy which is needed to Recondition the thought-compound, no other type of energy will do so well. Yet even though there is no harmonious aerial to the planet Jupiter, either in the birth-chart or by progression, nevertheless harmonious Jupiter energies can be developed as Rallying Forces.

In that case the work will be more difficult. It will require greater effort to keep the benevolent, jovial, Jupiterian mood. And the more the person really needs these Rallying Forces, that is, the further removed temperamentally he is from Jupiter, the more effort will be required for him to keep himself feeling strongly and harmoniously in the Jupiterian mood.

Yet irrespective of special stellar aerals, if an individual places himself in a mood strongly characteristic of any planet's vibrations, the electric energies of his nervous system tune in on that planet's vibrations, and these following the nerves reach all the

stellar aerals within his astral body and find some access to all the thought-cells. Thus can an individual acquire, through effort, whatever type of planetary energy he most needs.

But before any such attempt is made he should, as explained in lesson No. 96, first determine the thought-compound and the type of thinking which is responsible for the condition he wishes to correct. From this information he should, through the methods set forth in lessons Nos. 97 and 98, decide whether it is better to use the method of Conversion, which is the only alternative if the compound causing the difficulty is composed of Mental Antidotes, or to use a Mental Antidote. If the latter seems to be the best method to follow, he should then select, according to the principles set forth in lesson No. 97, the family of thoughts that is the suitable antidote.

Having selected the antidote, or decided upon Conversion, he should next outline specific plans for developing the required kind of thinking, and energizing it harmoniously with as powerful feelings as possible. Included in this plan should be the determination to substitute selected constructive thoughts for those which are responsible for the difficulty whenever these come into the consciousness; and to think about the department of life—about the health of the body if the bodily health is to be improved—only in association with the thoughts and feelings thus decided upon. And to make these selected thoughts effective in the accomplishment of the work contemplated, the plan should also formulate means by which the selected planetary type of feeling energy can be aroused and maintained while these thoughts are before consciousness; or if it seems desirable, can be developed as a permanent mood by which the appropriate Rallying Forces may be added to all the thought-cells within the unconscious mind.

As explained in lesson No. 98, deliberately to substitute one type of thinking for the type which more spontaneously rises into objective consciousness is to add these deliberately selected thought-elements and the Conditioning energy at the time present to the compound of the dynamic stellar structure responsible for the more spontaneous thoughts. The substitution associates them, and the feeling energy Conditions the harmony or discord of the new combination. To think about a department of life adds the thought-elements and the Conditioning energy present at the time, to the thought-cells of the compartment of the astral body relating to the department of life.

When Conversion is the method which seems advisable, the problem is not that of substituting new families of thoughts, but that of substituting the constructive expression of the same families for their more discordant expression, along with feeling energy of sufficient intensity and volume to Recondition the compound to be altered. That is, whenever the thoughts of either family involved in the compound rise into the consciousness, their constructive expression should deliberately be substituted for the expression which is more spontaneous. When thoughts relating to both families of elements in the compound rise into consciousness, as will frequently be the case because of their association in the compound, constructive thinking

about their relation each to the other should be substituted for the more spontaneous type of thinking. And whenever thoughts enter the consciousness relating to either or both departments of life, the thought-cells of which embrace these compounds, the constructive expression of the thought families embraced within these compounds should deliberately be substituted for the more spontaneous kind of thinking about these things. Furthermore, in Conversion, because unless the compound is of Mental Antidotes the pleasant affinity of the elements is lacking, it requires a far higher intensity and greater volume of pleasant feeling to effect the proper Reconditioning of the compound.

Sources of Mental Antidotes and Conditioning Energy

—Every person, in the past, has had a variety of pleasant experiences. And it is very easy to select the family of thought-elements to which the incidents chiefly relate. If the source of pleasure arose mostly from the heightened sense of significance, the incident was responsible for building Power thought-elements into the astral body; and when it is recalled in memory and that pleasure again pondered over, more Power thought-elements are added to the astral form along with harmonious Conditioning Energy.

Perhaps there have been joyous experiences with strife and aggression in the past. These experiences, recalled as vividly as possible, and with as great intensity of feeling as can be engendered, not only build Aggressive thought-elements into the stellar-cells of the unconscious mind, but they add with them harmonious Conditioning Energy.

In thus recalling affectional experiences which have afforded high pleasure, for the purpose of adding social thought-elements to the astral body along with harmonious Conditioning Energy, it is essential, if later experiences developing out of these have been less pleasant, to confine the attention as closely as may be to the briefer period of idyllic love. If disillusionment followed the happier period, one should live in reverie, and as intently and joyously as possible, only in the time when affection was coming into bloom and before its blossoms began to fade.

Living in the past may tend to divert energy from future accomplishment: but when such is deliberately cultivated, with the past experience carefully selected for its Conditioning Energy and as an agent for Conversion or for use as a Mental Antidote, it not only is permissible, but can be made to afford just the thought-elements required, along with the proper quantity and intensity of Conditioning Energy, to alter the thought composition of certain stellar-cells in just the desired way.

At one's leisure it is advantageous to ponder on the various experiences one has had so far in life, with the object in view of selecting those which were at the time most highly pleasurable and at the same time of a character which gained satisfaction for commendable desires. One can briefly analyze them as to the family whose desires

finding satisfaction chiefly gave rise to the pleasure, and note them down under this thought-family classification for use whenever the occasion seems to require the application of these thought-elements along with happy Conditioning Energy.

Even aside from applying Conversion or Mental Antidotes, the most satisfactory method of preventing the mind from being occupied with discordant thoughts which arise in response to difficulties encountered, is to have ready at hand some selected interest which has sufficient pleasure already associated with it that it can displace the discordant thoughts which otherwise would build inimical thought compounds into the finer form. And with a classified list of reminiscences of happy experiences, one is in a position not only to recall something from the past to take the place of intruding mental discord, but one can select the reminiscence thus to be used with the special need in view for a Mental Antidote or Conversion. In this selection from the list one may be sure that the substituted reminiscence will add both the thought-elements and the Conditioning Energy thus engendered, to the mental compound within the astral form which is responsible for the thinking which it is used to displace. That is, the fact that it is used to displace a train of thoughts, associates it with the thought-elements the release of whose energies are responsible for that train of thoughts.

In addition to such reminiscences, there are experiences one hopes to have, and experiences of the imagination, which, to the extent they are vivid and capable of arousing intense feelings of pleasure, can be used as sources of Mental Antidotes and Conditioning Energy. Such trains of thinking can be devised and tested out as to the amount of emotional energy they generate. And they can be listed in the same manner as can reminiscences, for use according to the demand at special times.

It has been said that the joy of anticipation often is greater than that of realization. Most people get a thrill of pleasure in planning the things they like to do.

The planning of security for the future, in which system, forethought, persistence and labor are involved can be made to yield both the Safety thought-elements, and pleasant Conditioning Energy. Most people can acquire quite an intense feeling of satisfaction through contemplating the steps and the results of such carefully thought out security plans. And as thinking about such plans, once they have been formulated and the individual has become accustomed to find joy in them, can be substituted for any other train of thought that enters the mind, the Safety thought-elements and the accompanying Conditioning energy can be added to any structure, or to any compartment, within the astral body.

Nor is it difficult to call up in the imagination hoped for experiences of a religious nature. One can anticipate actions of good fellowship, deeds of benevolence, and the jovial kindness and helpfulness which characterizes the Religious thought-elements. And one can think about the anticipated or imaginary experiences with the glow of kindly feeling that should accompany such actions. Having formulated them once, one can then keep them on tap for those occasions when there is special need of the

Religious thought-elements to afford the proper antidote along with proper Conditioning Energy.

If they are substituted for critical intellectual processes, we may be sure that associates them with the Intellectual thought-elements which are responsible for those analytical thoughts. If they are substituted for distressing thoughts about the home, we may be equally sure that they are then built into the thought-cells of the astral body relating to the home. But if they are not substituted for other thinking they tend to move within the astral body to that section relating to the department of life or that type of activity about which the thinking at the time chiefly revolves.

A still better source of thought-elements and Conditioning Energy than any to be had from reminiscences or from contemplating something yet to come, is that to be derived from actual life experience. To actually do something with the feeling of pleasure in the doing is the most satisfactory way to add thought factors to the astral body. Intentions thus confirmed by action acquire a power through those actions which is difficult to attain through imagination only. Furthermore, the unconscious mind gains a powerful and proper suggestion at the same time; for the action convinces it that actual results should follow. It is better, therefore, to engage in some effort which will concentrate the thoughts and feelings according to the thought-elements and Conditioning Energy desired, than it is merely to call such activities up in the imagination.

And in addition to the application of the proper thought-elements and Conditioning Energy to affect the desired change within the thought-cells of the astral body, which is the process of Mental Alchemy, the healing process will be facilitated by talking to the organs and thought-cells and telling them just what they are expected to do. They each have an intelligence of their own, and tend to respond to suggestions thus given them. Talk to them just as you would talk to an individual, kindly but firmly. And to aid all to cooperate in the desired end, keep the image of perfect health before the attention of the mind.

Chapter 6

Serial No. 100
Original Copyright 1937
Elbert Benjamine

Copyright
Church of Light
August 2002

Just How to Attain Realization

Chapter 6

Just How to Attain Realization

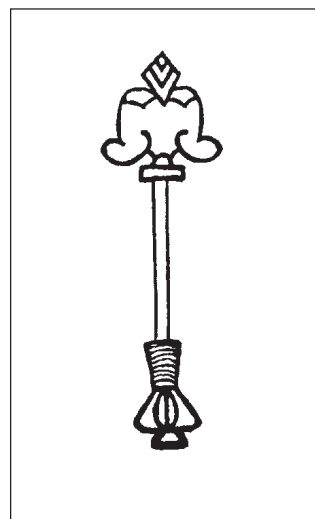

WHEN we recognize that not only our thoughts and physical behavior, but also every event which comes to us, even such events as apparently are due to chance, but which, nevertheless, are herded into our lives through the activities of our thought-cells operating from the plane of four dimensions, is due to the release of desire energies from the thought-compounds within the unconscious mind, the ancient occult proverb, **REALIZE THE TRUTH WITHIN AND THE WITHOUT WILL TAKE CARE OF ITSELF**, is illuminated by a more convincing significance. By the light of this scientific conception, we then perceive that, to the extent we can alter our characters, the cell composition and cell arrangement within our unconscious minds will be changed, the intensity and direction of their desire releases will be different, and our whole fortunes will be correspondingly modified.

Furthermore, we now possess instruments, such as astrological Birth-Chart Constants, Progressed Constants, and psychoanalysis, by which we can determine quite precisely both the composition of the thought-cells, and their organization, along with the type of energy they are likely to receive at any given time, which will enable them to work more vigorously from the four-dimensional plane than usual. That is, the implements are at hand which enable us to measure all the important factors that comprise the character, to gauge the energy of each, and closely to estimate the direction in which their desire energies will be released at any selected time, and thus what conditions and events at that time will probably affect the life.

And this perception of the thought composition of the astral body which is responsible for each trend of objective thinking, each type of physical behavior, and each event which enters the life, leads immediately to the knowledge of exactly what changes must be made in the thought-composition of the unconscious mind to realize any specific condition, to manifest any given talent, or to experience any type of fortune that may be desired.

In the preceding lessons I have given the method by which, through the use of Conversion, Mental Antidotes and Rallying Forces, each particular trouble or disease toward which Stellar Diagnosis shows there is a predisposition, can be avoided. When the thought-composition of the cells or group of cells within the unconscious mind whose release of desire energies are responsible for the affliction,

is changed so that the energy releases are more harmonious, the difficulty, whatever it may be, no longer is attracted. But the individual who aspires to live life at its highest is not content merely to thwart some disease, or merely to make a success in business or matrimony. Instead, he desires to get the utmost out of living, to make of his life as complete a success, physically, mentally and spiritually, as possible.

To do this, it is not enough to apply a Mental Antidote to some one or two groups of thought-cells which have been attracting trouble. What is required is a thorough overhauling of the character, in which all the weak parts are properly strengthened and, where new parts are necessary to attract the desired conditions and events, these are added. This means, of course, a complete rebuilding of the character; for only as the character is thus completely rebuilt is it possible for the conditions and fortune attracted to be of a correspondingly better grade.

Most people have traits, not conducing to the greatest effectiveness in living, which require nothing more than a little reflection to discern. Whenever there is a tendency, for instance, to over-emphasize the importance of anything, as revealed by an abnormally sensitive or violent emotional reaction to certain thoughts or situations, this points to the existence of a complex. It may express as fear, as self-consciousness, as bashfulness with the opposite sex, as a conscious feeling of inferiority or of superiority, as an ungovernable temper, as hysteria, or as touchiness regarding some special subject. And as soon as these are recognized, the methods explained in lessons No. 63 and 65 should be applied until there is an adjustment in the manner in which the desire energies express; the complex being relieved through the habit of diverting its energies so that they flow through constructive channels.

But in addition to these easily recognized trends which block the way to the highest type of living, most of us, as the result of experiences which we have completely forgotten, possess repressions and conflicts within our unconscious minds, which can be uncovered only by the use of a special technique; repressions and conflicts which quite unknown to ourselves, are hampering influences. Therefore, in the task of reorganizing the character, to the end of attracting the best type of fortune, before attempting to build into the astral body new energies or applying Conversion and Mental Antidotes to other discordant thought-compounds, it is well first to handle these desire energies, and put them to some useful work. And in accomplishing this the discoveries of psychoanalysis will prove a singularly happy aid.

Psychoanalysis first was used as a means of relieving the stress of repressed desires through analyzing the dreams. It was found, and later experience fully verified these findings, that many serious diseases are caused by strong desires which are given no opportunity to express themselves in other ways in the life. That is, the activity being blocked that would permit them the expression they desire, they find a subterfuge expression in some disease. Yet in sleep there is less resistance to their being expressed in fantasy, and they find some satisfaction through draining a portion of their energy into a dream in which the desire is gratified.

Yet owing to the censorship exercised by the waking mind, more often than not the dream, as it is remembered, is pictured in such terms as to conceal its true import; for the waking mind having previously prohibited the realization of the desire in waking life, it will permit even such imaginary realization, as fully explained in lesson No. 65, only when thoroughly camouflaged in symbolism.

Yet by tracing the thoughts that are suggested by a dream, it is found possible to uncover the true meaning and thus discover just what repressed emotions caused it. When the repression is once recognized by the dreamer as the cause of his dream, and also as the cause of his illness, or the other trouble he has been experiencing, it is then revealed in its true light. Such recognition relieves the pressure from the repression, and the energy it contains finds some outlet for its expression through thinking about it. To the extent thinking about the desire in the normal way, without the magnification which repression induces, drains it of the repressed energy, it is relieved and the disease cured.

Free Association

—Later investigations revealed that it is also possible to discern the strong repressed desires by having the patient sit listlessly and tell whatever fleeting thoughts come spontaneously into his mind. Those strong desires of the thought groups within the astral body which have found expression in action will have drained, temporarily, their energy. But the powerful desires which have been blocked will have accumulated, under this pressure, sufficient force straining for release, that they deliver a strong impact upon the attention, and thus, as soon as the mind is not deliberately directed to some other subject, they take control of the thoughts.

Thoughts that thus come spontaneously when the attention is relaxed are apt to be those actuated by repressed energies straining for release. Thus by tracing the thoughts which, even though they express the desire in symbolism are nevertheless instigated by it, though more often than not there is no objective recognition of the desire, it becomes possible to discern what desire is chiefly causing the discord. This is called the method of FREE ASSOCIATION.

When repressions are recognized by the patient as having an existence, and are accepted by him as having a meaning in his life; as forces which should find expression; rather than thoughts and impulses which are denied; that they are part of his biological heritage of which he need not be ashamed; that such desires are natural and normal to human beings, although they require directing into proper channels; such thinking about them shows them not to be so painful as was supposed, and not so terrible and serious as had been imagined. And this gives them pleasant Conditioning Energy that works through the process of Conversion to give the whole complex a harmony which it did not have before, in addition to affording some energy release through thinking about the subject of the desires.

The peculiarly discordant compounds, often mapped in a birth-chart by a retrograde planet, Conditioned by the pain of forcing the desires from rising into the consciousness, is replaced by rearranging the thought-elements through pleasant Conditioning energy, by an equally energetic harmonious compound. The new Conditioning Energy which is responsible for the Conversion is furnished by repeatedly viewing the repressed desires as nothing to be ashamed of, but as energies which when given correct expression are quite normal and healthful. If they are of such a nature that their more gross expression is against the interests of the individual or society, they nevertheless should be recognized for just what they are, and then the effort made to sublimate them so that they will find complete and pleasurable expression on a higher level. It is through such processes that diseases are cured by psychoanalysis.

Self Psychoanalysis

—Up to about 1920, this was as far as the most advanced psychoanalyst thought of proceeding. He felt that he could cure the majority of nervous, and some mental, diseases by these methods, and possibly a number of other diseases that were not deep-seated organic troubles; but he saw no particular advantages to the ordinary fairly healthy person in the discoveries of psychoanalysis, astounding though they were.

But about the time mentioned, a number of the most eminent psychologists extended their experiments into the lives of what are considered to be quite normal people. And they attained the most astonishing results. For they found that in every person's life there have been innumerable painful experiences, which have been entirely forgotten by the objective mind, yet which continue to be responsible for much misery, inefficiency and failure. In fact, it was discovered that almost every experience of life, that at the time of its occurrence was accompanied by strong painful emotions, continues to hamper and restrict the individual, and to influence him in a derogatory manner. As a result of this discovery, they came to advocate Self Psychoanalysis by every person.

In the years since then, more and more the process they advocated has justified their faith in it. And because it thus has stood the test of time warrants the quotation of a paragraph showing what was claimed for it then. It is from an article on the subject by William MacHarg and Wilfred Lay, Ph.D., which appeared in the *Cosmopolitan Magazine* for September, 1921.

“Self Psychoanalysis takes, ordinarily, half an hour a day for about four months. You will not, however, have to wait so long before you feel the effect of it. Within a few weeks you will begin to feel an increase in your self-confidence, a drawing together of your mental powers and a satisfaction in your contact with the world. At the end of six weeks you will be amazed at the strengthening of your memory, and the incidents of your early childhood that you can recall. When your self psychoanalysis has been

completed, you will find so many roads to success and happiness open to you that you will be able to choose what sort of life you want to live.”

After thus choosing the sort of life you wish to live, if it be of the type we have been considering, which requires a high physical, mental and spiritual success, in order to live it fully it is probable the character must be still further changed through Conversion and the application of Mental Antidotes; but at least the self psychoanalysis indicated will place your feet firmly on the road leading to such high success.

It will be noticed that special mention is made of childhood memories. Biological changes, as had been demonstrated by laboratory experiments, are very rapid in infancy. At that period one ages greatly in a short space of time; but these changes, and the aging process, progressively slow down with the passing of the years. The biological changes, such as those which exhibit the aging of the individual, may be almost imperceptible during the course of a year in a man of eighty, while during the first year of life they always are vast.

And in a similar way the astral form seems to be more plastic and easily molded by impressions received during the earliest years of life than at subsequent periods. The child seems to feel more intensely, and therefore, through this feeling, to build more powerful desires into his astral form. Furthermore, his lack of experience with the ways of the world permits him often to place an exaggerated importance upon trifles. To the extent he is sensitive, and thus unable to appraise events at their true value, he suffers great mental pain from rather insignificant events. And each time he thus suffers, regardless of the real triviality or magnitude of the suffering's cause, he adds thought-elements to his astral body along with painful Conditioning Energy which causes them to enter into discordant compounds, or if the Conditioning Energy is sufficiently exaggerated, to form a complex.

The fact that, as he grows older, he forgets most of these painful experiences, in no way alters their power to attract him to unfortunate conditions. For just as an organism is repelled by pain, and endeavors to escape from it, so the objective mind also endeavors to escape pain; it being one of the laws of objective consciousness that it ever strives to inhibit the memory of all disagreeable events and emotions.

That is why, looking back upon childhood, we remember it as the time of the Happy Days. This is also the reason that a year after a vacation in the mountains, the wet, the cold, the grinding toil of climbing, the mosquitoes, and the blinding smoke of the camp-fire, are completely forgotten. Only the joyous camaraderie of camp, the wide-spread vistas, the noble trees, the singing waters, and the glorious sunsets, are remembered. The disagreeable part remains, but it is held submerged in the unconscious mind, and only the pleasant experiences commonly are recalled.

But there is this difference between the hardships of a vacation and the hardships of childhood: the former are viewed as incidental accompaniments of an effort resulting in pleasure, as all a part of the day's work and play; while the latter are viewed as serious troubles, as important menaces to life and happiness. It is the mental element,

rather than the physical pain, which because of the intensity of its distress in the disagreeable thoughts and emotions of childhood, then contributes Conditioning Energy which is particularly potent to form virulent complexes.

One who is a failure in life, who continually experiences hard luck, may be amazed to learn that the cause of his failure is the fear inculcated into him as a child by the religious teachings of eternal damnation; that it is caused by the inward frustration arising from constantly hearing the word "Don't!" from his parents; that it is the result of a feeling of inferiority produced by associating with an older brother or sister; or that it is the outcome of the repressed rage felt against members of his own family in childhood. Yet such frequently is the case.

A child is, of necessity, denied so many of its desires, is forced not to do this, and not to do that, and coerced into doing so many things against its inclination, that in the astral body of all ordinary adult human beings there are discordant complexes which have had their origin in the experiences of early life, in addition to thought-cells containing discordant thought compounds. And there may also very well be others originating later in life, which have arisen from circumstances of a far more serious kind.

In the complete reorganization of the character, therefore, to the end of making it highly competent and fortunate, it is well to begin with the Reconditioning of the various discordant complexes and repressions within the astral body that have been built by experiences earlier in the life; so that their energies shall be diverted into expressing through some harmonious and beneficial activity. And to facilitate the Reconditioning of each of these complexes and repressions, it is advantageous to remember the experiences which gave them the Conditioning energy which is thus to be changed.

Most of these experiences when they are remembered, and viewed by the light of later knowledge, which enables them to be arranged according to a broader philosophy, will be seen to have been either quite insignificant, merely as the incidents necessary in life's struggle, or as the avenue through which some important lesson, essential to progress, could be learned. And it has been found in psychoanalytic practice, that whenever a disagreeable experience is thus recalled in memory, and seen to be, after all, a benefit, that the new and pleasurable emotion then imparted to it tends to Recondition the thought-elements within the compound, or the arrangement within the complex, so that it expresses more harmoniously.

When one can honestly laugh at his own past misfortunes, the thought-elements within the astral form derived from them are subjected to the process of Conversion, and are rearranged to form a constructive compound. And in like manner, in recalling the various annoyances of childhood, if they can be seen as mere trifles, the virulent compounds they have formed will be Reconditioned into those which are beneficial, and their repressed energy diverted into useful work. Thus it becomes an advantage, as an early step in attaining Realization, in the fullest sense of the word, to recall in memory all the disagreeable experiences of the past, and to view them either as

events whose importance at the time was ridiculously over estimated, or as a necessary and truly beneficial stepping stone on the pathway to higher things.

It should be understood, however, that any disagreeable event is to be called up in memory only for the transitory purpose of giving it more pleasant Conditioning Energy. For, if recalled in memory to again experience the disagreeable emotions, it will be given new thought-elements along with additional Conditioning Energy of the type which will increase the power of its discord. A painful image held in the mind strengthens the compound which it gave form, and tends to attract other similar painful events. But an experience that was once deemed painful, recalled in memory as an experience from which in reality benefit was derived, tends to rearrange the thought-elements in the compound associated with it.

At the same time, it is always well to associate every such painful picture with a stronger picture in which there is pleasure; to associate the picture from childhood with a later experience in which there were more agreeable happenings. The end sought should be merely to remember the painful incident long enough to reorganize it by giving it a new polarity; and not to dwell on the image of the experience, for that tends to attract other experiences of a like nature. The experience is to be recalled only to view its pleasurable side, and then having Converted it, to let the matter drop. For the rule is, in all visualizing, that the picture of the desired condition should receive the major portion of the energy and attention.

The Record Which Reveals Repressions and Complexes

—To recall the events which were responsible for repressions and complexes which now exist within the astral form, in addition to other methods, Free Association may be used. Under ordinary circumstances the most convenient and effective way of doing this is to set apart a half hour each day. Then, with a notebook and pencil ready at hand, recline in an easy position with the muscles completely relaxed and the mind as much of a blank as possible. Thus, as near to the sleeping state as can be maintained without loss of objective consciousness, permit whatever thoughts may come, to pass freely through the mind. From time to time, arouse sufficiently to make notes of these thoughts and mental pictures; notes that are for no one else to read but yourself. And, as if the psychoanalysis proves successful, before it is finished all the sordid side of the inner nature, the unsublimated primitive desires and impulses, will have contributed their share to the record, these notes should be kept under lock and key.

In addition to what passes through the mind in Free Association, the record also should include an account of all dreams, and all blunders and mistakes made during the day.

For awhile it will be quite enough to keep this record without trying to understand it. But after a week or two some of the notes may be read over in the attempt to discern

just what repressions and complexes and thought compounds they express. From the Free Associations, one thought suggesting another, gradually there will come remembrances of humiliating experiences and of shameful thoughts and desires. When these are remembered, they can be Reconditioned pleasantly through viewing them in proper perspective; as trivial, as experiences necessary and valuable for the fuller understanding of life, or as primitive propensities not yet sublimated, but which when properly diverted furnish energies that can be used for high purposes of construction.

The cause of little forgetfulnesses, the misplacing of this article, the failure to remember that engagement, the tipping over of the water glass, the various other blunders, may be traced, in each instance, to some disagreeable experience or thought with which the matter is in some way mentally associated. And by tracing the line of thought, by the method of Free Association, which spontaneously passes through the mind, with the blunder as a starting point, the disagreeable event which caused the complex, and through it the error, can be located. When once it is located, it can then be viewed in the light of a broad and optimistic philosophy, laughed at perhaps, and thus Converted into a source of energy which will prove beneficent and constructive.

The dreams will be a little more difficult to unravel. Some of them, and possibly some of the scenes viewed while practicing Free Association, may be actual astral conditions. But commonly more of them will symbolize some strong desire that has been repressed. And by taking each factor of the dream and finding just what other thoughts and images naturally follow it in Free Association, it is possible to learn what is symbolized by each.

In this connection it is well to bear in mind that the parts of the dream soonest forgotten are apt to be the most important from the standpoint of psychoanalysis; for the objective consciousness tends to thrust the portion that arises from a disagreeable complex out of the memory. Thus by writing down the dream immediately upon waking, and then writing it down again later in the day, or on the following day, it will be found considerably altered. And the portion changed or omitted, because there is always a tendency to forget that which is most painful, frequently is the part of greatest symbolic value. It is the part which directly symbolizes the discordant complex.

When the meaning of the dream is made plain: that there is such and such a desire within the astral form which, perhaps, the objective mind would not even recognize as a possible desire; a mental acknowledgment that the desire exists, and as explained in detail in lesson No. 60, the sublimation of its energies so that they will find an acceptable and adequate expression of their basic nature, will convert a source of hindrance and discord into constructive energies which can be used to advance the life along the path selected.

For the best results this process of self psychoanalysis should continue over a period of several months. It is the general training that should precede the more specific

application of Conversion and Mental Antidotes to the discordant thought-compounds mapped by discordantly aspected planets in the birth-chart. Before a gymnast is given drastic exercises to make him especially strong and skillful for some particular feat, it is common to give him a period of general training in which the objects are to build up the entire body to a point of vigorous health, and to remedy any little weaknesses here and there that may, if not strengthened, in time cause trouble.

Proceeding along a very similar line toward full Realization, physically, mentally, and spiritually, before attempting the reorganization of the thought-compounds and groups of thought-cells which already had been built into the astral body before the moment of birth, and which are specifically mapped by the birth-chart planets, and before starting on the work of building into the astral body such compounds and dynamic stellar structures as would be mapped by the birth-chart if it could be given the planetary strength and the aspects desired, it seems wise first to prepare for this more arduous work by self psychoanalysis. This will release pernicious repressions and Recondition complexes and compounds of the type that have been acquired since human birth.

Reconditioning the Compounds Mapped by Birth-Chart Constants

—After the Reconditioning of the desires of compounds and complexes which can be reached through the methods of psychoanalysis has been completed, the next step is to bring about the Reconditioning of the thought-compounds and Stellar-cells in the unconscious mind which are mapped by birth-chart Constants which show a predisposition toward specific diseases and difficulties.

As the method of doing this through Conversion and Mental Antidotes has been fully explained in the earlier lessons of this course, it only remains to emphasize that in applying the appropriate kind of thoughts and Conditioning Energy, it is essential to have the precise mental images or thought-train ever ready at hand and easy to use, and that steps be taken to insure that they always are used on the occasions selected for applying them to the discordant thought-compounds. Just a hazy general notion will not do. If a discordant compound is to be Reconditioned into one harmonious, a definite and effective system of applying the proper thoughts to it must be formulated and strictly observed.

Building Into the Character Such Qualities As Might be Mapped By Any Birth-Chart Desired

—So far, we have been chiefly considering altering energies that already have been built into the unconscious mind so that they will express, not as discords and conflicts, but in the most harmonious and effective manner. But when it is

remembered that all that is within the unconscious mind, whether mapped by the birth-chart or acquired since birth, has been added to it through experience, we perceive that merely Reconditioning what already resides within the character is only a portion of the work to be accomplished in gaining complete Realization. It is only repair work, so to speak. And in addition to it, many new parts can be added which will enable the character to function on a level otherwise it could never hope to reach.

Just what these new parts, which are well organized groups of thought-cells added to the astral body through appropriate mental processes, are, which a given individual should acquire for his character, depends upon what he already has, and upon the specific cosmic work he feels he should accomplish. In the limited space here at disposal, it will be possible to indicate only a few of the beneficial character factors, and how they can be built into the unconscious mind, so that they will have all the force of such a dynamic stellar structure as is mapped by a certain planet when it is prominent and harmoniously aspected in the birth-chart. But this will indicate the method used. And it will be understood that qualities, through the use of such methods, can be added to the character, if enough energy can be applied in the process, such as are represented by any selected planetary position and aspect in a chart at birth.

Acquiring Positiveness and Vitality

—Upon the energy and harmony of the Power thought-cells within the astral body depends the vitality and the ability to resist the mental influence of others. Especially people who have the negative planets prominent in their birth-charts need an additional supply of the Power thought-cells to enable them to keep from being swayed from their purpose and to prevent their domination. They represent the specific mental factors most needed by those who are troubled by psychic forces, more about which will be explained in the next lesson. Self-esteem and self-confidence are expressions of these Power urges. Self-esteem is essential to anyone who would gain the esteem of others, and self-confidence is necessary to the efficient performance of any worth-while task.

Self depreciation and lack of pride and firmness all too often are responsible for failure. But to preserve significance it is not necessary to be arrogant nor condescending. Yet it is imperative that one recognize one's own importance and value. And, as a matter of fact, each human is being fitted to occupy a function in life that he can fill better than any other. Each person is really an important cog in the cosmic scheme; and the proper turning of the mill of the gods depends upon each cog in the universal wheel performing its special function. Thus is each of us being shaped and polished to be able to perform his work in the universal scheme of things with ever greater nicety.

Therefore, each day when the aspirant for Realization retires for his half hour or so, let him spend a portion of the time meditating deeply on these facts. Let him withdraw his attention from the cares of the day, and thinking of these matters, learn to Feel his oneness with the whole universe. Let him feel and know that he is a part of the Universal Life, and that he is in harmony with this All Of Life; and being conscious of it, that he is working daily and doing his part to carry out the cosmic program.

He will then feel and Realize that he is working under Divine guidance, and that he has responsibilities to the Master Mind which none but himself can fulfill. And he should permit this Realization of his oneness with all life, and the Realization that he is assisting in the universal work, to fill him with great joy and thanksgiving. Let it inspire him to be conscientious, firm, and self-confident in the performance of life's work, and let it induce in him a great pleasure through the exercise of these qualities. Then let him go forth and manifest these attributes in action. By so doing he will build into himself those thought-cells which give length of life, vitality, and power.

Acquiring Abundance

—These Power thought-cells attract success through their strength and virile energy. They lead to positions of authority, and give the ability to command others. But there is still another group of thought-cells which has a special facility to attract abundance and exceptional good fortune. These are the Religious thought-cells. And the most powerfully harmonious compound that can be formed is one in which the Power thought-elements combine pleasantly with the Religious thought-elements. Therefore, after it becomes possible to Enter The Silence—to turn the thoughts from the external environment to an apprehension of the inner feelings and thoughts—and to realize that you are an eternal spark of Deity, possessing an immortal soul that is working in harmony with all other souls for universal progression; then learn to Feel intensely Devotion, Hope, Cheerfulness, Veneration, Faith and Optimism.

Realizing that you are a part of Deific Life, and working under the direction of the Master Architect it will be easy to bring thoughts of benevolence, hope and faith into association with thoughts of conscientiousness, self-esteem and pride; for you then will inwardly know that one who serves God so faithfully will only reap that which is good. And after the period of Going Into The Silence and feeling this Realization within, then go forth into the world and confirm your Realization by Acts; for when a change has really been made in the astral body, it will manifest in the outward form, and by the act is this inward change then demonstrated.

In this building these new and harmonious compounds into the astral form by the power of thought, the strength of the compound is determined by the volume and intensity of the feeling imparted to it. But the kind of a compound that is organized depends upon the quality of the emotions that accompany its formation.

In the formation of the religious-power-compound, for instance, which I have just explained how to construct, if the thoughts accompanying its formation, during the period of meditation and when carried out by appropriate acts, are persistent and mildly pleasant, a Growth-compound will be formed. If the thoughts are mildly pleasant, but rather intermittent, and interspersed with some slightly discordant feelings, the compound formed will be of the Expansion variety. If, however, the feelings accompanying the thoughts and deeds of a power and religious nature are of the buoyant and joyous quality, the result will be an Opportunity-compound. But if the emotion is more than joyous, being also enthusiastically happy and intensely blissful, then will a Luck-compound be constructed. Such a combination is then called a Power-Religious-Luck-Compound; and no more powerful influence exists on earth for the purpose of attracting Good Fortune.

The same principles hold also for the formation of harmonious mental compounds from the other thought-elements: the intensity of the pleasure accompanying their formation determines whether they will enter into the construction of a Growth, an Expansion, an Opportunity, or a Luck compound.

Acquiring Good Fortune With the Populace and the Opposite Sex

—The next most powerful compound that can be incorporated into the character for the purpose of attaining the highest Realization of success is a harmonious Domestic-Power-Compound, particularly if it is also a Luck-Compound. It is not so potent to bring blind good fortune as a harmonious Religious-Power-Compound; but it gives greater ability, and is even more beneficial to the health. It causes the vital processes and physical functions to cooperate perfectly, endowing the person both with vitality and a strong constitution. It attracts favors from the opposite sex and from people in power, and gives popularity with the general populace. It thus aids in the accumulation of wealth, in gaining favorable publicity and in the rapid advancement of the social and business position.

To build such a compound into the astral body, a justifiable joy should be felt in one's own importance, and a particular pleasure should be felt in using whatever station, income, and advantages that are gained to make the home and family more attractive. Few things build up those mental conditions which lead to general unpopularity so rapidly as does a discordant home life. And few things tend so quickly to attract popularity as does the compounds built into the unconscious mind by a happy home. When such a happy home life can be made to inspire a feeling of importance, dignity, and conscientiousness, so that these feelings can be carried strongly into the business world, we have one of the most potent influences extant, not merely for business success, but for honesty, morality, and integrity of character.

Yet in building such a compound, it is important to remember that it is not the actual events which happen in the home, the people in it, or the beauty of its surroundings,

that tend to form integrative or disintegrative thought-compounds; but the mental attitude toward these things.

Life in a hovel, while surrounded by unsympathetic people, can be made a potent factor in organizing harmonious compounds if one will but search minutely for causes of joy. And, on the other hand, a palace and servants may be made a potent source of discord, if only the disagreeable side of conditions is perceived. It is not the nature of the events which happen that cause the fortunate Conditioning of compounds but the amount of happiness felt due to the event.

Acquiring Affectional Success

—The compounds coming third in the order of their potency for good, are the Social-Compounds. In the astral body of a man, a Domestic-Social-Compound is more fortunate, because women have so much to do with making or marring the life of a man, and this is the most fortunate of all compounds for Realizing affectional success, and for attracting good fortune through women. In the astral body of a woman, the Social Power-Compound is more fortunate; for it insures her happiness where affectional matters are concerned and also gives her great success in all her dealings with men.

For a man deliberately to set about building a Domestic-Social-Compound into his astral form, he should grasp every opportunity to associate an interest in providing for, and looking after, his own family, with taking an active part in promoting social activities. He should take a special interest in going out among people accompanied by his family, or if he has no family of his own, with children or people who are helpless and need care. He should learn greatly to enjoy mixing with people, and the mixing of his family with others in social affairs. The custom of whole families paying visits upon other families is good practice, provided, of course, it can be arranged so that all concerned will have a happy time. The man who loves to entertain in his own home will benefit by it both in popularity and in health.

For a woman to build a Social-Power-Compound into her astral body, she should not confine her interests entirely to domestic duties, but should take a pride in her personal appearance, and in being agreeable company. The cultivation of a feeling of kindness and friendliness toward all persons she meets, will tend to combine the Social and the Power thought-elements properly; and if along with this there also is felt a joy in being rather queenly and dignified, this will tend to the Conditioning of a harmonious Social-Power-Compound. Mirth is as important in this life as is work; and dignity and self-esteem also have their important function.

Acquiring Other Good Fortune

—It will be found quite profitable systematically to build any two families of thought-elements into the astral body as a harmonious compound. But because of their greater importance in human life, the time and energy may be spent more

profitably in adding to the thought-cells, compounds in which one of three families of thought-elements always are present. The most important family that should be harmoniously combined with as many other families as possible, is that of the Power thought-elements. Next in importance to the Power group are the elements belonging to the Domestic thought-element family. And third in importance are the thought-elements of the Intellectual family.

The etheric energies of the body, that is, the nerve currents and their magnetic field, in their positive phase are governed by the releases of desire energies by the Power thought-cells; and the four-dimensional activities of these thought-cells, as mapped by the progressed aspects of the Sun in a birth-chart, are responsible for attracting many of the events of major importance into the life. In their negative phase the nerve currents and their magnetic field are governed by the release of desire energies by the Domestic thought-cells; and the four dimensional activities of these thought-cells, as mapped by the progressed aspects of the Moon in a birth-chart, are responsible for attracting many events into the life of sub-major importance.

The electric currents, generated through the release of desire energies by the Power thought-cells and Domestic thought-cells, in the wave-length of their radiations, are commonly governed by the release of desire energies by the Intellectual thought-cells. These thought-cells powerfully influence the trend of objective thinking, and the thoughts thus gaining objective attention raise or lower the vibratory rates of the energy radiated; and through this control of the comparative shortness of the wavelengths emitted, the individual tunes in on planetary and other broadcasts of a similar frequency. The energy thus tuned in on, radio fashion, through the thoughts and feelings that at the time are before the objective attention, finds its way over the etheric energies of the nervous system, which are ready conductors of astral broadcasts, to the thought-cells in various regions of the astral body. Furthermore, the thoughts and feelings, as this whole course has constantly emphasized, determine what elements are added to the thought-cells and how they are Conditioned to act.

It is to the Intellectual thought-cells that we must look for the ability to keep the thoughts Directed into the specific channels which will provide Mental Antidotes or produce Conversion, and which will add elements to the astral body only in a manner which will prove constructive and assist in attaining Realization. Therefore, no pains and effort should be spared to insure that these Intellectual thought-cells have abundant and harmonious desire energies which with facility can be released

Chapter 7

Serial No. 101
Original Copyright 1937
Elbert Benjamine

Copyright
Church of Light
August 2002

Just How to Give Absent Treatments

Chapter 7

Just How to Give Absent Treatments

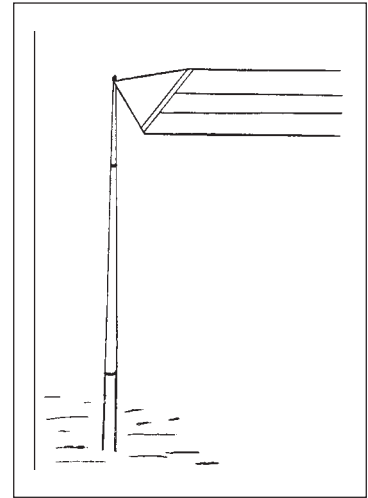

NOW that the principles underlying radio broadcasting and reception are so well understood, it is not so difficult as once it was, to perceive that any thought process which the individual might himself inaugurate, can, with equal force, and effectiveness of change within his astral form be imparted to his astral body by some other person at a distance. Thought-elements of any kind, and Conditioning Energy of any quality, when the tuning-in is adequate, can be conveyed from one individual to another.

Thus in giving absent treatments, because the thoughts used for a specific difficulty are the same in Family and in Conditioning Energy as the individual would use if he had the ability mentally to treat himself, that which specially needs to be understood and used, is the tuning-in process, which when completed commonly is called rapport.

Two objects or two persons are said to be in rapport when their vibrations are synchronous and of similar frequencies; that is, when they both impart to a common medium vibrations that have the same rate of motion in such a manner that the crest of a wave-motion in one corresponds, in point of time, to the crest of a similar wave-motion in the other. In the transmission of thought over short spaces, the common medium may be the ether, but in giving absent treatments at a distance, the medium which carries the energies from the healer to the patient usually is astral substance.

This condition of rapport between people may be only partial, or it may be very complete. When the same tones are sounded on two musical instruments, the rapport between them is very complete. But when an orchestra is playing, the same tones are sounded simultaneously only on some of the various instruments, and other tones that do not have the same frequencies are sounded on different instruments. Therefore, the rapport between instruments is complete only in so far as the tones sounded are the same; and between other instruments and tones the rapport may be partial, or not at all. Thus also, the rapport between the healer and the patient may, be confined to a very limited section of the patients astral body, or it may be so complete that the two personalities, for the time, seem identical.

When two objects are in rapport they may impart energies from one to another, even at a great distance, with facility. The general principle can be demonstrated by striking a tone on a musical instrument in the same room with a piano. The tone will be responded to by a similar tone from the piano, showing that energy has been imparted to it. In radio, the electric frequencies set up in one aerial impart motions to the ether which sets up similar motions in any other terminal which is within the radius of its vibratory waves. But only a receiving set which is in rapport with the sending set, which is tuned to about the same number of kilocycles, can receive the message.

And in a similar way, in order that the person to whom the absent treatment is sent shall intercept it, and through this means have energies applied to the thought-cell structure of his astral body, it is necessary that more or less rapport be established between the healer and the patient. As a rule this rapport is only partial; but the more complete it is, the greater will be the facility for the thoughts sent by the healer to reach and influence the patient.

Inducing the Rapport

—Therefore, in giving absent treatments, the first essential is, in so far as possible, to establish a condition of complete rapport between the healer and the patient. To do this it becomes necessary for the healer to contact the patient astrally, that is, through the medium of astral substance, and then to raise or lower his own vibrations until they vibrate in unison with the patient he is to treat.

To contact the patient, if he has previously seen him, or has his picture, he may visualize him; that is, make a picture of the patient in his imagination. But if he has never seen the patient or his picture, he then should hold some object in his hand that the patient at some time has touched, such as a handkerchief, or a letter he has written. And even more potent as a means of focusing the attention on the patient than his picture or an object he has carried, is his astrological birth-chart; for it is an accurate map, not merely of his physical body, but also of his character, including those very thought-groups which the healer wishes to manipulate in the process of healing.

Looking at the picture of the patient, or his horoscope, or touching some article he has had in his possession, the healer then should relax physically, as much as possible, but at the same time keep his attention alert and keen. His nervous system should be passive, for the time being, to pick up, radio fashion, the vibrations it intercepts coming from the patient; but the brain should retain tension enough to be able to recognize when the rapport has been effected, and also to direct the thoughts afterwards.

In this state of receptivity, the healer should endeavor to FEEL his patient; permitting the article he holds, or the chart or picture, to give him the vibratory rate which he is to tune in on. When he FEELS this vibratory rate, and that he thus has made astral contact with the patient, he then should raise or lower his own vibrations, and adjust

them as completely as possible to the FEEL of his patient, until he senses that there is a complete sympathy with him.

Not everyone is sensitive enough to recognize when they have inwardly made contact with another person, or even when they are in rapport with him. But those in whose birth-charts either Neptune or Pluto is prominent, with practice, can acquire this ability.

Maintaining Control

—When rapport is established, which is felt as an inward identity between the healer and the patient, while maintaining an attitude of sympathy which may be permitted to go so far as to enable the healer to FEEL the discords within the patient, and from them to diagnose the difficulty to be treated, the healer, nevertheless, through alertness of brain, should keep the situation well in hand. He must not permit himself to be swayed by the thoughts and feelings of the patient whom now he has inwardly contacted. Instead, he must have a reserve of power, of the kind especially given by a prominent birth-chart Uranus or Sun, with which he can vitalize the healing thoughts he now should send the patient.

The Etheric Radiations Given by Each of the Three Upper-Octave Planets

—Electrical Potential, or voltage, is something different from the wave length of electromagnetic energies radiated. Some radio stations, for instance, are powerful enough to drown out other broadcasts which are operating on nearly the same kilocycles. Yet for long distance transmission, the high-frequency, short waves commonly are used.

Lesson No. 64 explains in detail how the electrical energies which become nerve currents and are used in objective thinking are generated by the protoplasmic cells of organic life, each of which is a miniature electric battery. And there is explained also how man, through his thoughts and feelings, has the ability to increase or decrease his mental and nervous tension, which means the rapidity with which the nitrogen compounds release radiant energy, and so control the comparative shortness of the wave lengths emitted, and thus tune in on various levels. And that as the etheric energies of the nervous system are ready conductors and transformers of corresponding astral broadcasts, he can tune in not merely on broadcasts through the ether, but on astral broadcasts from the planets and from minds that no longer are of earth.

And in that lesson also is explained that the lately discovered electrical properties of protein, prove that the nervous system is not merely a radio receiving set, but that its phenomena are reversible, so that it can be made, at will, either a receiving or a broadcasting set. During use as a receiving set, if through properly Directed

Thinking, or even through the process of more spontaneous thinking and feeling, the brain-cells are given considerable activity, they generate high electrical charges which reverses the process, and the nervous system then becomes a broadcasting instrument.

Electrical processes are both positive and negative. Laboratory experiments prove that the brain is the most positive region of the body and the liver is the most negative region. But in sleep, as explained in lesson No. 64, the most effective electric batteries of the body, the cells of the gray matter of the brain, become recharged. And even while retaining consciousness they may be permitted to lose so much tension, to so relax, that they no longer generate electrical charges of much potential.

The rapidity with which the protein fraction of the cells of the brain and nervous system release the short wave-lengths which lightning or nitrifying bacteria have stored in their molecules is largely governed by the hormones secreted by the endocrine glands. And those individuals in whose birth-charts the planet Uranus is prominent, probably through its influence upon the parathyroid glands, develop a higher, even though often unstable and not persistent, electrical potential than do any other people. That is, temporarily, at least, they have at their command more electrical power. But while greater in voltage, it seems that the wave-lengths radiated are not so short, nor have they long distance carrying power, of those developed in the brains and nervous systems of people in whose charts either Neptune or Pluto is prominent.

The high nervous tension of those with Uranus prominent in their birth-charts is coincident with the development of electrical charges which radiate, especially through the ether, with great force. Orators and those who sway people through the spoken word or personal influence, to be successful, as ascertained from a statistical study of their charts, must have Uranus prominent in their birth-charts.

Personal magnetism is the etheric radiations of an individual; and nothing gives the compelling force to the personal magnetism that Uranus does. Others, with a lower electrical potential, are unable to resist its power because, after all, we must depend upon electrical currents, or nerve impulses, to control our behavior. At all times there is competition between various nerve currents, which are electrical discharges, for control of the actions; and the one which, at the time, is strongest, that is, has the highest potential, overcomes its rivals, and determines what is done.

The brain is able to exercise such control as it has over the thoughts and actions due to its cells generating higher electrical potentials than those generated by the nerves of the organs, or by stimuli coming in over the nerves from the outside world. Each person has an electromagnetic field of force, or aura, which when it contacts the nerves and brain of another person tends to generate electrical conditions there, through a process of electromagnetic induction, which are in all respects similar.

Thus if at the time there is a marked difference in potential between the two individuals, the nerve currents, and thus the feelings, and for the time being even the thoughts, of the person of lower potential will be established by the person of higher

potential; because in the competition between nerve currents, the currents induced by the electromagnetic, or etheric, radiations of the person of higher potential, have a higher voltage than those generated by the person thus influenced.

Volume of electrical energy generated also has a bearing upon the ability of the individual to control himself and to control others. This volume, and the persistence with which it is generated, determine the vitality and the ability to recuperate from disease; for the vital force of all physical life now has been proved to be electricity generated by the miniature batteries which are the protoplasmic cells.

It is the Sun, operating chiefly through a secretion of the front pituitary gland, whose vibrations rule electricity of the vital sort. To the extent the Sun is prominent in the birth-chart are the Power thought-cells active and such vital energies generated. And these, in turn, give the power to exercise authority over others who, not having the Sun so prominent in their charts of birth, do not generate vital electricity in the same volume. Thus we find in the statistical analysis of the charts of those who occupy positions where they direct the activities of others, that such individuals invariably have the Sun prominent in their charts of birth.

This, however, is a less intense, a far more stable, and a much less erratic, influence than that exercised by Uranus. The Sun type of personal magnetism holds steady to a purpose, and gives a feeling of reliability and solid strength; while the temporarily more powerful magnetic influence of Uranus, with its shorter wave-length radiations, sweeps others off their feet and carries them into actions which, perhaps, they would not dream of doing if not thus influenced by electrical forces of a potential sufficiently high that they can not be resisted.

Electricity, however, is both positive and negative; and the wave-lengths radiated by the nervous systems of those with planet Neptune prominent seem to be shorter and of higher frequency than those ruled by Uranus, but they seem to operate on the negative phase. The Neptune nervous system is far more sensitive than the Uranus nervous system, but the potential generated is much less, and instead of being a positive, controlling force, it is a negative and receptive one.

It is specifically adapted to bringing up into objective consciousness, through the electrical charges generated, whatever is seen, heard, tasted, smelled or felt, by the senses of the astral body, or unconscious mind. That is, the wave-lengths ruled by Neptune, when its influence is strongly imparted to the individual, seem specifically adapted to sensing happenings from the four-dimensional plane. They are of the frequency that most readily permits that which the unconscious mind records to float up, through using them to impart vibrations to the nerves and brain, into objective recognition. And they seem to be of the frequency also which enables the nervous system most readily to get in rapport with things most diverse in their vibratory rates.

Pluto, the other upper-octave planet, operating through the Universal-Welfare thought-cells upon the endocrine glands, generates electrical charges which have a higher potential than those of Neptune, but which are of shorter wave-length and greater carrying power. Apparently they can operate upon either the positive or the

negative phase, but more commonly do so on the negative. They are less potent than those generated by Uranus to influence through the spoken word or personal contact, but are the most potent of all to influence through the method of thought transmission.

Through collecting the birth-charts of those in some manner closely associated with radio, and observing the aspects in the cycle charts when news relating to the radio came prominently before the notice of the public, we have demonstrated that radio is ruled by the planet Pluto. We find also that when people most readily get telepathic messages, and especially when they recognize thoughts sent to influence them, getting the thoughts clearly and becoming aware of the sender, is when there is a progressed aspect to Pluto operative in their charts of birth.

All the evidence points to the conclusion that for establishing rapport between two individuals, whether one has left the physical plane or both are still in physical bodies, and exchanging thoughts, that the wave-lengths generated when Pluto is prominent in the birth-chart are the most effective. Apparently they are not so conducive to tuning in on objects, or to perceiving astral scenes, as are the wave-lengths of Neptune; but as the means by which one intelligence, whether of the three-dimensional plane or the four-dimensional plane, can impress its thoughts upon another at a distance, they rank first. And people with Pluto prominent in their birth-charts are specially adapted to giving or receiving absent treatments.

Psychic Diagnosis

—When the healer is as sensitive as he should be for the highest efficiency in such work, as soon as the rapport is established he begins to feel in his own body the same discords from which the patient suffers. But he must not permit these sensations to become pronounced enough to cause him much discomfort, or to be more than distinctly perceived. This he can prevent by holding a positive and assertive attitude of mind, provided of course, his brain generates electrical charges of sufficient volume and potential to maintain control of his thoughts and feelings. If one has the habit of being negative, or if one is exhausted, the potential that can be developed may be lower than that generated in the nervous system by the astral energies received from the patient, in which case one acquires the aches and pains of the patient, and retains them so long as the rapport lasts. For this reason one should never treat when tired or ill. To treat successfully, and without ill results to oneself, one should be rested and have a surplus of vital, which means electrical, energy on hand.

When he has sufficient electrical potential at his command, he can permit himself to FEEL his patient to the extent desirable, and yet have the ability instantly to reverse the process, and to any extent he desires, and instead of being a receiving set, to broadcast over the rapport thus established, to his patient. This enables him to make a quite complete psychic diagnosis of the patient without difficulty to himself.

If the patient's heart is affected, the healer will feel distress in the region of the heart. If the feet are the region of the trouble, then the healer's feet will cause him

discomfort. And likewise with any other afflicted region of the patient's body. Even when the distress is financial, social, or domestic, the sensitive healer will FEEL the nature of the discord And by noting the thoughts that come into his mind while he is thus in rapport with his patient, he can trace the trouble to its Thought Cause.

When he becomes sensitive enough, by following the thoughts that come into his mind while he is relaxed and in complete rapport with the patient, he can apply the method of FREE ASSOCIATION to determine what repressions and complexes are present in the unconscious mind of the patient, and the nature of the disagreeable experiences in the patient's past which have been responsible for their formation. He will feel these conditions within himself—though he must not, for a moment, let them dominate him—and thus will he recognize the inner cause of the patient's trouble, even though the latter be on the further side of the globe.

Basic Inharmonies Between Healer and Patient

—The astral constitution, that is, the thought-cells and thought structures of the unconscious mind, of some people belong largely to one polarity while that of other people belong largely to the opposite polarity. It is this polarity of the thought-cells which determines whether a person is electric, magnetic, or electromagnetic in temperament. Although these terms more commonly are used to designate the polarity, and thus the type of radiations from, the etheric body, its polarity and thus the temperament, is determined by that of the astral body, to which in this particular it most closely corresponds. And the polarities of people's astral bodies are such as to cause them to radiate astral vibrations that are either wholly positive, commanding and assertive; wholly negative, receptive and yielding; or a combination of the two extremes.

If a healer is electric in temperament, it is easy for him to raise or lower his vibrations the slight degree that becomes necessary to give them the same frequencies, and synchronous with, the vibrations of any other person who likewise is of the electric temperament. But it may be quite impossible for him to change the whole polarity of his vibratory rate to such an extent that he will vibrate at the same rate, and in synchronism with, the vibrations of another person whose temperament is entirely magnetic. As a consequence, he will find it easy to come in rapport with electrical patients and difficult, or at times quite impossible, to come in rapport with magnetic patients. Or if the healer is entirely of the magnetic quality of vibration, he will find it easy to come in rapport with magnetic patients, and difficult, or impossible, to get in rapport with those entirely electric. As a matter of experience, however, only the very extreme types of people are exclusively electric in temperament, or exclusively magnetic. But in most people, one of the two temperaments predominates, and when such is the case they will find it easier to get in rapport with those of the same predominant vibration. Also, there are some very evenly balanced between the two extremes. They are electromagnetic, and thus will find it more difficult to come in rapport with either of the extreme temperaments, and much easier to form the

sympathetic contact with those in whom neither electric nor magnetic qualities are too pronounced.

The relations between birth-charts that show sufficient similarity of vibratory rates to make rapport easy, as well as those which tend to prohibit a satisfactory exchange of energies, are set forth in lesson No. 109, under the heading, PHYSICAL HARMONY. But the healer who has developed any degree of sensitiveness to vibration will need no other index to a person's temperament than his own feelings. Furthermore, some healers, especially those with Neptune prominent in their birth-charts, have the ability to alter their own vibratory rate to a remarkable degree, so that hard and fast rules based on birth-chart positions should not be attempted.

If, however, when the healer attempts to form the rapport between himself and the patient, he feels a Sinking Sensation in his Solar Plexus, or if, when attempting to treat he feels a sickening or faint condition which remains during the treatment, he may know that the proper rapport has not been established. This inward realization that all is not right, and that he is not blending with the patient will, with a little practice, be very easy to distinguish from any feeling caused by the patient's diseased condition. It is a peculiar sensation that arises when the etheric or astral emanations of two people, between whom there is no similarity of vibrations, meet.

Malicious Animal Magnetism

—This peculiar sinking sensation is due to the recoil of the healer's vibrations and thoughts from the astral body of the patient. This is the special Devil which Christian Science has brought to notice, and which it calls Malicious Animal Magnetism. In some cases, to be sure, it is actuated by malicious forethought; for any inimical thought sent against one may be felt as this peculiar sinking sensation, as a peculiar confusing vibration in the head, or as a discomforting vibration of the nerves elsewhere in the body. Commonly, however, the solar plexus is more sensitive than the brain, and thus the condition is more frequently felt in that region. But either a recoil from an unsuccessful treatment, or the presence of an inimical thought may affect the head instead, or even nerves elsewhere in the body; which once experienced is easy again to recognize.

Animal magnetism may be inimical, whether so intended or not. And its elevation to the prominence of a super-power for Evil by the founder of Christian Science was not the outcome of mere speculation, but the result of actual experience. For when two persons come into close contact astrally, as they must do when a treatment is to prove successful, they either form a condition of more or less complete rapport, or else the emanations from one fails to vibrate in synchronism with the vibrations of the other. And as a consequence they form an astral discord. Neither may be evilly inclined, and neither may send malicious thoughts toward the other, but both will feel discord, and both suffer from the contact.

Two musical instruments may both be very perfect, each in its own way; but if they are playing the same piece of music in different keys, or if they have the same key and

are playing different selections of music, there results a terrible turmoil. Thus also, two people may both be very good, each in his own way; but if one is keyed to an electric polarity, and the other is keyed to a magnetic polarity, no matter how much one may endeavor to benefit the other by mental treatment, there will be only adverse results. In fact, to give a successful treatment in such a case the vibratory key of one or the other must be, for the time being, changed so completely that they will vibrate to similar frequencies.

Furthermore, if both are of the same temperament, and one is vibrating at the time entirely to one set of thoughts and the other entirely to another set of thoughts, the result will be unsatisfactory; for they are not in rapport. And whenever this lack of rapport is present, whatever its cause, the healer will feel internally the lack of the conditions which are essential to his success. Whenever he feels this, he should not attempt treatment. And if on repeated trials he gets only such conditions, he should refuse to treat the patient at all, for no good will result. In such cases it is better to turn the patient over to some other healer of as near the opposite polarity to himself as possible. Where he has failed, due to his peculiar temperament, another healer of opposite qualities should have little difficulty in securing a quick cure.

It will now be seen that malicious animal magnetism far more frequently is unintentionally malicious. It is merely the natural discord produced by the meeting vibrations of two persons who are not harmoniously keyed to each other. Thus a healer in attempting to treat a patient visualizes or thinks strongly about him. And because his astral emanations, and the thoughts he sends the patient, recoil upon himself, he is apt to think someone is sending him inimical thoughts.

There is but one way to cure such malicious animal magnetism, and that is mentally and physically to keep away from such persons as temporarily or intentionally are discordant to one's own nature. Yet while malicious animal magnetism is quite as much of a bugbear as witchcraft, also of New England fame, that at one time was considered so serious, and afterwards was thought not even worthy of recognition; in another light it has great significance. For the thoughts and other astral vibrations we contact, through our physical and mental associates, can not but have a powerful influence upon our lives.

Unconsciously, and subtly, those with whom we associate are giving us thought and vibratory treatments, either to produce sickness and sorrow, or to promote health and success. And often there come those into our lives, attracted by the discords within ourselves, who, though good people, nevertheless, due to their temperaments and habits of thought, feed us astral poison. But whenever this is the case, if we will but heed our feelings we will recognize the fact, and we will then no longer associate physically with, or think about, such persons.

Psychic Persecution

—Having mentioned deliberately used malicious animal magnetism, it may be well to relegate this new bugaboo, along with witchcraft, voodooism, black magic, and

sorcery, to the position of insignificance each rightfully should occupy. Not one of these instruments for evil, when recognized for what it truly is, has any power worthy of important consideration in the life of the average normal person. They only have important power over those who fear them, or over those who, either naturally, or through deliberate cultivation, have little power to control their own thoughts and physical forms.

If one systematically cultivates the condition of being negative to unseen influences and intelligences, if one develops irresponsible mediumship, so as to permit any strong thought-force that comes along to control the actions; then there is serious danger from these sources. But if one cultivates the ability at all times to dominate and control his own thoughts and actions, to permit only such thoughts and perceptions as are desired to be held before the consciousness, then there is no danger from any one of these things. In fact, their power chiefly is derived from the circumstance that people give them energy and vitality and force by picturing them in their minds as things to be dreaded.

The Brethren of the Shadow, Voodooism, and Malicious Animal Magnetism, all have a very real existence. So do thugs, robbers, and murderers. And if you go into some low dive where you know criminals of the worst kind abound, and go unarmed and in fear and trembling, the chances are in favor of harm coming to you. But if you stay away from such places, or if you must go there, you go adequately armed for the occasion, then there is little chance of damage.

Therefore, just remember that whenever you think about Inversive Brethern strongly, that astrally you are coming in contact with them. You are entering into mental association with them, just as much so as when you go among wolves on the physical plane you are associating yourself with dangerous animals. And if, when you think of inversive forces, you are negative and weak and have fear, they will attack you just as quickly as will wolves when you run from them and exhibit cowardice. But there is little necessity for coming in contact either with wolves or with unseen intelligences of evil. And should such contact seem advisable, or unavoidable, firearms in the case of wolves, and a calm, confident positive mental attitude in the case of inversive forces, will cause the danger to be insignificant.

And where some person on the physical plane succeeds in using mental power to injure another, whether called by witchcraft, voodooism, *aji*, black magic, or any other name, it is due to the fact that the person influenced, through his ignorance of psychic phenomena, has failed entirely to recognize the source of his trouble; or, recognizing its source, has, through fear and natural negativeness, been specially receptive to it. Those who cultivate the disintegrative forms of mediumship, and those who naturally are negative to everything and everybody, and who have little mental or physical vigor, those who are swayed by every wind that blows; these are subject to injury by magic under any one of its various names.

But any person who has cultivated a reasonable control of his physical body and of his thoughts need not be injured by any form of inimical mental influence. He can

recognize it when it is present by the sinking in the solar plexus, or the peculiar vibrations in his head or other part of his body. And when he recognizes such a condition he should turn his attention resolutely to some active employment of mind and body, keeping a firm, unbending, cold and positive frame of mind, and a serene confidence that he is master of himself and director of his own destiny. To think about and attempt to fight any such inimical force is to give it additional energy. But anyone who can resolutely turn his attention to some active work, and keep his mind positive and interested in the work he is doing, is quite immune from injury from any magical source.

Repelling Psychic Forces

—As already indicated, volume and potential of the electric energy generated have a bearing upon the ability of the individual to control himself and to control others. If an individual develops a lower potential than that which is developed in some section of his nervous system, either through the impact of a thought sent to him, or through the impact of a sensory stimulus, such as hearing a sound, or feeling the jab of a needle; in the competition of electric currents, that developed under the impact, being the stronger, will gain attention from the brain, and if powerful enough also will exercise local control.

Furthermore, when an individual places himself in the mood, or state, to feel, either an external sound, or a thought-wave, he reduces the competition of electric currents, and tunes his nervous system, or some special section of it, to pick up the anticipated vibration. That is, mentally, he reverses the direction of electrical flow, giving predominance to the charges flowing to his brain from the sensory nerves or sympathetic nervous system. If his brain is alert and vigorous, and he retains the ability at any time to take control through generating a still higher electrical potential than those coming in, he is then said to be sensitive. But if his brain is not active enough to generate an electrical potential which enables him to prevent the electrical charges coming to it from registering, he is said to be negative to the external condition. And if this negativeness is sufficient, he loses the power to control his own thoughts and actions.

The organism of man is a bundle of habit systems; and an individual, through practice, can greatly increase either his sensitiveness or his negativeness. And having established the habit of being sensitive or negative in a particular way, it requires but a thought, or slight impact from without, to induce the state again.

It will be seen, however, that if the brain, and sympathetic nervous system and efferent nerves under its influence, develop electrical currents of sufficient volume and potential successfully to compete with those generated by impacts against the afferent nerves and sympathetic nervous system, that the thoughts of the individual then will be the only thoughts or impressions recognized by the brain, and he will retain complete control of his actions. Such is the normal state of affairs, in which most people, because the electric energies moving outward from the brain are more

powerful than those that their nervous systems generate due to the thoughts of others which reach them, are unconscious of thoughts other than their own.

Whether the thought thus reaching him comes from some person on the three-dimensional plane, or from some entity on the four-dimensional plane, the principle is the same: If the individual is broadcasting, that is, if the brain and nerves it can reach, carry a higher potential than that generated in the nerves by the impact of thoughts coming from without, he is unaware of these thoughts. We then say the individual is too positive to perceive such thoughts.

To keep such a positive attitude, not only must the brain be in a somewhat forceful state, in which it is active enough to generate the required electrical potential, but the whole nervous system will be placed under a just perceptible tension, in which there is a slight feeling as of pushing outward of the individual's forces, as if, which he is, he were radiating energy.

But in addition to being able to become positive at will, which is a great asset, both the healer and the person who is troubled with psychic forces, will find it of paramount importance to be able to select some line of thinking and hold it resolutely before the attention. The healer, while in the positive attitude, after establishing rapport with his patient, must be able to think the thoughts he wishes to send his patient, and thus because his potential is higher, convey them to the astral body of the one he treats. And the one troubled with psychic forces, must be able to hold in his consciousness, lines of thought of his own selection, and keep thinking about them with sufficient intensity that the electrical potential thus generated enables him to keep tuned to them, and thus automatically shuts away those generated by the impact of thoughts from without. So long as he generates electrical potentials that are higher, his own thoughts, in the competition between electrical currents, will be the only ones acquiring any influence. And if he is absorbed by his own thoughts, no thought force coming from the outside can even gain recognition.

To keep the thoughts tuned to some dry subject requires the overcoming of various resistances, which consumes electricity rapidly and leads to exhaustion. But if there is some recreation or other interest which easily arouses enthusiasm and pleasure, it will be easy to hold the thoughts to it with a small expenditure of electrical energy. This whole matter of How To Direct The Thoughts is explained in lesson No. 64; so that here it only remains to point out that so long as the thoughts are rather completely occupied with one subject, this tunes the nervous system in on vibratory rates of a similar frequency, and, just as when one dials one station on a radio it cuts off the programs from other stations operating over a quite different frequency, so when one thoroughly tunes in on one train of thoughts, this effectually cuts off the reception of unrelated psychic forces and the thoughts of others, and they then have no influence. Therefore, to be free from any type of psychic persecution merely requires the development of the ability, as explained in lesson No. 64, positively to Direct one's thoughts.

This, it will be seen, is exactly the opposite training from that to become a disintegrative medium; for such a medium cultivates so low a brain potential that not only is he controlled by the electrical currents generated through the impact of the thought-forces of others against his nervous system, but under such training the brain potential becomes temporarily so low that it does not register what is happening upon objective consciousness.

Giving the Absent Treatment

—When the healer feels that the condition of rapport has satisfactorily been established between himself and his patient, he may then, after himself becoming positive while holding to the vibratory rate of his patient, start sending him whatever thoughts he has decided upon as required for a cure. During this time he should visualize the patient in a perfect state of health.

It may be that he will decide what the patient most needs is not Mental Antidotes or Conversion, but the release of some Repression or the diversion of the energy of some Complex. He does not command, or coerce, or force the patient to any action or course of thinking. He merely talks to him in a positive manner, talks to the visualized image of the patient in perfect health, which means talking to him astrally, as if he were physically before him.

He explains to him, perhaps, that the events and conditions which built complexes into the astral body, have been exaggerated as to their importance, and that in reality they are rather insignificant. Or he talks to him about some repression, explaining it to the patient in precisely the same manner he would if he were physically present, telling him exactly through what channel to divert its energy so that it will no longer cause discord but will do some constructive work. The patient may not, and probably will not, be objectively aware of any part of this conversation, yet he will gradually begin consciously, as well as unconsciously, to view his past in a different way, and make the mental adjustments suggested by the healer.

As explained in lesson No. 95, both the physical cells and organs, and the thought-cells and thought structures, have an intelligence of their own. And the healer, in giving an absent treatment, can talk to any of them which are not performing in the best manner, and tell them what they must do. If, for instance, through his diagnosis, he finds the stomach not behaving as it should, while in rapport with his patient he may visualize his stomach, and give it strong suggestion what results are desired from it.

But in thus interfering with the work of any organ, it is better to confine the suggestions given it, which may taken the form of forcefully asking it to do certain things, to the result expected. The heart, or intestines, or spleen, or other organ thus appealed to, knows far more about how to get the asked for result than the healer does; and if the healer tries to give it detail instructions, these are apt to be such that when followed by the organ give results different from those required.

Whatever the patient could do in the way of giving himself mental treatment, had he the skill and energy, can be done by another at a distance, providing the condition of rapport can be established, and the patient is willing thus to receive the treatment.

The healer can use the method of Conversion to alter the manner in which some group of thought-cells perform by taking a keen delight as possible in the appropriate thoughts, while in rapport with the patient, and visualizing the result desired. Or he can use the method of Mental Antidotes, by selecting the appropriate train of thoughts and, while in rapport with the patient, thinking them vividly and harmoniously in association with the department of life to be affected. But in such work he must be conscious not merely of the thoughts and feelings, but also that he is imparting them to a certain region of the patient's astral body.

In such a manner, through changing the thought composition and thought structure of his patient's astral body, the healer can bring about a change also in the habitual thinking of his patient; for the condition of the physical health, the events which come into the life, and the type of thinking, all are expressions of the release of the desire energies of the thought-compounds which he has changed. And it is upon the changed habit of thinking the patient must depend to prevent a recurrence of the old affliction.

Such an absent treatment should last not less than five minutes after the condition of rapport has been attained. Usually twenty minutes will be long enough; and it is seldom advisable to continue the treatment over half an hour; for such work consumes much electric energy. One should never treat after beginning to feel exhausted. At the close of every treatment the mind should be polarized to an attitude of lofty, imperious, positive calm, breaking completely the rapport which during the whole time of treatment has been maintained with the patient. Then the healer, permitting no further thought of his patient, should immediately turn his attention positively to something else.

Book 10-1

Copyright
Church of Light
August 2002

Natal Astrology Delineating the Horoscope

Chapter 1

Serial No. 103
Original Copyright 1922
Elbert Benjamine

Copyright
Church of Light
August 2002

First Eighteen Decanates Analyzed

	♈	♈	♂	Pictured by the constellation TRIANGULUM—A triangle with point upward.
♈	♈	♁	☉	Pictured by the constellation ERIDANUS—A river whose waters confer youth and immortality.
	♈	♁	♄	Pictured by the constellation PERSEUS—A warrior in the cause of right, with wings on his feet, and bearing a sword, helmet and Medusa's head.
	♉	♉	♀	Pictured by the constellation LEPUS—a hare running timidly away.
♉	♉	♋	♁	Pictured by the constellation ORION—A hunter armed with a huge club, fighting with an infuriated bull.
	♉	♊	♄	Pictured by the constellation AURIGA—A charioteer who drives his steeds with one hand and with the other protects a mother goat and her kids.
	♊	♊	♁	Pictured by the constellation URSA MINOR—A small bear which travels backwards, and whose long unbearlike tail touches the pole star.
♊	♊	♋	♀	Pictured by the constellation CANIS MAJOR—A large dog which sits up and watches closely for orders from his master, the hunter.
	♊	♋	♁	Pictured by the constellation URSA MAJOR—A huge bear that travels about the pole, but does not touch the pole star.
	♋	♋	♁	Pictured by the constellation CANIS MINOR—A little yapping, treacherous cur.
♋	♋	♌	♂	Pictured by the constellation HYDRA—A huge water-serpent which extends Its length a third of the way around the celestial sphere, all the way to Scorpio.
	♋	♌	♁	Pictured by the constellation ARGO—A ship that carries its crew across the tempestuous sea to safety.
	♌	♌	☉	Pictured by the constellation CRATER—a fiery furnace inverted so that the lire it contains pours out upon the earth.
♌	♌	♁	♄	Pictured by the constellation CENTAURUS—A creature with the body of a horse and the upper parts of a man, armed with a spear, upon the point of which is impaled a wolf.
	♌	♈	♂	Pictured by the constellation CORVUS—A raven with wings outspread, making a noisy meal from the back of the water-serpent.
	♋	♋	♁	Pictured by the constellation BOOTES—A husbandman, who with upraised sickle chases the Great Bear about the pole, and in his other hand a spear.
♋	♋	♊	♄	Pictured by the constellation HERCULES—A hero who crushes the head of the Dragon under his feet. and with his hand grasps the apples of Hesperides.
	♋	♉	♀	Pictured by the constellation CORONA BOREALIS—A crown of twelve iron spikes, in front of which a serpent threatens to strike.

OUTLINE OF A COMPLETE ASTROLOGICAL READING

1. The person receiving the reading should be told just what the birth-chart represents.
2. He should be told, in connection with each department of life, what will be attracted, and why, if nothing special is done about it.
3. He should be informed as to the best methods to follow to change the destiny of each department of life in the desired direction.
4. He should be told what a progressed aspect represents.
5. He should be told what events each progressed aspect during the period covered may be expected to attract if nothing special is done about it.
6. In connection with each progressed aspect he should be told just what precautionary actions he should take to cause its energies to attract, not what they otherwise would, but what he desires.
7. To show that the basis for such information is at hand he should be given an accurate erected chart for the TIME OF DAY of his birth on the day, month, and year of birth, in the geographical latitude and longitude of his birth.

Chapter 1

First Eighteen Decanates Analyzed

THE Hermetic System of Natal Astrology is different from the systems that today find favor with the vast majority of astrologers only in that it embraces additional features. It departs from prevalent methods seldom, and then only where experience, based on thousands of charts analyzed by The Church of Light Research Department, proves those methods in error. But in addition to the factors commonly employed by the most successful astrologers, it contains others which promote greater precision, and which give the science far greater practical utility.

As lending itself to precision, instead of rules so general in application as to be vague, a definite and specific statement is presented for each position, aspect and relation found in the chart. Natal astrology is not divination; although a wide variety of systems may be devised of using astrology as a divinatory agent, any one of which in the hands of an expert will yield good results. Instead, it is the actual measurement of those thought-elements within a certain person, and a mapping of their relations to each other which express as his character; and the plotting of when these factors of his character will be stimulated into a given activity and will thus tend to attract events of a specific type.

A Person Receiving a Birth-Chart Should Be Told What It Represents

—A birth-chart is an accurate map of those thought components within the astral body which constitute the character with which the individual was born. In its ascent through innumerable lower forms of life, the soul had experiences of various kinds. The awareness and emotions accompanying these experiences built thought-elements into the high-velocity, or stellar, body. Through other experiences these thought-elements became organized as stellar cells, and these in turn into dynamic stellar structures.

The most powerful of these thought-structures in the astral body are mapped by the planets in the birth-chart; and their outstanding relations to other dynamic thought-structures are mapped by the aspects in the birth-chart.

Thoughts, in the sense we here use the term, embrace every form of consciousness and include the sensations felt by even the lowest forms of life. All life-forms react to environment through an awareness which builds mental elements into their finer forms. And a birth-chart is a map of an individual's character, that is, of the thought organizations of his finer body.

These thought-groups and the way they are organized thus indicate the natural aptitudes with which the individual was born, and also, because the thought-cells, or stellar-cells, work from the inner plane to demonstrate the kind of events they desire, the type of events that will come into the life unless some effort is made to change the character, that is, to change the thought-combinations in the finer form.

When the individual receiving a reading understands this, he will no longer consider his birth-chart as an instrument of fatality. Instead, he will perceive that it shows him what changes in his character he must make to improve his destiny; and that his destiny can thus be improved.

In Connection With Each Department of Life Should Be Shown What Will Be Attracted, and Why, if Nothing Special Is Done About It.

—The houses of a birth-chart map the compartments in the astral body which contain the thought-cells and thought-structures relating to each of the 12 departments of life. The planet in a house, or ruling it by sign, maps the most active thought-structures in the astral body which have an influence upon the department of life so designated.

The thought-elements mapped by a planet are of the type indicated by that planet. This determines the type of activity they possess: aggressive, social, domestic, abundance, poverty, etc.

These thought-elements are combined with the thought-elements mapped by other planets to form the stellar-cells of which the astral body is composed. That is, even as all living physical matter is composed of protoplasm, which is a combination of chemical elements, so is the high-velocity astral body composed of psychoplasm formed of thought-elements in various kinds of combinations.

The physical body is built of cells of protoplasm and their secretions, and the astral body, wherein resides the character, is built of thought-cells, or stellar-cells as they also are called. These stellar-cells are not all alike, but are composed of thought-elements of various kinds and in different proportions. They, in turn, enter into the formation of stellar structures, Just as the physical cells are organized into the bony structure, the muscular structure, the nervous structure, etc., of the physical body.

The manner in which the elements have combined to produce thought-cells and stellar structures in the astral body is mapped in the birth-chart by the aspects between the planets which rule the different types of thought-elements.

An aspect, furthermore, indicates that a line has been built across the astral body which has the function of picking up, radio fashion, the vibratory energies radiated by the two planets involved in the aspect. That is, it performs the function of a stellar aerial by which new energy reaches the thought-cells in the astral body and gives them the power to do work from the high-velocity plane where they reside.

The planet in, or otherwise ruling, a house in a birth-chart thus indicates by its nature the kind of thought-elements that are dominant in relation to a certain department of life—such as health, finances, marriage, honor, etc.—and by its aspects to other planets indicates how these thought-elements have combined with other thought-elements, and the amount of harmony or discord they tend to express.

From the volume and type of energy these thought-elements express, together with their harmonious or discordant relations to other departments of life, as indicated by the aspects which map both stellar aerals and the way the thought-elements at either end of the aerial have combined, can be estimated both the natural aptitudes of the individual in reference to the things thus designated, and whether, and to what extent, he will attract fortune or misfortune in reference to this department of life.

Whatever comes to him, of course, is the result of his own character; the aptitudes and normal activities of which are mapped in the birth-chart. Every complete reading of a birth-chart, therefore, should define the aptitudes and indicate what, unless special steps are taken to alter the destiny, may be expected in each of the 12 departments of the individual's life.

It Should Be Shown What Can Be Done About Changing the Destiny of Each Department of Life.

— Of what benefit is it to an individual to understand what a birth-chart is, and what kind of fortune he may expect in each of the 12 departments of life, unless he also knows what can be done to make his destiny more satisfactory?

The value of understanding what a birth-chart is, and what normally may be expected from its positions (thoroughly set forth in this course), is that this also points the way to what can be done, in reference to each department of life, to attract events and conditions more to the liking. That is, if both the abilities and the fortune or misfortune attracted in reference to business, money, marriage, honor, friends, etc., are due to organizations and activities of thought-energies within the astral form, by changing these organizations and activities the abilities and fortune both will be altered.

So far as health is concerned, Course XVI gives the more common birth-chart indications, and also the more common progressed indications, of 160 different diseases, and what should be done to prevent these birth predispositions from developing diseases. In the reference book, *Body Disease and Its Stellar Treatment*¹, the statistical analysis of 700 birth-charts progressed to the time of one of seven common diseases is presented, together with a detailed explanation of the proper precautionary measures. In the reference book, *How to Select a Vocation*¹ there is statistical analysis of 3,000 birth-charts and 30 vocations, which is presented in such a way as completely to cover the subject of astrological vocational selection. And in the reference book, *When and What Events Will Happen*¹, there is the statistical analysis of 2,000 charts progressed to the time of events, and explanation of the precautionary actions that must be taken to make each type of event analyzed more fortunate.

Course IX goes into the details of how to change, in the most beneficial manner, the thought-cell composition, and the desires of the thought-cells, within the astral body. And the present course treats natal astrology very thoroughly from the standpoint of the best thing to be done in relation to each position of the birth-chart and each progressed aspect.

I believe the skill of an astrologer, and his real worth, should be measured by his ability to instruct his client on the best possible method of making those changes in himself and his environment that will enable him, in each of the 12 departments of his life, to have a far better destiny than his birth-chart otherwise indicates; and I believe that such valuable information should form an essential part of every complete birth-chart reading.

The Person Receiving a Reading Should Be Told What a Progressed Aspect Represents.—A progressed aspect may be inevitable in the heavens, like rain or snow, heat or cold, wind or calm; but its effect on the individual is determined by the way he handles it. It means that a temporary stellar aerial is built across his astral body, for the duration of the aspect, which picks up the energies of both planets involved; and picks them up either harmoniously or loaded with static, according to the nature of the aspect.

It is so much additional energy of a given kind, reaching the thought-cells in a certain compartment of the astral body, and causing them to become unusually active. It is the unusual inner-plane activities of these thought-cells which attract into the life at that time the indicated events.

The Person Receiving a Reading Should Be Told What Events Each Progressed Aspect During the Period Covered May Be Expected to Bring If Nothing Special Is Done About It.

— That is, he should, in connection with each progressed aspect, be informed as to what thoughts, impulses and tendencies are stimulated in his unconscious mind, how they are stimulated, and what events may be expected to come into the life from the inner-plane work of these unusually active thought-cells.

The Person Receiving a Reading Should Be Told, In Connection With Each Progressed Aspect During the Period Covered, the Very Best Method of Causing the Energies to Attract, Not What They Otherwise Would, But What He Wants Them to Attract.

—In PREDICTING EVENTS, for instance, is indicated what normally may be expected from a progressed aspect to each planet, what to do under a progressed affliction to each planet, and what to do under a favorable progressed aspect to each planet. And in this section of the course is indicated how Rallying Forces, the Environment, Mental Antidotes, and Conversion, may advantageously be employed. Course IX goes further into the details of properly directing thought-energies to change beneficially the factors mapped in the birth-chart or stimulated by progressed aspects.

The Person Receiving a Reading Should Be Given a Chart Correctly Erected for the Time of Day, as Well as for the Year, Month, Day, and Place of Birth.

—Astrology has become so interwoven in the public mind with fortune-telling that great effort is needed to set people aright concerning the difference. All too often broadside mass readings and psychic readings are called astrological. But a correctly erected birth-chart for the TIME OF DAY of birth, will indicate that the factors for a personal reading have, at least, been calculated. Without the time of day of birth the house positions of the chart cannot be known, and unless the house positions of the chart are known, the compartment of the astral body whose thought-cells receive unusual amounts of energy cannot be determined. It is from the compartments of the astral body receiving energy of a special type and volume that the department of life affected must be ascertained.

It is true that astrology can be used as a divinatory instrument. It is probably the most valuable of all divinatory instruments, and certainly is more widely used as a divinatory instrument than any other. Horary astrology, for instance, is the use of astrology as an instrument of divination; and much of the advice appearing in current astrological literature is based upon the divinatory use of astrology. Nor is there here any intention of disparaging divination by astrology, by the tarot cards, by numbers, or by other well tested methods. A wide variety of systems may be devised, and have been devised, of using astrology as a divinatory agent, any one of which in the hands of an expert will yield good results.

But it cannot be emphasized often enough that Natal Astrology is something quite different in that it maps actual thought-organizations that comprise the character, and plots when these thought-organizations will receive additional energy of a given kind from the planets in such a manner as to cause them to work from their high-velocity plane to attract events of a corresponding nature into the life.

I am here presenting views as to what should be included in every complete reading of a birth-chart, quite well aware that as yet only a small section of public has been educated to an appreciation of either the work involved in such a thorough reading, of its tremendous value to the person possessing such a complete reading. I well realize that the astrologer cannot do the work here outlined for a dollars.

Nor can the professional astrologer afford to give the detailed and constant study to a birth-chart that an individual is warranted in giving to his own. To his own chart any person will be amply repaid to give a great amount of time and attention; for it can be used as a ROAD MAP to guide the course of his life into channels of success he never could reach without its aid. In no other way can an individual gain so much from every department of his life as he can through the intelligent use of such a STELLAR MAP OF BIRTH.

What a Complete Astrological Reading Should Include

—In a matter that, through placing reliance on it, may change the whole course of life and destiny, cheap work, through proving unreliable, may prove terribly expensive. And if it is not of a character that warrants reliance being placed on it, it has no value. It, therefore, is my conviction that natal astrology will never be esteemed as highly as it merits until every complete reading contains these factors:

1. The person receiving the reading should be told just what the birth-chart represents.
2. He should be told, in connection with each department of life what will be attracted, and why, if nothing special is done about it.
3. He should be informed as to the best methods to follow to change the destiny of each department of life in the desired direction.
4. He should be told what a progressed aspect represents.

5. He should be told what events each progressed aspect during the period covered may be expected to attract if nothing special is done about it.
6. In connection with each progressed aspect during the period covered he should be told the very best method of causing the energies then present to attract, not what they otherwise would, but what he desires.
7. To show that the basis for such information is at hand he should be given an accurately erected chart for the TIME OF DAY of birth.

ARIES—1st Decanate. To picture the possibilities of the first decanates of the zodiac the masters of old traced in the sky a starry triangle. This constellation—TRIANGULUM—symbolizes the divine fire that those born under the first decanate of Aries have the capacity to inhale. When living in their highest they are true leaders in thought; for the triangle, ever used as a symbol of flame, is also used as a symbol of mind. And again, by its three sides united into one figure, it represents the union of body, mind, and spirit—thus teaching the importance of co-operation. The pioneer spirit of Aries is expressed in this decanate in all its fiery fullness. Zeal and enthusiasm mark the progress of its children. The Aries-decanate of Aries, sub-ruled by the aggressive lord of war, ever seeks new worlds to conquer. And when the thoughts are permitted to soar untrammelled upward, even as the triangle points to heaven, those born under this influence become the harbingers of better things. But when the lower marital power gains sway they become the avenging agents of death and destruction.

Dr. J. M. Peebles, the great pioneer of spiritualism, had this as his Spiritual polarity, having been born when the Sun was in this decanate. Emperor Paul of Russia had this portion of the zodiac for Mental polarity, the Moon being there when he was born. And Proclus, the great Greek Neoplatonic philosopher, who scaled the height of occult initiation and so impressed his thoughts upon the times in which he lived, was born with the Mars-decanate of Aries Ascending, this being his Physical polarity. It is the decanate of ACTIVITY.

ARIES—2nd Decanate. The second decanate of Aries is pictured in the sky by ERIDANUS—the River of Life—flowing from the never-failing fountain of perpetual youth. Here we find the severity of Mars tempered by the magnanimity of the Sun, which has sub-rulership over this decanate. It is the Leo section of Aries. And as Leo is natural ruler of the house of love, so the water, symbol of the emotions, bespeaks the affectional influence. Only through the affections, only in the sacred precincts of love, does man quaff the coveted elixir that imparts eternal life. So those born under this section of the sky may well seek this most hallowed source of power. They become rulers of men through their inherent power to sway the minds of others. They are born to lead rather than to serve, for this sub-influence of Leo lends a persistent ambition for power. The heart is somewhat joined to the head, and the more this union is cultivated the better; for the greatest lever for attainment obtainable by the natives of this decanate is a noble affection.

Bismarck, who pioneered in statesmanship, had his Individuality in this portion of the zodiac, the Sun being there at his birth. Le Plongeon, who pioneered in archaeology, deciphering Mayan inscriptions and writing a work on Atlantis, had his Mentality here, the Moon being in this decanate at his nativity. And Annie Besant, leader of the Theosophical Society and economic pioneer, had her Personality in this decanate, it being on the Ascendant when she was born. It is the decanate of EXALTATION.

ARIES—3rd Decanate. PERSEUS, with the wings of thought on his feet, the helmet of courage on his head, armed with the sword of righteousness, protected by the shield of beneficence, and holding the blood-dripping head of Medusa in one hand, pictures the third decanate of Aries. The sub-rulership of Jupiter diverts the aggressive energies somewhat into religious and philosophical channels. Consequently, this Sagittarius division of Aries has vast spiritual possibilities when its natives espouse some progressive line of thought, or use their restless never-failing energy in protection of the weak. Perseus gained renown through his daring exploits in relieving oppression. And even as he severed the head of the Gorgon Medusa, which turned to stone all who gazed upon it, so the people of this decanate have the power to destroy the crystallizing influence of licentiousness, and like the David-version of the same tradition, cut off the head of the Goliath of selfish greed. They may become the valiant heroes who wage a successful fight against the sordid conditions that oppress civilized life. In the philosophical field of endeavor they find a useful work in releasing Andromeda, the human soul, which all too often is found chained to the rock of materialism to be devoured by lust and envy.

Of those born with the Sun in this decanate I may mention the pioneer Theosophist, Win. Q. Judge. As expressing the Mentality in this section of the heavens, George Sand, world's greatest authoress, and spiritualizer of common sights, is a fitting example. And Dr. Rajendra Lal, whose antiquarian and research work are known far beyond his native country, India, has his Personality polarized in this decanate, which was on the Ascendant at his birth. It is the decanate of PROPAGANDA.

TAURUS—1st Decanate. The masters of olden times in tracing symbolic pictures in the sky, to convey to later generations their conception of the influence of the various sections of the heavens, sometimes pictured the highest attainment and sometimes pictured the greatest obstacle to progress. In LEPUS—the Hare—they symbolize the thought that timidity is the greatest bar to advancement of those born under the first decanate of Taurus. Being the first decanate of the sign naturally ruling the house of money, there is often a tendency to devote too much energy to the acquisition of wealth. And as this decanate is particularly mediumistic, those born under it easily acquire magical powers. Hence the various traditions regarding it as a place of black

magic. Yet its children become adepts at white magic just as easily if they but overcome the lust for material things. It is only when they are blinded by physical aims that the place of the soul's exaltation becomes an adverse symbol. Those born here have great natural healing power and ability to crystallize conditions to their desires by the power of the imagination to mold astral substance.

Ulysses S. Grant, whose fixity of purpose was his most remarkable trait, was born with his Individuality polarized in this decanate, the Sun being here. G.R.S.Mead, who edited *The Theosophical Review* and did an immense amount of laborious work to enlighten students, had his Mentality in this decanate, being the place of the Moon in his chart. And Jerome Cardan, who became famous as a mathematician and astrologer, had this decanate Rising at his birth. It is the decanate of DETERMINATION.

TAURUS—2nd Decanate. In the second decanate of Taurus the fixity of purpose is given the analytical trend through the sub-influence being that of Virgo. Therefore, some condition in the environment is attacked and made the center upon which the physical and mental forces are focused. The result is a conflict. And this conflict may be to attain fame through literary or artistic production, to attain financial supremacy through business methods, or to rise in the field of science or politics. Thus it brings a combat for supremacy.

This thought is pictured by ORION, the most successful of all hunters, who attacked and slew the mighty bull. The bull represents material pleasures and physical limitations over which it is possible for those born under this decanate to rise supreme. They have at their command an unusual supply of electromagnetism, and can mentally attack with a force as great as the huge club wielded by the mighty arm of Orion. Thus they cause obstacles to crumble.

Thomas H. Huxley, whose work as a scientist was so painstaking and brought him so much opposition, was born with the Sun in this decanate. The Rt. Hon. Joseph Chamberlain, whose political life was spent in the struggle to gain greater freedom for the people, had his Mentality here. And another, who strove with armies, George Washington, founder of the U.S. of America, was born with his Personality in this section of Taurus. It is the decanate of STRUGGLE.

TAURUS—3rd Decanate. The third decanate of Taurus shows the reflective influence of Saturn, its sub-ruler. And even as the key-phrase of Capricorn is "I Use," so those born under this decanate have the ability to use physical means to attain spiritual ends. The decanate is pictured in the sky by AURIGA, the charioteer, who with one hand guides the chariot of his soul and with the other protects and ministers unto the weak and needy. Auriga pictures the one who has triumphed over his environment and physical limitations and attained adeptship. Those born under this decanate have an aptitude for true spiritual attainment. And while the progress usually is not swift; yet, once undertaken, it becomes a sure and steady climb with seldom setbacks. What they receive, however, largely depends upon the use they make of the power they already possess in ministering unto the ills of others.

Elizabeth D. Benjamine, who labored so successfully as a teacher of Brotherhood of Light classes for 23 years, and was one of the three founders of The Church of Light, was born with her Individuality in this decanate. Fred H. Skinner, who labored successfully as a teacher of Brotherhood of Light classes for 21 years, and was one of the three founders of The Church of Light, was born with his Mentality in this section of the heavens. And Immanuel Kant, whose works on transcendental philosophy have not been surpassed, was born with his Personality here. It is the decanate of MASTERSHIP.

GEMINI—1st Decanate. By means of a bear— URSA MINOR—whose restless activity and power suggest that of the mind, the ancients depicted the Mercury-decanate of Gemini. And because the unconscious mind is not so obvious as the objective mind, this bear is small. So too, travels about the sky backward. Thus must one direct his attention contrary to the trend of objective life to hear “the voice of the silence.”

Perhaps unconsciously, yet none the less effectively, those born in the Gemini third of Gemini tend to rely upon intuition. Their natural field of endeavor is the mental plane. They see, not merely the details of a problem, but view it completely, perceiving the proper relation of each part to the whole. And if they are not carried away by the restless desire to undertake too many things, they may become intellectual giants. For they assimilate all they contact and their deductions rise spontaneously from the soul.

Alighieri Dante, who intuitively grasped so many cosmic truths and portrayed them in his “Inferno,” was born when the Sun passed through this decanate. George Bernard Shaw, who comprehends in their entirety so many of the present-day world problems and presents them in his lucid literary style, was born when the Moon was here. And Richard Wagner, the composer, who saw and felt the great truths of nature and expressed them so adequately in music, was born when this decanate was on the Ascendant. It is the decanate of INTUITION.

GEMINI—2nd Decanate. The second decanate of Gemini is pictured in the sky by a large dog— CANIS MAJOR. This noble looking beast is the emblem of faithfulness, and through its adoration for its master also represents the worshiping and serving of Deity—for to the dog his master is God. Therefore, we find those born under the second decanate of Gemini often possess a singular and admirable faithfulness, either to their human companions or to some high ideal. They have much veneration and seek to obey the voice of their conscience implicitly.

This Venus decanate also relates to twin-souls. So there is greater likelihood of those born here finding a congenial mate than is the case with most. And to make the best of life they must espouse some principle or progressive cause, and work to get it generally acknowledged and accepted.

Robert Schumann, the musical critic and composer, who was so faithful to his ideal of musical interpretation, was born with his Individuality polarized in this decanate. Miss Florence Cook, whose faithfulness to the cause of spiritualism led her to become the medium through whom “Katie King” manifested to Sir. Win. Crookes, had her Mentality pictured by this section of the sky. And Win. Jennings Bryan, whose faithfulness to his political and religious convictions is the best known feature of his career, was born with his Personality in this part of Gemini. It is the decanate of FIDELITY.

GEMINI—3rd Decanate. A huge bear—URSA MAJOR—traveling about the pole-star in a forward direction depicts among the constellations the Aquarius-decanate of Gemini. The bear, whose restless activity and omnivorous nature is typical of mentality, in this case moves as does the objective mind, in the direction of events. And it is huge in size to indicate the immense power that may be exercised by thought. This is the scientific decanate of the sign of thought. Those born under it are capable of accomplishing great things through the exercise of their minds. They tend chiefly to rely upon reason, therefore, should not only train their minds, which is readily accomplished, but should also cultivate idealism and religion. Otherwise their efforts crystallize and become self-centered.

Nero, the Roman Emperor, who had wonderful talent, but could burn Rome for his own amusement so self-centered had he become, had the Sun in this section of the heavens at his birth. On the other hand, as indicating the better qualities of this decanate, Nicholas Culpepper, author of the “Herbal” and by his friends said to be the best physician that ever lived, had his Moon here. And Jay Gould, whose manipulation of railroad securities wrecked so many others and made for himself such a huge fortune, had his Personality located in this last decanate of Gemini. It is the decanate of REASON.

CANCER—1st Decanate. The first decanate of Cancer is depicted in the sky by a little yapping cur—CANIS MINOR—a mongrel without courage or loyalty. By it the ancient masters sought to convey the thought that those born under this section of the sky are particularly susceptible to domestic intrigue. They have strong emotions and may easily be carried away by them. Consequently, they should put forth a persistent effort to cultivate the qualities of faithfulness and poise.

Through the activity of the emotional nature, and their sensitiveness to all that affects life, they are often capable of remarkable poetic and dramatic expression. Unknown to themselves they are the mediums through which entities on the inner planes manifest. And because they are such perfect mediums they sometimes betray the trust placed in them, for they tend to yield to the temporarily strongest influence. They should learn to be positive and firm.

Louis XII of France, who divorced his virtuous and ill-favored queen, Joan, to marry Anne of Brittany, by whom he was dominated, was born with the Sun in this decanate. Nell Gwyn, actress and favorite of Charles II, had her Moon in this place. And Lord Byron, the poet, whose love affairs were none too conventional, was born with this decanate on the Ascendant. It is the decanate of MOODS.

CANCER—2nd Decanate. HYDRA—the water-serpent—commences as the middle decan of Cancer and extends through the sky all the distance from this home constellation to Scorpio, the constellation of death. Representing the Scorpio, or sex, decanate of the domestic sign, those born under it possess much resource and energy, as well as being strongly emotional. The serpent is the symbol of creative energy and the water in which it dwells is the symbol of the strong emotions displayed by these people. So the traditional struggle of Hercules with this monster is not without significance, for it represents the struggle with sensual desires, as well as a struggle to overcome the limitations imposed by death.

Thus we find that those born here have a natural aptitude for communion with those who have passed to the spirit side of life. And if they do not fall into the destructive forms of mediumship, but instead retain at all times full control of their bodies and minds, they are led, impressed, and guided from the spirit side of life in all their worthy undertakings.

W. T. Stead, who established the bureau for spirit communication and did so much for the spread of spiritualism, was born with his Individuality here. Dr. Luke D. Broughton, author of the well-known “Elements of Astrology,” had his Mentality in this decanate. And Sarah M. Grimke, the fine seeress, and author of “Esoteric Lessons,” who contributed valuable work in behalf of spiritual enlightenment, had her Personality in this section of the sky. It is the decanate of REVELATION.

CANCER—3rd Decanate. ARGO, the constellated ship that gave foundation for the story both of Noah’s Ark and that of the adventurous Argonautic expedition, pictures the third decanate of Cancer. There will be stormy seas in the lives of those born here, but a tranquil mind will prove an adequate bark to carry them to the shores of safety. They are restless and somewhat discontented. While loving domestic life, yet they are also eager to learn what is just below the horizon. Their curiosity, however, becomes an asset and leads them into fields that are all too little known. They are great lovers of Mother Nature, take keen delight in spying out her secrets, and in this kind of work find their greatest natural aptitude.

The celebrated Finnish painter, Albert Edelfelt, had the Sun in this decanate at his birth. Lorenzo Niles Fowler, whose investigations in another department of Nature’s laboratory, that of phrenology, has made him noted, had his Moon here at birth. And Bulwer Lytton, who delved deeply into the occult— for among his many novels we find two depicting respectively the lives of a white and a black magician, “Zanoni” and “A Strange Story”—was born with his Ascendant in this part of the heavens. It is the decanate of RESEARCH.

LEO—1st Decanate. The first decanate of Leo is pictured among the constellations by CRATER—a furnace, or cup of fire. In this manner did the ancient masters of stary lore portray the fiery love nature of those born under this section of the sky.

Their most notable trait is the desire and ability to rule others. And unless this tendency is restrained there is an inclination to dominate. Yet always there is a powerful love nature. And as love is at the foundation of all achievement, if this love energy can be directed into proper channels, it leads on to success. But due to its strength there is danger of turning to one extreme or the other—either permitting pleasure to dominate the life, or in rebellion at the tendency toward excess to become the avowed ascetic. As neither extreme permits of proper expression of the fine qualities of this decanate the watchword should be moderation.

Hiram Butler, author of “Solar Biology,” who founded and ruled a colony of esoteric students whose efforts largely revolve around sex-repression, was born with the Sun here. Anna B. Kingsford, who wrote “The Perfect Way,” “Clothed with the Sun,” and other works of an occult character, and whose relationship with a prominent organization was severed because of her own dominant views and teachings, was born with the Moon in this decanate. And Adelina Patti, the prima donna, who dominated the multitude through the beauty and power of her voice, was born with this part of Leo as her Ascendant. It is the decanate of RULERSHIP.

LEO—2nd Decanate. In the second, or Jupiter, decanate of Leo the inherent quality of dominant control characteristic of Leo is modified by the subinfluence of the sign of the higher mind, Sagittarius. The philosophical and religious elements are more in evidence, and those born here readily recognize the prevalent weaknesses both in current politics and in current religion. And what is more important, they have the courage of their convictions and the power to gain followers for their own progressive ideas.

To picture the ruthless onslaughts with which these people attack both persons and policies that seek to ravage society, CENTAURUS, a being having the lower parts of a horse and the upper parts of a man, is represented among the constellations as impaling on the end of his spear the wolf that pictures the last decanate of Libra. This wolf symbolizes those who use the brilliancy of their intellects to suppress truth and to foist ignorance and superstition upon society that they may profit by its exploitation. As those born in this middle decanate of Leo have the power to convince and lead others, it behooves them to put forth every effort to gain the truth, and to take great care that they do not disseminate erroneous notions.

iVladam H. P. Blavatsky, founder of the Theosophical Society, was born with her Individuality here. Mr. J. Malcolm Mitchel, secretary of the Men’s League for Women’s Suffrage, had his Moon in this decanate. And Martin Luther, founder of the Protestant Religion, was born with his Personality polarized to this section of the sky. It is the decanate of REFORMATION.

LEO—3rd Decanate. CORVUS, the Raven, is the constellation picturing the tendencies of people born under the third decanate of Leo. This raven is pictured with wings outspread as if in readiness to fly aloft, but with its feet firmly gripping the back of Hydra, the water-serpent. This symbolizes the emotions that are associated with creative energy, for the raven appears to be making a meal from the flesh of the serpent.

In this last portion of Leo we have the love of power and rulership combined with the quality of leadership bestowed by Aries. As a consequence those born under this section of the sky are determined to rise in life regardless of obstacles. And when this tendency is carried to extremes they will sacrifice their associates, their family, and even integrity itself, in order to increase their power. But when their ideals are thoroughly for the welfare of humanity rather than for mere personal aggrandizement, they become of immense service to society through their natural gift of being able to handle others and use them to advantage.

Napoleon I, who attempted to conquer the world by arms, was born with the Sun in this decanate. Dr. Zamenhof, who invented a language, Esperanto, which was to supersede all other languages in the world, had his Moon in this section of the heavens. And Alan Leo, who attempted to give to astrology a world-wide recognition and power, was born with his Ascendant here. It is the decanate of AMBITION.

VIRGO—1st Decanate. In the Mercury-decanate of Virgo we find the assimilative quality exercised to the most pronounced degree. The mind of those born here are usually restless and active, a tendency pictured among the constellations by BOOTES—the Bear Driver—who follows the Great Bear, symbol of the objective mind, about the heavens with an upraised sickle, urging him on. And to convey the idea that man's thoughts, when carefully tended, yield a most precious fruitage, Bootes is traditionally associated with the vine of the grape; for he is also a husbandman.

So those who are native of this section of the zodiac press, with great dexterity, the wine from all life's varied experiences. It then becomes a coveted elixir which stimulates them to still greater accomplishment. This is the harvest decanate, and these people readily sift the grain from the chaff, and use it practically for sustenance.

Maurice Maeterlinck, so successful in literature, was born with his Individuality in this decanate. Alexander the Great, whose military achievements have been unsurpassed, was born with the Moon in this part of the heavens. And Henry Cornelius Agrippa, who attained success and renown in the practice of ceremonial magic, was born with his Ascendant here. It is the decanate of ACHIEVEMENT.

VIRGO—2nd Decanate. The Saturn-decanate of Virgo is pictured among the constellations by Hercules—the Hero—who, among other things, performed twelve superhuman labors. One foot crushes the head of the Cyclic Dragon, while his outstretched hand grasps the apples of Hesperides. This depicts the tendency of those born under this section of the sky to undertake and accomplish, by unremitting toil, the performance of gigantic tasks. They also have an exceptional variety of experiences, both with the so-called good and the so-called evil. Thus are their lives filled with events.

Here we find the assimilative powers of the mind, conferred by Virgo, to be given a diplomatic trend, and often there is a great desire for worldly fame and honor. The temptations that come to these people are great. But if they guard against the allurements of the flesh that sooner or later come into their lives, they can rise to great heights through their unusual powers of discernment and comparison.

Mabel Collins, who wrote “Light on the Path” and other occult works, and whose life has been varied in experience, was born with the Sun in this decanate. Camille Flammarion, the great French astronomer, who likewise is an authority on Psychic Research and a wide variety of other matters, had the Moon here at birth. And Chopin, the great composer, whose affair of the heart ended so disastrously, had this part of the heavens on the Ascendant at his birth. It is the decanate of EXPERIENCE.

VIRGO—3rd Decanate. The last decanate of the northern signs is pictured by a crown of twelve iron spikes. This Venus-decanate of the mental sign Virgo is the point from which the Sun passes into the winter section of the zodiac. And so the serpent, picturing the first decanate of Libra is represented with his fangs just before CORONA BOREALIS—the Northern Crown—as if to strike.

Virgo, as a whole, corresponds to the house of work. So this last decanate seems particularly given to working in behalf of others. People born here find their greatest possibilities in the realm of service. When they can lose sight of the reward, and labor enthusiastically for some noble cause, they live to their utmost. Even though the laborer is worthy of his hire, yet those born under this influence are often called upon to give up the things they would prefer to do for the sake of duty. Though the material reward is a crown of thorns, yet the gain in character and soul-power always more than repays for all sacrifice.

Henrich Daath, who labored so steadfastly in the cause of modern astrology, was born with his Individuality here. Leo Tolstoy, who though born of nobility, lived so simply and made so many sacrifices in the cause of peace and purity, had his Mentality in this decanate. And Swami Triganitetti, the Vedanist teacher who was blown to pieces in his temple in San Francisco by a fanatic, while he was faithfully serving his religion, had his Personality polarized in this place. It is the decanate of RENUNCIATION.

Note—With a few exceptions, so that the student may have easy access to the charts cited and thus study the other factors contributing to character and accomplishment, I have used as examples persons whose charts may be found in “1001 Notable Nativities.”

¹See Astrology—30 Years Research.

Chapter 2

Serial No. 104
Original Copyright 1923
Elbert Benjamine

Copyright
Church of Light
August 2002

Last Eighteen Decanates
Analyzed

			♀	Pictured by the constellation SERPENS—A serpent about to strike.
			♁	Pictured by the constellation DRACO—A dragon coiling its length about the pole-star.
			♀	Pictured by the constellation LUPUS—A wolf pierced and dying on the spear of Centaurus.
			♂	Pictured by the constellation OPHIUCHUS—A man who wrestles with Serpens, the serpent.
			♁	Pictured by the constellation ARA—An altar from which arises the smoke of burnt sacrifices.
			♃	Pictured by the constellation CORONA AUSTRALIS—A laurel crown of triumph.
			♃	Pictured by the constellation LYRA—A harp of seven strings.
			♂	Pictured by the constellation AQUILA—An eagle bearing aloft in its talons a young man.
			♃	Pictured by the constellation SAGGITA—An arrow in full flight.
			♁	Pictured by the constellation CYGNUS—A swan flying swiftly southward.
			♀	Pictured by the constellation DELPHINUS—A dolphin that has come to the surface to breathe.
			♀	Pictured by the constellation PISCES AUSTRALIS—A fish drinking the water that flows from the urn of Aquarius.
			♁	Pictured by the constellation EQUULEUS—The head of a horse with flowing mane.
			♀	Pictured by the constellation PEGASUS—A winged horse that soars upward.
			♀	Pictured by the constellation CETUS—A gigantic whale-like monster.
			♁	Pictured by the constellation CEPHEUS—A king with upraised scepter and whose crown is surmounted by seven globes.
			♃	Pictured by the constellation ANDROMEDA—A princess chained to a rock by the sea.
			♂	Pictured by the constellation CASSIOPEIA—A queen sitting on a throne clasping in one hand a braid of her hair.

The Spiritual Texts of Astrology

In addition to its significance where natural aptitudes and the trend of material fortune are concerned, each constellation portrays a spiritual message which is of special significance to those having its corresponding sign or (charts of birth, or temporarily outstanding due to a powerful progressed aspect being formed involving a planet in the sign or decanate.

Astrology makes known to man the Will of God. And the text which expresses the spiritual significance of a given sign or decanate reveals God's **RELIGIOUS INSTRUCTIONS** to the individual who has the sign or decanate unusually prominent.

The Spiritual Text which derives from each of the 12 signs and each of the 36 decanates is set forth in Course 7 after the picture and story describing it.

KEYWORDS OF THE 36 DECANATES

	ARIES	TAURUS	GEMINI
1st	Activity	Determination	Intuition
2nd	Exaltation	Struggle	Fidelity
3rd	Propaganda	Mastership	Reason
	CANCER	LEO	VIRGO
1st	Moods	Rulership	Achievement
2nd	Revelation	Reformation	Experience
3rd	Research	Ambition	Renunciation
	LIBRA	SCORPIO	SAGITTARIUS
1st	Policy	Resourcefulness	Devotion
2nd	Independence	Responsibility	Exploration
3rd	Expiation	Attainment	Illumination
	CAPRICORN	AQUARIUS	PISCES
1st	Organization	Originality	Verity
2nd	Martyrdom	Inspiration	Self-sacrifice
3rd	Idealism	Repression	Vicissitudes

Chapter 2

Last Eighteen Decanates Analyzed

IN so far as positive influences are concern, scientific astrology need consider only these four: 1. The 12 signs and their decanate subdivisions. 2. The 10 planets. 3. The 12 houses. 4. The 10 aspects.

Each sign, each house, and each planet, however, rules several different things; so that while positive science points to alternative things within well-defined limits, there are commonly several such alternatives to choose from within the boundary of the limits defined by scientific astrology.

The conditioning of the individual and the environment within which he functions, as well as each progressed aspect which at the time is adding energy to his thought-cells, and such effort, if any, which he makes based on knowledge of astrology to control events and conditions, all have an influence in determining which of the alternate things is 'the most probable one.

Physical data of precision and scope often are not at hand to make a correct appraisal of the specific condition or event indicated; and if such details are correctly to be given extra-sensory perception must be employed.

The unconscious mind of every individual, because of the properties of the inner-plane on which it constantly functions, is able to perceive things—even things in the future as ESP experiments in our universities now prove—that are quite undiscernible to everyday consciousness. The difficulty in utilizing information thus gained is not so much that the unconscious mind is unable to arrive at correct conclusions from such inner-plane observations, as that more frequently it is unable to mobilize the electromagnetic energy to impart its correct conclusions to everyday consciousness.

To impart them to ordinary consciousness the LAW OF ASSOCIATION must be brought into play, connecting images already in everyday consciousness with those discerned by the unconscious mind, or soul. And the most effective of all images thus to form the necessary link between the two phases of consciousness are universal symbols.

Aware of this principle, which only recently has become recognized by modern psychologists, the ancient Wise Men, to whom we are indebted for so much of our astrological knowledge, devised universal symbols which would operate through the LAW OF ASSOCIATION to give extra-sensory perception the best possible images with which to work in connection with each sign and decanate of the zodiac. These images, or symbolical pictographs, became the constellations.

Present-day maps show many more than 48 constellations because with the study of modern astronomy kings and notables desired something placed in the heavens to remember them by. But the old Greek celestial sphere, obtained by them from Chaldea, shows only 48 constellations, one picturing each of the 12 signs and each of the 36 decanates of the zodiac.

The origin of these constellations is set forth in considerable detail in lesson No. 71. The constellations picturing the signs were placed in the sky in a sequence of longitude that would reveal to which sign each is related. That is, while the constellation Cancer only occupies about 15 degrees, and the constellation Virgo occupies about 50 degrees, there should be no mistake that the Crab pictured the sign Cancer, because it was the fourth zodiacal constellation and Cancer was the fourth sign; nor that the Virgin pictured the sign Virgo, because it was the sixth zodiacal constellation, and Virgo, was the sixth sign.

These signs were subdivided, both by ancients and moderns, into 10 degree divisions called DECANATES. There are three decanates, or 10 degree sections, to each sign, each presided over by its own planet, each exerting its own particular influence, and each pictured as to its attributes by one of the 36 ultra-zodiacal constellations. And in determining the relation between the 10-degree sections of the zodiac and the constellations picturing their significance the ancient Masters followed the same general system they had employed with the zodiacal constellations.

That is, commencing with the first of Aries both among the decanates and the constellations, they placed the first of the outline of the constellation so it would have the same sequence in longitude that the decanate it pictured had. Following this plan, the seventh constellation in longitude, either north or south of the zodiac, pictured the seventh zodiacal decanate, the eighteenth constellation in longitude, either north or south of the zodiac, pictured the eighteenth zodiacal decanate, etc.

About the 48 constellations (a full-page picture of each is given with its sign and decanate rulership in Course VII), each picturing one of the zodiacal signs or one of the zodiacal decanates, the ancients wove allegorical stories which imparted a spiritual teaching. The whole of these teachings, and the 48 texts derived from them, are embraced in spiritual astrology.

Spiritual astrology explains in the language of symbolical pictograph that the universe is an organic whole permeated with the consciousness of God, and is not, as the materialists would have us believe, just an aimless collection of material particles obeying blind physical laws. It explains that this organic whole, in response to the mental design of God, is marching endlessly toward greater perfection. And it further explains that the soul of man, both on earth and in the hereafter, is not just a robot, but is called upon to employ initiative, and intelligently to assist in carrying forward the work necessary to the realization of God's Great Plan.

The nature of this Great Evolutionary Plan is clearly revealed by a study of God's Word which in the language of symbolical pictograph has been traced among the stars as the constellations. And this Great Evolutionary plan thus revealed calls for each individual to develop and use the natural aptitudes which are shown by his planetary chart of birth. The natural aptitudes which are strongest are those which directed into proper channels will enable the individual to be of greatest use to society.

To give the individual guidance in his effort to cooperate in God's Great Evolutionary Plan, the allegorical stories (set forth in Course 7) woven about each of the constellations were not confined to revealing a spiritual teaching applicable to mankind as a whole. They were designed also for the purpose of conveying special information relative to each sign or decanate pictured whenever it was an outstanding influence in the birth chart. This special information relates both to the material and the spiritual endeavors.

Therefore, to those astrologers who desire to give richer detail and finer precision to their work than can be had by positive science alone (although each decanate, as set forth in this and the preceding lesson and revealed by its Key-Word does have a positive significance also), the constellation picturing the decanate in which the planetary influence needing interpretation is found in the birth chart, and the allegorical stories concerning it handed down from antiquity, afford the best possible means of aiding the extra-sensory perception to give details otherwise unobtainable.

The constellations picturing the signs occupied by the Sun, Moon, Ascendant and Mercury are quite significant in this respect. And in the analysis of what may be expected from each of the 12 departments of life in connection with the aspects received by the Asc., M.C. and 10 planets, the constellation picturing the decanate occupied by each of these will yield a wealth of detail that gives finish and precision to astrological work.

The pictures used to portray the significance of the decanates were derived in the same manner as those used to picture the signs. That is, to picture the tendencies and possibilities of the sign Aries the Masters of Old selected a Ram to be placed among the stars; and to picture the tendencies and possibilities of the sign Taurus, they found in the Bull the qualities they sought.

In this and the preceding lesson, while the constellation picturing each decanate is indicated, no attempt is made to appeal to extra-sensory perception. The approach here is that of cold and positive science based on ample research. And that the outstanding attribute of each decanate may be the more readily remembered, it is expressed as a single Key-Word.

The Four Outstanding Decanates of Every Birth Chart

Next to locating the Dominant Planet, the most important single factor to be considered in determining the individual's natural bias is the decanate in which the Sun is found at birth. It is so important because it maps the section of the astral body where those most deep-seated of all experiences, those relating to the desire for significance, called the Power Urges, are organized into a dynamic stellar structure. Analytical psychology proves that these Power Urges, which included the mental factors that go to make up a person's pride, firmness, approbateness and self-esteem, are the most strongly fortified and persistent of all the energies within the soul.

The qualities mapped by the Sun in the birth chart being the most persistent and deep-seated, we are quite justified in saying that it represents the INDIVIDUALITY. And as the decanate occupied by the Sun is the region of contact between the ego and the soul it is quite correct to say that the Individuality is polarized in a certain decanate.

But there are other, and less deep-seated mental factors within the astral body of man, that have been organized by the experiences of the soul since the commencement of its cyclic journey, that give him the capacity to grasp information of a certain order more readily than that of another. These fluctuating factors that indicate the type of experience most easily received and assimilated by the unconscious mind, and that thus determine the general quality of the mental processes, are shown in the birth chart by the decanate occupied by the Moon. Therefore, while every planet and aspect in the chart represents definite mental factors and relations, we are correct in saying that the MENTALITY is polarized in the decanate occupied by the Moon.

And whatever lies inherent in the Individuality, or is grasped by the Mentality, if it is to be externalized, must be transmitted into action through the physical body. This also has its trend, or polarity. It is given by the decanate upon the Ascendant. So we are justified in saying that the PERSONALITY is polarized, or represented, by the Ascendant decanate.

Furthermore, the method by which the thoughts most readily are expressed has considerable significance. This is not the same thing as mentality. It is mapped in the birth chart by the planet Mercury. We are justified, therefore, in saying that the EXPRESSION is polarized in the decanate occupied by Mercury.

The sign and decanate occupied by any planet, either in the birth chart or by progression, will afford valuable indications to the alert astrologer; but most important is the Individuality, shown by the Sun-decanate in the birth chart. Next is the Mentality, shown by the Moon-decanate in the birth chart. Following this comes the Personality, as indicated by the Ascendant-decanate; and then the Expression, as indicated by the Mercury-decanate. These four should always receive attention.

But in applying these it should never be forgotten that while in some instances the constellation pictures the condition that bars the way, and in others pictures the thing to be obtained, that inherently no one decanate is more fortunate, more noble, nor more powerful, than any other decanate. The picture forms a guide to endeavor, such as is most needed, but those under each have an equal opportunity to scale either material or spiritual heights.

In reference to this matter of alleged good and bad signs and decanates, I wish I might impress it indelibly upon the mind of every inexperienced astrological student that every degree and decanate in the zodiac offers equal opportunity for nobility and greatness. The greatness that more easily may be attained by a person born in one decanate, however, is not the kind of greatness that may be grasped readily by one born in another.

That is as it should be, for the world, like the universe, is a very complex organism. And to be complete, society must have statesmen, poets, artists, musicians, writers, engineers, architects, healers, naturalists, astronomers, mathematicians, leaders, and a variety of other persons each skilled along certain lines. Therefore, the successful man, both from the standpoint of the individual and that of society, is one who performs some needed work exceptionally well; and if he performs it better than other men he may become famous.

The greatest author the world has ever produced, William Shakespeare, made a poor family man, and was a failure as a provider. The greatest musician of all time, Beethoven, was quite helpless through his ignorance when brought face to face with worldly matters. And the greatest mathematician ever known, Isaac Newton, who discovered a yard-stick with which to measure the universe, in other matters had the mind of an innocent child. Had any one of these men, each the greatest in his own line, been forced continuously into other lines of effort, the world would have profited nothing by his genius.

Furthermore, every person is fitted by natural tendency to be educated to fill some useful and needed place in the social scheme. And it is one of the important functions of astrology to point out the particular line of effort, and the special kind of training, that will make each person more useful to himself and to society. When he finds and fills his proper function in the universal plan he has then also found his greatest happiness.

LIBRA — 1st Decanate. The first decanate of Libra is pictured among the constellations by SERPENS—the Serpent. This is the snake that sacred tradition asserts tempted Eve to her downfall. The serpent has been used from ancient times, however, not only as a symbol of creative energy, but also of cunning. In worldly matters those native to this decanate have no need of the admonition to be “wise as serpents,” for they have the innate ability to handle people and situations.

It will be remembered that the Biblical serpent told Eve that if she would eat of the apple she would become wise—and that subsequent events verified the prophecy.

And those born under this decanate well uphold all the serpent traditions of wisdom and subtlety, and besides possess the creative energy to pioneer in the realms of human association. Such people should never seek seclusion to be at their best, but should mix in the world’s affairs and come in contact continuously with their fellow-men. In this field they can wield an enormous power for good through their ability to influence the thoughts and actions of others. But they should take pains not to become too engrossed in purely material aims.

Georges Clemenceau, the “Tiger” prime minister of France, was born with the Sun in this part of the sky. Wm. Ewart Gladstone, the great statesman, had the Moon in this place at his birth. And Emperor Franz Joseph of Austria, who triumphed over so many difficult situations, was born with his Ascendant here. It is the decanate of POLICY.

LIBRA — 2nd Decanate. The Aquarius decanate of Libra differs somewhat from the other decanates of this sign in the strong tendency to express individuality. Being under the sub-influence of Uranus, it partakes of the Uranian quality of originality and sometimes even eccentricity. It is pictured among the constellations by DRACO — the Dragon — which winds its length in sinuous coils about the heavenly pole.

And even as this is the dragon of worldliness that St. George was called upon to conquer, so, very frequently, those born under this decanate find in the world some opposition to their views which they feel it incumbent upon themselves to slay. They are natural exponents of liberty in thought and action, and rebel against restrictions. They find the best opportunity to express themselves as enthusiastic members or leaders of progressive movements. And in fighting the tendency toward crystallized conservatism, they reach their highest level.

S.J. Paul Kruger, Boer President, who struggled valiantly for the liberty of his people had his Individuality in this decanate. Magi Zariel, largely responsible for founding the National Astrological Society, and for 25 years editor of its official organ, “Prophecy,” was born with his Mentality polarized in this place. And W. H. Chaney, author of “Primer of Astrology,” who fought energetically in defense of astro-science, was born with this part of the heavens on the Ascendant. It is the decanate of INDEPENDENCE.

LIBRA — 3rd Decanate. The last decanate of Libra is not less given to contact with people than the other two. Neither is the mind less keen. In fact, it is often superior, especially where literature and art are concerned. But as it is the decanate in the sign of partnership and open enemies next to the sign of death, Scorpio, there is sometimes a peculiar fatality associated with it.

This fact is pictured in the sky by the constellation LUPUS—the Wolf. This original of the wolf in sheep's clothing is represented as impaled on the spear of Centaurus. And as designed it indicates the almost certain fate of those born under this portion of the sky who transgress either the laws of man or those of God. Due to the brilliancy of their minds they sometimes use their talents to ensnare their fellowman and keep him in ignorance and poverty that they may profit thereby. But when they live straightforward moral lives and do not fall into corruption, they rise to positions of power and usefulness, and no tragedy overtakes them.

Samuel Taylor Coleridge, the poet, who became a victim of opiates, was born with his Sun here. Marie Antoinette, who was accused of extravagance and profligancy, and so was beheaded, was born when the Moon was in this section of the sky. And Henry IV., king of France, who led a stormy life and was finally assassinated, had this decanate on his Ascendant. It is the decanate of EXPIATION.

SCORPIO—1st Decanate. OPHIUCHUS—the man who wrestles with a serpent—is the constellation, picturing in the sky the sex-decanate of the sex-sign, Scorpio. He typifies the struggle of man with his animal desires. And even as in the Biblical story of Jacob wrestling with the angel—which is but one version of this starry struggle—he who is victorious is always greatly blessed.

So we find people born under this decanate with the strongest sex impulses. There is an excess of creative energy which goads them to desire and action. They thus have an abundant vital magnetism, which they impart to others, giving a natural ability to heal. It also stimulates the mind to creative imagination. Therefore, when they turn from sensualism and direct their forces to constructive work they have a wonderful fertility of ideas, and are capable of leading the strenuous life at its maximum. Not through suppression can they overcome the serpent, but through the guidance of the surplus energy into proper channels.

The Sun was in this portion of the zodiac at the birth of the versatile and resourceful Theodore Roosevelt, who became president of the United States. Henry Steel Olcott, president-founder of the Theosophical Society, and a man of refined creative genius, was born with his Mentality here. And the most resourceful and prolific inventor of all times, Thos. A. Edison, was born with this part of the heavens on his Ascendant. It is the decanate of RESOURCEFULNESS.

SCORPIO—2nd Decanate. ARA—the Altar—rising from which is seen the smoke of burnt offerings, pictures in the heavens the Pisces-decanate of Scorpio. Here we find the self-centeredness and aggression of Mars, the ruler of Scorpio, somewhat modified by the restrictions of Pisces. All the desire for expression is present, but usually there comes a time in the life when mere personal gratification must be sacrificed on the altar of devotion to the sense of duty.

Those born here are usually strong characters, either in good or in evil. They have vivid passions and abundant animal force. Then comes the time when they are called upon—even as were Cain and Abel—to sacrifice the animal part of themselves. Some, like Cain, refuse to do this and endeavor to buy favor from the Law with the fruits of the earth. But others, rising to the occasion, attain to truly spiritual heights. Those born here find themselves called upon to fill positions of importance, if they do not shirk. And the successful completion of one duty ever leads on to advancement. But the animal needs to be guarded well.

King Edward VII., who dutifully carried the weight of Great Britain's rulership, was born with his Individuality in this decanate. John Heydon who wrote the "Temple of Wisdom", and felt it his duty to promote the cause of astrology, was born with his Mentality here. And Wm. Howard Taft, the man whose duty led him to the highest office in both the executive and judiciary branches of the U.S. Government, was born with his Personality polarized to this section of the sky. It is the decanate of RESPONSIBILITY.

SCORPIO—3rd Decanate. Unlike the crown of spikes that pictures the last of Virgo, CORONA AUSTRALIS—the Southern Crown—is the laurel crown of victory. Picturing among the constellations the Cancer-decanate of Scorpio, it reveals the potency of sex when sublimated to carry the soul to the loftiest summit of physical and mental achievement.

Adjacent to the religious sign Sagittarius, and under the sub-influences of the sign of domestic life, Cancer, those born here have intense emotions and vivid ideas. When the spirit of chivalry is developed and they sense their value to country and home they are capable of lofty effort. But for the greatest success it seems essential that they have some person of the opposite sex to stimulate their ambitions and ideals, and for whom they strive to make a success of life. Social life, therefore, is always, an important factor contributing to or detracting from their usefulness to society.

Franz Hartman, who wrote "Life of Paracelsus," "Magic White and Black," and achieved other success along occult lines, was born with the Sun in this decanate. Thomas Moore, whose social grace and patriotism were second only to his achievements as a poet, had his Mentality here. And the chivalrous Benjamin Disraeli, who became Prime Minister of England, was born with this part of the zodiac on his Ascendant. It is the decanate of ATTAINMENT.

SAGITTARIUS—1st Decanate. The Harp of Seven Strings—LYRA—such a harp as David played upon to soothe the spirit of King Saul, pictures the Jupiter-decanate of Sagittarius. The constellated instrument portrays the soul which places itself “In Tune with the Infinite,” and becomes responsive to the thoughts radiated by the Cosmic Mind.

Those born under this influence, when true to themselves, are the most religious of all and are capable of attaining Cosmic Consciousness. But their religion need not be tinctured with orthodoxy, and is often most expressed through their kinship with Nature and their love and sympathy for all living creatures. They live at their best, and accomplish most, when they constantly feel the abiding presence of the Cosmic Intelligence and place implicit trust in Its guidance. They then feel impressed to fill a definite mission, and if they follow the dictates of the “Inner Voice” they seldom err in judgment. But either in matters of spiritual progress or in mere worldly affairs, they must rely upon their own judgment, for when they take the advice of others they most signally fail.

William Blake, poet and painter, author of “Books of Prophecy” and designer of illustrations to “The Book of Job,” was born with his Individuality here. Dr. Alfred Russel Wallace, whose research led him independently to the theory of evolution so ably expounded by Darwin, and who was famous as a naturalist, and who embraced the cause of spiritualism in spite of the ridicule of his contemporary scientists, was born with his Mentality in this decanate. And Abraham Lincoln, man of destiny, deeply religious and the instrument through whom human slavery was abolished in America, was born with his Personality under this section of the sky. It is the decanate of DEVOTION.

SAGITTARIUS—2nd Decanate. The Eagle— AQUILA—symbol of transmuted sex, and the power of the higher mind to make lofty flights through the rare atmosphere of the spiritual world, pictures among the constellations the Aries-decanate of Sagittarius.

The migratory instincts of Sagittarius are given a trend toward pioneering. Consequently, we find people born here to be unusually successful in searching out new fields of endeavor, physical, mental, and spiritual. They are usually restless. Their minds are constantly alert for new facts. And in order that they shall not become discontented it is very essential that they have at all times some definite work to accomplish, and that this work is of a nature to be well worth their best efforts. Confinement and restrictions are most depressing to these people, and if forced to be idle or to follow some uncongenial occupation they become rebellious and hypercritical. They require some task of importance to call out their wonderful executive ability.

Alfred de Musset, whose searching mind grasped the merits of both the classic and the romantic schools and welded them into a system of his own, becoming famous as a poet, playwright, and novelist, was born when the Sun was here. Alice Le Plongeon, author, and co-worker with her husband in his explorations among the ruins of Yucatan, was born with her Mentality under this decanate. And Dr. Sven Hedin, the great geographical explorer, had this section of the zodiac on his Ascendant. It is the decanate of EXPLORATION.

SAGITTARIUS—3rd Decanate. The third decanate of Sagittarius, the Leo-decanate, is pictured among the constellations by SAGITTA—the Arrow. This is the arrow that Mithra shot against a rock and a stream of water immediately gushed forth. It symbolized the soul piercing the illusions of matter and through this comprehension of the meaning of incarnate existence being able to quench its thirst at the fountain of Divine Consciousness.

Those born under this decanate may either tread the path of pleasure, or climb the royal road to spiritual supremacy. Being the kingly section of the sign of the higher mind, when the sporting proclivities relating to the fifth sign's influence are transmuted, they have not only the ability to perceive things in their proper relation, but also to synthesize their observations and impart this knowledge to others. They, therefore, reach their greatest usefulness as teachers and leaders of philosophical and religious thought. And when faithful to their ideals and persistent in adhering to their own conceptions they reach the highest states of consciousness possible to embodied man.

C. C. Zain—pen name of Elbert Benjamine—author of all 210 Brotherhood of Light lessons, author of over a thousand magazine articles on astrology or occultism, and one of the three founders of the Church of Light, was born when the Sun was here. Krishnamurti, head of the Order of the Star in the East, who refused to pose as an avatar, and author of “At the Feet of the Master,” was born when the Moon was in this section of the sky. And Maria M. Benjamine, whose wifely sympathy and constant assistance contributed markedly to all the later work of C. C. Zain, and who worked vigorously and unselfishly to disseminate The Religion of the Stars, was born with this division of Sagittarius on the Ascendant. It is the decanate of ILLUMINATION.

CAPRICORN—1st Decanate. CYGNUS—the Swan—speckless white, which with outspread pinions wings its way from the frozen north toward the sunny southern skies, pictures among the constellations the first decanate of Capricorn. It symbolizes the first news of a new order of things, a retreat from the crystallizing influence of materialism, and the harbinger of the approaching warmth of a spiritual spring.

So we find those born under this influence, when living at their best, to be forerunners of better conditions. They, better than any others, realize the value of system and organization to effect any worthwhile changes. And in business or in politics, both of which are spheres of activity to which they naturally gravitate, their greatest asset is in conciliating different factions and inducing them to join in some large merger which will operate more economically and efficiently than could any one faction alone. These people shoulder responsibility readily and become the managers in the world. To live at their highest they must be permitted to find expression for their talent of co-ordination.

Woodrow Wilson, one-time president of the U.S., whose greatest effort was made toward effecting a “League of Nations,” was born with his Individuality here. Bessie Leo, owner of “Modern Astrology” and publisher of many books on astrology, was born with her Mentality in this decanate. And Cicero, the great orator and statesman, had this section of the zodiac rising at his birth. It is the decanate of ORGANIZATION.

CAPRICORN—2nd Decanate. DELPHINUS—the Dolphin—pictures among the constellations the second decanate of Capricorn. This is the Taurus-decanate of Saturn’s sign, the strong emotional element conferred by the sub-influence of the Moon’s exaltation being indicated by the water in which the mammal lives.

While the Sun passes through this decanate we have Epiphany, and also the common civil year begins, bringing a new dispensation. And about the dolphin that represents this section of the zodiac there are many traditions implying it to be a Savior of Men. So we find that those born here possess extraordinary ability to make the most of whatever environment they find themselves in, even as the dolphin has adapted itself to the water. They utilize every condition to their purpose, and while encountering many setbacks they have the persistence to again come to the surface and “carry on.” They are indefatigable workers, and when they set their minds upon some worthy aim they scale the heights to success. And if they get a higher than material viewpoint they are capable of great self-sacrifice in the interest of universal progression.

Sir Isaac Newton, the greatest mathematician the world has so far produced, who discovered a yardstick with which to measure the universe, and had the courage to announce his convictions, was born when the Sun was here. Savonarola, who was burnt at the stake rather than forsake his religious convictions, was born when the Moon was in this part of the sky. And Swami Vivekananda, who sacrificed his life in first bringing to America and establishing the Vedanta religion was born when this section of the zodiac was on the Ascendant. It is the decanate of MARTYRDOM.

CAPRICORN—3rd Decanate. The Southern Fish—PISCES AUSTRALIS—is the constellation picturing the Mercury-decanate of Capricorn. It is shown as eagerly drinking the water that flows from the urn of Aquarius. This symbolizes the conception that through the cultivation of the higher emotions it is possible to communicate volitionally with those who have passed to the spirit side of life. Also, that those on earth are, to an undreamed-of extent, the recipients of love and wisdom poured down upon them by those who are of earth no more.

People born under this decanate have natural ability to grasp the ideal and express it in concrete form. Their power of imagination is marked, and is united to the faculty of intensive labor. They can follow clerical lines, but to develop their highest talents they should be permitted to develop and execute plans of their own. They readily contact the interior planes and draw valuable information from that source, even when unconscious of the origin of their ideas.

Joan of Arc, who under spirit guidance led France to victory, was born when the Sun was in this decanate. George Eliot, who attained fame through the ideals expressed in her novels, was born with her Mentality here. And Michelangelo, the greatest sculptor and artist of all time, was born with this portion of the zodiac on the Ascendant. It is the decanate of IDEALISM.

AQUARIUS—1st Decanate. A horse, which is an animal used to carry a person to a desired locality, has been used from ancient times as a symbol of mind. And to picture the Uranus-decanate of Aquarius the ancients placed the head of a horse—EQUULEUS—among the constellations.

Those born under this section of the sky tend to follow their own ideas. They are keenly interested in education and are exceptional in the fullness of their knowledge of human nature. In fact, aside from their inventive ability their greatest asset in life is in knowing how to handle men. And it is a great mistake for them to live apart from close contact with numerous of their fellow humans. The tendencies are decidedly progressive, alert for the new and unique. Consequently, their true mission in life is in imparting their enthusiasm for advanced methods and ideas to others.

Samuel Gompers, leader of the American Federation of Labor, was born with his Individuality here. James Coates, mesmerist and author of books on character-reading, was born when the Moon was in this decanate. And W. B. Yeats, poet, was born with his Personality polarized to this portion of the zodiac. It is the decanate of ORIGINALITY.

AQUARIUS—2nd Decanate. The Flying Horse—PEGASUS—pictures among the constellations the Mercury-decanate of Aquarius. The wings pictured upon the symbol of mind indicate the ability to leave the material body and travel in the super-physical world in the astral form. This may take place volitionally, or quite unconsciously so far as the objective mind is concerned, during sleep. And those who can bring through into the objective state the information so contacted have a never-ending supply of interesting material that they often are able to present in a fascinating manner.

People under this decanate possess naturally the ability to gain information from invisible sources. Consequently, they have unlimited resourcefulness in imaginative creation. And they are able to present their conceptions in a most dramatic manner. So, by all means, they should follow some occupation where the mind has power to exert itself. And when not inclined to literature they should read much and learn to express their thoughts in conversation. They convey their ideas to others in a most convincing manner, and through this faculty lies their greatest good, both to themselves and to humanity.

Charles Dickens, the famous novelist, was born with his Individuality here. H. Rider Haggard, another famous novelist, had his Moon in this decanate. And Robert Louis Stevenson, still another wonderful writer of romance, had this section of the zodiac on the Ascendant at his birth. It is the decanate of INSPIRATION.

AQUARIUS—3rd Decanate. The Libra-decanate of Aquarius is pictured by CETUS, which mythology informs us is the largest constellation in the sky. This Whale was the monster that devoured the innocent youths of the country as a punishment for the haughty pride of their queen.

In this manner is symbolized the tendency of those born under this influence to enter into matrimony from other motives than those of pure love; or, from some material motive renouncing love altogether, to be consumed by its energy inversely directed.

These people reach their greatest efficiency and attainment only in harmonious association with a kindred soul of opposite sex. When they deny true love, or make it subservient to material ambitions they are in great danger. But when they follow the dictates of the heart and realize companionship in the higher sense they become efficient workers for human betterment. A solitary life is not beneficial to these people. They should mix with others and take a keen interest in helping to make the world a better place in which to live. This is the work for which they are fitted.

C. W. Leadbeater, the Theosophical writer, was born when the Sun was in this decanate. John Cooper, who did a work of great value toward human enlightenment in translating the “Primum Mobile” of Placidus was born with the Moon here. And Havelock Ellis, author of “Sexual Inversion” and other works dealing with sex, was born with this part of the zodiac on the Ascendant. It is the decanate of REPRESSION.

PISCES—1st Decanate. The Neptune-decanate of Pisces is pictured among the constellations by CEPHEUS—the King—whose foot rests upon the immovable Pole Star. He holds aloft a scepter cut from the Tree of Life, and his crown is surmounted by seven globes representing the seven planets and the septenary law in nature.

People born under this section of the sky are naturally interested in understanding Nature, particularly in its psychic and spiritual aspects. They are mystics, to the manor born, and seek truth not so much through the methods of exact science and reason as through the exercise of their psychic faculties. They readily become seers, and have a natural aptitude for grasping the esoteric interpretation of all phenomena. This ability to recognize the truth through the “inner response” becomes of value in the world of affairs in connection with secret-service work of all kinds. They are detectives of the highest order, whether their talents be directed to social conditions, or to the wider mysteries of universal relations.

Ramkrishna, the famous Yogi, whose influence over the Vedanta Philosophy was so great and beneficial, was born when the Sun was here. Dr. Richard Hodgson, whose physical researches led him to investigate the phenomena connected with H. P. Blavatsky, was born when the Moon was in this decanate. And Wm. Lilly, best of the older authorities on horary astrology, had this portion of the zodiac on the Ascendant at his birth. It is the decanate of VERITY.

PISCES—2nd Decanate. The second decanate of Pisces is pictured among the constellations by ANDROMEDA—the Princess chained to the rock for the sea-monster to devour. It symbolizes the earthbound condition of the human soul that passes to the spirit side of life obsessed with the desire for material reincarnation. It also represents those noblest of all mankind who suffer persecution and imprisonment that the rest of humanity may prosper.

The lives of persons born under this section of the sky are usually filled with restrictions and limitations. Often these conditions are assumed voluntarily as the price enacted by the world for the sake of assisting in its progress. When living at their best they are readily impressed by those on the spirit side of life, and are often chosen to carry out some important mission on earth. They grasp more readily than others the true meaning of universal brotherhood, and they get the most out of life through alleviating the physical and mental suffering of their fellow-man.

Nicholas Copernicus, who was largely responsible for the adoption of the present system of astronomy, and suffered for his apparent heresy, was born with the Sun here. Charubel, author of “Degrees of the Zodiac Symbolized,” a seer and worker in behalf of the esoteric wisdom, had his Mentality in this decanate. And T. H. Burgoyne, author of “Light of Egypt,” and adept in the highest sense of the word, who suffered persecution for his views, was born with this part of the zodiac on the Ascendant. It is the decanate of SELF-SACRIFICE.

PISCES—3rd Decanate. The last decanate of Pisces is pictured among the constellations by CASSIOPEIA—the Queen on her throne. It is the sex-decanate of the sign of imprisonment, and mythology attributes the imprisonment of her daughter to the pride of this queen in her beauty. However, in another story she is the queen who furnished her children with the Ram that bore the golden fleece and carried them to heaven.

Therefore, we find those born under this influence to have eventful lives, and to be capable of entering upon and succeeding in a wide variety of careers. It is the last section of the zodiac, and they seem often to recapitulate in their lives the events and conditions we expect from many other decanates. They are unusually adaptable, are likable people, and require excitement and change. They reach their highest value in psychical research, and in adopting and advocating such a life as will prepare man for existence after the change called death.

Sir Richard Burton, the famous traveler, who was so expert at disguise and as a linguist that he passed as a native in many lands, was born when the Sun was here. Evelyn Nesbit Thaw, actress over whom her husband shot Stanford White, and whose life has been filled with drama and pathos was born with her Mentality in this decanate. And Empress Frederick of Germany, mother of Kaiser Wilhelm of world-war notoriety, was born with this section of the zodiac on the Ascendant. It is the decanate of VICISSITUDES.

Note—With a few exceptions, so that the students may have easy access to the charts cited and thus study the other factors contributing to character and accomplishment, I have used as examples persons whose charts may be found in “The Book of Notable Nativities.”

Chapter 3

Serial No. 105
Original Copyright 1934
Elbert Benjamine

Copyright
Church of Light
August 2002

Stature, Temperament, Disposition and Mental Ability

Chapter 3

Stature, Temperament, Disposition and Mental Ability

Because, when the cart gets in front of the horse instead of in its proper position wrong conclusions inevitably follow, right here is the place to point out the real relation between character and the birth chart and to indicate that the assumption, so often expressed, that two people with practically identical birth charts must be identical in form, in the details of their character, and in the experiences of their lives, is incorrect.

Quite a number of dog fanciers, of late years, have been using astrology in their efforts to breed, and to pick from various litters, pups which would win prizes in the shows. Others have experimented with considerable success in selecting colts to be trained into race horses. And yet more extensive mention might be cited in this domain of animal husbandry, were such required, in which the birth charts of various kinds of creatures have been recorded and the subsequent experiences of their lives compared with these birth charts.

The unanimous conclusion of those who have thus experimented with non-human birth charts is that, due allowance being made for plane of expression, similar positions in a birth chart give similar qualities and experiences.

Dogs often are born in the same town and at the same instant that a child is born. Yet no one would be so foolish as to expect such dogs to exhibit human intelligence or to have human experiences. Yet a dog, as has been noted in kennel magazines, with the planetary positions and aspects in its birth chart which, if it were human would lead it to honor and public acclaim, is one to be counted on to take prizes in the show and get its portrait in the papers.

A Bushman, either of the Australian or the African bush, might have, and some probably do have, birth charts to all intents and purposes the same as those of our aldermen and utility magnates. Yet it is not to be expected that these Bushmen will run street railways or be given tips on the market by those who do. They will merely occupy positions of importance in the environment where they function which in some measure parallel those of their Caucasian birth chart types.

Practical experience with birth charts, even of those who have had a similar environment, is convincing that it is much easier to determine the type of ability possessed by an individual than it is to determine how far he will go in the development and expression of the qualities thus so clearly indicated.

And, unless we get the cart before the horse, it is easy to see why this should be so; as the zodiacal signs and planets can merely map the inner relations which express as character, but have no power to indicate the plane or level occupied. Bring any astrologer the birth chart of a dog, a horse, a Bushman or a cockroach, and ask him to delineate it.

From the chart alone he will be unable to determine what species of creature it represents; unable to specify the evolutionary level. It is only when he is informed of this that he can give a delineation of the qualities and the probable events of the life.

This rule may be relied upon; that the creature is not born until the positions of the signs and planets in their relations one to another rather closely map the relation of the important factors within its astral body. These factors, however, express on an infinite variety of evolutionary levels.

To be still more specific, the finer body of any creature, man included, is composed of astral substance organized by its experiences into thought-elements. These thought-elements, or urges as they are called, in turn combine to form psychoplasm, even as chemical elements combine to produce protoplasm. The physical body is composed of protoplasm and its secretions; the astral body is composed of psycho-plasm.

As protoplasm is organized into the physical cells of the physical body, so psychoplasm is organized by the experiences of the individual into the stellar cells which compose the astral body. Furthermore, physical cells are brought into cooperation as the bony structure, the nervous structure and the muscular structure of the physical body, and stellar cells enter into colonial life within the astral form as its various stellar structures.

These stellar cells and stellar structures of which the astral body is composed at the time of birth into human form have all been organized and built by the experiences of the soul in forms still lower than the human. The soul attracts to itself progressively those forms which afford it the experiences it needs to develop the qualities for which it was called into differentiated existence. It has a definite mission to perform in the cosmic scheme, which these qualifications fit it for, and which it can accomplish better than any other. Its evolutionary progress from one form to another, each form giving new experiences which are retained in its astral body, is to enable it to develop the ability to do this work.

The positions of the planets at the time of its birth into human form, therefore, do not determine either its character or the experiences it will have. They merely map the relation of the various factors within the astral body. They map those well organized groups of stellar cells which have unusual energy, and which therefore are called dynamic stellar structures. It is the thought-organization, the organization of experiences preceding human birth, which determines the positions the signs and planets have at birth, and which likewise shows the possibilities of the character.

The degree of activity of the thought-cells mapped by the planets indicates the natural aptitudes and the dominant trends. The more active a group of thought-cells is the more power they have to influence the thoughts and behavior and to attract events characteristic of them into the life. These stellar-cells have been given desires by the experiences which organized them, and they work with such energy as they possess or acquire to bring into the life the events thus desired. They work from the inner plane, exercising psychokinetic power, to influence physical events. Or to state it more technically, through the LAW OF AFFINITY they influence every event that enters the life.

But neither the degree of activity nor the desires of the thought-cells mapped by a given planet is fixed. Every experience and thought of its type adds energy to the thought-cell group and influences the specific trends of its desires. At birth these desires are harmonious or discordant as indicated by the aspects of the planets, and they seek expression through the departments of life indicated by the houses the planet rules. But through which of the departments of life ruled by the planet its stellar-cell energy chiefly will express, and through what specific events characteristic of the planet, is largely determined by the conditioning influence of the environment. Furthermore, both the conditioning offered by environment and the deliberate effort of the individual can influence the thought-cells to desire much more disastrous or much more fortunate expression than they have at birth and as therefore mapped by the birth chart.

But aside from conditioning by environment after birth it will thus be seen that the power of the birth chart to reveal the particulars of character and destiny is limited by the evolutionary level of the one whose astral body is mapped by the chart. The astral body when manifesting on the physical plane must use such materials as are at hand. If the child is born into a Mongolian family, no kind of a birth chart will give it Caucasian skin and hair.

These things must be considered not merely in judging the stature, but also in determining mental qualifications. A very small Scandinavian may be taller than a very large Japanese, and even though for his race, due to Saturn rising, he may be very dark, yet he still may be lighter in color than a native of Italy who, having the Sun rising, is light for his race.

Here in the United States, where all is a melting pot, racial traits and evolutionary levels assume especial importance. Jews, for instance, seem to take to business and the stage rather than to mining and agriculture. I believe the extension of examples is unnecessary. What is necessary, however, in all astrological judgment is to realize that the chart is merely a two-dimensional outline map of the important factors in the high velocity astral body and that such a map does not indicate the race, or even the stratum within the race, to which its owner belongs. The evolutionary level and the race must be ascertained as a part of the necessary data upon which sound judgment rests.

The Four Factors Which Indicate Stature and Appearance

Bearing in mind that the physical body is a replica of the astral body, in so far as it can express through the physical materials afforded, it seems quite certain that every position in the chart has some influence over the size and appearance of the physique. Yet four of these astrological factors have more influence in this than others.

1. Chief among such influences is the sign on the cusp of the Ascendant, and any planet that occupies the first house. And in thus considering the influence of planets in the first house, give precedence, as a rule, to the one nearest the cusp of the Ascendant. Note also any planet within fifteen¹ degrees above the Ascendant, considering it to be in conjunction with, and to influence, the Ascendant. As a rule it will be found that a planet near the Ascendant will impress its description even more strongly than the sign on the Ascendant, although in all cases the influence of both sign and planets should be combined.

When there are several planets in the first house, the planet nearest the cusp of the Ascendant will mark the appearance more certainly. But usually the body is smaller and more compact, and the more numerous the planets in this house, the smaller and more compact the body. Such a person is decidedly energetic and ambitious, but small in stature.

Except for such birth charts as are pictured in the lessons, the reader is referred to The Book of Notable Nativities for examples. King Edward there is shown to have Sagittarius 27 on the Asc. and Jupiter in Sagittarius 21, with both Saturn and Mars in the first house in the intercepted sign Capricorn. Because Jupiter is in its own sign and nearer the cusp of the Asc., even though in the twelfth house, his description was that of Jupiter in Sagittarius.

In the chart of Abraham Lincoln we also have Sagittarius rising, but giving a different form. Neptune, a planet tending to size, is a little closer to the Asc. than Saturn. Yet both planets are in conjunction with the Asc. and the combined influence of Saturn and Sagittarius outweighs the tendency to weight of Neptune and that of Jupiter being in a stout sign. Also, Saturn strongly marked the complexion and expression; for he was dark, raw-boned and six feet four in height.

2. Next in importance to the rising sign and planets in the first house, as an index to personal appearance, is the sign in which the planet ruling the sign on the cusp of the Ascendant is found. If there is a planet in the first house, it is chief ruler of the personality; any one of the planets that occupy the first house having more influence over the personality than the planet merely ruling the cusp of the Ascendant. But in all cases the planet ruling the cusp of the Ascendant is a co-ruler of the personality, and when there is no planet in the first house, or within 15¹ degrees above the Ascendant, it becomes the chief ruler of the personality.

It is found when this planet having an influence over the personality is in a long sign² it tends to heighten the stature, and when it is in a short sign it tends to shorten the stature below what would be expected from the rising sign alone.

This sign in which the ruler of the Ascendant is found, however, is not of equal importance with the rising sign as an index to the appearance. It is to be considered a secondary, modifying influence. Thus in the chart of Napoleon. I, the Aquarius-decanate of Libra is rising. Libra is a tall sign, although the middle-decanate is not so tall as the other two. As no planets are in the first house, Venus becomes the chief ruler of the personal appearance. And Venus is found in the first-decanate of Cancer. Cancer is not a tall sign, but tends to plumpness. Napoleon was notably short and inclined to be rotund.

3. As a third influence, of much less importance where personal appearance is concerned, the Sun-sign may be noted. Its influence over the size and structure of the body seems mostly to be strongly in evidence in those whose body changes markedly in weight and general contour at different ages of life. It is not uncommon, for instance, for a plump child to grow tall and thin at maturity. Nor for a thin child to take on weight in his prime. Also, persons that are slight or heavy at maturity sometimes assume opposite appearance with age. Where these conditions exist it usually will be found that the form at one period of life tends toward the rising sign and planet, and at the other, and usually shorter period, tends toward the contour to be expected from the Sun-sign.

4. Still a fourth factor should here be considered, even though it has little significance as regards size and weight of the body. The dominant planet usually stamps its impress upon the countenance. This planet may, or may not, be the one ruling the rising sign. It is simply the one, all things considered, such as house position, sign and aspects, that has the most influence over the life.

Sometimes two or more planets will be found so influential in a chart that it is difficult to determine the energy of which is most freely transmitted by the individual, even as in some people it may be difficult to say which of two or more races predominate in the blood. But usually some one planet in the figure stands out prominently, either by its elevation, its angular position, or by the many powerful aspects it makes; those to Sun, Moon and Mercury in this respect being especially important.

In the chart of Lincoln such difficulty of determination exists, as both Saturn and Neptune are conjunction the Asc., and Jupiter, close to an angle, in its co-rulership, is sextile the Moon and ruler of the Asc.

Even his life fails to clear the matter up entirely, as he so strongly exhibited the System of Saturn, the Benevolence of Jupiter and the Idealism of Neptune. Yet as Neptune is closest to the Asc., and aspects both Moon and Mercury, it is probably the dominant planet.

In the chart of Napoleon I, the Sun, Mercury and Saturn are in the 10th, but Saturn is closest to its cusp, is the most elevated planet, and is closely in opposition to the Moon. Saturn is the dominant planet. While his achievements were chiefly military, they were prompted by the urging of Saturn ambition. This planet did not influence his height, but it strongly impressed his features, as seen in his famous pose of deep meditation with downcast eyes.

Of Kaiser Wilhelm II, with world-war notoriety, the chart shows Cancer rising with no planet in the first house. The Moon, chief ruler of the personality, is in Scorpio. Therefore we expect to see a body of the Cancer type somewhat modified along Scorpio lines. But a glance reveals that he is not one who is dominated by the Moon. He fairly bristles with Mars arrogance and aggressive defiance.

Both Neptune and Mars are in the 10th, Neptune being in its own sign and closer to the M. C. than Mars. Mars, however, is almost exactly trine to the Moon, ruler of his personality. And this ruler of the personality is in the Mars sign Scorpio. His astral body, through the stellar aeries spanning it, picks up and transmits more of the planetary energy of Mars than any other, and therefore Mars is his dominant planet.

The Four Factors Which Indicate Temperament and Disposition

For many reasons, and particularly in the selection of a vocation and of close associates, It is unusually important to judge correctly the temperament and disposition. They are determined from these four factors:

1. The dominant planet of the chart, selected as previously indicated, is the most important factor. As the most influential planet in the chart, more of its particular quality of energy flows through the stellar structure of the astral form than any other. Thus the temperament and disposition manifest this type of energy conspicuously.
2. Second in importance is the personality, indicated by the rising sign and decanate, and any planet in the first house; a planet in the first house or within fifteen' degrees above it being more influential than the rising decanate and sign. Aspects to the planet which is thus shown to be the chief ruler of the personality, and aspects to the ascending degree, indicate temperamental traits.

3. Third in importance is the mentality, as shown by the sign and decanate occupied by the Moon. Aspects to the Moon show mental traits.

4. Fourth in importance, so far as temperament and disposition are concerned, is the individuality, as shown by the sign and decanate occupied by the Sun. Aspects to the Sun indicate deep-seated traits of character.

By way of illustration let us briefly apply these four factors to determine the temperament and disposition of Napoleon I. Already we have decided that Saturn is the dominant planet in his chart. He therefore was a lover of efficiency, economy and organization. His best quality was System and his worst quality Selfishness. The strongest aspect to Saturn is the opposition of the Moon—a Separative aspect—showing ambition (Saturn in 10th) and domestic tendencies (Moon in 4th) in deadly conflict.

The Aquarius-decanate of Libra is rising. It is the decanate of Independence, pictured by the Dragon, and its natives usually find expression in conflict. They have originality and tend to become leaders of some progressive movement. Venus, chief ruler of the Personality, receives good aspects from Uranus, Neptune and Mars. This gives magnetic power, vision, and energy. Best qualities, Affability and Altruism. Worst qualities, Approbation and Argumentation.

The Mentality is polarized in the Virgo-decanate of Capricorn, pictured by the Southern Fish, symbolizing guidance from the spirit side of life. It is the decanate of Idealism. Best qualities Diplomacy and Analysis. Worst qualities, Deceitfulness and Criticism. The Moon's opposition to Saturn tends to bring the Selfish quality of Saturn into prominence.

The Individuality is polarized in the Aries-decanate of Leo, pictured by the Crow, symbolizing emotions associated with creative energy, and giving a decided love of power. It is the decanate of Ambition. Best qualities, Kindness and Leadership. Worst qualities, Domination and Officiousness.

As Saturn is the dominant planet and in the house of honor, his other qualities, both good and bad, became the means by which Self-aggrandizement might be attained.

The Four Factors Which Indicate Character

Character embraces those deep-seated traits which most resist change. And these are indicated by the same four factors that indicate temperament and disposition, but the order of their importance is different.

1. Because the dominant planet maps the dynamic stellar structure through which the most energy flows, it must be considered as of first importance in determining character, even as in determining temperament.

2. But as mapping the most deep-seated and permanent of all the thought-elements comprised within the astral body, the Sun-sign is next in importance in determining character.
3. Third in importance, is indicating the type of impressions most readily received, and therefore as determining mental capacity, must be considered the sign occupied by the Moon.
4. And finally, as least important of all as regards the real character, but of so much importance in mere personality, are to be considered the rising sign and rising planet.

The Five Factors Which Indicate Mental Ability.

To the same four factors used to determine both Character and Temperament must be added a fifth to determine the mental ability. The Sun-sign signifies the Individuality, the Moon-sign the Mentality, the Rising-sign and Rising-planet the Personality, and the Dominant Planet the Planetary Family to which the Ego belongs. But the method by which the thoughts, so indicated, are expressed, is largely determined by the planet Mercury.

The dynamic stellar structure mapped by the Moon is the most open avenue by which impressions and information find access from the outside world to the astral body. The Moon-sign thus indicates the type of experience most easily received and most readily assimilated by the unconscious mind. The general trend of mental activity is thus shown by the Moon. But the method and facility with which such thoughts, and those arising from the character and personality, express is markedly determined by the sign occupied, and the aspects made, by Mercury.

And it should be noted that every aspect to the Moon and Mercury, either harmonious or discordant, increases mental capacity and mental ability. Every planet aspecting the Moon shows unconscious trains of thought concerning the things denoted in the chart by the planet. Every aspect to Mercury increases facility for expressing the qualities indicated by the planet making the aspect. If the aspect is harmonious the thoughts, unconscious or expressed, are pleasant, but if discordant they have disagreeable associations.

Of course, if the discordant aspects are too strong and too many, and the rest of the chart not strong, the mind breaks under the excessive strain. But for mental activity the Moon and Mercury should have strong aspects. And best of all for mental expression are those between Mercury and the Moon; for then the unconscious mind, indicated by the Moon, has a stellar aerial reaching across the astral body by which it finds immediate access to the trains of thought passing through the objective mind. There is a wide open avenue through which may readily be expressed whatever has been recognized within.

As I have given, in lesson No. 89, a table showing the personal appearance denoted by each sign and planet, it need not be repeated here.

In lesson No. 46 I have also given a brief analysis of the twelve signs of the zodiac, there stating the dominant idea of each as a phrase of two words which when memorized serves admirably as a key to the whole influence of the sign. And in lesson No. 47 I have in a similar manner briefly analyzed the ten planets, giving a single key-word to each which when memorized instantly calls to mind the associated qualities.

But of far more importance than merely knowing the usual influence of any sign or planet is to know its worst tendency and its best quality, and how the former may be transmuted into the latter. There are no bad planets and no bad signs. The qualities of each are equally important in world economy; all are necessary to form an organic functioning whole. The problem is, of course, to divert these characteristic qualities from their destructive trends into those which will most benefit both the individual and society.

Any planet or sign in a birth chart, if it is unusually prominent, can be turned into an asset by the expression of its best qualities to such a degree that its energies are thus completely utilized and none are left for the manifestation of its less attractive trends.

The energy must express; and it will express in terms suitable to its own nature. But it takes only a minimum of effort to turn it from one channel to the other of its own natural flow. And to indicate these natural channels of expression, to the end that destructive currents may most readily be diverted into those constructive, in the following pages I shall treat both signs and planets from this point of view. To facilitate remembering the worst quality, which so readily may be converted into the best quality, I shall employ key-words.

If it were not for complicating a matter which is best left simple, a key-word could be employed for each of the 36 decanates. A better plan, and one quite as accurate, is to join the key-word of the sign and the key-word of the sign having sub-rulership of the decanate, this sub-sign key-word being used as a secondary factor. Thus if the best qualities of the third decanate of Aries are to be found it is necessary to remember only that the best quality of Aries is Leadership, and that the best quality of Sagittarius—for this is the Sagittarius-decanate—is Loyalty. Therefore, Leadership and Loyalty are the best qualities of the last decanate of Aries.

Aries

—The Aries person to be at his best requires the zest of competition. He feels the need of combat in some form, and ever strives for personal leadership. He is extremely optimistic, and this often leads him into undertakings that are too large for him to handle. In fact, one of the things he should avoid is having too many irons in the fire at one time. His enthusiasm often leads him to rush into controversy before he has had time to examine the justice of the matter. And once he has taken up arms in behalf of a cause he is very difficult to dissuade. He is bright and lively, is a “good mixer”, likes politics, and may attain brilliancy in conversation. He is apt to be rash in love, and to overwork in business. His best quality is LEADERSHIP.

His worst quality is OFFICIOUSNESS. His desire for leadership causes him to interfere in the affairs of others when he should not. He should learn, therefore, instead of diffusing his energy, to concentrate his powers of leadership to the chosen field of his endeavor. Thoughts ruled by this sign belong to the EGOTISTICAL series.

Taurus

—The Taurus person is steadfast in mind and in habits. He follows a certain routine in the performance of his tasks, and very much dislikes to change his methods in any way. He is thorough in all he undertakes, given to perfecting the small details, and can not be hurried, pushed or frightened out of his rather deliberate pace. He is obedient to his employer, and very persistent in all that he undertakes. He has not the initiative for new undertakings, nor the courage to take great risk. Rather is he conservative both in thought and action. He is quite reliable and efficient in taking care of other people’s possessions, at banking, at agriculture, and also at accountancy. His best quality is STABILITY.

His worst quality is OBSTINACY. Early in life, therefore, he should form the habit of being steadfast toward truth and justice; for when this attitude becomes entrenched it then will not be difficult for him to give way in smaller things that he may maintain his original purpose. Thoughts ruled by this sign belong to the POSSESSIVE series.

Gemini

—The Gemini person has a very active brain and is at his best when his intellect has full scope for work. He is restless, and must constantly express himself in some way. Often he becomes a voluble talker, and may talk so much about unimportant details that important information is suppressed. He can do any number of things well, having great dexterity. His best quality is VERSATILITY.

His worst quality is CHANGEABLENESS. He not only changes his point of view, but can follow so many occupations without difficulty that he frequently does not stick to one long enough to make a marked success of it. He can do so many things well he will not endure disagreeable things in one occupation because he can always get work to do in another. He therefore should realize that any one task can be made worthy of all his ingenuity and talent, and that instead of changing occupations he should change his methods in the one he has chosen. Thoughts ruled by this sign belong to the THOUGHT series.

Cancer

—The Cancer person is exceptionally emotional, and above all else craves sympathy. Due to his extreme sensitiveness and mediumistic tendencies, environment is most important in his life. He tends to absorb all the conditions he contacts. He therefore should choose his associates with much discretion. His best quality is TENACITY.

His worst quality is TOUCHINESS. He becomes greatly upset on hearing unpleasant news, or when he fancies he has been slighted. The fear of ridicule is torture to him, and prevents him from asserting himself to advantage. But when he has a friend or an idea or a purpose to cling to, he does so with utmost patience and persistence. He should, therefore, absorb the idea that people in general are sympathetic and friendly, and that those who are otherwise are not worth bothering about. With this thought a part of himself he no longer will refuse to accept, when they are presented, the very opportunities he most desires. Thoughts ruled by this sign belong to the FEELING series.

Leo

—The Leo person has great faith and trust in other people. And other people usually respond to this faith by endeavoring to live up to his expectations. He does not demand of subordinates that which is impossible of fulfillment. He is a good entertainer. His best quality is KINDNESS.

His worst quality is DOMINATION. He has a great thirst for personal glory, and craves a position of authority. He is much better at deputizing work than at taking orders from others. And sometimes he feels he should have a position of importance when in reality he is quite incapable of efficiently filling it. He should, therefore, early realize that kindness may often best be expressed through work rather than through issuing orders, and that the highest glory obtains to him who serves best. Thoughts ruled by the sign belong to the WILL series.

Virgo

—The Virgo person loves to deal with facts rather than with theories. He inclines to statistics, and often is a walking encyclopedia of information. He takes orders readily and uses ingenuity and originality in executing them. Hence he becomes a clever accountant and a good public servant. His best quality is ANALYSIS.

His worst quality is CRITICISM. His powers of discrimination and his practicality instantly discern the flaws of other people and their plans. His assimilative functions also are sensitive, so he should use care in the selection of his food, and this sometimes leads him to be over fastidious and fussy. He becomes exceptionally valuable to executives who do planning; for he can dissect a proposition of any kind and find all its weaknesses, and determine how these can be strengthened. But to be at his best he should early realize that it takes just as keen discrimination to find good points in people and in things as to find those objectionable, and that this is even more profitable information when applied. Thoughts ruled by this sign belong to the ANALYTICAL series.

Libra

—The Libra person is a lover of perfection. He is courteous and kind, and greatly craves understanding and companionship. As a rule he should not live an isolated life, but follow his social inclinations. His best quality is AFFABILITY.

His worst quality is love of APPROBATION. He has a great dislike for injustice, and a revulsion at getting his hands or clothing soiled. Consequently he should never follow an occupation which will interfere with such fastidiousness. His natural tendency is to dabble in many things, and thus develop in true proportion. But unfortunately for him, the world pays for high efficiency in some single direction, hence he should specialize. He should choose some occupation where he meets people personally. He is a lover of harmony, and so dislikes to hurt another's feelings that he can seldom say no. He should early realize that he will be better liked by others in the long run if he has the character to render firm decisions and to be uninfluenced by flattery. Thoughts ruled by this sign belong to the EQUILIBRIUM series.

Scorpio

—The Scorpio person is very intense in his likes and dislikes, and whatever he finds to do he does with his whole might. He possesses a natural healing magnetism, and is never at a loss for plans by which difficulties may be overcome. His best quality is RESOURCEFULNESS.

His worst quality is TROUBLESOMENESS. He believes in duty, and often takes special pains to see that others fulfill all their obligations to society. He should early realize that his advantage is in concentrating his energies on the solution of his own problems, and in overcoming the obstacles to his success, rather than in insisting upon the proper conduct of others. He should also learn that his success at times depends upon his willingness to take second place, and that asking questions is not a serious acknowledgment of inferiority. Unlike Libra, he can be trusted to grapple with the most difficult and disagreeable tasks. Thoughts ruled by this sign belong to the DESIRE series.

Sagittarius

—The Sagittarius person can both give and take orders. He is naturally an executive and in both thinking and deed goes straight to the mark, caring more for effectiveness than for elegance. He is buoyant and cheerful, and should follow an occupation where there is plenty of opportunity for mental activity. At the same time he also requires fresh air and exercise. Recreation is very important to him, as he tends to burn up his vitality through over-intensity. His best quality is LOYALTY.

His worst quality is SPORTIVENESS. He is philosophically inclined, and unless given opportunity for open-air recreation is apt to develop morbid self-examination. He is frank and outspoken in his opinions, and invariably is caught if he attempts deceit or dishonesty. He lives at his best when he has found a work in life so interesting to him that it becomes a game in which success is the hazard. Thoughts ruled by this sign belong to the COMPREHENSION series.

Capricorn

—The Capricorn person is methodical and highly ambitious. He is inclined to convention, and thinks much of worldly success, money and station. He has a faculty for bringing together dissenting factions, for synthesis and economy. He is at his best when given responsibility, and can shoulder it successfully. His best quality is DIPLOMACY.

His worst quality is DECEITFULNESS. He willingly bends the knee to those above him in rank or ability, and at the same time delights in receiving homage from those under him. He is a good manager, too much inclined to carry other people's troubles and make their responsibilities his own. But in his management he ever keeps in mind his own advantage. He should early realize that the greatest advantage any person can have is integrity of character and devotion to the welfare of others. Thoughts ruled by this sign belong to the, UTILITY series.

Aquarius

—The Aquarius person understands human nature better than those born under any other sign. He knows just what to say and just what to do to produce a given effect upon those with whom he is associated. He is a master psychologist. He is very progressive, is interested in the latest developments of science and invention, and finds it easier to learn through hearing others talk than through the study of books. He is greatly concerned regarding politics and religion, and tends to view things from the stand-point of the welfare of society at large. His best quality is ALTRUISM.

His worst quality is ARGUMENTATION. He frequently will take the opposite side of a question merely for the sake of discussion. And his enthusiasm is apt to be too greatly expended in theoretically solving the difficulties of mankind rather than in efficient action. He should learn that wisdom must be accompanied by practical application if it is to accomplish anything worth while. Thoughts ruled by this sign belong to the KNOWLEDGE series.

Pisces

—The Pisces person is inclined to be plastic, and thus much influenced by environment. He should be thoroughly interested in and enthusiastic about his choice of work. He is impressionable, psychic, and emotional. His best quality is SYMPATHY.

His worst quality is WORRY. He has high ideals, and loves harmony. And because he is so sensitive to discords and to the thoughts of others he is inclined to magnify the importance of slight adversity, or imagine adversity that never comes to pass. He is at his best when working in the spirit of universal brotherhood. And to work thus effectively he must early cultivate the faculty of finishing everything he starts; otherwise there will be restrictions cropping up that will cause him to drop his work before completion. And, being deeply religious, he should realize that he is responsible only in so far as he has ability, and that he should trust Deity with the other details. Thoughts ruled by this sign belong to the BELIEF series.

Sun

—The Sun person rarely works for others to advantage, unless he is given, full charge of his department. He is in his natural sphere of endeavor when he has received a political appointment. He is always at his best when at the head of something. His best quality is RULERSHIP.

His worst quality is DICTATIVENESS. He needs early to learn that undue assumption of superiority really weakens his authority and that consideration of the opinions of others and sympathy with their views will tend toward getting better service. The thoughts ruled by this planet are called the POWER thoughts.

Moon

—The Moon person has much curiosity, and is subject to ever-changing moods. He loves notoriety, and is at his best when he is either before the public or coming constantly in touch with masses of people. His best quality is ADAPTABILITY.

His worst quality is INCONSTANCY. He should early learn that if he is to achieve fame, or to be favorably known by the public, that he must cultivate the power to persist in some one endeavor to the point of exceptional ability. The thoughts ruled by this planet are called the DOMESTIC thoughts.

Mercury

—The Mercury person is an excellent agent. He is at his best where he can attain his ends by writing, talking or travel. His best quality is EXPRESSION.

His worst quality is RESTLESSNESS. Clerical work of all kinds appeals to him, as does accountancy. He is decidedly clever, and learns a new task with great facility. He should learn, however, from the fable of the tortoise and the hare that the race is not always to the swift. Also that the highest form of expression of his mentality can only be attained through protracted concentration. The thoughts ruled by this planet are called the INTELLECTUAL thoughts.

Venus

—The Venus person needs social expression to be at his best. He is fastidious, and loves grace, music and the artistic. He is unfitted for a life of solitude; companionship is essential. His best quality is AFFECTION.

His worst quality is PLIANCY. He is entirely too desirous of pleasing others and in finding the line of least resistance. He is not fitted for hard or heavy work, but requires employment where charm of manner becomes an asset. He should early realize that he more often truly pleases when he asserts strength of character. The thoughts ruled by this planet are called the SOCIAL thoughts.

Mars

—The Mars person must have an outlet for his abundant energy either in constructive or destructive work. He becomes a good manufacturer, surgeon, or mechanic. His best quality is INITIATIVE.

His worst quality is HARSHNESS. He should early realize that there is greater satisfaction in building up than in tearing down, and that undue severity and antagonism hinder constructive enterprise. There is more opportunity for initiative in fighting disease, ignorance and poverty than in combating any human foe. Thoughts ruled by this planet are called the AGGRESSIVE thoughts.

Jupiter

—The Jupiter person gravitates to the professions, and also has ability to sell on account of his jovial personality. Menial employment is beneath his dignity, and he chafes under much restraint. He does well, however, at merchandising. His best quality is BENEVOLENCE.

His worst quality is CONCEIT. He always has a good opinion of himself. And he should early realize that Deity permitted others than himself also to have correct opinions, and that true charity demands that he give them due consideration. The thoughts ruled by this planet are called the RELIGIOUS thoughts.

Saturn

—The Saturn person loves efficiency, economy and organization. His best field is that of business man. He is shrewd and can buy to advantage, but in selling does better to employ another. His best quality is SYSTEM.

His worst quality is SELFISHNESS. He will abandon trickery when he realizes that honesty is the best policy. He has a horror of waste, and can wait patiently for his plans to mature. The thoughts ruled by this planet are called the SAFETY thoughts.

Uranus

—The Uranus person is at his best when swaying the multitude with his magnetic oratory, or when engaged in some unusual pursuit. He is unconventional, abrupt, and tends to take extreme views. His best quality is ORIGINALITY.

His worst quality is ECCENTRICITY. He is always enthusiastic about reformation of some kind. And he early should learn that conventional action and moderate views in most things will enable him the better to impress others with the sanity of the essential reform. One step at a time should be his motto. The thoughts ruled by this planet are called the INDIVIDUALISTIC thoughts.

Neptune

—The Neptune person has a lively imagination, and possesses the power to get others interested in his projects. He is a good promoter and has decided dramatic talents, but dislikes any kind of hard work. He is not given to system, and dislikes discipline. His best quality is IDEALISM.

His worst quality is VAGUENESS. He dislikes the mental labor of critical analysis of his ideas, preferring to believe what he wishes to be true. He should early learn that the only valuable ideals are those which can be made practical. The thoughts ruled by this planet are called the UTOPIAN thoughts.

Pluto

—The Pluto person, consciously or unconsciously, easily tunes in on the thoughts and energies being broadcast from the inner planes. This opens to him unusual sources of information and power. He is active, energetic and resourceful, and tends to unite with others to accomplish a common purpose. His best quality is SPIRITUALITY.

His worst quality is INVERSION. He is never milk and water in what he does, and if occasion demands does not hesitate to resort to violence. When the destructive side is dominant, all his resourcefulness and energy are turned against society. He then becomes the gangster and racketeer who unites with others of his type to spread subtle lies and prey upon humanity. The best and worst side of this planet are more vividly in contrast than those of any other. The thoughts ruled by it are called the UNIVERSAL WELFARE thoughts.

¹ Twelve degrees should be allowed. See “Table of Aspects And Their Orbs,” in B. of L. Lesson No. 87.

² See “ Personal Description Given By Signs,” in B of L. Lessons # 89

³ According to “Horoscopes of The U.S. Presidents,” Mercury has the most astrodynes.

Chapter 4

Serial No. 106
Original Copyright 1934
Elbert Benjamine

Copyright
Church of Light
August 2002

Vitality, Health and Disease

MAN'S TWOFOLD NEEDS

Afflicted	Physical Diet	Mental Diet
Sun	Iodine, Manganese, Vitamins B Complex, and A	Harmonious thoughts of vitality and power.
Moon	Proper Water-Salt Balance, Vitamin B-2.	Harmonious Mars thoughts.
Mercury	Calcium, Vitamin B-1, Vitamin D or Sunlight.	Harmonious Jupiter thoughts.
Venus	Iodine, Copper, Vitamin A and Vitamin E.	Harmonious Sun and Saturn thoughts.
Mars	Iron, Low Protein (but a variety), Vitamins A, B-1, and C.	Harmonious Moon thoughts.
Jupiter	Sulphur, care with sugar and fat.	Harmonious Mercury thoughts.
Saturn	Variety in Mineral Salts, Vitamins, Proteins.	Harmonious Venus and Sun thoughts.
Uranus	Calcium Vitamin B-1, Vitamin D or Sunlight.	Harmonious Jupiter thoughts.
Neptune	Energy, Calcium, Less Protein, vitamins D and B-1.	Harmonious Saturn and Sun thoughts.
Pluto	Protein, Iron, Calcium, Vitamins A, C, D, and B Complex	Harmonious Mars thoughts.
See:	<i>Personal Alchemy</i>	<i>Mental Alchemy</i>

Chapter 4

Vitality, Health and Disease

ANY clear conception of how to judge, from a birth chart, the length of life, the state of health, and the nature of the diseases to which an individual is predisposed, most rest upon an equally clear understanding of the relation which exists between the astral body and the physical body.

The physical body in its structure and relations, and in the events which at a given time are attracted to it, is a replica, in so far as physical materials and environment permit, of the stellar cells and their activities, as they exist in the astral body. Through the LAW OF AFFINITY the structures and activities of the finer form attract corresponding structures and events in the external life.

These stellar cells, and the stellar structures they form, which comprise the astral body are thought-built. The inner-plane substance of which the astral body is composed is a thought-responsive substance. It is organized and built into temporary or more permanent form through sensations, emotions, mental impressions and other states of consciousness. Either in the lower or the higher forms of life the event which transpires is of far less importance to an organism in its effect upon the astral form than the mental reaction to the event. Chiefly it is the state of consciousness which accompanies the event which is significant.

Every organism on earth, from bacteria and amoebae up to man, has an astral form in which is retained the total of previous states of consciousness. These mental reactions to its experiences in the past have given it the present organization of its astral form, which in turn determines the kind of physical organism it occupies. That is, the astral form of every living thing is thought-built.

Each cell of the human body is such an organism, having its own experiences, its own limited consciousness, and its own astral form built by such consciousness. But the astral body of a man is not the sum total of the astral forms of these physical cells. Instead the astral body of a man is a completely distinct thought-built organism which has temporarily annexed, for the purposes of its physical life, the various cells and other intelligences which are embraced within its physical body. The astral body of man can, and does, function on the astral plane when entirely separated from the astral replicas of the cells of its physical body. It is only dependent upon these cells in its relation to material expression.

The type and vigor of the physical cells, with their astral counterparts, which are attracted to the individual, are determined by the thought-built stellar cells and the manner of their organization, in his astral body. And it is because the birth chart—through mapping the thought-compounds which enter into these stellar cells and mapping the relations between stellar structures built by these thought-cells—gives a fairly accurate picture of the mental organization of the astral body, that it affords a very accurate method of determining the length of life, and of diagnosing disease.

There are twelve quite distinct zones in the anatomy of the astral body, each zone closely limited by one of the zodiacal signs. Thus Aries always maps the head zone, Taurus the neck zone, and Pisces the feet zone.

But in addition to these zones, which occupy the same relation to the body in all persons, there are also twelve compartments in the astral body. These compartments, to which the stellar cells built by thoughts concerning a certain department of life move, are mapped by the mundane houses of a birth chart.

Thus it is that thoughts about health and the physical body add their astral substance to the stellar cells in the compartment mapped by the first house and thoughts about money and personal property add themselves to the compartment of the astral body mapped by the second house.

But the zone embraced within a compartment varies with the person. The first house compartment may embrace the head, as shown by the sign Aries there, or it may embrace the feet, as shown by the sign Pisces. In one instance, therefore, the thoughts in reference to health and physical appearance which are built into the astral body are in the region of the head, and in the other instances they are built into the astral body in the region of the feet.

Not always it is easy to picture in low velocity terms all the relations within the astral body; for it is a high velocity form. And, of course, it is still more difficult to ascertain from a birth chart, which is a two-dimensional representation, the interaction of the various forces of this inner-plane body. There are, therefore, due to the restrictions of expression on a two-dimensional surface, limits as to what a birth chart reveals. It does not, for instance, reveal the evolutionary level; does not reveal if the chart is that of a man or a dog.

But whether the chart is that of a man, a dog, or some other living thing, due allowance being made for the limits of a two-dimensional surface in portrayal of high velocity existence, it maps the more important mental factors within the astral body, and their relation to each other, of which the physical form is a replica. The physical form, its vitality, health and disease, as well as all other attributes, are as they are because the thought-built stellar cells and stellar structures are of a type and relation which attract the physical cells and relations which the body express.

Health is the physical expression of stellar cells and stellar structures within the astral body which are vigorous and in harmony one with another. Disease, on the other hand, is always the expression either of weak stellar cells, or of stellar structures which are discordant one with another. That is, either health or disease is the result of thoughts or less complex mental reactions which in the past, perhaps before birth into human form, built the astral body in a particular way.

The chart is not the cause of a disease. Neither are the planets in the sky its cause. They merely show its presence and nature. The disease, or whatever the condition in life is under consideration, is attracted through the thought-organization of the finer form. And this finer form is being modified by every thought and every experience of life. As it is thus modified the fortune changes accordingly.

The birth chart maps on a two-dimensional surface the thought-organization at birth. Progressed aspects indicate when temporary stellar aerals are formed which permit planetary energies of a specific nature to flow into the astral body and stimulate corresponding types of thought-cells into unusual activity.

But as the astral body is a thought-built organism, it may also be altered and changed by building into it other thoughts. In fact, throughout life it is being so changed by every experience; but because no intelligent effort is devoted to changing the inner trends, which are entirely unrecognized by most, the ordinary individual does very little to change the type of events which his birth chart indicates will be attracted to him.

Stellar Aerials are Mapped by Aspects

—Having mentioned stellar aerals, some brief explanation should be made.

Wherever a planet is located in the birth chart maps an organization of stellar cells in the astral body which is unusually active. It is because these cells express the activity and quality of the planet which maps them most strongly that they are thus mapped by the particular planet. Because they thus form a structure within the astral body which has a high degree of activity they are known as dynamic stellar structures.

Each dynamic stellar structure has the property of acting as a receiving set for the planetary energy of its corresponding type. And every aspect from one planet to another maps an astral line extending through the astral body, of a length corresponding to the aspect, which connects the two planets. This line functions as an aerial which picks up, radio fashion, the astral planetary vibrations of both planets.

If a planet in a birth chart has no aspect, it never-the-less maps a receiving set for picking up its energies, but the dynamic thought-center thus indicated has an antenna which acts merely as a short loop aerial. Energy of greater volume is, of course, picked up by the aerials mapped by heavy aspects. And every aerial, according to its length, that is, the nature of the aspect, has the property of transmitting the energy it picks up in a harmonious manner or as complicated by discordant static.

These lines through the astral body which are mapped by aspects in the birth chart are called permanent aerials. But there are others which form when a planet by progression gets within one degree of the perfect aspect to another birth chart, or progressed planet. These which pick up the energy of the two planets only during the time the planets are within one degree or less of their perfect aspect, are called temporary aerials.

Both the permanent aerials and the temporary aerials are important not merely in matters of health and disease, but in every department of life. The amount of activity of any group of thought-cells within the astral body at a particular time is determined by the amount of planetary energy which at that time it receives. This, in turn, depends upon the aerials, mapped by aspects, which at that time are picking up and transmitting planetary energy to this group of thought-cells.

Furthermore, upon the amount and nature of the activity of the various groups of thought-cells within the astral body depends the intensity and the kind of events which are attracted to the individual. This, again, is determined by whether or not the planetary energy reaching the group of thought-cells is received not merely in volume, but over aerials which are free from discord or over those which are loaded with nerve-racking static.

Everything which a life experiences is attracted to it by corresponding activities within the thought-organization of the astral body. Delineating character, the general trend of events, or predicting their precise time and nature, by natal astrology is wholly dependent upon the ability to determine from planetary positions what group of thought-cells is stimulated, in what way it is stimulated, and the resistance of environment to its efforts.

And it follows from this as a corollary, one which has been demonstrated in the lives of innumerable earnest aspirants, that the control of life and destiny depends upon, not merely drifting in the direction indicated by the birth chart and progressed aspects, but in giving the thought-groups within the astral body which are mapped by the planets the type of energies which will activate them to attract such qualities and events into the life as most are desired.

Now as the physical body is a replica of the astral body in so far as physical materials are at hand for that purpose, it follows that every group of thought-cells within the astral body has some influence over the health. Each represents the inner condition of which the corresponding physical tissues and functions are the more external manifestation. Therefore, in considering the health, and the type of disease toward which an individual is predisposed, no planet in the chart should be neglected.

Health, however, is not the same thing as vitality. An individual may be quite healthy all his life, but die young because he has not sufficient vitality to recuperate from the first attack of some disease. On the other hand, we have in our files the charts of people who have lived to beyond ninety years who have been in poor health most of their lives, seldom knowing a day free from some ache or pain.

The Solar-Lunar Electromagnetic Body of Man

—In order to understand this, and to be able to judge the length of life, it is necessary to know the composition of the electromagnetic body.

Astral substance, including stellar cells, stellar structures, and the thoughts which build them, does not communicate its energies directly to physical substance. There is too wide a gap between the velocities of inner-plane existence and outer plane existence for these two worlds to affect each other directly. They only exchange energies through that boundary substance which commonly is called electromagnetism.

All forms of physical organisms—bacterium, plant or animal—in the processes of the chemical changes which represent their metabolism, generate electromagnetic energy. This electromagnetic energy constitutes the physical life-force of the organism and in its totality is called the electromagnetic body. The nerve currents of man, and the magnetic reactions of plants to stimuli, are merely specialized forms of this electromagnetic energy.

The electromagnetic body is not, however, of a single polarity, but like a magnet contains within itself energy of two different kinds; positive and negative. Experiment indicates that the positive electromagnetic energy of any life-form is ruled by the Sun; while the negative electromagnetic energy of any life-form is ruled by the Moon. It is the interaction of this solar electromagnetic energy with the lunar electromagnetic energy, of the masculine with the feminine, of Osiris with Isis, that gives that which we call life to any physical organism.

Furthermore—as conclusively indicated by studies carried out in the preparation of C. of L. Astrological Report No. 17, in which the birth charts of 150 people whose time of birth is accurately known, and who each lived beyond 70 years—the vital force of both man and woman is ruled by the Sun. Of the birth charts analyzed in the Report, 70 were those of women and 80 were those of men.¹ And the same rules apply in this respect for one sex as for the other. The positive, electric energy is that which gives vitality and recuperative power; and its abundance, vigor and persistence is indicated by the Sun in a birth chart.

Vitality, therefore, but not health nor length of life, may be judged from the house position, sign location and aspects of the Sun in any birth chart.

Length of life is dependent upon still other factors than the power and strength of the positive, electric energy of the body. It is also dependent upon those factors which contribute to the strength of the constitution.

At the present time physical science has not advanced far enough that the difference between the electromagnetic energies which radiate the frequencies that afford vitality and those that nourish and sustain the constitution can be indicated by terminology as precise as is to be desired. Instead, as yet we must refer to Sun frequency electromagnetic radiations as affording the vitality of living things, and Moon frequency electromagnetic radiations as in some manner the polar opposite, or at least less intense electromagnetic phenomenon which is essential to health.

For sake of convenience we call this feminine, soothing electromagnetic energy ruled by the Moon the constitutional magnetism. And next to the Sun, the house position, sign location and aspects of the Moon are most important in judging length of life, health and disease.

The Moon, however, is only one factor in gauging the strength of the constitution. Every planet in the chart maps the state of activity of the most energetic thought-cells in its particular region of the astral body. It indicates the kind of thought-cells there located, how vigorous they are, and whether they are in a state of harmonious cooperation or are stirred to rebellion. And these dynamic stellar structures thus mapped by, and receiving energy from, the planets, indicate similar strength or weakness in the physical organs and tissues corresponding to their location.

Even the Sun, in addition to mapping the specialized stellar structure where the astral body receives the vital solar energy which determines the vitality, also by its position and aspects maps the condition of the physical tissue in that region of the physical body.

Thus in determining the strength of the constitution, every sign, planet, and relation has a bearing as indicating how strong the physical organs are and how much stress they will endure.

We have, always, therefore, in determining length of life, to weigh the vitality and recuperative power shown by the Sun against whatever weaknesses the constitution indicates. If the constitution is weak enough, or if there are powerful enough afflictions by progression to impair it, such vital strength as the Sun may show will not suffice to prolong the life. That is, if the chart is otherwise sufficiently discordant, no position of the Sun in a birth chart can prevent physical dissolution.

On the other hand if the constitution, as indicated by the chart as a whole, is sufficiently strong and harmonious, even a rather weak and discordant Sun may afford vitality enough that the individual lives to a good age.

Length of life is thus a balance between the weaknesses of the body and the strength of the vital electric energy which sustains it; a balance between the weaknesses of the chart as a whole and the power of the Sun. And on this basis, weighing the one against the other, must it be judged.

Some zodiacal signs, as analysis in C. of L. Report No. 17 shows, more commonly map greater vitality than others, and aspects from certain planets promote longevity in a marked degree.

In the birth charts of women, Scorpio as a Sun-sign is least conducive to long life, but as a rising sign it gives more who live beyond 70 years than any other sign. Cancer as a Sun-sign gives the highest number of women who live to beyond 70, and is also favorable to them as a rising sign. Next as Sun-sign of women beyond 70 comes the sign Pisces; but none is poorer for them as a rising sun. Following this, Aries as a Sun-sign gives more women of advanced age; but it also for them is a poor rising sign.

In the birth charts of men, Capricorn comes first, Cancer second, with Taurus and Leo tying for a poor third place, as Sun-sign in those who live beyond 70. Only one sign, Sagittarius, is poorer than Scorpio as a Sun-sign for giving length of life to men; but next to Cancer, which has the highest score, Scorpio and Virgo as rising signs give more men who reach an advanced age.

While an affliction of Mars to the Sun indicates discord where the constitution is concerned, which is sure thus to be a source of trouble and perhaps disease, yet any aspect of Mars to the Sun, in either a man's chart or a woman's, adds vital power. Mars is the planet of energy, and this energy added to the solar vitality tends to prolong the life. Of women beyond 70 years, 77% have some aspect of Mars to the Sun in their birth charts. Of men beyond 70, 74% have some aspect of Mars to the Sun in their birth charts.

Next in importance to an aspect of Mars to the Sun, as conducing to length of life, is a good aspect from Jupiter to the Sun at birth. Of the 70 women past 70 years, 39% had a good aspect of Jupiter to the Sun at birth. And of 80 men past 70 years, 51% had a good aspect from Jupiter to the Sun in their charts of birth.

Of the women 44%, and of the men 48%, had the Sun in an angle at birth.

Not as giving vitality, but as endowing with a more abundant constitutional magnetism, 40% of the women and 34% of the men, had the Moon in an angle.

For the detailed statistics, the book, **BODY DISEASE AND ITS STELLAR TREATMENT** should be consulted, yet even it must omit the most important consideration of all, which is the comparative strength and harmony of the Sun as balanced against the weaknesses and discords of the constitution as revealed by the various planets and their aspects.

Gauging Health

—The health, which may be good so long as it lasts in one who dies young, depends not merely upon the Sun, but upon the soundness of the tissues, as mapped by the planets, and the magnetic strength of the constitution. No noticeable position in the chart should be neglected in determining this; but chiefly should be considered in this order of importance: the Moon, the Sun, Mercury, the Ascendant and the Sixth House.

Influence of the Moon on Health

—The electromagnetic body, as already indicated, is a solar-lunar combination of energy, of which the Sun is exclusive ruler of the vital force. But in its effect upon the magnetic constitution, and therefore upon the health, the Moon is equally important.

The Moon maps the most receptive planetary terminal in the astral body, the place where impressions both from the external world and from the inner plane reach the unconscious mind. It maps where energy of great volume, regardless of its character, is picked up and transmitted to the finer form. This is a negative region, and any stellar aerial reaching it, as mapped by an aspect to the Moon, or even by the swiftly recurring progressed aspects of the Moon, carries the energy of the planet thus indicated freely into the astral body.

It is because the Moon is thus so openly receptive to the energies of the environment that the person develops the habit of acquiring information from the outside world in a given way. It is easier to receive impressions through the avenue indicated by the sign and aspects of the Moon. And because of this, the mental capacity develops readily along allied lines. Thus, even as we say the Sun, mapping the most deep-seated and permanent characteristics, rules the Individuality, so it is common to say that the Moon rules the Mentality.

Mercury, through the conscious processes of formulating thoughts, rules the method of mental expression. But the Moon rules all those innumerable impressions which reach the unconscious mind, so many of which come from the contacts of domestic life and associations with the common people.

And because these impressions are so numerous, reach the finer body in such volume, and directly affect the constitutional magnetism, they are always potent factors in determining the health.

The unconscious thoughts, as the psychoanalysts have so convincingly proved, often are far more significant where the health is concerned than those which, under the rulership of Mercury, escape censor, and find conscious, even though not verbal, expression. Therefore, in determining the strength or weakness of the constitution, especial attention should be paid to the position and aspects of the Moon.

Influence of the Sun on Health

—In diagnosing diseases the Sun, because it rules the vitality, should be given precedence. But in merely determining the strength of the constitution, and where in the body the natural weaknesses are located, it is no more important, perhaps not so much so, than the Moon. Yet the Sun also maps a group of intensely active thought-cells in the astral body, and if these are strong the physical body in that region will tend to be free from disease.

The Sun and Moon rule, not merely the stellar cells and stellar structures within the astral body, but also the positive electric energy and the negative magnetic energy which, permeating the physical body and traversing the nerves as currents, alone permit the astral energies of the finer body to reach and alter the cells and tissues of the physical body. Thus due to their more direct influence over the medium by which thought-energies or planetary energies alone can contact the physical, they are more important in natal astrology than the other planets.

Influence of Mercury on Health

—The electric currents furnished through the activities of the Sun and Moon, however, are susceptible of having their direction of flow changed, and their vibratory rate raised or lowered, through conscious thought. Thus Mercury, ruling such thoughts, becomes also a powerful influence in any birth chart; for the thinking he promotes tunes in the electric energies flowing over the nerves on the rates of vibration corresponding to these thoughts.

Furthermore, these thoughts which come under Mercury's rule are fed by the individual's mental activities into his astral body. They represent his habitual trend in thinking, and therefore, whether he is adding elements and compounds to his astral form which conduce to, or detract from, a condition of health.

The significance of both Mercury and the thoughts which it governs is made apparent when we consider that the sign Virgo, ruled by Mercury, is the ruler both of foods and of the house of illness in the natural chart. The thoughts which we think are the foods we feed our astral bodies, and upon the quality of mental food thus furnished depends in great measure the state of health. If we nourish the stellar cells only with discordant thought-compounds, illness will surely follow. Thus is Mercury, in matters of health, only less important than Sun and Moon.

Influence of the First House on Health

—All those thoughts, feelings and impulses of the past which have had the body as their primary object of consideration have entered into the thought-compounds of the stellar cells which fill the compartment of the astral body mapped by the first house. This is the most powerful compartment in the astral body, although approximately equaled by the one mapped by the tenth house. That is, a greater volume of energy flows through it normally than through other compartments.

Any planet in the house, and to a less extent the planet ruling the cusp of the house, because it connects up so directly with the physical body, has an influence over the health. A malefic planet here, or one afflicted, indicates a corresponding impairment of the physical body. But, because the house is so strong, such an affliction is less inimical to the health than the same planet located in the sixth house.

The degree upon the ascendant maps a heavy line running across the astral body, which can be seen clairvoyantly. This is not merely an astral line, but a line of electromagnetic energy also through which the whole astral body is grounded. Aspects to this ground wire, or ascending degree, act, where health and personality are concerned as do aspects to the planets. They are almost as important as the aspects to the Sun, Moon and Mercury.

Statistical study of thousands of charts, made in the preparation of our Astrological Reports on the various diseases indicates that, except when a disease is present from birth, the individual becomes ill only when there is a major progressed aspect, other than from the Moon, to the ruler or co-ruler of the first house. Minor complaints which afterwards are considered inconsequential, of course, are not thus included.

The aspect may be either discordant or harmonious, but the energy from the aspect responsible for stimulating the stellar cells of the astral body discordantly, can only reach and influence the physical body markedly when there is a stellar aerial, mapped by a progressed aspect which is within one degree of perfect, carrying energy to the first house.

Influence of the Sixth House on Health

—All those thoughts, feelings and impulses of the past which have been associated with illness and labor have entered into the thought-compounds and form the stellar cells of, that compartment of the stellar body mapped by the sixth house. Less planetary energy reaches this compartment, normally, than flows through any of the other twelve compartments of the astral body. As a consequence, the sixth is the weakest house of them all, and marks the bodily zone of the least resistance.

It would be an error to conclude from this that the sixth house usually, or even commonly, denotes the kind of illness to which the person is predisposed. Indicating, as it does, a region of the body of little vigor and energy, unless the ruler of the sixth is afflicted, it merely denotes the various conditions, such as the services rendered by others and the general environment, during illness.

If a malefic is in the sixth, however, or if the ruler of the sixth is severely afflicted, such affliction, because directly associated with the compartment of the astral body which governs illness, has greater power to attract illness, and to predispose toward the kind of illness thus indicated, than if the afflicted planet were in, or ruled, any other house. That is, a planet ruling the sixth house is more significant of the kind of illness, and as indicating tendencies to illness, than the same planet would be similarly aspected in any other house of the birth chart.

Furthermore, our statistical studies of thousands of charts at the time their owners became ill, as set forth in the B. of L. Astrological Reports, indicate that, except when a disease is present from birth, or is an inconsequential minor ailment, an individual becomes ill only at those times when there is a major progressed aspect, other than from the Moon, to the ruler or co-ruler of the sixth house.

As the highest function of a healer is to keep people well, it is a valuable asset for him to know that illness only develops when there are temporary stellar aerals leading both into the first house and into the sixth house of the birth chart. Whatever discords are present through temporary stellar aerals formed by aspects, they only affect the health conspicuously when at the same time there are aerals leading into the astral compartment ruling the health, and into the astral compartment ruling the illness, of the body.

And these major progressed aspects, to be effective, must be within one degree of perfect.

Very much the same situation exists in regard to other events which enter the life. They only take place when temporary stellar aerals form leading into the compartment of the astral body where the thought-cells are retained having to do with such events. Not that the aspect to the ruler of the house is necessarily the energy which stimulates these cells to the activity which attracts the event; but it provides an avenue by which the more powerful planetary energies, which may be picked up by aerals shown by other and apparently unrelated aspects, gain access to the compartment and stir up its stellar cells. These heavier energies coming in over powerful aspects, which take advantage of the aerals mapped by less pronounced aspects to reach compartments other than those which their planets rule, are called RALLYING FORCES.

Such information gives the individual or the healer a means of determining the periods in life when the health, rather than finances, honor, or affections, will be apt to be affected. But to prevent the occurrence of illness at the times when there are heavy discordant planetary energies, as shown by the progressed aspects, which through progressed aspects to the rulers of the first and sixth find access to the stellar cells of the compartment ruling health and the compartment ruling illness, the kind of disease which is apt to develop at the given time should also be known.

When a Planet is Prominent

—As one of the factors which constantly must be considered in such diagnosing, and in all delineating from a birth chart, is that of the prominence of a planet, it should be made clear in this place when and why a planet is thus considered.

Any planet in an angle indicates that its energies in reaching the astral body and its thought-cells meet little resistance, and that, therefore, more of its energy reaches and influences the individual than were it not so located. Thus a planet in any Angular House is Prominent.

As already explained, the astral energies of the Sun and those of the Moon have direct access to the electromagnetic body. And the planet Mercury, through its rulership of the nerves and the electromagnetic currents which move over them in response to the thoughts, is a third planet having direct access to the electromagnetic body.

When a planet receives very powerful aspects, especially if a heavy aspect is not more than one degree from perfect, it must be considered prominent irrespective of not being in an angle and aspecting Sun, Moon or Mercury. But such prominence constitutes an exception to the general rule that only such planets in a birth chart as are in an angle, or which aspect Sun, Moon or Mercury with a reasonable degree of closeness are to be considered Prominent.

Determining the Diseases to Which a Person is Predisposed

—It is impossible, in a single lesson, to present more than a few of the considerations which bear upon the diagnosis of diseases from the birth chart.

It is found, however, that for each disease there are a few well defined factors which are constantly present in the charts of all who have it. These are called the Birth chart Constants.

Likewise it is found that at the time the disease manifests there are equally well defined and constant major progressed aspects. These are called the Progressed Constants.

These constants are ascertained by analyzing the birth charts of those who have had certain diseases, and by analyzing the major progressed aspects at the time the disease became noticeable. When possible we base such analyses on the charts of 100 persons who have had a given disease.

In Course 16, STELLAR DIAGNOSIS AND STELLAR HEALING, I have given both the Birth chart Constants and the Progressed Constants for 160 of the most familiar diseases, with example birth chart for each and the progressions at the time of illness. In the same manner we propose eventually, in the C. of L. Astrological Reports, to cover every important disease and all other afflictions to which man is subject. Both the details of diagnosis and the method of using planetary energies to heal are set forth in the 12 lessons of Course 16.

The Birth chart Constants of any particular disease are usually restricted to the prominence and aspects of two, although sometimes one and sometimes three or more, planets. This means that any person not having the specified, and usually narrowly restricted, influences present in his chart which are the constants of the disease is practically immune from it. Those whose charts exhibit the Birth chart Constants may not have the disease; but they have a predisposition toward it, which, if suitable conditions arise will permit it to develop.

The Progressed Constants for any particular disease may be restricted to a progressed aspect to some one planet, although in certain diseases it may include any one of two or more planets. This means that those in whose charts the Birth chart Constants are present, do not develop the disease, except at such times as the major progressed aspects, which must usually be perfect within one degree of orb, are of the type, and between such planets, as are designated by the Progressed Constants. At other times the individual may have such troubles, including diseases, as the progressed aspects signify, but he is practically immune to this disease.

This does not signify that a person who has the Birth chart Constants of a certain disease, and arrives at a time of life when the Progressed Constants of the disease form in his chart, always then has the disease, or ever has it. The stellar cells and dynamic stellar structures within the astral body tend to attract, as active thought forces possessing a certain subjective intelligence of their own, conditions into the life which correspond to their activity. This activity, however, may be influenced not merely by planetary energies coming in over stellar aeriols mapped by aspects, but by planetary energies diverted to such purposes in the processes of STELLAR HEALING, and by the conscious application of appropriate thoughts in the processes of MENTAL ALCHEMY.

Furthermore, thought groups in the astral body can only bring about such physical conditions as are permitted by the physical environment. Where the human body is concerned planetary activities make use of the ductless glands, which are unusually sensitive to the thoughts, feelings and emotions aroused by them. Each planet, when its energies are discordantly received, as explained in Course 16, calls forth a definite response from certain of the ductless glands, and this modifies the chemistry of the body accordingly. But when the proper elements are present in the food, these glands, and other physiological functions, tend to retain their normal activity in spite of planetary discord.

It follows, therefore, because the unconscious thought-activities of the astral body which are stimulated by planetary energies must bring about physical changes through physical methods, that proper selection of foods and other physical conditions may make it impossible for a disease to develop. Just what the most essential food requirements are under the affliction of each planet is set forth in detail in lessons 153, 222, 223, 224 and 225, which also constitute the book STELLAR DIETETICS.

In regard to these constants, it should be understood that they apply not merely to diseases of the physical body, but to all conditions and events of life.

The loss of money and the gain of money are always coincident with progressed aspects indicating loss or gain, and always coincident with a major progressed aspect to the ruler of the second house. The constants for 20 different events, including one or more typical of each of the twelve houses of the chart, are set forth with the statistical analysis of 2,000 charts progressed to the time of events in the book ASTROLOGY: 30 YEARS RESEARCH.

In determining the diseases which an individual will probably have, it is safe to scan the birth chart and select the heaviest afflictions in the chart, all things considered, as indicating the diseases to which he is predisposed.

The SUN afflicted is a Birth chart Constant of high blood pressure, infantile paralysis, pneumonia, and diseases of the spine. In heart disease, the most common of all fatal afflictions, the Birth chart Constant is an affliction in Leo, or the Sun severely afflicted. The Progressed Constant is a progressed aspect made by the Sun, or a progressed aspect to a planet in Leo; with discordant rallying forces.

The MOON is always involved in dropsy, is often a factor in mental complaints, is involved with Mars in the various types of eye trouble, and with Saturn in afflictions to the ears. It may also affect the stomach.

MERCURY is involved in nervousness, certain mental troubles, neuralgia, neuritis, sciatica, hay fever, asthma and some bowel complaints.

VENUS tends to affect the kidneys, the venous blood stream, the thyroids and the internal sex organs. Either Venus or Mars may be involved in the so-called social diseases and in female trouble.

MARS when prominent and afflicted invites infection, inflammation and the contagious diseases such as small-pox, measles, scarlet fever and chicken-pox. It is a factor in burns, typhoid, malaria, blood-poison and rheumatism, as well as in some kidney troubles and in urinary complaints.

JUPITER afflicts through over abundance of something. Some acidosis, one type of diabetes, and biliousness, catarrh, auto-intoxication, carbuncles and fatty tumors are under his influence.

SATURN always afflicts through a deficiency. His typical diseases are cancer, fibrous tumor, tuberculosis, pellagra, atrophy and constipation.

URANUS has for typical diseases, appendicitis and paralysis; but is also a factor in arthritis, infantile paralysis and nervous complaints.

NEPTUNE tends to a negativeness which permits invasion by bacteria, and to the formation of moist pockets of infection, which may be quite hidden or may develop into ulcers.

PLUTO also tends to negativeness and a high degree of sensitiveness which encourages invasion by other organisms and invites hives, hay fever and asthma when Mercury also is involved.

Neither Birth chart Constants nor Progressed Constants, however, should be considered as inevitable and unalterable conditions. The Birth chart Constants merely map the organized thought-activities of the astral body as they exist at birth. The Progressed Constants merely indicate that at a predetermined time during the life stellar aeries will form across the astral body which will pick up the energies of certain planets in volume and with or without static.

The planetary energies thus picked up and delivered to the astral body in those compartments mapped by the birth chart and progressed positions of the planets, and affecting through sympathetic response the compartments ruled by the planets, that is, mapped by the signs which the planets rule, give new energy and activity to the thought-cells there located. It is due to this new energy that events corresponding to them are attracted. It is due to the discordant activities of these thought-cells that disease is attracted, and due to their harmonious activities that good fortune comes into the life. Whatever event comes is attracted through the LAW OF AFFINITY by corresponding thought-cell activities at that time within the astral body.

But such additional activities as the thought-cells in the astral body display are not dependent upon planetary energies, but can be induced by the conscious feeling of the individual. Anything that can be added to the astral body by planetary energies can also be added through volitionally directed thought.

Thoughts and feelings can be cultivated which build a very different astral body, and therefore a very different life, than that mapped by the birth chart. Thoughts and feelings can be cultivated which are powerful enough to cancel and annul the energies received from any planet due to the formation of a temporary aerial as indicated by a progressed aspect. Thoughts and feelings can be cultivated which will add the same type and quantity of energy to any compartment of the astral body as would be added by the stellar aerial mapped by a sextile or a trine of the selected planet.

Man has thus within his own power the ability to prevent a disease which Birth chart and Progressed Constants indicate, or to alter any other undesirable phase of his life. The technique by which thoughts and feelings are applied for healing and other specific purposes is set forth in full detail in the 7 lessons of Course 9, MENTAL ALCHEMY.

¹ Astrology: 30 Years of Research

Chapter 5

Serial No. 107
Original Copyright 1934
Elbert Benjamine

Copyright
Church of Light
August 2002

Business, Finances and Vocational Selection

Chapter 5

Business, Finances, and Vocational Selection

IF, as we firmly believe, the most successful and most spiritual type of life open to any organism is that in which it contributes its utmost to universal welfare, the occupation followed by an individual has implications of tremendous importance. His health, his domestic life and his recreation aid him in the building of character and the acquiring of abilities. But it is chiefly in his work—either his vocation or his avocation—that he has the opportunity to contribute most to the common good of society.

Vocational selection should have for its object the placing of the individual in the particular line of work where he will be of greatest benefit, not merely to himself, but to the world at large. And if he is to continue productive, it is necessary for him to have a source of income. Therefore, in the selection of an occupation the matter of financial revenue should not be overlooked.

The amount of revenue which may be obtained from a given type of work, however, is seldom commensurate with the benefit it confers upon others; but is governed by many artificial conditions which manipulate the law of supply and demand. Poe sold the poem which made him famous, “The Raven,” for \$10.00. Very few of the great inventions have yielded much money to their originators. And the scientists who give to the world the most valuable discoveries, for the most part get nothing for them other than personal gratification; earning the money for their research through teaching or some other modest occupation.

When, therefore, the talents of the individual fit him particularly for some useful accomplishment which has little or no financial demand at the period in which he lives, it is appropriate that he should seek in addition to this work which may be followed as an avocation, an occupation which yields a revenue. Just as scientists more commonly earn their living as college instructors, so usually it is possible to find a financially remunerative work in which whatever ability the individual has can find, if not the highest, at least beneficial, expression. Whether the individual makes his greatest contribution to the common good through the occupation in which he makes his living, or through the line of endeavor which thus making a living enables him to follow, in each instance his highest success depends upon utilizing his most pronounced abilities.

Any type of ability, however, is capable of being used under a wide variety of environmental conditions. And quite aside from ability, the environment of its use may, and often does, contribute factors which determine whether there is success or failure.

No matter how skilled an aviator may be, a defect in his plane may cause his own death and the death of his passengers. No matter how shrewd a financier may be, a sudden bank failure may bring his ruin. An earthquake may wipe out the business man of exceptional merchandising skill. A lawyer may become the target of criminal malice. A doctor may contract infection. A farmer may have his crops destroyed by hail. These in spite of unusual skill and customary precaution.

In all success there is an element other than ability which plays an important part. It is commonly called luck. But where the individual is concerned this element, which when discordant enough may bring ruin to the most skillfully handled enterprise, is in reality the habitual manner in which the thought-cells within his astral body perform when he is brought into contact with certain environmental conditions.

These thought-cells, or stellar cells, as we more commonly call them, are the units of which the astral body is composed, much as the physical body is composed of protoplasm cells and their secretions. And it is within this astral body, which is a thought built body, that both the mental factors which express as ability, and those which, acting from the inner plane, attract fortune or misfortune, are retained.

Not only are most of the processes and functions of the physical body—such as the circulation, digestion, assimilation, secretion, and the opposite pull of the innumerable muscles required to enable us to sit in a chair or stand erect—controlled by the thought cells and their organizations within the astral body, but these thought organizations exert a constant and powerful influence to attract events

It is a mere platitude to say that character is destiny. But when it is realized that the character of an individual is the sum total of the thoughts which have been built, as stellar cells and stellar structures, into his astral body, the statement acquires dynamic significance. For each stellar cell and each organization of thought-cells has such intelligence as has been imparted to it, and is capable of independent activities on the inner plane which are within the scope of that intelligence. It is these inner plane activities of the thought groups embraced within the astral body which bring to an individual the events of his life.

Whatever an individual may be at a given time, including his abilities and his tendency to attract events of a particular type rather than those of another type, results from the sum total of his past experiences as these have been organized as mental factors within his finer body. The events which are attracted at a particular time are due to the activities of one or more of the thought groups within his astral body which have at the time been given more than a normal amount of energy. This unusual supply of energy may be acquired by properly directed thought; but commonly is the result of planetary energy flowing into the thought group over the temporary aerial formed by a progressed planetary aspect.

The planets by their positions in the birth-chart map the most active thought groups within the astral body at the time of birth. But the planetary positions are not thus the cause of them. They are located as mapped, and have the kind of activity indicated, because the experiences of the soul previous to the time of human birth built them into the astral form.

In vocational selection we are interested in these dynamic stellar structures which are mapped by the planets in the birth-chart because they point in an unmistakable manner to the natural aptitudes an individual possesses and to the amount of harmony or discord he may expect to attract in any given environmental association. These are the two considerations which determine the line of work any individual may best follow.

It may be asked why it is that some people, or for that matter some dogs, are born with one kind of ability and one kind of fortune, and their fellows are born with a different kind of ability and a different kind of fortune.

One who observes nature finds, as a matter of fact, that no two life-forms have just the same qualities or undergo just the same experiences. There is the utmost diversity both in capabilities and in the fortunes of creatures. This is because the experiences they undergo constitute their training; and they need different training because each is being educated to fill a different position in the cosmic scheme.

An organism can only function as such through specialization and division of labor. The universe is a most complex organism whose ever expanding frontiers demand new workers, each having ability of a highly specialized kind. Souls are called into differentiation in response to the future cosmic needs, and are trained through their experiences for the particular type of activity in which they ultimately are to engage.

At the moment of their differentiation they are given the polarity, or trend, which attracts to them the long series of events which is the only means nature has of developing special abilities. These experiences, and the mental attitude toward them, build impulses, feeling, and emotions into the astral body as stellar cells.

Judging the Aptitudes.

—This is not the place to trace the evolution of the soul from the time of its differentiation through the astral spheres and the lower kingdoms of physical life on earth. The universal laws, which anyone can see at work if he will look about him at other life-forms, under which such evolution takes place, and many details concerning them, are set forth in Course XIX. Here it is mentioned only because, to get a clear conception of the operation of astrological forces on human life it is necessary to know that the aptitudes and the fortune trends with which any person is born have been acquired through experiences in lower forms of life, that they exist within the astral body as thought organizations, or stellar structures, and are mapped by the signs and planets of the birth-chart.

The experiences which a soul undergoes are of ten distinct types, and the mental reaction, or state of consciousness, resulting from each type of experience gives rise to a distinct family of thoughts. Thus are there ten families of thoughts. The thought-elements belonging to these ten families enter into thought-compounds which form the stellar cells of the astral body. And the more powerful the thought-cells belonging to a particular family are, the more prominently are its stellar cells mapped in the birth-chart.

The importance of this lies in the circumstance that the more prominent a planet is in the birth-chart the more powerful and active are the stellar cells and the dynamic stellar structure which this planet maps. That is, the experiences of the individual before birth have been such as to give him very little aptitude of the quality mapped by a planet lacking in prominence, but have been such as to build up a powerful thought organization in his astral body of the quality of any prominent planet. And whenever the astral body contains such a powerful group of stellar cells belonging to a certain family, this signifies that the soul has had ample experience of this type before human birth to develop the kind of aptitudes given by this thought family.

Ability of a certain kind can not be judged exclusively by the volume of experiences related to it. The lines of association which connect these experiences to those of other types must also be considered. But it can safely be concluded that unless there have been such experiences in volume the ability of this kind will be small. And the more prominent a planet is in the birth-chart the greater the volume of experiences of its type does it map. The stellar cells forming the dynamic stellar structure at that point in the astral body, acting as the terminal of a stellar aerial, receive planetary energy constantly, and continue in a high state of activity. They represent aptitudes that readily can be converted into ability.

In lesson No. 106 I have explained why any planet in an angle, or in reasonably close aspect to Sun, Moon or Mercury must be considered prominent. And in lesson No. 105 has been explained how the Dominant Planet in the chart should be selected. It is the most influential planet in the chart because more of its particular quality of energy flows through the stellar structures of the astral body than any other. The thought-cells it maps are the most active group in the chart, and thus indicate natural aptitudes of the kind related to their thought family.

Each of the ten thought families, together with the best quality and worst quality expressed by it, is listed under its appropriate planet in lesson No. 105. And in the same lesson the manner in which a family expresses the particular thought-element, or urge, belonging to each series of the twelve is set forth, with the best quality and worst quality of the series, under its ruling zodiacal sign.

Now, any planet in the chart which is prominent indicates aptitude of the nature denoted by the planet. But in expressing this aptitude, which is to be gauged by the amount of prominence of the planet, the number of aspects it makes and the strength of these aspects, the individual should be allowed to follow the methods indicated by his temperament and disposition.

The rules for judging temperament and disposition are explained, in lesson No. 105: Dominant planet first, the first house next, the mentality third, and the Sun-sign fourth.

The individual may have pronounced abilities other than those shown by these four factors; but if any attempt is made to express them in a manner not consistent with the temperament and disposition, there is sure to be discomfort. When he tries to more follow an occupation which is at variance with the temperament and disposition, even though he has the ability to perform such work, a distaste for it arises which contributes neither to happiness nor high accomplishment. Temperament and disposition, therefore, should be considered as playing an essential part in the selection of the abilities which can be used to greatest advantage.

Selecting an Outlet for the Abilities.

—Whatever the abilities may be, in order that they may be effective they must express themselves in the accomplishment of something; and this implies that they be used in a definite direction and amid certain surroundings.

These environmental associations within which abilities are used have a character vibration which is radiated from them and which impinges upon the astral body of a person in much the same way that planetary vibrations do. In fact, the astral energy which each thing radiates is really of the same type as corresponding thought energy or planetary energy.

The radiations of objects and people which thus influence those who come into close association with them are called Character Vibrations. All astral vibrations capable of influencing human life, therefore, are embraced within the three terms: astrological vibrations, thought vibrations and character vibrations. And both thought vibrations and character vibrations can be classified according to the planetary vibrations having the same rate and consequently the same affect.

Now, the soul as it evolved through various astral and physical forms, due to the original attractive and repulsive qualities with which it was endowed, has had repeated experiences with objects and intelligences belonging to each of the ten planetary types. Because this original attractive and repulsive quality was determined by its need for experience to accomplish its special education, it has been attracted more often to situations of a given planetary type than some other soul; and its attitude, or mental reaction, to such conditions as it has met also has been peculiar to its own polarity.

Situations which it has met with a feeling of pleasure, even though that pleasure was the high gratification at overcoming an enemy or an obstacle after a painful and exhausting struggle, have incorporated into its stellar cells thought-elements which have combined with other thought-elements in harmonious compounds. But every situation or condition which has been productive of an attitude of distaste, discomfort, or pain, has built thought-elements into the stellar cells of the astral body as discordant compounds.

Whenever the stellar structures within the astral body which are composed of harmoniously compounded thought-elements are given additional energy from the thoughts, from the planets, or from the character vibrations of objects, they become active in proportion to the amount of astral energy so received. And because they are harmonious, this activity is directed, according to the intelligence they possess, toward bringing into the life those conditions commonly called fortunate.

Likewise, whenever the stellar structures within the astral body which are composed of discordantly compounded thought-elements are given additional energy from the thoughts, from the planets, or from the character vibrations of objects, they also become active in proportion to the amount of astral energy so received. But, because they are discordant, this activity is directed, according to the intelligence they possess, toward bringing into the life those conditions commonly called unfortunate.

The birth-chart, by the aspects, indicates to what extent the stellar cells and stellar structures of each type are built of harmoniously or discordantly compounded thought-elements. And as the type of character vibration of various environmental conditions is known, it is possible to determine what stellar cells will be given additional energy through associating with such an environment, and whether the stellar cells so stimulated will use this additional energy, and their intelligence, to attract fortune or to attract misfortune.

To associate with those things the character vibrations of which are ruled by a harmoniously aspected planet in the birth-chart is to attract good fortune. The more prominent the planet and the more harmonious the better, because the aerial mapped by the aspect picks up all energy of the type, whether from the planet, from thoughts, or from character vibrations, and conducts it harmoniously to the stellar cells in the astral body which the planet maps.

When we associate with the things ruled by an inharmoniously aspected planet, the character vibrations from it are picked up by the stellar aerial stretching across the astral body as mapped by the aspect, and are given so much static by the aerial as they are conducted to the stellar cells that these thought-cells, feeling the discord, work energetically to bring into the life conditions corresponding to their inharmony.

Selecting the Vocation.

—In selecting a vocation, therefore, the aptitudes of the individual should be appraised, and an effort made to find an outlet for these special aptitudes amid conditions that will not attract too much misfortune. That is, in so far as practicable, the environments ruled by planets which are discordant in the birth-chart should be avoided in favor of those ruled by more harmonious planets. And in this appraisal of the effects of an environmental association over the life it must be remembered that only a prominent planet indicates a volume of energy, either for better or worse, which is important.

As a broad general rule, which is subject to various practical considerations, we can say that the best vocation for an individual is one which permits his highest ability to express amid the surroundings ruled by the best planet in his birth-chart.

These practical considerations, among which is the demand for work of a particular type, often force the most successful individuals into environmental associations which are decidedly discordant. But their abilities, combined with the more fortunate positions in their birth-charts are sufficient to enable them to achieve high ends in spite of the various obstacles, set-backs, and disagreeable circumstances attracted by the discordantly stimulated stellar cells mapped by the badly aspected planet.

People are not born with the abilities used in vocations. In lower forms of life there has been no experience in handling a typewriter, for instance. But there may have been other experiences of the Mercury type which have built into the thought-cells mental alertness, quick adaptability and manual dexterity which make it easy to learn to handle a typewriter expertly. Such people are born with natural aptitudes which when given training readily become specific Mercury abilities. And if there have also been numerous third house experiences before human birth, they may readily be attracted to, and become proficient in, typing.

People are born with natural aptitudes which under suitable training are readily converted into specific abilities. And the general rule in vocational selection is to unite the abilities already possessed, or which the natural aptitudes indicate can be developed to a marked degree, with as harmonious an environment as can be found for their expression. But there are much more specific and detailed rules for judging suitability for each vocation which can only be ascertained by careful analysis and the statistical study of large series of birth-charts of those who actually have followed the vocation.

The Brotherhood of Light Research Department spent 18 years and thousands of dollars collecting 100 timed birth-data each of those who followed 30 different vocations. The birth-charts were erected, and were then analyzed by the statistical method, in which each significant position is given in terms of percentage. While 30 vocations are but a fraction of those followed by people, these that were thus analyzed employ abilities developed from all the natural aptitudes in various combinations. The reference book in which these analyses and other findings are published, *HOW TO SELECT A VOCATION*,* thus aims completely to cover the subject of astrological vocational selection.

In addition to certain planets being prominent, and thus showing natural aptitudes commonly utilized in the vocation, those following most vocations have charts in which there is outstanding house activity which is significant. Experiences in lower forms of life have been not merely of planetary family types, but also associated with the various departments of life. Lower forms of life take journeys, such as are ruled by the third house, build homes, such as are ruled by the fourth house, care for offspring, such as are ruled by the fifth house, and in some degree have experiences related to each of the twelve departments of life, the thought-cells relating to which are mapped by the twelve houses of the birth-chart.

Such thought-cell activity due to extensive experiences with a certain department of life has a power to attract the individual into association with the things of this department of life. Thus architects have active third and fourth houses, while doctors have active sixth and twelfth houses. Such details are beyond the scope of this lesson, but that the general rules may be applied intelligently I shall here give the more important environmental things, and also the type of ability, ruled by each of the ten planets.

SUN.—The Sun rules gold, politics, persons of authority, the male sex in general, and those who employ others.

In method he inclines to official positions, civil or political, or to deputies appointed by office holders. He must be at the head of something, even if but a shop foreman or the head of a small department in some business.

MOON.—The Moon rules silver, liquids, the common people, commodities, hotels, the home, food, the female sex in general, and has some significance over music.

In method she inclines to everyday business in the retail trade, to fishing, seamanship, nursing, and to serving food. She is at her best when meeting large numbers of all kinds of people.

MERCURY.—Mercury rules books, railroads, periodicals, telephone and telegraph systems, and people who are literary or studious.

His methods incline to talking, writing, traveling, teaching, and the constant use of the mind. Clerical work, accountancy, postal work, traveling salesman, or acting as an agent, is in line with his inclinations. He must have opportunity to express his mentality.

VENUS.—Venus rules flowers, art of all kinds, dancing, wearing apparel, fancy goods, confectionary, pastry, toilet articles, jewelry, people of a social turn, and has some significance over music.

In method she inclines from hard work and depends upon affability, grace of manners and good taste. She relies upon that which pleases rather than upon that which is of necessity.

MARS.—Mars rules steel, machinery of all kinds, implements of construction or destruction, intoxicating drink, and among people, cooks, soldiers, surgeons and mechanics.

In method he is aggressive, and either destructive or constructive. He therefore takes to all mechanical work, to war, and to surgery. He must have an outlet for his abundant creative energy.

J U P I T E R .—Jupiter rules judges, clergymen, bankers, professional men of all kinds, merchandise and persons of wealth.

He does well in any of the professions, and also as a salesman of things appealing to those of considerable means. While Mercury depends upon shrewdness and cleverness, Jupiter depends upon good fellowship and a genial personality. He appeals to the better class of patronage and can sell either his own abilities or his merchandise to the very best advantage.

SATURN.—Saturn rules basic utilities, such as minerals, hay, grain, coal and building material. He also rules mines, real estate, the land, business methods and sedate or elderly people.

In method he depends upon foresight, system, economy, management and persistent labor. He predisposes to sedentary employment and to laborious work. Mining and agriculture are in his line, as is business management in general. He has not the personality to make a good direct-contact salesman, but he can buy to advantage and is a shrewd trader.

URANUS.—Uranus rules inventions, automobiles and late mechanical devices, orators, lawyers, electricians, astrology and occultists.

In method he is original, inventive, and tends to the uncommon. He has the power to influence others through his magnetism, and must have an outlet for his unusual ingenuity.

NEPTUNE.—Neptune rules oil, gas, drugs, the drama, moving pictures, aviation, mediums, mystics, psychic people and schemes requiring incorporation or the profit-sharing of a number of people.

In method he is visionary and dislikes physical work, but has the power to impart to others enthusiasm for his plans. Consequently, he makes a good promoter, one who carries out psychic work of some nature, or who practices some progressive method of healing.

PLUTO.—Pluto rules chemists, television, the wireless transmission of messages or power, intra-atomic and cosmic sources of energy, national planning, gangsters, kidnaping, and compulsory codes for the benefit of the people as a whole.

In method he requires the close co-operation of a number of people, the regimentation of public opinion, works cunningly but has no compunction about resorting to force, and utilizes the latest discoveries and inventions in the carrying out of his purposes.

The Three Factors of Business Success.

—It frequently happens that a person who is unusually successful in handling a business for another is able to earn a very nice salary; but as soon as he goes into business for himself he loses all he has. On the other hand, a person who makes very little success in the employ of others often is able to make a marked success when he breaks away from such servitude and establishes himself independently. In determining this there are three chief things to consider.

1. The first, and most important of these three factors, is the tenth house. The cusp of the tenth house is marked through the astral body by a thin blue line. And all astral energy which reaches this line is widely broadcast. It is the apex of the chart where astral energy is brought to a focus and radiated in a manner which brings it to public notice. The sharp blue line mapped by the degree on the M. C. thus acts as an amplifier. In the compartment of the astral body mapped by the tenth house are all the thoughts, impulses and feelings of the past which have to do with credit, honor, business and promotion. They are present as harmonious or discordant compounds which attract to the individual the conditions in reference to business and honor corresponding to the aspects of the planets which map their condition. And, because they have ready access to the amplifying device of the M. C., their influence, whatever it may be, gets the widest publicity.

As a general rule, the more elevated a planet is in the chart, that is, the closer it is to the cusp of the M. C., the more readily the qualities represented by the stellar structures it maps get publicity. But as affecting the honor and business in particular, any planet aspecting the cusp of the tenth, or aspecting a planet in the tenth, and thus mapping a stellar aerial reaching to the amplifier, is more important than a planet elevated and not in the tenth.

If, therefore, the rulers of the tenth house, and the cusp of the tenth (the amplifier), are well aspected, it is an excellent indication that the person can make a success in business for himself. But if planets in the tenth, the cusp of the tenth, or the ruler of the cusp of the tenth, receive inharmonious aspects, it indicates difficulties that tend to hamper an independent business.

2. Another factor, which may, or may not, be next in importance in determining if a person will succeed in a business for himself is the Sun. When a person owns and controls a business he becomes the center about which the whole enterprise revolves. If the Power-urges in his astral body, as mapped by the Sun, are powerful and harmonious, this controlling power will tend to success. But if the Power-urges are weak or inharmonious, as indicated by a weak and afflicted Sun in the birth-chart, his power of control over the business tends toward disorganization and failure.

The Sun becomes more important in proportion as the activities of other persons must be directed in the business, especially if such direction must be made through personal contact. Bosses, either in politics or in business, need a well aspected Sun if possible; but at least a prominent Sun.

3. From the purely financial end, rather than that of ability to direct and control, the two business planets, Jupiter and Saturn, are of more importance than the Sun. Where buying, selling, bargaining and sound business judgment are concerned, these are the two influences that must be relied upon. If they are weak and afflicted they indicate lack of business ability; but to the extent they are prominent and well aspected they indicate both the judgment and the luck which tend to financial success.

When the three factors of business success—the tenth house, the Sun, and the business planets—are weak and much afflicted, it is better for the individual not to go into business for himself, but to be content to work in the employ of others. This need be no great hardship, as at the present day there seems to be no limit to the salary it is possible to command in the services of the larger companies and corporations.

The business an individual would like to follow often is indicated by a planet in the tenth house, or if no planet is in this house, by the ruler of its cusp. But such an inclination does not signify that the person actually will follow the business, or even that it would be wise for him to do so. It merely indicates that there are stellar cells which have been built into the compartment of his astral body mapped by the tenth house which have had thought associations such as to incline him toward a particular type of endeavor.

In reference to business success, and to retaining a position of prominence in world affairs, it is interesting to compare the charts, here given, of Henry Ford and Grau San Martin. Under the progressed positions shown San Martin was elevated to the position of president of Cuba. Sudden elevation is typical of such a progressed aspect to Uranus; but although his chart shows political sagacity and exceptional personal ability, his tenth house was not powerful enough to retain him in power. After about six months he was compelled to resign in favor of a man with a stronger tenth house.

Securing Employment.

—To the extent the position involves promotion, responsibility, credit, or even limited public recognition, it implies activities of the thought-cells organized in that portion of the astral body mapped by the tenth house. But the actual labor involved, and the various conditions under which that labor is performed, are indicated, and attracted by, the stellar cells which are in that portion of the astral body mapped by the sixth house.

In matters of employment, as in other things, each individual, according to his birth-chart, has a normal trend. Some individuals are seldom out of work, and others seldom are employed. But when there is any departure from this norm, such as to be noticeable, where employment is concerned, the reference book, *When and What Events Will Happen,** shows statistically that there is always a temporary stellar aerial formed at that time, as mapped by a progressed aspect, leading into a house having to do with that employment.

In so far as the situation secured or lost involves credit, honor, or responsibility, there is a major progressed aspect, within one degree of perfect, to the ruler of the tenth house. In so far as the situation secured or lost involves a change in the matter of labor, there is a major progressed aspect, within one degree of perfect, to the ruler of the sixth house.

Most changes of any consequence where employment is concerned involve both the matter of preference as well as that of labor. Analysis reveals, as set forth in *When and What Events Will Happen,** that when people gain employment or lose it there is a major progressed aspect to the ruler of the sixth and a major progressed aspect to the ruler of the tenth. Jobs which last only a month or so may be indicated by merely a progressed aspect of the Moon.

The kind of position secured depends upon, not merely the amount of activity, but the harmony or discord of the activity of the stellar cells mapped by the tenth house and sixth house. Their normal activity, of course, is indicated by these houses in the birth chart. But when progressed aspects form to their rulers, temporary stellar arials permit additional planetary energy to gain access to these stellar cells and increase their activity. This is~ what brings or loses the position.

But the harmony or discord of the energy received by these cells from the planets may not be determined by the harmony or discord of the aspects leading into these two houses. If there are other, even though unrelated, progressed aspects in the chart at the same time, these indicate stellar arials picking up planetary energy of the harmony or discord indicated by the aspects.

Because the thoughts and feelings tune the electromagnetic energies to their rate, if these heavier aspects cause the thoughts and feelings to be dominated by the energy they map, this tunes the etheric body to their particular harmony or discordant static. And this enables these other planetary energies, using electromagnetic energy of a corresponding vibration as a conductor, to gain access to the compartment of the astral body into which at the time any other temporary stellar aerial extends.

If the individual understands this, and keeps his thoughts and feelings tuned to the best progressed aspect present at the time, he has a powerful means at hand for attracting good fortune. Thus, as it is actually observed in analyzing charts, a good position is often secured when the ruler of the tenth is afflicted, if at the same time there is a more powerful harmonious progressed aspect in the chart which acts as a Rallying Force.

It is often observed that people lose their jobs at times under a good progressed aspect to the ruler of the tenth, because there is at the same time some more powerful discordant aspect which acts as a Rallying Force. But unless the thought-cells mapped by the tenth and sixth houses are given new energy through some major progressed aspect leading to the rulers of these houses there will be no marked change in employment.

The Four Factors of Making Money.

—1. Of most importance in the power to make money is the amount of activity, and the harmony and discord, of the stellar cells within the compartment of the astral body mapped by the second house. And in judging this bear in mind that the thought-cells mapped by Venus bring money with little effort, those mapped by Jupiter through fortunate transactions and the good will of others, those mapped by Mars through strife, and that they incline to squander it, and those mapped by Saturn, while they tend to save and hoard, are such as bring wealth only through persistent and laborious effort.

2. Next in importance are the prominence and aspects of the business planets, Jupiter and Saturn. The thought-cells of Jupiter show power to attract wealth, and those of Saturn to keep it.

3. Third in importance is the tenth house, the stellar cells of which determine so largely the person's honor, credit, reputation and success in business. These all have a bearing on money making.

4. Fourth in importance are the Sun and Moon. The thought-cells mapped in the astral body by the Sun show the power to attract gold and the good will of those in power. The thought-cells in the astral body mapped by the Moon show the power to attract silver and the good will of the common people. Thus if the Sun is well aspected and prominent and the Moon is afflicted, it is a waste of time to bother with small sales and little business deals, as there is greater success through a few large transactions. But if the Moon is prominent and well aspected and the Sun afflicted, it is better to follow a business in which there is a large turn over, even though each transaction is small.

Wealth, however, is not confined to gold and silver, even though it is measured by them. If an activity is to yield ready financial returns it is much better that a favorable aspect from the house ruling it should lead to the ruler of the second house. But even aside from this, a favorably aspected planet may be considered a potential source of wealth. The activities of the thought-cells denoted by houses much afflicted seldom bring wealth and always bring trouble.

Money is gained through the first house by capitalizing the personality, such as in selling through personal contact. Banking and finances come under the second house. Transportation, mail order and writing are avenues of the third house. Real estate and hotels belong to the fourth house. The fifth house governs stocks, bonds, speculation and entertainment. The sixth house has to do with the preparation and serving of foods. The seventh house gives gain through meeting the public. The eighth house relates to gifts, the partner's money, inheritance and the investment of other people's money. The ninth house brings gain through teaching, lecturing and publishing. The tenth is the house of business. The eleventh house capitalizes on friendship, politically or as a sales avenue, or as professional hostess or reception clerk. The twelfth house indicates gain through large live stock, through detective work, or in association with hospitals and places of detention.

As already indicated in selecting the outlet for the abilities, for best fortune the individual should associate with those things which are indicated by harmonious stellar cells in his astral body. This applies to selecting the things ruled by any house in the chart as a possible source of wealth.

Where to Succeed.

—It is not uncommon for a person to fail in one locality and succeed in another. The sign occupied in the birth-chart by the best planet for money indicates the type of environment where success with money will be greatest. Thus also, the sign occupied by the planet most afflicting the money prospects is the environment where money making will be most difficult. Tables showing the rulership of the various environments by the signs are given in lesson No. 90.

When the tenth and ninth houses are more harmonious than the fourth and third, a person can do better at some distance from the, locality of birth. And in case a move is advisable, the direction from the place of birth that the best planet for money making is in the birth-chart—the left hand side of the chart being east, the top south, the right hand side west, and the bottom north—is, other considerations not contradicting, the direction in which success would be most pronounced.

Indications of Honors.

—The stellar cells which have been built into the compartment of the astral body covered by the tenth house are more significant than any others in indicating the reputation. However, in this connection the Sun, as representing the attitude of those in authority, and the Moon, as representing the attitude of the common people, should also receive some consideration.

People with no planets elevated—as witnessed in the charts of Grau San Martin and Thomas A. Edison—may attain fame through unusual accomplishment. In such instances an aspect from the planet ruling the accomplishment to the M. C., or to the ruler of the tenth, enables it to reach the amplifier and thus get public recognition.

Henry Ford, with planets in the tenth, nevertheless is better known for his handling of labor in the interests of universal welfare, as indicated by Pluto in the sixth in close trine to the M. C., than for anything else. Thomas A. Edison, with only one planet above the horizon, is noted for his inventions, as indicated by a close trine of Uranus to the M. C. Grau San Martin gained fame through his military activity, shown by Mars in close trine to the M. C., in connection with revolution as shown by Uranus trine the ruler of the tenth, and his temporary position of president of his country, as indicated by the Sun trine to the ruler of the tenth.

But for wide public recognition, either favorable or unfavorable, other than through such unusual contributions to society which are so important they can not be overlooked, elevated planets, the nearer the M. C. the better, are the common essential.

The Factor of Control.

—As the success in business, the money acquired, the honors attained, and all other circumstances of life are attracted by the condition of the thought-cells of certain compartments in the astral body, the birth-chart indicates, not the inevitable conditions, but what changes must be brought about in the thought-cells thus mapped if the conditions attracted are to be those desired.

These thought-cells and the stellar structures they form, attract events at a particular time in life because of the energy added to them by temporary stellar aerals, mapped by aspects. The fortune or misfortune of the event so attracted is determined by the harmony or discord of the stellar cells thus stimulated into activity. This harmony or discord, however, is not entirely dependent upon the aspects of the planets, but is subject to considerable control by induced emotion and directed thinking.

Especially is it possible, when there is one harmonious progressed aspect, even though it is not powerful, so to tune the thoughts and feelings to its influence as to permit its energies to reach and enter all the compartments of the astral body which are at the same time reached by temporary stellar aerals mapped by other progressed aspects no matter what their nature. Through MENTAL ALCHEMY, and through this intelligent application of RALLYING FORCES which places the planetary energies received under the individual's control, an aspect which otherwise would indicate a misfortune may be made a force for attracting fortunate events.

“Out of print, see Church of Light Research Cyclopedia

Chapter 6

Serial No. 108
Original Copyright 1934
Elbert Benjamine

Copyright
Church of Light
August 2002

Friends, Enemies and Associates

Chapter 6

Friends, Enemies and Associates

THE power of the various objects and persons which an individual contacts to influence his life and destiny either in the direction he desires or contrary to his wishes, is determined by the amount and kind of energy they contribute to definite groups of thought-cells within his astral body. The control of his life, and its most effective direction into the channels of his choosing, therefore, must include an intelligent selection of friends and inanimate associates.

Whether animate or inanimate, whether a musical tone or an unspoken thought, each close associate radiates astral energy the quality of which may be determined. This invisible energy finds its way, over the stellar aeries which span the astral body of man, to the stellar cells within, and adds its activities to such of them as it thus reaches.

These stellar cells, and the thought-structures they compose, are located in the particular compartment of the astral body relating to the department of life about which the thoughts, impulses and emotions which furnished their substance had their origin. And when they are furnished with additional energy from planets, from the thoughts of the individual, or from the character vibrations of such associates as we are now considering, they work, with such subjective intelligence as they possess, to attract into the life events relating to this department of life.

That is, stellar cells having had their origin in impulses relating to personal property, when they are given new energy, work to attract into the life events having to do with money. And stellar cells having had their origin in feelings about friendship, when energy enough is afforded them bring into the life events relating to friendship. The compartments of the astral body where stellar cells and stellar structures are located, according to the department of their origin, are mapped by the houses of the birth-chart.

Astral energy from planets, thoughts, or character vibrations can only reach the thought-cells within any particular compartment of the astral body in unusual volume through being picked up, radio fashion, by one of the stellar aerials, mapped by an aspect, which traverses the astral body. These stellar aerials lead directly into certain compartments and not into other compartments. The energy thus picked up by such an aerial flows readily into the compartments mapped by its planetary terminals. And through sympathetic response it is able to reach, although in a minor degree of volume, the stellar cells in the compartments ruled by the planets which map its terminals.

Caruso's famous, and oft' repeated cafe demonstration with a wine glass illustrates this principle of sympathetic response. Entering a cafe he would call for a glass, tap it to get its tone, and instruct the waiter to place it on the farther side of the room. Then, with his vibrant voice sounding the same tone, the wine glass across the room would be shattered. In a less dramatic way the response of a piano string, when its tone is sounded on some other instrument in the same vicinity, also affords a parallel example.

Any stellar aerial, either permanent as mapped by an aspect in the birth-chart or temporary as mapped by a progressed aspect, is capable of picking up only astral energy of the vibratory rates corresponding to the two planets which map its terminals. If there is an aspect between Mars and Saturn, for instance, the stellar aerial so mapped has the ability to pick up either Mars vibratory rates or Saturn vibratory rates, but is unable to pick up the vibratory rates of the Sun, Venus, or Jupiter.

Furthermore, which is most important, whatever Mars energy or whatever Saturn energy is picked up from any source by such an aerial is given either a harmonious quality or a quality of discordant static, according to the length of the aerial as mapped by the aspect.

Whatever comes in over an aerial mapped by a square aspect, for instance, is given so much discord by the aerial that when it reaches the stellar cells of the compartments where its terminals are located they are made to feel intensely uncomfortable. Prodded to activity in a most disagreeable way they move, in their inner-plane manner, to bring an obstacle into the life relating to their department. That is, if they are located in the eleventh compartment, the obstacle will arise from friends; but if they are located in the second compartment, the obstacle will be to the making or retaining of money.

If, therefore, we possess a knowledge of the vibratory quality, or planetary rulership, of the various things we contact, and the birth-chart of an individual, we are in a position to determine how associating with any particular thing will influence him.

Vibratory rates which must reach the thought-cells of his astral body over an aerial which gives them discordant static are inclined to attract to him only disagreeable events. But vibratory rates which must reach the thought-cells of his astral body over an aerial which gives them a harmonious trend are inclined to attract to him fortunate conditions.

Events Are Attracted Only by Increased Activity of Thought-Cells.

—And the department of life chiefly thus influenced, either for fortune or misfortune, is the one the stellar cells of which are given the greatest activity by the new energy received.

Aside from aerials leading into them the zones of the astral body mapped by the signs of the zodiac each have a characteristic resonance. They are thus, as explained, influenced through sympathetic response. And this sympathetic response is not merely to the energy coming in over the aerial one terminal of which is mapped by the ruling planet of the sign, but also to the thought vibrations and character vibrations of the same rate as the sign.

If, for instance, an individual is closely associated with things ruled by the sign Aries, the whole zone of the astral body mapped by the sign Aries responds to the vibrations of these Aries things. The stellar cells thus, through sympathetic response, gain new energy and become more active. But, because Aries energy is also received by the stellar aerial which has Mars as one terminal, the sympathetic response to this Mars aerial tends to determine whether the activity thus stimulated is one of harmony or one of discord.

The most active and highly organized stellar structures in any compartment of the astral body are mapped by planets. Wherever a planet is located in the birth-chart is a group of thought-cells in a high state of activity. The major thought-element of which they are composed belongs to the family ruled by the planet thus mapping them. They form the terminal in the astral body for such aerials as are indicated by the aspects of this planet.

Because of their organization as a dynamic stellar structure, and the energy they receive from the aerials for which they act as a terminal, they have much more power and more readily become active than the other cells in the same compartment not mapped by a planet. Yet when the stellar cells surrounding them become active due to energy received by sympathetic response, either to the vibrations of objects ruled by the sign, or to energies picked up by an aerial mapped by any aspect to the planet ruling the sign, this activity is communicated by direct contact to the dynamic stellar structures mapped by planets in the sign.

Because the thought-cells mapped by a planet in the sign are so much more vigorous, any activity imparted to the stellar cells of the compartment mapped by a sign, even more profoundly affects the group of thought-cells thus acting as the terminal for an aerial. The energy is conveyed to them by direct contact with other stellar cells in the same zone; and because of their greater vigor what they accomplish is of considerable more importance than what is accomplished by the cells, not acting thus as aerial terminals, which convey the energy to them.

Thus if Jupiter is in Aries, such vibratory rates of the Aries frequency as are contacted will have an influence over the life predominantly such as is indicated by the prominence and aspects of Jupiter. Only to a less extent will the influence be that indicated by the aspects of the planet Mars, if that planet is located in some other house of the birth-chart.

With this information at our disposal it is no difficult matter to determine quite definitely how close association with anything the astrological ruler-ship of which is known will affect a given individual. If the object is under the direct rule of a planet, the stellar cells which its vibrations will reach in greatest volume are those mapped in the birth-chart by the planet.

This planet is located in a certain house of the birth-chart, mapping a compartment of the astral body. It will, therefore, be a dynamic stellar structure of this compartment which receives the major portion of this additional energy. And as the thought-cells of this whole compartment have had their origin in impulses, feelings, and other mental activities relating to one department, the result of their increased activity will attract events into the life relating to this department. That is, events will be attracted which are ruled by the house of the birth-chart containing the planet.

To a minor degree, through the activity gained by the sympathetic response of the stellar cells there mapped, events will also be attracted ruled by any house the cusp of which is ruled by this planet.

If the object is ruled by a zodiacal sign, and thus only indirectly under the rule of a planet, the stellar cells which its vibrations reach more directly are those of the compartment mapped by that zodiacal sign. The major influence, therefore will relate to the department of life ruled by the house of the birth-chart so indicated.

Only in a less degree, because the planetary aerial picks up some of the energy of the vibration of the sign it rules, will energy reach the compartment of the astral body mapped by the planet ruling the sign, and thus have some influence toward attracting events relating to it.

But when there is a planet in the sign ruling the object with which there is association, the type of energy of this planet and its harmony or discord are more important than are those of the planet ruling the sign and elsewhere located.

Therefore, in judging the effect of the character vibrations or thought vibrations ruled by a planet, look chiefly to the house position and aspects of the planet. But in judging the effect of the character vibrations or thought vibrations ruled by a zodiacal sign, look chiefly to the house position of the sign, and to any planet in the sign. If there is no planet in the sign, look chiefly to the house position of the sign in reference to the department of life affected, but to the aspects of the planet ruling the sign to determine the harmony or discord thus accentuated.

Character Vibrations.—The kind of business and type of person ruled by each planet and sign are given in lesson No. 107. The part of the country, climate, part of city and part of home ruled by each sign are given in Course VIII, Lesson No. 90. And in Course VI the herbs and flowers, stones, branch of science and human function ruled by each sign are set forth in connection with the corresponding Major Arcanum of the tarot. Here, therefore, only the briefest mention will be made of important associations ruled by each sign and planet.

ARIES.—Number 13. Letter M. Color, light red. Tone, high C. Talismanic gem, amethyst.

TAURUS.—Number 14. Letter N. Color, dark yellow. Tone, low E. Talismanic gem, agate.

GEMINI.—Number 17. Letter F, Ph, P. Color, light violet. Tone, high B. Talismanic gem, beryl.

CANCER.—Number 18. Letter Sh, Ts, Tz. Color, light green. Tone, high F. Talismanic gem, emerald.

LEO.—Number 19. Letter Q. Color, light orange. Tone, high D. Talismanic gem, ruby.

VIRGO.—Number 2. Letter B. Color, dark violet. Tone, low B. Talismanic gem, jasper.

LIBRA.—Number 3. Letter G. Color, light yellow. Tone, high E. Talismanic gem, diamond.

SCORPIO.—Number 4. Letter D. Color, dark red. Tone, low C. Talismanic gem, topaz.

SAGITTARIUS.—Number 7. Letter Z. Color, light purple. Tone, high A. Talismanic gem, red garnet.

CAPRICORN.—Number 8. Letter H, Ch. Color, dark blue. Tone, low G. Talismanic gem, onyx.

AQUARIUS.—Number 9. Letter Th. Color, sky blue. Tone, high G. Talismanic gem, blue sapphire.

PISCES.—Number 12. Letter L. Color, dark purple. Tone, low A. Talismanic gem, peridot.

SUN.—Number 21. Letter S. Color, orange. Tone, D. Metal, gold. Flower, helianthus and gaillardia.

MOON.—Number 20. Letter R. Color, green. Tone, F. Metal, silver. Flower, lily.

MERCURY.—Number 1. Letter A. Color, violet. Tone, B. Metal, quicksilver. Flower, jasmine and honeysuckle.

VENUS.—Number 6. Letter U, V, W. Color, yellow. Tone, E. Metal, copper. Flower, rose.

MARS.—16. Letter O. Color, red. Tone, C. Metal, iron. Flower, hollyhock.

JUPITER.—Number 5. Letter E. Color, purple. Tone, A. Metal, tin. Flower, dahlia.

SATURN.—Number 15. Letter X. Color, blue. Tone, G. Metal, lead. Flower, statice.

URANUS.—Number 10. Letter I, J, Y. Color, dazzling white. Tone, astral chimes. Metal, uranium. Flower, clover and oxalis.

NEPTUNE.—Number 11. Letter C, K. Color, changing iridescence. Tone, music of the spheres. Element, neptunium. Flower, arctotis.

PLUTO.—Number 22 or 0. Letter T. Color, ultra-violet and infra-red. Tone, spirit choir. Element, plutonium. Flower, pitcher plant.

What is even of greater importance than to know that association with a particular thing will tend to attract events relative to a certain department of life, as signified by the house position of the sign or planet ruling the thing, is to know whether, and in what way, events so attracted will be fortunate or unfortunate.

This, as I have pointed out, depends upon whether the stellar cells to which the new supply of energy is added through such association, are harmonious or discordant in their activity.

It is quite correct to say that stellar cells or stellar structures in the astral body mapped by planets receiving discordant aspects are discordant in their activity, and that those mapped by planets receiving harmonious aspects are harmonious and tend to attract fortunate events. But in leaving the matter thus we are all too apt to overlook why the thought-cells of one person attract fortunate events and the thought-cells of another attract unfortunate events when brought in contact with the same associations.

The dynamic stellar structures mapped in the astral body by the planets in the birth-chart are composed of stellar cells which are definite thought-compounds, the thought-elements of which have been united under conditions that give them a harmonious or discordant quality, or feeling. Both the intensity and the kind of feeling which is present at the time two thoughts or impulses are brought together influence the manner in which the thought-elements unite in a compound.

It is not due to the aspects of the planets that the thought-cells in the astral body act harmoniously or discordantly, but due to the circumstances with which the thought-elements embraced within them were brought together. The strongest combinations of thoughts within the astral body, the chief ingredient in one region being mapped by one planet and the chief ingredient in another region being mapped by another planet, are connected by a line, or aerial, through the astral body. It is this line, which indicates how the thoughts at each end have united and formed compounds with a less volume of the thoughts at the other end, which is mapped by an aspect in the birth-chart.

The aspect is there because the thoughts at each end are in such relation to each other as the aspect indicates. But as these stellar cells and dynamic stellar structures so mapped are thought-formed, they may also be thought-changed. And when so altered by an intelligent application of the same principles under which they originally were formed, their activities stimulated by new energy from objects, thoughts, or planets will be according to this new relation, and not according to the aspect mapped in the birth-chart. The birth-chart aspect only maps their composition at birth, and not such as is later acquired.

An indication of the circumstances under which each of the ten types of thought-compounds is formed, therefore, is valuable both in determining what type of harmony or discord will be attracted into the life through association with a particular object, and in setting about to change the trend of fortune in any department of life mapped by a house of the birth-chart, the stellar cells of which are shown by planetary aspects to be discordant.

CONJUNCTION.—This aspect indicates that the thought-elements ruled by the planets so joined have had a long and close association, and that the persistent thinking or feeling along the lines indicated has given great volume and energy to the thought-compound there located. In this repeated association of mental factors there has been no intense pleasure or intense pain. Such harmony or discord as is indicated belongs to the essential qualities of the thought-families so united rather than to the circumstances of their union. A dynamic stellar structure mapped by such an aspect, because of the volume of energy it contains, tends to bring the things ruled by both planets into prominence. Hence it is called a PROMINENCE compound.

SEMI-SEXTILE .—When thought-elements of any two families are united by a steady feeling of mild pleasure they form a compound such as is mapped by the semi-sextile. Such a union of thought-elements in a dynamic stellar structure tends to attract conditions offering many small advantages for further growth. It is, therefore, called a GROWTH compound.

SEXTILE.—The things thought about, as indicated by one planet, when brought into association with the things thought about as indicated by another planet, under conditions which uniformly give rise to a feeling of pleasure, unite in a thought-compound such as is mapped by a sextile aspect. A dynamic stellar structure formed of such harmoniously blended thought-elements tends to attract opportunities. Hence it is termed an OPPORTUNITY compound.

SQUARE.—This aspect indicates that two types of desires have been present at the same time which were incompatible one with the other. As a result of the obstacles each desire placed in the way of realizing the other, violent discord was experienced. And because the dynamic stellar structure so built tends to attract additional obstacles, it is called an OBSTACLE compound.

TRINE.—Things thought about in mutual association with prolonged and enthusiastic pleasure bring a union of corresponding thought-elements into the most harmonious of all types of stellar cells. A dynamic stellar structure composed of such cells, because it tends to attract what is commonly called luck, is known as a LUCK compound.

INCONJUNCT.—When endeavors, or objects, are brought together in the mind in association with ideas of development, but with no pronounced feeling of pleasure or annoyance, they unite in a compound which is neither markedly harmonious nor discordant. A dynamic stellar structure composed of thought-cells so formed tends to attract expansive conditions into the life, and thus is known as an EXPANSION compound.

SEMI-SQUARE.—Irritations, the smaller abrasions of life, and the numerous little anxieties, when they bring together and unite the thoughts about definite types of activities, enter into a compound which is chronically discordant and annoying. A dynamic stellar structure formed in this manner tends persistently to attract friction with others and irritating circumstances, and is called a FRICTION compound.

OPPOSITION.—When the desires pull simultaneously in opposite directions, causing a decided feeling of distress because if one course of action is followed another desired course of action must be relinquished, a most energetic compound is formed of the thought-elements so united. Because the dynamic stellar structure formed in this manner tends to force asunder those things in the life which are associated with it, it is called a SEPARATION compound.

SESQUI-SQUARE. —Thoughts about things which at one time were pleasureable but later became painful, the reaction being accompanied by a high degree of distaste, tend to enter into a thought union which is disruptive, and which operates to break up, at intervals, the previously existing condition. A dynamic stellar structure thus formed, because agitation is the common mental state when the break-up is either contemplated or takes place, is called an AGITATION compound.

PARALLEL.—This aspect indicates that the thought-elements ruled by the planets have had a long association of rather indefinite quality in which neither pleasure nor pain was pronounced, but of sufficient volume to build, although in a somewhat loose manner, quite a powerful stellar structure. The dynamic stellar structure so formed, because it gives intensity to the power of attracting the things ruled by the two planets, is known as an INTENSITY compound.

GRAND TRINE.—When three planets are located in a chart so as to form a complete equilateral triangle, each planet being within orb of a trine to both the others, it is called a Grand Trine. Our research department has conducted a statistical analysis of such Grand Trines in connection with those who have made money, attained honor and attracted other types of success. Because thoughts from three distinct departments of life are harmoniously associated, as indicated by the analyses mentioned the Grand Trine proves to be the most fortunate configuration that can occur. And in so far as the person can live his life in association with the things so indicated will he attract unusual good fortune.

GRAND SQUARE.—When four planets in a chart are so located that they form a complete cross, all four arms of which are occupied by a planet, each planet being within orb of a square aspect to its neighbors, and in opposition to the one across the zodiac, it is called a Grand Square. Our research department, through statistical analysis, has found such a Grand Square to be the most unfortunate configuration that can occur in a chart. In the thousands of birth-charts with progressed aspects of people suffering from the 160 different diseases considered in Course XVI, we found that when there was a Grand Square in the chart the disease almost invariably was indicated by the planets involved in it.

Already, in preceding lessons, it has been shown that the abilities, temperament, disposition, business qualifications and attraction for money which any individual possesses, and which are mapped in the birth-chart, are due to the thought-cells which have been built by experiences of parallel significance into his astral body. And now that we also know the manner in which thoughts about different things unite to form definite compounds which build up with the stellar cells so formed the dynamic stellar structures mapped by the planets, we are in a position to extend the principle involved to all other departments of life, including friends, enemies, studies, travels and associations.

Instead of considering astrology as the writing of the hand of inevitable fate, if this grand science is used according to its true function, as the Golden Key to unlock the cause of conditions and reveal the processes of nature, it becomes a great boon to mankind. And thus applied in natal astrology, it indicates why—through the thought organization of the astral body, and the receiving of new energy by the stellar cells in a given compartment of the astral body at a specified time—a life has qualities, attracts the conditions, and on given dates undergoes the fortune or misfortune it does.

And in addition, because all are due to the thought-composition of the finer form, it shows just how to go about it, through altering the thought-composition of the astral body and supplying additional energy to the more fortunate thought groups, to make the life and fortune more as desired. When intelligently and persistently applied, as proved by the letters we receive from students who do this very thing, these methods bring the desired results.

Friends.

—Because the stellar cells in the compartment of the astral body mapped by the 11th house of the birth-chart have been acquired through thoughts and impressions relating to friendship, both the kind of friends attracted, and the type of influence they have in the life, are to be judged from this house.

As the most active thought-cells within the astral body are those mapped by the planets, and as each planet maps thought-cells which belong to a certain family as they have entered into the composition of a dynamic stellar structure, the location of a planet in a house of the birth-chart indicates the type of conditions attracted to this department of life.

If Neptune is in the 11th house, as in the charts of Wm. Jennings Bryan, Sir Arthur Conan Doyle and David Belasco, it signifies that the most influential friends in the life will be idealists, psychics and mediums, or people of dramatic talent; because the stellar cells in the friendship compartment of these notables' lives have been built chiefly of the thought-elements of the same family to which the people so attracted belong.

In the birth-chart of Professor Nicholas Murray Butler, with the Moon in the 11th, the stellar cells in this compartment of his life have had their origin in contacts with the widest variety of people. Consequently he attracts to him, as friends, those from all walks of life. But Professor A. Vander Nailen, also with honor in college work, has Mars and Uranus in the house of friends. He, therefore, attracted to him occult students and engineers, eccentric characters and soldiers, because the stellar cells that had been built into this compartment of his astral body were of the same thought-family as these people.

When the 11th house of the birth-chart is unoccupied by a planet, because the more active thought-cells are elsewhere located in the astral body, the influence of close friends, either for fortune or misfortune, is much less than when one or more planets are so located. Such a chart, for instance, is that of David Lloyd George.

Such influence as friends do have, however, must be determined, not merely by the planets in the 11th, or by the ruler of the cusp of the 11th, but by also taking into consideration the aspects of these planets. Henry Ford, with Jupiter well aspected in the 11th, benefitted greatly by influential friends. He was a close friend of John Burroughs, the writer, as indicated by the sextile of Jupiter to a planet in the 9th, was a close friend of Harvey Firestone and George Eastman, manufacturers, as indicated by the sextile of Jupiter to Mars, and was a close friend of Thomas A. Edison, the inventor, as revealed by Jupiter trine Uranus.

But that fine old gentleman, A. Vander Nailen, with Mars conjunction Uranus in the 11th, suffered persecution from his former friends when he departed from materialism and embraced occult doctrines. And the occult friends and their influence in his life estranged him from his children, as indicated by Mars and Uranus opposition Saturn in the 5th, and they were a severe affliction to him personally, as indicated by the square of Mars and Uranus to the Sun in his 1st.

Hopes.

—Not only the impulses and thoughts relating to physical friends, but also to those mental friends and almost constant companions which we call hopes, are embraced within the compartment of the astral body mapped by the 11th house. Not merely the kind of friends, therefore, but the kind of hopes, are indicated by any planet in the 11th, and to a less degree by the planet ruling the cusp of the 11th.

The two great hopes of Abraham Lincoln were to win the war, as indicated by Mars in the 11th trine Sun and square Mars, and eventually to free the slaves, as indicated by the freedom planet, Uranus, in the 11th, trine Mercury. And, although at great cost, for Mars gains its ends only through strife, the trines of these planets enabled him to realize these hopes.

Sir Arthur Conan Doyle, as indicated by Neptune in the 11th, hoped to convert the world to spiritualism. He toured the globe in the endeavor, and wrote copiously, these activities being indicated by the Moon in the 9th, sextile Neptune. His influence in this direction was probably greater than that of any other man; but, as indicated by Neptune square Jupiter in the 1st, the obstacles encountered were terrific, and his hopes were only partially realized.

Wm. Jennings Bryan hoped for a new ratio between gold and silver in coinage, as indicated by Mercury in the 11th, square Jupiter in the house of money. This he did not get. He hoped for many socialistic reforms, as indicated by Neptune in the 11th, and hoped to become President of the United States, as indicated by the Sun in the 11th. He was able to exert a powerful influence, but he never became President; and his hope of success as Secretary of State, to which office he had been appointed, was blighted, as indicated by Neptune and the Sun in the 11th square Mars in the house of war. His conscientious objections were such an obstacle that when the U. S. entered the war he resigned this one important position which he held.

Disappointments.

—The thoughts, feelings and emotions relating to sorrows, restrictions and disappointments are built into the stellar structure mapped by the 12th house. An individual may realize important hopes in one direction and have equally keen disappointments relating to other things.

Mr. Bryan had three planets in his 12th house. His disappointments were no less outstanding than his realizations. His sorrow when the U. S. entered the World War knew no bounds; for Pluto, the planet of universal welfare, in the 12th was for peace at any price.

Abraham Lincoln's early love for Ann Rutledge, instead of resulting in marriage—Mercury square planets in the 12th—was defeated by her death— Mars ruler of 5th, square Moon, ruler of the 8th. Saturn and Neptune in the 12th made of him a man of many sorrows.

People with many planets in the 12th may attain as great success as those with no planets in this house; but because the thought-cells relating to disappointments are so energetic they attract to themselves many sorrows. Quite frequently these disappointments are due to their own attitude or actions; although others may be the result of the actions of secret enemies, or due to circumstances of which they have no knowledge.

These actions which bring disappointments may be due to inability to appreciate the effect of a certain course of conduct, or it may be due to premeditated conduct in spite of recognized consequences. Wm. J. Bryan was quite aware that his radical views would bring him difficulties (Uranus in 12th, conjunction Asc.), and he resigned as Secretary of State as a conscientious objector to war.

Arthur Conan Doyle well realized that he would be persecuted for espousing spiritualism, but the ruler of his Asc. was in the 12th, conjunction the universal welfare planet, Pluto; therefore, he went ahead with what he considered his duty, in spite of its effect upon him personally or upon his reputation (ruler of 10th in 12th).

Studies, Writing, Publishing, Brethren.

—The thoughts, impulses and feelings relative to physical brethren and to those mental brethren which are the studies are chiefly retained in the thought compounds of the compartment of the astral body mapped by the third house.

In general, therefore, the type of brothers and sisters an individual has, and more particularly the amount of fortune or misfortune of their influence in the life, may be determined by the planets and their aspects relating to the 3rd house. Furthermore, at those times when their influence will be marked in the life there will be found a temporary stellar aerial leading to this compartment as mapped by a major progressed aspect within one degree of perfect to the ruler of the 3rd house. For instance, the reference book, *WHEN AND WHAT EVENTS WILL HAPPEN*,* shows by detailed analysis that when brother or sister dies there is always a major progressed aspect within one degree of perfect both to the ruler of the 3rd and to the ruler of the 8th.

The private studies and the writing that results from them are also to be judged from the 3rd house. Thus Saturn here gives depth of thought; although the mind unfolds more slowly. Mars in the 3rd tends to an early and energetic development of the mind. Uranus gives originality in thought and studies, and Neptune supplies imagination. A number of planets in the 3rd house increases the tendency to study. But of even greater importance in conferring ability to study, write and travel are the prominence and aspects of the three planets, Mercury, Uranus and the Moon.

Discordant aspects to the ruler of the 3rd, or to the three mental planets mentioned, do not impair the power of thought; but they attract unfortunate events according to the inharmony shown.

The public expression of the thoughts, through teaching, lecturing, advertising or the medium of printed books or periodicals is related to the stellar cells contained within the compartment of the astral body mapped by the 9th house. Conan Doyle, for instance, had the Moon in the 9th, indicating that to the extent they were received his writing would have a universal appeal. The Moon makes some aspect to each of the six planets in his 12th house, the house of crime, mystery and detectives. His fame rests upon his Sherlock Holmes detective stories. Mercury, Uranus and the Moon all are prominent.

A. Vander Nailen had no planets in his 9th, but the ruler of the cusp of the 9th is Jupiter. Jupiter is the religious planet, is in conjunction with Neptune, the mystical planet, and both are trine the writing planet, Mercury, in the 1st. His contributions to science were overlooked; but his mystical-religious novels are still widely read. Mercury, Moon and Uranus are all prominent.

Religion.

—The type of religion an individual embraces must be determined from the chart as a whole, as the prominence of the upper-octave planets indicates a progressive trend. But the influence on the life of the public expression of whatever religious, philosophical, or other beliefs are held may be determined from the 9th house.

If Mars is there the publicly expressed beliefs will bring strife, if Uranus is there the individual will be considered eccentric, if Neptune is there people will think him visionary in his doctrines. Conan Doyle's detective novels brought the acclaim of his Moon trine Sun and Uranus; but his deeper thoughts, as indicated by Saturn in the 3rd, in opposition to the Moon, when expressed, brought him opposition, and the obstacles indicated by the Moon square Mercury and Pluto in the 12th.

Secret Enemies and the Influence of Astrals.

— The more active, as shown by planets in the 12th, the stellar cells are which compose the compartment of the astral body relating to enemies, the more secret enemies will be able to influence the life. But their power to damage must be gauged by the nature of the planets in the 12th and their aspects.

Conan Doyle's chart, because so many planets are in the 12th, attracted many secret enemies. They were of all six types indicated by the six planets there. And as the 12th also indicates the compartment of the finer body where contact is made with astral entities, his contact with the invisible world was wide and varied, and not confined to well-disposed humans who had passed from earth life. But the power of either physical or astral enemies to injure him was limited by the splendid aspects, Venus sextile Jupiter, and Sun trine Moon.

Lloyd George had secret enemies of three types, as shown by three planets in his 12th. But Mercury there, trine Uranus, enabled him more frequently to defeat them.

George Bernard Shaw also has three chief types of secret enemies, as indicated by three planets in the 12th. And to a less degree than Doyle, both he and Lloyd George have ability to get to the bottom of things; for the 12th not only has to do with secret enemies, hospitals, places of detention and underhanded plots, but also relates to crime detection. Shaw, similar to Doyle and Bryan, has both the expose planet, Uranus, and the universal welfare planet, Pluto, in the 12th. He dotes on turning up and exposing the methods employed by the wealthy in exploiting the downtrodden.

Open Enemies.

—The thoughts, feelings and mental attitudes toward those who are met publicly are retained in the compartment of the astral body mapped by the 7th house. Therefore, because these determine the conditions surrounding open contact with others, not only the public enemies, but the general reception from the public, and the circumstances surrounding contacts with the public, are to be judged from the 7th house.

The writer of these lessons has Jupiter in the 7th, and aside from writing has for many years appeared before the public in person as a lecturer on THE RELIGION OF THE STARS, and as a naturalist, having been associated with clubs devoted to nature study also for a long time, just now being president of The Nature Club of Southern California. The only public enemies he has ever made, in so far as he is aware, have been due to his religious views.

Jupiter is the ruler of the 7th in Conan Doyle's chart, and is conjunction with Mars in the 12th and square Neptune in the 11th. His open enemies, as well as those more secret, were also due to his religious opinions.

Lloyd George, with Saturn in the 7th, contacted his public in the serious statesmanship of handling practical affairs. He has had powerful public enemies among the conservatives indicated by Saturn, and also among the socialists, as indicated by Neptune in opposition to Saturn. As this is written the socialistic opposition thus shown, headed by Ramsey MacDonald, has forced him into comparative obscurity. But during the World War, Saturn in the house of war, trine Venus and Mercury, enabled him as head of the British Government, to bring about the defeat of her opponents.

Wm. Jennings Bryan, with Mars in the 7th, had open enemies of a different kind. His peace-at-any-price caused army men to hate him, and his violent assaults on intoxicants, also ruled by Mars, made the liquor interests furious. War caused him to resign the most important office he ever held, and he was constantly fighting for the under dog. It was this willingness to fight for the interests of the common people, as indicated by Mars in the 7th, sextile Moon in the 10th, that not only won him public enemies, but which gave him the great popularity that he deservedly possessed.

Journeys.

—The experiences with long journeys, and the thoughts and feelings so engendered, are retained in the stellar cells of the compartment mapped by the 9th house; and those derived from short journeys are a part of the composition of the stellar structure mapped by the compartment of the astral body mapped by the 3rd house.

The more activity these stellar cells, and the stellar structures they form, possess the more strongly are journeys attracted into the life. But, as accentuating this influence, the three travel planets, Mercury, Moon and Uranus also must be considered. Their stellar structures, to the extent these planets are prominent and have powerful aspects, tend toward not merely mental activity, but also toward change and travel.

But the circumstances surrounding the journeys are to be judged from the 9th house for long journeys and from the 3rd house for short journeys. In compiling the information on journeys in the reference book, WHEN AND WHAT EVENTS WILL HAPPEN,* in which 100 long journeys and 100 short journeys are analyzed, it was evident that progressed aspects to the travel planets made travel more certain, but that people do not take journeys under progressed aspects to these or other planets unless at the same time, in the case of long journeys there is a progressed aspect to the ruler of the 9th, and in the case of a short journey there is a progressed aspect to the ruler of the 3rd.

What fortune or misfortune accompanies such journeys, and the general nature of them, must also be judged from the planet ruling the house in the birth-chart. If Mars is in the 3rd, short journeys will be accompanied by strife or danger. If Uranus is chief ruler of the 3rd, short journeys will be taken abruptly and with little preparation. If Saturn is chief ruler of the 9th, long journeys will be tiresome and laborious. If Neptune is in the 9th, sea journeys are indicated, or at least the long journeys will have a romantic setting.

*Out of print, see Church of Light Research Cyclopeda

Chapter 7

Serial No. 109
Original Copyright 1934
Elbert Benjamine

Copyright
Church of Light
August 2002

Love, Marriage, and Partnership

Chapter 7

Love, Marriage and Partnership

MARRIAGE is a complex relationship involving somewhat every department of life. Even friendship, the financial success, honor and the attitude of relatives are influenced by marriage; and especially does it include as its outstanding factors, a close partnership, association with the opposite sex, affection, and the love embrace.

The thoughts, feelings and impulses of the soul before human birth, derived from its experience with each of these distinctive departments of life are not retained in a single compartment of the astral body. Instead, they originally were built into, and now reside in, the particular compartment of the astral body mapped by the house or dynamic stellar structure corresponding to the department of their origin.

If the one important thing about marriage, for instance, were the amount of financial success it would bring, the partnership house and the houses of money, especially the 8th, which is the house of the partner's money, would be the chief things to consider in a birth chart.

Marriage to certain other persons is measured as to its desirability almost exclusively by the love embrace. That there is little kindness shown, and much strife and bickering at other times, seems of no importance. With such a yard-stick marriage must be measured almost exclusively by the 5th house.

The Four Factors of Success in Marriage.

—Because what people expect and desire from marriage are so diverse, it is impossible to give the factors in the order of sequence of their importance to all. The sequence must be changed to meet special needs. Possibly the following order of importance applies to the average person:

1. PARTNERSHIP.—The stellar cells and stellar structures mapped by the 7th house, their harmony or discord and the intensity of their activity, as well as the general quality, determine the kind of partners in general that are attracted into the life. If Saturn is in the 7th, all partners will tend to be serious and cold; if Jupiter is there they will tend to be jovial and benevolent; if the Sun occupies this house they will tend to dignity and importance. Thus from the planet in the 7th, or less precisely from the ruler of the cusp of the 7th, can be gauged the general type of partner which the individual will have.

How the partner thus indicated will affect the life must be determined by the aspects formed by the ruler of the 7th. These indicate not only the thought-compound of which the stellar cells in the compartment of the astral body relating to partnerships are formed, but also open lines of energy exchange, of definite harmony or discord, with other compartments in the astral body. Because the thought-cells of the partnership compartment are connected, for instance, with the thought-cells of the money compartment, by a stellar aerial mapped by an aspect from the 7th house to the 2nd house, money will be an important factor as influencing the success of the partnership. The partnership, likewise, because of this free communication of energy between these compartments, will have an important bearing upon the financial success.

The more prominent the planet, and the more powerful its aspect to the ruler of the 7th, the more influence the things relating to its compartment in the astral body will have over the partnership. Such influences are mutual. But the compartment having the stronger influence over the other is the one with the most active stellar cells, that is, mapped by the most prominent planet.

Consequently, if there is a planet in the 7th made prominent by having several powerful aspects, and the planet ruling the 2nd is not prominent, an aspect between the two indicates that the partnership will have more influence upon money than money will have upon the partnership. But if the planet ruling the 2nd is more prominent than the planet ruling the 7th, money will have more influence upon the partnership than the partnership will have upon money.

This, if course, is a principle which can be applied to the aspects of planets between any two houses. The activity of the stellar cells mapped by a planet determines the amount of their influence, both in relation to the life, and in relation to the amount of influence exerted by any other group of stellar cells mapped by another planet to which there is an aspect. It is the thought-energy possessed and exerted which, in all cases determines the amount and kind of influence mapped by any position in the birth chart or by any progressed aspect.

The nature of the influence exerted by one department of life over another department, as indicated by the aspect between two planets, must be gauged by the nature of the aspect. If, for instance, there is a trine aspect between the ruler of the 7th and the ruler of the 2nd, partnership will tend to bring good luck in money matters and money matters will tend to bring good luck in partnership. But if the aspect is a square, the partnership will be an obstacle to financial success and financial difficulties will be an obstacle to the success of partnership.

In judging the influence of any department of life, every aspect to the ruling planet should be taken into consideration, not merely as a harmony or discord, but as indicating a definite kind of condition which arises from the department of life which the other planet rules. It should be considered as an opportunity, an obstacle, friction, luck, agitation, etc., arising from the department indicated by the house position and rulership of the planet making the aspect, which tends to influence the department of life being considered in this definite way.

Thus must the partnership be judged to influence, and be influenced by, every planet making an aspect to the ruler of the 7th.

As a rule either Uranus or Neptune, in so far as they are involved in it, tend to disrupt marriage and bring separation. In the 7th house there are instances when exceptionally well aspected in which they bring the finest type of marriage relations. But even in such cases the circumstance of the union are decidedly unusual. The cusp of the 7th merely being occupied by Aquarius or Pisces, however, is not so drastic. Upton Sinclair, for instance, with Aquarius on the cusp of the 7th, but with the other three marriage factors harmonious, has had an exceptionally fortunate marriage in all ways.

But an afflicted Uranus in the 7th is another matter, as illustrated by the chart of Jean Harlow, here presented. Mars conjunction Uranus in the 7th, and both heavily otherwise afflicted has brought tragedy and disruption to her marital relations.

Any aspect of the Sun in a woman's chart or of the Moon in a man's chart to the planet Uranus tends toward unconventional conduct. It is the freedom planet, and its individualism expresses thus in relation to the opposite sex. Any aspect of the Sun in a woman's chart or of the Moon in a man's chart to Neptune tends to a peculiar unrealizable idealism regarding the opposite sex. Neptune in the 7th is not suddenly disruptive, as is Uranus, but the partner is given imaginary qualities which the realities of life do not permit of fulfillment. The partner may be strangely afflicted, the one desired may already be married, a queer slow process of estrangement may occur, or some involved condition develop which leads to an unsatisfactory married experience.

2. OPPOSITE SEX.—Aside from partnerships and the affections the opposite sex has an influence upon each life.

To an extent undreamed of by most, a woman's health depends upon the astral and electromagnetic forces radiated by her brothers, her father, her husband and all the men she even remotely comes near.

The kind of energy she thus receives from men, as well as the influence of men in general upon her life, is determined by the stellar cells mapped by the Sun in her birth chart. If the Sun is well aspected she will attract to herself, because the thought-cells relating to the opposite sex are harmonious, favors and fortune from men. But if the Sun is afflicted, it indicates that the thought-cells relating to the opposite sex are inharmoniously compounded, and she will attract misfortune from men accordingly.

Man, in no less degree, depends for health and inspiration upon the astral and electromagnetic forces radiated by his sisters, his mother, his wife and all the women he approaches even closely enough for conversation or a handshake.

The kind of energy he thus receives from women, as well as the influence of women in general upon his life, is determined by the manner in which the stellar cells within his astral body mapped in the birth chart by the Moon are compounded. If the Moon is afflicted by aspect, women in general prove a detriment such as the aspect indicates. But if the Moon receives good aspects it reveals that the thought-compounds built of his experiences with the opposite sex are harmonious, and that women will favor and assist him.

Man depends largely upon woman for magnetic power and woman depends largely upon man for vital strength. Even as the thoughts of an individual tune his astral and electromagnetic energies to their vibratory rate, so also the sex of an individual gives a distinctive quality both to his astral energies and to his electromagnetic energies. Aside, that is, from being vital electromagnetic energy or constitutional electromagnetic energy, the electromagnetic energies are either strongly or weakly sexed, according to the individual, and are either masculine or feminine according to the gender.

Those who have no contact by speech or handshake with the opposite sex become one-sided creatures. Thus does monastic life become an open avenue for all manner of fantastic beliefs and obsessions. Such isolation from the balancing magnetic contacts are always indicated in the birth chart by an unusually severe affliction.

3. AFFECTIONS.—The strength, importance and success of the affections in general, without reference specifically to the marriage partner, children, relatives, or friends is to be judged from the planet Venus. The affections are important in the life and powerful to the extent that the planet Venus is prominent. Their general satisfaction, or lack of it, is indicated by the aspects Venus receives. And these aspects, by the house positions of the planets making them and the house position of Venus, indicate what things conduce to, or detract from, affectional success, and in what manner.

4. LOVE AFFAIRS.—Love affairs, which include those that result in marriage and those that do not, and the circumstances relating to them, including the embrace of marriage, are to be judged from the 5th house.

Venus may well play an important part in lovemaking, but some love-making has very little of the Venus quality of affection in it. The individual who has Venus prominent in his chart will desire Venus expression; but in actual love-making, and in the success of it, the thought-cells mapped by the 5th house play the determining role.

If Mars is in the 5th, love-making will attract strife; if Saturn is there, a quality of coolness will develop; or if the Moon is in this house of passion, lack of constancy will play a part. How these influences will affect the life, of course, must be determined by the aspects of the ruler of the 5th and the houses occupied by the planets aspecting it.

The thoughts, feelings, impulses and emotions relating to the love embrace and to other pleasures have been built into the compartment of the individual's astral body mapped by the 5th house. What will be attracted to him relating to pleasures and the love embrace, therefore, must be judged from the 5th house. And to the extent this relation is a factor of importance in marriage the 5th house conduces to or detracts from the marital happiness.

Opportunities to Marry

—As a general rule the aspects to which the Moon applies in a man's chart, and the aspects to which the Sun applies in a woman's chart, represent the opportunities to marry. The first complete aspect the significator thus makes is the first opportunity, the second complete aspect is the second opportunity, and so on.

A composite picture of partners in general may be had by reversing the chart and judging it as if the 7th were the partner's first. But in selecting from among various opportunities to acquire a husband or wife, the particular woman is indicated by the aspect to which the Moon applies, and the particular man is indicated by the aspect to which the Sun applies.

In a man's chart, if the first aspect made by the Moon were to Uranus in the 10th, this would indicate a woman who was eccentric or interested in some unusual pursuit, and in some manner associated with business. If the second aspect were to Saturn in the sixth, this would indicate a later acquaintance of more serious and laborious turn, who, in some manner was related to illness, or was a servant or inferior.

In a woman's chart, if the first aspect made by the Sun were to Neptune in the 11th, the man so indicated would be visionary, a promoter, and his relation to friends would be noticeable. If the second aspect completed by the Sun were to Jupiter in the 4th, the man so designated would be jovial, probably possessing wealth, and interested in real estate or the hotel business.

Usually every planet to which the significator of the opposite sex completes an aspect before leaving the sign indicates a possible opportunity to marry. If the chart otherwise is pronouncedly a marrying chart there may be opportunities beyond those thus shown. If the chart is not strong for marriage, the weaker aspects thus indicated will bring only friendships that will not develop far enough to imply marriage. Gemini or Sagittarius on the 7th rather frequently gives a second marriage.

The value of being able thus to determine the individual who is indicated by any planet to which the significator of the opposite sex applies lies in revealing the fortune which the life would have in association with each prospect so designated. If the planet thus applied to were much afflicted, the individual also would be similarly afflicted. But if the planet indicating the particular marriage opportunity were powerful and well aspected, the partner would be likewise fortunate.

If the application made is by good aspect, it signifies that the relation between husband and wife would be harmonious, to the extent there might be harmony with any partner. But if the application made is by adverse aspect, it signifies that the relation between husband and wife will tend to be discordant, according to the nature of the aspect.

Therefore, if the Sun in a woman's chart, or the Moon in a man's chart, applies favorably to the first planet with which an aspect is completed, and by adverse aspect to the second planet, the first opportunity to marry is the better. But if the first application is to an adverse aspect, or even to a planet much afflicted, and the second, or third aspect is a harmonious aspect to a more favorable planet, it is better to ignore the early opportunity and wait for the later one. The planets to which Sun or Moon thus applies, by their characteristics and the house occupied, give hints sufficiently clear to enable each individual so indicated to be recognized.

Whom to Marry

—Many factors conduce to, or detract from, the suitability of two persons to wed, but in particular there should be magnetic harmony, kindred intellectual interests, and not too divergent spiritual ideals.

1. PHYSICAL HARMONY.—Between people so closely associated as man and wife there is an exchange of electromagnetic energies. The etheric body is a union of energies of opposite polarities; solar electromagnetic energy and lunar electromagnetic energy. This electromagnetic energy, generated by the chemical processes of the body, is really the life of the physical form.

The nerve currents are such energies traveling over the nerves. And their vibratory rates, aside from those given temporarily by the transient thoughts and feelings, are determined by the thought-cells of the astral body as mapped by the planets.

The positive electromagnetic energy is ruled by the Sun. Its quality, therefore, is largely determined by the Sun-sign; but to a degree also by any planet aspecting the Sun; for such a planet reaches the etheric body through the dynamic stellar structure mapped by the Sun, into which its aerial leads.

The negative electromagnetic energy is ruled by the Moon. Its quality is largely determined by the sign occupied by the Moon in the birth chart; and to a much less degree by any planet aspecting the Moon. Such an aspect implies an aerial leading into the dynamic stellar structure mapped by the Moon, through which it gains direct access to the etheric body.

Any planet aspecting Mercury, at times, through the thoughts it stimulates, reaches and influences the quality of the etheric body. The conscious thoughts, ruled by Mercury, tune the electromagnetic energies to their vibration. But this influence is pronounced only while the particular thoughts are prominent in the mind. It may, therefore, be considered not as the permanent rate to which the nerve currents vibrate, but merely as those tuned in on temporarily.

Aside from such temporary tuning in by means of the conscious thoughts, which may or may not be habitual, the quality of the electromagnetic energies of the body may be determined chiefly by the signs occupied by the Sun and Moon; carrying in minor degree the vibratory rate of the planets from which these luminaries receive aspects.

In reaching the outside world, however, the solar electromagnetic energies and the lunar electromagnetic energies, thus colored by planetary vibrations as indicated by their aspects, must pass over the ground-wire mapped by the degree on the Ascendant. Electromagnetic energy which thus passes over the ground-wire to the world without is known as personal magnetism.

This ground-wire itself has a vibratory quality which also is imparted to such electromagnetic energies as pass over it. Not only the sign on the Ascendant must thus be considered, but all planets in the first house also, because they are closely enough associated with the ground-wire to impart their vibratory rates to it.

The magnetism of an individual, therefore, is not a simple energy, but a compound of solar energy and lunar energy of the quality indicated by the signs occupied, and the aspects made, by Sun and Moon, to which still other vibratory rates are added by the sign on the Asc., planets in the first house, and planets strongly aspecting the degree on the Asc.

To the extent electromagnetic energies have a similar vibratory quality they the more readily fuse and blend. The magnetism of watery signs blends best with the magnetism of watery signs. It also blends in less degree with the magnetism of earthly signs; but will no more blend with the magnetism of fiery signs than oil will blend with water. Magnetism of the fiery signs blends most readily with that of fiery signs. It blends somewhat with that of the airy signs; but refuses to unite with the magnetism of the earthly signs.

If the Sun in one chart is in a fiery sign and the Moon or Ascendant of another chart is in a fiery sign, the magnetisms, to the extent shown, are given a fiery vibration, and to that extent will fuse pleasantly. That is, for magnetic harmony, it is not absolutely essential that the Sun-signs shall be of the same triplicity, or even of complementary triplicity, although the energies blend more completely when they are. Electromagnetic energy of the same, or of complementary quality, will blend whether given its quality by the Sun, Moon or Ascendant. But the blend is more perfect if in both cases it is given by the Sun, in both cases by the Moon, or in both cases by the Ascendant.

The electromagnetic energies of an individual are subject to being somewhat raised or lowered through the mental attitude, or sympathy for another. After all, the vibratory rate they possess as mapped by the signs and planets in the birth chart, is due to the vibratory quality of the thought-cells in the astral body. That is, the solar electromagnetic energy has a quality determined by the thought-cells of the dynamic stellar structure mapped by the Sun. If the Sun receives a strong aspect from Uranus, it indicates that the thought-cells mapped by the Sun have in their composition also some of the Uranian thought-element. And this, to an extent modifies their vibratory quality, because in addition to the vibrations of the Sun-sign, they partake of these Uranian thought-element vibrations.

The vibrations of the electromagnetic energy which when it is radiated to others is termed personal magnetism is quite complex; for in addition to other qualities they partake of the sex of the individual. Electromagnetic energies of similar vibratory rate fuse readily, and without jar or discomfort, and if at the same time they are of opposite sex, and to the extent they are strongly sexed, there is pronounced attraction of the one for the other.

But even when of the opposite sex, magnetisms which are of too dissimilar characteristics do not fuse or blend, and often are violently destructive, one to the other; the weakest suffering most. When the vibrations are thus so divergent, as indicated by signs which are contradictory opposites, such as Aries and Cancer, Capricorn and Gemini, or Taurus and Leo, they can not be brought into synchronism, and they jar from their impact.

When the divergence of vibratory rates is less antagonistic, having certain factors of similarity as indicated in the birth chart, under kindness and sympathy the feelings so engendered are able to raise or lower or otherwise adjust to each other so that they enter into a satisfactory fusion. Even when there is rather wide divergence in birth chart vibratory frequencies, the conditions of courtship may bring about the feeling of sympathy which adjusts the vibratory rates of the electromagnetic energies, one to the other.

Under such conditions, so long as the kindness lasts and hardships do not too greatly, through thoughts about them, cause a reversion to the natural birth chart vibrations, the magnetic blend will persist. But when, as often occurs after marriage, irritations arise, and financial worries absorb much of the attention, this artificial adjustment of electromagnetic vibratory rates is destroyed, and each has as the normal quality of personal magnetism only that which the thought-cells, as mapped in the birth chart, impart to it. That is, the quality imparted to it by love of the other departs as soon as the love no longer is a vigorous and persistent factor in the consciousness coloring the thoughts.

When this transpires, husband and wife whose magnetisms fused nicely during courtship and the honeymoon, find the blending no longer present, and each wonders why the magnetism of the other is so annoying.

If, however, the quality of the magnetism of each is quite similar to that of the other, due to the sign-vibrations of the thought-cells in the astral body mapped by Sun, Moon or Ascendant, their normal everyday electromagnetic energies fuse harmoniously without particular adjustment on their part. When irritations arise, their temporary tuning in on different rates, due to the thoughts and feelings at the time, may make it impossible for the electromagnetic energies to blend. But as soon as the difficulty is past and each has a normal mental attitude there is, without special effort on their part, a satisfactory blending of electromagnetic energies again.

In marriage, therefore, it is favorable when the electromagnetic energies have, as shown by Sun, Moon and Asc. in the birth chart, much in common, and not too much which is of the contradictory quality. For practical purposes, and without going into the fine points, the personal magnetism of individuals may be broadly classed into two polarities, electric and magnetic.

The positive signs, and the positive planets, give the electromagnetic energies of the body a positive, electric quality. The negative signs, and negative planets, give the electromagnetic energies of the body a negative magnetic quality. Electric personal magnetism blends well with electric personal magnetism, especially if the sexes of the persons are opposite. Magnetic personal magnetism blends nicely with magnetic personal magnetism. But electric personal magnetism will not blend with magnetic personal magnetism. They recoil from each other, and close association is injurious to both.

Very few people are exclusively electric, or exclusively magnetic in temperament. To the extent there are elements in common the magnetisms will readily fuse. When the electromagnetic vibratory rates are about equally divided between positive and negative the temperament is said to be electromagnetic. These people are able to blend with all other types somewhat, but not so thoroughly as do those more pronouncedly of the same temperament.

In referring to this matter of energy exchange, which is so important in the close and constant association implied by marriage, in addition to the general vibratory quality of the electromagnetic energy, or personal magnetism, it is found that when a planet in one chart occupies the same degree of the zodiac as a planet in the other chart there is a ready exchange of astral energies of the nature indicated by the planets involved.

Each planet maps the terminal of a stellar aerial, and if there is a dynamic structure acting as such a terminal in the same degree of the same zone in the astral body of each, this affords the facilities for astral energy exchange. The nature of the energy given to the other is shown by the planet and its aspect in the chart of the one who imparts it. Thus if Saturn in one chart is in the same degree as Mars in another chart, a close association of the two persons enables the Saturn energy to reach the Mars terminal. And to the extent Saturn is afflicted, it imparts to the Mars terminal inharmonious energy. And because Mars and Saturn are discordant, one to the other, even if not afflicted, the energy exchange is detrimental to both.

Venus and Mars, however, between those of opposite sex are natural lovers. Mars in one chart on Venus in the other, other things not interfering, often brings a strong and lasting attachment. The Sun in one chart on the Moon in the chart of a person of opposite sex also indicates an exchange of energy which is usually satisfactory and lasting. In this case, however, because Sun and Moon rule them, the exchange is of electromagnetic energies as well as those astral.

It is probably not good practice to consider such exchanges if the planets are much more than one degree apart in the zodiac.

As to the general influence on the various departments of life, of one person when closely associated with another, this can be determined, although subject to many modifications, by considering in which house of the chart of one the planets in the chart of the other fall. For instance, if one person has Virgo on the 10th, and the other person has Jupiter in Virgo, the influence of the second person on the first would be to increase the business. It is, only with a minor degree of force, as if Jupiter were placed in his own 10th house. If Jupiter in the second person's chart were well aspected it would be more favorable, of course, than if discordantly aspected.

By thus inserting the planets, according to the degree of the zodiac they occupy, from one person's chart into the chart of another, much can be learned of the manner in which any partnership will influence the life of each.

2. MENTAL HARMONY.—To be companionable, people must have at least some interests in common. If all the husband cares for is business and baseball games, and all the wife cares for is literature and social affairs, they are sure to bore each other, and probably will seek companionship with those of kindred tastes.

It is a mistake, as a rule to which there are numerous exceptions, for husband and wife to have abilities so closely identical that they become rivals. Too frequently, when this is the case, there is jealousy of the praise bestowed upon each other. It is better that each have qualities which the other has not, but which the other admires. Yet their tastes should be sufficiently alike that they have interests in common. The best possible mental combination is when husband and wife are vitally and enthusiastically absorbed in some interest to which each contributes an element which the other can not.

How to determine the things an individual will be interested in, and thus if two people will be mentally compatible, may be determined from the temperament, disposition and mental ability as set forth in lesson No. 105.

3. SPIRITUAL HARMONY.—People tend to be uncomfortable when closely associated with those whose characters are in marked contrast to their own. The character includes those deep-seated traits which most resist change. Rules for judging it are given in lesson No. 105.

The spiritual level, including the religious conceptions, the ideals, and the many individual trends and traits, all are embraced in character.

One who lives on a low spiritual level, likes riotous living, is keenly dishonest, and cares nothing for others or for the future life, is quickly irked by the companionship of a clean-living, honest and pious companion. A materialist husband is a source of incessant worry to a spiritual wife. One who cares only for the flesh pots is hardly a suitable mate for a fine-grained aesthete.

A divergent philosophy of life, because philosophy determines action, is a common source of discord between wedded people. If one is progressive, is interested in astrology and the occult, and the other is conservative enough to believe that such things are the work of the devil, it does not conduce to happiness. Many instances are brought to our notice, too, in which one of a married pair concludes that all expression of sex is sin, while the other believes such doctrines are contrary both to sound psychology and to physical health. Both then consider the other selfish in demanding a type of life of which the other does not approve. Had they the same ideals they would be spared such misery.

The Sun-sign, as mapping the most deep-seated and permanent of all the thought-elements comprised within the astral body, is a significant factor in determining spiritual harmony. Fire and water, of course, are wide apart in their spiritual relations as revealed by the motives of their conduct. And even the degree of the zodiac occupied by the Sun seems to be quite important in their respect.

John A. Hadallier, member of the California State Bar Association, after thirteen years' research published in the N. A. Journal for February, 1934, a graph showing the grouping of actual divorce cases in his files according to the degree occupied by the Sun.

This graph indicates that when the Sun in the birth charts of husband and wife are near the sextile and trine to each other there are the fewest number of divorces, but that when they are near the semi-square, square, sesqui-square and opposition divorces are most numerous. The square aspect brings the most divorces; those of the semi-square and sesqui-square are about half as many as indicated by the square; and the opposition aspect, probably due to the principle of polar opposites, exhibits only about half the divorces shown by the semi-square and sesqui-square.

When to Marry

—From merely a comparison of the birth charts of a man and a woman it cannot be determined whether or not they can make a success of marriage. All that can thus be ascertained is to what extent the fundamental harmonies are present between them which promote marital happiness.

In an afflicted chart, conditioning by environment since birth may have developed complexes or fixations that make it impossible for its owner to make a success of marriage with anyone. But statistical studies show that while an individual is under harmonious progressed aspects he is unlikely to be attracted toward marrying an individual with such a complex or fixation, or who is otherwise so constituted that he cannot get along successfully with anyone in marriage

In the reference book, *ASTROLOGY: 30 YEARS RESEARCH* the progressed aspects are analyzed for 215. different marriages. People may marry when the progressed Moon is in any house, or making any aspect, or making no aspect; but they only marry when there is a major progressed aspect, other than the Moon, within one degree of perfect, to the ruler of the 7th.

There is no planet of marriage; but when there is a progressed aspect to the ruler of the 7th, a progressed, aspect to Venus favors marriage. And in a woman s chart, when there is a progressed aspect to the ruler of the 7th, a progressed aspect to Mars tends even more strongly toward marriage than does a progressed aspect to Venus.

In the mentioned reference book, the birth charts' and progressed aspects of 100 persons, both at the time they married and at the time they separated or divorced, are also analyzed. At the time of marriage 79 of them had a discordant progressed aspect dominant, and only 3 of them had harmonious progressed aspects dominant.

A large percentage of these people who divorced, later remarried when their progressed aspects were harmonious, and made a success of the later marriage. Thus one of the most important steps in making a success of marriage is the selection of a time for the marriage when there are harmonious progressed aspects strong enough to act as Rallying Forces, and a harmonious progressed aspect to the ruler of the 7th. If, at the same time, Venus and the ruler of the opposite sex are unafflicted by progressed aspect, so much the better.

Progressed aspects from Sun, Moon or Venus to Uranus or Neptune tend to bring into the life romantic affairs. If Neptune is the dominant influence at the time they tend to fizzle; and if Uranus is the dominant influence at the time the attachment may be very strong while it lasts, but commonly lasts only so long as the progressed aspect to Uranus remains within one degree of perfect.

As to the actual day and time of marriage, it is well, as in starting any important enterprise, to select a proper time for it. The chart of the marriage, erected for the time the minister says, "I . . . now pronounce you husband and wife," should have, in addition to other favors, as good a 7th house as possible.

Children

—The relation of children to the individual, and their affect upon the life, is to be judged from the 5th house. Fruitful planets and a fruitful sign on the 5th are indications of children, but whether the Sun-sign, Moon-sign and Asc. are fruitful must also be considered.

The relation of the children to the individual, whether they will be a source of just pride or a cause of trouble, and the nature of the benefit or difficulty, is to be judged solely from the 5th house.

It is significant that pleasures and children are ruled by the same house. That is, the thought-cells relating to both are in the same compartment of the astral body. This means that children conceived in discord, such as indicated by an afflicted house of pleasure, are of a type which are themselves discordant. The LAW OF AFFINITY thus indicates that when there is love and harmony between husband and wife, that the soul attracted will have similar qualities of harmony, which will be evident in the child's birth chart.

Astrology should be used by all parents in bringing children into the world. Child bearing should not be a hit or miss affair. It should be premeditated. More details as to this will be found in lesson No. 167, but anyone can look ahead in the ephemeris 273 days and note if the positions of the planets will be favorable for a child then born. It is true that gestation may be somewhat shorter or longer than this period, but even so the Sun-sign and heavier aspects, which last over considerable time, can thus be known. And by applying the prenatal epoch, as explained in lesson No. 117, a chart can be selected in detail for the child, using the rules there given to work back to find the proper moment for conception.

If the parents can not attract a soul having such qualities there will be no conception. But if conception takes place the child will not be a burden to its parents and to society, but such as the selected chart indicates.

Home

—The home should be judged exclusively by the 4th house. Uranus in the 4th is a disturbing element. Jupiter there gives a rather sumptuous place and enjoyment in it. Venus lends itself, when in the 4th, to harmony and a place of comfort. The home, it should be understood, as thus ruled by the 4th, is not just a house, but the whole domestic environment, including people.

Servants

—Servants are to be judged from the 6th house. A benefic there indicates that those who work for one will give valuable service. Much of the late President Woodrow Wilson's success is attributed to the willing and capable services rendered him by those in his employ. He had Jupiter in his 6th.

Mars in the 6th gives quarrelsome servants, and difficulties with them. Neptune in the 6th gives servants who are dreamers and little inclined to work. Saturn indicates those laborious, and if well aspected that they work hard for their employer, but if afflicted that they have only their own advantage in view. Thus the type of individuals who will be attracted into the person's service is indicated by planets in the 6th, or the ruler of the cusp of the 6th; but the benefit or detriment they are to him must be judged by the aspects these planets receive.

Father and Mother

—Theoretically it would seem that the mother should be ruled by the 4th, as this is the natural house position of the mother sign, Cancer. With no theory to uphold, and not caring in the least as to results, we conducted an impartial analysis, based on the progressed aspects to the rulers of the 10th and 4th at the time of the father's death and at the time of the mother's death.

This analysis, set forth in the reference book, *ASTROLOGY: 30 YEARS RESEARCH*, based on the progressed aspects at the time of death of 100 fathers and 100 mothers, reveals that there is always a progressed aspect to the ruler of the 10th at the time of the death of the mother, but not at the time of the death of the father. Also that there is always a major progressed aspect to the ruler of the 4th at the time of the death of the father, but not at the time of the death of the mother.

These results have been verified since in still other ways. Therefore, in judging the influence of the mother in the life refer to the 10th. Its ruler will have some significance as to her qualities, but chiefly will indicate how she will affect the individual. The aspects will show the benefit or affliction to him from her.

From the 4th house is to be judged the influence of the father in the life. The ruler of the 4th will reveal the attitude of the father toward the individual, and the aspects will indicate whether or not, and how much, benefit will be derived from him.

Inheritance and the Dead

—The nature of the inheritance, if any, to be derived from those who die, gifts and bequests from others, and the personal property of the husband or wife, are to be judged from the 8th house.

This house indicates also the good-will, or otherwise, of those who have passed to the next plane as it affects the life. This is of more significance to those who through the seance room, or through voluntary communion, come in contact with people once of the earth but now living on the inner plane.

Collecting Debts

—This 8th house, as indicating other people's money, is also of particular significance in the matter of being able to collect money which is due. If there are several afflicted planets occupying this house, it indicates financial loss through trusting to the promises of others to pay. If Saturn is there, either debts will be paid slowly or not at all. If Mars is in the 8th, there will be strife over debts, and money due can be collected, if at all, only by forceful action.

The practical significance of this is that a person knowing his 8th house is severely afflicted can refrain from permitting others to become indebted to him. If he is a merchant, a cash and carry policy may lose him some customers, but in the long run it will be of financial advantage.

Legal Matters

—Law suits are indicated by the 7th house, because it is the house of the person bringing suit or being sued. Thus an afflicted 7th tends to involve the individual in difficulties that must be taken to the court to settle; and the greater the affliction of the 7th the more damage the opponent will be able to do.

But the court itself, where decision is rendered, is ruled by the 9th. For instance, in the reference book, *ASTROLOGY: 30 YEARS RESEARCH*, it was found that when separation of husband and wife was taken into court and became a divorce, there was always a major progressed aspect to the ruler of the 9th.

From the 9th, therefore, must be determined the attitude of the court, both judge and jury, before whom any civil or criminal case involving the individual is tried.

End of Life

—The circumstances surrounding the end of life are to be judged from the 4th house. Jupiter in this house is an indication that the individual will end his days amid abundance: while Saturn there indicates hard work and responsibilities, and if afflicted enough that actual want will be felt in the closing days.

The Sun in the 4th is some indication that toward the end the individual will attain to some prominence or dignity; Mercury that he will be among books, or engaged in writing; Venus that the surroundings will be bright and pleasant; and the Moon that the end of life will be full of movement and change.

People with Uranus or Neptune in the 4th, who do not become interested in astrology and occultism earlier in life, not infrequently are deeply absorbed in such subjects in their late years.

Uranus, of course, is a disruptive influence in domestic life. And Neptune in the 4th, aside from interest in occult matters, has a tendency to influence the individual to retire and live a life away from close contacts with his fellow man; an influence which becomes more insistent as there is advancement in age.

Chapter 8

Serial No. 110
Original Copyright 1934
Elbert Benjamine

Copyright
Church of Light
August 2002

How to Delineate a Horoscope

Chapter 8

How to Delineate a Horoscope

ONE who reads a birth-chart for another should be grounded in the conviction that the success of the reading given is to be measured by the amount of assistance it affords his client to be happier, more spiritual, and more useful to society.

These are the three worth while objectives of human life; and to the extent the advice of the astrologer conduces to their maximum attainment is that advice of value. If this is kept in mind, and the astrologer strives, to the limit of his ability, to aid his client cease drifting on the blind tides of fruitless endeavor, it will raise astrology from the rank of cheap fortune-telling into that of a dignified and exceptionally useful profession.

It is of very little value to any individual to be told that, according to the indications of his chart, he has certain faults. A cheap fortune-teller can tell him this. But the real astrologer, if worthy of the title, can, and does, also tell him just what step he can take to overcome these faults.

Any Gypsy along the road can point out to the individual that he is unsuccessful in making money. But it takes real talent to analyze a chart, pick out its weaknesses and its strong points, and indicate to this same individual how he can fortify his weaknesses and take advantage of such natural strength as he possesses, and thus so direct his efforts that he no longer is a failure, but becomes a financial success.

If a chart is so hopelessly afflicted in the 7th house that marriage can bring nothing but tragedy and unhappiness, it is better for the client to realize this and direct his energies wholly into other channels. When marriage is denied, it is always indicated by heavy afflictions in the chart. That is, the absence of marital experience in the life is always a real affliction. But if the chart is inimical enough in this respect, to avoid marriage may be the less of the two evils.

Yet as a matter of practical observation, few charts are so hopeless in this respect. Instead, they indicate that the individual needs special education and the development of more harmonious thought-cells in relation to affectional matters, and perhaps some special kind of partner, or some unusual arrangement in reference to the partnership. And it is when the astrologer can take a life which is miserable in its affectional experience, and direct it into channels of its maximum happiness in this respect, that he deserves to feel some pride in his work.

Some women, for instance, abhor merely taking care of the home. Their energy is such that they can only be happy when out in the business world striving with others, meeting others, and feeling that they are accomplishing something in the world's work. For such a woman to marry a man who feels that a woman's only place is in the home is to wreck the happiness of both. But there are many men who are not so much interested in a home as in having a pal and a lover with whom they can converse and with whom they can go places. A business woman with such a man may make of marriage just as great a success as the homebody wife with the home-loving male. And these are the things about which the astrologer should be able to give the correct information.

U. S. Grant was a failure in business. It was not until the war came along that his particular talents, which later placed him in the president's chair, were discovered. Every person has more chances of rising to honor, or at least making a greater success, along some line than along other lines. It is the astrologer's business to determine the field of work, and the circumstances under which it should be followed, to enable his client to gain the highest success.

Progressed aspects are not the writing of the hand of inevitable fate. They indicate that certain thought-cells, at predetermined times, will receive planetary energy of a particular quality, and, unless something is done about it by the individual, will become active in attracting a particular kind of event. The knowledge that such an event will transpire is of some advantage to the client, as it will enable him to arrange his affairs to meet the approaching conditions.

Yet indicating when such events will transpire, if nothing is done about them, is the less important work of the astrologer. His real function is to point out in detail just what his client should do to prevent, or mitigate, events which he does not desire, and to take fullest advantage of those he does desire.

Progressed aspects are not events, they are astral storms and astral sunshine, arriving at predetermined dates, which hinder or favor events. This hindrance or favoring is brought about through the energy, darkness or light, which they add to the thought-elements within the astral body having to do with the department of life where the influence is felt.

Just as a man protects himself from rain by umbrella and slicker, from cold by steam-heat, and takes advantage of the sunshine and fresh air by his morning walks, so the individual can protect himself from adverse progressed aspects by selection of physical environment, by diverting Rallying Forces of a genial nature into the channels of the adverse aspect, and by the use of Mental Antidotes applied directly to the thought-cells receiving the unwanted planetary energy. And he can take full advantage of favorable progressed aspects by mentally walking in the stream of their benign influence.

Delineating a horoscope is not just a matter of telling the individual the facts about himself as they exist. What he is now, as mapped by his birth-chart, is the foundation on which must be built what he is to become. It is important to understand this foundation. But a foundation is not a building. The important thing is the building. And it is the function of the astrologer, taking the foundation which already has been built, to indicate to his client how, in every department of life, he can build a future structure upon this foundation that is superior to any which could be built without the astrologer's services, and which is as near to realizing all his worthy desires as possible.

Follow the Rules.

—As this is written our school, in which teachers have been trained who are now conducting classes of their own in nearly every large city in America, has been in continuous operation thirty years. And the thing we have noticed as the most sure indication that a student will eventually become a good astrologer is not brilliance, but the ability to learn the rules set forth in these lessons and follow them closely.

It is not that there is any intention to limit the student's knowledge to our teachings. On the contrary we believe every student who masters our system should persist diligently to find, and prove out, additional astrological information. But we have found many rather brilliant minds who attend our classes that in reading a chart jump to the first thing they see in it, and flit from that to the next point, as a bird flits from limb to limb, with no system and no order. And instead of applying the rules set forth in the lessons, and modifying them as the chart indicates, they judge each position in the chart by what happens at the moment to enter their minds as a proper interpretation.

In thirty years teaching astrological students, I have never known one of these hop-skip-and-jump readers to become a reliable astrologer. To them a position at one time means one thing and at another time it means something else, and in the end means faulty judgment.

My advice to every astrological student is to learn the rules thoroughly, and always think of the rules first in every reading. Contradicting conditions in a chart often will prevent the application of a given rule; but in such instances the student should say to himself that the rule is so-and-so, yet in this particular instance it is modified or abrogated, and on that account must be read in the manner finally given.

Follow Some Definite System.

—In lesson No. 88 I have indicated the system, as seven steps which should be taken in the same order of sequence in judging any horoscope, which we have found most advantageous not merely in natal astrology, but also in other branches. Some such definite system should be adopted and followed by every astrologer.

First General Consideration.

—The first step, as there given, consists in gauging the Power of the chart by the distribution of the planets among the houses. In natal astrology, planets in an angle indicate thought-cells in the astral body with sufficient vigor to accomplish something. Unless there is energy present in volume nothing of importance, either good or bad, is attracted. Planets in an angle, or at least prominent, indicate thought-cell activity.

Thus in Lloyd George's chart four planets are in angles; in Jean Harlow's chart five are in angles; in Charles Lindbergh's chart four are in angles; in Anne Lindbergh's chart eight are in angles; in Henry Ford's chart four are in angles; in Thomas Edison's chart five are in angles; and in Upton Sinclair's chart four are in angles.

This means that the thought-cells in the astral bodies of these persons, as mapped by the angular houses thus occupied by planets, were vigorous enough to enable them to accomplish something if these energies were directed toward accomplishment.

To attract even good luck or bad luck in any marked degree takes energy. Nothing of consequence happens in the lives of people whose thought-cells do not possess, as mapped in the birth-chart, or as acquired through Mental Alchemy, more than mediocre energy. Therefore, if a chart is weak, the astrologer should tell the individual how, through cultivating desires and a proper line of thought and action, to give his life more power.

Second General Consideration.

—The second step is to observe the Quality of the influence which the most active stellar cells exert through noting the signs the planets and Ascendant are in. This Quality of the most active thought groups in the astral body is an important factor in determining the capacities and abilities.

In Lloyd George's chart, for instance, we find four planets and the Asc. in fixed signs, indicating fixity of purpose and ability to handle details. Four planets in movable signs enable him to branch out, pioneer, and when necessary enter untrodden paths. Two planets in mutable signs give adaptability, which is heightened by the adaptable planet, Mercury, in conjunction with the Asc.

We might judge, therefore, from the dominance of the fixed signs, that such an individual would be active and daring in carrying out his policies, that he would be agile in adapting means to attain his ends, but that once he had decided on the end to be attained he would not swerve, and would only surrender it when overwhelmed by insurmountable difficulties.

People with too many of their most active thought-cells indicated by fixed signs tend to be stubborn, to lack adaptability, and to hold on to investments and other things too long. They, therefore, should be advised how to cultivate a more elastic attitude.

People with too many stellar structures in the mutable signs, as indicated by the planets, permit both people and obstacles readily to deflect them from their purpose. They should, therefore, be instructed how to cultivate stamina and the ability to withstand being pushed about.

Those with too many active stellar cells of the movable type, are good starters. But they are so keen on pioneering that they tend to take up new projects before the ones already commenced are sufficiently under way. They should be instructed how to take pleasure in finishing what they start, and in not starting anything that they are unwilling to see through to its completion.

Third General Consideration.

—The third step, also as having a bearing upon temperament and ability, is to note the triplicity in which the planets are found. This indicates to what extent the stellar cells and stellar dynamic structures tend to express through inspiration, emotion, aspiration, or as influenced by practical considerations.

As in Lloyd George's chart six of the influences are in airy signs, he would move largely upon the intellectual plane. Practical considerations also would play an important part in his decisions, as three planets are in earthy signs. Two planets in fiery signs indicate considerable zeal and enthusiasm. But as he has no planets in watery signs, he may well know how to move others to tears, and may appeal to their sympathies, but is himself moved only by logic and reason.

People with too few planets in the fiery signs should be taught how to cultivate zeal and enthusiasm. If the watery influences are deficient they should cultivate sympathy and kindly emotions. An increased interest in mental activities should be advised when the airy signs are lacking in planets. When the earthy signs have too little influence in the chart, the individual should be instructed how to cultivate a more practical attitude.

And in his vocation and other endeavors, these should be selected with a view to his abilities and shortcomings as thus indicated by the triplicity distribution of the more active thought-cells in his astral body. To do the things which are compatible to the Quality and Triplicity of the more prominent influences in his chart he merely will need to utilize thought-cells which already are within his astral body; but to do the things which are not compatible to them, because the thought-cells are not thus already in his astral body, he will have to work hard to build them into himself. While not an impossible task, this means the systematic expenditure of an immense amount of energy over a long period of time to be able to do what another person, with the proper thought-cells already built, as indicated by his birth-chart, can do with almost no effort.

Fourth General Consideration.

—The fourth step is to note which houses are accentuated by containing planets. As planets indicate active thought-cells built into dynamic stellar structures, the houses holding planets indicate the departments of life in which the thought-cells have enough energy to attract events.

In Jean Harlow's chart, three planets in the 10th gave her much public notice, and the two planets in the 7th made partners an active factor in her life. Luther Burbank, with the only two angular planets in the 4th, gained fame in farming. Thomas Edison, with five planets in the 4th in a different sign, gained fame from work done in his laboratory. Conan Doyle, with six planets in the 12th was active in stories of crime detection and in psychic research. Charles Lindbergh, with four planets in the house of travel, the 3rd, was most active in flying. And Anne Lindbergh, with seven planets in her 10th—including the ruler of her 7th in conjunction with the ruler of her 1st—gained public recognition by accompanying her famous flying husband on perilous trips of exploration.

To build entirely new thought-cells into a compartment of the astral body which will have the vigor, and therefore the same power to attract events, as would be indicated normally by several planets in the house of the birth-chart, is probably a larger task than most people can accomplish. Therefore, the compartments of the astral body that already have the most numerous dynamic structures, as mapped by the planets,

should be considered as representing possibilities either for fortune or misfortune. And the client should be instructed how to avoid indicated misfortune, how to turn the discordant thought-energy shown into constructive channels, and how to take greater advantage of such compartments of his astral body as show unusual stellar cell activity of a harmonious nature.

Fifth General Consideration.

—The fifth step is to note the influence of each planet in the house it occupies. That is, each dynamic structure is composed chiefly of the thought-elements indicated by the planet mapping it, and these give their characteristics to the department of life mapped by their house position. This should be appraised before proceeding to the detailed delineation.

The public notice Anne Lindbergh receives, for instance, is influenced by each of the seven planets in her 10th. Jupiter gives abundance, and as it is ruler of the 4th, it associates her in the public mind with a wealthy father. Pluto is both the planet of universal welfare and the planet of gangsters and kidnaping. In the 10th of Upton Sinclair it brought him fame through unceasing toil for universal welfare. But in Anne Lindbergh's chart, being square Saturn, ruler of her children, it brought her notoriety in connection with the kidnaping of her baby and its murder and the \$50,000.00 ransom paid without avail. Mars, the ruler of the 3rd, in the 10th, conjunction the flying planet, Neptune, also brings her honor as a daring aviatrix.

In addition to the planets in his 3rd, Charles Lindbergh has both Pluto and Neptune in the 7th; house of open enemies. Neptune is the planet of aviation; and early in 1934 the cancellation of air mail contracts by the Postmaster General brought him into sharp conflict with the administration. In 1932 the kidnaping of his child brought a nation wide search for the gangsters, as indicated by Pluto in his 7th, who took ransom money from him, although the child had been murdered by someone almost immediately after it had disappeared.

Jean Harlow had Jupiter, the planet of abundance, in the 5th, house of love affairs and entertainment. It is one member of a grand trine, and her outstanding success was in the realm of entertainment. But she had Mars and Uranus in her 7th, house of marriage, and her marital life was an outstanding example of strife, disruption and tragedy.

Lloyd George, Calvin Coolidge, Franklin D. Roosevelt, Wm. Jennings Bryan and Anne Lindbergh get the widest publicity for such events as come into their lives, because the Moon, representing the common people, is in the 10th. Their actions and their affairs are perennially of public interest.

The house position of each planet, in addition to indicating the type of influence surrounding the department of life mapped by the house, also is a guide to the Mental Antidote which must be applied to overcome the misfortune, if such should be denoted, relating to the department of life.

Sixth General Consideration.

—The sixth step is to note the relation which exists between the house occupied by each planet and houses the cusps of which it rules; how many planets are above the horizon, how many are east, if the Asc. is fast or slow, and such matters.

When a planet is not in its own sign, but is in some other sign, it indicates that the thoughts about the department of life which it rules by sign have become subordinated to the department of life indicated by the house in which the planet is found.

For instance, if the ruler of the 7th is in the 1st, it indicates that the experiences before human birth with other life-forms have been such that they have built thought-cells into the compartment of the astral body relating to personal power with a type of activity which gives the individual the ability to dominate and overcome partners and open enemies. But if the ruler of the 1st is in the 7th, it indicates that past experiences have built into the compartment having to do with partners and open enemies a thought-composition which enables the partner or open enemies to have more influence over the individual than he has over the partner or open enemies.

This relation between two departments of life, in which one has a preponderance of influence over the other, may be to the individual's advantage, or it may be to his disadvantage. Yet it is not something inevitable. It is a condition due to the organization of thought-cells in his astral body. Therefore, if it is a condition of considerable disadvantage, the astrologer should instruct his client just how to go about it to build thought-cells into his astral body which will alter the influence thus shown in the birth—chart and enable him to attract conditions which are more to his advantage and to the advantage of society.

By way of illustrating what is meant: Jean Harlow, with the ruler of her 1st in the 10th, was dependent for success upon popular approval. Anne Lindbergh, with the ruler of the 7th in the 10th, gives her honor some power over her husband. Grau San Martin, with the ruler of the 10th in the 12th, is dependent for honor upon secret plots and the relative power of secret enemies.

The Detailed Delineation of a Birth-Chart.

— The first six steps in judging any horoscope, as applied to natal astrology, will be seen to be in the nature of a preliminary survey in which, to be sure, important information is gained and beneficial advice is given, but in which the precision of detail is omitted. That is, no attempt up to this point has been made to determine all the factors relating to any special department of life, nor to give all the advice regarding it which should be given.

That most important matter of the aspects has so far been completely neglected. And it is noting the number and nature of the aspects received by each planet in the chart which constitutes the seventh step in judging any horoscope.

When, therefore, in delineating a birth-chart, this seventh and final step is reached, the best plan is to take up each distinct department of life in orderly succession, consider what bearing each of the first six steps or general considerations, have upon it, and then to this add the influence of each aspect affecting it. and state the findings in as much detail as seems desirable.

The order of sequence which should be followed is not as important as it is to have some definite system always to follow so that no phase of the life will be overlooked. The order in which the activities and interests are presented in the bold-faced subheadings of the lessons No. 105 to No. 109 inclusive we believe to be a good system to follow. But if thought more desirable, the detailed delineation can be commenced with the things ruled by the first house, considering the various things ruled by each house in turn, moving on around the chart to the twelfth house.

But in whatever order the departments and phases of human activity are considered, no delineation of any department of life or type of anticipated endeavor should ever be considered complete until definite and detailed advice is given to the client as to the very best course of action to pursue regarding it. What he needs to know is not so much what will happen, as what he can do about it, and just how to do it.

If we start, for instance, with temperament and disposition, a statement of them as they exist is valuable to indicate adaptability to certain types of endeavor. But when the details of the disposition are revealed, as indicated not merely by signs and planets, but also by aspects, it is likely that certain characteristics are shown which are a detriment to the individual and which detract from his usefulness. These traits, therefore, should be pointed out as requiring correction.

Even so, nothing constructive has been accomplished. And not until the astrologer gives his client instructions in detail just how to go about it to correct the undesirable trait, by diverting its thought-cell energy into constructive channels, should he consider he has given a complete delineation regarding this phase of life.

Before passing from the first house of the birth-chart the health will most appropriately come in for consideration. It is not judged, of course, exclusively from the first house, but according to the rules given in lesson No. 106.

It is scant comfort to the client to be informed that as the Sun in his birth-chart is not in an angular house, has no aspect to Mars, no good aspect to Jupiter, and is severely afflicted, he has so little vitality he will probably die at a time most people are in their prime. If such positions occur in the birth-chart it is the obligation of the competent astrologer to tell him just how to go about it to build up a vitality far more vigorous than indicated by his birth-chart, so that he may live and accomplish the things he wishes to do.

The birth-chart reveals the diseases to which an individual is subject. But this information is of little value unless the astrologer advises his client what thoughts to think, what foods to avoid and what ones to use abundantly, and what environmental circumstances to cultivate, that he may avoid these diseases. They are attracted by the unusual activities of certain thought-cells which are discordant. And the client should be given detailed instructions in transforming these discordant thought-compounds into harmonious compounds, and on using Rallying Forces to supply them with harmonious energy instead of that which is discordant.

Should poverty be indicated in another birth-chart, instead of advising his client he must always remain in want, the astrologer, by keen analysis of the chart should be able to find the best possible field for acquiring money, and give his client specific instructions on cultivating those attitudes and experiences which enable him to attract a competence.

The astrologer should be able to select the vocation which his client should follow to be of greatest benefit to himself and others. When thus advising an adult, there are other considerations than those shown in the chart. A child can be educated to fill any place in life for which it has natural ability as shown by the chart. But already part of the life of an adult has flowed by. He can only with great difficulty start in the manner of a child. His educational background, and acquired handicaps must be taken into consideration.

Some have energy enough to gain an education after thirty; but to most it would be useless to advise an occupation requiring a good education if at that age they were still comparatively illiterate. One who in his own country might have been a good public speaker, but who has arrived in America after maturity, may find his accent too great an obstacle for him to overcome to follow this occupation here.

Thus in advising an adult in regard to activities where education and acquired habits are important, his cultural background and experiences since birth, as well as the chart for the time of birth, should be given proper consideration.

Affectional matters have considerable bearing upon the happiness, usefulness and spirituality of nearly every life. If the birth-chart indicates much disappointment and discord throughout life where these interests are concerned, the astrologer should not be content merely to tell his client that marriage will be disastrous, that love will be unrequited, or whatever the condition shown happens to be. He also should instruct just how to overcome these conditions indicated. Often if a certain type of person is avoided in affectional matter, or another type cultivated, or the affectional relation be on a prescribed basis of mutual tolerance, happiness may be gained from an otherwise discordant affectional life.

And even more frequently the assiduous cultivation of certain habits of thought and action, which the astrologer should be able to point out, will convert this, or any other department of life, from an intolerable situation into one of satisfactory expression.

After all, the condition attracted, whatever it may be, is due to the energy and activity of certain easily ascertained thought-cells within the astral body. These thought-cells have been formed by states of consciousness; and they can be added to, or altered by other states of consciousness. To do this requires the cultivation of new feelings, impulses, and thoughts, about the department of life in which a change of fortune is desired.

Habits of long standing, such as those which have built powerful dynamic thought-structures into the astral body, are not changed merely by willing them to change. They are altered only by resolutely following the law of new habit formation, as set forth in lesson No. 157.

No impossibility is involved in changing a birth-chart opposition into an effective trine, or a birth-chart square into an effective sextile, as will presently be explained. But even partially to succeed in such an effort new habit-systems must be formed to displace those indicated by the discordant aspect, and this is difficult enough even when the best method is followed. Therefore, the astrologer should be able to instruct his client not merely in the habits of thought and action which will build the desired new stellar cells into his astral body, but also the method by which most readily the new habit-system can be established.

The best planet in each chart delineated should always be selected, as it indicates those things with which the fortune will be best. And in this selection, prominence of the planet should receive attention as indicating its power to attract events and circumstances.

The worst planet in every birth-chart also should always be selected; but as indicating those things with which, by adding their character vibrations discordantly to the astral body, association will conduce most to misfortune.

However, aside from any one planet thus selected, most charts present an appearance which at once attracts attention to certain outstanding configurations. Such a combination may be a close square from angles, a close trine from prominent planets, a grand square or a grand trine.

A grand square gives just as much ability as does a grand trine, but to the extent the individual lives in the department of life indicated by the harmoniously aspected planets he will be lucky, and to the extent he lives in the department of his life indicated by the afflicted planets he will attract misfortune.

Before illustrating this, as so little has been written about Pluto, I should point out he is co-ruler of Scorpio, and on his adverse side is the planet of gangsters and profiteers, while on the higher side his laws are: Know Yourself; Master Yourself; Be Yourself; Give Yourself.

Now look at the chart of Thomas A. Edison, and you will perceive standing out an unusual square and an equally unusual sextile. Sun, Mercury and Neptune are conjunction in the 4th, in close sextile to Pluto in the 6th. So long as he worked in the laboratory, as indicated by the 4th, and with his employees as indicated by Pluto in the 6th he was a most lucky man, benefitting himself and contributing to universal welfare, as indicated by the sextile to the Universal Welfare planet.

But when he ventured into the department of life mapped by the 5th he often met heavy losses. This square contributed to his great inventive ability as strongly as if it had been a trine; but in his financial ventures, especially those of a speculative character, he was anything but fortunate. Yet in spite of recurrent financial loss, at his death he left an estate of proportion commensurate with the benefic influences in his 4th house.

Reference can be made advantageously to the grand trine to Venus in the 5th in the chart of David Belasco, the theatrical producer; to the grand trine to the Moon in the 11th in the chart of Professor Nicholas Murray Butler, president of Columbia University, and at times National Chairman of the Republican party; and to the grand trine of Pluto in the 10th in the chart of Upton Sinclair, whose novels have given him fame and money in spite of the fact that he has fought all predatory interests constantly in the interest of public welfare.

Next in power to attract good fortune is a planet which connects by a sextile and a trine two planets in powerful opposition. The dynamic stellar cells in the two compartments thus connected by an aerial are unusually active. The aerial mapped by the opposition picks up energy in great volume, but imparts to it discordant static. But when another planet through a sextile and a trine reach each terminal of the opposition with an aerial, these harmonious aeriels are able to drain the great energy of the opposition harmoniously into the stellar cells of the dynamic structure which this planet maps. Such a planet, and the department or life it maps, consequently, are commonly called the best in the chart, and attract the most spontaneous good luck.

In the chart of Charles Lindbergh, for instance, the opposition of Pluto and Neptune in the 7th to Uranus and the Moon in the 1st, is connected by both Sun and Mars in the 3rd (house of journeys), sextile Moon and Uranus, and trine Pluto; Mars also being trine Neptune.

In the chart of Anne Lindbergh the opposition of Uranus to Sun, Moon, Mars, Neptune and Mercury, is connected by Saturn in the 6th, sextile Uranus and trine the five mentioned planets. On their flights of exploration she is not merely a passenger, but an efficient helper.

Next to the grand square in its power to attract misfortune is a T, in which two planets in opposition are connected by a third planet which is square to both. Henry Ford has such a T-square in which Pluto, although trine the M.C. and conducing to business success, is square Mercury and Sun, and to the Moon. This has not merely brought labor difficulties, but afflicted him in court when he attempted to expose Wall Street racketeers.

The Three Methods of Planetary Energy Control.

—These grand squares, T-squares, oppositions and squares all map definite stellar aeriels which pick up the energies of the planets involved in such a manner that they are given a definite quality of static discord. The aeriels they map are present in the astral body because feelings, emotions, and impulses of the discord implied have been repeatedly present when the departments of life connected by the aspect have been associated.

What the astrological client wants, and what the competent astrologer should furnish, is a method by which these discordant thought-compounds can be handled so that they will cease to attract misfortune, or better still, will attract good fortune, in the department of life which their house position in the birth-chart indicates.

There are three distinct methods by which such control of planetary influence over the life may be gained. They may be used singly, or in combination. And it should be a part of every birth-chart reading to instruct the client just how to go about it to prevent the heavier afflictions in his chart from bringing into his life the misfortune indicated.

With a chart like that of the late Jean Harlow, it was not enough to tell her she would always be unfortunate in marriage and should stay single. She plainly was one who did not wish to remain single. Marriage was important to her. And the astrologer should have been able to tell her how to change the thought-compounds in the compartment of her astral body mapped by the 7th in such a manner that she could have had at least a reasonably happy marriage.

Rallying Forces.

—When the individual's thoughts and feelings are tuned to a certain vibratory quality, the nerve currents, which are electrical energies, become conductors of this quality of astral energy and carry it readily to all the stellar aerials of the astral body. So long as this state of feeling is maintained the chief astral energy received by the stellar cells at the terminal of all the aerials is of this type, and of this harmony or discord. If the energy thus picked up and transmitted to the various dynamic stellar structures is pleasant, it causes thought-cell activity, to the extent the energy has volume, and of a character which is fortunate.

If, in the birth-chart there is some favorable aspect, it is much easier to tune the consciousness to its harmony and hold it there persistently than to tune in on some quality to which no stellar aerial in the astral body is tuned. The more outstanding and powerfully harmonious the aspect, the easier it is to tune in on its harmony and pick up its energies in volume.

An individual, for instance, who has a grand trine in his chart finds it easier to tune in on its harmony, and to hold that state of feeling, than on a less pronounced aspect. And by the same token an individual with a grand square has more difficulty in keeping from tuning in repeatedly on this grand square than on less powerful aspects. To the extent the person lives in the environment and conditions indicated by the aspect it is easier for him to tune in on its vibrations, whatever they may be.

So long as he keeps his consciousness and feelings tuned to the best influence in his chart, its planetary energies are picked up and added as Rallying Forces to the various thought-cells reached by aerials. It is because those who have grand trines in their charts thus, without premeditation, live in such vibrations, that their lives in other departments than those reached by its aerials are often so successful.

By establishing the habit-system of keeping tuned in on the best influence in the chart the individual can minimize the amount of discordant planetary energy that reaches the thought-cells in his astral body, and at the same time furnish them with a type of energy that stimulates them to activities toward attracting more fortunate events.

Mental Antidotes.

—Rallying forces, to the extent they are accompanied by thoughts and feelings, also tend to change the thought-composition of the stellar cells. To the extent the thought-compound is thus altered will it tend to attract a different fortune in the department of life where it functions. But the use of Rallying Forces is too general to be most effective in this respect.

The most effective way of changing the thought-composition of a stellar cell from a discordant compound into one harmonious is through the application of its Mental Antidote. The thoughts of the Mars type most readily enter into harmonious compounds with those of the Moon or Pluto type. The thoughts of the Saturn type most readily enter into harmonious compounds with the Venus or Neptune type. Thoughts of the Jupiter type enter most readily into harmonious compounds with those of the Mercury or Uranus type. And in applying these thoughts and experiences it is essential, if strongly harmonious thought-cells are to be re-made from those inharmonious, that there be pleasure in the association.

As Course IX is largely devoted to finding and applying such Mental Antidotes, the details can be acquired there.

Conversion.

—Conversion, also a mental alchemy process, does not contemplate changing the thought-compounds in the astral body through adding to them other thought-elements than they already possess. Instead, realizing that planets connected by a heavy aspect, regardless of the nature of the aspect, map dynamic stellar structures possessing an immense amount of energy, it proposes to utilize all the energy present harmoniously through a rearrangement of the thought-elements already present, and perhaps adding more of the same planetary type.

It is possible, through the conditioning process described in Course XIV to learn to take pleasure in almost anything, even though always heretofore it has been most distasteful. Such work requires the establishment of new habit-systems. And a new habit-system can not be established merely by willing to do so. There is a definite technique, as set forth in lesson No. 157, and the astrologer should be able to tell his client not merely what new habits of thought he should adopt to convert a discordant aspect into a source of harmonious power, but also just how to go about it to establish the required habit-systems.

A discordant aspect implies that the thought-elements of the two planets involved, because the things indicated by the departments of life revealed by their house positions have been present in the mind under disagreeable circumstances, have combined in a thought-compound of definite discord. As a consequence, unconsciously, and usually also consciously, whenever these two departments of life are present in the thoughts there is a feeling of dissatisfaction or annoyance.

As these thought-cells were formed by discordant states of consciousness in relation to definite departments of life, they can also be reformed harmoniously by harmonious states of consciousness in relation to the same departments of life. It is all a matter of giving to them harmonious energy of greater volume and intensity than was originally given discordantly in their building. Harmonious thinking and feeling about the things mapped by discordant planets rearranges the thought-elements in the stellar cells relating to these things, and if the things thus brought about belong to different departments of life, an aerial capable of picking up corresponding energy harmoniously is built across the astral body connecting the two compartments.

That is, instead of thinking about things mapped by the favorable aspects in the chart, as in applying Rallying Forces, Conversion is accomplished by thinking about the things mapped by the most discordant aspects in the chart. But the association between two departments of life thus thought about must be free from discord and charged with pleasurable feeling. As the stellar cells are thus altered in the arrangement of the thought-elements of which they are composed, the pleasant association between the departments of life dissolves the stellar aerial across the astral body mapped by the discordant aspect, and builds a new one which picks up energy free from static and gives it a harmonious trend.

Conversion is far more difficult in practice than the application of Mental Antidotes; for when the things mapped by a discordant aspect are thought about there is an almost irresistible tendency for the thoughts to warp around to a viewpoint which has elements of discomfort. Often there is something like a mental argument with the person so signified, or about the matters indicated. Therefore, Conversion is not something which can be accomplished by an untrained mind. For its success the departments to be harmoniously united must only be thought about in a pleasurable way.

Yet to one conversant with the technique of forming habit-systems in reference to thoughts and feeling, who at the same time has sufficient resolution, any stellar aerial present in his astral body at birth, as mapped by an aspect in his birth-chart, can be dissolved.

Furthermore, its energies can be fully utilized in a manner that will attract fortunate conditions, instead of those unfortunate, by building across the astral body a stellar aerial, not mapped by the birth-chart, but nevertheless quite as effective, such as customarily is mapped by a sextile or a trine.

Through Conversion, which every astrologer should understand, an opposition can be transformed to exert the influence of a trine, and a square can be rerouted so that its effect in the life is that of a sextile.

Book 10-2

Copyright
Church of Light
August 2002

Natal Astrology Progressing the Horoscope

Chapter 1

Serial No. 19
Original Copyright 1934
Elbert Benjamine

Copyright
Church of Light
August 2002

The Hermetic System of Progressions

Chapter 1

The Hermetic System Of Progressions

TRADITION should never be mistaken for recorded history; yet when properly labeled it is sometimes not without a certain interest. And the tradition is that the system of predicting the probable time of events, here presented, has never been lost to The Brotherhood of Light since the days of Atlantis and Mu.

When the darkness shut down on those ancient lands—so the tradition runs—colonies were established where later were to rise Egypt, India, Crete, Peru, Mexico, China and Chaldea—the seven ancient centers of civilization. THE RELIGION OF THE STARS thus transplanted, though modified by the characteristics of each people through whose hands it passed, has finally reached the present generation.

Natal, as well as the other branches of astrology, was practiced in each of the countries mentioned. But in Chaldea predictions were checked as to accuracy by the Anu-Enlil series of observations extending unbroken for over a thousand years, in which the events as they happened were recorded with the astrological positions which coincided with them. This gave to the Chaldeans unusual precision in predicting the nature and time of events in human life.

The Anu-Enlil series of astrological observations is historical, in the sense that archaeologists have unearthed the clay tablets on which the records were made. But that the Hermetic System was derived from a still more ancient source, and reached us by way of Chaldea, is tradition.

My predecessor, from whom I received the tradition, used the system for twenty years before his passage to the higher plane. In 1902, after trying out all the methods in common usage, I adopted it, and found it most satisfactory in an extensive astrological practice which continued up to May, 1915. At that time, having discontinued private astrological practice, I commenced teaching it in the astrological classes held in Los Angeles; and in October, 1917, as the Hermetic System of Directions, it was published, and since that date has been in constant use in all B. of L. (now C. of L.) classes, wherever held, and has been tested and adopted by a vast number of astrologers throughout the world.

The Brotherhood of Light Astrological Research Department began in April, 1924, to solicit data, and since that time has collected, erected, and progressed according to this Hermetic System, many, many thousands of birth charts to the time of some given event. The Progressed Constants for each of the 160 different diseases considered in Course XVI, for each of the diseases considered in the book, *Body Disease and Its Stellar Treatment*, and for each of the events considered in the book, *When and What Events Will Happen*,* were ascertained in this manner.

The recurrent complaint of Church of Light teachers, from Miami to Seattle, and from New York to Los Angeles, is that their students are so muddled with a variety of systems that even when they think they are using the Hermetic System, in reality they are clouding their judgment with other factors which, however worthy in their own domain have no place in this method.

Some students also seem to think that when they are conversant with Major Progressions and Transits they have education enough. But no one can have that precision of judgment regarding details which differentiates the first class astrologer from the mediocre, who neglects Minor Progressions. And because they attract into the life the little events, from day to day and week to week, and their influence in the life of oneself and one's friends can thus readily be observed, to become fully conversant with them is even less of a task than to master major progressions.

Set up the birth chart of the people you know. Calculate the major progressed aspects for each important event they can remember, and observe how it fits in with your theories. Calculate the more important minor progressed aspects in their charts for a month or two ahead, and make an attempt to tell them the nature of half a dozen little events to come, and their dates. Then check the results. And in a similar manner find out how accurate, both as to the event and its importance, your judgment is when based on transit aspects.

If you follow this plan until you are thoroughly grounded in the system here set forth, and know just what you can, and can not, do with it, you will become a good astrologer. And after you have reached this point will be time enough for you to branch out and try to discover additional information. In fact, when you have reached this point, you should, by all means, thus endeavor still further to increase the range and scope of your knowledge.

All Unnecessary Factors Should Be Avoided

—It is one of the cardinal doctrines of science, applicable to every line of research, that so long as a condition can adequately be explained by factors already recognized, no new factor should be introduced into its explanation. Both in delineating the birth chart, and in its progression, we have held tenaciously to this principle, upon which material science has so successfully been able to build its systems.

We are sometimes asked why we neglect the Moon's Nodes, the Part of Fortune, and the Fixed Stars in the birth chart. We do so because, up to date, we have not found any condition in a person's life which could not satisfactorily be explained by the planetary positions without recourse to these other factors. We do not say that these positions have no value; merely that up to the present we have found no need to use them in explaining the conditions and events in people's lives.

Events occur in people's lives which can only be explained adequately through the progressed aspects of the Asc. and M.C. We thus progress them, as presently to be explained, as if they were planets. But in the birth chart we do not calculate aspects to the cusps of any other houses, and do not progress planets to aspects of the cusps of any other houses, nor progress the cusps of any other houses in any way; because so far in our very extensive research work we have found nothing that can not quite as well be explained without such aspects and progressions.

It should be borne in mind that an individual with active extra-sensory perception can take almost any system, however unreliable it may be to others, and get startlingly precise results. What we have striven for in our presentation of the Hermetic System, however, is not a system of divination; but to find and include all the actual astrological energies which have an important bearing upon human life. It may be that there are yet factors which remain undiscovered; but if so we will include them only when, through extensive analysis, we have become fully convinced that only by their use can certain conditions or events be satisfactorily explained or predicted.

Events Are Attracted Only by Unusual Thought-Cell Activities

—Events and conditions are attracted into human lives—and into the lives of all other creatures—due to the activities of the thought-cells within the astral form. The astral form of every living thing is composed of such cells, which we also commonly refer to as stellar cells, built by the consciousness accompanying experiences.

These stellar cells, the more active of which are organized into the dynamic structures mapped by the planets in the birth chart, have a certain intelligence of their own, and work from the inner-plane to attract into the life conditions and events corresponding to the way they feel.

When they receive no additional energy from any source, they have only the amount and kind of activity indicated by the birth chart. It is only when, from some source—astrological vibrations, thought vibrations, or the character vibrations of objects—they receive an additional energy supply that their activity is greater than the normal thus shown.

While the effect of conditioning since birth, and the present facilities of the physical environment must also receive attention, the chief problem in predicting the nature and time of events by natal astrology, therefore, is to ascertain the time when certain groups of stellar cells within the astral body will receive additional energy; and in what volume and in what harmony or discord it will reach them.

Relativity Now Explains How Progressed Aspects Time Energy Releases

—Only within the past few years has Einstein's Special Theory of Relativity become almost universally accepted by physicists the world over, and become the foundation of the physics as taught in our universities.

The most essential conception of this special theory of relativity, which is now so widely employed to explain the behavior of high-velocity particles, is the inter-relationship between velocity and time. It is held that there is no such thing as absolute time, but that as velocity increases time slows down, until at the velocity of light time comes to a standstill. Conversely, as time speeds up, velocity slows down, until at the time speed with which we are familiar objects tend to move at the velocity physical things are observed to do.

If at the velocity of light time stands still, within a single moment of such slow time an infinite number of events could happen. And in a realm, or condition, where velocities are not so great, but are greater than that of ordinary physical objects, a large number of events can happen in a single moment of this slower time. In our dreams, for instance, and to some people when they are on the verge of dying, there are numerous experiences which in ordinary time would require days or years, compressed into a few minutes of the slower time of this borderline state.

Material science has now proved that the nerve currents are electrical in nature and that man has an electromagnetic form. Electromagnetic waves when radiated move with the velocity of light; but electric currents traveling over wires or over nerves move much slower. In other words, in man's electromagnetic form are velocities greater than those of ordinary physical substance, but which are not so great as the 186,284 miles per second (1942) that light travels.

From what has already been said, it will be apparent that if a clock slows down relative to the velocity it acquires, as consciousness attains higher and higher velocities it will be able to have more and more experience within the space of four minutes of this slowed down time. At a certain velocity, which is well within the limit of what can be expected to occur in man's electromagnetic form, the ratio of the number of experiences in four minutes of slower time, to the number of experiences in the faster time of external life, is $365 \frac{1}{4}$ to 1.

As the ratio of velocities between one electromagnetic region of man's body and his physical existence is $365 \frac{1}{4}$ to 1, the occurrences that took place in a little less than four minutes of this slower Major Progression Time, when expressed in the faster Calendar Time of the external world occupy a duration of 24 hours, and what took place in 24 hours Major Progression Time of the boundary region, when externalized on the physical plane takes $365 \frac{1}{4}$ days of ordinary Calendar Time; that is, what took place in one day in the boundary region, when externalized takes place in one year of the faster physical time.

As the ratio of velocities between another electromagnetic region of man's body and his physical is about 13 to 1, the occurrences that took place in approximately 2 hours of this slower Minor Progression Time, when expressed in the faster Calendar Time of the external world occupy a duration of 24 hours, and what took place in 27.3 days of this Minor Progression Time in the boundary-line region, when externalized on the physical plane takes $365 \frac{1}{4}$ days of ordinary faster Calendar Time; that is, what took place in 27.3 days of this Minor Progression Time takes place in one year of faster physical time.

Progressed aspects indicate time-velocity transformations of energies, released according to the day-year, month-year, or year-year ratio, which bring about structural changes within the astral body. These structural changes enable the stellar cells to receive additional energies from the planets and thus gain the impetus to work, from the inner plane, to bring events of a definite type into the life.

The energy-release, as mapped by a progressed planet, is in that compartment and zone of the astral body mapped by the house and sign of the birth chart in which the progressed planet is located. Thus a planet merely moving through a house of the birth chart by Transit, by Minor Progression, or by Major Progression, brings about a structural change in the astral body which enables it to receive energy, of the nature indicated by the progressed planet, in that region. The energy release shown by a progressed planet forms a temporary stellar dynamic structure within the astral body. This acts as a radio receiving terminal for picking up and transmitting to that compartment of the astral body the energies of the vibratory rate of the planet.

Progressed Aspects Build Temporary Stellar Aerials

—When such a progressed planet forms an aspect with a planet in the birth chart, or with another major progressed planet, the energy-release builds across the astral body a line which acts as an aerial which picks up and transmits to its two terminals, energy of the types of the two planets involved in the aspect. In our extensive statistical studies we have found that when Mars or the Sun is involved, and at the

same time there are other heavy progressed aspects which act as Rallying Forces, the indicated events may occur when the progressed aspect is as much as a degree and a half from perfect. But as a general rule the effective orb within which the event indicated by a progressed aspect may be expected to take place is one degree from the perfect aspect.

Before it reaches one degree from perfect the line across the astral body usually has not become dense enough to act as an effective aerial. But at one degree from perfect it is dense enough to pick up about one half the peak load of the aspect, gradually increasing in power until the peak is reached when the aspect becomes perfect, then decreasing in power until at one degree beyond perfect it picks up only about one-half the peak load, past which point it usually has dissolved so far that it is no longer an effective receiver.

While within one degree of perfect the progressed aspect maps a temporary aerial stretching across the astral body which picks up astral energies from the planets, from the thoughts, and from the character vibrations of objects, which are of the frequency of either planet, and transmits them to the stellar cells mapped in the astral body by these planetary terminals.

These temporary stellar aerals thus formed by the cyclic release of energy, have a length indicated by the aspect which maps them, and this determines whether the astral energy, from any source derived, which they pick up, will be given a harmonious turn, or will be loaded with discordant static.

To the extent they transmit energy which is harmonious to the stellar cells at their terminals, are the thought-cells there given impetus to work to attract favorable events. Likewise, to the extent these temporary stellar aerals transmit energy which is discordant to the stellar cells at their terminals, are the thought-groups there located given an impetus to attract misfortune.

But in thus considering the type of activity of any group of thought-cells in the astral body as accelerated by new energy received, the type of activity they already possess, due to the conditions under which they originally were formed as modified by conditioning since human birth, is fully as great in importance as the quality of the new energy received.

That is, if they are composed of inharmonious thought compounds, as mapped by unfavorable birth chart aspects, the mere adding to them of a supply of harmonious energy is not sufficient markedly to change their nature. Or if the compound of which they are formed is quite harmonious, as shown by the birth chart aspects, the mere supplying them temporarily with discordant static does not cause them to feel so intensely malignant that they work to attract misfortune.

Any energy supplied by a temporary stellar aerial is thus of no more importance in determining the amount of harmony or discord which a group of stellar cells feels than are the permanent aerals mapped by aspects in the birth chart.

These permanent stellar aerals, unless changed through the deliberate cultivation of new processes of thought to dissolve them, not only indicate the nature of the thought compounds at their terminals, but they continue to feed them with astral energy of the harmony or discord denoted by the aspects. And because the thought-elements in the compounds were originally united as indicated by the aspects, and continue to receive some energy of the same quality, the temporary energy afforded by a less permanent stellar aerial is limited in its power to cause them to act in a manner different than has been their custom.

Importance of Event Depends Upon Intensity of Thought-Cell Activity

—In predicting what events will be attracted into the life at a given time, therefore, the first thing to do is to consider the normal composition and activity of the thought-cells within the compartment of the astral body affected. Then consider the volume, type, and harmony or discord of the energy added to the stellar cells within the compartment, and estimate not merely the amount of activity which will result from this new energy supply, but also how the new energy supply modifies or accentuates their normal feeling of harmony or discord.

The importance of the event, other things being equal, will be in proportion to the volume of energy received. That is, in the same physical environment it is always in proportion to the amount of thought-cell activity. But the fortune or misfortune of the event—its harmony or discord—cannot be determined solely by the harmony or discord of the energy added. The new energy merely modifies the normal feeling of pleasure or pain of the stellar cells. It does not change them completely. Thus the fortune or misfortune of the event cannot be ascertained merely from the harmony or discord of the progressed aspect in relation to the physical environment, but must be determined from the harmony or discord of the stellar cells made active in relation to the environment.

Because of the smaller volume of energy picked up by their temporary stellar aerals, only events of less importance are attracted by the stellar cell activity indicated by Minor Progressed aspects and Transit aspects. No event of outstanding importance will be attracted into the life unless there is a much stronger temporary stellar aerial, mapped by a Major Progressed aspect, within approximately one degree of perfect, stretching across the astral body.

The event attracted by the additional thought-cell activity will, of course, relate to a department of life to which the stellar cells, as mapped by their house position in the birth chart, belong. That is, the event will refer to one or more of the compartments in the astral body which, by house position, the planets involved in the aspect rule. And the circumstances attending the event will be characteristic of these planets.

It is not a difficult matter—because the progressed planetary aspects so reliably indicate the time of formation of temporary stellar aerals across the astral body which pick up and deliver new astral energy to definite groups of stellar cells—accurately to predict about when, and relating to what departments of life, an event will happen. But it is far more difficult to determine its importance, how fortunate or unfortunate it will be, or the specific event.

Determining Harmony or Discord of Thought-Cell Activities

—The reason the degree of fortune or misfortune of the event is difficult to determine is not only due to the resistance or facilities which environment offers to bringing about what the thought-cells desire, but also that a variety of conditions may influence the stellar cell activity as to harmony or discord. The normal way the thought-cells feel, in the compartment of the astral body influenced, must be estimated. Then must be gauged just how much this normal feeling will, or will not, be changed by the new influx of energy. Furthermore, it must be considered to what extent, if any, Rallying Forces, indicated by other progressed aspects, will be able to reach these stellar cells with their type of energy.

That is, there is always the factor of the general Mental Attitude; because if this, in spite of the particular progressed aspect under consideration, keeps the consciousness tuned in on some other type of feeling, this supplies the stellar cells at the terminals of all stellar aerals with energy of this harmony or discord, and their activities to attract fortune or misfortune are modified accordingly.

The reason progressed aspects usually work out in terms of their own harmony or discord is because few persons resist permitting themselves to think and feel, at such times, that which is indicated. Even the unwitting application of Mental Alchemy or Rallying Forces, as by those who because of their religious convictions or belief in New Thought continue to feel cheerful and happy in spite of apparent adversity, quite markedly, as we have had occasion to observe, modifies the misfortune that otherwise might be expected from a severe progressed aspect.

In other words, what is attracted to the individual is not due to the birth chart or to the progressed aspect, but is due to the activity of the thought-cells within the astral body, working from the inner plane. Anything, therefore, which alters this thought-cell activity, from whatever source it comes, or which alters the resistance of the physical environment to that which the thought-cells strive to bring to pass, also alters the fortune.

It is because structural changes within the astral body—which as to time and nature can be ascertained by calculating Major Progressions, Minor Progressions and Transits—are commonly the most influential means through which astral energies are added to the stellar cells within the astral body, that these become of utmost importance in every human life.

The positive influences in an individual's life, measuring the releases of energy which bring structural changes in his astral body at times which can be predetermined, that in turn afford certain stellar cells with the energy to attract events, with which an astrologer should concern himself, in addition to the birth chart, are only these three: Major Progressions, Minor Progressions and Transits.

The only difference to be observed in the influence of these three measures of progression is in the relative amount of structural change indicated by each, and consequently the volume of energy afforded the thought-cells above their normal amount, which makes the events attracted relatively important or unimportant.

That is, the structural changes indicated by Transits give the thought-cells only enough additional energy to attract inconsequential events. The structural changes indicated by Minor Progressions afford the stellar cells enough energy to attract the minor events of life. But it is only the structural changes indicated by Major Progressions which afford the thought-cells in any compartment of the astral body with sufficient additional energy that through their inner-plane activities they can attract important events into the life.

Major Progressions

—Major progressions are measured by the ratio of the movements of the planets during one apparent solar day releasing energy which causes the chief structural changes within the astral body that take place during one astrological year in the life of man.

This simply means that the movements and positions of the planets each four minutes after birth indicate the structural changes that take place within the astral body each day after birth; that the movements and positions of the planets each two hours after birth spread the structural changes so shown over each month of life after birth and that the movements and positions of the planets each day after birth relate to the structural changes within the astral body that take place during the corresponding year of life. To calculate the time, therefore, when any particular structural change of major importance will take place, is merely a matter of solving a simple problem. in proportion.

Up to 1942 it had been the custom to solve the simple problems in proportion involved in ascertaining when given major progressed aspects would be perfect in the manner still followed in the text of lessons No. 111, No. 112, and No. 113. But in that year I published the reference book, *PROGRESSED ASPECTS OF STANDARD ASTROLOGY*,* in which the simple problems in proportion involved in calculating progressed aspects are solved through the use of logarithms.

It should be understood that the precise time a progressed aspect is perfect is exactly the same whether the method of proportion is employed or the method of logarithms. We discover, however, that some students find logarithms easier to use than proportion, while other students find proportion easier. Which is used is quite optional, as the final result is exactly the same.

It will be seen that as a planet's movement between two consecutive noons in the ephemeris is the equivalent of 12 months Calendar Time by major progression, that the planet's movement during 2 hours (12 of 24 hours) is the same as 1/12 of the planet's movement during the same 24 hours. Whether the planet's motion during 24 hours is divided by 12, or its motion during 2 hours is calculated, the result is the same, and in either case represents its travel by major progression during one month of Calendar Time. In other words, it follows from the time-velocity relativity which permits astrological energies to be released by progression, that the position of a progressed planet may be calculated either by its proportional movement through space (as illustrated in the text of the lessons which follow), or by its proportional movement relative to time (which is the method of logarithms).

In placing the planets in the chart of birth when erecting the horoscope it is customary to find the distance that a planet has moved from ephemeris noon position by adding (d) the logarithm of the EGMT Interval, to (a) the logarithm of the daily motion of the planet. The logarithm so found is then (b) the logarithm of the distance the planet has traveled. Therefore, if we wish to know (d) the EGMT Interval it takes a planet to travel (b) a given distance required to complete an aspect, it is obvious we must merely reverse this process, and subtract (a) the logarithm of the daily motion of the planet, from (b) the logarithm of the distance the planet moves.

When the EGMT Interval is thus simply found it may then be converted into Calendar Time Interval according to the time-velocity ratio, which for major progressions is:

24 hours (one day) major progression (ephemeris EGMT Interval) time equal 12 month (one year, or 365 1/4 days) calendar time.

2 hours (120 minutes) major progression (ephemeris EGMT Interval) time equal 2/24 years (one month or 30 days) calendar time.

4 minutes (120 minutes divided by 30) major progression (ephemeris EGMT Interval) time equal 1/30 month (one day) calendar time.

Now, as ephemeris EGMT Interval is major progression time which can always be converted into Calendar Time according to the ratio just indicated, the EGMT Interval from noon on the day of birth—for which the distance the planets had traveled from their noon positions were calculated when finding their places in the birth chart—can be converted into Calendar Time. The noon positions of the planets on the day of birth thus represent their progressed positions on a definite calendar date. Mathematically it makes no difference if the calendar date found occurs before the birth of the individual, for in that case we have merely moved back from birth to get a starting point for calculating progressed positions during his life.

It should be obvious that if in placing the planets in the chart of birth we moved them forward from ephemeris noon positions—using a plus EGMT Interval—that to get them back to noon positions we must subtract their movement from their ephemeris positions. Also if we are to ascertain the Calendar Date corresponding by major progression to this moving the planets back to their noon positions, we must move back from birth the calendar interval represented by the EGMT Interval during which the planets thus are moved.

However, if in placing the planets in the chart of birth we moved them back from ephemeris noon positions—using a minus EGMT Interval—to get them again to noon positions we must move them forward their motion during the same EGMT Interval. And if we are to ascertain the Calendar Date corresponding by major progression to this moving the planets ahead to their noon positions, we must move ahead from birth the calendar interval represented by the EGMT Interval during which the planets are thus moved.

Whether the method followed in calculating the progressed aspects is that of proportion or that of logarithms, the calendar date thus found—called the LIMITING DATE—constitutes the most convenient starting point in calendar time. The Limiting Date (L.D.) must include year, month and day of calendar time.

As the positions of the planets in the ephemeris on the day of birth represent their major progressed positions on the L.D., the positions of the planets in the ephemeris on the day following birth represent their major progressed positions on the month and day of the L.D. in the following calendar year; each succeeding day in the ephemeris showing the major progressed positions of the planets on the month and day of the L.D. in the corresponding calendar year.

The ephemeris date which shows the positions of the planets by major progression as they appear for the month and day of a given calendar year is called the Major Progression Date. And for finding it we use the Limiting Date as the base or starting point in calendar time, and the day of birth as the base or starting point which is equivalent to it in progression time. Thus to find the Major Progression Date we merely count ahead in the ephemeris from the day of birth (major progression time) as many days as years of life (calendar time) have elapsed since the Limiting Date.

To find the progressed M.C., add to the birth chart M.C. the number of degrees and minutes the Sun has progressed since birth. To find the progressed Asc., take a table of houses for the latitude of birth and merely ascertain the degrees and minutes on the Asc. with the progressed M.C. already found. Other progressed house-cusps are not wanted, but if they were, they could be taken from the table of houses corresponding to the progressed M.C. and Asc.

The M.C. and Asc. are unique positions, unlike other house-cusps. The M.C. marks a thin blue line through the astral body which acts as an amplifier; while the Asc. is a heavy line which serves as a ground-wire over which electromagnetic energy reaches the outside world. Very extensive experience leads to the conviction that not merely in the birth chart, but also by progression, these two positions act very much after the manner of planets.

In many, many thousands of birth chart with progressed aspects worked out to the time of events handled by our research department, we have never, however, found it necessary to consider aspects to any other house-cusps in the birth chart, or to progress the cusps of houses other than the Asc. and M.C.

The house-cusps of a birth chart map the dividing membranes between one compartment in the astral body and another. These astral membranes mapped by the house-cusps do not act in the manner of planets. Consequently, while we progress the Asc., M.C. and planets through the houses of the birth chart, there is no progressed-chart, in the sense of progressing all the house-cusps, in the Hermetic System.

We have done a vast amount of research work on progressed aspects, and we find they invariably work out in terms of the houses of the birth chart through which the planets are progressing or which they rule.

The reason the M.C. is progressed the same distance the Sun moves by progression is that this avoids an error, due to the difference between mean time and true or apparent solar time, which is introduced when the progressed M.C. is found by using the mean time of birth on the major progression date.

This discrepancy in extreme instances would cause an error of approximately 7 1/2 degrees in the progressed M.C. and Asc.; which is the equivalent of about 7 1/2 years. But such an error in timing the progressed planets would be less than 8 days. On the average, in calculating progressions for middle life, the discrepancy amounts to, perhaps, 2 to 12 minutes.

This would cause an error of from one to three days in timing planetary progressions, which is close enough for practical purposes. But in timing the progressed aspects of the M.C. and Asc., the error would be from one to three years, which can not be tolerated.

Minor Progressions

—Minor progressions are measured by the ratio of the movements of the planets during one astrological month releasing energy which causes the minor structural changes within the astral body that take place during one astrological year in the life of man.

This means that the movements and positions of the planets while the Moon passes through each degree of the zodiac after birth indicate the minor structural changes that take place within the astral body each day after birth; that the movements and positions of the planets while the Moon moves one sign through the zodiac represent the minor structural changes in the astral body during one month of life; and that the movements and positions of the planets while the Moon moves through the whole zodiacal circle indicate the structural changes within the astral body that are spread proportionally over the whole year.

RULE: From the position of the Moon in the zodiac at birth, count ahead in the ephemeris as many astrological months—successive transits of the Moon over the degree and minute of the zodiac it occupied at birth—as there have been completed years of life. The positions of the planets, M.C. and Asc. during the following astrological month will form the Minor Progressions for the year of life following the birthday. The M.C. progresses the same number of degrees that the Sun has progressed by Minor Progression. As the Sun is always the same number of degrees zodiacally from the M.C. as at birth, the M.C. is easily found from the Sun's position by Minor Progression; adding or subtracting from the Sun's minor position its zodiacal distance from the M.C. at birth. The progressed Asc. may be ascertained from a table of houses for the latitude of birth by using the M.C. so found.

The aspects formed by the progression of the planets, M.C. and Asc. at the rate of one astrological month for each year of life, as strictly between Minor Progressed positions produce imperceptible effects. But when formed between Minor Progressed planets and angles to the planets and angles of the birth chart, or to the positions of the Major Progressed planets and angles, they produce structural changes within the astral body which attract the minor conditions and events of life.

Transits

—Transits are measured by the ratio of the movements of the planets during one astrological year releasing energy which causes the inconsequential structural changes within the astral body that take place during one astrological year in the life of man.

This means that the positions of the planets shown in the ephemeris, from day to day, bring about small structural changes in the astral body on those days.

RULE: The transits of the planets through the houses, especially the slower moving planets through angular houses, should be noted. The conjunction aspect of transiting planets with birth chart or major progressed planets in particular is worth observing, and next, the oppositions thus made by the slower moving planets. Only the aspects made to birth chart positions and Major Progressed positions should be noted; no attention being paid to transiting aspects to Minor Progressed positions, or to other Transiting positions.

In our very extensive research work we have been unable to notice any difference in the influence exerted by Major Progressed aspects, Minor Progressed aspects and Transit aspects, other than the volume of energy supplied the stellar cells as indicated by the importance and magnitude of the event attracted.

The events which many people believe to be occasioned by transiting planets are really coincident with major progressed aspects which have formed heavier temporary stellar aerals. Under such circumstances the transit, which merely aids the Major Progression, and which fails to work when no such Major Progressed aspect is present, is often accredited with full responsibility for attracting the event.

Predicting Events

—Except when influenced by Rallying Forces, each progressed aspect tends to work out in terms of its own departments of life as indicated by the house ruler-ships of the planets involved. That is, progressed aspects do not annul each other, but each attracts its own type of event. Very frequently, however, the fortune or misfortune of the event is not indicated by the harmony or discord of the aspect, but is powerfully influenced by the dominant progressed aspect at the time acting as a Rallying Force.

The indicated major event may be expected during the time the progressed aspect is within approximately one degree of the perfect aspect. The same orb of influence is effective for sub-major progressed aspects (major progressed aspects of the Moon), for minor progressed aspects, and for transit aspects. For an event to be attracted by any of the three types of progression it is not necessary that any other type of progression contribute to it. But during the period a major progressed aspect is within the indicated distance from perfect there will occur several brief periods when due to the major progressed Moon, or a minor progressed planet, or both, or several minor progressed aspects, forming an aspect with one of the planets involved in the major progressed aspect, or affecting the house ruling the anticipated event, the thought-cells working for the event are given unusual accessory energy. And it may confidently be expected the event will occur on one of these peaks of thought-cell activity.

The event indicated by a major progressed aspect is not much influenced as to its fortune or misfortune by the harmony or discord of the sub-major aspect or minor progressed aspect which gives its thought-cells accessory energy. Within the larger pattern of conditions indicated by the major progressed aspects, each sub-major aspect tends to work out in terms of a sub-major event or condition, and each important minor progressed aspect tends to work out in terms of a minor event or condition.

Astrology does not foreshow events which are inevitable. It maps thought-cell activities which influence the thoughts and behavior and exert extra-physical power on the environment in such a way as to make certain events probable. The effort should be, through elimination, to reduce the probable events, and the periods when one or more of them will happen, to as few alternatives as possible. A good way to do this is in the following manner:

1. Eliminate all events which do not bear the characteristics of one of the two planets involved and all events not belonging to the houses influenced.

SUN: Any progressed aspect of the Sun affects the vitality, the significance, and the authority.

MOON: Any progressed aspect of the Moon affects the mental attitude, the domestic life, and the everyday affairs.

MERCURY: Any progressed aspect of Mercury affects the mental interests, the facility or accuracy of expression, and increases the cerebral activity.

VENUS: Any progressed aspect of Venus affects the emotions, the social relations, and the artistic appreciation.

MARS: Any progressed aspect of Mars brings strife, haste, and increased expenditure of energy.

JUPITER: Any progressed aspect of Jupiter affects the individual through abundance, increased optimism, and joviality.

SATURN: Any progressed aspect of Saturn brings work, responsibility, and economy or loss.

URANUS: Any progressed aspect of Uranus affects through something sudden, through a human agency, and brings change into the life.

NEPTUNE: Any progressed aspect of Neptune increases the imagination, increases the sensitivity, and attracts schemes.

PLUTO: Any progressed aspect of Pluto affects through groups, through subtle force, and brings coercion or cooperation.

2. Eliminate all events improbable because of lack of proper birth chart planetary power, or lack of proper birth chart aspects, or lack of proper birth chart house activity.

3. Eliminate all events which the education and training of the individual, and the habit-systems his thought-cells have acquired make unlikely.
4. Eliminate from the remaining events those which do not fit into the pattern as influenced by Rallying Forces.
5. Eliminate from the few events that still remain those which the age of the individual make unlikely and which the environmental factors belonging to the two planets involved are not present to bring about.

Even after this process of elimination, there may remain several alternate events any one of which apparently might happen. But from the viewpoint that ascertaining the most probable event is not to foretell the inevitable future, but to be able to influence what actually happens, the residue thus found should be highly satisfactory; for one should not be unwilling to take steps facilitating several different events or deflecting several other different events, if by that effort the event when it actually occurs is made far more fortunate.

*Out of print, see Astrology: 30 Years Research

Calculating Progressed Aspects by Logarithms.

RULE: Find the EGMT Interval from noon the aspect is perfect on the day (Major Progression Date) the ephemeris shows it is completed. Divide the hours by 2 and call this months, and the minutes by 4 and call this days. This gives the calendar interval before or after the Limiting Date of the calendar year corresponding to the Major Progression Date.

Solving Example 1

lesson No. 113, by Logarithms.

Log. (b) 1.8573 0° 20' Venus past aspect.

Log. (a) 1.2950 1° 13' subtract daily motion Venus. Log. (d) .5623 6h 35m minus EGMT interval.

Dividing the 6 by 2 gives 3mo. Dividing the 35 by 4 gives 9d. Thus 3mo 9d is the minus calendar interval.

1922y 3mo 22d L.D. in calendar year.

3mo 9d subtract calendar interval.

1921y 12mo 13d date Venus sextile Saturn r.

Either Proportion or Logarithms Get Correct Dates.

It is more convenient to work progressed aspects of Sun, M.C. and Asc. by proportion. But when always using 60' as the yearly progression of the Sun, the date the progressed aspect is perfect may be a few days in error. Thus in the example below the Sun on January 4 is moving 61' instead of 60' per day. Using 61', either by logarithms or by proportion, gives the date the aspect is complete as January 3, 1922. January 6, 1922, however, obtained by using 60' as the yearly progression of the Sun, is precise enough for all practical purposes.

Solving Example 6

lesson No. 111, by Logarithms.

Log. (b) 1.7270 0° 27' distance Sun must travel. Log. (a) 1.3730 1° 01' subtract daily motion Sun. Log. (d) .3540 10h 37m plus EGTM interval.

Dividing the 10 by 2 gives 5 mo. Dividing the 37 by 4 gives 9 days. 5mo 9d is the plus calendar interval.

1921y 7mo 24d L.D. in calendar year.

5mo 9d add calendar interval.

1922 1mo 3d date Sun semi-square Venus r.

Solving Example 11 lesson No. 111, by Logarithms.

The gap to be closed by the M.C., and therefore by the Sun, is found as indicated in the lesson. On April 10, 1921, the Sun and Mars are thus $21^{\circ} 45'$ apart, and must yet close the $8'$ to make M.C. opposition Mars p. The daily gain of Sun on Mars, as indicated, is $15''$.

Log. (b) 2.2553 $0^{\circ} 8'$ Sun must gain to make aspect. Log. (a) 1.9823 $0^{\circ} 15''$ subtract daily gain of Sun.

Log. (d) $.2730$ 12h 48m plus EGMT interval.

Dividing the 12 by 2 gives 6mo. Dividing the 48 by 4 gives 12d. Thus 6mo 12d is the plus calendar interval.

2035y 2mo 9d L.D. in calendar year. 6mo 12d add calendar interval.

2035y 8mo 21d date M.C. opposition Mars. p.

Chapter 2

Serial No. 111
Original Copyright 1934
Elbert Benjamine

Copyright
Church of Light
August 2002

Major Progressions of Sun and Angles

Chapter 2

Major Progressions Of Sun And Angles

IT was Einstein's Special Theory of Relativity, followed to its practical and logical conclusions which led to the discovery of releasing and utilizing atomic energy. And it is this same Special Theory of Relativity followed to its practical and logical conclusions which indicates both how inner-plane energies operate and what can be done to cause them to work more to the individual's advantage.

As university scientists have conclusively demonstrated that time, distance and gravitation on the inner plane have properties radically different than they have on earth, should we expect inner-plane weather to operate according to the same laws weather operates on earth? Einstein's Special Theory of Relativity carried to its logical conclusions indicates that inner-plane weather affects the individual not merely according to his inner-plane constitution, but through certain time-space relationships that bring structural changes within his astral body.

Astrological energies constitute the inner-plane weather. How this inner-plane weather affects an individual, however, is not dependent upon any theory; for even as the time, distance and gravitation properties of the inner plane have been determined experimentally by university scientists, so have the properties of inner-plane weather, and how it works to affect individuals, groups, cities, nations and world affairs been determined experimentally, and through statistical studies carried out in the process of astrological research.

One of the outstanding influences of inner-plane weather is that when a person, creature or important event is born, it is born at a time when the inner-plane weather tends to coincide with the inner-plane make-up of that which is then born. Thus does the inner-plane weather at the time of his birth, as mapped by his birth chart, indicate the predisposition of an individual to develop abilities of a certain type. The planetary positions and aspects, whatever they may be, which indicate such a predisposition are called its birth chart constants. The statistically ascertained birth chart constants of 30 different vocations are set forth in the reference book HOW TO SELECT A VOCATION*

The predispositions indicated by the inner-plane weather conditions at birth never manifest as events or diseases except during those periods when the appropriate thought-cells receive commensurate additional energy from inner-plane weather mapped by progressed aspects.

Inner-plane weather consists of astrological vibrations in their infinite variety of combinations. Those mapped by progressed aspects enable planetary vibrations to reach and make active certain groups of thought-cells. These thought-cells have desires such as were imparted to them when they were formed and as indicated by the aspects of the planets mapping them in the birth chart. Such desires are temporarily altered by the planetary energy reaching them through the inner-plane weather mapped by a progressed aspect. And the additional energy thus reaching the thought-cells not only gives them the power to influence the individual's thoughts and behavior, but it also gives them the psychokinetic activity that enables them to attract events of the kind they desire into his life.

By far the most important inner-plane weather is mapped by major progressed aspects. Church of Light statistical research covering the lives of many thousands of persons indicates that every important event of life takes place during the period while a major progressed aspect is present involving planets characteristic of the nature of the event, and which rule the birth chart house governing the department of life affected. If more than one department of life is pronouncedly affected by the event, at the time it occurs there are always major progressed aspects involving the ruler of each house governing these various departments of life.

The periods in his life when the individual is likely to experience a specific event, condition or disease toward which he has a predisposition are indicated by certain major progressed aspects. These progressed aspects mapping inner-plane weather conditions which have been found always to coincide with the given event, condition or disease are called its progressed constants. The statistically ascertained progressed constants of 20 different events are set forth in the reference book *WHEN AND WHAT EVENTS WILL HAPPEN*,* and both birth chart constants and the progressed constants of 160 different diseases are set forth in Course XVI, *STELLAR HEALING*.

Both the birth chart position and the progressed position of a planet act as terminals for the reception of planetary energy. Each terminal actually involved in the progressed aspect receives the energy of the progressed aspect in full volume. But unless the progressed aspect is from a major progressed planet to its birth chart place—in which case there are only two terminals—each progressed aspect has two other terminals not directly involved in the progressed aspect. Each of these two terminals not directly involved in the progressed aspect receives, through the principle of resonance, one-half as much energy as is received by each terminal directly involved.

It is important to understand that commonly a major progressed aspect has four terminals because our research has determined that each major progressed constant of an event or disease is always reinforced by a minor progressed aspect heavier than from the Moon to one of its four terminals at the time the event occurs or the disease develops; and that each reinforced major progressed constant of an event or disease is always released by a transit aspect heavier than from the Moon to one of its four terminals at the time the event occurs or the disease develops. And an independent minor progressed aspect is always released by a transit aspect to one of the birth chart or major progressed terminals influenced by the minor progressed aspect at the time the event takes place.

Before an ephemeris of Pluto was available to permit its aspects to be included, there seemed to be indications that events influenced by progressed aspects of Sun or Mars occasionally took place while the aspect was as much as a degree and half from perfect. But as statistically indicated in C. of L. Astrological Report No. 61, published in the January, 1948, * number of The Rising Star, in these instances while sometimes the zodiacal aspect was well over the one degree limit, at the same time there was a progressed parallel aspect involving the significant planet which was not over the one degree limit.

The more closely the planets approach the perfect progressed aspect the greater the amount of energy the temporary stellar aerial in the astral body is capable of picking up, radio fashion, and transmitting to the thought-cells at its direct and indirect terminals, and the more capable these become of influencing events.

Due to the reinforcement effect of minor progressed aspects to any of the four terminals of the major progressed aspect, to the trigger effect of transit aspects to any of the four terminals of the major progressed aspect, and to the physical environment through which events must come, the important events attracted by major progressed aspects seldom arrive exactly on the date the progressed aspect is perfect. But other things being equal, they are more apt to arrive close to the date the major progressed aspect is perfect than while the aspect is farther removed. Therefore, that the time and nature of the important events which will be attracted into the life—unless they are forestalled by precautionary actions—may be estimated in advance, it is essential that the time be known when each major progressed aspect becomes perfect.

As major progressions are measured by the ratio of the movements of the planets during one apparent solar day releasing energy which causes the chief structural changes within the astral body that takes place during one astrological year of life, the movements and positions of the planets each four minutes after birth indicate the structural changes that take place within the astral body each corresponding day after birth; the movements and positions of the planets each two hours after birth spread the structural changes so shown over each corresponding month of life after birth; and the movements and the positions of the planets each day after birth indicate the structural changes and events attracted during the corresponding year and time of year of life.

The noon positions (or midnight positions if a midnight ephemeris is used) of the planets as given in the ephemeris must thus represent their major progressed positions for some year, month and day of calendar time either before or after birth. And as on an average the progressed positions of the planets on the birthday are no closer or farther from making perfect progressed aspects than the progressed positions of the planets for any other day of the year, the calendar date which corresponds to the ephemeris positions of the planets on the day of birth is the most convenient starting point for calculating the calendar date any major progressed aspect is perfect. Its originator called the calendar date thus found the LIMITING DATE.

Finding the Limiting Date

—The Limiting Date (abbreviated L.D.) is the date in calendar time corresponding to the major progressed positions of the planets on the day of birth as they are shown in the ephemeris. Convert the EGMT Interval of birth into months and days of calendar time by dividing the hours by 2 and calling the result months, and dividing the minutes by 4 and calling the result days.

If the EGMT Interval of birth is minus, add the calendar interval thus found to the year and month of birth. If the EGMT Interval of birth is plus, subtract the calendar interval thus found from the year, month and day of birth. The L.D. thus found is the calendar starting point from which all major progressed aspects and positions are calculated. As the birth chart positions of the planets are calculated for an EGMT Interval, the most convenient time for finding the L.D. is while the chart is being erected. However, should an EGMT Interval on the day preceding or following birth be used in finding the planets, places, this must not be employed in finding the L.D. Instead, the EGMT Interval on the day of birth must be ascertained; *for the L.D. must always be calculated from the EGMT Interval on the day of birth.* On B. of L. student blanks a space is designated on which to write the L.D. It may be in the year of birth, in the year previous to birth, or in the year following birth. In writing it down be sure to include not only the month and day of month, but also the year in which it falls.

Example 1: Chart 1a, Jan. 2, 1920, has an EGMT Interval of plus 10h 32m. What is the Limiting Date?

10 divided by 2 gives 5 as the month. 32 divided by 4 gives 8 as the days. As the interval is plus, the 5 months, 8 days must be subtracted from Jan. 2, 1920. This gives July 24, 1919, as the L.D. This means that the places of the planets given in the ephemeris for Jan. 3, 1920 (one day after birth) are their major progressed positions for July 24, 1920. The Map. D. for calendar year 1920 is thus Jan. 3, 1920.

Example 2: Chart 316, Dec. 17, 1920, has an EGMT Interval of minus 3h 30m. What is the Limiting Date?

3 divided by 2 gives 1 month with a remainder of 60 minutes. 60m plus 30m gives 90m. 90 divided by 4 gives 22 1/2 as the days. As the interval is minus, this 1 month, 22 1/2 days must be added to Dec. 17, 1920. This gives Feb. 9, 1921, as the L.D. This means that the positions of the planets on the day of birth, Dec. 17, 1920, are their major progressed positions for Feb. 9, 1921; and that their positions as shown in the ephemeris for Dec. 18, 1920, are their major progressed positions for Feb. 9, 1922. Likewise, the positions of the planets in the ephemeris for Dec. 28, 1920, are their major progressed positions for Feb. 9, 1932. Which means that the Map. D. for 1932 is Dec. 28, 1920.

Example 3: The birth chart of Henry Ford (lesson No. 107) has an EGMT Interval of plus 7h 56m. What is the Limiting Date?

7 divided by 2 gives 3 as the months, with a remainder of 60m. These added to 56m gives 116m 116 divided by 4 gives 29 as the days. As the Interval is plus, this 3mo 29d must be subtracted from July 30, 1863, which is the date of birth. This gives April 1, 1863, as the L.D. July 31, 1863, represents the major progressed positions, and is the Map.D. for April 1, 1864; and Aug. 1, 1863, represents the major progressed positions for April 1, 1865. and is thus the Map.D. for 1865.

Finding the Major Progression Date

—Both the L.D. and the Major Progression Date should always be calculated from the date of birth in the ephemeris. Using the day preceding or following birth in the ephemeris is the most common source of error in calculating major progressions. The Major Progression Date (abbreviated Map.D.) is the ephemeris day which shows the major progressed positions of the planets for the month and day of the Limiting Date, but for some calendar year. To find the Map.D. for any calendar year, count ahead in the ephemeris from the day of birth as many days as complete years have elapsed since the Limiting Date. The ephemeris day so located is the required Map.D. Examples 1, 2 and 3 illustrate the process.

Finding the Midheaven Constant

—As explained in lesson No. 19, the M.C. progresses—by major progression, by minor progression, and by transit progression—exactly the same number of signs, °s and ‘s that the Sun progresses through the zodiac during the same time. As the progressed aspects made by the M.C. and Asc. are extremely important—next in importance to those made by the Sun—it is advisable to reduce the work of calculating a series of them, once for all, in each chart by finding the Midheaven Constant.

The Midheaven Constant (abbreviated M.C.C.) is the distance in the chart of birth between the M.C. and the Sun in signs, °s and ‘s expressed as a plus or minus, so that when added to the sign, °, and ‘ occupied by the M.C. the algebraic sum gives the sign, °, and ‘ occupied by the Sun. It is found by merely subtracting the smaller zodiacal longitude occupied by birth chart M.C. or Sun, from the larger zodiacal longitude occupied by birth chart M.C. or Sun, and placing before the signs, °s, and ‘s thus found the proper plus or minus sign.

Then, wherever the M.C. may be by progression—major, minor or transit—algebraically add the sign, °, and ‘ it occupies to the M.C.C. and the result is the sign, °, and ‘ occupied by the progressed Sun. And wherever the progressed Sun may be, change the sign before the M.C.C. and algebraically add it to the sign, °, and ‘ occupied by the progressed Sun and the result is the sign, °, and ‘ occupied by the progressed M.C.

Example 4: In chart 1a, the Sun is 11 Capricorn 16 and the M.C. is 5 Aries 45. From 10S 11° 16’ subtract 1S 5° 45’ and it gives 9S 5° 31’. As to find the position of the Sun the difference so found must be added to the M.C., the M.C.C. is plus 9S 5° 31’.

Example 5: In chart 316, the Sun is 25 Sagittarius 08 and the M.C. is 16 Cancer 45. From 9S 25° 08’ subtract 4S 16° 45’ and it gives 5S 8° 23’. As to find the position of the Sun the difference so found must be added to the M.C., the M.C.C. is plus 5S 8° 23’.

Example 7: In the Henry Ford chart (lesson No. 107), the Sun is 7 Leo 06 and the M.C. is 12 Virgo 00. From 6S 12° 00’ subtract 5S 7° 06’ and it gives 1S 4° 54’. As to find the position of the Sun the difference so found must be subtracted from the M.C., the M.C.C. is minus 1S 4° 54’.

The Problems of Progressions

—The calculations involved in chart erection, major progressions, minor progressions and transit progressions are chiefly the solution of problems in direct proportion such as are taught in grammar school. In each problem (a): (b) :: (c) : (d)

In thus solving problems in proportion, as the product of the means is equal to the product of the extremes, when the two inner terms are given, multiply one by the other and divide the product by the outer term. When the two outer terms are given, multiply one by the other and divide the product by the inner term. The result is the answer.

Any of these problems in proportion can be solved in four different ways. They can be solved by direct proportion, they can be solved by logarithms, they can be solved with a slide rule, or they can be solved with The Church of Light Chart Calculator.

In mathematically handling proportions involving hours and minutes and °s and ‘s, the use of logarithms greatly reduces the labor. Each problem in proportion considered in this book can be worked either by direct proportion, or by logarithms. By either method the letter employed to designate each term of the proportion is as follows:

(a) is the ephemeris daily gain, or gain through some constant interval of time or space.

When only one planet or position is moving, as when a planet is moving to make an aspect with some birth chart position, the ephemeris daily gain (a) is the daily motion of the planet. When both planets or positions are direct in motion, or when both planets or positions are retrograde in motion, subtract the ephemeris daily motion of the slower moving planet from the ephemeris daily motion of the faster moving planet. The result is (a) the ephemeris daily gain. When one planet or position is direct in motion and the other is retrograde in motion, add the two daily motions. Their sum is (a) the ephemeris daily gain.

(b) is the gain during some selected interval of time or space.

(c) is the constant interval of time or space.

(d) is some selected interval of time or space.

In employing direct proportion to solve problems in progression it is more convenient to work immediately with calendar time. But in employing logarithms it is more convenient to work the problem first in terms of progression time (EGMT Interval), and then convert the result so found into calendar time. Diurnal proportional logarithms such as are to be found in the back of most ephemerides are constructed to solve just such problems in proportion, term (c), which is always 1440 minutes (24 hours) , being taken care of by the table.

The advantage of such logarithms, which are almost universally used in erecting birth charts to find how many °s and ‘s a planet moves during a given EGMT Interval, is that the logarithm of term (b) can be obtained merely by adding the logarithms of term (a) and (d); and the logarithm of term (d) can be obtained merely by subtracting the logarithm of term (a) from the logarithm of term (b).

To designate the birth chart position of a planet it has become the custom to use the letter r after the planet, to designate a major progressed planet to use the letter p after the planet, to designate a minor progressed planet to use the letter m after the planet, and to designate a transit progressed planet to use the letter t after the planet.

Finding the Major Progressed Positions of the Planets on a Given Calendar Date

—Find the plus or minus calendar interval in months and days the given date is from the nearest month and day of the L.D. Then find the Map. D. in the ephemeris for the L.D. from which the given calendar date is this number of months and days distant. Convert the calendar interval from the L.D. in that calendar year into EGMT Interval (major progression time) at the rate of each month being equivalent to 2 hours, and each day being equivalent to 4 minutes. If the calendar interval is plus the EGMT Interval thus found is plus; if the calendar interval is minus the EGMT Interval thus found is minus. Use this EGMT Interval on the Map. D. in the ephemeris exactly as if finding the birth chart positions of the planets for this EGMT Interval on that ephemeris day.

Example 8: Find the major progressed positions of the planets on Nov. 24, 1949, for chart 1a. In example 1 the L.D. is found to be July 24, 1919. Subtracting 7mo 24d from 11mo 24d gives a plus calendar interval of 4mo. Multiplying 4 by 2 gives a plus 8h EGMT Interval. Subtracting 1919(L.D.) from 1949 gives 30. Adding 30 days to January 2, 1920 (date of birth) gives February 1 as the Map. D. Using the planetary positions on Feb. 1, 1920, and calculating their positions for a plus EGMT Interval of 8 hours, gives their major progressed positions on November 24, 1949, as shown on page 35.

Example 9: Find the major progressed positions of the planets on April 24, 1934, for chart 316. In example 2 the L.D. is found to be Feb. 9, 1921. Subtracting 2mo 9d from 4mo 24d gives a plus 2mo 15d calendar interval. Multiplying 2 by 2 gives 4h. Multiplying 15 by 4 gives 60m, or 1h. There is thus a plus 5h EGMT Interval. Subtracting 1921 (L.D.) from 1934, gives 13. Adding 13 days to Dec. 17, 1920 (date of birth) gives Dec. 30, 1920, as the Map. D. Using the planetary positions on Dec. 30, 1920, and calculating their positions for a plus EGMT Interval of 5h, gives their major progressed positions on April 24, 1934, as shown on page 36.

Finding the Major, Minor or Transit Progressed M.C. on a Given Date

—First find the sign, °, and ‘ occupied by the progressed Sun on the given calendar date. Change the sign before the M.C.C. and algebraically add the M.C.C. to the sign, °, and ‘ occupied by the progressed Sun. The result is the precise progressed M.C.

Example 10: Find major progressed M.C. for chart 1a on November 24, 1949. In example 4 the M.C.C. for this chart is shown to be plus 9S 5° 31 ‘. Major progressed Sun on November 24, 1949, is 11 Aquarius 41. Subtracting 9S 5° 31’ from 11S 11° 41’ gives 2S 6° 10’. Thus progressed M.C. is 6 Taurus 10.

Example 11: Find major progressed M.C. for chart 316 on April 24, 1934. In example 5 the M.C.C. of this chart is shown to be plus 5S 8° 23'. Major progressed Sun on April 24, 1934, is 8 Capricorn 44. Subtracting 5S 8° 23' from 10S 8° 44' gives 5S 0° 21'. Thus progressed M.C. is 0 Leo 21.

Finding the Major, Minor or Transit Progressed Asc. on a Given Date

—In a table of houses look between the two columns within which the progressed M.C. occurs, and find (a) the °s and 's between the nearest and next nearest Asc. given for the latitude nearest that of birth.

Find (c) the °s and 's between the nearest and next nearest M.C. given in the table. In Dalton's, AP, Raphael's and RC tables this is always 1° (60').

Find (d) the °s and 's between the true M.C. and the M.C. given in the table.

By proportion reduce each term to 's, then multiply (a) by (d) and divide the product by (c). This gives (b), the distance the Asc. is from the nearest Asc. given in the table for the nearest latitude given in the table.

By logarithms, to log. (a) add log. (d), and from the sum so found subtract log. (c). The result is log. (b), the distance the Asc. is from the nearest Asc. given in the table for the nearest latitude given in the table.

If the true M.C. is smaller than the M.C. given in the table, subtract (b) from the nearest Asc. in the table. If the true M.C. is greater than the M.C. given in the table, add (b) to the nearest Asc. in the table.

This gives the Asc. for the latitude given in the table. If the latitude of birth is not precisely that given in the table, use the Correction For Latitude given on page 34.

Example 12: Find major progressed Asc. for chart 1a on November 24, 1949. In example 10 the major progressed M.C. for this date is shown to be 6 Taurus 10. AP and Raphael's tables give the Asc. for 6 Taurus as 15 Leo 39 and the Asc. for 7 Taurus as 16 Leo 24. The difference (a) is thus 45'. As 6 Taurus 10 is 10' more than 6 Taurus, (d) is 10'. (c) is 60'. By proportion, multiplying 45 by 10 gives 450. 450 divided by 60 gives 7 1/2'. By logarithms, the sum of log. (a) 1.5051 and log. (d) 2.1584 is 3.6635. Subtracting log. (c) 1.3802 from 3.6635 gives 2.2833, which is the log. of (b) 7 1/2'. To the Asc. for 6 Taurus, which is 15 Leo 39, we add 8' (considering the 1/2 as 1), which, as the table is for the precise latitude of birth, gives the progressed Asc. as 15 Leo 47'.

Example 13: Find major progressed Asc. for chart 316 on April 24, 1934. In example 11 the major progressed M.C. for this date is shown to be 0 Leo 21. Dalton's table gives the Asc. for 0 Leo in latitude 40 as 25 Libra 38, and the Asc. for 1 Leo as 26 Libra 27. The difference (a) is 49'. As 0 Leo 21 is 21' more than 0 Leo, (d) is 21'. (c) is 60'. By proportion, multiplying 49 by 21 gives 1029. 1029 divided by 60 gives 17. By logarithms, the sum of log. (a) 1.4682 and log. (d) 1.8361 is 3.3043. Subtracting log. (c) 1.3802 from 3.3043 gives log. 1.9241, which is the log. of (b) 17'. To the Asc. for 0 Leo, which is 25 Libra 38, we add 17', which gives the progressed Asc. for the latitude given in the table as 25 Libra 55.

But as the true latitude of birth is $39^{\circ} 45'$, there is a correction to be made for (d) the 15' difference in latitude. Under the 0 Leo column the table gives 25 Libra 52 for latitude 39, and 25 Libra 38 for latitude 40, a difference of (a) 14'. (c) is 60'. Following the instructions given on page 34, by proportion, multiplying (a) 14 by (d) 15 gives 210. Dividing 210 by 60 gives (b) $3 \frac{1}{2}'$. By logarithms, subtracting log. (c) 1.3802 from log. (d) 1.9823 gives .6021. Adding log. (a) 2.0122 to .6021 gives 2.6143, which is the log. of (b) $3 \frac{1}{2}'$

As the true latitude is less than the nearest latitude given in the table and the 's are decreasing with latitude, we add the correction of $3 \frac{1}{2}'$ to 25 Libra 55, which (considering the $\frac{1}{2}$ as 1) gives the progressed Asc. as 25 Libra 59.

Finding the Calendar Date on Which a Major Progressed Aspect Between Planets is Perfect

—Find the Map. D. in the ephemeris nearest the ephemeris time the aspect is perfect.

Find (a) the daily gain in °s and 's of the one planet on the other as indicated on the Map. D. in the ephemeris.

Find (b) the °s and 's the aspect is from perfect. In employing proportion (c) is 12 months or 365 days. In employing logarithms (c) is 24h EGMT Interval.

In employing proportion (d) is months and days of calendar time from the L.D. in the calendar year it takes the planets to close the gap (b) and make the perfect aspect.

In employing logarithms (d) is the number of hours and minutes of EGMT Interval on the Map.D. it takes the planets to close the gap (b) and make the perfect aspect. This EGMT Interval must then be converted into its equivalent plus or minus calendar interval at the rate of each 2 hours being equal to 1 month and each 4 minutes equal to 1 day. By either method if the aspect is formed before the positions given in the ephemeris, subtract the calendar interval thus found from the L.D. in the calendar year. If the aspect is formed after the positions given in the ephemeris, add the calendar interval thus found to the L.D. in the calendar year. This gives the calendar date the aspect is perfect.

By proportion, to find (d) multiply (b) by (c) and divide by (a).

By logarithms, to find (d) subtract log. (a) from log.(b).

Example 14: The L.D. for chart 1a was found to be July 24, 1919. On what date does the Sun make the conjunction with Uranus r by major progression?

Uranus r is 29 Aquarius 03. Turning to the 1920 ephemeris we find the Sun on Feb. 19, 1920, in 29 Aquarius 34, and thus (b) 31 ' past the perfect aspect. Between Feb. 18 and Feb. 19, 1920, the Sun is moving (a) 61'.

By proportion, multiplying (b) 31 by (c) 12 gives 372. Dividing 372 by (a) 61 gives the calendar interval (d) as 6 6/61 months, or 6mo 3d.

By logarithms, subtract log. (a) 61', 1.3730 from log. (b) 31', 1.6670, and it gives log. .2940, which is the log. of (d) 12h 12m. Dividing 12 by 2 gives 6mo. Dividing 12 by 4 gives 3 days.

Counting ahead in the ephemeris from the day of birth, January 2, 1920, we find that Feb. 19 is 48 days later. Adding 48 years to the L.D., July 24, 1919, gives 1967 as the calendar year for Map. D. Feb. 19, 1920. As the aspect was formed before the positions given in the ephemeris on Feb. 19, 1920, we subtract the calendar interval 6mo 3d from July 24, 1967. This gives the date of progressed Sun conjunction Uranus r as January 21, 1967.

Progressing the Sun

—Examples of finding the dates of major progressed aspects of the other planets will be found in lessons No. 112 and No. 113. For precision the calendar date on which each progressed aspect involving the Sun is perfect should be determined in the manner above indicated. But as the daily motion of the Sun varies only from 57' to 61', its approximate major progression per month is 1/12 of this, or approximately 5'; and 1' progression is thus equivalent approximately to 6 days of calendar time. Thus when there is no need for precision it is more convenient to work progressed aspects of the Sun by proportion.

Example 6: Find date on which in chart 1a major progressed Sun makes the semi-square with Venus r. Venus is 28 Scorpio 18. The Sun must therefore reach 13 Capricorn 18 to make the semi-square. In example 1, we found the L.D. for this chart to be July 24, 1919. On January 4, 1920, the ephemeris shows the Sun 12 Capricorn 51. It must therefore move 27' to make the aspect. Dividing 27 by 5 ('s of Sun travel per month) gives 5mo. Multiplying the remaining 2' by 6 (days the Sun travels in 1') gives us 12d.

Counting ahead in the ephemeris from the day of birth, January 2, 1920, we find January 4 is 2 days later. Adding 2 years to the L.D. July 24, 1919, gives 1921 as the calendar year for the Map. D. As the aspect was formed after the positions given in the ephemeris, we add the 5mo 12d to July 24, 1921, and it gives the date of Sun semi-square Venus r as January 6, 1922.

When the actual travel of the Sun on the Map. D., 61', is used, the more precise date obtained by either proportion or logarithms is January 3, 1922. The problem worked out in detail by logarithms is given on page 3 of lesson No. 19.

Finding the Sign, °, and ' on the M.C. for a Given

Asc.

—If the table of houses does not give the precise latitude of birth, find the Correction for Latitude as explained on page 34.

When the true latitude is less than the nearest latitude given in the table: If the table shows the 's decreasing with latitude, the correction is subtracted. If the table shows the 's increasing with latitude, the correction is added.

When the true latitude of birth is greater than the nearest latitude given in the table: If the table shows the 's decreasing with latitude, the correction is added. If the table shows the 's increasing with latitude, the correction is subtracted.

This gives the Asc. for the nearest latitude given in the table.

Find (a) the °s and 's between the nearest and the next nearest M.C. in the table. In Dalton's, AP, Raphael's and RC tables this is always 1° (60').

Find (c) the °s and 's between the nearest and the next nearest Asc. given in the table.

Find (d) the °s and 's between the true Asc. corrected for the latitude given in the table, and the nearest Asc. for that latitude given in the table.

(b) is the distance the true M.C. is from the nearest M.C. given in the table.

By proportion, to find (b), multiply (a) by (d) and divide the product by (c). By logarithms, add log. (a) to log. (d) and from their sum subtract log. (c).

Example 15: In chart 1a what sign, ° and ' is on the M.C. when progressed Asc. makes the conjunction with Neptune? To make the conjunction the progressed Asc. must move to 10 Leo 55. Looking in the table of houses for New York we find the nearest Asc. 11 Leo 08, with 30 Aries 00 on the M.C. The next nearest Asc. is 10 Leo 24. The difference (c) is 44'. The difference (d) between 10 Leo 55 and 11 Leo 08 is 13'. By proportion, multiplying (a) 60 by (d) 13 gives 780. Dividing 780 by (c) 44 gives 18'. By logarithms, adding log. (a) 1.3802 to log. (d) 2.0444 gives log. 3.4246. Subtracting log. (c) 1.5149 from 3.4246 gives 1.9097, which is the log. of (b) 18'.

As the Asc. when the aspect is complete is less than the nearest Asc. given in the tables, the 18' must be subtracted from 30 Aries 00. This gives the progressed M.C. 29 Aries 42.

Example 16: In chart 316 what sign, ° and ‘ is on the M.C. when progressed Asc. makes the trine with Pluto r? To make the trine with Pluto r the Asc. must move to 8 Scorpio 04. Dalton’s table of houses shows 15 Leo 00 on the M.C. when 7 Scorpio 40 is on the Asc. in lat. 40, and 8 Scorpio 01 on the Asc. in lat. 39. As chart 316 is erected for lat. 39:45, there is a correction to be made for (d) 15’ of latitude. (a) is 21’, the difference between 7 Scorpio 40 and 8 Scorpio 01. Multiplying (a) 21’ by (d) 15’ gives 315. 315 divided by (c) 60’ gives the correction for latitude as 5’. Subtracting this 5’ from 8 Scorpio 04 shows that when 8 Scorpio 04 is on the Asc. in lat. 39 :45, 7 Scorpio 59 is on the Asc. in lat. 40, the lat. given in the table. We need to find, therefore, the sign, °, and ‘ on the M.C. when the table shows 7 Scorpio 59 on the Asc. in lat. 40.

In lat. 40 the table shows 7 Scorpio 40 as the nearest Asc. and 8 Scorpio 27 as the next nearest. The difference (c) is 47’ The difference (d) between 7 Scorpio 40 and 7 Scorpio 59 is 19’. By proportion, multiplying (a) 60 by (d) 19 gives 1140. Dividing 1140 by (c) 47 gives 24’. By logarithms, adding log. (a) 1.3802 to log. (d) 1.8796 gives log. 3.2598. Subtracting log. (c) 1.4863 from 3.2598 gives 1.7735, which is the log. of (b) 24’.

As the Asc. when the aspect is complete is more than the nearest Asc. given in the table, the 24’ must be added to 15 Leo 00. This gives the progressed M.C. 15 Leo 24.

Finding the Calendar Date from Major, Minor or Transit Progressed M.C.

—Algebraically add the sign, °, and ‘ of the progressed M.C. to the M.C.C. The result is the sign, °, and ‘ occupied by the progressed Sun on the sought calendar date. Thus when the sign, °, and ‘ occupied by the Asc. when it makes an aspect is determined, the sign, °, and ‘ on the M.C. for this Asc. can be ascertained as above explained. And when the sign, °, and ‘ occupied by the progressed M.C. when it makes an aspect is determined—as when it makes an aspect to a birth chart planet—this can be used. In either case, from the M.C. find the sign, °, and ‘ occupied by the progressed Sun by algebraically adding to it the M.C.C. Then find the calendar date on which the progressed Sun occupies the sign, °, and ‘ so found. This is the precise date on which the progressed Asc. or M.C. makes the aspect, or reaches the given sign, °, and ‘ of the zodiac.

Example 17: In chart 1a, on what date does major progressed Asc. make the conjunction with Neptune r? In example 15 we found the aspect is perfect when 29 Aries 42 is on the progressed M.C. In example 4 we found the M.C.C. for this chart to be plus 9S 5° 31’. Adding 9S 5° 31’ to 1S 29° 42’ gives the major progressed position of the Sun 11S 5° 13’. On January 26, 1920, the ephemeris gives the Sun 5 Aquarius

15. This is 2' past the required position, and as the Sun moves at the rate of 1' for each 6 days by major progression, this is equivalent to 12 days to be subtracted from the L.D. July 24, in the calendar year, giving July 12. As January 26 is 24 days after birth, we add 24 years to the year of the L.D., 1919. Asc. is conjunction Neptune r July 12, 1943.

Example 18: In chart 316, on what date does major progressed Asc. make the trine with Pluto r? In example 16 we found the aspect is perfect when 15 Leo 24 is on the M.C. In example 5 we found the M.C.C. for this chart to be 5S 8° 23'. Adding 5S 8° 23' to 5S 15° 24' gives the major progressed position of the Sun as 10S 23° 47'. On January 14, 1921, the ephemeris gives the Sun 23 Capricorn 49. This is 2' past the required position, and as the Sun moves at the rate of 1' for each 6 days major progression, this is equivalent to 12 days to be subtracted from the L.D. February 9, in the calendar year, giving (ignoring the 31 days in January) January 27. As January 14 is 28 days after birth, we add the 28 years to the year of the L.D., 1921. Asc. is trine Pluto r January 27, 1949.

Finding the Progressed Zodiacal Motion of Major, Minor or Transit M.C. or Asc.

—In a table of houses find the nearest Asc. to that the motion of which is to be ascertained for the latitude nearest that of birth. The difference in Asc. motions between consecutive latitudes is so small that using the motion for the nearest latitude is sufficiently precise.

Find (a) the difference in °s and 's between the nearest and the next nearest Asc. given in the two columns within which the progressed Asc. is found.

Find (c) the difference in °s and 's between the nearest and the next nearest M.C. given in the same two columns in the table. In Dalton's, AP, Raphael's and RC tables this is always 1° (60').

Find (d) the daily motion of the Sun in °s and 's as given in the ephemeris on the Map. D., MED, or Transit Date. This is also the number of °s and 's traveled by the progressed M.C. during the same progressed interval. It is the daily motion of the M. C. on the Map. D., MED, or Transit Date.

By proportion, multiply (a) by (d) and divide the product by (c). This gives (b). By logarithm, add log. (a) to log. (d), and from the sum subtract log. (c). This gives log. (b). (b) thus found is the °s and 's the Asc. moves during the same major, minor or transit progression interval moved by the Sun. It is the daily motion of the Asc. on the Map. D. MED, or Transit Date.

**Finding the Calendar Date on Which an Aspect
Involving Major Progressed M.C. or Asc. is
Perfect.**

—From the daily motion of the M.C. or Asc. on the Map. D., and the daily motion of the planet on the Map. D., find (a) the gain of the one on the other in °s and ‘s. If the aspect is from progressed M.C. or Asc. to a birth chart position, (a) is the daily motion of M.C. or Asc.

Find (b) the °s and ‘s the aspect is from perfect. To find (b) first find the sign, °, and ‘ occupied by the progressed M.C. or Asc. on the Map. D. Then find the sign, °, and ‘ occupied by the progressed planet on the Map. D. The °s and ‘s which are less subtracted from the °s and ‘s which are greater, gives the °s and ‘s the aspect is from perfect.

(c) is 12mo calendar time or 24h EGMT Interval.

With (a), (b) and (c) thus ascertained the date the aspect is perfect is found exactly as in finding the date on which a major progressed aspect between planets is perfect.

Example 19: In chart 1a, on what date does major progressed Sun make the opposition of progressed Asc.? On Feb. 20, 1920, the ephemeris shows Sun 0 Pisces 34. Subtracting the M.C.C. 9S 5° 31’ found in example 4, from 12S 0° 34’ gives the progressed M.C. for this Map. D. 25 Taurus 03. The Asc. when 25 Taurus 03 is on the M.C. as worked from the table of houses for New York is 0 Virgo 31. Progressed Sun, moving faster than progressed Asc. is thus (b) 3’ past the perfect opposition. The Sun on Feb. 20, and therefore the M.C., is moving 60’. The Asc. is moving 48’ while the M.C. moves 60’. The gain (a) of the Sun on the Asc. is the difference between 48’ and 60’ or 12’.

By proportion, multiplying (b) 3 by (c) 12 gives 36. Dividing 36 by (a) 12 gives 3mo. By logarithms, subtracting log. (a) 2.0792 from log. (b) 2.6812 gives log. (d) .6020 which is the log. of 6h. Dividing 6 by 2 gives 3mo. Subtracting the 3mo from the L.D. July 24, in the calendar year, gives April 24. Feb. 20 is 49 days after the day of birth on Jan. 2. To the year of the L.D., 1919, we therefore add 49 years. Progressed Sun is opposition Asc. p April 24, 1968.

Example 20: In chart 316, when does major progressed Mercury make the sextile with major progressed Asc.? The Map. D. for 1930 is 9 days after birth, or Dec. 26, 1920. The ephemeris position of Mercury on this date is 22 Sagittarius 23. The position of the Sun on Dec. 26, 1920, is 4 Capricorn 27. In example 5 we found the M.C.C. of this chart to be plus 5S 8° 23’. Subtracting 5S 8° 23’ from 10S 4° 27’ gives

the progressed M.C. on the Map. D. 26 Cancer 04. Dalton's table of houses shows 22 Libra 19 on Asc. in lat. 40 when 26 Cancer 00 is on M.C. Asc. moves 50' while M.C. moves 60'. Thus when 26 Cancer 04 is on the M.C. 22 Libra 22 is on the Asc. in lat. 40. As explained in example 13 there is a further correction of 3' to be added which gives the Asc. in lat. 39 :45 as 22 Libra 25.

As the Asc. on Map. D. is 22 Libra 25, and Mercury is 22 Sagittarius 23, the distance aspect is from perfect (b) is 2'.

The Sun on Dec. 26, and therefore the M.C., is moving 61'. To find how far Asc. moves while M.C. moves 61', as previously explained, multiply (a) 50 by (d) 61. This gives 3050. Then divide by (c) 60, which gives the daily motion of the Asc. (b) as 51'. The daily motion of Mercury on Jan. 26, 1920, is 1° 31'. The daily gain is thus 40'.

By proportion, multiplying (b) 2 by (c) 12 gives 24. Dividing 24 by (a) 40 gives (d) 24/40mo or 18d. By logarithms, subtracting log. (a) 1.5563 from log. (b) 2.8573 gives 1.3010 which is log. (d) 1h 12m. Dividing this 72m by 4 gives 18d. As Mercury is moving faster than the Asc. the aspect is formed after the Map. D. Therefore the 18d must be added to Feb. 9, 1930. Progressed Mercury is sextile Asc. p, Feb. 27, 1930.

*Out of print, see Astrology: 30 Years Research

Correcting Ascendant for Latitude of Birth

Find (a) the difference in °s and 's between the house cusp for the nearest latitude to that of birth and the house cusp for the next nearest latitude to that of birth given in the table of houses.

Find (c) the difference in °s and 's between the nearest and the next nearest latitude to that of birth given in the table. In Dalton's, AP, AA, and RC tables this is always 1° ($60'$)

Find (d) the difference in °s and 's between the true latitude of birth and the nearest latitude given in the table.

By proportion, reduce each term to 's, then multiply (a) by (d) and divide the product by (c). This gives (b), the correction for latitude.

By logarithms, from log. (d) subtract log. (c), and to the difference so found add log. (a). The result is the log. of (b), the correction for latitude. In using Dalton's, AP, AA, and RC tables log. (c) is always 1.3802.

When the true latitude of birth is less than the nearest latitude given in the table: If the table shows the 's decreasing with latitude, the correction is added. If the table shows the 's increasing with latitude, the correction is subtracted.

When the true latitude of birth is greater than the nearest latitude given in the table: If the table shows the 's decreasing with latitude, the correction is subtracted. If the table shows the 's increasing with latitude, the correction is added

Chapter 3

Serial No. 112
Original Copyright 1934
Elbert Benjamine

Copyright
Church of Light
August 2002

Major Progressions of the Moon

Chapter 3

Major Progressions Of The Moon

OTHER than that a progressed planet carries with it only one-half the power (astrodynes) it had at birth, the influence is the same whether the planet under consideration is a birth chart planet receiving the aspect of a progressed planet or is a progressed planet making an aspect to a birth chart planet or to another progressed planet. Therefore, instead of repeating the phrase, “making an aspect to or receiving an aspect from”, when a planet makes or receives an aspect, we merely say it is involved in the aspect.

Each planet maps, both in the birth chart and by progression, a particular type of inner-plane weather. This type of inner-plane weather influences the desires of the thought-cells in a manner characteristic of the planet mapping it. Thus from each planet involved in a progressed aspect we may expect the thought-cells to use whatever psychokinetic power they gain from the aspect to try to bring into the life conditions and events characteristic of the planet.

Aside from the type of inner-plane weather indicated by the planets involved in the aspect, each aspect indicates weather that is favorable or unfavorable, or that has a special trend, which is distinctive of the aspect mapping it. This distinctive trend is indicated by the key-word of the aspect as given in lesson No. 87.

The inner-plane weather indicated by a progressed aspect chiefly influences the thought-cells mapped by the birth chart houses containing the terminals of the progressed aspect and the houses of the birth chart ruled by the planets involved. As the thought-cells mapped by a house relate to a definite department of life, the houses involved show the departments of life chiefly influenced by the progressed aspect.

Progressed Aspects Involving the Sun

—Any progressed aspect involving the Sun affects the vitality, the significance, and the authority.

The thought-cells in the astral form mapped or ruled by the Sun are chiefly composed of thought-elements of the type which relate to the persistence and significance of the Individual.

They express as the Power Urges, map the most deep seated traits of character, are particularly important in giving power to exercise authority over others, as indicating the relations with men in general, and as being the rulers of the electrical energies which give vitality. They not only denote the ability to exercise power over others, but the ability to get the esteem and confidence of those who exercise such authority.

Power and energy are not the same thing. Energy must be effectively directed to become power. Ability to dominate conditions through persistently directed desire, or will-power, resides primarily in the Individuality, or Sun dynamic structure, of the astral body.

Progressed aspects involving the Sun are very important because the activity of the Power thought-cells so largely determines the Individual's power. They indicate his ability to get along with those in authority, and his own estimation of himself or the esteem in which others hold him. He only gets honors when there is a progressed aspect involving the Sun.

Progressed Aspects Involving the Moon

—Any progressed aspect involving the Moon affects the mental attitude, the domestic life, and the everyday affairs.

The thought-cells in the astral form mapped or ruled by the Moon are chiefly composed of thought-elements of the type which relate to the unconscious mind and the domestic life.

They express as the Domestic Urges, map the most open and receptive avenues to the unconscious mind, are particularly important as affecting the moods, the domestic life, the relations with the common people, the relations with women in general, and as being the rulers of the magnetic energy which influences the strength of the physical constitution and therefore the health.

The major progressed Moon moves through all twelve houses and makes all possible aspects to the other planets in 27.3 years. Because its thought-cells are so open an avenue for energy, its passage through each house in turn, averaging less than two and a half years, tends to bring the things signified by the department of life ruled by the house it is in at the time to the fore.

In some manner the popularity is apt to be affected by aspects involving the Moon. As it relates to the Mentality, the temporary mood is indicated by the planet to which it makes a progressed aspect.

Progressed Aspects Involving Mercury

—Any progressed aspect involving Mercury affects the mental interests, the facility or accuracy of expression, and increases the cerebral activity.

The thought-cells in the astral form mapped or ruled by Mercury are chiefly composed of thought-elements of the type which relate to perception and intellectual effort.

They express as the Intellectual Urges. Mercury is the messenger. The planet with which it is involved in a progressed aspect influences the trend of thinking; and the departments of life mapped by the houses occupied by Mercury and the other planet involved in the aspect tend to become subjects of thought. Thus an aspect with Venus turns the thoughts toward mirth, an aspect with Mars turns the thoughts toward strife, an aspect with Jupiter turns the thoughts toward optimism and expansion, and an aspect with Saturn turns the thoughts to serious matters, to caution and to security.

While discordant progressed aspects involving Mercury are operative there is a tendency to attract misfortune through errors, which may be those of the person experiencing the aspect, or of others with

whom he is dealing. Clerical errors, mistakes in addressing letters, mistakes in making change, documents purposely or by error wrongly worded, and saying the wrong thing, are common difficulties that arise.

Harmonious progressed aspects involving Mercury, on the other hand, give facility in writing and talking, and comparative freedom from error. They also favor travel; although there must be a progressed aspect involving the ruler of the third house for a short journey, and a progressed aspect involving the ruler of the ninth house for a long journey.

Progressed Aspects Involving Venus

—Any progressed aspect involving Venus affects the emotions, the social relations, and the artistic appreciation.

The thought-cells in the astral form mapped or ruled by Venus are chiefly composed of thought-elements of the type which relate to feeling.

They express through the Social Urges, and the things they attract come into the life through social relations. There may be an attraction to music, dancing, art or other common avenue by which the emotions are given expression; or the emotional nature may merely become more sensitive to such contacts as already have been established. Neither a love affair nor marriage can be expected unless the ruler of the fifth or the ruler of the seventh is involved in a major progressed aspect; but a progressed aspect involving Venus has a definite influence upon such affectional matters as are present.

If Venus is involved in a discordant progressed aspect, not only will there be a tendency for misunderstandings to develop, but the individual inclines to be unusually sensitive to imaginary slights or opposition. If he can realize this and train himself to overlook discord he will fare much better.

When Venus is involved in a harmonious progressed aspect, affectional matters move forward smoothly, and the attitude tends to be buoyant and pleasure-seeking, attracting many happy occasions and joyous expressions. Venus inner-plane weather influences about one-fourth of all the good fortune experienced by mankind.

Progressed Aspects Involving Mars

—Any progressed aspect involving Mars brings strife, haste and increased expenditure of energy.

The thought-cells in the astral form mapped or ruled by Mars are chiefly composed of thought-elements of the type which relate to energy.

They express through the Aggressive Urges. Whether the psychokinetic energy attracts infection, accident or combat, is diverted into mental creation, healing and surgery, into mechanical work, or into the building of something depends on whether the thought-cells given activity are discordant or harmonious. Only in so far as it can be controlled is Mars energy beneficial; and even under the most favorable aspects what is gained is at the expense of initiative and strife. One must fight for any advantage Mars brings.

Mars is a social planet, and while its aspects are effective conflicts with others tend to develop. The individual feels less submissive, and is more active and aggressive than usual. If the aspect is favorable, it gives him the ability to win his objective in spite of opposition. But if the aspect is unfavorable he suffers severely from the antagonism of others.

Mars is also the mechanical planet, and its progressed aspects affect the relations with machines, with sharp instruments, and the various agencies which may cause accidental injury. Machines give trouble under adverse aspects involving Mars, and surgical operations and accidents take place only while some major progressed aspect involving Mars is present.

Haste is often a contributing factor to such accidents. Impulse and over-exertion are Mars tendencies, and fevers and infection are attracted only while there is a progressed aspect involving Mars. Mars inner-plane weather influences about one-fourth of all the trouble experienced by mankind. Under Mars inner-plane weather cultivate patience and take it easy.

Progressed Aspects Involving Jupiter

—Any progressed aspect involving Jupiter affects the individual through abundance, increased optimism, and joviality.

The thought-cells in the astral form mapped or ruled by Jupiter are chiefly composed of thought-elements of the type which relate to good-fellowship.

They express through the Religious Urges, and the things they attract into the life are not derived from work and hardship, but from good-fellowship and patronage. Jupiter is the salesmanship planet, and the things attracted by its thought-cells are derived chiefly from the benevolence and good will of others. They give an optimism which tends toward expansion, and they incline toward thoughts of religion and business. Jupiter is a business planet, and contacts with merchants, bankers, the clergy, lawyers and doctors are particularly affected by the activity of its thought-cells.

The most fortunate of planets, its thought-cells use their psychokinetic power to bring Abundance. Even such afflictions as they bring are due to an excess of something, such as excess of food, or excessive richness of food which injures the health, excessive expenditures which affects the finances, over expansion which affects the credit, or too great generosity, carelessness or extravagance. Jupiter inner-plane weather influences about one-half of all the good fortune experienced by mankind.

Progressed Aspects Involving Saturn

—Any progressed aspect involving Saturn brings work, responsibility, and economy or loss.

The thought-cells in the astral form mapped or ruled by Saturn are chiefly composed of thought-elements of the type which relate to security.

They express through the Safety Urges, and the things they attract into the life are derived from responsibility, perseverance, plodding labor, system, organization, hardship or loss. If the aspect is harmonious the work done is productive of commensurate gain; but if discordant, there is inadequate recompense for labor expended.

Saturn is a business planet, but the method it follows is always restrictive, and thus the opposite of that employed by Jupiter. His gains are made through economy, system, order, shrewdness, and taking advantage of the necessity of other persons to buy at the lowest figure. In selling under progressed aspects involving Saturn the appeal must be made by means of presenting a bargain; and in buying a harmonious aspect involving Saturn is the best influence to attract a bargain.

The most unfortunate of planets, its thought-cells use their psychokinetic power to bring Poverty. The afflictions they bring are due to a lack of something, such as inadequate diet affecting the health, death or sickness affecting the home, or loss affecting finances. Saturn inner-plane weather influences about one-half of all the troubles and losses experienced by mankind. Under Saturn inner-plane weather keep your chin up and cultivate cheerfulness.

Progressed Aspects Involving Uranus

—Any progressed aspect involving Uranus affects through something sudden, through a human agency, and brings change into the life.

The thought-cells in the astral form mapped or ruled by Uranus are chiefly composed of thought-elements of the type which relate to originality.

They express through the Individualistic Urges, and the things they attract into the life come suddenly, through some human agency, and inaugurate a change which after they have passed in some manner leaves the life on a higher mental level. They tend to bring into the life new persons and new conditions, to take out of the life old associates and old conditions, and to bring new ideas which profoundly affect the life.

Uranus is the radical planet. He has a code of his own and is utterly indifferent to convention. Thus unconventional attachments or unconventional views flourish when his thought-cells are active. More than any other thought-cells they tend to the formation of sudden strong attachments and the breaking of them. Breaking one attachment often coincides with forming another. Yet an attachment formed under a progressed aspect involving Uranus is apt to last only while the aspect is within the one effective degree of perfect.

Uranus has particular rule over astrology and the occult sciences, although both Neptune and Pluto incline also to such studies. When the progressed aspect involving Uranus is a strong one it divides the life as if one chapter had been finished and an entirely new one commenced. And the instrument by which such changes are brought about, often as a bolt from a clear sky, is always human. The planet rules the sign of the Man, and such favors as it brings come through some person attracted by the activity of its thought-cells, and the misfortunes it attracts are due to some person exercising an undue influence over the life, or through some person's carelessness.

New inventions, and gadgets requiring electricity such as automobiles and radio sets, tend to get out of order under discordant progressed aspects involving this planet. And a peculiar thing about any of the events attracted by its thought-cells is that no matter how favorable they are there is also some small loss, and no matter how unfavorable they are, they are accompanied by some small gain.

Progressed Aspects Involving Neptune

—Any progressed aspect involving Neptune increases the imagination, increases the sensitivity, and attracts schemes.

The thought-cells in the astral form mapped or ruled by Neptune are chiefly composed of thought-elements of the type which relate to idealism.

They express through the Utopian Urges, and the things they attract into the life come without much effort, for Neptune dislikes hard work. He inclines to negativeness, to great sensitiveness and to day dreams, rather than to positive action. He also is unconventional, but less obviously so than Uranus. His thought-cell activity inclines the mind to advanced views, and to interest in occultism, psychic matters and astrology. But to make an astrologer other thought-cells must be active enough to overcome the reluctance of those mapped by Neptune to learn how to handle the necessary astrological arithmetic.

Harmonious progressed aspects involving Neptune lead to vacations, outings and unusually pleasant experiences. Often a feeling akin to ecstasy is present. But even its more favorable aspects have a peculiar separative quality upon affectional relationships. The separation is not abrupt, as are those occasioned by Uranus, but quite gradual. Often there is a voluntary renouncement. Yet romantic attachments also may be formed.

The unfavorable events attracted by Neptune's discordant thought-cell activity usually have to do with unrealizable ideals formed by the individual, or to deliberate promotion schemes fostered to take advantage of him by others. Confidence men are represented by heavy afflictions involving Neptune; and less heavy afflictions indicate well-meaning promotion schemes which fail. Relative to the health, Neptune progressed aspects are present in all cases of poisoning, and by depressing the secretion of adrenalin and cortin they facilitate infection.

Neptune tends to exaggerate, and that which approaches under its progressed aspects always seems larger than later it turns out to be, except in those rare cases in which the individual, without effort, receives some amazing benefit. The big sweepstake and lottery winnings are almost always under Neptune aspects. But by far the most of the time big benefits that are promised turn out to be small benefits when realized. Threatened calamities, that cause vast worry and fear, either fail to arrive or on arrival are of minor consequence.

Imagination is active under Neptune thought-cell activity, and projects and plans that are attracted under discordant aspects tend to fizzle. Even those started under better aspects yield far less than anticipated. Usually what is promised by Neptune should be discounted by about 90%.

Progressed Aspects Involving Pluto

—Any progressed aspect involving Pluto affects through groups, through subtle force, and brings coercion or cooperation.

The thought-cells in the astral form mapped or ruled by Pluto are chiefly composed of thought-elements of the type which relate to cooperation. The events they attract are unique in their power to attract the individual to participation in group activity of some kind which is sure to meet opposition from some other group.

They express through the Universal Welfare Urges, and the things they attract into the life come through groups. The groups the Pluto thought-cells use their psychokinetic power to bring into the life may have for purpose some selfish advantage over others, or to benefit humanity. On its better side Pluto gives the impulse to work for Universal Welfare. But on its adverse side it tends to gangdom and racketeers.

It thus behooves an individual when progressed aspects involving Pluto are powerful, to use discrimination in joining forces with others, either those on the physical plane or those of the inner world. Under discordant progressed aspects an individual may become involved with the criminal underworld, be the object of kidnapers or be used as a tool by invisible racketeers. Yet under more harmonious progressed aspects there may be opportunity to join hands with others in an effort that is important for universal good.

No less than Uranus and Neptune, Pluto tends to stimulate interest in occult pursuits; and particularly has the power to connect up with intelligences on the inner plane. Under its thought-cell activity the individual may have the opportunity and the desire to do some spiritual work.

As do progressed aspects involving Uranus or Neptune, progressed aspects involving Pluto increase the sensitiveness of the nervous system and tend toward psychic experiences. The individual becomes unusually sensitive to the thoughts of those on either plane.

Progressed Aspects Involving M.C

—Any progressed aspect involving the M.C. affects the honor, the business and the publicity.

The thought-cells in the astral form mapped by the M.C. are chiefly those which act as amplifiers. Whether the birth chart M.C. or the progressed M.C., their activity attracts into the life events which influence the public standing. The type of event thus influencing publicity is determined by the characteristics of the planet involved in the aspect, and the department of life thus influencing publicity is indicated by the houses this planet rules. The business or honor also affects the departments of life indicated by the houses this planet rules.

Progressed Aspects Involving Asc

—Any progressed aspect involving the Asc. affects the health, the personality, and the personal affairs.

The thought-cells in the astral form mapped by the Asc. are chiefly those which act as a ground-wire through which the astral energy of the personality reaches the outside world. Whether the birth chart Asc. or the progressed Asc., their activity has much significance in matters of health and how the personality affects others who are brought directly into contact with it; and how the things or people indicated by the planet involved in the progressed aspect affect the health, the personality, and bring changes into the personal life.

The planet involved in the progressed aspect determines by its characteristics the manner in which the health and personality will be influenced, and the houses it rules indicate the departments of life thus affecting the personality, and affected by the personality.

Major Progressed Aspects of Moon Attract Only Sub-Major Events

—Because long observation indicates that on the average a progressed aspect made by the Moon attracts an event only 1/7 as important as that attracted by a similar progressed aspect made by one of the other eleven positions, it is customary to designate major progressed aspects made by the Moon as sub-major progressed aspects. Progressed aspects made by any of the other eleven positions to birth chart Moon, however, are on the average as powerful to attract events as those made to other birth chart planets.

Finding the Motion by Declination of Major, Minor or Transit Progressed M.C. or Asc.

—The M.C. and Asc. have the same motion by declination that the Sun has when in the same zodiacal sign, °, and ‘ and moving through the same number of °s and ‘s of zodiacal longitude.

Turn in an ephemeris to the date when the Sun is approximately the same sign, °, and ‘ of the zodiac occupied by the progressed M.C. or Asc.

Find (a) the daily motion in °s and ‘s of the Sun on that date by declination.

Find (c) the daily motion in °s and ‘s of the Sun on that date by zodiacal longitude.

Find (d) the °s and ‘s the M.C. or Asc. moves by zodiacal longitude on the Map. D., MED., or Transit Date, as explained on pages 61-62 of lesson No. 111.

By proportion, multiply (a) by (d) and divide the product by (c). This gives (b). By logarithms, add log. (a) to log. (d), and from the sum subtract log. (c). This gives log. (b). (b) thus found is the °s and ‘s the M.C. or Asc. moves by declination during the same major, minor or transit progression interval moved by the Sun. It is the daily motion by declination of the M.C. or Asc. on the Map. D., MED., or Transit Date.

Example 21: In chart 317, what is the motion by declination of major progressed Asc. on the Map. D. for 1925? The Limiting Date for this chart is Jan. 20, 1920. The Map. D. for 1925 is July 9, 1920. The progressed Asc. for this Map. D. is 18 Sagittarius 29, calculated according to the rule given on page 51 of lesson No. 111.

Looking in the ephemeris for the date when the Sun is near 18 Sagittarius 29, on Dec. 10, 1920, we find it 18 Sagittarius 09, with a declination of 22 S 55, and on Dec. 11, 1920, we find it 19 Sagittarius 10, with a declination of 23 S 00. The daily motion by declination is (a) 5’. The daily motion by zodiacal longitude is (c) 61’.

Now to find (d) we must make the calculation explained on pages 61-62 of lesson No. 111. In this problem we look at a table of houses for latitude 30 and find that the difference between the nearest and the next nearest Asc. to 18 Sagittarius 29 is (a) 48’. The difference in the same column between the nearest and the next nearest M.C. is (c) 60’. The Daily motion of the Sun on the Map. D. (July 9, 1920) is 57’. Multiplying (a) 48 by (d) 57 gives 2736. Dividing 2736 by (c) 60 gives (b) 46’ as the distance the Asc. moves while the Sun moves its 57’ on the Map. D. Thus 46’ becomes (d) of the main problem.

By proportion, multiplying (a) 5 by (d) 46 gives 230. Dividing 230 by (c) 61 gives (b) 4’. By logarithms, adding log. (a) 2.4594 to log. (d) 1.4956 gives 3.9550. Subtracting log. (c) 1.3730 from 3.9550 gives 2.5820, which is log. of (b) 4’. 4’ is thus the daily motion by declination of major progressed Asc. on the Map. D. for 1925.

Example 22: In chart 317, what is the motion by declination of major progressed M.C. on the Map. D. for 1951? The Limiting Date for this chart is Jan. 19, 1920. The Map. D. for 1951 is Aug. 4,

1920. The progressed M.C. for this Map. D. is 26 Libra 36, calculated according to the rule given on page 51 of lesson No. 111.

Looking for the date when the Sun is near 26 Libra 36, on Oct. 19, 1920, we find it 25 Libra 48, with a declination of 9 S 58, and on Oct. 20, 1920, we find it 26 Libra 48, with a declination of 10 S 20. The daily motion by declination is (a) 22'. The daily motion by zodiacal longitude is (c) 60'.

On the Map. D. (August 4, 1920) the daily motion of the Sun is 57'. As the M.C. moves at the same rate the Sun moves, the daily motion of the M.C.

(d) is also 57'.

By proportion, multiplying (a) 22 by (d) 57 gives 1254. Dividing 1254 by (c) 60 gives (b) 21'. By logarithms, adding log. (a) 1.8159 to log. (d) 1.4025 gives 3.2184. Subtracting log. (c) 1.3802 from 3.2184 gives 1.8382, which is the log. of (b) 21'. 21' is thus the daily motion by declination of major progressed M.C. on the Map. D. for 1951.

Finding the Calendar Date on Which a Parallel Aspect Involving Major Progressed M.C. or Asc. is Perfect

—Find the declination in °s and 's occupied by the progressed M.C. or Asc. on the Map. D. If the aspect is to a birth chart planet, find its birth chart declination; but if it involves a progressed planet find the ° and ' of declination occupied by the planet on the Map. D.

From the daily motion by declination of the M.C. or Asc. on the Map. D., and the daily motion of the planet by declination on the Map. D., find (a) the gain of the one on the other in °s and 's. If the aspect is from progressed M.C. or Asc. to a birth chart position, (a) is the daily motion by declination of M.C. or Asc.

Find (b), the °s and 's the parallel aspect is from perfect on the Map. D.

Then work the problem exactly as if finding the calendar date on which a major progressed aspect between planets is perfect, as explained on pages 54-55 of lesson No. 111.

Example 23: Find the date on which in chart 317 progressed Asc. makes the parallel with Venus p. On Map. D. for 1925 (ephemeris date July 9, 1920) Venus is declination 22 N 58. On page 66 we found that on this same Map. D. progressed Asc. is declination 22 S 57. The aspect is thus (b) 1' from perfect on the Map. D. The ephemeris on July 9, 1920, shows Venus decreasing declination at the rate of 9' per day. We found in example 21 that the daily motion of the Asc. by declination is 4'. As Venus is decreasing in declination and Asc. (as shown by Sun when in same zodiacal degree) is increasing in declination, we add 9' to 4' which gives the daily gain (a) as 13'.

By proportion, multiplying (b) 1 by (c) 12 gives 12. Dividing 12 by (a) 13 gives the calendar interval (d) as 12/13 months, or 28 days. By logarithms, subtract log. (a) 2.0444 from log. (b) 3.1584, and it gives 1.1140 which is the log. of (d) 1h 51m, or 111m. Dividing 111 by 4 gives 28 days.

Adding this 28 days to January 19, 1925 (for which July 9, 1920, is Map. D.), gives progressed Asc. parallel Venus p Feb. 17, 1925.

Example 24: Find the date on which in chart 317 progressed M.C. is parallel Uranus r. Uranus r has declination 10 S 15. On Map. D. for 1951 (Aug. 4, 1920) on page 66 we found progressed M.C. has declination 10 S 16. The difference is (b) 1'. In Example 22 we found the daily motion of the M.C. by declination on this Map D. to be (a) 21'.

By proportion, multiplying (b) 1 by (c) 12 gives 12. Dividing 12 by (a) 21 gives the calendar interval (d) as 12/21 months, or 17 days. By logarithms, subtracting log. (a) 1.8361 from log. (b) 3.1584 gives 1.3223 which is the log. of (b) 1h 9m, or 69 minutes. Dividing 69 by 4 gives 17 days.

As progressed M.C. has passed the aspect on the Map. D., we subtract the 17 days from January 19, 1951. Thus major progressed M.C. is parallel Uranus r January 2, 1951.

Calculating Aspects Made by Major Progressed Moon

—In order that the type and harmony or discord of the important inner-plane weather may be known far enough in advance that proper precautionary actions may be taken, all major progressed aspects other than those made by the Moon should be calculated and tabulated for a number of years ahead. And major progressed aspects made by the Moon should be calculated and tabulated at least one year ahead so that adequate precautionary actions may be taken relative to the accessory energy they may add to the inner-plane weather indicated by major progressed aspects of the other planets when progressed Moon makes an aspect to a terminal of one of these other major progressed aspects.

To facilitate calculating the major progressed aspects of the Moon for a period of one year, and not inadvertently overlooking some important aspect, in addition to the birth chart positions, including all declinations, it is well to write on the chart both the sign, °, and ‘ and the declination of the major progressed M.C. and major progressed Asc. calculated for the two consecutive Map. D.s between which the progressed Moon calculations are to be made. Each of these Map. D.s represents the Limiting Date within a given calendar year. The difference between the sign, °, and ‘ of the progressed M.C. or Asc. on one Map. D. and the next Map. D. represents its progressed zodiacal motion during the corresponding year, and the difference between the declination of the M.C. or Asc. on one Map. D. and the next Map. D. represents its progressed motion by declination during the corresponding year. The zodiacal motion and the motion by declination of each of the planets between the two successive Map. D.s show their motion by progression during the corresponding year. And as the positions of the planets in the ephemeris on the Map. D. show their positions for the L.D. within the corresponding calendar year, the calculations should start with the Map. D. and the calendar date within the year indicated by the L.D.

In calculating the major progressed aspects of the Moon for a year it facilitates the work to start with the L.D. within one calendar year and before making the calculations tabulating one after another in the succession in which they form, all the aspects made by the Moon up to the L.D. of the following calendar year. The aspects thus start with one Map. D. and end with the following Map. D., the daily motion of all the planets between these two Map. D.s being their major progression during the given year. Because the Moon's daily motion is so great it is much easier to calculate its progressed aspects by logarithms than by proportion. However, both methods will here be illustrated.

We will start with calendar date May 12, 1959, using Chart 2a on page 68, which has the major progressed positions around it for this date. The Map. D. (date in the ephemeris) is May 21, 1920. On May 21, 1920, the daily motion of the Moon is (a) $14^{\circ} 36'$. The log. of this, which will be used for all aspects of the Moon to birth chart positions, is .2159. Dividing $14^{\circ} 36'$ by 12 gives the motion of the Moon per month by major progression as $1^{\circ} 13'$, or $73'$ in 30 days.

1. Moon parallel Neptune p: The Moon is decreasing in declination (a) $2^{\circ} 51'$ per day. $1/12$ of this is $14'$, the amount of progression per month. Neptune p has declination $18^{\circ} N 00'$. The Moon has declination $18^{\circ} N 01'$. The difference is (b) $1'$. $1/14$ of 30 days is 2 days.

By logarithms, subtracting log. of $2^{\circ} 51'$ (a) .9254 from log. (b) 3.1584 gives 2.2330, which is the log. of (d) 8m. Dividing 8 by 4 gives 2 days. Adding the 2 days found by either method to May 12, 1959, gives Moon parallel Neptune p May 14, 1959.

2. Moon inconjunct Asc. r: To reach this aspect the Moon must move (b) $19'$ to $15^{\circ} Leo 49'$. $19/73$ of 30 days is 8 days.

By logarithms, subtracting log. of $14^{\circ} 36'$ (a) .2159 from log. (b) 1.8796 gives 1.6637, which is the log of (d) 31m. Dividing 31 by 4 gives 8 days. Adding the 8 days found by either method to May 12, 1959, gives Moon inconjunct Asc. r May 20,

3. Moon sextile Venus p: To reach this aspect the Moon must close a gap of (b) $2^{\circ} 52'$. Subtracting the $1^{\circ} 13'$ Venus moves from the $14^{\circ} 36'$ the Moon moves gives the daily gain (a) $13^{\circ} 23'$. Dividing this by 12 gives the gain per month as $1^{\circ} 07'$. In 2 months the gain is $2^{\circ} 14'$. This leaves $38'$. $1^{\circ} 07'$ is $67'$. $38/67$ of 30 days is 17 days.

By logarithms, subtracting log. of $13^{\circ} 23'$ (a) .2536 from log. of $2^{\circ} 52'$ (b) .9228 gives .6692, which is the log. of (d) 5h 08m. Dividing 5 by 2 gives 2mo with 60m remainder. Adding this remainder to the 08m gives 68m. Dividing the 68m by 4 gives 17 days. Adding the 2 months 17 days found by either method to May 12, 1939, gives Moon sextile Venus p July 29, 1959.

4. Moon sesqui-square M.C. r: To reach this aspect the Moon must move (b) $3^{\circ} 47'$ to 19 Leo 17. At $1^{\circ} 13'$ per month this takes 3 months with $8'$ remainder. $8/73$ of 30 days is 3 days.

By logarithms, subtracting log. of $14^{\circ} 36'$ (a) .2159 from log. (b) .8023 gives .5864, which is the log. of (d) 6h 13m. Dividing the 6 by 2 gives 3mo. Dividing the 13 by 4 gives 3d. Adding the 3 months, 3 days found by either method to May 12, 1959, gives Moon sesqui-square M.C. r August 15, 1959.

5. Moon sesqui-square Uranus r: To reach this aspect the Moon must move (b) $3^{\circ} 51'$. In 3 months it moves $3^{\circ} 39'$. To move the additional $12'$ takes $12/73$ of 30 days, or 5 days.

By logarithms, subtracting log. (a) .2159 from log. (b) .7947 gives .5788, which is the log. of (d) 6h 20m. Dividing 6 by 2 gives 3mo. Dividing 20 by 4 gives 5d. Adding the 3 months, 5 days found by either method to May 12, 1959, gives Moon sesqui-square Uranus r August 17, 1959.

6. Moon sesqui-square Saturn p: To reach this aspect the Moon must close a gap of (b) $4^{\circ} 30'$. Saturn moves $2'$ and the Moon moves $14^{\circ} 36'$. The difference is the daily gain (a) $14^{\circ} 34'$. Dividing this by 12 gives the gain per month as $1^{\circ} 13'$, or $73'$. In 4 months it moves $4^{\circ} 52'$. To move the $22'$ it has gone too far, takes $22/73$ of 30 days or 9 days. To make the aspect thus takes 3 months, 21 days.

By logarithms, subtracting log. (a) .2168 from log. (b) .7270 gives .5102, which is the log. of (d) 7h 25m. Dividing the 7 by 2 gives 3mo with a remainder of 60m. Adding the 60m to the 25m gives 85m. Dividing 85 by 4 gives 21d. Adding the 3 months, 21 days found by either method to May 12, 1959, gives Moon sesqui-square Saturn p September 3, 1959.

7. Moon semi-square Saturn r: To reach this aspect Moon must move (b) $4^{\circ} 50'$. In 4 months the Moon moves $4^{\circ} 52'$. To move the $2'$ it has gone too far, takes $2/73$ of 30 days, or 1 day. It thus makes the aspect in 3mo, 29d.

By logarithms, subtracting log. (a) .2159 from log. (b) .6960 gives .4801, which is the log. of (d) 7h 57m. Dividing the 7 by 2 gives 3mo, with 60 remainder. Adding the 60m to the 57m gives 117m. Dividing the 117 by 4 gives 29d. Adding the 3 months, 29 days found by either method to May 12, 1959, gives Moon sesqui-square Saturn r September 11, 1959.

8. Moon sesqui-square Uranus p: To reach this aspect the Moon must close a gap of (b) $5^{\circ} 01'$. Uranus moves $1'$ and the Moon moves $14^{\circ} 36'$. The difference is the daily gain (a) $14^{\circ} 35'$. Dividing this by 12 gives the gain per month as $1^{\circ} 13'$, or $73'$. In 4 months the Moon moves $4^{\circ} 52'$. To move the other $9'$ takes $9/73$ of 30 days, or 4 days.

By logarithms, subtracting log. (a) .2164 from log. (b) .6798 gives .4634, which is the log. of (d) 8h 15m. Dividing the 8 by 2 gives 4 mo. Dividing the 15 by 4 gives 4d. Adding the 4 months, 4 days found by either method to May 12, 1959, gives Moon sesqui-square Uranus p September 16, 1959.

9. Moon square Mars p: To reach the aspect the Moon must close a gap of (b) $6^{\circ} 29'$. Mars is moving retrograde $9'$, and the Moon is moving $14^{\circ} 36'$. To find the daily gain we add the two motions which gives (a) $14^{\circ} 45'$. Dividing by 12 gives the gain per month as $1^{\circ} 14'$, or $74'$. In 5 months the gain is $6^{\circ} 10'$. This leaves $19'$. $19/74$ of 30 days gives 8d.

By logarithms, subtracting log. of $14^{\circ} 45'$ (a) .2114 from log. (b) .S684 gives .3570, which is the log. of (d) 10h 33m. Dividing the 10 by 2 gives 5mo. Dividing the 33 by 4 gives 8d. Adding the 5 months, 8 days found by either method to May 12, 1959, gives Moon square Mars p October 20, 1959.

10. Moon square Sun r: To reach this aspect the Moon must move (b) $6^{\circ} 41'$. In 5 months the Moon moves $6^{\circ} OS'$. This leaves $36'$. $36/73$ of 30 days gives 15 days.

By logarithms, subtracting log. (a) .2159 from log. (b) .5552 gives .3393, which is the log. of (d) 10h 59m. Dividing the 10 by 2 gives 5mo. Dividing the 59 by 4 gives 15d. Adding the 5 months, 15 days found by either method to May 12, 1959, gives Moon square Sun r October 27, 1959.

11. Moon square Asc. p: To reach this aspect the Moon must close a gap of (b) $6^{\circ} 48'$. The Asc. is moving (see chart) $1^{\circ} 41'$ and the Moon is moving $14^{\circ} 36'$. The difference is (a) $12^{\circ} 55'$. Dividing this by 12 gives a gain of $1^{\circ} 05'$ per month. In 6 months the gain would be $6^{\circ} 30'$. This leaves $18'$. $1^{\circ} 05'$ equal $65'$. $18/65$ of 30 days gives 8 days (not so precise as by logarithms, as the gain is a trifle less than $1^{\circ} 05'$ per month).

By logarithms, subtracting log. (a) .2691 from log. (b) .5477 gives .2786, which is the log. of (d) 12h 38m. Dividing the 12 by 2 gives 6 mo. Dividing the 38 by 4 gives 9d. Adding the 6 months, 9 days so found to May 12, 1959, gives Moon square Asc. p November 21, 1959.

12. Moon parallel Venus p: To reach this aspect the Moon must close a gap of (b) $1^{\circ} 42'$. The Moon is decreasing $2^{\circ} 51'$, and Venus is increasing $22'$. To find the gain we add these two motions which gives (a) $3^{\circ} 13'$. Dividing $3^{\circ} 13'$ by 12 gives a gain of 16 per month. The gain in 6 months is $1^{\circ} 36'$. This leaves $6'$. $6/16$ of 30 days gives 11 days (not so precise as by logarithms, as the gain is a trifle more than 16' per month).

By logarithms, subtracting log. (a) .8728 from log. (b) 1.1498 gives .2770, which is the log. of (d) 12h 41m. Dividing the 12 by 2 gives 6mo. Dividing the 41 by 4 gives 10d. Adding the 6 months, 10 days thus found to May 12, 1959, gives Moon parallel Venus p November 22, 1959.

13. Moon parallel Asc. r: To reach this aspect the Moon must move by declination (b) $1^{\circ} 55'$ (Asc r is 16 5 06). By declination the Moon moves (a) $2^{\circ} 51'$. Dividing this by 12 gives $14'$ per month. In 8 months the Moon moves $1^{\circ} 52'$. This leaves $3' \frac{3}{14}$ of 30 days gives 6 days (not as precise as by logarithms, as Moon moves a trifle more than $14'$ per day).

By logarithms, subtracting log. (a) .9254 from log. (b) 1.0977 gives .1723, which is the log. of (d) 16h 08m. Dividing the 16 by 2 gives 8mo. Dividing the 8 by 4 gives 2d. Adding the 8 months, 2 days thus found to May 12, 1959, gives Moon parallel Asc. r January 14, 1960.

14. Moon trine Mercury r: To reach this aspect the Moon must move (b) $9^{\circ} 50'$. In 8 months the Moon moves $9^{\circ} 44'$. This leaves $6'$. $6/73$ of 30 days gives 2 days.

By logarithms, subtracting log. (a) .2159 from log. (b) .3875 gives .1716 which is the log. of (d) 16h 10m. Dividing 16 by 2 gives 8mo. Dividing 10 by 4 gives 2d. Adding the 8 months, 2 days found by either method to May 12, 1959, gives Moon trine Mercury r January 14, 1960.

15. Moon sextile Mercury p: To reach this aspect the Moon must close a gap of (b) $9^{\circ} 04'$. Subtracting the motion of Mercury, $2^{\circ} 09'$, from the motion of the Moon, $14^{\circ} 36'$, gives the daily gain (a) $12^{\circ} 27'$. Dividing this by 12 gives the monthly gain of the Moon as $1^{\circ} 02'$. In 9 months the Moon thus gains $9^{\circ} 18'$, which is $14'$ too much. $1^{\circ} 02'$ are $62'$. $14/62$ of 30 days gives 7 days. 7 days subtracted from 9 months gives 8 months, 23 days (not as precise as by logarithms, as Moon gains a trifle more than $1^{\circ} 02'$ per month).

By logarithms, subtracting log. (a) .2850 from log. (b) .4228 gives .1378, which is the log. of (d) 17h 28m. Dividing 17 by 2 gives 8mo, with 60m remainder. Adding the 60m to the 28m gives 88m. Dividing the 88 by 4 gives 22d. Adding the 8 months, 22 days to May 12, 1959, gives Moon sextile Mercury p February 4, 1960.

Finding the Declination of Major, Minor or Transit Progressed M.C. or Asc. for Any Given Calendar Date

First find the sign, ° and ‘ of progressed M.C. or Asc. for the given calendar date. As any house cusp has the same declination as does the Sun when in the same sign, ° and ‘, then find the declination of the Sun when in the indicated sign, ° and ‘. This is the declination sought.

Major progressed Asc. of chart No. 317 on Jan. 19, 1925, is 18 Sagittarius 29. Looking in the ephemeris for the Sun close to this place, on Dec. 10, 1920, we find it 18 Sagittarius 09, and on Dec. 11, 1920, we find it 19 Sagittarius 10, and thus moving daily (c) 61’ by zodiacal longitude. The difference between 18 Sagittarius 09 and 18 Sagittarius 29 is (d) 20’. The Sun is increasing daily (a) 5’ by declination. Multiplying (a) 5 by (d) 20 gives 100. Dividing 100 by (c) 61 gives (b) 2’ to be added to the 22 S 55 declination of the Sun on Dec. 10, giving the declination of major progressed Asc. on Jan. 19, 1925, as 22 S 57.

Major progressed M.C. of chart No. 317 on Jan. 19, 1951, is 26 Libra 36. Looking in the ephemeris for the Sun close to this place, on Oct. 19, 1920, we find it 25 Libra 48, and on Oct. 20, 1920, we find it 26 Libra 48, and thus moving daily (c) 60’ by zodiacal longitude. The difference between 26 Libra 48 and 26 Libra 36 is (d) 12’. The Sun is increasing daily (a) 22’ by declination. Multiplying (a) 22 by (d) 12 gives 264. Dividing 264 by (c) 60 gives (b) 4’ to be subtracted from the 10 S 20 declination of the Sun on Oct. 20, giving the declination of major progressed M.C. on Jan. 19, 1951, as 10 S 16.

The table on page 162 of lesson No. 115 facilitates this calculation.

Chapter 4

Serial No. 113
Original Copyright 1934
Elbert Benjamine

Copyright
Church of Light
August 2002

Major Progressions of the Planets

Know Your Inner-Plane Weather in Advance

To have the knowledge on which to base proper precautionary actions, you should at all times have calculated and set down in chronological order all your major progressed aspects for several years ahead. This record of when aspects will be perfect should be kept in a convenient place and consulted frequently.

Before each of these aspects comes within its one degree of effective orb you should also calculate and set down the precise date it thus comes within the one degree of perfect. At one degree from the perfect aspect the inner-plane weather thus indicated is one-half as powerful as when the aspect is perfect, it increases in power until the aspect is perfect, then decreases until the aspect is one degree past perfect, when it again has half its peak power. Either before or after it is one degree from perfect its influence is negligible. But during the whole period it is within one degree of perfect, precautionary actions should be taken.

During the period when each important major progressed aspect is within the one degree of effective orb you should keep informed a month or two ahead, just when minor progressed aspects forming to one of its four terminals will reinforce its power-they thus reinforce all the time they are within one degree of perfect-and make it more likely at that time to attract an event of the character of the major progressed aspect. While such reinforcing energy is present, special precautionary actions should be taken.

Chapter 4

Major Progressions Of The Planets

ASIDE from the type of inner-plane weather indicated by the planets involved in a progressed aspect, each aspect indicates weather that tends to cause the thought-cells it influences to use their psychokinetic power to influence the thoughts, behavior and the events that come into the life toward the distinctive trend indicated by the keyword of the aspect. The conjunction, parallel and inconjunct involving Venus or Jupiter are favorable, involving Mars or Saturn are unfavorable, and not involving one of these four planets, are neutral. The trine, sextile and semi-sextile between any two planets are favorable, but the opposition, square, semi-square and sesqui-square are unfavorable. The progressed aspect thus indicates positively whether the inner-plane energy is favorable or unfavorable.

But whether the thought-cells thus influenced will use their psychokinetic power to bring fortunate or unfortunate events into the life depends upon how they feel. If through birth chart harmony or discord, or through harmony or discord imparted to them since birth, they have been conditioned strongly enough to desire events and conditions that are favorable or unfavorable, the influence of the inner-plane weather mapped by a progressed aspect may not be powerful enough markedly to change this desire. And in that case the inner-plane weather may merely supply the energy to enable the thought-cells to bring into the life an event which is of opposite fortune to that commonly indicated by the progressed aspect.

The thought-cells of each planetary type can express characteristically through constructive thoughts and behavior or through destructive thoughts and behavior. To the extent their energy is channeled into their type of constructive thoughts and behavior does it decrease their power to influence their type of destructive thoughts and behavior. And as what happens to the individual often is markedly influenced by what he does, to the extent thoughts typical of the planet enter his mind and to the extent there are actions typical of the planet, under any progressed aspect involving the planet, whether harmonious, neutral or discordant, it is the part of wisdom to see to it they are typical of its constructive expression.

It is important to bear in mind that it is not the inner-plane weather mapped by an aspect which determines the fortune or misfortune of the event or condition coincident with it. Instead, it is the desires of the thought-cells receiving new energy from the inner-plane weather. And if enough harmony can be added to them through harmonious thinking and feeling, in spite of any inner-plane weather or outer-plane condition, they will work for fortunate events. The details of thus using mental antidotes, conversion and rallying forces harmoniously to recondition the desires of the thought-cells are set forth in lesson No. 110.

However, the psychokinetic power of the thought-cells is, on the average, only about one-half of the influence that determines the events that come into the life. Physical environment is commonly equally important. The physical environment may be such that when a progressed aspect forms the thought-cells need exert only a little psychokinetic energy to bring the event they want into the life, or it may be such that any amount of psychokinetic energy cannot bring the event they want into the life. What happens is not the exclusive result of the psychokinetic power of the thought-cells working for what they desire, and it is not the exclusive result of the physical environment. It is the algebraic sum of the psychokinetic power brought to bear minus the resistance of physical environment to that power. Therefore, in taking precautionary actions, if what the thought-cells desire is also what the individual desires, he should do all he can to arrange the physical environment so they will have to use a minimum of psychokinetic energy to bring the event or condition they desire into the life. But if what the thought-cells desire is what the individual does not desire, he should do all he can to arrange the physical environment so that no matter how much psychokinetic energy they bring to bear they cannot bring into the life the event or condition they desire.

What to Do Under Unfavorable Progressions Involving the Sun

—To attract a more fortunate event than that otherwise indicated it is necessary that the thought-cells in the astral body at each end of the stellar aerial mapped by the progressed aspect shall receive energy generated by the voluntary thoughts and feelings of such volume and harmony that they feel this energy more vividly than they feel the planetary energy coming in over the aerial mapped by the discordant aspect. And to reach the Sun terminal and influence its thought-cells harmoniously, those thoughts and feelings must be associated with thoughts of dignity, courage, calm self-assurance, control and stamina.

When there are unfavorable progressions involving the Sun the power of the individual to mold affairs is in danger of being weakened by the discord stirred up among these controlling thought-cells. And because these thought-cells are intimately associated with the nerve currents and provide the electric vitality of the body, if they are permitted to do so they may become Rallying Forces that extend their influence into other departments of life than those reached by the aerial mapped by the aspect involving the Sun.

If the aspect involves a negative planet, thoughts and actions should be cultivated which are positive, and thus when harmoniously associated with thoughts of dignity, self-esteem, courage, control and stamina, tend to prevent depletion of the vital energy of the solar dynamic structure. But if the aspect involves a planet that tends toward unusual expansiveness and expenditure, the thoughts which should be held harmoniously in the mind in association with those of dignity, self-esteem, courage, and stamina should be those of deliberate control and calm confidence.

Unusual care should be given to dealing with the male sex, to political influences, to the attitude of those above one in station, to things affecting the honor and self-esteem, and especially as affecting the departments of life indicated by the houses in which the Sun and the other planet involved in the aspect are located.

When I say care, I do not mean fright. One of the most disastrous of human experiences is to be unwilling to face any condition that may come and carry on in spite of it.

I merely mean that far more foresight, skill and initiative are required at such a time than is customary to bring the same type of thing to a successful issue. Perhaps such scrutiny will bring the decision to abandon some attempt, or to write off as a loss something without carrying it further.

The Sun has no natural mental antidote, but the Religious thoughts are unusually potent when held in association with the Power thoughts. Whatever the thoughts are that are thus selected to be held in the mind at the same time as thoughts of power, of confidence and of ability to handle whatever situation arises, they must be held with a glow of enthusiasm. It is their harmony that must be depended upon to counteract the planetary discord being received.

What to Do Under Unfavorable Progressions Involving the Moon

—Because the thought-cells within the astral body mapped by the Moon in the birth chart, and by the progressed Moon, are so directly in contact with the magnetic energies of the electromagnetic form which determine the strength of the constitution and influence the nerve currents, progressed aspects involving the Moon are unusually significant. If given the opportunity, through the person responding in feeling to their influence, they readily become Rallying Forces which, reaching the other temporary stellar aeries and flowing over them into the other compartments of the astral body, may have an influence over many departments of life.

The thought-cells of which the dynamic stellar structure mapped by the Moon chiefly is composed have had their origin in experiences with domestic life. Sympathy for the weak and helpless, for those in distress, and such impulses as relate to the preservation of the home and care for the family, and in a wider sense care for people everywhere who are less fortunate, or even care for plants and animals, are the type of feelings that directly reach the thought-cells of the Moon dynamic structure within the astral body. Any thoughts, therefore, the purpose of which is to give so much harmonious energy to these stellar cells that the discordant energy reaching them from the planets is displaced, must be associated with sympathetic feelings of this kind.

Harmonious thinking and feeling in general, because the temporary stellar aerial having the Moon dynamic structure at one terminal is so open to reception, if associated with such feeling of desire and effort to minister to the welfare of others, tends to correct the discord of a progressed aspect involving the Moon. But the most effective thoughts and feelings for this purpose are of the Aggressive type ruled by Mars, which are the natural antidote.

In applying Mars thoughts and feelings care must be exercised that these express the constructive rather than the destructive tendencies. The energies received from a progressed aspect involving the Moon tend toward negativeness, receptivity and emotion. To apply the Aggressive thoughts successfully the feeling of positive constructive work must be maintained in association with the protection and welfare of others.

Irritation, anger, and other discordant thoughts only add increasing discord to the Domestic thought-cells. Negativeness and the feeling of frustration do likewise. But if a positive, yet constructive attitude is held, and the efforts are directed toward helping the weak or less fortunate, or toward protecting them, these harmonious thought energies will transform the Domestic thought compound into a compound the stellar cells of which will work from the inner plane to attract fortunate events.

Under unfavorable progressed aspects involving the Moon the health, contacts with women, relations with the public, the attitude of the mind, and those things indicated by the house position of the Moon and the other planet involved in the aspect should receive special attention.

What to Do Under Unfavorable Progressions Involving Mercury

—The progressed aspects involving Mercury, as well as those involving Sun and Moon, add energy to stellar cells which have intimate contact with the electromagnetic form and the nerve currents. The nerve currents are largely directed by the objective thoughts which Mercury rules. And it is the natural function of these thoughts to tune electrical energies of the nervous system in temporarily on the frequency corresponding to the thoughts that thus gain attention. Thus the energies of Mercury commonly act as Rallying Forces, quite as strongly as those of Sun or Moon, to influence not merely the thought-cells at the terminals of the temporary stellar aerial mapped by the aspect, but also to find their way into, and add their energy to, the terminals of other temporary stellar aerials which may be present.

Progressed aspects involving Mercury tend to give intensity and volume to thinking. When this thinking is too concentrated over a period of time, or is about unpleasant conditions, it causes great tension of the nervous system, and gives the thought-cells at the terminals of the temporary stellar aerial discordant energy which enables them to attract unfortunate events into the life.

The house occupied by Mercury and the house occupied by the other planet involved in the aspect, together with the nature of that planet determine the type of thinking. Often the same train of thoughts, or those of similar context, is thought over and over again. Instead of such waste of mental energy, whatever problem is present should be thought through thoroughly and then dismissed by turning the attention to something else.

Good ideas and valuable discoveries often come under an unfavorable progressed aspect involving Mercury, and as good progress in study, in writing, or in other mental pursuits can be made under an unfavorable progressed aspect involving Mercury as can be made under a favorable progressed aspect. But if the ideas are expressed, writing is submitted for publication, or other persons are depended upon, the effect of the discord becomes quickly apparent.

Under an unfavorable progression involving Mercury only thoughts should be permitted which are pleasant and which move forward to some purpose. Clerical and other errors and slight mistakes should be guarded against, and especial care should be exercised as to the exact purport of any document which is signed. What is said to others also may be subject to misinterpretation.

The natural antidote, and thus the best type of thoughts to associate with the Intellectual activities at such a time are Religious thoughts. This does not signify one must turn to religion; but the optimism and confidence of Jupiter that all will work out as desired should be cultivated. The reliance on a higher power than human intelligence, after human intelligence has done its best, is an attitude which adds harmony to the thought-cells influenced by Mercury in the most potent form.

What to Do Under Unfavorable Progressions Involving Venus

—The progressed aspects involving Venus add energy to the thought-cells which relate to the affections, and if this energy is discordant the thought-cells thus given psychokinetic power bring events into the life that cause disappointment and grief through those toward whom there is, or it is desired there should be, a bond of attachment.

Under an unfavorable progression involving Venus slights, either real or fancied, are apt to arise. Perhaps events over which no one seems to have any control will, for the time being, cause conditions that stir up grief and emotion. The less attention the individual pays to slights during such a period the better. Whether intentional or not, and whether caused by unavoidable conditions or not, the discords of Venus thrive on emotional perturbation. The best procedure, therefore, is to invoke the aid of the Safety thoughts, ruled by Saturn, and also sufficient of the Power thoughts, ruled by the Sun.

The Safety thoughts, which give a cold appraisal of circumstances, and are under the dominion of reason and quite apart from emotion, are the natural antidote for the Social thoughts of Venus. That is, they enter into the Social thought-cells in the astral body most readily in the formation of a highly beneficial compound. And the realization that the less emotion permitted the less misfortune will be experienced, is an easy way to apply these Safety thoughts. Pleasure should be felt in this conquest of emotion by cold reason.

Because Venus is the planet of joy and mirth, as well as of art, music and social pleasure, one who has considerable resolution, and can call forth the stamina and self-esteem of the Power thoughts to overlook emotional hurt, often can make even severely unfavorable progressed aspects involving Venus subject to Conversion (see lesson No. 110), and thus gain much benefit from them.

What to Do Under Unfavorable Progressions Involving Mars

—As a progressed aspect involving Mars is always present when an accident takes place, and when an infection is contracted, and as it is the planet of haste and strife, the least exposure to danger and infection, and the greater the avoidance of haste and strife, within reason, the better. Often, under such discord a fight is thrust upon one in such a manner that measures for self protection become necessary.

We cannot say that because Mars is involved in an unfavorable progressed aspect that an ill person should not have an operation. Not infrequently such an operation is the only measure that will save the life. And either a favorable or an unfavorable progressed aspect involving Mars is always present at the time of a surgical operation. Nor can we lay down a blanket rule that a person under an unfavorable aspect involving Mars should refuse to fight, as it may be the only manner in which invasion of his rights can be prevented. But if conditions permit the operation to be postponed, and if the individual can avoid a fight without too great sacrifice, it is better to wait for more favorable progressed aspects under which to solve such difficulties.

Under unfavorable progressions involving Mars it is better to avoid danger; but if danger comes, as it often does, to face it with courage, resolution and calmness is the best way to mitigate its effect. Machines and mechanical contrivances are apt to break or get out of order more readily than usual. Fire hazards increase, and too great energy expenditures threaten.

Haste, impulse, and too great activity should be guarded against. But as Mars is a Social planet, the relations with people are even more commonly a source of difficulty. Pains should be taken not to say or do that which causes offense or which will lead to strife, unless it has calmly been decided upon that strife is the only proper course to pursue.

Because Aggressive thoughts will come so spontaneously into the mind no special effort toward associating other thoughts with them is necessary. The Domestic thoughts are the natural antidote, and the best way of applying them is merely to interest oneself as thoroughly as possible in helping those who are weak and in distress. This maternal attitude and the actions springing from it, if sufficiently encouraged, will generate the thought-elements which, if pleasure is felt in them, will combine with the Aggressive thoughts in the astral body to form a more fortunate compound. The more such thoughts of helping others tend to displace the discordant thoughts of strife the more favorable the events which will be attracted by the progressed aspect. Under Mars inner-plane weather cultivate patience and take it easy.

What to Do Under Unfavorable Progressions Involving Jupiter

—Self-indulgence, extravagance, unwise optimism, too great generosity, unwillingness to consider the cost, and unwarranted business expansion are the chief things which an unfavorable progression involving Jupiter tends to attract.

All these things are attracted due to lack of careful analysis of the situation, the reliance upon chance or the opinions of others, or on the good offices of others. Sometimes even too great enthusiasm to present one's religious opinions may cause difficulty.

But whatever the discord that a progressed aspect involving Jupiter brings, basically it is due to lack of Intelligence. The house position of Jupiter and of the other planet involved in the aspect indicate the departments of life chiefly affected; but in general, as Jupiter is a Business planet, the finances also need attention. And the kind of attention most needed is to cultivate a pleasure in carefully analyzing and appraising by the most conservative methods every transaction which is entered into, especially those indicated by the progressed aspect.

The Intellectual thoughts are the natural antidote to the thought-elements given activity by Jupiter progressed aspects; and by taking pleasure in applying intelligence and care to the activities is the best method of converting them into a compound which will attract fortunate events.

What to Do Under Unfavorable Progressions Involving Saturn

—The trend of the thoughts under an unfavorable progression involving Saturn is to look upon the dark side of things. The planetary vibrations received by the thought-cells at the terminals of the temporary stellar aerial are heavy, morose, self-centered and lacking in buoyancy and elasticity; imparting to these cells a feeling which causes them to work from the inner plane to attract want, responsibility and loss.

These vibrations are negative, and to correct this negativeness, and prevent the development of fear, timidity and the tendency to worry, the Power thoughts of the Sun should be cultivated by holding thoughts of courage, determination and stamina. But of even more benefit, as they are the natural antidote for the Safety thoughts of Saturn, a deliberate effort should be made to encourage the Social thoughts.

Safeguarding the interests through positive action, rather than through negative fear, frequently is necessary under afflictions involving Saturn. That is, commonly it is unwise to press into activity the departments of life influenced by an unfavorable progressed aspect involving Saturn during the time the aspect is within the one degree of effective orb; but rather to turn for the time being to other, and less discordant interests.

Because Saturn thoughts are so insistently present, weighing down the personality, no special effort is necessary to cause them to associate with other thoughts and feelings that may be cultivated. Yet social contacts and other Venus activities are of no value unless the light-heartedness and gaiety of Venus are experienced. It may require great fortitude, when things apparently are going to pieces, and even social slights and financial losses may be in the offing, to mix with people, to dance, sing, go to the movies, make merry and take joy in art and music. But there is nothing better to drive away the Saturn blues, and nothing better to add happy thought-elements to the Safety thought compounds in a manner which most readily transforms them into a dynamic stellar compound which attracts good fortune. Under Saturn inner-plane weather keep your chin up and cultivate cheerfulness.

What to Do Under Unfavorable Progressions Involving Uranus

—Uranus, as octave of Mercury, has direct access to the electromagnetic form through the nerve currents; and its discords tend to unusually high tension of the nervous system, and to depletion of the electromagnetic energy. In particular it opens the gate to outside influences, notably those of people, who often gain at such times, through hypnotic effect, mental influence, or through misplaced confidence, altogether too great control over the life.

If this be recognized, that attachments made under progressed aspects involving Uranus seldom are lasting, and that such misfortune as the influence brings is in some manner due to a human agency, it will enable the individual to guard against difficulties. It is the sudden and unexpected which happens under progressed aspects involving Uranus.

New contrivances, such as radios, automobiles, and intricate machines, especially those depending in some manner on electricity, tend to get out of order under unfavorable progressions involving Uranus.

All attachments made during such a progression should be subject to certain reservations. Yet excellent progress in astrology and the occult sciences can be made under even heavy unfavorable progressed aspects involving this planet. An aspect involving Uranus favors gaining new information; and as a result of such new information the viewpoint often is changed.

The natural antidote for an unfavorable Uranus is the same as for an unfavorable Mercury. What has been said as to applying the Religious thoughts to counteract a discordant Mercury applies with equal force to transforming a Uranian thought-compound into one of more fortunate trend.

What to Do Under Unfavorable Progressions Involving Neptune

—An unfavorable progression involving Neptune requires the same cultivation of the Safety thoughts as that prescribed for its octave, Venus. But in addition, because it is so much more negative and sensitive, the Power thoughts should receive even more consideration. Courage, stamina, positiveness and determination are especially required to offset the shrinking sensitiveness and the dreaminess which the vibrations of Neptune encourage.

Such discord tends to attract schemes which work to the detriment of the individual. Imaginary advantages seem unusually attractive, and may lead to loss. On the other hand, imaginary dangers may harass, and require adequate Power thoughts to banish. Psychic matters, new habits, or even drugs may tend to enslave the person and poison may affect the health; yet even under quite unfavorable progressed aspects involving Neptune good progress may be made in music, in fiction writing, or in dramatic work.

With these additional considerations, what has been said under unfavorable progressions involving Venus applies with equal force to unfavorable progressions involving Neptune.

What to Do Under Unfavorable Progressions Involving Pluto

—The Domestic thoughts of the Moon apparently are expanded in the octave expression, Pluto, to embrace society as a whole. As octave of the Moon, the vibrations of Pluto have ready access to the nerve currents, and more readily than any other planetary influence tune the organism in on thoughts radiated by intelligences of either plane.

On its better side Pluto has to do with Soul Mates; and on its adverse side with weakness due to separation. Unusual discrimination is required while an unfavorable progression of Pluto is operative that contact with the criminal world of both planes be avoided. Kidnaping, or becoming the tool of visible or invisible racketeers, should specially be guarded against. Such things at times are present in slight degree without being recognized. Association with groups of doubtful character, and situations that might lead to coercion, should be avoided.

The Aggressive thoughts, as natural antidotes, should be applied under unfavorable progressions involving Pluto in precisely the same manner advocated for unfavorable progressions involving the Moon.

What to Do Under Unfavorable Progressions Involving the M.C.

—A progressed aspect involving the M.C. forms a temporary stellar aerial between the dynamic stellar structure mapped by the planet and this broadcasting station. The chief energy picked up is that of the planet involved. Therefore use the instructions given under the heading what to do when this planet is under unfavorable progressions, and associate the thoughts there indicated as harmoniously as possible with thoughts relating to honor, business and publicity. And take pains to see to it that the behavior and physical environment offer as much resistance as possible to any effort made by the M.C. thought-cells to bring unfavorable publicity, loss of position, or business adversity into the life.

What to Do Under Unfavorable Progressions Involving the Asc.

—A progressed aspect involving the Asc. forms a temporary stellar aerial between the dynamic stellar structure mapped by the planet and this ground-wire. The chief energy picked up is that of the planet involved. Therefore use the instructions given under the heading what to do when this planet is under unfavorable progressions, and associate the thoughts there indicated as strongly and as harmoniously as possible with thoughts relating to the health, the personality and personal affairs. And take pains to see to it that the behavior and the physical environment, including the diet, are the proper precautionary actions for such physical illness as the birth chart constants and the progressed constants, as set forth in Course XVI, at the time indicate might possibly develop.

Calculating Aspects Made by Major Progressed Planets.

—Major progressed aspects involving the planets are calculated in exactly the same way as are major progressed aspects of Sun, examples of which are given in lesson No. 111, and as are major progressed aspects made by the Moon, examples of which are given in lesson No. 112.

And the time an aspect moves to within the one degree of effective orb, and therefore first commences to have an influence, and the time an aspect moves past the one degree of effective orb, and thus loses its influence, are calculated in precisely the same way, except that the gap to be closed is indicated by the position one degree before or one degree past the perfect aspect.

FRACTIONS OF A MONTH: When working progressions by proportion there often is a fraction of a month to be converted into days. To do this multiply the numerator by 30 and divide the product by the denominator. Thus in example 1 below there are $21/73$ months. Multiplying 21 by 30 gives 630. Dividing 630 by 73 gives 9 days.

The examples which follow all relate to Chart 3a, given on page 100. The chart is erected for June 28, 1920, 12:23 p.m. CST. 89W. 40:40N. The EGMT is plus 6h 23m. The Limiting Date is March 22, 1920.

Example 1. Venus sextile Saturn r: Ephemeris date June 30, 1920, Venus is (b) 20' past the aspect, and moving daily (a) $1^{\circ} 13'$, or 73'. By proportion, multiplying (b) 20 by (c) 12 (months) gives 240.

Dividing 240 by (a) 73 gives (d) $3 \frac{21}{73}$ months, or 3 mo. 9d. June 30, 1920, is 2 days after the L.D. and thus Map. D. for 1922. Subtracting the 3 months, 9 days from March 22, 1922, gives Venus sextile Saturn r December 13, 1921. By logarithms, the problem is worked in detail on page 2 of lesson No. 19.

Example 2. Venus applying sextile Saturn r within one degree of orb: To reach the one degree of effective orb Venus must reach 6 Cancer 06. Ephemeris date June 29, 1920, Venus is 6 Cancer 13 and thus (b) 7' past the required position, and moving daily (a) $1^{\circ} 14'$, or 74'. By proportion, multiplying (b) 7 by (c) 12 gives 84. Dividing 84 by (a) 74 gives (d) $1 \frac{10}{74}$ months, or 1 mo. 4d.

By logarithms, subtracting log. (a) 1.2891 from log. (b) 2.3133 gives 1.0242, which is the log. of (d) 2h 16m. Dividing the 2 by 2 gives 1mo. Dividing the 16 and 4 gives 4d. June 29, 1920, is Map. D. for calendar year 1921. Subtracting the 1 month, 4 days found by either method from March 22, 1921, gives Venus applying sextile Saturn r within one degree of orb February 18, 1921.

Example 3. Venus separating sextile Saturn r within one degree of orb: To leave the one degree of effective orb Venus must be more than 8 Cancer 06. Ephemeris date July 1, 1920, Venus is 8 Cancer 40 and thus (b) 34' past the required position, and moving daily (a) $1^{\circ} 14'$, or 74'. By proportion, multiplying (b) 34 by (c) 12 gives 408. Dividing 408 by (a) 74 gives (d) $5 \frac{38}{74}$ months, or 5mo. 15d.

By logarithms, subtracting log. (a) 1.2891 from log. (b) 1.6269 gives .3378, which is the log. of 1h 02m. Dividing the 11 by 2 gives 5mo with a remainder of 60m. Adding the 60m to the 2m gives 62m. Dividing the 62 by 4 gives 15d. July 1, 1920, is Map. D. for calendar year 1923. Subtracting the 5 months, 15 days found by either method from March 22, 1923, gives Venus separating sextile Saturn r within one degree of orb, after which its effect is negligible, October 7, 1922.

Example 4. Venus square Mars p: Ephemeris date July 22, 1920, shows Mars 5 Scorpio 05 and Venus 4 Leo 30 and thus (b) 35' from square aspect. Venus is moving daily 1° 14' while Mars moves 28'. The difference is the gain (a) 46'. By proportion, multiplying (b) 35 by (a) 12 gives 420. Dividing 420 by 46 gives (d) 9 6/46 months, or 9mo. 4d.

By logarithms, subtracting log. (a) 1.4956 from log. (b) 1.6143 gives .1187, which is the log. of (d) 18h 16m. Dividing the 18 by 2 gives 9mo. Dividing the 16 by 4 gives 4d. July 22 is 24 days after the L.D., and is thus Map. D. for calendar year 1944. Adding the 9 months, 4 days found by either method to March 22, 1944, gives Venus square Mars p December 26, 1944.

Example 5. Venus applying square Mars p within one degree of orb: Ephemeris date July 21, 1920, shows Mars 4 Scorpio 37 and Venus 3 Leo 17, and thus lacking (b) 20' of being within the one degree orb of the square. Venus is moving daily 1° 13' and Mars is moving 28'. The difference is the daily gain (a) 45'. By proportion, multiplying (b) 20 by (c) 12 gives 240. Dividing 240 by (a) 45 gives (d) 5 15/45 months, or 5 mo. 10d.

By logarithms, subtracting log. (a) 1.5051 from log. (b) 1.8573 gives .3522, which is the log. of (d) 10h 40m. Dividing the 10 by 2 gives 5mo. Dividing the 40 by 4 gives 10d. July 21, 1920, is Map. D. for calendar year 1943. Adding the 5 months, 10 days found by either method to March 22, 1943, gives Venus applying square Mars p within one degree of orb September 2, 1943.

Example 6. Venus separating square Mars p within one degree of orb: Ephemeris date July 24, 1920, shows Mars 6 Scorpio 01 and Venus 6 Leo 58, and thus lacking (b) 3' of being one degree past the square aspect. Venus is moving daily 1° 14' and Mars is moving 29'. The difference is the daily gain (a) 45'. By proportion, multiplying (b) 3 by (c) 12 gives 36. Dividing 36 by 45 gives (d) 36/45 months, or 24d.

By logarithms, subtracting log. (a) 1.5051 from log. (b) 2.6812 gives 1.1761, which is the log. of (d) 1h 36m, or 96m. Dividing the 96 by 4 gives 24d. July 24, 1920, is Map.D. for calendar year 1946. Adding the 24 days found by either method to March 22, 1946, gives Venus separating square Mars p within one degree of orb, after which its influence is negligible, April 16, 1946.

Example 7. Saturn sextile Pluto r: Ephemeris date June 30, 1920, Saturn is (b) 1' past the aspect. Saturn is moving daily (a) 5'. By proportion, multiplying (b) 1 by (c) 12 gives 12. Dividing 12 by (a) 5 gives (d) 2 2/5 months, or 2mo. 12d.

By logarithms, subtracting log. (a) 2.4594 from log. (b) 3.1584 gives .6990, which is the log. of (d) 4h 48m. Dividing the 4 by 2 gives 2mo. Dividing the 48 by 4 gives 12d. June 30, 1920, is Map.D. for calendar year 1922. Subtracting the 2mo. 12d found by either method from March 22, 1922, gives Saturn sextile Pluto r January 10, 1922.

Example 8. Venus conjunction M.C. r: Ephemeris date July 4, 1920, Venus is 12 Cancer 21 and thus (b) 7' past the aspect. Venus is moving daily (a) 1° 13', or 73'. By proportion, multiplying (b) 7 by (c) 12 gives 84. Dividing 84 by (a) 73 gives (d) 1 11/73 months, or 1mo. 5d.

By logarithms, subtracting log. (a) 1.2950 from log. (b) 2.3133 gives 1.0183, which is the log. of (d) 2h 18m. Dividing the 2 by 2 gives 1mo. Dividing the 18 by 4 gives 5d. July 4, 1920, is Map. D. for calendar year 1926. Subtracting the 1 month, 5 days found by either method from March 22, 1926, gives Venus conjunction M.C. r February 17, 1926.

Example 9. Mercury trine Moon r: Ephemeris date July 6, 1920, Mercury lacks (b) 5' of the aspect, and is moving daily (a) 30'. By proportion, multiplying (b) 5 by (a) 12 gives 60. Dividing 60 by (a) 30 gives (d) 2mo.

By logarithms, subtracting log. (a) 1.6812 from log. (b) 2.4594 gives .7782, which is the log. of (d) 4h. Dividing the 4 by 2 gives 2mo. July 6, 1920, is Map. D. for calendar year 1928. Adding the 2 months found by either method to March 22, 1928, gives Mercury trine Moon r May 22, 1928.

Example 10. Mercury conjunction Neptune r: Ephemeris date July 10, 1920, Mercury lacks (b) 4' of the aspect, and is moving daily (a) 12'. By proportion, multiplying (b) 4 by (c) 12 gives 48. Dividing 48 by (a) 12 gives 4mo.

By logarithms, subtracting log. (a) 2.0792 from log. (b) 2.5563 gives .4771, which is the log. of (d) 8h. Dividing the 8 by 2 gives 4mo. July 10, 1920, is Map. D. for calendar year 1932. Adding the 4 months found by either method to March 22, 1932, gives Mercury conjunction Neptune r July 22, 1932.

Example 11. Venus sesqui-square Uranus r: Ephemeris date July 11, 1920, Venus is (b) 26' past the aspect, and is moving daily (a) 1° 14', or 74'. By proportion, multiplying (b) 26 by (c) 12 gives 312. Dividing 312 by (a) 74 gives (d) 4 16/74 months, or 4mo. 6d.

By logarithms, subtracting log. (a) 1.2891 from log. (b) 1.7434 gives .4543, which is log. of (d) 8h 26m. Dividing the 8 by 2 gives 4mo. Dividing the 26 by 4 gives 6d. July 11, 1920, is Map. D. for calendar year 1933. Subtracting the 4 months, 6 days found by either method from March 22, 1933, gives Venus sesqui-square Uranus r November 16, 1932.

Example 12. Mars square Mercury r: Ephemeris date July 16, 1920, Mars is (b) 1' past the aspect, and is moving daily (a) 26'. By proportion, multiplying (b) 1 by (c) 12 gives 12. Dividing 12 by (a) 26 gives (d) 12/26 months, or 14d.

By logarithms, subtracting log. (a) 1.7434 from log. (b) 3.1584 gives 1.4150, which is the log. of (d) 55m. Dividing the 55 by 4 gives 14d. July 16, 1920, is Map. D. for calendar year 1938. Subtracting the 14 days found by either method from March 22, 1938, gives Mars square Mercury r March 8, 1938.

Example 13. Mercury parallel Mars p: Ephemeris date July 18, 1920, Mars has declination 13 S 50 and gains declination 10' per day, while Mercury has declination 13 N 59 and loses declination 5' per day. The aspect lacks (b) 9'. As they are moving toward each other by declination we add 10 and 5 which gives the daily gain as (a) 15'. By proportion, multiplying (9) by (c) 12 gives 108. Dividing 108 by (a) 15 gives (d) 7 3/15 months, or 7mo. 6d.

By logarithms, subtracting log. (a) 1.9823 from log. (b) 2.2041 gives .2218, which is the log. of (d) 14h 24m. Dividing the 14 by 2 gives 7mo. Dividing the 24 by 4 gives 6d. July 18, 1920, is Map. D. for calendar year 1940. Adding the 7 months, 6 days found by either method to March 22, 1940, gives Mercury parallel Mars p October 28, 1940.

Example 14. Mercury applying parallel Mars p within one degree of orb: Ephemeris date July 12, 1920, Mars has declination 13 S 21 and gains declination 9' per day, and Mercury has declination 14 N 23 and loses declination 10' per day. They lack (b) 2' of being within the one degree of effective orb. As they are moving toward each other by declination we add the 9 and 10 which gives the daily gain as (a) 19'. By proportion, multiplying (b) 2 by (c) 12 gives 24. Dividing 24 by (a) 19 gives (d) 1 5/19 months, or 1mo. 8d.

By logarithms, subtracting log. (a) 1.8796 from log. (b) 2.8573 gives .9777, which is the log. of (d) 2h 32m. Dividing the 2 by 2 gives 1mo. Dividing the 32 by 4 gives 8d. July 15, 1920, is Map. D. for calendar year 1937. Adding the 1 month, 8 days found by either method to March 22, 1937, gives Mercury applying parallel Mars p within one degree of orb April 30, 1937.

Example 15. Mercury separating parallel Mars p within one degree of orb: Ephemeris date August 18, 1920, Mars is declination 19 S 10 and gains in declination 10' per day, while Mercury is declination 18 N 20 and loses declination 7' per day. As they are moving toward each other by declination we add the 10 and 7 which gives the daily gain as (a) 17'. They lack (b) 10' of being one degree past the parallel aspect. By proportion, multiplying (b) 10 by (c) 12 gives 120. Dividing 120 by (a) 17 gives (d) 7 1/17 months, or 7 mo. 2d.

By logarithms, subtracting log. (a) 1.9279 from log. (b) 2.1584 gives .2305, which is the log. of (d) 14h 7m. Dividing the 14 by 2 gives 7mo. Dividing the 7 by 4 gives 2d. August 18, 1920, is Map. D. for calendar year 1971. Adding the 7 months, 2 days found by either method to March 22, 1971, gives Mercury separating parallel Mars p one degree of orb October 24, 1971.

Example 16. Mars trine Venus r: Ephemeris date July 22, 1920, Mars lacks (b) 14' of the aspect, and moves daily (a) 28'. By proportion, multiplying (b) 14 by (c) 12 gives 168. Dividing 168 by (a) 28 gives (d) 6mo.

By logarithms, subtracting log. (a) 1.7112 from log. (b) 2.0122 gives .3010, which is the log. of (d) 12h. Dividing the 12 by 2 gives 6mo. July 22, 1920, is Map. D. for calendar year 1944. Adding the 6 months, found by either method to March 22, 1944, gives Mars trine Venus r September 22, 1944.

Example 17. Mars trine Sun r: Ephemeris date July 25, 1920, Mars lacks (b) 12' of the aspect and moves daily (a) 29'. By proportion, multiplying (b) 12 by (c) 12 gives 144. Dividing 144 by (a) 29 gives (d) $4 \frac{28}{29}$ months, or 4mo. 29d.

By logarithms, subtracting log. (a) 1.6969 from log. (b) 2.0792 gives .3823, which is the log. of (d) 9h 57m. Dividing the 9 by 2 gives 4mo. with a remainder of 60m. Adding the 60m to the 57m gives 117m. Dividing the 117 by 4 gives 29d. July 25, 1920, is Map. D. for calendar year 1947. Adding the 4 months, 29 days found by either method to March 22, 1947, gives Mars trine Sun r August 21, 1947.

Example 18. Mercury conjunction Mercury r: Ephemeris date July 29, 1920, Mercury lacks (b) 2' of the aspect, and is moving retrograde daily (a) 39'. Multiplying (b) 2 by (c) 12 gives 24. Dividing 24 by (a) 39 gives (d) $\frac{24}{39}$ months, or 18d.

By logarithms, subtracting log. (a) 1.5673 from log. (b) 2.8573 gives 1.2900, which is the log. of (d) 1h 14m, or 74m. Dividing the 74 by 4 gives 18d. July 29, 1920, is Map. D. for calendar year 1951. Adding the 18 days found by either method to March 22, 1951, gives Mercury conjunction Mercury r April 10, 1951.

Example 19. Venus parallel Saturn r: Birth chart Saturn is 10 N 35. Ephemeris date August 17, 1920, Venus decreasing declination is 10 N 27 and thus (b) 8' past the aspect, and moving daily (a) 27'. By proportion, multiplying (b) 8 by (c) 12 gives 96. Dividing 96 by (a) 27 gives (d) $3 \frac{15}{27}$ months, or 3mo 17d.

By logarithms, subtracting log. (a) 1.7270 from log. (b) 2.2553 gives .5283, which is the log. of (d) 7h 7m. Dividing the 7 by 2 gives 3mo with a remainder of 60m. Adding the 60m to the 7m gives 67m. Dividing the 67 by 4 gives 17d. August 17, 1920, is Map. D. for calendar year 1970. Subtracting the 3 months, 17 days found by either method from March 22, 1970, gives Venus parallel Saturn r December 5, 1969.

Chapter 5

Serial No. 114
Original Copyright 1934
Elbert Benjamine

Copyright
Church of Light
August 2002

Minor Progressions of Sun and Angles

Chapter 5

Minor Progressions Of Sun And Angles

MINOR progressed aspects have two distinct influences. They exert a power, and a harmony or discord, 1/27.3 of the power and harmony or discord of the same aspect between the same two planets when made by major progressed aspect. The psychokinetic power of the thought-cells receiving new energy through minor progressed aspects thus enables them to attract into the life minor events. Minor events coincide with characteristic minor progressed aspects.

But in addition to this independent influence, if the minor progressed aspect is to one of the terminals (as both birth chart and progressed positions are terminals, unless a planet aspects its birth chart place each progressed aspect has four terminals) of a major progressed aspect, it steps up, and thus reinforces the major progressed aspect. So far as effects are concerned, it seems to operate on the major progressed power as an automobile induction coil operates in stepping up the battery current to sufficient voltage to afford the spark necessary for ignition. And for a major progressed aspect to gain enough power to attract a major event it would seem that it is as necessary for it to be thus reinforced by a minor progressed aspect to one of its four terminals as it is for an automobile to have its battery current stepped up by an induction coil to get satisfactory ignition.

Church of Light statistical studies of the major and minor progressed aspects in many hundreds of charts at the time some major event took place demonstrate that major events take place only when the characteristic major progressed aspect is thus reinforced by a minor progressed aspect. These statistical studies indicate that this reinforcement effect seems to have no influence whatever on the harmony or discord of the major progressed aspect. But it does apparently step up whatever power the major progressed aspect has at the time by the same percentage a similar major progressed aspect steps up the birth chart power of the planets involved. Thus during the time a major progressed aspect is within its one effective degree of orb there are sure to be several lesser periods during which minor progressed aspects step it up. And whatever major event occurs is sure to happen on one of these peaks of power.

As is explained in lesson No. 116, in addition to the minor progressed aspect to one of its terminals, there must also be a transit aspect to one of its terminals at the precise time an event attracted by a major progressed aspect enters the life. But relative to the reinforcing power of minor progressed aspects, extensive statistical research fully justifies the following:

RULE: The major progressed constants of an event or disease are always reinforced by a minor progressed aspect heavier than from the Moon to one of its four terminals at the time the event occurs or the disease develops.

This rule is very important, for it enables us to eliminate the possibility of a given event or the development of a given disease, even during those periods when the major progressed constants are within the one degree of effective orb, except during those limited periods when ALL these major progressed constants are reinforced by minor progressed aspects.

But thus to be sure they are eliminated during a given period, not only the zodiacal minor progressed position of the ten planets and the M.C. and Asc. must be precisely ascertained, but the declinations also of all twelve minor progressed positions. Using a Lunar Constant for such calculations may give an error of from one to three days, which is not significant in timing minor events. But during three days minor progressed Sun, Mercury and Venus may each move not less than 15'. Thus this margin of error may make it appear that they are not within orb of an aspect when in reality they are. And should an individual undertake some dangerous exploit during a heavy discordant major progressed aspect involving Mars, under the impression there was no minor progressed aspect within one degree of perfect involving Mars, when in reality there thus was, this error might cost him his life. Or the error may indicate that there is a minor progressed aspect within one degree of orb to the terminal of a major progressed aspect when in reality there is not. On the assumption the minor progressed aspect is thus exerting reinforcing power, an individual under the influence of some favorable major progressed aspect may undertake some venture and fail, in which he would have been successful had the minor progressed aspect actually been within the one degree of effective orb. Thus on certain occasions it is essential to be able to determine quite precisely when a minor progressed aspect is, and when it is not, within the one degree of effective orb to a birth chart or major progressed position.

The above rule enables us more precisely to time indicated events; for the event will occur on one of the peaks of power indicated when ALL the major progressed constants are reinforced by minor progressed aspects.

As indicated on page 226 of lesson No. 117, it greatly aids in rectifying charts; because if the chart is correct it will have not only a major progressed aspect to the ruler of the house mapping the department of life affected by the event, and the major progressed constants of the event-often involving the rulers of several houses-at the time the event occurs, but as an additional check, the major progressed aspect indicating the event in each case must be reinforced by a minor progressed aspect and released by a transit aspect.

If the ruler of the house mapping the department of life affected by the major progressed aspect, and each of the other major progressed constants, are not thus reinforced by a minor progressed aspect and released by a transit progressed aspect at the time of the event, the house positions of the chart are not correct.

There are still other important applications of the rule given above, but undoubtedly its greatest usefulness is in the selection of the best time to do things. Commonly, minor progressed aspects last only a short period. Therefore, during the time a major progressed aspect is within its one degree of effective orb, it usually is possible to select several short periods during which no minor progressed aspect to any of its terminals reinforces it. If one were compelled to do something hazardous, such as take a dangerous trip, during the time there was an unfavorable major progressed aspect involving Mars, if one selected a time when this major progressed aspect was not reinforced by a minor progressed aspect, the danger would be reduced, if not to nil, at least to a minimum. Thus far in analyzing several hundred accidents we have found none unless a major progressed aspect involving Mars was reinforced by one or more minor progressed aspect.

On the other hand, if one wished to do something at a time when it was essential to get all the benefit possible from a favorable major progressed aspect, one could select a time when several minor progressed aspects were reinforcing the major progressed aspect. Often it is possible to find a short period during which the reinforcements give the major progressed aspect several times its normal peak power. The power to bring the desired event to pass during such a short period would consequently be much more than when no reinforcement was present.

Most major events do not drop unheralded out of the blue. Commonly there are preliminary minor occurrences leading up to the major event, and after the major event is past quite frequently there are minor occurrences resulting from it. The minor events leading to, and resulting from, a major event are indicated and timed by minor progressed aspects involving one or more of the terminals of the major progressed aspect indicating the major event. This knowledge may be quite valuable in anticipating the kind of major event that is approaching, and in anticipating the time certain conditions developing from it will occur.

Minor Progressed Aspects are of Value Only When Made to Birth chart Planets or to Major Progressed Planets

—Experience proves that the aspects among themselves of minor progressed planets afford so little energy that their influence should be neglected.

Any calendar time interval can be converted into minor progressed time interval, and any minor progressed time interval can be converted into calendar time interval, at the rate of 27.3 days minor progression time being equivalent to one year of calendar time, and 360° movement of the Moon by minor progression being equivalent to one year (365.25 days) of calendar time. The ephemeris Moon thus moves by minor progression approximately 1 degree a day.

To be precise, the minor progressed Moon moves exactly the same number of degrees and minutes as the transiting Sun. Thus the zodiacal distance between the birth chart Sun and the birth chart Moon is at all times the precise zodiacal distance between the minor progressed Moon and the transiting Sun. Therefore, from the transiting Sun—the position of the Sun in the ephemeris on any given calendar date—the position of minor progressed Moon may easily be found, and from the position of the minor progressed Moon the minor progressed positions of the other planets may be ascertained. And from the position of the minor progressed Moon when any minor progressed aspect is formed the transiting position of the Sun may easily be found, and from the transiting position of the Sun, by looking in an ephemeris for this position of the Sun, the calendar day the minor progressed aspect is formed can be ascertained. If desired, by calculating the time on that day when the Sun reaches the precise ° of the indicated position, the time on that calendar day when the aspect is formed also can be ascertained. The zodiacal distance between the birth chart Moon and the birth chart Sun, used in these calculations, is called the Solar Constant.

Finding the Solar Constant

—The Solar Constant (abbreviated S.C.) is the zodiacal distance in the chart of birth between the Moon and the Sun in signs, °s, and ‘s, expressed as plus or minus, so that when added to the sign, °, and ‘ occupied by the Moon, the algebraic sum gives the sign, °, and ‘ occupied by the Sun.

To find the Solar Constant, from the larger zodiacal longitude in signs, °s and ‘s occupied by the Sun or Moon in the birth chart, subtract the smaller zodiacal longitude in signs, °s and ‘s occupied by Sun or Moon in the birth chart. Place before the signs, °s and ‘s so found the plus or minus sign indicating whether these are to be added to, or subtracted from, the place occupied by the Moon to ascertain the place occupied by the Sun.

Then, wherever the Moon may be by minor progression, algebraically add the sign, °, and ‘ it occupies to the S.C. and the result is the sign, °, and ‘ occupied by the transiting Sun as shown in the ephemeris for that calendar year. The time of day the Sun reaches this ° and ‘ can then be calculated.

Wherever the Sun may be at any time of day on any day of the calendar year, change the algebraic sign before the S.C. and add it to the sign, °, and ‘ occupied at the time of day on that calendar date by the Sun, and the result is the sign, °, and ‘ occupied by the minor progressed Moon on that calendar date.

Finding the Minor Progression Date

—Each calendar year of 365.25 days is equivalent to 27.3 days of ephemeris time (minor progression time), which is the time it takes the minor progressed Moon to complete the cycle through all the 12 zodiacal signs and return to the sign, °, and ‘ it occupied in the birth chart. The Minor Progression Date (abbreviated Mip. D.)-the ephemeris date on which the minor progressed Moon again occupies the sign, °, and ‘ it occupied in the birth chart-for any calendar year may be found by counting ahead in the ephemeris as many returns of the Moon to the sign, °, and ‘ it occupies in the chart of birth as years of life have elapsed since birth.

Or, multiply the number of years that have elapsed since birth by 27.3. Then divide the product by 365 (number of days in a year) and call the quotient years. Divide the remaining days by 30 and call the quotient months. The number of years, months and days thus ascertained for each year after birth up to 96 years are given in the Minor Progression Date Table on pages 130 and 131. Then to the year, month and day of birth, add the years, months and days of the minor progressed interval thus ascertained. This will give the approximate ephemeris date of the Mip. D. Move forward or backward in the ephemeris from this approximate Mip. D. until the ephemeris shows the Moon in the sign, °, and ‘ it occupies in the birth chart. This ephemeris day is the Minor Progression Date.

Finding the Minor Ephemeris Date

—The Minor Ephemeris Date (abbreviated MED) is the date in the ephemeris from which the minor progressed positions of the planets are calculated, or on which the minor progressed planets make aspects to the birth chart or major progressed positions.

Inspection of the ephemeris will show the MED on which the minor progressed planets make aspects to birth chart or major progressed positions. To find the MED on which to calculate the minor progressed positions of the planets for any calendar date, after changing the sign before the S.C., algebraically add it to the sign, °, and ‘ occupied by the transiting Sun on that calendar date at the time of day for which the minor progressed positions are required. This gives the sign, °, and ‘ occupied by the minor progressed Moon on that calendar date and at that time of day.

Then find the approximate Mip. D. for that calendar year. If the calendar date is before the birthday of that year, move back in the ephemeris from the approximate Mip. D. until the Moon is found in the indicated sign, °, and ‘. If the calendar date is after the birthday of that year, move ahead in the ephemeris from the approximate Mip. D. until the Moon is found in the indicated sign, °, and ‘. The ephemeris date so located is the MED.

Finding the Minor Progressed Positions of the Planets on a Given Calendar Date

—First find the sign, °, and ‘ occupied by the transiting Sun on the given calendar date, and for the precise time of day, just as it is found in erecting a birth chart for the day and time of day of birth. Then, as above explained, use the S.C. to find the precise sign, °, and ‘ occupied by the minor progressed Moon for this calendar date and time of day. From this, as previously explained, find the MED for this calendar date.

Find (a) the daily motion of the planet in °s, and ‘s on the MED.

Find (c) the daily motion of the Moon in °s and ‘s on the MED.

Find (d) the °s and ‘s the sign, °, and ‘ occupied by the minor progressed Moon on the calendar date and time of day, as above found, is from the sign, °, and ‘ occupied by the Moon on the MED.

By proportion, reduce (a), (c) and (d) to ‘s.

Multiply (d) by (a) and divide the product by (c). This gives (b), the distance in ‘s the planet is from its MED position.

By logarithms, add log. (a) to log. (d), and from the sum subtract log. (c). The result is log. (b), the °s and ‘s the planet has moved from its MED position.

If the position of the minor progressed Moon for the given calendar date is less than its position on the MED and the planet is retrograde, add the °s and ‘s so found to its MED position. If the position of the minor progressed Moon is less than its position on the MED and the planet is direct in motion, subtract the °s and ‘s so found from its MED position. If the position of the minor progressed Moon is greater than its position on the MED and the planet is retrograde in motion, subtract the °s and ‘s so found from its MED position. If the position of the minor progressed Moon is greater than its position on the MED and the planet is direct in motion, add the °s and ‘s so found to its MED position. This gives the minor progressed position of the planet on the given calendar date.

For the minor progressed declination of the planet, for (a) use its daily motion by declination, and find (b), the °s and ‘s it is by declination from its MED position just as the °s and ‘s from its zodiacal MED position were above found.

Example 1. For the chart 317b, given on page 132, calculate all the minor progressed positions for January 19, 1932. The first step in all minor progressed calculations is to find the Solar Constant.

Subtracting the position of birth chart Sun, 4S 12° 36’, from the position of birth chart Moon, 11S 22° 31’, gives the Solar Constant as 7S 9° 55’.

The second step in finding minor progressed positions is to find the position of minor progressed Moon for the calendar date. Turning to January 19, 1932, in the ephemeris we find the transiting Sun at Greenwich noon $10S 28^{\circ} 13'$. Changing the algebraic sign before the S.C. we add its $7S 9^{\circ} 55'$ to the transiting Sun, $10S 28^{\circ} 13'$. This gives the position of minor progressed Moon as $6S 8^{\circ} 08'$.

The third step in finding minor progressed positions is to find the approximate Minor Progression Date. 1932 is 12 years after birth. We look on the Minor Progression Date Table, page 130, and find for 12 years of age 00y 10m 28d. Adding this to date of birth, 1920y 7mo 4d, gives the approximate Mip. D. as June 2, 1921.

The fourth step in finding minor progressed positions is to find the MED. As Jan. 19 is before the birthday in 1932, we move back in the ephemeris from the approximate Mip. D. until we find the Moon near 8 Virgo 08. The MED is thus May 15, 1921, which shows the Moon 5 Virgo 21 and moving (c) $13^{\circ} 55'$.

To reach 8 Virgo 08 it must move (d) $2^{\circ} 47'$.

The daily motion of the planet on May 15, 1921, is (a).

For use in proportion we reduce $13^{\circ} 55'$, which gives (c) 835'.

For use in proportion we reduce $2^{\circ} 47'$, which gives (d) 167'.

For use by logarithms they are not reduced.

The daily motion of the Sun on May 15, 1921, is (a) 58'. By proportion, multiplying (d) 167 by (a) 58 gives 9686. Dividing 9686 by (c) 835 gives (b) 12'.

By logarithms, adding log. (a) 1.3949 to log. (d) .9356 gives 2.3305. Subtracting log. (c) .2367 from 2.3305 gives 2.0938, which is the log. of (b) 12'. Adding the 12' found by either method to the position of the Sun in the ephemeris on May 15, 1921, gives the minor progressed position of the Sun at Greenwich noon for calendar date Jan. 19 1932, as 24 Taurus 18.

The daily motion of Mercury on May 15, 1921, is (a) $2^{\circ} 09'$. By proportion, reducing the $2^{\circ} 09'$ gives (a) 129'. Multiplying (d) 167 by (a) 129 gives 21543. Dividing 21543 by (c) 835 gives (b) 26'.

By logarithms, adding log. (a) 1.0478 to log (d) .9356 gives 1.9834. Subtracting log. (c) .2367 from 1.9834 gives 1.7467, which is the log. of (b) 26'. Adding the 26' found by either method to Mercury's position in the ephemeris on May 15, 1921, gives the Minor progressed position of Mercury at Greenwich noon on calendar date Jan. 19, 1932, as 00 Gemini 37.

The minor progressed positions of the other planets are found in the same way by using their daily motion on May 15, 1921, as (a). Their minor progressed positions for Greenwich noon will be found around the outside of the chart on page 132.

The declinations are handled in the same way by using the daily motion by declination of the planet as (a)

Thus on May 15, 1921, the Moon is decreasing in declination (a), $4^{\circ} 26'$. By proportion, reducing $4^{\circ} 26'$ gives (a) 266'. Multiplying (d) 167 by (a) 266 gives 44422. Dividing 44422 by (c) 835 gives (b) 53'.

By logarithms, adding log. (a) .7335 to log. (d) .9356 gives 1.6691. Subtracting log. (c) .2367 from 1.6691 gives 1.4324, which is the log. of (b) 53'. Subtracting (as declination is decreasing) the 53' found by either method from the Moon's declination in the ephemeris on May 15, 1921, gives the minor progressed declination of the Moon at Greenwich noon on calendar date Jan. 19, 1932, as $4^{\circ} N 51'$.

Example 2. For the chart 317b, find minor progressed M.C. and Asc. for Jan. 19, 1932. The Midheaven Constant (M.C.C.) for this chart, found according to the method given in lesson No. 111, is minus $2S 14^{\circ} 50'$. Therefore to find the minor progressed M.C., as explained in lesson No. 111, change the algebraic sign of the M.C.C. and add its $2S 14^{\circ} 50'$ to the minor progressed position of the Sun as above found, $2S 24^{\circ} 18'$. This gives minor progressed M.C. at Greenwich noon on Jan. 19, 1932, as $9^{\circ} Leo 08'$. Using the method given in lesson No. 111, it is found that when $9^{\circ} Leo 08'$ is on the M.C. in latitude $30^{\circ} N$., $5^{\circ} Scorpio 55'$ is on the Asc. Therefore, at Greenwich noon on calendar date Jan. 19, 1932, minor progressed Asc. is $5^{\circ} Scorpio 55'$.

Finding the Calendar Date on Which a Minor Progressed Aspect to a Birth Chart or Major Progressed Position is Perfect

—Find the MED in the ephemeris nearest the ephemeris time the aspect is perfect.

If a major progressed position is involved, find the major progressed position for the calendar date represented by the MED. Find its major progressed travel during the number of days represented by the movement of the minor progressed Moon on the MED. This is from 12 to 15 days of calendar time, as indicated by the Moon during the MED moving from 12 to 15 degrees.

Find (a) the gain in $^{\circ}$ s and $'$ s of the minor progressed planet on the major progressed planet during the calendar interval represented by the MED. If the aspect is to a birth chart position, (a) is the daily travel of the minor progressed planet on the MED.

Find (b) the $^{\circ}$ s and $'$ s the aspect is from perfect on the calendar date represented by the MED.

Find (c) the $^{\circ}$ s and $'$ s the Moon travels on the MED.

By proportion, reduce (a), (c) and (b) to $'$ s. Multiply (c) by (b) and divide the product by (a). This gives (d), the distance in $'$ s the minor progressed Moon is from its position on the MED when the aspect is perfect.

By logarithms, add log. (b) to log. (c), and from the sum subtract log. (a). The result is log. (d), the °s and ‘s the minor progressed Moon is from its position on the MED when the aspect is perfect.

From the sign, °, and ‘ thus occupied by the minor progressed Moon when the aspect is perfect, use the S.C. to find the sign, °, and ‘ occupied by the transiting Sun on the calendar date the aspect is perfect. If it is desired to know the time of day the minor progressed aspect is perfect on that calendar day, calculate the time of day in the manner explained in lesson No. 116.

Example 3. For chart 317b, find during calendar year 1932 when minor progressed Sun is sextile Venus p. The chart on page 132 shows the position of major progressed Venus on Jan. 19, 1932, as 27 Cancer 07. Looking back in the ephemeris from the approximate Mip. D. for 1932 (June 2, 1921), we find the Sun on May 18 in 26 Taurus 59 and thus near sextile Venus p. On this MED the Moon is 16 Libra 29. Subtracting the S.C. 7S 9° 55’ from 7S 16° 29’ gives the transiting position of the Sun on the MED as 12S 6° 34’. Looking in the 1932 ephemeris we find the Sun 6 Pisces 42 on Feb. 26, 1932. Calculating major progressed Venus according to the method given in lesson No. 111, gives its position on Feb. 26, 1932, as 27 Cancer 15. During the 13 days, movement of the Moon on the MED, calculated by the method given in lesson No. 111, Venus moves 3’. Subtracting this 3’ from the 58’ the Sun moves on May 18, 1921, gives the gain (a) 55’.

May 18, 1921, the Sun lacks (b) 16’ of sextile 27 Cancer 15.

May 18, 1921, the Moon moves (c) 13° 19’.

By proportion, reducing 13° 19’ gives (c) 799’. Multiplying (c) 799 by (b) 16 gives 12784. Dividing 12784 by (a) 55 gives (d) 232’ or 3° 52’.

By logarithms, adding log. (b) 1.9542 to log. (c) .2558 gives 2.2100. Subtracting log. (a) 1.4180 from 2.2100 gives .7920, which is the log. of (d) 3° 52’.

Adding the 3° 52’ found by either method to the position of the Moon on May 18, 1921, gives the minor progressed position of the Moon 20 Libra 21. From this 7S 20° 21’ subtract the S.C. 7S 9° 55’ and it gives the position of transiting Sun 10 Pisces 26. Turning to an ephemeris for the year 1932 we find the Sun 10 Pisces 43, less than 12 hours’ movement from the required position, on March 1, 1932. Thus Sun m is sextile Venus p March 1, 1932.

Example 4. For chart 317b, find during the calendar year 1932 when minor progressed Sun is sesqui-square birth chart Mars. The chart on page 132 shows Mars r 27 Libra 50. For the sesqui-square the Sun m can move to 12 Gemini 50. Looking in the ephemeris from the approximate Mip. D. for 1932 (June 2, 1921), we find the Sun on June 3, 1921, in 12 Gemini 20. On this MED the Sun moves (a) 57’. It lacks (b) 30’ of the aspect. The Moon moves daily (c) 13° 44’.

By proportion, reducing 13° 44’ gives (c) 824’. Multiplying (c) 824 by (b) 30 gives 24720. Dividing 24720 by (a) 57 gives (d) 434’ or 7° 14’.

By logarithms, adding log. (b) 1.6812 to log. (c) .2424 gives 1.9236. Subtracting log. (a) 1.4025 from 1.9236 gives .5211, which is the log. of (d) $7^{\circ} 14'$. Adding the $7^{\circ} 14'$ found by either method to the position of the Moon June 3, 1921, gives the minor progressed position of the Moon 13 Taurus 21. From this $2S 13^{\circ} 21'$ subtract the S.C. $7S 9^{\circ} 55'$ and it gives the position of transiting Sun as $7S 3^{\circ} 26'$. Turning to an ephemeris for 1932 we find the Sun 3 Libra 11, and thus less than 12 hours' movement from the required position on Sept. 26, 1932. Thus Sun m is sesqui-square Mars r Sept. 26, 1932.

Finding the Minor Progressed M.C. on a Given Date

—Instructions for this are given in lesson No. 111.

Finding the Minor Progressed Asc. on a Given Date

—Instructions for this are given in lesson No. 111.

Finding the Sign, °, and ' on the M.C. for a Given Asc.

—Instructions for this are given in lesson No. 111.

Finding the Calendar Date From the Minor Progressed M.C.

—Instructions for this are given in lesson No. 111.

Finding the Zodiacal Motion of Minor Progressed M.C. or Asc.

—Instructions for this are given in lesson No. 111.

Finding the Calendar Date on Which an Aspect From Minor Progressed M.C. or Asc. to a Major Progressed or Birth Chart Position is Perfect

Find the MED in the ephemeris nearest the ephemeris time the aspect is perfect. Find the sign, °, and ‘ of minor progressed M.C. or Asc. on the calendar date represented by this MED.

If a major progressed position is involved, find its major progressed position for the calendar date represented by the MED. Find its major progressed travel during the number of days represented by the movement of minor progressed Moon on the MED. This is from 12 to 15 days calendar time, as indicated by the Moon on the MED moving from 12 to 15 degrees.

Find (a) the gain in °s and ‘s of the minor progressed M.C. or Asc. on the travel of the major progressed position during the calendar interval represented by the MED. If the aspect is to a birth chart position, (a) is the travel of minor progressed M.C. or Asc. on the MED.

Find (b) the °s and ‘s the aspect is from perfect on the calendar date represented by the MED.

Find (c) the °s and ‘s the Moon travels on the MED.

Then proceed as if the aspect were being made by a minor progressed planet as previously explained.

Example 5. For chart 317b, find during the calendar year 1932 when minor progressed M.C. is sextile Mars p. The chart on page 132 shows major progressed Mars on Jan. 19, 1932, in 2 Scorpio 23. To reach the sextile M.C. must be more than 2 Virgo 23. From 6S 2° 23’ subtract the M.C.C. 2S 14° 50’ and it gives Sun m as 17 Gemini 33. Looking ahead from the approximate Mip. D. (June 2, 1921) we find the Sun on June 8, 1921, in 17 Gemini 08. This is the MED. To this 3S 17° 08’ add the M.C.C. 2S 14° 50’ and it gives the position of M.C. m on the MED as 1 Virgo 58. On this MED the Moon is 18 Cancer 04. Subtracting the S.C. 7S 9° 55’ from 4S 18° 04’ gives the transiting position of the Sun on the MED as 9S 8° 09’. Looking in the 1932 ephemeris we find the Sun 8 Sagittarius 06 on Nov. 30, 1932.

Calculating major progressed Mars according to the method given in lesson No. 111 gives Mars p on Nov. 30, 1932, in 2 Scorpio 45. During the 15 days movement of the Moon on the MED, calculated according to the method given in lesson No. 111, Mars moves 1’. The M.C. moves the same distance as the Sun on the MED. On June 8, 1921, it moves 57’. Subtracting the 1’ Mars moves from the 57’ gives the gain as (a) 56’.

On the MED the M.C. lacks (b) 47’ of sextile Mars p.

On the MED, June 8, 1921, Moon moves (c) $14^{\circ} 49'$.

By proportion, reducing $14^{\circ} 49'$ gives (c) 889'. Multiplying (c) 889 by (b) 47 gives 41783. Dividing 41783 by (a) 56 gives $746'$ or $12^{\circ} 26'$.

By logarithms, adding log. (b) 1.4863 to log. (c) .2095 gives 1.6958. Subtracting log. (a) 1.4102 from 1.6958 gives .2856, which is the log. of (d) $12^{\circ} 26'$.

Adding the $12^{\circ} 26'$ found by either method to the position of the Moon June 8, 1921, gives the minor progressed position of the Moon 00 Leo 30. From this $5S 00^{\circ} 30'$ subtract the S.C. $7S 9^{\circ} 55'$ and it gives the position of transiting Sun $9S 20^{\circ} 35'$. Turning to an ephemeris for the year 1932 we find the Sun 20 Sagittarius 17, less than 12 hours' movement from the required position, Dec. 12, 1932. Thus minor progressed M.C. is sextile Mars p Dec. 12, 1932.

Example 6. For chart 317b, find during the calendar year 1932 when minor progressed Asc. is square Neptune r: In example 2 we found minor progressed Asc. on January 19, 1932, in 5 Scorpio 55. To make the square of Neptune r it must reach 10 Scorpio 12. According to the method given in lesson No. 111, when 10 Scorpio 12 is on the Asc. in latitude 30N., 14 Leo 08 is on the M.C. From $5S 14^{\circ} 08'$ subtract the M.C.C. $2S 14^{\circ} 50'$ and it gives the position of Sun m when the aspect is perfect as $2S 29^{\circ} 18'$. Looking back in the ephemeris from the approximate Mip. D. we find the Sun on May 21, 1921, in 29 Taurus 52. Thus May 21, 1921, is the MED.

On the MED the Sun moves (a) $58'$.

On the MED Sun is (b) $34'$ past the aspect.

Previous day to MED, Moon moves $12^{\circ} 54'$.

By proportion, reducing $12^{\circ} 54'$ gives (c) 774'. Multiplying (c) 774 by (b) 34 gives 26316. Dividing 26316 by (a) 58 gives (d) $454'$ or $7^{\circ} 34'$.

By logarithms, adding log. (b) 1.6269 to log. (c) .2696 gives 1.8965. Subtracting log. (a) 1.3949 from 1.8965 gives .5016, which is the log. of (d) $7^{\circ} 34'$.

Subtracting the $7^{\circ} 34'$ found by either method from the position of the Moon on May 21, 1921, gives the minor progressed position of the Moon 18 Scorpio 15. From this $8S 18^{\circ} 15'$ subtract the S.C. $7S 9^{\circ} 55'$ and it gives the position of transiting Sun $1S 8^{\circ} 20'$. Turning to an ephemeris for 1932 we find the Sun 8 Aries 35, less than 12 hours' movement from the required position, March 29, 1932. Thus minor progressed Asc. is square Neptune r March 29, 1932.

Example 7. For chart 317b, find during the calendar year 1932 when minor progressed Asc. is square Mercury p. The chart on page 132 shows Mercury p on Jan. 19, 1932, in 9 Leo 58R. To reach the square the Asc. must be less than 9 Scorpio 58. When 10 Scorpio 05 is on the Asc. in latitude 30N. the table of houses shows 14 Leo 00 on the M.C. Subtracting the M.C.C. $2S 14^{\circ} 50'$ from $5S 14^{\circ} 00'$ gives the position of minor progressed Sun $2S 29^{\circ} 10'$. May 20, 1921, the ephemeris shows the Sun 28 Taurus 54. Thus May 20, 1921, is the MED.

To the position of the Sun on May 20, 1921, add the M.C.C. 2S 14° 50' and it gives the position of minor progressed M.C. on the MED as 13 Leo 44. Calculated according to the method given in lesson No. 111, when 13 Leo 44 is on the M.C. in latitude 30N. 9 Scorpio 51 is on the Asc. Therefore minor progressed Asc. on the MED is 9 Scorpio 51.

The Moon on the MED is 12 Scorpio 55. From this subtract the S.C. 7S 9° 55' and it gives the position of transiting Sun 3 Aries 00. The 1932 ephemeris shows Sun in 2 Aries 39 March 23. This is the calendar date corresponding to the MED. Calculating major progressed Mercury according to the method given in lesson No. 111, gives its position March 23, 1932, as 9 Leo 55R. The aspect is from perfect thus (b) 4'.

On the MED, May 20, 1921, the Sun moves 58', which is also the movement of minor progressed M.C. While the M.C. moves 60' from 13 Leo 00 to 14 Leo 00 the Asc. in latitude 30N. moves 51', and while the M.C. moves 58' the Asc., calculated according to the method given in lesson No. 111, moves 49'. Thus the Asc. on the MED moves 49', and during the 13 days, movement of the Moon on the MED major progressed Mercury, calculated according to the method given in lesson No. 111, moves 1'. As Asc. is direct in motion and major progressed Mercury is retrograde, we add the 49' and the 1' which gives the gain (a) 50'.

On the MED the Moon moves (c) 12° 54'.

By proportion, reducing 12° 54' gives (c) 774'. Multiplying (c) 774 by (b) 4 gives 3096. Dividing 3096 by (a) 50 gives (d) 62' or 1° 02'.

By logarithms, adding log. (b) 2.5563 to log. (c) .2696 gives 2.8259. Subtracting log. (a) 1.4594 from 2.8259 gives 1.3665, which is the log. of (d) 1° 06'.

Adding the 1° 02' found by either method to the position of the Moon on May 20, 1921, gives the minor progressed position of the Moon as 13 Scorpio 57. From this 8S 13° 57' subtract the S.C. 7S 9° 55' and it gives the position of transiting Sun as 1S 4° 02'. Turning to an ephemeris for the year 1932 we find the Sun in 3 Aries 39, less than 12 hours' movement from the required position, March 24, 1932. Thus minor progressed Asc. is square Mercury p March 24, 1932.

Finding the Declination of Minor Progressed M.C. or Asc. for a Given Calendar Date

—From the sign, °, and ' on the minor progressed M.C. or Asc. find the declination as if it were a birth chart position, as explained on page 66 of lesson No. 112.

Finding the Motion by Declination of Minor Progressed M.C. or Asc.

—Instructions for this are given in lesson No. 112.

Finding the Calendar Date on Which a Major, Minor or Transit Progressed Planet, Progressed M.C. or Progressed Asc. Reaches a Given Sign, °, and ‘ of the Zodiac, or Reaches a Given ° and ‘ of Declination

—In this problem (b) is the °s and ‘s the planet, M.C. or Asc. must move from its Map. D., MED, or Transit Date position to reach the given ° and ‘. The problem is handled exactly as if the progressing planet, M.C. or Asc. was this number of °s and ‘s from making an aspect to a birth chart position.

Finding the Calendar Date on Which the Minor Progressed M.C. or Asc. Makes a Parallel Aspect With a Major Progressed or Birth chart Position

—Find the MED in the ephemeris nearest the ephemeris time the aspect is perfect. If a major progressed position is involved, find the major progressed declination for the calendar date represented by the MED. Find the major progressed travel by declination during the number of days represented by the movement of the minor progressed Moon on the MED. This is from 12 to 15 days of calendar time, as indicated by the Moon during the MED moving from 12 to 15 degrees.

Find the declination in °s and ‘s occupied by minor progressed M.C. or Asc. on the calendar date represented by the MED. Find the minor progressed travel by declination of the M.C. or Asc. during the MED.

Find (a) the gain in °s and ‘s of the minor progressed M.C. or Asc. in declination on the major progressed position’s travel by declination during the calendar interval represented by the MED. If the aspect is to a birth chart position, (a) is the travel in declination of minor progressed M.C. or Asc. on the MED.

Find (b) the °s and ‘s the aspect is from perfect on the calendar date represented by the MED.

Find (c) the °s and ‘s the Moon travels on the MED.

Then proceed as if the aspect were being made by a minor progressed planet as previously explained.

Example 8. For chart 317 b, find the calendar date in 1932 when minor progressed Asc. is parallel Mercury p. Major progressed Mercury, as shown on the Map. D. July 16, 1920, has declination 14 N 13 on Jan. 19, 1932, and is decreasing declination by 8' per year by major progression. The table on page 162 of lesson 115 shows that to reach declination 14 S 11 the Asc. can be 8 Scorpio 00. A table of houses shows that when 11 Leo 00 is on the M.C. the Asc. in latitude 30N. is 7 Scorpio 31. Thus when the aspect is perfect approximately 11 Leo 30 will be on the M.C. Subtracting the M.C.C. 2S 14° 50' from 5S 11° 30' gives the approximate position of minor progressed Sun 26 Leo 40. Moving back in the ephemeris from the approximate Mip. D. for 1932, June 2, 1921, we find the Sun on May 18, 1921, in 26 Taurus 59. Thus May 18, 1921, is the MED.

May 18, 1921, the Moon is 16 Libra 29. From 7S 16° 29' subtract the S.C. 7S 9° 55' and it gives the transiting position of the Sun on the MED 12S 06° 34'. Looking in the 1932 ephemeris we find the Sun in 6 Pisces 42 on Feb. 26. Calculating the declination of major progressed Mercury by the method given in lesson No. 111 gives its position on March 13, 1932, as 14 N 12. It moves less than 1' during the 14 days, movement of the Moon on the MED.

To the position of the Sun on the MED 2S 26° 59' add the M.C.C. 2S 14° 50' and it gives minor progressed M.C. on the MED as 5S 11° 49'. Calculated by the method given in lesson No. 111, when 11 Leo 49 is on the M.C. in latitude 30N. the Asc. is 8 Scorpio 30. This is its position on the MED. On the MED the Sun moves 58'. This is also the travel of the M.C. on the MED. Calculated according to the method given in lesson No. 111, while the M.C. moves 58' the Asc. moves 50'. The table on page 162 of lesson No. 115 shows that when the Asc. in 8 Scorpio 00 moves 60' the declination moves 19'. Calculated by the method given in lesson No. 112, 8 Scorpio 30 thus has declination 14 S 21. While the Asc. travels the 50' on the MED by zodiacal motion, calculated by the same method the Asc. increases declination 16'. This is the travel by declination of minor progressed Asc. on the MED. As Mercury does not change declination during the MED the gain is (a) 16'.

As minor progressed Asc. on the MED is 14 S 21 increasing in declination, and major progressed Mercury on the MED is 14 N 12, the aspect is from perfect (b) 9'.

On the MED between May 17 and May 18, 1921, the Moon is moving (c) 13° 31'.

By proportion, reducing 13° 31' gives (c) 811'. Multiplying (c) 811 by (b) 9 gives 7299. Dividing 7299 by (a) 16 gives 456' or 7° 36'.

By logarithms, adding log. (b) 2.2041 to log. (c) .2493 gives 2.4534. Subtracting log. (a) 1.9542 from 2.4534 gives .4992, which is the log. of 7° 36'.

Subtracting the $7^{\circ} 36'$ found by either method from the position of the Moon May 18, 1921, gives the minor progressed position of the Moon when the aspect is perfect as 8 Libra 53 . From this $7S 8^{\circ} 53'$ subtract the S.C. $7S 9^{\circ} 55'$ and it gives the position of transiting Sun as $11S 28^{\circ} 58'$. Turning to an ephemeris for 1932, we find the Sun 11 Aquarius 38 , less than 12 hours' movement from the required position, on Feb. 18, 1932. Thus Asc. m is parallel Mercury p Feb. 18, 1932.

Example 9. For chart 317b, find the calendar date in 1932 when minor progressed M.C. is parallel Jupiter p. Major progressed Jupiter, as shown by the Map. D. July 16, 1920, has declination $15 N 15$ and decreasing $4'$ per year by major progression. When 18 Leo 00 is on the M.C. the declination of M.C. is $15 N 26$, and decreasing $19'$ while M.C. moves $60'$. When 18 Leo 30 is on M.C. minor progressed Sun is 3 Gemini 40 , which gives the MED May 25, 1921, with Sun 3 Gemini 43 . May 25, 1932, the Moon is 15 Capricorn 23 . Subtracting from this the S.C. gives calendar date for MED May 26, 1932. Major progressed Jupiter on May 26, 1932, has declination $15 N 14$ and moves less than $1'$ during the 12 days, interval of the MED.

Minor progressed M.C. on the MED is 18 Leo 33 with declination $15 N 16$. The aspect is from perfect (b) $2'$.

Minor progressed M.C. on the MED moves $58'$ by zodiacal motion and decreases declination $18'$. As Jupiter does not change declination the gain is (a) $18'$.

On the MED, May 25, 1921, the Moon is moving (c) $11^{\circ} 59'$.

Solving from this point on as if the aspect were being made by a minor progressed planet we find minor progressed M.C. parallel Jupiter p May 28, 1932.

Chapter 6

Serial No. 115
Original Copyright 1934
Elbert Benjamine

Copyright
Church of Light
August 2002

Minor Progressions of Moon and Planets

Chapter 6

Minor Progressions Of Moon And Planets

IT IS MUCH easier to determine the periods during which, because a major aspect is reinforced and given great power by one or several minor progressed aspects to its terminals, an event of importance will come into the life due to the psychokinetic power of the thought-cells thus given new energy than it is to determine how favorable or unfavorable the event thus attracted will be.

The harmony or discord of the minor progressed aspect to the major progressed terminal seems to have no influence on the harmony or discord of the major progressed aspect. But it does markedly step up its power.

These reinforced peaks of power of a major progressed aspect afford a fair estimate of the psychokinetic power of the thought-cells at those times to exert more than normal pressure characteristic of the planets involved in the major progressed aspect, on the thoughts, behavior and environment. But the harmony or discord which exerts pressure on the thoughts, behavior and environment cannot be estimated by the harmony or discord of the progressed aspect alone. The thought-cells influenced by the progressed aspect have their birth chart harmony or discord. This may be considered their life-time normal. An independent minor progressed aspect may coincide with a minor disagreeable or favorable event deviating from the normal, but its relative effect on the period in which it occurs is but a slight deviation from the normal harmony or discord; a deviation to be measured by the relative harmony or discord of the planets involved.

The harmony or discord of a major progressed aspect between two planets is also a deviation from the normal harmony or discord of the thought-cells. The harmony or discord added to the thought-cells by a progressed aspect alters their birth chart harmony or discord by the number of harmodynes or discordynes added to their birth chart harmodynes or discordynes.

If, as frequently happens, the major progressed aspect is between two planets one of which at birth had many harmodynes and the other of which at birth had many discordynes, the average benefit or detriment of the event influenced by the aspect may very closely be indicated by the average harmony or discord of the aspect, yet at the same time some of the events, or the same events, may markedly be a detriment or loss to the department of life ruled by the discordant birth chart planet. For instance, the death of a loved one may mean a grave personal loss, but may also bring a financial inheritance of much value. Or a harmonious marriage may bring estrangement of friends who oppose it.

Instances occur in which, because the birth chart discord of the planets involved is so great, a progressed trine brings loss and grief into the life. And other instances occur in which, because the birth

chart harmony of the planets involved is so great, a progressed square or opposition brings good fortune into the life. Thus in estimating whether, and how much, a progressed aspect is favorable or unfavorable, the harmony or discord of each planet involved in the progressed aspect should be estimated. And if one of the planets involved has much harmony, the departments of life it rules are not apt to suffer much from any progressed aspect. But if the other planet involved has much discord, the departments of life it rules are apt to suffer severely from a heavy discordant progressed aspect, and are apt to benefit little from a heavy harmonious progressed aspect.

Both the average benefit or detriment to be expected from a progressed aspect, and the benefit or detriment to be expected from each department of life influenced, may be calculated quite precisely in terms of harmodynes and discordynes according to the rules given on page 200-202 of lesson 203 of Course XVI, Stellar Healing. But before this can be done, the birth chart power and harmony of each of the two planets must be calculated, and the harmony or discord of the progressed aspect. These calculations are explained and examples given in Course XVI, Stellar Healing. But whether the birth chart harmony or discord of the planets involved in a progressed aspect are thus precisely calculated, or merely estimated by inspection, in appraising the fortune or misfortune of the event or conditions likely to be attracted by a progressed aspect the birth chart harmony or discord of each planet involved in it always should be given due consideration.

What to Do Under Favorable Progressions Involving the Sun

—Because the thought-cells mapped by the Sun are so intimately associated with the nerve currents, the feeling corresponding to the favorable aspect involving the Sun should be held as consistently and strongly as possible, so that its harmonious energies, dominating the whole electromagnetic form, will find their way as Rallying Forces into other compartments of the astral body and thus benefit as many departments of life as possible.

One under such a progression should make an unusual effort to increase his importance and the scope of his influence. He will find that his Power to mold conditions is increased, and he should thus direct himself vigorously toward shaping various environmental factors more favorable to his ends. In this endeavor he will find those above him in position or influence more favorable to his inclinations than usual; and he should make a special effort to form such contacts.

To women in particular the male sex will be more kindly disposed, and their help may be solicited. To them this aspect is favorable to making lasting attachments.

The Individual under a favorable progressed aspect involving the Sun will have at his command a vital reserve which if he persistently directs his mind and actions toward the accomplishment of something enables the thought-cells to exert unusually strong psychokinetic power toward its realization.

It is, of course, more easy at such a time to accomplish those things indicated by the house positions of the Sun and the other planet involved in the aspect. Undirected, the thought-cells will attract events belonging to the department of life thus indicated. But, because of their power as Rallying Forces, the Solar energies readily can be diverted into almost any other form of accomplishment.

To get the most out of such a Solar progression, therefore, the individual must know quite definitely what he desires to accomplish or attract. He must then keep this end steadily in mind and work persistently and with unflinching confidence to bring it to pass.

What to Do Under Favorable Progressions Involving the Moon

—Although more receptive, and fluctuating more than those of the Sun, the thought-cells mapped by the Moon also have an intimate association with the electromagnetic form and nerve currents. Energies coming in over the aerial to them thus readily become Rallying Forces to influence other departments of life, the thought-cells governing which also are reached by some temporary stellar aerial.

But energies from the planets, either harmonious or discordant, become Rallying Forces only when the feelings respond to them. If we are to utilize favorable progressed aspects involving the Moon to the greatest extent, therefore, we must cultivate the ability to feel the harmony and exuberance they bring. If, instead, through habit or volition, we keep tuned in on some less pleasant vibration, the energies from the Moon will only be able to have a favorable influence through the activities of the thought-cells they reach more directly.

The houses occupied by the Moon and the other planet involved in the aspect indicate the departments of life through which favorable conditions may be attracted with greatest facility. Contact with the public in general, efforts toward publicity, and Domestic affairs as a whole tend to flourish. To men in particular women will be kindly disposed and their help may be solicited.

At fairly frequent intervals throughout the life the Major Progressed Moon makes favorable aspects to the birth chart and major progressed positions. There is thus opportunity present recurrently to tune in on planetary vibrations which may be made decidedly helpful. It will give exceptional power to these favorable vibrations if the person appraises their nature by taking into consideration the characteristic energy of the other planet involved in the aspect, and makes a persistent effort to keep his Mind and Feelings tuned to this rate of vibration. In this manner his nerve currents will pick up this harmonious energy in great volume, causing it for the time to become his dominant vibratory rate.

If people but understood the opportunities presented to them by even a favorable progressed aspect from the Moon, through affording them an easily accessible supply of harmonious energy to tune in on, it would open up possibilities for attainment of which they dare not dream at present.

What to Do Under Favorable Progressions Involving Mercury

—Any progressed aspect involving Mercury gives additional energy to the thought-cells which relate to the expression of conscious thought. That is, cerebral processes are stimulated into more than normal activity; and the trend of the thoughts so stimulated will be colored strongly by the characteristics of the planet with which Mercury is involved in the aspect. The things about which these thoughts chiefly revolve are those governed by the houses in which Mercury and the other planet involved in the aspect are located.

These conscious thoughts have the function of tuning the nervous system and the electrical energies that flow over the nerves in on inner-plane vibratory rates having a corresponding frequency and trend. In fact, it is through the thoughts and feelings which are deliberately cultivated that man has his greatest power to mold his own destiny. He can, through the proper selection of the subjects for his thinking, tune his whole electromagnetic form in on similar vibratory rates and pick them up, radio fashion, and thus saturate himself with energies of the desired quality.

These energies then act as Rallying Forces, and flow over all the temporary stellar aeriels that may be present at the time in his astral body, adding their harmonious vibratory rates to the stellar cells relating to various departments of life. These cells thus gaining new energy, and feeling kindly disposed, then use their psychokinetic power to attract into the life fortunate events relating to their department. Thoughts and feelings are the implements by which character and destiny may be shaped to the desired ends.

Under a progressed aspect involving Mercury, however, unless the thoughts stimulated by the unusual access of energy to the stellar cells mapped by the terminals of the aspect are governed and steadied, they may give rise to nervous haste and flurry, to a condition of nervous tension, or to feelings that are not entirely harmonious and constructive in character. It is well, therefore, even under the most favorable aspect involving Mercury to keep the thinking directed calmly, steadily and harmoniously into some selected constructive channel. To do this, and to prevent scattering of the thoughts or the development of undue tensions, it may be necessary to spend effort in the cultivation of Power thoughts and Religious thoughts.

Favorable progressions involving Mercury give facility to, and success from, the expression of the thoughts. They are thus favorable to talking, drawing up written contracts, lecturing, teaching, writing, publishing, or the presentation to others of any product of thought, in whatever direction the talents lie.

What to Do Under Favorable Progressions Involving Venus

—As the favors Venus brings are largely those that come through friendship and the kind offices of others, it is essential, if the most is to be made of a favorable progression involving Venus, that human contacts be afforded.

Venus is helpful to all types of artistic expression, to love making, and to affectional matters in general.

These interests, therefore, may be cultivated at such a time if they seem desirable. But aside from these matters more obviously ruled by Venus, other interests which may be forwarded through friendship may be pushed.

Because Venus so seeks the line of least resistance the utmost in benefit is seldom obtained from her good progressions. The tendency is merely to have a happy time and to enjoy such pleasures as are offered by her bounty. But the kind wishes of others, their helpful suggestions, and their more material support, if proper initiative is taken, often can be made to lead toward some more important goal.

Excess in the pursuit of pleasure may develop even under a favorable progression involving Venus; but joy, buoyancy, and a happy outlook on life also are the qualities which under such a progression attract others to the person and cause them to favor him. Therefore, instead of shunning pleasure and the society of others, unusual effort should be made to mingle with people, to be congenial with them, and to conduce to their happiness and joy.

While the Safety thoughts are beneficial when there is an unfavorable progression involving Venus, the undue cultivation of them while under a favorable progression involving Venus dampens the exuberance and creates a chill which others feel. To attract the maximum benefit the Social thoughts of Venus must be permitted, and even encouraged, to express spontaneously. The effort to put everyone at his ease, to see that he is enjoying himself, taking delight in the companionship of others, and spreading the sunshine of happiness on every hand, afford the best opportunity for a favorable progression involving Venus to attract good fortune.

What to Do Under a Favorable Progression Involving Mars

—Whatever Mars gains comes through the expenditure of energy, through unusual initiative, creative power, aggression and strife. We need not expect, therefore, that the conditions attracted by even a favorable aspect involving Mars will be free from antagonisms. Strife is usually unavoidable; but the favorable progression gives the additional energy and resources which enable gains to be made in spite of opposition.

For purchasing or handling machinery such an aspect is fortunate. Surgical operations submitted to then will be handled with unusual skill. Enemies will be more easily defeated. But even though the aspect is exceptionally harmonious it does not prevent the attraction of dangers. And there should be a deliberate attempt to avoid haste and impulse in both speech and action.

One thing, and one thing only, is needed under a favorable progression involving Mars. It is to direct all the energies, to the utmost extent, into constructive channels. This does not mean that the energies should be curbed, but they should be employed to build up, and not to tear down.

Through the exercise of initiative and energy one is able to forward his desires and ambitions, especially those indicated by the house positions of Mars and the other planet involved in the aspect. And following the exclusively constructive attitude, when antagonisms and strife develop, as they surely will, the least attention paid to them the better. Usually, if unnoticed, they shortly will subside.

If fighting is unavoidable, the chances to win are better than usual; but to the extent one can keep his energies fully directed toward the goal of some real accomplishment will satisfactory progress be made under a favorable aspect involving Mars. Under Mars inner-plane weather cultivate patience and take it easy.

What to Do Under Favorable Progressions Involving Jupiter

—Jupiter is the most powerful influence to attract good fortune. This he does through abounding optimism and good-fellowship, which others feel, and to which they respond by the desire to grant favors.

Jupiter is one of the Business planets, and his favorable progressions are advantageous to investments, merchandising and professional advancement. The influence is to attract patronage from those with ability to pay well. The contacts with others through clubs, societies, or the more direct avenue of salesmanship should be sought.

This is the progression under which selling can be done easiest and to best advantage. The raising of money is also not so difficult at this time.

As the helpfulness comes through others feeling good will and benevolence through their contact with the individual, proper contacts should be encouraged.

In fact, no effort should be spared to come in touch with those who have it in their power to give assistance, and to create an atmosphere of hail-fellow, well-met on the occasion of such meetings.

What to Do Under Favorable Progressions Involving Saturn

—The gains that can be made due to the influence of Saturn are brought by hard work, economy, organization, system, shrewd bargaining, shouldering responsibilities, and dogged perseverance.

By accepting work and responsibility that is attracted, through management and the performance of duties in a manner satisfactory to others, permanent advancement may be made under such a progression. Contacts with elderly people and those of a conservative turn, tend to bring opportunities for progress. This is the best of all progressed aspects under which to make purchases. One is attracted to those who are willing to sell at a low price.

Organization, reorganization, or cost-saving methods may be inaugurated in business, as Saturn is one of the Business planets. He is so negative, however, that even under his most favorable progressions the Power thoughts need some cultivation to give courage and vitality. And, to prevent the mind from dwelling too continuously on serious problems, social contacts and the encouragement of the Social thoughts are only less important than when there is an unfavorable progression involving Saturn. Under Saturn inner-plane weather keep your chin up and cultivate cheerfulness.

What to Do Under Favorable Progressions Involving Uranus

—Mental pursuits, especially the study of astrology and occultism, are given a favorable impetus. Discovery, invention, the development of new ideas, and the handling of intricate machines and electrical devices also prove fortunate.

If so used it can be made the most powerful of all influences for intellectual, and perhaps even spiritual progress. The electromagnetic energies are strongly charged in a manner that enables the individual, through oratory or more intimate associations, to compel others to do as he desires. It tends toward sudden changes that prove fortunate; especially as opening new mental vistas.

Under such a progression some person often is attracted into the life, for a time to have a marked influence, but the attachment is seldom lasting. Nevertheless, through human contacts sudden and amazing opportunities may come. In fact, it is the sudden and unexpected which happens, and the individual should be prepared to take advantage of any circumstance which arises.

What to Do Under Favorable Progressions Involving Neptune

—Such progressions favor outings and recreation, and are probably the best of all for investigating psychic phenomena and for the development of the psychic faculties. Projects of vast size may be presented, but they seldom yield more than a small part of the expected benefits.

It is a fine influence for bringing new ideals, which if found sound after the aspect has passed may be adopted as permanent aims in the life. All dramatic and artistic endeavors are favored, and inspiration from unseen sources is ready at hand. Imaginative works thus are executed with extraordinary facility.

All occult, mystical and astrological pursuits are encouraged. This is one of the best of all influences for true spiritual progress.

What to Do Under Favorable Progressions Involving Pluto

—Under the influence of no other planet is it so easy to come in contact with intelligences of the unseen world, not through the psychic feeling and impressions encouraged by Neptune, but through direct interchange of thought.

This direct communion with those of the inner plane is not without its dangers. If the desires and thoughts are selfish, those thus tuned in on will be of similar disposition. The influence over the life of unseen entities, therefore, whoever they may pretend to be, needs critical examination.

Never, for a moment, should one surrender his power of discrimination, or permit control. After careful analysis, if information gained from such sources can be used for Universal Welfare, well and good. But Pluto has a subtle, inversive side which frequently convinces people they are being helpful to others when in reality they are limiting their expression and exercising undue restraint.

A favorable progression involving Pluto affords opportunity for group activity and cooperation; for joining with others to forward some worthy cause. Its finer side, which may be contacted under such a progression, is the most spiritual of all influences; and may thus be made to benefit others and yield the utmost to the individual in Spiritual Progress.

What to Do Under Favorable Progressions Involving the M.C.

—A progressed aspect involving the M. C. forms a temporary stellar aerial between the dynamic stellar structure mapped by the planet and this broadcasting station. The chief energy picked up is that of the planet involved. Therefore use the instructions given under the heading what to do when this planet is under favorable progressions, and associate the thoughts there indicated as strongly and harmoniously as possible with thoughts relating to honor, business and publicity. And take pains to take advantage of all opportunities to forward these three matters, especially through the characteristics of the planet involved in the aspect and the house it occupies.

What to Do Under Favorable Progressions Involving the Asc.

—A progressed aspect involving the Asc. forms a temporary stellar aerial between the dynamic stellar structure mapped by the planet and this groundwire. The chief energy picked up is that of the planet involved. Therefore use the instructions given under the heading what to do when this planet is under favorable progressions, and associate the thoughts there indicated as strongly and as harmoniously as possible with thoughts relating to health, the personality and personal affairs. And take pains to take advantage of all opportunities to forward these three matters, especially through the characteristics of the planet involved in the aspect and the house it occupies.

Using Favorable Progressions as Rallying Forces

—Often there is both an unfavorable and a favorable progressed aspect within the one degree of effective orb at the same time. The more energy given the thought-cells mapped by the unfavorable progressed aspect by thinking the type of thoughts characteristic of their planets and the nature of the aspect the more psychokinetic power they gain to bring unfavorable events into the life. And the more the individual associates closely with the environmental factors characteristic of the planets involved and the houses they rule the greater facilities are afforded this psychokinetic power to bring unfortunate events into the life.

To the extent the individual instead associates closely with the environmental factors characteristic of the planets at the same time involved in a favorable progressed aspect and the houses they rule will the thought-cells they map have facilities for bringing into the life fortunate events. And by avoiding the environmental factors characteristic of the planets involved in the unfavorable progressed aspect and the houses they rule, there will be environmental resistance to whatever psychokinetic power they are able to use which will lessen the misfortune of the event they can attract.

And if the individual will keep tuned in by his thoughts and feelings an the harmonious vibrations characteristic of the planets involved in the favorable progressed aspect, not only will he supply their thought-cells with additional energy which will increase their psychokinetic power to bring fortunate events into the life, but they will also act as Rallying Forces to give greater harmony to all the stellar cells reached by the aerials of all progressed aspects which at the time are within the one degree of effective orb.

When the individual's thoughts and feelings are tuned to a certain vibratory quality, the nerve currents, which are electrical energies, become conductors of this quality of astral energy and carry it readily to all the stellar aeries of the astral body. It is far easier to maintain the harmonious feeling characteristic of a planet while it is involved in a favorable progressed aspect than while it is involved in an unfavorable progressed aspect, or while not involved in a progressed aspect. And so long as this state of feeling is maintained the chief astral energy received by the stellar cells at the terminals of all the aeries is of this type. Thus not only the stellar cells at the terminals of the favorable progressed aspect receive additional harmonious energy, but the thought-cells at the terminals of other stellar aeries, particularly those at the terminals of other progressed aspects, also receive this harmonious energy, which tends to give them more harmonious desires. And thus having their desires conditioned more harmoniously they will use such psychokinetic power as they possess to bring into the life events which are more favorable than had their desires not thus been influenced by harmonious Rallying Forces.

Keeping Track of Minor Progressed and Transit Progressed Positions

—It is especially important to keep track of minor progressed positions so it can be known in advance whenever a minor progressed aspect heavier than from the Moon forms to one of the terminals affected by a major progressed aspect that is at the time within the one effective degree of orb; for such events as the major progressed aspect brings will occur on one of the peaks of power thus indicated. Thus special precautionary actions should be taken during each such reinforcement period.

The minor progressed Moon on the Mip. D. reaches the same sign, °, and ‘ the Moon occupies in the birth chart. Therefore a good way to keep track of the minor progressed positions is first to find the Mip. D. for the current calendar year and in the ephemeris mark it with the date of the calendar year. Then move back in the ephemeris to the position of the Moon on the Mip. D. of the previous calendar year, and ahead to the position of the Moon on the Mip. D. of the following year, and mark these days in the ephemeris with the dates of these calendar years.

As the Moon moves approximately 1° a day by minor progression, the relation of the number of degrees of the sign occupied by the minor progressed Moon to the number of the day of the calendar month is approximately constant. The number of °s it is ahead or behind the number of the day of the month at birth is approximately the number of °s minor progressed Moon is ahead or behind the number of the day of any month. This difference is called the Lunar Constant. Each full month after the birthday finds the minor progressed Moon in a subsequent sign, but approximately the same degree as at birth. Thus by making allowance for the Lunar Constant, starting with the birthday of the calendar year and the minor progressed Moon in the same sign and ° as at birth on the Mip. D. for that calendar year, when moving

backward or forward in the ephemeris from the Mip. D., mere inspection will indicate the calendar date when any of the planets are close to making an aspect to a birth chart or major progressed terminal. Having thus located the approximate calendar date when the aspect will be present, this MED can then be used to calculate when the aspect is perfect, and if it reinforces an important major progressed aspect, when it comes within, and when it leaves, the one degree of effective orb.

When the transit positions of the planets are close to an aspect with a birth chart or major progressed position can be ascertained merely by scanning the ephemeris for the given calendar year. But for the positions of the minor progressed and transit progressed M.C. and Asc. the M.C.C. should be used.

Change the sign before the M.C.C. and algebraically add it to the sign, °, and ‘ occupied by the progressed Sun. This gives the progressed M.C. As progressed M.C. moves the same distance as progressed Sun, mentally adding the movement of progressing Sun to the M.C. will indicate the MED or Transit Date on which the M.C. forms an aspect. At the same time scanning a table of houses for this progress of the M.C. will indicate the MED or Transit Date on which the Asc. forms a zodiacal aspect. And at the same time also scanning the Table of House Cusp Declinations on page 162 as progressed M.C. and Asc. move forward will indicate the MED or Transit Date on which the M.C. or Asc. forms a parallel aspect with a birth chart or major progressed position.

Calculating Aspects Made by Minor Progressed Planets

—In the following examples, and in those in lesson No. 114, minor progressed positions are calculated for Greenwich noon, and minor progressed aspects are calculated to the nearest calendar day. But by calculating the precise ‘ of transiting Sun for the given time of day at the place where the individual now resides, or the time of day where the individual now resides when the transiting Sun reaches the precise ‘ it occupies when the aspect is perfect, minor progressed positions and minor progressed aspects can be ascertained with a precision of less than half an hour of calendar time. How thus to ascertain the position of the transiting Sun at a given time of day, and the time of day it reaches a given of zodiacal longitude, for any location is explained in lesson No. 116.

When an ephemeris is not available for the calendar year for which minor progressions are to be calculated, to ascertain the position of the transiting Sun use an ephemeris for the same century (1900 was not a leap year), and use a year which is a multiple of 4 added to or subtracted from the given calendar year. Thus for the year 1980, subtract 32 years and use the same date in 1948. When not thus using the ephemeris for the given calendar year there will be a few ‘s error in the position of transiting Sun, but its position will be precise enough for practical purposes.

The rules for finding minor progressed positions for any calendar date, and for finding the calendar date when any minor progressed aspect is perfect, are given in lesson No. 114.

Example 1. For chart 3b, given on page 163, calculate all the minor progressed positions for March 22, 1937: The M.C.C., calculated according to the method given in lesson No. 111, is minus OS $5^{\circ} 32'$. Subtracting the position of the Sun, $4S 6^{\circ} 42'$ from the position of the Moon, $9S 8^{\circ} 27'$, gives the Solar Constant as minus $5S 1^{\circ} 45'$.

The ephemeris on March 22, 1937, shows the Sun 1 Aries 27. Changing the algebraic sign before the S.C. and adding its $5S 1^{\circ} 45'$ to $1S 1^{\circ} 27'$ gives the position of minor progressed Moon as 3 Virgo 12.

As 1937 is 17 years after birth, consulting the Minor Progression Date Table on page 130 of lesson No. 114, we add the 1y 3mo 9d there found to the birth date, 1920y 6mo 28d, and find the approximate Mip. D. is Oct. 7, 1921. As March 22 is before the birthday, we move back in the ephemeris to Sept. 29, 1921, where we find the Moon 8 Virgo 01. This is the MED.

8 Virgo 01 is past 3 Virgo 12 (d) $4^{\circ} 49'$.

Between Sept. 28 and Sept. 29, 1921, Moon moves (c) $14^{\circ} 49'$.

Between Sept. 28 and Sept. 29, 1921, Sun moves (a) $59'$.

By logarithms, adding log. (a) 1.3875 to log. (d) .6975 gives 2.0850. Subtracting log. (c) .2095 from 2.0850 gives 1.8755, which is the log. of (b) $19'$ travel by the Sun. Using its daily motion between Sept. 28 and Sept. 29, 1921, as (a), the travel of each planet may thus be found. Subtracting this travel from its position on Sept. 29, 1921, gives its minor progressed position for March 22, 1937.

The minor progressed position of the Sun thus found is 5 Libra 29. Changing the algebraic sign before the M.C.C., add its OS $5^{\circ} 32'$ to this position of the Sun and it gives minor progressed M.C. as 11 Libra 01. Calculated by the method given in lesson No. 111, when 11 Libra 01 is on the M.C. in latitude 40-40N. 19 Sagittarius 36 is on the Asc. This is the minor progressed Asc. The minor progressed zodiacal positions for March 22, 1937, are given around the outside of the chart on page 163. The positions by declination may be found in a similar manner.

Example 2. For chart 318b, given on page 164, calculate all the minor progressed positions for May 24, 1941: The M.C.C., calculated according to the method given in lesson No. 111, is minus $2S 23^{\circ} 57'$. Subtracting the position of the Moon, $2S 17^{\circ} 48'$ from the position of the Sun, $9S 2^{\circ} 27'$, gives the Solar Constant as plus $6S 14^{\circ} 39'$

The ephemeris on May 24, 1941, shows the Sun 2 Gemini 55. Changing the algebraic sign before the S.C. and subtracting its $6S 14^{\circ} 39'$ from $3S 2^{\circ} 55'$ gives the position of minor progressed Moon as 18 Scorpio 16.

As 1941 is 21 years after birth, consulting the Minor Progression Date Table on page 130 of lesson No. 114, we add the 1y 6mo 28d there found to the birth date, 1920y 11mo 24d, and find the approximate Mip. D. is June 22, 1922. As May 24 is before the birthday, we move back in the ephemeris to June 7, 1922, where we find the Moon 18 Scorpio 16. Not only is this the MED, but as the Moon in the ephemeris is the exact ° and ‘ of minor progressed Moon on May 24, 1941, no calculations are required for the planets. Their minor progressed positions are their positions given in the ephemeris on June 7, 1922.

The minor progressed position of the Sun thus found is 15 Gemini 56. Changing the algebraic sign before the M.C.C., add its 2S 23° 57’ to this position of the Sun and it gives the minor progressed M.C. as 9 Virgo 53. Calculated by the method given in lesson No. 111, when 9 Virgo 53 is on the M. C. in latitude 39N., 27 Scorpio 03 is on the Asc. This is the minor progressed Asc. The minor progressed zodiacal positions for May 24, 1941, are given around the outside of the chart on page 164. The positions by declination may be found in a similar manner.

Example 3. For chart 3b, given on page 163, find the calendar date when major progressed Mercury inconjunct Uranus r is reinforced in 1924 by minor progressed Venus trine Uranus r.

This major progressed aspect is perfect Jan. 1, 1924. As 1924 is 4 years after birth, consulting the Minor Progression Date Table on page 130 of lesson No. 114, we add the 0y 3mo 19d there found to the birth date, 1920y 6mo 28d, and find the approximate Mip. D. is Oct. 17, 1920.

As Jan. 1 is before the birthday, we move back in the ephemeris from Oct. 17, 1920, to the MED Oct. 4, 1920, where we find Venus 5 Scorpio 46, and thus (b) 14’ past trine Uranus r. Venus is moving daily (a) 1° 14’. The Moon between Oct. 3 and Oct. 4, 1920, is moving (c) 14° 11’.

By proportion, reducing 1° 14’ gives 74’. Reducing 14° 11’ gives (c) 851’. Multiplying (c) 851 by (b) 14 gives 11914. Dividing 11914 by (a) 74 gives (d) 161’, or 2° 41’.

By logarithms, adding log. (b) 2.0122 to log. (c) .2284 gives 2.2406. Subtracting log. (a) 1.2891 from 2.2406 gives .9515, which is the log. of (d) 2° 41’.

Subtracting the 2° 41’ found by either method from the position of the Moon on Oct. 4, 1920, gives the minor progressed position of the Moon as 1 Cancer 10. From this 4S 1° 10’ subtract the S.C. 5S 1° 45’ and it gives the position of transiting Sun 29 Capricorn 25. Turning to an ephemeris for the year 1924 we find the Sun 29 Capricorn 1°, less than 12 hours’ movement from the required position, on Jan. 20, 1924. Thus Venus m is trine Uranus r Jan. 20, 1924.

Example 4. For chart 318b, given on page 164, find the calendar date when major progressed Venus trine Saturn p is reinforced in 1933 by minor progressed Venus parallel Saturn p:

This major progressed aspect is perfect June 25, 1933. As 1933 is 13 years after birth, consulting the Minor Progression Date Table on page 130 of lesson No. 114, we add the 0y 11mo 25d there found to the birth date, 1920y 11mo 24d, and find the approximate Mip. D. is Nov. 19, 1921.

On Dec. 7, 1920, the Map D. for May 24, 1933, Saturn has declination 4 N 12. As May 24 is before the birthday we move back in the ephemeris from Nov. 19, 1921, until on Nov. 1, 1921, we find Venus in declination 4 S 15. This is the MED. On this date the Moon is 27 Scorpio 42. To this 8S 27° 42' we add the S.C. found in example 2, 6S 14° 39' and it gives the position of transiting Sun on the MED as 12 Gemini 21. The ephemeris for 1933 shows the Sun on June 3 in 12 Gemini 26. Thus June 3, 1933, is the calendar date representing the MED. As major progressed Saturn moves only 2' a year by declination during 1933, its position on June 3, 1933, remains 4 N 12.

Minor progressed Venus on the MED., Nov. 1, 1921, is 4 S 15 increasing in declination, and is thus past the aspect (b) 3'.

Between Oct. 31 and Nov. 1, 1921, Venus moves by declination (a) 29'.

Between Oct. 31 and Nov. 1, 1921, Moon moves (c) 13° 34'.

By proportion, reducing 13° 34' gives (c) 814'. Multiplying (c) 814 by (b) 3' gives 2442. Dividing 2442 by (a) 29 gives (d) 84', or 1° 24'.

By logarithms, adding log. (b) 2.6812 to log. (c) .2477 gives 2.9289. Subtracting log. (a) 1.6969 from 2.9289 gives 1.2320, which is the log. of 1° 24'.

Subtracting the 1° 24' found by either method from the position of the Moon on Nov. 1, 1921, gives the position of minor progressed Moon as 26 Scorpio 18. To this 8S 26° 18' add the S.C. 6S 14° 39' and it gives the position of transiting Sun 10 Gemini 57. Turning to an ephemeris for the year 1933 we find Sun 10 Gemini 31, less than 12 hours' movement from the required position, on June 1, 1933. Thus Venus m is parallel Saturn p June 1, 1933.

Example 5. For chart 318b, given on page 164, find the calendar date when major progressed Mercury square Uranus p starts to be reinforced in 1938 by minor progressed Sun trine Mercury p.

Major progressed Mercury square Uranus p is perfect Aug. 29, 1938. As 1938 is 18 years after birth, consulting the Minor Progression Date Table on page 130 of lesson No. 114, we add the 1y 4mo 6d there found to the birth date, 1920y 11mo 24d, and find the approximate Mip. D. is March 30, 1922.

The aspect is perfect when Mercury p is 2 Sagittarius 10. It commences to be reinforced by Sun m when Sun m is approximately one degree from this position in 1 Aries 10. Moving back in the ephemeris from March 30, 1922, we find on March 22, 1922 Sun in I Aries 05. This is the MED.

The Moon on March 22, 1922, is 25 Capricorn 20. To this 10S 25° 20' add the S.C. 6S 14° 39' and it gives the position of transiting Sun on the MED as 9 Leo 59. The ephemeris for 1938 shows the Sun on Aug. 2, 1938, in 9 Leo 31. Thus Aug. 2, 1938, is the calendar date representing the MED.

Calculating major progressed Mercury, according to the method given in lesson No. 111, gives its position on Aug. 2, 1938, as 2 Sagittarius 04. During the 12 days' movement of the Moon on the MED major progressed Mercury moves 3'. As the Sun on March 22, 1922, moves 60', we subtract the 3' from the 60' which gives the gain (a) 57'.

Minor progressed Sun on calendar date Aug. 2, 1938, is 1 Aries 05 and major progressed Mercury on calendar date Aug. 2, 1938, is 2 Sagittarius 04 Therefore Sun m is within the one degree of effective orb of trine Mercury p (b) 1'.

The Moon between March 21 and March 22, 1922, moves (c) 12° 11'.

By proportion, reducing the 12° 11' gives (c) 731'. Multiplying (c) 731 by (b) 1 gives 731. Dividing 731 by (a) 57 gives (d) 13'.

By logarithms, adding log. (b) 3.1584 to log. (c) .2945 gives 3.4529. Subtracting log. (a) 1.4025 from 3.4529 gives 2.0504, which is the log. of (d) 13'.

Subtracting the 13' found by either method from the position of the Moon on March 22, 1922, gives the minor progressed position of the Moon 25 Capricorn 07. To this 10S 25° 07' add the S.C. 6S 14° 39' and it gives the position of transiting Sun 9 Leo 46. Turning to an ephemeris for the year 1938 we find the Sun 9 Leo 31, less than 12 hours' movement from the required position, on Aug. 2, 1938. Thus Sun m is applying trine Mercury P within one degree of orb Aug. 2. 1938.

Chapter 7

Serial No. 116
Original Copyright 1934
Elbert Benjamine

Copyright
Church of Light
August 2002

Transits, Revolutions and Cycles

Chapter 7

Transits, Revolutions And Cycles

THE MOST controversial of all astrological subjects relates to how much dependence can be placed on transit aspects. If an orb sufficiently wide is allowed, a transit aspect can be found that can be made to appear to account for every event of life. But when so wide an orb is used, some such transit aspect is present at all times, and there is nothing which clearly shows which of these numerous transit aspects indicates an event, and which does not. Under such circumstances the astrologer who has active extrasensory perception is able to pick the one which will coincide with an event. But those who rely exclusively on the aspect cannot do so; for while events do often coincide with transit aspects to birth chart positions, innumerable transit aspects to birth chart positions occur which do not coincide with any significant event.

The Church of Light has never maintained that transit aspects have no influence, but it has taught that their importance has been greatly over-estimated by some. Furthermore, because statistical analysis of thousands of charts progressed to the time of an event indicates there is no need to consider them, the Hermetic System pays no attention whatever to the part of fortune, Moon's nodes, progressed minor house cusps, or the Arabic or so-called sensitive points.

Both in the birth chart and by progression it confines its attention exclusively to the positions of the ten planets, the midheaven and ascendant. For predicting by natal astrology the events probable in an individual's life it pays no attention to cycles or other such charts; having discarded their use after careful statistical analysis proved them often unreliable. It has found in addition to the birth chart the only reliable-and they are reliable-factors to be major progressions, minor progressions and transit progressions.

After a vast amount of statistical research on the matter we find the following rule fully justified:

RULE: Each reinforced major progressed constant of an event or disease is always released by a transit aspect heavier than from the Moon to one of its four terminals at the time the event occurs or the disease develops. And an independent minor progressed aspect is always released by a transit aspect to one of the birth chart or major progressed terminals influenced by the minor progressed aspect at the time the event takes place.

Thus even as minor progressed aspects have two distinct influences, so also have transit progressed aspects. They exert a power, and a harmony or discord 1/365.25 of the power and harmony or discord of the same aspect between the same two planets when made by major progressed aspect. The psychokinetic power of the thought-cells receiving new energy through transit progressed aspects thus enables them to attract into the life inconsequential events. Inconsequential events coincide with characteristic transit progressed aspects.

But in addition to this independent influence, if the transit progressed aspect is to one of the terminals (as both birth chart and progressed positions are terminals, unless a planet aspects its birth chart place each progressed aspect has four terminals) of a major progressed aspect, it has a trigger effect, tending to release either the minor progressed aspect or the major progressed aspect, or both.

If a match is lighted in a room filled with cooking gas, neither the power of the explosion nor the resulting destruction is commensurate with the limited energy of the match. The power was there, and the flame of the match merely released it. The power which projects a bullet from a gun does not lie in the trigger nor in the finger which presses it. The power is in the powder. That power is released when the trigger is pressed. Until the trigger is pressed the power is not released. And we have ample statistical data indicating that transit aspects have very little power in themselves, but that they exert a trigger effect which tends to release the power of reinforced major progressed aspects, and also the power of independent minor progressed aspects.

It will now be apparent why some think transits are so powerful. At the time they happen there is always a transit aspect within one degree of perfect involving the planets having an influence over important events. However, those who ignore major progressed aspects, on an average miss one-half of such significant transit aspects; for the transit aspect to the major progressed position of a planet is as powerful as the same transit aspect to the birth chart position of the same planet. The main point, however, is that no transit aspect coincides with an important event in an individual's life unless at the SAME TIME there is a major progressed aspect involving the aspected planet which is reinforced by a minor progressed aspect.

To sum the whole matter up, nearly half a century of observation, and a quarter of a century of C. of L. statistical research, convinces us that for major events primary reliance should be placed only on the major progressed constants of the event. Minor events take place only during the periods indicated by minor progressed aspects, and major events take place only during the peaks of power indicated by minor progressed aspects which reinforce ALL the major progressed constants of the event. And the actual event takes place only when this reinforced power is released by the trigger effect of a transit aspect to one of the terminals of ALL the major progressed constants of the event.

Symbolically, the Sun is the father and the Moon is the mother, “Male and female created he them.” In higher forms of life it requires the union of male and female to conceive offspring. The Hermetic Axiom, “As it is above, so it is below”, is thus verified still further by finding that both Sun measured progressed aspects and Moon measured progressed aspects influencing ALL its progressed constants must join in the production of a major event.

In addition to gestation, however, before the event is born the energy must be released. It must become manifest on earth. As in human birth after gestation has been completed there must be the pains of labor or their equivalent before the child is released to take its own first independent breath, so in the delivery of any major event, after gestation due to major progressed aspect and minor reinforcement progressed aspect, before the event is released in the physical world there must also be a transit aspect to the significant birth chart or major progressed terminal.

The above rule enables us to eliminate the possibility of a given event or the commencement of a given disease, even during those periods while the major progressed constants are within the one effective degree of orb, and all are being reinforced by minor progressed aspects, except during those limited periods when ALL these major progressed constants are also being released by transit aspects.

It assists greatly in rectifying birth charts, as indicated on page 226 of lesson No. 117, and it enables us more precisely to time indicated events; for the event will not only occur on one of the peaks of power indicated when ALL the major progressed constants are reinforced by minor progressed aspects, but it will occur during one of these peaks of power ONLY at a time when there is also a transit aspect releasing ALL the reinforced major progressed constants of the event or disease.

But thus to be sure they are eliminated during a given period, and that a certain type of event will not occur because the trigger effect is absent, not only the zodiacal transit positions of the ten planets and the M.C. and the Asc. must be precisely ascertained, but the declinations also of all twelve transit positions. Such precision also on occasions may be required to be sure that the trigger effect is present at the time the effort is made to bring some favorable event to pass.

Transit Progressed Aspects are of Value Only When Made to Birth Chart Planets or to Major Progressed Planets

—Experience proves that the aspects among themselves of transit progressed aspects—the aspects formed in the sky—afford so little energy that, while they should be considered in starting ventures or in doing some important thing, otherwise their influence should be neglected.

But as pointed out in lesson No. 19, transit movements through the houses, especially the slower moving planets through angular houses, should be noted. And especially the conjunction with, or opposition to, birth chart or major progressed positions made by the slower moving planets should be noted, in addition to the trigger effect of transit aspects in releasing reinforced major progressed aspects or in releasing minor progressed aspects.

When we consider that the energy of a transit progressed aspect is $1/365.25$ that of the same major progressed aspect, we are apt to jump to the conclusion that their influence is too small to be noticed. But the importance of an event attracted by psychokinetic power is not in direct proportion to the number of astrodynes of the planetary energy stimulating that power. When an individual has a number of major progressed aspects involving the same planet, the accessory energy acquired by the thought-cells mapped by that planet enables them to bring into the life an event more important than if there had been but one similar major progressed aspect involving that planet. But if the energy thus received by the thought-cells is five times that received under a single similar aspect, it does not indicate the event attracted will be five times as important. Experience indicates it is likely to be less than twice as important, and perhaps only one and one-half times as important.

Under ordinary circumstances the resistance of environment to an inconsequential event is so small that even $1/365.25$ the power of a major progressed aspect, such as that of a transit aspect, may be enough to bring it to pass. But commonly the resistance of environment to really important events is so great that a similar major progressed aspect may be able to bring into the life an event only a few dozen times more important. And five or ten times the power of a single major progressed aspect may be able to bring into the life, due to the resistance of environment to more important events, an event not more than twice as important as one due to a single similar progressed aspect.

Furthermore, the environmental conditions influenced by the inner-plane weather affecting the world, as indicated by the heavy aspects in the sky such as the oppositions and squares, and especially the conjunctions of the slower moving planets, and the inner-plane weather affecting nations, cities and groups of people as indicated by the major progressed aspects in their charts of birth, have an important influence on the facilities for, or the resistance to, events indicated by progressed aspects in an individual's chart.

Our research department has observed that when drastic discords of some duration appear in the ephemeris, such as give a trend to world events of a disastrous nature, that the people through whom these world afflictions chiefly operate are those who have one or more of the planets involved prominent and severely unfavorable in their birth chart and by progression.

If the heavy aspects in the ephemeris are beneficial, those who have one or more of the planets involved prominent in their birth charts, and making favorable aspects by progression, are those most benefitted.

The customary reaction of nations, cities, communities and other groups of people having a common governing authority is set forth in Course XIII, Mundane Astrology. And the laws, customs, attitudes and fortune of the group to which an individual belongs must be taken into consideration as an environmental factor affording facility for, or resistance to, the psychokinetic power of the thought-cells given energy by a progressed aspect to bring events into the life.

As a concrete example, during both World War I and World War II we had opportunity to observe the influence of progressed aspects in the charts of a great number of people who were called into service. For people within certain age limits, who were sufficiently sound of body and mind, almost any major progressed aspect involving Mars took them into the armed service and thus changed the whole course of their lives. And under a progressed aspect involving Mars that under normal conditions would have attracted only a slight cut or burn, many a fine soldier was slain in battle.

Long Time Progressed Aspects

—People get acclimated to either customary outer-plane weather or customary inner-plane weather. Major progressed aspects between the slowly moving planets last for years, and may last throughout the whole life. The individual adjusts himself to this continuous inner-plane weather and considers it normal for his life. But at all times it is within one degree of effective orb the major progressed aspect indicates the inner-plane weather is such that, given sufficient accessory energy from another major progressed aspect, or sufficient reinforcement by a minor progressed aspect to one or more of its terminals, at a time outer-plane environment offers facilities for such an event, it may enable the thought-cells to attract into the life a characteristic event. Thus, because an aspect has been within the one degree of effective orb for years does not indicate that eventually it will not bring to pass an event typical of it, or that precautionary measures relative to it should be neglected.

While knowledge of the birth chart and progressed aspects as set forth in this course is of tremendous value, it is obvious that the more precisely the psychokinetic power of the thought-cells mapped by a planet is known, the better the individual knows the manner in which his thought-cells will react; and the more precisely their harmony or discord is known, the better it is possible to estimate the amount and kind of precautionary actions needed to enable the individual to direct his life so that events and circumstances will be to his advantage. And to give this precision of information, the relative amount of psychokinetic power is measured in astrodynes, and the relative amount of harmony or discord, and thus the strength of their trend to bring harmonious conditions, or the strength of their trend to bring discordant conditions, into the life is measured in harmodynes or discordynes. How to compute as so many astrodynes, the POWER of any planet, aspect, sign or house in the progressed chart;

and how to compute as harmodynes or discordynes the HARMONY or DISCORD of any planet, aspect, sign or house in the birth chart, or the HARMONY or DISCORD of any planet, aspect, combination of aspects, sign or house of the progressed chart, are explained with examples in Course XVI, and are explained in greater detail in the reference book, *The Astrodyne Manual*.

What Not to Tell the Client

—The object of the astrologer should be, not merely to demonstrate to his client and to the world at large how accurate in every detail his predictions are, but to be of as great assistance as possible to his client and to society as a whole.

He should never forget, therefore, that people react markedly to suggestion. In fact, a positive statement made by a determined mind builds a thought-form in the astral which works from the inner-plane to make the statement a reality. This power of suggestion, consequently, and the will of the astrologer to bring constructive events to pass, may be made of great benefit. On the other hand, it may be made a force of great destructive power.

The astrologer who predicts the death of an individual at a certain time, if the individual is aware of the prediction, may through suggestion contribute to the death. And even when the individual is unaware of the prediction, the thought-form started by the astrologer, and added to by others who believe the astrologer's prediction will be fulfilled, may be an active agent toward causing tragedy.

Frightening people is iniquitous, because their fear attracts to them disasters that otherwise never would befall.

I do not believe the astrologer ever is justified in lying to his client; but it is within his professional jurisdiction how much of what he discerns he will tell. And in what he does tell his client, he has the opportunity, and should use it, to impart advice and information in such a manner that the suggestive power, and the thought-power, of his words shall be constructive and of assistance.

The psychological effect of delineations and predictions should always be well weighed in connection with the temperament and probable reaction of those to whom made, before they are given.

Finding the Transit Progressed Positions of the Planets on a Given Calendar Date

—The transit progressed positions of the planets for any time of day, on any calendar day, are found by calculating them exactly as if they were to be placed in a birth chart for that time of day on the indicated calendar day.

Find (a) the daily motion of the planet on the given calendar day.

Find (d) the minus or plus EGMT Interval from noon on the given calendar date.

(c) is 24 hours, or 1440 minutes.

By proportion, multiply (a) by (d) and divide the product by (c). This gives (b) the distance the planet travels during the EGMT Interval.

By logarithms, add log. (a) to log. (d). The result is log. (b), the distance the planet travels during the EGMT Interval.

(b) added to, or subtracted from, the Greenwich noon position of the planet on the calendar date gives the sign, °, and ‘ it occupies at the indicated time on the given calendar day.

-Finding the Calendar Date on Which a Transit Progressed Aspect to a Birth chart or Major Progressed Position is Perfect

Find the date in the ephemeris for the calendar year nearest which the aspect is perfect.

—If a major progressed position is involved, find its major progressed position for this calendar date. Find its major progressed travel during 24 hours by dividing its travel on the Map. D. by 365. This travel is less than 1’ for all the major progressed planets other than the Moon.

Find (a) the gain in °s and ‘s of the transit progressed planet on the major progressed position during 24 hours. If the aspect is to a birth chart position, or to any progressed planet other than the Moon, (a) is the daily travel of the transit progressed planet. Major progressed Moon moves 2’ during 24 hours.

Find (b) the °s and ‘s the aspect is from perfect at the time of day represented by the ephemeris position of the transit progressed planet.

(c) is 24 hours, or 1440 minutes.

By proportion, multiply (b) by (c) and divide the product by (a). The result is (d).

By logarithms, subtract log. (a) from log. (b). The result is the log. of (d). (d) found by either method is the EGMT Interval required for the planet to move from its ephemeris position to the perfect aspect.

If the aspect is formed before the positions given on the calendar date in the ephemeris, (d) is a minus EGMT Interval on that calendar day. If the aspect is formed after the positions given on the calendar date in the ephemeris, (d) is a plus EGMT Interval on that calendar day. From this EGMT Interval find the Standard Time (watch time), or the Local Mean Time, the aspect is perfect at the place where the individual resides thus:

**Finding the Standard Time or the Local Mean
Time for a Given Place From the Minus or Plus
EGMT Interval From Noon**

—From the EGMT Interval find the EGM Time by subtracting a minus EGMT Interval from noon, or adding a plus EGMT Interval to noon.

If the place is east of Greenwich, to find the Standard Time add the number of hours of the Standard Time Zone of the place to the EGM Time; but if the place is west of Greenwich, subtract the number of hours of its Standard Time Zone from the EGM Time. The result is the sought Standard Time (watch time).

To find the Local Mean Time, multiply the number of degrees of terrestrial longitude the place is from Greenwich by 4 and call the product minutes of time, and multiply the additional number of minutes of terrestrial longitude by 4 and call the product seconds of time. This gives the time difference from Greenwich. If the place is east of Greenwich, to find the Local Mean Time, add the time difference to the EGM Time; but if the place is west of Greenwich, subtract the time difference from the EGM Time. The result is the sought Local Mean Time.

**Finding the Transit Progressed M.C. on a Given
Date**

—Instructions for this are given in lesson No. 111.

**Finding the Transit Progressed Asc. on a Given
Date**

—Instructions for this are given in lesson No. 111.

**Finding the Calendar Date From the Transit
Progressed M.C.**

—Instructions for this are given in lesson No. 111.

**Finding the Zodiacal Motion of Transit
Progressed M.C. or Asc.**

—Instructions for this are given in lesson No. 111.

**Finding the Calendar Date on Which an Aspect
From Transit Progressed M.C. or Asc. to a
Major Progressed or Birth chart Position is
Perfect.**

—Find the calendar date in the ephemeris nearest the ephemeris time the aspect is perfect.

If a major progressed position is involved, find its major progressed position for the calendar date. As the major progressed travel is less than 1' for 24 hours for all major progressed aspects other than the Moon, except for the Moon, it may be ignored.

Find (a) the gain in °s and 's of the transit progressed M.C. or Asc. on the major progressed position during 24 hours. If the aspect is to a birth chart position, or to any planet other than the Moon, (a) is the daily travel of the transit M.C. or Asc. Major progressed Moon moves 2' during 24 hours.

Find (b) the °s and 's the aspect is from perfect at the time of day represented by the ephemeris position of the planet on the given calendar date.

(c) is 24 hours, or 1440 minutes.

By proportion, reducing (b) to 's, multiply (b) by (c) and divide the product by (a). The result is (d).

By logarithms, subtract log. (a) from log. (b). The result is the log. of (d).

(d) found by either method is the EGMT Interval required for the aspect to become perfect.

If the aspect is formed before the positions given on the calendar date in the ephemeris, this is a minus EGMT Interval on that calendar day. If the aspect is formed after the positions given on the calendar date in the ephemeris, this is a plus EGMT Interval on that calendar day. From the EGMT Interval find the Standard Time (watch time), or the Local Mean Time the aspect is perfect at the place the individual resides according to instructions previously given.

**Finding the Declination of Transit Progressed
M.C. or Asc. for a Given Calendar Date**

—From the sign, °, and ' of the transit progressed M.C. or Asc. find the declination as if it were a birth chart position, as explained on page 66 of lesson No. 112.

Finding the Motion by Declination of Transit Progressed M.C. or Asc.

—Instructions for this are given in lesson No. 112.

Finding the Calendar Date on Which the Transit Progressed M.C. or Asc. Makes a Parallel Aspect With a Major Progressed or Birth chart Position

—Find the calendar date in the ephemeris nearest the ephemeris time the aspect is perfect. If a major progressed position is involved, find its major progressed declination on the calendar date. As the major progressed travel by declination is less than 1' during 24 hours, it may be ignored.

(a) is the daily motion in 's of the transit progressed M.C. or Asc. by declination.

Find (b) the 's the aspect is from perfect at the time of day represented by the ephemeris positions of the planets on the calendar date.

(c) is 24 hours, or 1440 minutes.

By proportion, multiply (b) by (c) and divide the product by (a). The result is (d).

By logarithms, subtract log. (a) from log. (b). The result is log. (d).

(d) found by either method is the EGMT Interval required for the aspect to become perfect.

If the aspect is formed before the positions given on the calendar date in the ephemeris, this is a minus EGMT Interval on that calendar day. If the aspect is formed after the positions given on the calendar date in the ephemeris, this is a plus EGMT Interval on that calendar day. From the EGMT Interval find the Standard Time (watch time), or the Local Mean Time, the aspect is perfect at the place where the individual resides according to instructions previously given.

Finding the Time of Day an Aspect in the Sky is Perfect or a Planet in the Sky Reaches a Given Sign, °, and ‘ of Zodiacal Longitude or a Given ° and ‘ of Declination

—It often is desirable to find when an aspect in the sky is perfect. In mundane astrology it is essential to determine the time of day of the New Moon, and the time of day each of the other planets passes from south to north declination. In weather predicting by astrology it is necessary to know the time of day when the Sun enters each cardinal sign, and the time of day Mercury enters each sign. In the problem as here solved it is assumed the motion of the planet is uniform. When, as often is the case of the Moon, and not infrequently in the case of Mercury, the motion is ununiform, this acceleration or deceleration must be taken into account if great precision is required. How to do this is explained later. But considering the motion uniform, in each of the mentioned problems:

Find the calendar date in the ephemeris nearest the ephemeris time the aspect or position is perfect:

—Find (a) the daily gain in °s and ‘s of the faster moving planet on the slower moving planet either in zodiacal motion or by declination. If the planet is moving to a fixed position, such as 0° N 0’ declination, (a) is the daily motion of the planet.

Find (b) the °s and ‘s the aspect is from perfect on the ephemeris date, or how far the planet must move to reach the fixed position.

(c) is 24 hours, or 1440 minutes.

By proportion, reduce (a) and (b) to ‘s. Multiply (b) by (c) and divide the product by (a). The result is (d) .

By logarithms, subtract log. (a) from log. (b). The result is log. (d).

(d) found by either method is the EGMT Interval required for the aspect to become perfect or the required position to be reached.

If the aspect is formed, or the fixed position reached, before the positions given on the calendar date in the ephemeris, (d) is a minus EGMT Interval on that calendar day. If the aspect is formed, or the fixed position reached, after the position given on the calendar date in the ephemeris, (d) is a plus EGMT Interval on that calendar day. From the EGMT Interval find the Standard Time (watch time), or the Local Mean Time, the aspect is perfect or the fixed position is reached, at the place for which it is desired to erect the chart or know the time.

Example 1. For chart 317c, given on page 194, calculate all the transit progressed positions for Jan. 19, 1932, at Greenwich Noon: The positions of all the planets are merely copied from the ephemeris for Jan. 19, 1932. Subtracting the birth chart position of the Sun, $4S 12^{\circ} 36'$, from the birth chart position of the M.C., $6S 27^{\circ} 26'$, gives the M.C.C. minus $2S 14^{\circ} 50'$. Changing the algebraic sign before the M.C.C. add its $2S 14^{\circ} 50'$ to the position of transiting Sun on Jan. 19, 1932, $10S 28^{\circ} 13'$, and it gives the transiting M.C. as 13 Aries 03. When 13 Aries 03 is on the M.C. in latitude 30, calculated by the method given in lesson No. 111, 23 Cancer 16 is on the Asc. This is the transiting Asc.

Using the Table of House Cusp Declinations given on page 162 of lesson No. 115, and the method given on page 66 of lesson No. 112, we find that when M.C. is 13 Aries 03 it has declination 5 N 09, and that when the Asc. is 23 Cancer 16, it has declination 21 N 26.

Example 2. In lesson No. 114 it was found for chart 317b that minor progressed Sun was sextile major progressed Venus on March 1, 1932, when transiting Sun was 10 Pisces 26. At what Standard Time of day at New York was this aspect perfect?

Turning to an ephemeris for 1932, on March 1 we find the Sun in 10 Pisces 43, and thus past the required position (b) $17'$.

Between Feb. 29 and March 1, 1932, the Sun is moving (a) $60'$.

(c) is 24h, or 1440m.

By proportion, multiplying (b) 17 by (c) 1440 gives 24480. Dividing 24480 by (a) 60 gives 408m, or 6h 48m.

By logarithms, subtracting log. (a) 1.3802 from log. (b) 1.9279 gives .5477, which is the log. of 6h 48m.

Subtracting the 6h 48m found by either method from Greenwich noon gives 5:12 A.M. As New York is Eastern Standard Time zone, 5h West, we subtract 5h from 5:12 A.M. and it gives minor progressed Sun sextile major progressed Venus, March 1, 1932, 12:12 A.M. New York watch time.

Example 3. In lesson No. 114 it was found for chart 317b that minor progressed Asc. was parallel major progressed Mercury on Feb. 18, 1932, when transiting Sun was 28 Aquarius 58. At what Standard Time of day at Los Angeles was this aspect perfect?

Turning to the ephemeris for 1932, on Feb. 18 we find the Sun 28 Aquarius 38, and thus lacking from the required position (b) $20'$.

On Feb. 18, 1932, the Sun is moving (a) $60'$.

(c) is 24h, or 1440m.

By proportion, multiplying (b) 20 by (c) 24h gives 480. Dividing 480 by (a) 60 gives 8h.

By logarithms, subtracting log. (a) 1.3802 from log. (b) 1.8573 gives .4771, which is the log. of 8h.

Adding the 8h found by either method to Greenwich noon gives 8:00 P.M. As Los Angeles is in Pacific Standard Time zone, 8h West, we subtract the 8h from 8:00 P.M. and it gives minor progressed Asc. parallel major progressed Mercury Feb. 18, 1932, noon, Los Angeles watch time.

Example 4. When, by Local Mean Time at Chicago, Ill., did Mercury in March, 1932, enter the sign Aries? The ephemeris on March 9, 1932, shows Mercury 29 Pisces 21, and thus lacking from the required position (b) 39'.

On March 9, 1932, Mercury is moving (a) $1^{\circ} 54'$, or 114'.

(c) is 24h, or 1440m.

By proportion, multiplying (b) 39 by (c) 1440 gives 56160. Dividing 56160 by (a) 114 gives 493', or 8h 13m.

By logarithms, subtracting log. (a) 1.1015 from log. (b) 1.5673 gives .4658, which is the log. of 8h 13m.

Adding the 8h 13m found by either method to Greenwich noon gives 8:13 P.M. As Chicago is 87:39W. we multiply the 87 by 4 and it gives 348m, and we multiply the 39 by 4 and it gives 156s, or 2m 36s. Adding these two sums gives 350m 36s West, or 5h 50m 36s West. Subtracting the 5h 50m 36s from 8h 13m 00s P.M. gives Mercury 00 Aries 00 March 9, 1932, 2h 22m 24s P.M. LMT., Chicago, Ill.

Example 5. At what Greenwich time of day on March 11, 1920, did Mars make the square of Jupiter in the sky? The ephemeris on March 10 1920, shows Jupiter R 9 Leo 03, and Mars direct 8 Scorpio 58. The aspect thus lacks of being perfect (b) 5'.

Jupiter is moving daily 5', and Mars is moving daily 3'. As one is direct and the other retrograde, we add the 5 and the 3, which gives the daily gain (a) 8'.

By proportion, multiplying (b) 5 by (c) 1440 gives 7200. Dividing 7200 by (a) 8 gives 900m, or 15h.

By logarithms, subtracting log. (a) 2.2553 from log. (b) 2.4594 gives .2041, which is the log. of 15h.

Adding the 15h found by either method to March 10, noon, gives Mars square Jupiter in the sky March 11, 3:00 A.M. Greenwich. With the planetary positions given to the "s position it works out 3:10 A.M.

Finding the Transit Progressed Position of a Planet Ununiform in Motion For a Given Time of Day

—First find the increment or decrement of the planet during the 24 hours within which its position is to be found. The increment or decrement found by taking the difference in the planet's daily motion on two consecutive days is that of the planet's average travel. And this average travel is its precise travel midway between the two noons of each day. Thus starting at midnight with the average increment or decrement, the acceleration increases or decreases as the time is distant from midnight. Therefore, by proportion or logarithms find the increment or decrement at the midway point between noon and the time for which the position is to be calculated. Add the increment thus found, or subtract the decrement thus found, to or from the daily motion of the planet. Then use this as the average gain (a) and solve the problem in the ordinary way.

Example 6. For chart 318c, calculate the precise occupied by the Moon, making due allowance for acceleration. On Nov. 24, 1920, the Moon's position is 10 Taurus 36, while on Nov. 23 its position is 26 Aries 30. Its daily motion between these two days is $14^{\circ} 06'$. Its daily motion between Nov. 24 and Nov. 25, however, is $14^{\circ} 30'$. The amount of increment during 24 hours is thus $24'$. The $14^{\circ} 30'$ is the rate of its travel Nov. 24 at plus 12h Greenwich.

We desire the position of the Moon for plus 12h EGMT Interval. The position given in the ephemeris for noon is 10 Taurus 36. We want its increment at the midway point between noon and plus 12h, or at plus 6h. Plus 6h after noon is 18h after Nov. 23 at plus 12h, or it is 6h before Nov. 24 at plus 12h. The daily increment-difference between the Moon's travel on Nov. 23 and Nov. 24-is (a) $24'$.

(c) is 24h, or 1440m.

(d) is 6h, or 360m.

By proportion, multiplying (a) by (d) 360 gives 8640. Dividing 8640 by (c) 1440 gives (b) $6'$. By logarithms, adding log. (a) 1.7781 to log. (d) .6021 gives 2.3802, which is the log. of (b) $6'$.

Subtracting the $6'$ increment found by either method from the $14^{\circ} 30'$ travel of the Moon on Nov. 24 at plus 12h, gives the average travel at midway point between noon and plus 12h as $14^{\circ} 24'$.

Without allowing for acceleration and calculating in the ordinary manner (a) is $14^{\circ} 30'$. Using this daily motion gives the Moon's position as 17 Taurus 51. But allowing for acceleration (a) is $14^{\circ} 24'$. This gives the position of the Moon more precisely as 17 Taurus 48, which is the position given it in charts 318, 318b and 318c.

Finding the Time of Day a Transit Progressed Planet Ununiform in Motion Reaches a Given Position

—First find the increment or decrement of the planet during the 24 hours within which the time of its position is to be found. The increment or decrement found by taking the difference in the planet's daily motion on two consecutive days is that of the planet's average travel. And this average travel is its precise travel midway between the two noons of each day. Thus starting at midnight with the average increment or decrement, the acceleration increases or decreases as the planet is distant from midnight. Therefore, by proportion or logarithms find the increment or decrement at the midway point between the planet's position at noon and the given position. Add the increment thus found, or subtract the decrement thus found, to or from the daily motion of the planet. Then use this as the average gain (a) and solve the problem in the ordinary way.

Example 7. When, in March, 1920, making due allowance for acceleration, does the Moon enter the sign Aquarius? On March 14, 1920, the position of the Moon is 12 Capricorn 44, and on March 15 it is 24 Capricorn 53. Its daily motion is thus $12^{\circ} 09'$. Its daily motion between March 15 and March 16 is $12^{\circ} 24'$. The amount of increment during 24h is thus $15'$.

The increment on March 15 at noon is $1/2$ of 15 or $8'$. The motion at noon, therefore, is $8'$ less than the $12^{\circ} 24'$ daily motion, or $12^{\circ} 16'$.

Reducing the daily motion, the $12^{\circ} 24'$ become $744'$. Dividing the 744 by the daily increment, $15'$, gives $50'$ travel by the Moon for each $1'$ increment. At noon March 15, 1920, the Moon lacks $5^{\circ} 07'$, or $307'$ of entering the sign Aquarius. Dividing 307 by 50 gives the increment at the time the Moon enters Aquarius as $6'$ more than its increment at noon. As we want the increment midway between noon and this position we divide the 6 by 2 and it gives $3'$. Adding this $3'$ to the $12^{\circ} 16'$ travel at noon gives the average travel for the $5^{\circ} 07'$ as $12^{\circ} 19'$.

(a) is $12^{\circ} 19'$, or $739'$.

(b) is $5^{\circ} 07'$, or $307'$.

(c) is 24h, or 1440m.

By proportion, multiplying (b) 307 by (c) 1440 gives 442080 . Dividing 442080 by (a) 739 gives (d) $598'$ or $9h 58'$. By logarithms, subtracting log. (a) $.2897$ from log. (b) $.6712$ gives $.3815$, which is the log. of (d) $9h 58'$.

Adding the $9h 58m$ found by either method to noon gives Moon 00 Aquarius 00 March 15, 1920, $9:58$ P.M. Greenwich time.

Solar Revolutions

—A solar revolution is a chart erected for the moment the transiting Sun returns to the same sign, °, and ‘ of the zodiac it occupies in the birth chart. The chart should be erected for the latitude and longitude occupied by the person at that time. Our research department has not found solar revolutions reliable in indicating what will transpire during the following year. But the time of the Sun’s transit thus over its birth chart position is a creative period of value.

Example 8. For what Standard time of day at Los Angeles, California, in 1932, should the chart for a solar revolution relative to chart 317c be erected?

July 4, 1932, the ephemeris shows the Sun 12 Cancer 16, and thus lacking from the required position (b) 20’.

The daily motion of the Sun is (a) 57’.

(c) is 24h, or 1440m.

Solving the problem in the ordinary way shows that to move (b) 20’ the Sun requires 8h 25m. From 8:25 P.M. Greenwich time, subtract the 8h Standard time difference of Los Angeles and it gives transiting Sun conjunction Sun r July 4, 1932, 0:25 P.M., Pacific Standard Time.

Lunar Revolutions

—When the transiting Moon makes the conjunction with its birth chart place is one type of lunar revolution. The other, and more creative period, is when the transiting Moon makes the conjunction with the birth chart position of the Sun. In either, the chart should be erected for the latitude and longitude occupied by the person at that time. Our research department has not found lunar revolutions reliable in indicating what will transpire during the following month. And it has not found that the house of the birth chart occupied by the New Moon is of more significance than ordinary transit positions. After doing a great deal of research on this matter it has found that an eclipse of Sun or Moon falling on a birth chart luminary or other birth chart position is of no more significance than a heavy transit.

To find the time for erecting a lunar cycle, find the time the Moon reaches the cycle position just as in calculating when an aspect is perfect, or a planet reaches a given position, as illustrated in examples 2, 3, and 4.

Diurnal Revolutions

—A diurnal revolution is a chart erected for the moment the Asc. on the given day reaches the sign, °, and ‘ of the zodiac occupied by the Asc. in the birth chart. The chart should be erected for the latitude and longitude occupied by the person at that time. Our research department has not found diurnal revolutions reliable in indicating what will happen during the following day.

Examples of finding the time of day for which to erect a chart to give a selected sign, °, and ‘ on the Asc. are given on pages 249 and 251 of lesson No. 117.

Chapter 8

Serial No. 117
Original Copyright 1934
Elbert Benjamine

Copyright
Church of Light
August 2002

Rectifying the Horoscope

Chapter 8

Rectifying The Horoscope

A BIRTH CHART, according to the views presented in these lessons, is a map of the thought-energies within the astral body of man, and the progressed aspects map the time and nature of the inner-plane weather which adds planetary energies to these thought-energies. Thus natal astrology becomes a means of estimating the various forces within man's finer body at any selected time.

These forces, like any forces of nature, if left to themselves, flow on in their accustomed channels. Thus does electricity flow, and the current of a stream, or the wind through the trees. Thus also does light from the Sun beat upon our earth. Yet all of these forces have been harnessed by man and diverted from their customary channels to perform work of his choosing.

And it has been one of the objects of this series of lessons in natal astrology to indicate not merely how the energies reaching the astral body of man may accurately be estimated as to volume and their natural trend, but also to indicate the methods by which they can be controlled, diverted, and employed to do the kind of work he most desires of them.

But if such estimation of their power is to be accurate, and if the instructions as to the manner in which they can be manipulated to perform a more constructive purpose is to be sound, the birth chart which forms the basis from which these matters are judged must be accurate.

Unfortunately, many people do not know the hour of their birth. It might be held that Nature should provide a sure and easy way to remedy this negligence upon the part of man. But so far as I have been able to discover no such easy and certain method is at hand by which we can offset the ignorance of those who have failed to realize the importance of accurately timing each birth. And in this Nature seems quite consistent; for it is her custom to exact dear payment for ignorance, no matter how innocent of wrong doing it may be.

I wish there were an easy method by which, when the day of birth alone is known, a birth chart might be rectified so that the sign, degree and minute rising might be known with certainty. Yet I have experimented with “progressing the house cusps” the “noon-point method”, the “sunrise method,” the “tidal point method,” the “octagonal point method,” the “improved Egyptian method,” the “pointer method,” methods based upon horary charts and methods based upon the person’s name, without finding in any one the precision and certainty I desire.

The magazines hold glowing advertisements of those who will rectify a birth chart by some easy and sure method. Yet I find that when a birth which is accurately timed is sent to these individuals with only the day given, that the chart returned as the correct one all too often is entirely different than the one erected for the time given by the electric clock in the maternity hospital.

There are those who boast that they never delineate a chart, even when the time of day is given, unless they first rectify it.

In our research department we have found it better always to use the time of day given. The chart thus obtained may be a few degrees in error; but we believe the error introduced by using the approximate time as ascertained by a clock by someone present at the birth, is likely to be much smaller than the error commonly occasioned in trying to make the chart fit some theory. If a birth is accurately timed I consider it a great mistake to juggle it in any way. Theories should be made to fit facts, and the observed time of birth is the fact in this case that all theories should be made to fit.

The best solution of uncertain birth-times in the future is to create a public sentiment that will insure all births being accurately timed and recorded. But in the meantime those who know the day of birth, but not the hour, need not be discouraged. If enough work is done upon a chart, with the collaboration of the person to whom the chart belongs, it is possible to rectify it, that is, to experiment with it until the sign, degree and minute on the Ascendant are precisely ascertained. But the work involved, while the benefit to the individual is worth immeasurably more than the labor expended, often is so great that the professional astrologer can not afford to give it the painstaking care that is required. His time is worth something, and he can not, for the compensation received, afford to spend several days perhaps, experimenting with a single chart.

But the astrological student himself can well afford to experiment with his chart until he is certain it is correct. Instead of a few paltry dollars, which the professional astrologer would receive as pay, it means to him, if he takes the pains to understand his chart, a far more successful life. It may mean all the difference between success and failure. He can not afford not to have his correct birth chart, whatever the cost to him in time and labor.

The First Step In Rectification

—The first step, as a general rule, is to find the rising sign. Quite frequently, as indicated in lesson No. 105, planets in the first house, the sign in which the planet ruling the cusp of the Ascendant is found, the Sun-sign and the Dominant planet, all have some influence over the personal appearance. Therefore, while occasionally the rising sign marks the person so clearly that there can be no mistake, more frequently the combined impress of these other influences is so strong as to make judgment from the appearance given solely by the rising sign unsatisfactory.

More commonly the personal appearance should be taken as but one of a number of indices pointing to the correct birth chart. It should be used in combination with these other factors, and to do this the more that is known about the person the better. The type of fortune he has had in each department of life is significant, and when the outstanding events relating to each occurred.

When the fortune which has already been attracted relative to any particular department of life is clear cut in its trend, it signifies that a planet rules the house governing that department of life which by its Key-word and the Key-word of its aspects is characteristic of that fortune.

A house may be ruled by a planet which is not in that house, it is true. But by making inquiry in reference to the events, or conditions, that the life has experienced in relation to each of the 12 houses, with a trial chart showing the aspects before one, it often quickly becomes apparent just how the planets must fit into the various houses to produce the known effects.

This is very much like piecing together a jig-saw puzzle. And to start with, if no opinion is entertained as to the rising sign, it is well to use a Natural Chart. That is, to use a chart with no-degrees Aries on the Ascendant. This trial chart may then be manipulated, by turning it around gradually, until it reaches a place in reference to the house positions of the planets, and the planetary rulership of the houses, which fits the known facts of the life. And, like a jig-saw puzzle, when the proper relations are established, it is clear that the correct combinations have been obtained.

A Natural Chart is one with Aries on the cusp of the 1st house, with Taurus on the cusp of the 2nd house, with Gemini on the cusp of the 3rd house, and so on; with the planets inserted just as they appear in the ephemeris at Greenwich on the day of birth.

This is the best of all charts to use when the hour of birth is not even approximately known, and there is no incentive for doing the great amount of work necessary to careful rectification. That is, it is better to give judgment from such a chart than to hazard a mere guess at the rising sign.

From such a Natural Chart no attempt should be made to predict the department of life influenced by each planet. It is enough in such cases to know the general significance of the planets in a house as given in lessons No. 47 and No. 116.

Starting with such a Natural Chart, which can be copied from the ephemeris for the day of birth in a few moments, the eye should follow down the page of the ephemeris and the chief aspects that form between the planets as there shown-the Major Progressed Aspects to the Progressed Planets-and the chief aspects that form between the planets in the ephemeris and the birth chart planets-the Major Progressed Aspects to birth chart planets-noted.

Even without setting up any chart, a person of ready wit can give quite a startling demonstration of astrology from a public platform with nothing to aid him but a set of ephemerides.

He asks someone in the audience to give the day and year of his birth. This date he finds in the ephemeris and marks it with his finger.

Then he runs his eye down the column of the ephemeris, or even through several pages of it if the person receiving the reading is elderly, and picks out the more spectacular aspects between the Major Progressed Planets, and from them to the birth chart planets which he has marked with his finger.

Counting ahead as many years as days have passed in the ephemeris since the birth date to the day when the aspect is formed, he then tells the audience that in such a year the individual had much trouble, that there were obstacles to overcome, that there were disappointment and loss, etc. He informs those present that in another year, which he names, the individual had good fortune, that affectional matters prospered, or that fine opportunities for advancement were present.

The general nature of the planet indicates the conditions accompanying the event, and the Key-word of the aspect, as given in lesson No. 108, indicates the nature of the fortune or misfortune attracted into the life. Lessons No. 112, No. 113, and No. 114, give still further information as to what is commonly attracted under each Major Progressed Aspect to each of the ten planets.

A student quick to note aspects and count ahead the number of days that have elapsed when they occur, can thus locate the years in which many of the chief Major Progressions form temporary stellar aeriels across the astral body, and do it about as fast as he can talk in giving such a reading from the rostrum.

By picking only the most pronounced Major Progressed Aspects in each case, he can insure that the event he describes in general terms did take place within the designated year. He can not, of course, give detail, or determine the department of life affected by the progressed aspect, as this requires that the house positions of the planets be known. But following such a method he can point out to a large number of persons in an audience during a single evening the most pronounced events of their lives, and designate the years in which they occurred.

Trial and Error

—It is because events can thus be described in general terms, and in approximate dates, without house positions, that the student must carefully distinguish between the general influence commonly exerted by a planet, and the department of life affected, in the process of rectification.

The Brotherhood of Light Astrological Reports will be found of much assistance in this trial and error process of rotating the chart until the signs and planets occupy the correct houses. The Birth Chart Constants for the various vocations may furnish valuable hints. Likewise, the Birth Chart Constants and Progressed Constants for the diseases from which the client has suffered, as set forth in Course XVI, may be employed.

Referring to these B. of L. Reports, we find that people marry, separate, or divorce, for instance, only when there is a Major Progressed Aspect to the ruler of the 7th. If legal action is taken, in obtaining a divorce or in other affairs, there is a Major Progressed Aspect at the time to the ruler of the 9th.

People lose their children, through death only when there is a Major Progressed Aspect to both the ruler of the 5th and the ruler of the 8th. Mothers die only when there is a Major Progressed Aspect to the ruler of the 10th and another to the ruler of the 8th. Fathers die only when there is a Major Progressed Aspect to the ruler of the 4th and to the ruler of the 8th. Brothers or sisters die only when there is a Major Progressed Aspect to the ruler of the 3rd and to the ruler of the 8th.

People make or lose money only when there is a Major Progressed Aspect to the ruler of the 2nd. They are ill only when there is a Major Progressed Aspect to the ruler of the 6th and a Major Progressed Aspect to the ruler of the 1st. They get employment, or lose it, only when there is a Major Progressed Aspect to the ruler of the 10th and another to the ruler of the 6th.

These Progressed Constants, and others which are given in the B. of L. Astrological Reports, as well as the department of life ruled by the house which an outstanding event chiefly influences, all can be used as indices to the relation of the houses to the signs and planets in the correct birth chart

When a chart is obtained through this trial and error method that seems to be close to the correct one, each house in turn should be given due consideration as to the events that have occurred in the department of life signified, to ascertain if the planet in it, or ruling its cusp, indicates such fortune or misfortune. Likewise, the chief Major Progressed Aspects of the planet ruling the house should be calculated to determine if the events attracted at the indicated times are such as should be expected.

Minor Progressions also are of great value to the individual who is attempting to rectify his own chart, or who is attempting to rectify the chart of some person with whom rather closely associated.

One seldom has long to wait until there is some new Minor Progressed Aspect formed of significance enough to attract some well defined Minor Event. Such events are seldom of importance enough to be marked strongly in the memory. But as they occur they are easily observed. And, quite as much as Major Progressions, they tend to attract events that relate to the departments of life ruled by the houses which the aspecting planets rule or occupy. And as they occur so frequently, it is possible to observe enough of them within a year or so, to quite thoroughly check the accuracy of the selected birth chart.

Thus if the individual is invited to some social event where he has a particularly good time, he may look up the Minor Progressed Aspect coincident with it. If a small debt which he never expected to be paid is collected, let him look up the Minor Progressions on that day and ascertain how they coincide as to house position in the selected chart with such collection. Or if he makes an enemy, takes a little trip, or any other of the numerous Minor Activities that make up the common run of life, let him observe how the Minor Progressions at the time, through their relation to house positions, bear out the chart he has decided upon.

Finding the Time of Day of the Trial Chart

—Such a trial and error chart must have approximately some degree of some sign on the 10th house. From a Table of Houses copy the other signs and degrees upon the various house cusps that are given when this sign and degree are on the 10th. Then observe in the Table of Houses what Sidereal Time corresponds to this position of sign and degree on the cusp of the 10th. Turn to the day of birth in the ephemeris and note the Sidereal Time at Noon there given. The difference between the Sidereal Time for noon as given in the ephemeris and the Sidereal Time of birth as determined from the sign and degree and on the cusp of the 10th, gives approximately the LMT Interval from Noon on the day that birth took place.

The student should note that this Interval can not be greater than 12 hours without passing into another day, and this is not permissible; for people usually know the day on which they were born. Consequently, when the difference appears greater than 12 hours, 24 hours should be added to the less Sidereal Time, and the other Sidereal Time should be subtracted from it to find the Interval from Noon.

Thus suppose we have a chart for Nov. 30, 1920, with 00 Taurus 00 on the M.C. The Sidereal Time of birth is 1h 51m 37s. Now if we subtract 1h 51m 37s from 16h 36m 13s, it gives us an Interval of 14h 44m 36s. As the Noon Sidereal Time is 16h 36m 13s and we subtract this Interval to get 1h 51m 37s, it signifies that to get the time of day we must subtract 14h 44m 36s from Noon. But this carries us back into the previous day, or Nov. 29, which as the birth was on Nov. 30 is not permissible.

Instead of doing this, therefore, we add 24h to the 1h 51m 37s, giving us 25h 51m 37s. And from this we subtract the 16h 36m 13s, which gives us 9h 15m 24s. And as to the Sidereal Time at Noon we must add this 9h 15m 24s to get the Sidereal Time of Birth, we know that this Interval is After Noon. The time of birth, consequently, is Nov. 30, 1920, 9:15 p.m. LMT minus or plus the correction of 9.86 seconds per hour for EGMT Interval.

Finding the Exact Degree and Minute on the M.C.

—When the student has the chart of birth as closely rectified as possible by the trial and error method, he should next endeavor to ascertain the exact degree and minute on the M.C. In this work he can apply either one or both of two methods. One is the Prenatal Epoch Method, and the other is to make use of progressions of, and progressions to, the Ascendant and Midheaven.

The method of using Major and Minor Progressed Aspects to and from the Asc. and M.C. is feasible only when there are events in the life that can not adequately be explained by the progressions of the planets.

Progressed aspects to the Asc. and M.C., and from the Asc. and M.C., are quite as effective in forming temporary stellar aethers which pick up energy and attract events into the life as are similar aspects to and from the planets. Consequently, if there have been strong Major Progressed Aspects to or from these Angles in the birth chart, they should have been marked by characteristic events.

The difficulty encountered in using progressed aspects to or from the Asc. and M.C. as a basis of rectification lies in the fact that more often than might be expected there is at the same time one of these progressed aspects is in force, also a progressed aspect between planets. It is not a simple matter, by any means, to determine under such circumstances just what part in attracting the event was taken by the Asc. or M.C., and what part was taken by the Major Progressed planets.

Yet we may be sure of this, that when the Major Progressed Asc. or the Major Progressed M.C makes outstanding aspects to the planets, or the Major Progressed planets make outstanding aspects to the Asc. or M.C., events of considerable importance enter the life. If the Asc. is involved, these relate to personal matters; but if the M.C. is part to the aspect the honor and business are affected. If it is discovered, therefore, that no such circumstances were present when these heavy progressed aspects formed in the trial chart, it is quite certain that it is not yet precisely correct.

A good method is first to compare the events of life that have occurred with the Major Progressed Aspects of the planets at the time of each, to discern if each event is thus properly accounted for, and if not whether a progression involving the Asc. or M.C. would better account for it. With this done, take up the Major Progressed Aspects from and to the Asc. and M.C., starting with birth and tabulating each up to the time rectification is attempted.

If the chart is correct as to the exact degree on the Asc. and M.C. the time of each progressed aspect thus tabulated will correspond to a characteristic event in the life. If events do not closely coincide with the time of these progressed aspects, the chart needs further manipulation; and in this case, if it is close to being correct, the amount of movement forward or backward required to make the Asc. and M.C. properly fit with events often is clearly indicated. As a further check, the Minor Progressed Aspects to and from the Asc. and M.C. may be employed.

This trial and error method requires persistent work and careful checking, but if carried out thoroughly gives a chart that may be relied upon more implicitly than one rectified by any other method about which I know.

The Trutine of Hermes

—Under normal conditions there seems to be an interchange of positions between the horizon at the moment of a child's conception and the place of the Moon at the moment of birth; and an interchange of positions between the place of the Moon at the moment of a child's conception and the horizon at the moment of a child's birth.

Where sympathetic relations between earth and sky are not interfered with by artificial conditions or untoward events, the degree of the zodiac on the Ascendant or Descendant at conception becomes the degree of the zodiac occupied by the Moon at birth; and the degree of the zodiac occupied by the Moon at conception becomes the degree of the zodiac on the Ascendant or Descendant at birth.

This law handed down from a remote past as the Trutine of Hermes has been amplified by modern astrologers, who have added other valuable factors. The application of this ancient law in connection with modern factors and a vast amount of detail has given rise to an elaborate theory called the Prenatal Epoch.

The Prenatal Epoch

—The prenatal epoch is of great value in rectifying horoscopes, but in my opinion, which is not shared by all astrologers, is quite valueless in rectification unless the time of birth is ascertained within half an hour of the correct time by some other method.

To apply the method it is necessary to know approximately the sign and degree occupied by the Moon at conception, and to ascertain this it becomes necessary to know approximately the sign and degree on the Ascendant at birth.

The word conception as used in this connection is not coincident with any physical act, but denotes the moment when, through the union of ovum and spermatozoon, the astral body of the child to be born becomes attached to the ovum thus fertilized. In my opinion, which is not shared by all, this attachment is never previous to the physical relations of the parents. The fertilization of the ovum and the attachment of the astral form to it, however, may occur any time during several days after the union of the parents.

With the time of birth approximately known, and the number of days of gestation definitely known, it is a simple matter to calculate the time of conception closely; for the degree occupied by the Moon in the birth chart represents the degree on the horizon at that time, and the Moon must be in a degree of the zodiac not far removed from the approximately known horizon of the birth chart.

From the degree and sign on the horizon at conception the time of day at the moment of conception may readily be calculated, and from this time the degree of the Moon at conception may be ascertained, as in any birth chart. The degree of the Moon at conception, thus found, represents the exact degree on the horizon of the birth chart.

Unfortunately for the infallibility of this method, in some cases it is very difficult to determine the exact number of days of gestation.

The enthusiastic advocates of the method have formulated some very complex Laws of Sex, based upon the supposed value of the quadrants, and the supposed sex value of certain degrees of the zodiac. Unless the chart erected for the epoch—as the true moment of conception commonly is known—by the value of the area occupied by the Moon and Ascendant confirm the sex of the child, the epoch is regarded as fictitious, and an epoch for a different day is sought.

While the Trutine of Hermes certainly seems to formulate a natural law, this “Paramount Law of Sex”, as it is called by its advocates, seems to me to be too artificial and theoretical to be relied upon implicitly. Yet it does deserve investigation and critical study, as it is a serious attempt, at least partially successful, to solve one of the most difficult situations met with in the practice of natal astrology.

Those who wish to do so can find a full exposition of the various ramifications of the “Paramount Law of Sex,” in connection with the Prenatal Epoch in a book of considerable size by E. H. Bailey, bearing the title, *The Prenatal Epoch*.

In my own investigations, and those of our research department, as near as it is possible to decide so uncertain a matter, we have found that without recourse to the “Paramount Law of Sex”, when the birth-time is approximately known, the birth chart may be rectified to the correct degree and minute of the rising sign by the Prenatal Epoch in about seven charts out of ten. About 30% of all charts, apparently, do not yield to the regular method of treatment, because the duration of gestation, due to instrumental deliveries, to artificial environment, or other conditions, does not conform to the regular rule.

There are rules given by Bailey for calculating these variations, but they soon lead into bewildering complexities that make them not entirely satisfactory. Consequently, unless the student has the time and inclination to give a very thorough and detailed study to the Prenatal Epoch, when he finds that rectification by the Prenatal Epoch gives a birth-time beyond the probable error of observation, it is better for him to make the rectification by the other previously mentioned methods.

Whether Moon and Ascendant or Moon and Descendant Should Be Used

—In applying the Prenatal Epoch the first essential knowledge is whether the interchange of places occurs between the Moon and Ascendant or between the Moon and Descendant. In determining this, as well as in determining whether the period of gestation is shorter or longer than the average, the other of the three most important birth chart factors, the Sun, must also be considered RULE 19. When in the birth chart the Moon is Increasing in light, its position is the degree on the Ascendant at the epoch, and the position of the Moon at the epoch is the degree on the Ascendant in the birth chart.

RULE 20. When in the birth chart the Moon is Decreasing in light, its position is the degree on the Descendant at the epoch, and the position of the Moon at the epoch is the degree on the Descendant in the birth chart.

Whether Gestation Is Shorter or Longer Than 273 Days

—The average period of gestation is considered to be ten lunar months, or nine calendar months, or 273 days. To know whether the period of gestation was longer or shorter than 273 days the following rules have been formulated:

RULE XXI When in the birth chart the Moon is Increasing in light and Below the earth, or is Decreasing in light and Above the earth, the period of gestation is more than 273 days.

RULE XXII. When in the birth chart the Moon is Increasing in light and Above the earth, or is Decreasing in light and Below the earth, the period of gestation is less than 273 days.

How Much Gestation Is Shorter or Longer Than 273 Days

—To find the number of days that the period of gestation was more or less than 273 days the following two rules customarily are used:

RULE XXIII. When the period of gestation is shown to be more than the average length, find the number of degrees in the birth chart between the Moon and the Horizon to which it is approaching by the diurnal rotation of the earth, and divide this number by 13 (the average daily motion of the Moon), which will give the number of days in excess of 273 occupied by gestation.

RULE XXIV. When the period of gestation is shown to be less than the average length, find the number of degrees in the birth chart between the Moon and the Horizon last crossed by it due to the diurnal motion of the earth, and divide this number by 13 (the average daily motion of the Moon), which will give the number of days less than 273 occupied by gestation.

Theoretically, counting back in the ephemeris as many days as is indicated by the above rules, the Moon should be found in the same sign and near the exact degree occupied by the Ascendant or Descendant, as determined by the above rules, in the approximate birth chart.

Unfortunately this is not always actually the case, but is usually near a day in the ephemeris in which the Moon is in such a sign and degree, and in this case that latter day should be used. In applying the Law of Sex there is a variation to the rule given by which a still further 14 days are added to the period of gestation when it is more than 273 days, or 14 additional days are subtracted when the period of gestation is shown to be less than 273 days. Further, there are supposed to be Three Irregular Epochs that because of the Law of Sex require special treatment.

Complexities begin to multiply. I believe, however, that about seven out of every ten birth charts can be rectified by the Prenatal Epoch when the time of birth is approximately known without reference to any of these elaborate and special considerations which are not held in favor by all astrologers. Let us, therefore, apply the regular Prenatal Rules to two example charts:

Example 1. A child was born in New York City, November 22, 1920, at approximately 5:00 a.m., Local Mean Time. What was the exact degree and minute rising at the true moment of birth?

First we erect a trial chart for the time of birth, inserting only the Sun and Moon (Diagram A at front of this lesson).

As the Moon is Increasing in light-moving toward the opposition with the Sun-the place of the Moon in the birth chart, 11 Aries 41, is the Ascendant at the epoch (Rule XIX). Also (Rule XXI) the period of gestation is more than 273 days.

From 6 Scorpio to 12 Aries is 156 degrees. Divide this by 13 and it gives 12 days more than 273 as the period of gestation (Rule XXIII).

Counting back 9 calendar months brings us to Feb. 22; and as we desire to find 273 days, or 10 lunar months, we look to see on what date near this day the Moon is in 12 Aries, as at birth. This is Feb. 23, 1920.

Counting 12 days back from Feb. 23 gives us Feb. 11. Here we find the Moon in 17 Scorpio. But as we have reason to believe the birth was timed within half an hour or less of being correct, we drop back another day to Feb. 10, with the Moon in 5 Scorpio 28. This then is one of the many cases in which the rule for finding the length of gestation brings us close to the correct day but does not give us the exact day.

As the Ascendant on this day of conception, or Epoch, was the place of the Moon in the birth chart, we must find at what time 11 Aries 41 was on the Ascendant on Feb. 10, 1920. The Table of Houses for New York shows that when 11 Aries 41 is on the Ascendant the Sidereal Time is 18h 27m 00s. The Sidereal Time at noon on Feb. 10 was 21h 17m 06s. Subtracting 18h 27m 00s from 21h 17m 06s gives an Interval of 2h 50m 06s before noon. To this add the correction of 9.86s per hour for the plus 2h 06m EGMT Interval (equivalent to subtracting it from the S.T.) and it gives 2h 50m 27s as the minus LMT Interval of the Epoch at New York. This means 9:10 a.m. LMT New York or plus 2h 06m EGMT Interval on Feb. 10, 1920.

The place of the Moon on Feb. 10, at plus EGMT Interval 2h 06m (9:10 a.m. LMT New York) is found to be 6 Scorpio 31. Therefore 6 Scorpio 31 was on the Ascendant at birth.

The Table of Houses for New York shows that when 6 Scorpio 31 is on the Ascendant the Sidereal Time is 9h 05m 07s. The Sidereal Time at noon on November 22, 1920, is 16h 04m 40s. Subtracting 9h 05m 07s from 16h 04m 40s gives an Interval of 6h 59m 33s before noon. From this subtract the correction of 9.86s per hour for the minus 2h 04m EGMT Interval and it gives minus 6h 59m 12s LMT Interval. Subtracting this from noon gives the LMT time of birth at New York as 5:01 a.m.

Example 2. A child was born in New York City, December 3, 1920, at 3:08 p.m., Local Mean Time. What was the exact degree and minute on the Ascendant at the true moment of birth?

First we erect a trial chart inserting the Sun and Moon only (Diagram B at the front of this lesson).

In this chart for the time given the Moon is seen to be Decreasing in light-going toward the conjunction with the Sun. Therefore (Rule XX), the position of the Moon at birth, 25 Virgo 41, was the Descendant at conception. Also (Rule XXII), the period of gestation was less than 273 days.

Applying Rule XXIV, from 26 Virgo to 17 Scorpio is 51 degrees. Divide the 51 by 13 and it gives 4 as the number of days the period of gestation was less than 273 days.

Going back in the ephemeris 9 calendar months and looking for a day close to this time that shows the Moon again in 26 Virgo, we come to March 5, 1920. However, as seen, the period of gestation was 4 days less than this average time, so we come to March 9 as the day of the Epoch.

Next we desire to know the time of day at New York when 25 Virgo 41 was on the Descendant, which is the same as when 25 Pisces 41 is on the Ascendant.

A Table of Houses for New York shows us that when 25 Pisces 41 is on the Ascendant the Sidereal Time is 17h 50m 05s. The Sidereal Time at noon on March 9, 1920, was 23h 07m 29s. Subtracting 17h 50m 05s from 23h 07m 29s gives us an Interval of 5h 17m 24s. From this subtract the correction of 9.86s per hour for the minus 21m EGMT Interval and it gives us 5h 17m 20s as the minus LMT Interval of the Epoch at New York. This means 6:43 a.m. LMT New York or 11 :39 a.m. Greenwich, March 5, 1920.

Then we calculate the position of the Moon on March 9, 1920, at 11:39 a.m. Greenwich and find it was 13 Scorpio 01. Therefore, in the birth chart 13 Scorpio 01 was on the Descendant, which gives 13 Taurus 01 on the Ascendant at the true moment of birth.

The Table of Houses for New York shows that when 13 Taurus 01 is on the Ascendant the Sidereal Time is 19h 45m 55s. The Sidereal Time at noon on December 3, 1920, is 16h 48m 02s. Subtracting 16h 48m 02s from 19h 45m 55s gives an interval of 2h 57m 53s after noon. From this subtract the correction of 9.86s per hour for the plus 7h 54m EGMT Interval, and it gives 2h 56m 35s as the plus LMT Interval. This gives the LMT time of birth at New York as 2:57 p.m.

It will be seen from the above two typical examples that rectification by the Prenatal Epoch, except when unusual conditions are present, offers no greater mathematical difficulties than are ordinarily present in the erection of a birth chart.

Occasionally a birth is encountered which does not yield to the simple rules illustrated above, and then the astrologer's resourcefulness may be taxed to the limit. In these complex cases results are more satisfactory if other methods than the Prenatal Epoch be used to check the accuracy of the birth chart obtained.

Responsibility of the Astrologer to His Client

—Telling the fortune of his client plays a very small part in the work of a reputable astrologer. Instead, his work largely consists in a careful appraisal of the possibilities open to his client as revealed by a study of his birth chart and the progressed aspects, and in offering advice and instructions that will enable him to take the utmost advantage of such possibilities.

There may be, and often are, conditions arising from the trend of national events and the activities and fortunes of other people, over which the individual has no control. And if he is informed of the nature of these events, when they will happen, and the bearing they will have upon his life, it will give him a certain advantage. With this knowledge he is able to shape his affairs in advance to conform to these conditions as they present themselves.

Yet the astrologer should be at some pains to impress upon him that most events affecting his life are not inevitable. They are attracted to him only because he has within his astral body thought-cells organized in a definite manner. It lies within his power to change the thought organization of his astral body, and to divert the energy of progressed aspects into channels that will enable only such groups of thought-cells as he chooses to become more than normally active.

The birth chart should be viewed by the astrologer as mapping the natural tendencies and qualifications with which the individual was born. It is a map of the effect of previous experiences of the soul. It is not a map of unchanging conditions, but merely of the character, and power to attract conditions, as they exist at birth.

Yet even so, it reveals the raw materials, so to speak, with which the life begins. From it the astrologer should be able to discern the avenues of endeavor which will yield the most satisfactory results from effort expended. And he should advise his client and instruct him how to proceed, utilizing the raw materials he has, to make the most of his life.

From the birth chart the astrologer thus should analyze each department of life, and discern the normal trend of the events attracted as they relate to each of these twelve departments. This information not only should be used, as indicated, to determine the line of effort into which the energies should be directed to make the most progress, but also as a basis for advice which should be given the client on how to remodel the thought-organizations in the discordant departments of life so that they will cease to attract misfortune.

Progressed aspects should not be regarded as implying inevitable events, but as temporary stellar arials stretching across the astral body that pick up, radio fashion, new energy, which if not manipulated by the individual, is added to the thought-cells in his astral body at their terminals.

If the thought-cells, working from the inner plane, are to accomplish much, that is, if they are to attract events of consequence, they must be supplied with energy. Any progressed aspect maps an aerial that supplies additional energy and thus enables the thought-cells of the astral body to do more work. They can attract events of an importance comparable to the amount of energy thus reaching them. Any progressed aspect, therefore, offers possibilities for attracting events that otherwise would not be present.

The problem is, not to prevent the energy picked up by even a discordant temporary stellar aerial from reaching the astral body, but so to divert, manipulate, or control it that the resulting activity of the thought-cells it reaches will be harmonious enough to attract fortunate events instead of disaster.

Even the most discordant temporary energy added to thought-cells in the astral body which, as shown by powerfully fortunate aspects of the planets mapping them in the birth chart, are themselves basically fortunate, is not difficult to divert, by the mental attitude or by harmonious Rallying Forces which may be present, into channels that will attract considerable good fortune. The astrologer should thus not be hasty to discourage effort under such conditions; but rather make a careful analysis of how advantage may be taken of the additional energy.

A more difficult problem is when, from the birth chart and progressed aspect, it is clear that the energy if left to itself will attract misfortune. But even in such cases possibilities are open for changing the quality of the new energy through the mental attitude. Just what those possibilities are, and to what extent his client should as completely as possible avoid certain activities and certain kinds of environment, requires keen judgment upon the part of the astrologer.

As the harmony or discord of the thought-cells determines the fortune or misfortune of the event attracted, to the extent the thought-cells in a given department of life are given greater harmony, to that extent are the events attracted more fortunate. Such harmony can be imparted either through the proper application of a Mental Antidote, or through Conversion, in either method the composition of the thought-cells being changed; or through the application of harmonious Rallying Forces, by which process harmonious energies are so completely tuned in on that they reach all temporary stellar aerials mapped by progressed aspects at the time, and thus find their way to the stellar cells governing various departments of life.

It thus becomes the work of the astrologer, among other things, to appraise the possibilities offered by progressed aspects, and to instruct his client how the thought structure of his astral body can be changed, and the new energies mapped by progressed aspects manipulated to the best advantage.

Life presents a series of problems to each individual, and the astrologer should be an expert in assisting people, with his knowledge of astrology and the working of the unconscious mind, to solve these problems in the most advantageous manner. There is a best course of action and a best mental attitude under any condition that may arise; and it is the function of the astrologer to discover these for his client, and to make them plain to him.

When pointing out to his client the trend of developing conditions which make a course of action and mental attitude advisable, he should ever bear in mind the power of suggestion. Instead of instilling the feeling of fear, he should point out the path of constructive endeavor. His outlook should be that something always can be done, even under the most adverse conditions, to make them better than they otherwise would be.

To the extent the astrologer is able to assist people, through his advice, to overcome the limitations otherwise imposed by their birth charts, to escape the afflictions otherwise attracted by the temporary stellar aeriels mapped by progressed aspects, and to attain usefulness, happiness and spirituality, is he justified in considering himself successful in his calling.

Thus will he assist others, as well as himself, to **CONTRIBUTE THEIR UTMOST TO UNIVERSAL WELFARE.**

Book 11

Copyright
Church of Light
August 2002

Divination and Character Reading

Chapter 1

Serial No. 118
Original Copyright 1940
Elbert Benjamine

Copyright
Church of Light
August 2002

Doctrine of Divination

Chapter 1

Doctrine Of Divination

Divination is the act of foreseeing or foretelling future events or discovering information not accessible through the exercise of reason and the ordinary physical senses. When this lesson was first issued, in 1923, there was a vast accumulation of scientifically checked evidence that man has faculties through which his mind can reach across space, and, irrespective of distance and physical barriers, perceive objects and events, and through which he can perceive events in the past and events in the future. But it was not until after the advent of the Pluto Period, commencing with the discovery of the planet Pluto in March, 1930, that mass methods applied to experiments gave irrefutable evidence of such faculties in not less than a dozen universities and gained for the process the now universally accepted name Extra-Sensory Perception—usually abbreviated ESP—and for its use in perceiving that which is yet in the future the name Precognition.

Although he may not be exercising ESP nor in possession of precognition, when the Midwest farmer sees dark clouds gather upon the western horizon and predicts rain, he is practicing a form of divination. The old rhyme tells us that, “A mackerel sky and mare’s-tails, Make tall ships carry low sails”; and another that, “Red clouds in morning the sailor takes warning, Red clouds at night are the sailor’s delight.”

So too, here in California in winter, and elsewhere earlier in the season, when the nights seem cold but cloudy there is little fear of frost, but when nights become both cold and clear, frost warnings go out and the citrus growers prepare to light their smudgepots. In fact, out-of-doors people—sailors, lumbermen, stockmen and fruit-growers—have a wide assortment of signs by which they attempt to predict the weather. The woodsman, for instance, examines the thickness of the bark on trees, and the Amerindian examines the quantity of food stored by chipmunks and squirrels, in an endeavor to predict if the approaching winter will be severe. They also believe if the cockle-bur ripens early and hibernating animals go into their dens before the usual time, that there will be an early winter. Whether or not such methods have any degree of reliability, any person using them in the attempt to foretell the future is practicing divination.

Knowledge of Future Conditions Has Great Practical Value

—These efforts to foreknow are not prompted by idle curiosity. Frequently preservation of life itself depends upon preparations based upon such foreknowledge. If the seafaring man waits until the blast strikes before furling sail, it may be too late. If the western stockman delays until the snow is falling to move his cattle from the high mountain meadows it is then usually too late; and many a huge band of sheep has perished thus in the High Sierras because it tarried a day or two too long. On the other hand the heavy snows may hold off another month, and if the stock can stay during this period on the free range, instead of being fed in the valley on costly hay, it may mean all the difference between profit and loss.

The lumberman may find it necessary to get in his winter supplies before the rains soften the roads, and he may find it necessary to have his logs in advantageous positions before the spring thaw and consequent freshets, that the stream may carry them to the market. The Amerindian must regulate his stores of food and his movements more or less in anticipation of weather conditions or he may perish. And the fruit-grower who fails to take warning of approaching frost may well lose in a single night the result of a year of labor. It will be seen, consequently, in these instances that success or failure, even life or death, may depend upon correct methods of divination.

Such observations are quite commonplace. But if we take a step further and examine any person's life, and every department of his life, we shall find that correct information as to approaching conditions and events may be made the means of making every such phase of his life more successful than it otherwise would have been. So often we hear the thought expressed that if one's foresight were as good as one's hindsight there would be no reasonable limit to what might be accomplished. There are opportunities surrounding every person, if the future could be clearly foreseen, that would lead on to worthwhile achievement. Doubt may arise as to whether the future may be foreseen and foretold, and doubt may be expressed as to the extent it is possible to foresee the future; yet no one, I think, will be so foolhardy as to deny that could the future be foreknown such knowledge would be of utmost value.

Evidence of Precognition

—As the type of divination to be considered in this course depends upon the exercise of Extra-Sensory Perception in what science now calls Precognition, I shall pass over the voluminous literature issued by the world's greatest men of science giving conclusive proof of telepathy, clairvoyance, clairaudience and other supernormal sensing, to a consideration of this still more wonderful and useful phenomenon of perceiving that which is yet in the future. Fortunately there has been considerable effort made by men of recognized scientific standing in the larger universities of the world to collect and verify data bearing upon this subject. Bozzano has published what is said to be an excellent book on premonitions. Camille Flammarion in *Death and Its Mystery*, gives considerable attention to premonitions, and various other eminent writers on psychical research cite instances of premonitions that can be explained only on the basis of the existence of a supernormal faculty by which otherwise unknowable future events may be perceived.

As this is being written, a radio program which specializes in strange matters frequently presents to its audience some individual who relates his own experience with precognition. To be eligible on this program the person relating the experience must have documentary evidence such as would be deemed valid in a court of law, of its authenticity.

Joseph Banks Rhine, whose mass-method experiments with the ESP cards which he invented for the purpose, made the public conscious of the significance of Extra-Sensory Perception, reports numerous instances in his Duke University experiments which can be explained only through precognition.

In the winter of 1937-38 the Zenith Foundation put on a radio program in which search was made for authentic data on the little known powers of the mind, and telepathic experiments were conducted with its audience. After thirty weeks of such work, the sponsors had received and tabulated over a quarter of a million pieces of mail. And although I have quoted this part of their findings in lesson No. 16, I will give the quotation again here:

“Authentic personal experiences indicate time is not a factor in telepathic communication. Possession of the ability to visualize in detail events which have not happened, a phenomenon science calls precognition, seems but slightly less rare than telepathy itself.”

The most systematic presentation of the evidence regarding premonitions, or divination of the future, that I have yet seen is in that notable book published the same year (1923) this course was first written, *Thirty Years of Psychical Research*, by Charles Richet, Professor of Physiology in the University of Paris. In this book Professor Richet has devoted fifty large pages to a recital and classification of carefully verified cases of premonition. As lessons on divination can only be

justifiable when divination has been demonstrated to be possible, and as the presentation of the evidence by Professor Richet and his conclusions very fairly express the views still held by the many scientific men who have conducted unprejudiced investigation of the subject, I feel I should not only refer the student to his book for evidence, but that I should quote his summing up and conclusions on the matter fully:

“A definite inference arises from these facts, whether they be important or trivial; an inference that no criticism of details can invalidate. It is that premonition is a demonstrated fact.

“In certain circumstances not as yet definable, certain individuals (mostly, though not exclusively, hypnotizable persons or mediums) can announce events to come, and give precise details on these events that are not as yet existent; details that no perspicuity, no coincidence, and no chance can account for the prediction.

“We are therefore driven to infer that the special, mysterious faculty that we have called cryptesthesia, whose nature and modes of action are unknown, is not only manifest for past and present facts, but also for future ones.

“After all, the metapsychic cognition of existing distant facts is so marvelous that cognition of the future is not so very much more extraordinary. A. knows B., six hundred miles away, is drowned. How can A. know this? We have not the least idea. A. announces that B. will be drowned tomorrow. It is only a little more marvelous. In the whole domain of metapsychic lucidity, so profound is the mystery and so impenetrable the obscurity that a little more or a little less mystery should not appall us.

“Are we then to conclude that time is only a notion of our defective mental constitution, that the future is irrevocably fated, that free will is an illusion, and that there is no moral responsibility? Long discussions might be raised on that text. I shall not enter on arguments that pertain more to metaphysics than to metapsychics, not allow myself to be led into vain speculation. I shall abide in the domain of strict facts. There are indisputable and verified facts of premonition. Their explanation may or may not come later; meanwhile the facts are there authenticated and undeniable. There are premonitions ”Are these due solely to human intelligence, or to other intelligent forces acting on our minds? It is impossible to decide. We must be content with exact observation of facts.

“And it would be inexcusably rash to affirm, as I have boldly done, that there are premonitions, if abundant and formal proof had not been advanced. This abundant and formal proof has, I think, been given.” So long a quotation would hardly be excusable were it not that in addition to the evidence proving precognition that almost anyone can find by looking for it among his acquaintances, it seems well that the public should know that the phenomenon has been exhaustively and critically investigated by eminent men of science and found to be true.

Space-Time Relativity Permits Precognition

—One of the most thoroughly established foundations of present-day physical science is that, as Einstein and certain physicists who preceded him pointed out time and velocity are always related to each other as a ratio such that when any new time condition is present the velocity on that time-level can be determined by inverse proportion, and when any new velocity level is present the rate of time-flow there can be determined by inverse proportion. In other words, as time increases, velocities slow down; and as velocities increase, time slows down. As explained in lesson No. 14, proof of such slowing down of time when velocities increase has been provided experimentally, and the time factor in the operation of progressed aspects in natal astrology depends upon this space-time inter-relationship.

Man normally lives in two realms. He lives, moves and is conscious in a physical world in which time is rapid and velocities comparatively slow. But his soul, which is identical with his unconscious mind, habitually lives in a realm where velocities are greater than the 186,173 miles per second which light, radiation and electromagnetic waves travel when unimpeded. Yet the mathematicians, headed by Einstein, hold that physical velocities cannot exceed that of light, and that anything moving with the velocity of light no longer possesses length, has infinite mass and so is impervious to the pull of gravitation, and that for it time has come to a standstill. In other words, in the region where the soul chiefly functions, on the inner plane or astral world, velocities are greater than those of light and there consequently is a different order of gravitation, a different order of distance, and a different order of time, all of which is explained more fully in lesson No. 16.

Connecting these two realms in both of which all incarnated life constantly functions, are light, electromagnetic waves and radiations which have velocities approximately those of light. And, as explained in detail in lesson No. 11, the region where mind functions, the astral realm, can be affected by physical conditions only by first communicating its motions to this Boundary-Line energy; and vice versa, the astral realm and mind can contact and affect anything physical only through first communicating energies to this Boundary-Line electromagnetic energy which then passes it on to the physical.

Consciousness Can Function on Many Levels

—When the attention, sustained by electromagnetic energies of the frequency of the Cerebral System, is directed to perceiving objects on the physical plane, there is objective consciousness of the reports of the physical senses; and when the Attention is directed to cerebral processes the energies stimulate and support objective thinking.

Sleep is a no-man's-land between such consciousness on the physical plane and consciousness on the astral plane. From that state, to the extent the Attention can mobilize electromagnetic energies of the cerebral frequency and direct them to happenings on the physical plane, is the sleeper aware of what is going on about him in the physical world. Physical sensations thus reaching his consciousness afford suggestions which give trend to his dream.

In this state of sleep, or a similar condition induced for the purpose, if the Attention moves neither out to become conscious of the material plane, nor in where velocities exceed those of light, the consciousness remains chiefly linked with electromagnetic energies, and because it is not fully conscious on either plane, but in the no-man's-land where Boundary-Line energies are dominant, it is highly susceptible to suggestion and devoid of discrimination. The subconscious mind referred to by many writers is a consciousness functioning almost exclusively in this Boundary-Line region.

Electromagnetic waves, as we see demonstrated in radio, have the power to move almost instantly to distant places on the earth. They have the power to make considerable impact on a suitably tuned instrument at a distance; but to do much work thus at a distant point the receiving set must itself provide electrical energy suitable to amplify the modulated carrier waves picked up.

Consciousness can be extended in association with electromagnetic waves. It can make an impact thus on those at a distance, and have considerable influence provided the receiver is tuned to the same frequencies and is generating electrical energies suitable for amplifying what is thus received. And consciousness thus extended in association with electromagnetic energies can become aware of distant happenings on the earth, and to a limited extent even of events yet to come. Extension of consciousness occurs in many degrees, all the way from the perceptions of the physical senses on the plane of matter, through the region of Boundary-Line electromagnetic energies, to the various ascending levels of the astral world into a region which has still higher velocities called spiritual.

In the no-man's-land of sleep if the Attention is turned to the inner plane the consciousness in some degree becomes aware of stimuli reaching it from the astral realm where, as velocities are greater than those of light, time relations, as well as those of distance and gravitation are of quite a different order than those either on the physical plane or in the electromagnetic Boundary-Line region. Almost anyone who will systematically endeavor to do so, and thus turn the Attention of his soul to the inner plane during sleep, and over a few weeks keep a careful record of his dreams, will become convinced that his consciousness has become aware of some events long before they happen or could be surmised from ordinary waking sources. To keep such a record, the dreams should be written down in full detail in the morning before thinking about them. In the state between sleep and waking there is usually remembrance of dreams, but it is largely destroyed as soon as cerebral thinking commences.

It is not to be expected that such dreams at first will give full and correct pictures. But fragments recorded will so amazingly coincide, either actually or through symbols, with some of the situations or events which occur a day, several days, or even weeks later, that little doubt will remain that some portion of the consciousness has precognition of some events.

Such dreams should be regarded, not as complete inner awareness of the details of the future event, but as a distortion of the fantasy thinking common to the no-man's-land of sleep by the impacts of stimuli relating to the event from the astral plane. They should be considered in the category of imperfectly perceived conditions, just as stimuli coming from the outer world also distort the fantasy thinking common to sleep. Too many covers, producing the sensation of weight, may cause an individual to dream of being between the closing jaws of some huge press; or if they cause him to become too warm, he may dream of being in the tropics. The exact trend the fantasy will take depends largely upon the power of desires in his unconscious mind, his experiences in the preceding waking state, and past experiences in his life which have conditioned his mental associations. The stimuli reaching his consciousness in the no-man's-land from either the outer plane or the inner plane under such conditions is not powerful enough to displace the fantasies passing through the mind, but only to warp them from their course and to inject into them an occasional image, symbolic or real, pointing unmistakably to the source of the stimuli.

Yet just as consciousness can move out from the no-man's-land of sleep where Boundary-Line energy and suggestion chiefly prevail, to become vividly aware of the happenings on the space-time ratio which we call the physical world, so also can it, through diverting sufficient electrical energy to upper-octave electromagnetic radiations which are transformed into inner-plane energies, and holding its Attention there, move out on the astral plane where a new order of space-time relations prevails.

Unlike the physical world, this astral world has numerous levels of existence on each of which a wide variety of life functions. As explained in detail in lesson No. 16, an astral entity, or the consciousness of an individual yet on the physical plane, is pulled to the basic astral level by its dominant vibratory rate, much as gravitation keeps physical objects fastened to or near the earth.

Every physical object has its astral counterpart, even though there are many astral objects and entities which have no physical counterparts. And as distance on the inner-plane, as explained in lesson No. 16, is not of the same order as on the physical, but is the relation between vibratory rates, consciousness functioning on the inner plane can bridge the distance instantly to any object or person on the inner plane, including the astral counterparts of any thing physical, to which it can sufficiently adjust its vibratory rates.

Future Events Seen on the Inner Plane

—Much experience with astrology and with prevision has brought the conviction, born of actual observation rather than of theory, that events which have not yet come to pass are not fixed unalterably along the time dimension. It is true that mathematically time can validly be considered as the fourth dimension. The soul, or unconscious mind of an individual, is the organization in finer than physical substance of the sum total of his past experiences. It and all objects, move along this fourth dimension we call time. The line of movement of anything thus through time is called its World-Line. All back of the Now point in each object's or soul's world-line is fixed in the time dimensions; its place at any moment of the past cannot be altered. And when the consciousness is extended to an object or person on the inner plane, this world-line can be perceived, and if the attention can be focused on any particular point in that world-line, what happened at that time in the past, with details of the conditions affecting it can be perceived.

Atheistic materialism, with its view that life is nothing more than a mechanism, postulates that time in essence is not different from the other three dimensions. It holds to the attitude that what appears to our consciousness as the passing of time is in reality our consciousness moving along a fixed time dimension in which not only the past, but also the future, is unalterable. It takes this view because it denies the existence of a soul which functions apart from physical conditions and which possesses intelligence and initiative to change the future of its world-lines; for in a perfectly predetermined scheme of things, in a universe where all conditions are caused by purely mechanical reactions, the world-lines would thus be fixed throughout their total length.

However, it is easy to fall into the erroneous assumption that a mathematical formula which is valid for objects possessing neither intelligence nor initiative, is equally valid for intelligent life. But nowhere have we witnessed any work by these atheistic materialists which would prove any such unwarranted assumption. As a matter of fact, it is merely the extension of their prejudiced assumption that mind cannot exist apart from a physical body, and is merely one function of the material organism.

Yet there is a tremendous volume of evidence available to prove the survival of personality after physical dissolution, and to prove that the soul, even while still occupying a physical body, can exercise ESP and EPP (Extra-Physical Power) in violation of the very mechanical principles on which the atheistic materialists base their conclusions. Instead of time being a dimension in the same category as the other three, it has a unique quality of flexibility such that, within certain limits, world-lines extending forward from the Now point can be changed through intelligent initiative. In other words, in so far as the future is concerned, the position of a soul or object along the time dimension is subject to the power of mind.

This flexibility in response to the action of mind is due to the mind occupying a region where velocities are so great that ordinary time no longer exists and a new order of duration has taken its place. Consciousness on the astral plane has moved out and away from the ordinary time dimension—for according to the mathematicians, at the velocity of light ordinary time comes to a standstill—but is still able to view events along the ordinary time dimension.

By way of illustration let us suppose that equipped with a powerful telescope we leave the earth in an airplane capable of climbing into the stratosphere. At the time of making this ascent a recent fall of snow has spread its mantle over the landscape.

While we were walking about the surface of the earth unequipped with the telescope our view of things was limited by the weakness of our eyesight, by obstacles, such as trees and houses and mountains, and by the curvature of the surface of the earth. The tracks people and automobiles were making in the snow could be observed only over short distances.

But as we ascend toward the stratosphere the whole country spreads out before us. Buildings and trees and mountains no longer obstruct our view. By training our powerful telescope on the tracks in the snow—as we observe world-lines on the astral plane—we can trace the movements of pedestrians, automobiles and animals. If necessary we can move back long distances on a particular track in the snow, and through the higher velocity which our airplane gives us, follow the track up to the Now point, where the track maker is now located. Scrutiny of his track will give us considerable information about what he did at various points in his journey. And from observing the direction in which the track has come, and the direction the track-maker continues to move, we may be able with much accuracy to project the track—comparable to his world-line—into the future and state where he is going and about when he will arrive at a certain place.

Furthermore, by observing from our airplane the movements of others, and their world-line like tracks, we may be able to foresee when such individuals will encounter our track-maker, and come to a conclusion as to the probable result of the meetings as influencing his conduct. Or from our vantage point we may see ahead of him a raging river, with the bridge washed out, and decide he will be compelled there to turn from his original course. Before deciding this, however, we will probably look ahead of this track-maker's Now point—which we can easily do with our telescope—and observe if, from some distant point a repair crew may be on its way to make crossing the river possible.

The action of such a repair crew, and the action of the track-maker, are not inevitable beyond their Now points. A message dropped by us from the airplane—or reaching them through divination or knowledge of astrology—readily could change the direction of travel—world-line—of either. Neither the repair crew nor the track-maker is aware of the existence of the other, and the track-maker is unaware that at a certain point in his future he will come to a raging torrent which he will be unable to cross unless a repair crew, of whose existence he has no knowledge, arrives on the bank of the river and through its work repairs damage he has no way of knowing about.

Consciousness functioning on the inner plane not only has the advantage of the wider view we enjoyed looking through the telescope in our imaginary airplane survey of conditions, but facilities for grasping in detail innumerable world-lines which may have some bearing upon the future of some particular world-line we are exploring, and tremendously increased powers of correct deduction from the multiple factors thus apprehended.

Looking along such a world-line and projecting it into the future it views a place where, due to the converging of other world-lines whose directions are plainly visible, a certain event, unless these world-lines are suddenly changed through the intervention of intelligently directed initiative, will take place.

On the inner plane thought is the objective reality; that is, in a thought-built region, thought-created structures are as real as the astral counterparts of physical things. They may, or may not, according to the type of energy used in their building, be as permanent as the astral counterpart of such physical things. But so long as they last they can be seen just as the astral counterparts of physical objects, and the astral bodies of discarnate souls, can be seen.

I think all of us have witnessed conditions parallel to two autos speeding toward an intersection, the drivers for some reason oblivious of the approach of the other car from a street at right-angles. When the speeding cars—perhaps we were back-seat passengers in one of them—were so close that collision seemed inevitable, our imagination supplied the detail of the crash so that we visioned flying glass and battered iron, and bracing ourselves felt the shock of impact. Yet the crash was not inevitable until the cars actually met. Possibly our shout of warning called the attention of one or both drivers to the danger just in time to enable a quick swerve to avoid disaster.

On the inner plane where thought is the dominant force, the correct mental imagery of the details of some event that seems inevitable because various world-lines are converging to make it happen, takes on a reality many fold more vivid than such mental images assume on the physical plane. They become temporary thought-structures which can be seen, or heard or felt, by the astral senses, and as such become the source of precognition.

Yet just as the cars in our illustration were not predestined to meet in a crash, events observed through precognition are not inevitable. In the first place, the deductions from the directions of their world-lines may not be perfect. In the second place, as occurred in our car illustration, the interference of intelligent initiative may suddenly alter the course of one or more world-line. Knowledge obtained through astrology or divination may not have been taken into account by the previsioning intelligence. The sudden interjection of information so acquired, and resolute acting based upon it, may so change the otherwise normal course of an individual's world-line that a given event apprehended through prevision will be markedly changed. The individual's reaction to a given set of conditions is not predetermined. The probability may be high that he will do a certain thing. But until his Now point has reached the event it is not inevitable.

The Limits Set Upon Intelligence and Initiative

—Our power to alter conditions extends no great distance beyond our own reactions to the world-lines of other individuals and other things. Knowing that a storm, either physical or planetary, is on the way does not give us the power to make the storm turn aside or abate. We can warn others of the storm, and urge them to seek shelter with us before it breaks. With knowledge of approaching conditions—including those of what others almost certainly will do—we have full liberty to seek shelter or stand bareheaded and firm under the sky glorying in the raging wind and drenching rain.

We may be able to persuade a few to protect themselves from such a storm which, from the inner plane or through astrology we see approaching; or to take full advantage of fair weather and bright sunshine which we prevision. Yet the forces of nature are so stupendous, and the movement of the multitude so weighty that we cannot expect to change them to any great extent. But if we have precognition of the action of natural forces and the events which in great probability will befall our fellowmen, we are not subjects of blind fatality; for while not able to change such tremendous forces as exist outside ourselves to any great extent, we yet retain the ability to choose our own methods of meeting these environmental conditions.

We cannot keep the earth from turning on its axis and carrying us in its daily circle, but we can determine whether that diurnal circle we each perform shall be large or small, and whether under hot skies or cold. If we prefer the heat we may move toward the equator and travel farther, but if we prefer the cold we may move away from the equator of the earth, and the farther we move the smaller becomes our daily trip from noon to noon. Perceiving the future does not imply, for us, fatality; for so far as we are concerned our actions may be changed and the future altered at any time before the presignified event happens. But such freewill implies two things: a knowledge of what is approaching in the future unless we do something special to change the course of our world-lines, and intelligence and initiative enough to do the special thing required thus to alter world-lines.

Senses and Faculties of the Soul

—Each person, by virtue of being human, has a soul, or unconscious mind, which is possessed of senses corresponding to those physical but which can be exercised on the inner plane, and which is possessed of faculties for appraising what is sensed and drawing correct conclusions. But that does not mean that every person has ability without training to use these senses and faculties effectively; no more so than the fact that every person has a brain implies that every person can make correct observations and draw accurate conclusions from them. Most people have a brain that, if they trained themselves, would enable them to solve reasonably difficult problems in mathematics. And most people have faculties which, if they trained them sufficiently, would enable them to become rather efficient in precognition; but only a few people—mathematical prodigies—can master mathematics without training; and only a few people—natural psychics—can get precognitions consistently without training.

The training of the individual in the exercise of his soul senses—ESP—and in performing work on the inner plane—EPP—was a part of the work of ancient initiation. As much of the processes and principles of such training are set forth in Course IV, Ancient Masonry, as it seems wise to give the general public. Complete details and instructions are set forth in the NOT SOLD B. of L. lessons. This reserving of detailed instructions is not due to any desire to keep information secret.

On the contrary, we desire as many as possible to have all the information we possess. But it is not wise to give formulas for making TNT and other deadly explosives to those who have no knowledge of chemistry; nor do we deem it wise to give too much instruction on the development of inner plane faculties to those who are ignorant of the principles of occultism. Any member who will through passing examinations demonstrate he has sufficient knowledge of occult matters safely to be entrusted with that knowledge, will be given, free of charge, the NOT SOLD lessons containing the designated information.

As set forth in lesson No. 18, there are three methods of acquiring information from the inner plane. One of these methods—Mediumship—we do all we can to discourage. Another of these methods—Feeling ESP—we advise should be approached with caution. The third method—Intellectual ESP—in so far as our extensive observation with numerous students goes, seems both desirable and without danger.

More details of the distinction among the three methods are given in lesson No. 18, but the chief differences are that in mediumship there is partial or complete control of the medium by some intelligence other than his own; in Feeling ESP the individual who tunes in on something or some entity has a lower potential in his nervous system or some part of it than that which is tuned in on, and picks up, radio fashion, the astral vibrations of that which is thus contacted on the inner plane, and “takes on,” or feels, the information sought; while in Intellectual ESP the individual maintains a higher potential than that contacted through extension of consciousness.

Either Feeling ESP or Intellectual ESP can be exercised with equal success without a divinatory instrument or with one; but in Intellectual ESP, which alone we can give our complete endorsement, feeling or hyper-sensitivity plays no more part in the search for the required information made by the unconscious mind on the inner plane than it does in a similar search by objective consciousness made on the physical plane, nor are the emotions more active. The examination of conditions is conducted by the unconscious mind, or soul, on the inner plane and may include an inspection of the world-lines as revealing past and probable future as well as aspects of the present about which information is sought. It is an intellectual appraisal the results of which are not communicated to other sections of the nervous system, but, much as something is remembered even though seen but a moment before, is communicated directly to the brain as an Intellectual awareness.

The Function of Divinatory Instruments

—Whether the less desirable Feeling ESP or the more desirable Intellectual ESP be employed, if information is not available through ordinary physical channels is to be acquired the soul must exercise its senses or functions on the inner plane to apprehend the wanted information. After the soul has acquired the information about past, present or future, this information then resides in the unconscious mind, or soul, as a memory. Soul senses are incapable of contacting physical conditions directly. But they can contact the astral counterparts of those conditions and sense their world-lines. Yet to be made available for physical use this information which has become a memory of an inner plane experience must be brought up into objective consciousness. The interval between the astral experience and its objective recognition may be imperceptible, but thus to gain for it objective recognition it must be able to communicate its motions to electrical energies generated by the nervous system in such a manner that these vibrate the physical brain cells.

All people have soul senses and soul faculties, and most have some ability to direct these senses and faculties into inner plane activities by which considerable information is apprehended by the unconscious mind. Occasional strong inner plane stimuli are sufficiently recognized by objective consciousness to be considered intuitions, hunches, or even undefined premonitions. And nearly everyone, even without the more exacting training by which ESP (Extra-Sensory Perception) and EPP (Extra-Physical Power) can be exercised independently of any external crutch, can, through the use of some divinatory instrument learn to get considerable information otherwise unobtainable, including some precognition.

Divinatory instruments vary, and are handled in different ways; but their function always is twofold: to direct the Attention and activities of the inner plane senses and faculties toward obtaining specific information, and to aid in bringing that information, when the soul has acquired it, through from the inner plane region to objective consciousness.

Outer-Plane Matter and Inner-Plane Substance.

—Psychics in reporting on their experiences sometimes refer to quite a variety of planes and substances. Some refer to etheric substance, to the emotional plane and emotional substance, to the astral plane and astral substance, to the mental plane and mental substance, and to finer substances of still higher planes.

Although our experiences are identical in most respects with theirs, we believe a different terminology is more scientifically accurate. Difference of plane does not depend essentially on vibratory frequency, or on coarseness of substance, but on the customary velocities of the region. Anything which has a velocity much lower than that of light partakes of the physical space-time relationships, and consequently can be considered physical. Anything which has a velocity greater than light no longer obeys the laws imposed by physical space-time relationships, and is astral or some higher order of existence. Velocities approximately those of light partake somewhat of the properties of both the inner and the outer plane, and are indications of the existence of what we call Boundary-Line substance, or electromagnetism.

Now consciousness and sensation, thought and feeling, cannot be completely separated in view of the fact that all thought is accompanied by some degree of feeling and all feeling is accompanied by some degree of consciousness which in turn depends upon mental activity. The individual while occupying a physical body is dependent upon electrical energies for both thought and feeling. It is only when these electrical energies impart their vibrations to his nervous system that he feels anything, and emotion is the feeling produced by voluminous discharges of electrical energy in response to thoughts relating to various emergency situations. Other thoughts develop their own characteristic electrical discharges, which vary, due to their frequencies, in the kind of feeling produced, even as do the different emotions, and are of different volume and intensity. On the physical plane thought and emotion are not reactions to two different kinds of energy, but are different expressions of electrical energy as affecting the nervous system and recognized by consciousness. Nor is there on the inner plane one substance which reacts exclusively to emotion and feeling and another substance which reacts exclusively to thought. Instead, on any plane or level where the soul functions, it is capable of both emotion and thought. Nowhere is it devoid of feeling or of some degree of consciousness; but the quality of either emotion or thought is different on different vibratory levels.

On the astral plane, as I have already indicated, there are a great number of levels on each of which conscious life can and does function. That which determines the level on which consciousness functions is the soul's dominant vibratory rate at that time. Emotion on any plane is a response to thought, and the dominant emotion or mood determines the level of the astral plane to which the soul then moves. And it certainly is true that a consciousness which habitually engages in cold reasoning functions on a quite different astral level than does a consciousness which is habitually dominated by gusts of emotion.

It is also true that the coarser emotions drop the soul to astral levels where the vibration is comparatively slow, while protracted mental effort in the attempt to solve some difficult problem carries the soul to a level of higher vibratory rates, and religious ecstasy takes it into regions of great vibratory frequency.

Vibratory frequency, however, is not that by which different planes are distinguished, even though—as is illustrated between matter and Boundary-Line substance when material substance gains enough in molecular vibration to give off light—high frequency of vibration of lower plane substance may communicate energy to substance which, because of its velocity, belongs to the plane interior. That which distinguishes planes from each other are the velocities there commonly encountered. Mind functions in contact with various planes and various levels of those planes, and on them experiences emotion. And although until we arrive on the astral plane without physical bodies and through personal experience come to understand more fully how life performs its functions there it seems useless to say much about the plane still interior to it, yet there is a region of still higher velocities, which we call the spiritual plane.

Most of that contacted by people who speak of the spiritual plane is really the higher, more spiritual levels, of the astral plane. And until we have had extensive experience with astral conditions, through actually living there without physical bodies to limit our conception, we can talk no more intelligently about condition on the spiritual plane than a student can talk intelligently about equations in calculus who as yet is only learning to add, subtract, multiply and divide the simplest kind of problems in arithmetic. I mean that, occupying the low-velocity speedy-time plane of physical matter so much of our lives, the best we can hope to do in comprehending astral plane conditions is comparable to such simple arithmetical problems. However, just because as yet we cannot comprehend its problems, we need not deny the existence of regions to understand which requires an advance in our abilities comparable to that from elementary arithmetic to calculus.

Prejudice Against Divination

—The prejudice against the use of divinatory instruments is not without some valid foundation; for those who, instead of using Intellectual ESP, cultivate hypersensitivity, sometimes get so accustomed to picking up the feel of things from the inner plane that it is difficult for them to shut out that which they do not wish to contact. This is not the fault of divination, but of using the wrong technique.

To those who hold divination is the work of the devil, I would point out that all scientific investigation not so long ago was subjected to the same charge. But the churches today no longer consider the geologist, for instance, sinful for uncovering proof of the great age of the earth. And we may be sure, when the churches come to realize that through ESP people can acquire proof of the after-life, and not be compelled to accept or reject it merely on belief, that they will welcome it as the most effective weapon they can use to bring about the defeat of atheistic materialism.

Chapter 2

Serial No. 119
Original Copyright 1940
Elbert Benjamine

Copyright
Church of Light
August 2002

Teacup and Coffee Cup Divination

Chapter 2

Teacup And Coffee Cup Divination

ALTHOUGH there are astrological methods, in which the trends of astrological currents and their influence upon events are employed, and methods depending upon the observation of natural phenomena such as out-of-doors people often use, most divination depends upon the exercise, in some degree, of that which now is called Extra-Sensory Perception, more commonly referred to merely as ESP.

This means that the diviner exercises, on the inner plane where they are not subject to the restrictions of time, gravitation and distance imposed by physical substance, the senses and faculties of his soul. Soul and conscious mind are synonymous terms for the sum total of an individual's consciousness as it persists upon the inner plane. His objective consciousness consists of such portions of this consciousness of his soul as, through electrical energies generated in the nervous system, can at the time impart their energies to the cells of the physical brain. Most methods of divination stimulate the senses and faculties of the soul to gain the desired information on the inner plane and then project it up into the brain in such a manner that it can be objectively recognized.

The ability of the senses and faculties of the soul to acquire information on the inner plane is as susceptible to development through training as is the ability of the physical senses and faculties to acquire information on the physical plane. Yet even as the normal individual with almost no training can acquire considerable information from physical sources, so the normal individual also has the power to acquire considerable information through ESP even though he has had no previous experience or special training. And although those specially gifted, and those who have had sufficient training, do not need such helps, others find some form of divinatory instrument a decided advantage. With it, much as a scientist can see things with a microscope or a telescope which are invisible to his unaided eye, they are able to bring information through from the inner plane of which they would be totally unaware without its assistance.

Direct Perception and Symbolic Perception

—While the soul senses cannot contact physical conditions directly, they can contact the astral counterparts of physical things and trace their world-lines as well as gain access to information which belongs exclusively to the inner plane. But whatever information is thus acquired from inner-plane sources, before it can be recognized by objective consciousness, or whether it is ever recognized by objective consciousness, first resides as a memory in the soul, or unconscious mind. And to bring it through into objective recognition it is subject to the processes that enable physical perceptions or objective conclusions to be remembered.

Yet in comparison to physical experiences which the individual strives to remember these Extra-Sensory Perceptions are heavily handicapped. The physical experiences when they entered consciousness utilized electrical energies to modify the physical brain-cells. It was this impression of the physical brain-cells which constituted objective consciousness of the experiences. The electrical energy associated with the brain-cells thus impressed imparted some of its motions to the inner-plane substance of the soul. And this organization of energy within the soul persisted in the soul as a memory.

Now to remember some physical experience, or some thought which once has passed through the brain, requires that the inner-plane organization of energy within the soul which constitutes the real memory of the occurrence or thought shall connect up with electrical energies in the brain sufficiently that it can use them again to impress the brain-cells in the same manner they were impressed when the experience to be remembered first took place. But as channels for electrical energies of the required modulation already have been established to the brain-cells that originally registered the experience, and as the brain-cells have already been modified to accommodate objective consciousness of the experience or thought, the soul needs to command very little electrical energy to cause the experience or thought to be remembered. As soon as the experience or thought gains the attention of the soul and thus acquires some additional inner-plane energy by which electrical currents can be set in motion, these electrical currents find both an open channel and preconditioned brain-cells waiting to give the memory objective recognition.

But an inner-plane experience finds no such open channel, and no such electromagnetically preconditioned brain-cells waiting to register the impression. Instead, it must either command sufficient electrical energy to make its own path and impress brain-cells as they have not before been impressed, or it must follow channels already prepared by previous experiences and impress brain-cells in the manner they at some previous time have been impressed.

The electrical energies that more commonly can be commanded by an inner-plane experience are not vigorous enough to make new paths and impress brain-cells that have not previously been properly modified. When they move through the brain, therefore, they are deflected from the course which would register direct perception of the experience into channels which lead to brain-cells which have previously registered other experiences which are closely associated in the unconscious mind with these experiences. That is, they follow the line of least resistance.

Furthermore, this principle of following the line of least resistance applies also to the image or thought even before it communicates its energy to electromagnetic forces. There are conflicts and repressions and various forms of competitions between factors in the unconscious mind which make it easy for some thoughts and images to acquire much energy for purposes of expression, and which restrict or prohibit other images from acquiring energy for purposes of expression. Censorship or emotional accentuation exists for many images in varying degrees. Thus that which is recognized by objective consciousness after some Extra-Sensory Perception more frequently is not that which was actually witnessed on the inner plane, but quite different images which are tied, through the Law of Association, to that which was actually perceived.

The unconscious mind, for reasons fully explained in lesson No. 58, finds it easier to communicate whatever it has perceived to objective consciousness by means of symbols rather than by means of lately acquired arbitrary words. And it also, for the reason just explained, usually finds it easier to present to objective consciousness images which are linked through association with what it perceived, than to present the images it actually perceived, and as they reside in the memory of the soul.

Extra-Sensory Perceptions, therefore, are of two types, direct perceptions and symbolic perceptions. Direct perceptions are those in which the images and information are presented to objective consciousness as they are perceived by the soul. Symbolic perceptions are those in which the images and information presented to objective consciousness must be interpreted through converting them into other images and meanings to determine just what was perceived on the inner plane and its true significance.

Thus in gazing into a globe of glass or into a magic mirror, the globe will become cloudy, or white clouds will appear on the surface of the mirror, then they will clear and a picture will be presented to the diviner of certain happenings. Events will be seen much as they appear on the movie screen. The diviner may even see himself as one of the actors in this drama. Nor is it always a silent drama; for not infrequently he may hear the words that are spoken, and smell the odor of the flowers that are seen. The picture so beheld may be an event that is actually transpiring on the physical plane at a distance, or it may be an event which has not yet come to pass on the physical plane but which eventually will happen just as witnessed. In either case the divination is of the direct perception type, not because a divinatory instrument is or IS not used, but because what is seen needs no translating into other terms to be understood.

With training many people are able to practice divination without any manner of divinatory instrument. And in so doing they may see, hear and feel happenings on the inner plane just as they actually are occurring at a distance on the physical plane, or as they will occur in the future on the physical plane. Such independent use of ESP is greatly preferable in the higher phases of occult developments. But most will find it much easier, at least at start, to use some form of divinatory device. Almost anyone with a little practice can learn to get some results in this way. Yet whether ESP is practiced independently of a divinatory device or with its aid, it will be found usually much easier to gain the desired information through Symbolic Perception than through such Direct Perception as has just been described. Even when a crystal globe or magic mirror is the instrument used, the first images seen usually are of the symbolic type, and often information of great value is obtained through them. Therefore, while here not treating specifically of crystal and magic mirrors, nor of the exercise of ESP apart from divinatory instruments, much that I shall say about other methods of divination, and particularly about the function of symbols, also, of necessity, applies to them.

In ancient times, moreover, the flight of birds was observed as a means of foreseeing the future. Another method, which has been abandoned, I am glad to say, was to slaughter an animal and cut it open and from the entrails discern that which was to come to pass. Dreams also, in olden times, as repeatedly recorded in the Bible and in ancient history, were looked upon as presignifying the future. And while they have a different significance to the psychoanalyst, they also may be made the means of gaining much foreknowledge at the present day.

Teacup and Coffee Cup Divination

—But among the various divinatory instruments, none is easier to use than the teacup or the coffee cup; and either offers possibilities which are quite astounding.

A cup that is white and glossy inside is best. In pouring the tea or coffee, pains should be taken that there are enough tea-leaves or coffee-grounds that when they are shaken about they will fairly well cover the bottom of the cup. That is, if spread out on the bottom of the cup no large areas of the white cup-bottom should show through. It is not absolutely essential that there should be this many leaves or grounds, but this amount—say half a teaspoonful—seems to give the widest range in their subsequent arrangement. Neither is it necessary that the person whose cup is read should drink the tea or coffee. He should be, however, the only person to handle the cup after the cup is drained of tea or coffee until the leaves or grounds have been distributed and the cup is handed to the diviner to be read.

As it is customary for tea and coffee to be strained as poured into the cups, it is quite permissible while a little tea or coffee remains in the cup to have half a teaspoonful of leaves or grounds added to it expressly for the purpose of having enough material for divination .

Nearly all of the tea or coffee liquid should be drained off, just enough moisture remaining that the leaves or grounds when shaken will stick to the side of the cup as well as to its bottom. Then the person whose cup is to be read should concentrate his mind on that which he desires to know from the cup. If there is some particular information he wants, he should hold the thought strongly that he expects the correct answer to this question to be found in the cup. If he seeks a serious and intelligent reading he should be very much in earnest. If there is no particular information sought, he may hold the thought strongly in his mind that the cup will truthfully reveal the future. Whatever he seeks from the cup should be clearly and strongly formulated in his mind.

Then holding the cup at such a distance that he cannot see into it, and while keeping his mind on what he desires it to reveal, he should shake the cup about in such a manner that the leaves or grounds will be distributed over the bottom and side of the cup.

He should give whatever kind of motion, in the distribution of the contents, that he feels impelled to make. Then without looking into it to see how the contents are arranged he should turn the cup upside down in the saucer. Finally, to complete the ceremony, he should revolve the cup around in the saucer, while it is still upside down, turning it around thus from left to right—in the direction the hands of a clock move—three times around. No one, after this, should be allowed to touch the cup, or look into it, until it is given to the diviner to read.

The diviner may be the person whose cup is to be read, or another person. But for the best results it is essential that no person shall see the inside of the cup except the person giving the reading, until after the reading is completely finished. The reason for this is that another person seeing the symbols in the cup is apt to form conclusions. These conclusions may be perfectly correct and result in an accurate reading if followed to their full destination in the proper order of sequence. But the diviner in reading the cup contacts these conclusions projected from the other person's mind, through the symbols that have given rise to them, and thus approaches the matter from a point of view that is not his own. Such mental contagion as it is called by them, is well recognized as influencing the results obtained by academic experimenters in ESP. And unless the mentioned precaution is taken it may warp the diviner's usual method of interpretation. Thus do the best results require that no one but the diviner shall see what is in the cup until after the reading is completed, and that during the reading he should not be hurried or unduly interrupted.

The diviner then takes the cup into his hands and gazes intently into it. As a rule, the more completely his mind becomes absorbed in contemplating the inside of the cup, and the more oblivious he becomes to his external surroundings, the clearer the reading he is able to give. A state approaching abstraction, in which the contents of the cup are minutely examined, but in which thoughts unrelated to them are inhibited, is often found best. No hard and fast rules can be laid down as to this, however, for the conditions that permit the content of the unconscious mind of one person best to impress itself upon the everyday consciousness may not be the

conditions that best permit another person's unconscious mind to register its thoughts on the everyday consciousness. Some even find it best to engage in conversation, only glancing into the cup now and then, and in this glance perceiving a symbol to be interpreted. In this case very brief periods of intent concentration interspersed with long periods of relaxation in conversation yield better results than a long period of steady concentration. A little experimental practice, however, enables a person to determine the manner in which he can perceive clearly the most symbols and get impressions concerning their interpretation.

The whole process of manipulating the cup, before it is given to the diviner to read, is for the purpose of arranging the tea-leaves or coffee-grounds into symbolic groups and forms. In this arrangement, when the person is very much in earnest, his thought cells working from the inner plane, and at times other inner-plane intelligences, exert an influence.

The tea-leaves or coffee-grounds, as they are agitated about in the cup in association with a small amount of liquid, are acted upon strongly by electromagnetic energies manipulated by the mentioned inner-plane intelligences. This tends to cause them to form groups and diagrams of proper symbolic import correctly and intelligently to answer the desire in the mind of the person in whose cup they are found.

The combined inner-plane intelligences present may act largely through the unconscious muscular movements of the person, in thus arranging the leaves or grounds, much as it may do in table-tipping, in using the Ouija board, or in automatic writing. Or, on other occasions, it may act more directly upon the leaves or grounds, their saturated condition facilitating their movement by the electromagnetic energies surrounding persons present.

A little experimentation, under proper conditions, joined to careful observation, will quickly convince the open-minded that, aside from the ESP ability displayed by the diviner, the leaves or grounds often take such form as unmistakably and intelligently to answer the thought in the mind of the person. It is certain that there is often present, when a person who has faith in cup-divination is manipulating the cup prior to a reading, some intelligent force that causes the contents of the cup to assume such forms as to answer correctly with the information the person desires. On occasions, too, there will be perhaps but a single symbol stand out in the cup, and this symbol of such obvious form that anyone looking at it will see it as the same symbol, and this universally accepted as representing a certain condition or event; yet when the events come to pass they prove the verity of the symbol so seen. The world-lines which will converge in the production of definite events are perceived by the person's soul, and it utilizes such electromagnetic energies as are present to cause the contents of the cup to assume such forms as most readily will be recognized as presaging the events thus foreseen.

Reading the Cup

—The diviner, when he takes the cup into his hands to read it, should permit his imagination full play. There may be symbols in the cup, so arranged by the inner-plane intelligences present, that they are obvious and their import may not be mistaken. But to rely solely upon these obvious symbols is greatly to curtail the amount of information that may be had. What is being striven for is to bring up into the region of everyday consciousness as many images as possible that are perceived by the soul regarding the person. To do this a large variety of trial images may be permitted to pass through the mind. That is, the imagination should be allowed full play in regard to the images the various groups of leaves or grounds suggest to the mind. It is not necessary for the purpose that the form in the cup have any real resemblance to the thing thought of, only that it suggests that thing in some manner to the mind.

Most of us at times forget the names of persons. In vain we try to recall the name of someone whose face is quite familiar. Then someone begins to go over a list of names, speaking them aloud. We know the names we hear are none of them the one we seek, yet we do not remember the right one. Then the name of the person is spoken, and we instantly recognize it as the one sought. It has, all the time, been present in the unconscious mind, or soul, but has lacked the right association with thoughts already in the brain to pull it to the surface of objective consciousness. But once we hear it we recognize it instantly, and we do not accept other names as the right one when they are heard.

Now this is just what happens in looking at tea-leaves or coffee-grounds, only that sight instead of sound is used, and what we are trying to remember, although it is as much in the unconscious mind as the person's name we tried to remember, yet it has never been in objective consciousness. It has never been recognized through the physical brain. We nevertheless use a similar expedient.

In going over a long list of possible names, we go over a list of images supplied by the imagination. A certain group of leaves or grounds may at once suggest the picture of a certain object. On the other hand we may look at it some time trying to ascertain what it resembles. It may actually look as much like a cat as like a duck. Nevertheless as we look at it we wonder if it can be a cat, or a monkey, or a horse, or finally, a duck. When we come to the image duck, we perceive that it certainly represents a duck. We see it as a duck because the soul recognizes the duck as the symbol of some of the information it is trying to impart to the physical brain. We recognize it as a duck instead of something else for the same reason that we recognize the right name as belonging to the person when we heard it. The name was in the unconscious mind, and the information that the duck symbolizes was in the unconscious mind. Both the name and the duck are mere symbols, the one for a person and the other for something perceived by the senses of the soul.

It follows, then, that a very free imagination which causes images of various sorts readily to be suggested by the most superficial resemblance to what is actually seen, is often an advantage to a cup diviner. Not that the diviner usually is conscious of the trial and error method of determining what a group of leaves or grounds looks like; for with practice the line of association between the image in the soul and the arrangement of grounds or leaves in the cup becomes so strong that the right image may be recognized at once. Yet on those occasions when there is difficulty in forming judgment, and at other times when a diviner has had little experience, it is a decided advantage to have fertility of resources in the matter of the fancied likeness of the arrangements in the cup to animals and inanimate objects.

To persons of the more imaginative type, a host of symbols may be seen in the arrangement of grounds or leaves, one symbol crowding on another in the rapidity with which it is recognized. Such persons read the cup with great ease. But their readings are no more apt to be reliable than those of more deliberate minds.

Some persons must put forth a decided effort, and turn the cup this way and that, and scrutinize each group of leaves or grounds with minute care, before they can get the faintest suggestion that it looks anything like what they have ever previously seen. Their reading of the cup is very slow, quite laborious, and usually lacking in flowery trimmings. Yet those who divine in this painstaking manner are just as likely to divine accurately as those of the other type. Not the facility with which images are seen, nor with which symbols are translated into terms of events, determines the reliability of the diviner, but the correctness of his conclusions. And this can only be determined by comparing numerous cup-readings with subsequent events.

The Function of the Cup

—Let it be understood, then, that the cup is an instrument through which the soul of the diviner, by means of a code, transmits information to his physical brain.

It may be asked why a code is necessary. I ask, in turn, why is a code necessary in transmitting information by telegraph? It is because the telegraph instrument is a device suited to code communications, and not to such direct messages as may be transmitted by telephone. Likewise, the divining cup is a divinatory instrument suited for transmitting code messages from the soul to the physical brain.

It is quite possible that information may be communicated from the soul to the physical brain more directly, without the use of a code. In fact, those who use the cup for divination frequently use the cup and its code messages merely as a starting point, and after getting connected up, no longer pay much attention to what the cup contains, gradually drifting into the more direct perception type of ESP in which symbols are not used. This direct type of divination, however, is more difficult to attain.

Most people, in sending a quick message from Los Angeles to New York, use the telegraph. This does not imply that it is impossible to speak to a person in New York, from Los Angeles, by telephone. It merely implies that it is more convenient for many reasons to use the Morse Code of the telegraph system. The soul, in communicating with the physical brain in reference to matters of which the latter has no previous knowledge, likewise usually finds it more convenient to use the code of symbolism.

By now it should be clear why a definite and predetermined routine should be followed in manipulating the cup before it is given to the diviner. Not that turning the inverted cup from left to right in the saucer, three times around, is of much importance. That which is important is that the inner-plane intelligence present at the time shall know the order of procedure; for knowing this facilitates the distribution of the tea-leaves or coffee-grounds so as to present appropriate symbols.

Method of Interpretation

—For the best results, also, the soul of the diviner should know beforehand the interpretation which is apt to be placed upon certain symbols and their positions in the cup. Such a prearrangement, perhaps, is not absolutely essential for good results, for the soul may perceive how a symbol will be apt to be interpreted. Also there are many symbols universally accepted as having a certain significance. But the information can be transmitted from the unconscious mind to the physical with more certainty, with greater facility, and with more elaborate details, if there is a complete understanding between them beforehand as to the precise meaning of the code, or symbols, used. Thus a diviner might read the bottom of a cup as that which will happen in the near future. And if his soul understood this—if the diviner habitually read the cup in this manner—he could give a correct reading. Usually the bottom of the cup is not so considered. But if it were read as the near future at one time, and as the distant future at another, in all probability the unconscious mind would become confused and the proper signal would not be given.

It is not so important that the diviner follow any particular code, or follow any one routine in preference to another, or interpret a certain symbol as a certain thing and not another. But it is exceedingly important that the same code be used at every reading, that the same routine of reading be followed, and that the same symbol always be interpreted in the same way. In other words, a system of signals should be decided upon, which by repeated use also becomes well recognized by the soul, enabling it to transmit messages to the physical brain with precision by the use of these prearranged signals, or symbols.

A symbol, or signal, may be chosen quite arbitrarily. This, however, is quite unnatural; for the mind when not forced permits one thing to represent another only when there has been some familiar association between them. This association may arise through their resemblance—likeness or unlikeness—or through the circumstance that both were presented to the mind about the same time. This Law of Association is explained in detail in lesson No. 57.

In divination people not only desire to know the nature of the events but they wish to know when they will transpire and where they will take place. Applying the Law of Association, because the contents of the cup closest to the brim is that portion first contacted in drinking, it is quite natural to think of the brim as the present and any emblems close to the brim as being significant of the immediate future. The bottom of the cup, then, is suggestive of the very distant future, that portion of the cup where it joins the bottom as the distant future, and the portion of the cup midway between the brim and the bottom as moderately distant in the future. This gives five time periods: 1. The present. 2. The immediate future. 3. The moderately distant future. 4. The distant future. 5. The very distant future.

Then as the handle of the cup is the portion of the cup encircling the finger in drinking—a place from which the movement of the cup is directed—we can readily associate the handle with the home, or residence, of the person. Distances from the handle, to the left or to the right, in the cup show at what distance from the home the event will take place.

People may be shown in the cup by groups of leaves or grounds that closely resemble people or their faces, or they may be represented by single tea-leaves, or small more or less perpendicular groups of grounds. If the symbol is forked at the bottom, or if there is no spreading to suggest a skirt, it is considered a man. But if the emblem is perceptibly wider at the bottom, even slightly suggesting a skirt, it is considered to be a woman. If the leaf or emblem is lighter in color than the average of the leaves or grounds, the person represented is a blond; but if it is darker than the average, the person represented is a brunette.

The Meaning of Symbols Seen

—The various past experiences of the diviner, through the association of certain objects with these experiences, will, in all probability, have furnished his soul with many symbols that have a specific meaning to it, which would not be comprehensible to another person. Thus, if at some time he has had a misfortune come to him while under some conspicuous tree, the symbol of a tree in the cup will signify misfortune. Or if he has been bitten by a dog when he was a child, a dog among the emblems in the cup will signify danger. If some dear friend was killed by a railway train this strong association caused by the shock of the news of the accident may make a lasting impression, so much so that a railway train may become the symbol of the death of an acquaintance.

Each person has a large number of such symbols that have a meaning only to him, because somewhere in the past they have been more or less associated with his emotions. They are used by his soul through dreams and through divinatory instruments, such as cup-divining, as a part of the code by which it endeavors to impart information to the everyday consciousness. As no two persons have the same experiences, no two persons will have the same code in all its details. Therefore this private code, which springs from the individual experience, must be learned by each for himself. This may be done by reflecting on what kind of an experience in the past a symbol calls to mind, and by observing what events actually come to pass after observing a certain symbol.

By far the larger number of symbols used by the soul in its code messages to the physical, however, have such an obvious association in the ordinary run of life that they mean about the same thing to all who have not had some unusual experience that is associated with them.

Thus, the symbols above mentioned, to the person without such extraordinary experiences, have a very different meaning. The tree, because of its strength and long life, is usually interpreted as a symbol of health and vitality. The dog, because of its faithful companionship with man, is usually interpreted as a friend. And a railroad train, because it is commonly used for transit, is usually interpreted as a journey.

The student who has studied astrology will frequently find astrological symbols in the cup. These, of course, are interpreted according to their usual astrological significance. Both letters and numbers, also, are frequently seen in the cup, and may be interpreted by their significance as given in the Hermetic System of Names and Numbers (Course VI). Any students who have given some study to the Sacred Tarot (Course VI) will have a great number of symbols added to their repertory by which their souls can transmit messages in code to their brains, for these symbols may be interpreted according to the significance given to them in tarot study.

Let us carry our interpretations a step further, using almost the Free-Association method of the psychoanalyst. To most, clear skies suggest good fortune, and cloudy skies suggest trouble. Therefore, what is seen in the cup in the clear spaces, not in the murky patches, may be interpreted as happenings without confusion or trouble, but the same symbol seen in the cloudy part of the cup signifies that the event, although essentially the same, was accomplished with difficulty and accompanied by much trouble.

Dots usually may be interpreted as money. They appear like miniature coins.

Dashes may be interpreted as enterprises that have started but that need time to mature. They suggest movement, yet reach no important destination.

A cross, because of its common religious association, is a symbol of hardship and suffering.

A circle is something completed, or finished, because the line of which it is composed has completed its cycle.

That which is found within a circle, or an enclosure, indicates that it is restricted or imprisoned.

A wavy line, like water-waves, suggests, and may be interpreted as, indecision—as changeable as water.

A line that is undulating, like a highway, may be interpreted as a road.

A long straight line, likewise, may be interpreted as a straight road.

A fox in the cup signifies trickery or cunning, and a cat signifies treachery, because of their common associations.

A rabbit, because of its common association, symbolizes timidity and lack of courage; and a snake, because of the biblical curse relating to its enmity to man, usually may be interpreted as an enemy.

An arrow, because of its flight and ability to wound, is interpreted as unpleasant news

A bird on the wing, seen in the cup, because of the association common to the carrier pigeon, and because migrating birds bring news of the approaching seasons, may be interpreted as a message. The direction in which the bird is traveling indicates where the message is going. If it is flying toward the handle of the cup it is approaching, but if flying away from the handle of the cup, it is going away from the person receiving the reading.

A horse, probably because in astrology Sagittarius symbolizes the higher mind, is usually interpreted as a mental condition. If it is a light colored horse it signifies the higher aspirations. If it is dark in color it signifies thought about more material things. If it seems to be drawing a load, it means success through careful planning. If it seem so be running away, it signifies that undue enthusiasm will carry the person beyond that which is the part of wisdom.

A mouse, because of its common association with small difficulties, may be interpreted as petty annoyances.

A rat, however, usually is interpreted as a thief.

Eggs symbolize plans, or ideas, that have useful possibilities.

A parrot, because it is commonly associated with much useless and sometimes annoying talk, may be interpreted as a scandal.

A dove, on the other hand, is a symbol of peace.

A horseshoe, seen in the cup, even as it is so considered by popular tradition, is a symbol of good luck. The object seen in the cup nearest to the horseshoe indicates from whence the good luck will come.

Fish, commonly, are not to be interpreted according to the astrological sign Pisces, because this significance is known only to astrologers, but according to the fisherman's notion, that of gain. Thus, more often than not, they signify money, and the size of the fish indicates the size of the sum, and the direction it is going from the handle of the cup determines whether the money is coming to the person or leaving him.

A peacock is to be interpreted according to its common significance, being an emblem of vanity.

A butterfly, because it flits from flower to flower, feeding on the nectar, is to be read as pleasure.

A baby is to be interpreted as some enterprise just commenced.

A comet is the symbol of an unexpected event.

A fan, because it is sometimes used for clandestine signals, is the emblem of a flirtation.

An umbrella, because of its use in rain-storms, is the emblem of impending emotional stress.

A spoon, perhaps because of the colloquial expression "to spoon," is the symbol of a love affair.

A tortoise, or turtle, because of the traditional race between the tortoise and the hare, is to be interpreted as success through slow, plodding effort.

A spider, because of the web it constructs in which to catch its prey, is to be considered as the symbol of a trap, or plot, which is set to catch the person to whom the reading is given.

A ship, because of its common association in the mind with the saying, "when your ship comes in," may be regarded as a symbol of approaching wealth.

A gun or pistol is the emblem of a dangerous enmity; a person who desires to injure seriously.

A pair of scissors, because of their cutting edges and form, signifies two persons at cross purposes.

A ring, because of its use in the marriage ceremony, is to be interpreted as a marriage.

A ladder, because it is used to climb, is to be interpreted as a rise in position, or greater success.

A knife symbolizes a quarrel, and a broken knife that a quarrel is at an end.

Flies, because of the saying, "a fly in the ointment," symbolize disagreeable happenings that tend to spoil the plans.

A bottle, because of its usual association with intemperance, may be interpreted as dissipation.

Flowers, because they are commonly used to express goodwill and kindness, may be interpreted as happiness.

I might go on to mention almost every article commonly seen by man, and give its interpretation when seen in the cup. But this would serve no good purpose. Those symbols mentioned have been cited merely as examples of the manner in which the emblems seen in the cup should be interpreted. To the soul, in its code messages to the physical, an emblem symbolizes that which it is most strongly associated with in the unconscious mind. This usually, though not always, is that event, or quality, or thing, which most readily comes into the mind next after thinking of the emblem. Usually, as in most of the above examples, the relationship between the symbol and that which it signifies is quite clear after a moment's reflection.

The skilled cup-diviner, however, does not leap from one symbol to some other on the far side of the cup. He starts in with those symbols nearest the brim of the cup, and nearest the handle. Often there will be a chain of symbols reaching from near the brim down into the bottom of the cup; reaching from the present into the very distant future. He permits his attention to follow these symbols in the order in which they occur, and strives to perceive the exact relationship of each symbol to the next one in the series, and perhaps how the symbols on one or both sides influence it. As he passes from one symbol to another, observing the influence of adjacent symbols, he endeavors to weave the whole into a connected story. He seeks to point out how one event follows another, and what causes each. Instead of a disjointed account he strives to knit together the influences and persons and events represented into such a connected narrative of the future that it brings out all the important facts and relationships.

Some Other Divinatory Instruments

—In the early part of the lesson I mentioned that the ancients made forecasts from the flight of birds. Birds in their flight, when in flocks, by their relation to each other, present the outlines of symbols. These symbols, observed by viewing a flock of birds, may be interpreted after the same manner as when reading a cup. In addition, birds sometimes fly higher than usual and sometimes fly lower than usual, and sometimes fly with more directness than at other times. Probably arbitrary meanings once were attached to these methods of flight, but of much more consequence than this was any peculiarity noticed by the observer. These peculiarities might be real or fancied, but they gave the soul a chance to impart code messages by attracting attention to these actions that seemed out of the ordinary.

The entrails of slain animals that were observed in ancient times as a means of divination also were read in almost the same manner that I have described for cup-divining. The viscera of the animal presented a glassy surface, somewhat similar to that of a china cup. The entrails as they lay before the observer were curled and twisted in fantastic designs, which prepresented many fanciful likenesses to the forms of creatures and objects. Such of these symbols as were observed formed the code message by which the soul of the diviner imparted information that it perceived, regarding approaching conditions, to the physical brain.

Clouds, also, to one well versed in symbolism, may be used very effectively as a divinatory instrument. They lack one factor that gives to the cup a decided advantage. Tea-leaves and coffee-grounds are influenced to take certain shapes by the inner-plane intelligence present. But we are hardly to suppose that clouds are so influenced to any appreciable extent. They do, however, offer an extremely wide, and ever-changing, range of symbols.

They should only be consulted as a divinatory instrument when the mind is quite anxious about something, or after there has been a deliberate resolution to read them. Then the attention should be centered closely upon the first clouds seen, working from this center carefully, as a cup-diviner works from the brim near the cup-handle, in a gradually widening circle. The attention should not wander all over the sky at random, but each symbol should be interpreted as it is seen, in working out from this arbitrarily chosen center. The interpretation should be made in precisely the same manner as when divining by the cup.

In the use of the cup, clouds, globe of glass or magic mirror, the diviner with practice will begin to get impressions apart from the symbols and what these symbols may reasonably be expected to mean. A name, or a date, or less startling information, may pop into his thoughts without any apparent connection with the symbols. He should not hesitate to express these thoughts, and subsequently to test their accuracy. He also may glimpse events apparently not suggested by the symbols. By expressing these impressions and carefully watching for them, he will gradually develop the direct type of Extra-Sensory Perception, in which that which he seeks to discern is perceived objectively just as his soul senses perceive it on the inner plane instead of objectively perceiving only their symbols. And he gradually will develop such facility in the use of Extra-Sensory Perceptions that he will be able to discern that which is transpiring at a distance, which has transpired in the past, or which will transpire in the future, without the use of a divinatory instrument.

Many people in reference to divining or other use of ESP have an erroneous idea of what to expect and how to proceed. As a consequence they do not get satisfactory results, and decide they have no such ability. Yet there are very few people who cannot learn cup-divining, although as in the exercise of inner-plane faculties by other methods, or, for that matter, as in the exercise of any other art, there is a knack to it. In almost every case all that is necessary finally to get this knack is to do considerable experimenting and persistently to practice.

Nor is there, as I have tried to make clear, anything unnatural or detrimental in such practices provided hypersensitivity or mediumship is not cultivated. There is a right way and a wrong way of doing almost anything. One can injure the eyes by reading in the twilight, and one can injure the ears by contacting noises that are too loud; but we do not jump to the conclusion from this that people should not acquire information through reading and listening to others. Nor should we condemn the acquiring of information through the exercise of the senses and faculties of the soul merely because it is possible to use them under conditions that are injurious.

Instead, we should realize that after a date not too distant, if we are to acquire information we will be compelled to rely exclusively upon ESP because, having passed from the physical, we will no longer have physical senses and a brain which we can thus employ. Such training in ESP and other soul activity as we can get before the transition, will make that much less training necessary when we move into the after-earth life.

Chapter 3

Serial No. 120
Original Copyright 1940
Elbert Benjamine

Copyright
Church of Light
August 2002

Divining Rod and Other Divination

Chapter 3

Divining Rod And Other Divination

The most familiar use of the divining rod, and the one most people know something about through reputation if not through actual observation, is that of locating underground water. The divining rod of late years, however, has greatly extended its usefulness. In its different forms it is known to oil and metal prospectors as a "doodle-bug." And although the claims of those using "doodle-bugs" for such purposes should be taken with much caution, such doodle-bugs" at present are in rather common use, and at times with outstanding success, in the effort to locate mines, and in locating oil.

They have been employed, with varying degrees of success, in the development of the newer oil fields of the southwestern United States. Instances of their successful use in this region might be cited at considerable length, but as these have not painstakingly been investigated by men of academic standing as scientists, such citations would carry little scientific weight. Yet before explaining this form of divination and how to practice it, irrefutable evidence should be presented that it can be done. And, as more convincing than the experience of any layman, I shall call upon one of the greatest scientists of our times, Professor Charles Richet, who investigated the subject exhaustively, to present the necessary proof. In his noteworthy book, *Thirty Years of Psychical Research*, on page 230 he says:

"The bending of the rod over water-springs or metals is incontestably true. It has recently been fully verified, with all possible care, and the phenomena can no more be denied than any fact of chemistry or physiology.

"There was a series of trials published in 1913 by H. Magar, at the Forest of Vincennes at which it was clearly proved that masses of metals buried in the ground could be discovered equally well as moving water. The discovery of moving underground water has almost become a trade and cannot be doubted; the government engineers in different lands use the faculty of dowser {one who uses a divining rod is called a dowser) to discover water; this is done in various districts of France, in Tunisia, Algiers, the United States, and in German Africa. Differences of skill in dowsers are not due to the rod not turning in their hands, but to unequal ability in interpreting its movements as to the extent, depth, and direction of flow."

On page 231 he gives the results of still other investigations:

“Summing up his results, M. Vire has sent me an unpublished note in which he give the figures below from fully verified trials since 1913 by Messrs. Pelaprat, Probst, Jouffreau, A. Vire, Colonel Vallatin, and the Abbe Mermet:

Subterranean water, number of experiments 19, successes 89%.

Subterranean cavities, number of experiments 23, successes 87%.

Metals and metallic veins, number of experiments 11, successes 80%.

Coal, number of experiments 9, successes 55%.

“Calculation by percentage underrates the successes, for a remarkable positive result greatly outweighs many failures. The probability is not 1 to 2, but very much less.

“For instance, M. Pelaprat and M. Vire (in an unpublished experiment) showed Mr. A.C., councilor of state, where to sink a well on his property at Juillac (Depart. Lot.). Several borings had been made without results. Messrs. Pelaprat and Vire indicated a thin stream of water thirteen metres below the surface; a well was sunk, and water was found in sufficient quantity for the purpose required.”

These quotations from a book written by a man recognized throughout the world for his scientific attainments will, I believe, be sufficient to indicate not only that the divining rod actually may yield information regarding underground substances, but that in the hands of an expert diviner it may prove of great practical value.

In the past such divination has been practiced mostly by the ignorant. It has systematically been discouraged as a mere superstition. In consequence, it is an ability which has been cultivated by the few indeed, and this cultivation has not been approached in an intelligent manner. Therefore what has already been accomplished in this line is probably inferior and unreliable in comparison to what may be accomplished under intelligent training based upon a more thorough knowledge of the principles that must be utilized.

The Principles Involved in Using the Divining Rod

—The principles underlying the use of the divining rod are the same in their general outlines as those underlying cup divination and other divinatory methods. Extra-Sensory Perception must be employed to enable the unconscious mind, or soul, to ascertain the position of the underground substance sought. Then, in order that this information, which after it has been acquired resides at least momentarily in the unconscious mind as a memory, shall be made available to objective consciousness, it must be projected into the physical world in a manner that can be

recognized and given correct interpretation. It is the manner in which the information is thus imparted from the soul to objective consciousness which to a certain extent makes the divining rod unique; for in using it the unconscious mind utilizes control of certain nerves and muscles to cause the rod to turn in the diviner's hands in such a way as to transmit the information it possesses.

Now it might be thought that the senses of the soul could perceive the presence of one substance under the ground just as readily as they could perceive another. But experiments, such as the series just cited, indicate that it is much easier to locate underground water than to locate oil, and that oil is easier to locate with a divining rod than are metals.

A little reflection will show that this is what should be expected; for when these objects are above ground it is easier to detect some at a distance, by means of the physical senses, than it is to detect the presence of others. A horse, for instance, if thirsty, will smell water at a long distance. Also, in the amounts in which they commonly occur, water may be seen at a much greater distance than gold Pools of oil on the surface of the earth may be smelled at a distance, as well as seen. Silver, in the chemical combinations of its ores as usually mined would not be so readily seen at the same distance, and would not appeal to the sense of smell.

The astral counterparts of substances certainly do not all have the same properties; in fact, objects are as different on the inner plane as they are on the physical. Their properties vary as greatly. And as a consequence of their individual properties, some can be perceived by the soul senses much more readily than can others. This is just what experiments with the divining rod indicate.

Undoubtedly all objects radiate astral vibrations But in addition to these inner-plane radiations all physical objects also radiate Boundary-Line vibrations. As was explained in Lesson No. 118, man normally lives in two realms; in a realm of slow velocities and fast time called the physical, and in a realm of high-velocity slow time which is called the astral world or inner plane. Connecting these two velocity-time regions, in one of which dwells his physical body and in the other of which dwells his soul, is a Boundary-Line region where velocities are those of light, electromagnetic waves and radiations. The realm where velocities are above 186,173 miles per second is the inner plane where mind resides and exercises Extra-Sensory Perception and Extra-Physical Power. The realm where velocities are below 186,173 miles per second is the outer plane where the physical body resides and exercises physical senses and muscular power. For the outer plane to affect the inner, or the inner plane to affect the outer, it must utilize energies of the Boundary-Line region.

As all physical objects have their astral counterparts, and can influence these only through Boundary-Line energies, and the astral counterparts can only influence the physical through Boundary-Line energies, it follows that material things radiate, in some degree, Boundary-Line energies. These greatly facilitate the detection of certain substances through ESP (Extra-Sensory Perception).

Material science is only now coming to recognize these Boundary-Line radiations which have been known to students of the occult for centuries. Let me quote from the front page of the Los Angeles Times, issue of December 30, 1939:

“Columbus (O.) Dec. 29. (AP) A radio microscope, a new scientific instrument which has disclosed an entire world of unseen rays, was announced to the American Association for the Advancement of Science today.

“Man himself as well as all kinds of supposedly inert matter constantly emits rays that this instrument ‘sees’...

“The radio device actually is a radio frequency spectroscope. It does the same thing for cool, nonflowing matter that the spectroscope does when it discloses the kind of atoms that make the stars...

“It was reported by I. I. Rabi, P. Kusch and S. Millman of Columbia University to a crowded hall filled with eminent physicists who listened enthralled.

“The existence of such rays coming from man and all living things, and probably from the inanimate world, has been suspected by scientists for many years. Today is the first experimental proof of their existence.

“The discovery shows that every atom and every molecule in nature is a continuous radio broadcasting station. That hot atoms broadcast waves has long been a proven fact. But this new broadcasting is by atoms not only at room temperature, but in any degree of cold.

“Thus even after death, the substance that was a man continues to send out its delicate rays. The wave lengths of these rays range from shorter than anything now used in broadcasting to the longest kind of radio waves.

“The jumble of these rays is almost inconceivable. There are millions of them. A single very large molecule, Professor Rabi said, may give off 1,000,000 different wave lengths at the same time.

“The longer wave lengths of this sort travel with the ease and speed of radio waves...

“There is one amazing difference between the new radio rays and familiar waves like light. This is the prolonged time, amounting to thousands of years, which these radio waves will keep on emitting from undisturbed matter. The more familiar rays, like light and heat, are all given off in a short time, as anyone can prove to himself by watching a fire.”

The cells of the nervous system of the human body are specially adapted to the production of short-wave electromagnetic radiations and to carrying electric currents. Thus, as seems well demonstrated by experiments in telepathy, it is a radio broadcasting set. And as scientists have found these electrical phenomena of the nervous system are reversible, as is demonstrated when the cells recharge in sleep, this means also that the nervous system is a delicate receiving set, capable of intercepting short waves which reach it from other broadcasting sets.

Nerve currents which are given the frequencies characteristic of the influence of the upper-octave planets—Uranus, Neptune and Pluto—may be used for broadcasting or for reception by reversing the polarity. And while long distance telepathy often is accomplished through transforming high-frequency electromagnetic radiations into astral vibratory rates which have a still higher velocity, the more common short distance telepathy is accomplished through electromagnetic waves. For this reason the ancients classified thought-transference as one of the seven physical senses.

The senses of the soul are capable of perceiving on the inner plane, and quite apart from their electromagnetic radiations, the astral counterparts of physical objects, and acquire information thus about them. But objects and thoughts, and things which people have carried about their persons so that they have acquired the electromagnetic quality of their thoughts, radiate Boundary-Line energy. And a properly attuned nervous system within the radius of these electromagnetic radiations is capable of picking them up in the manner of a radio receiving set. It then requires only the ability on the part of the unconscious mind to interpret the significance of what is felt to acquire information not accessible to the physical senses.

Intellectual ESP gains its information more directly by an extension of consciousness through which it contacts the astral counterpart of the object or condition. It does not depend upon picking up, radio fashion, either the astral vibrations or the electromagnetic vibrations radiated by that about which it seeks information.

Feeling ESP, on the other hand, depends exclusively upon picking up with the nervous system, or the currents traveling over it, either the astral vibrations or the Boundary-Line vibrations radiated by that which it thus contacts. And while Feeling ESP is capable of thus picking up and interpreting the astral radiations of objects and thoughts, those who practice it usually depend very largely upon feeling the Boundary-Line radiations of people and things. For the purpose of possessing very delicate receiving sets, capable of picking up and discriminating the difference between such waves as now are perceived by the radio microscope they hypersensitize their nervous systems.

Those who are good water diviners, and who as professional psychics are accustomed to give excellent personal readings to clients, usually are no better than others in tests with the ESP cards, or in acquiring information unknown to other minds or about matters which have no distinct Boundary-Line radiations. From a handkerchief carried by a person, or from a letter written by him, or from a lock of his hair, such a psychic may give amazingly accurate information not accessible through physical channels. But when the same psychic is asked to discern the symbol on a face-down card, if no other person knows what it is, that is quite a different matter. The electromagnetic radiations of these symbols are too weak and too similar for his nervous system to be able readily to distinguish one from another.

A stream of water under the ground, however, has powerful electromagnetic radiations, and to a person whose nervous system is even slightly attuned to pick up vibrations, radio fashion, its perception is quite easy. Oil, when in quantities sufficiently large to be commercially valuable, also has an electromagnetic radiation not too difficult to be felt by a hypersensitive nervous system. However, distance is a factor in the reception of Boundary-Line energies, and oil often is far beneath the ground. In locating things beneath the surface of the earth by means of Feeling ESP, both the quantity of the substance sought and the ease with which its characteristic electromagnetic radiations can be felt, as well as its distance from the diviner, are factors that enter into the degree of success in locating them.

But whether Felt through electromagnetic energies picked up by a sensitive nervous system or Intellectually perceived on the inner plane, the information to be of practical value must be in some manner transmitted to objective consciousness.

Now because the unconscious mind commonly directs the movements of the involuntary muscles, and those that perform their movements through habit, it is able to use unconscious muscular actions with facility in conveying its signals. Through the suggestion reinforced by tradition that the divining rod will turn down, or behave in a specified way, in the presence of the substance sought, it becomes aware of the nature of the signal it is expected to give.

And thus in the use of the divining rod it employs unconscious muscular movements, even as much table-tipping, automatic writing, and many Ouija board messages may be attributed to not dissimilar manifestations.

Selecting the Divining Rod

—From this explanation of the principles underlying the use of such an instrument it might be thought that the kind of a rod is unimportant. One might even be led to think that it would be quite as easy to locate underground treasures without the use of a rod or instrument of any kind through some arbitrarily chosen code between the soul and the physical brain. Experiments, however, show decidedly that this is not the case. They show that a rod made in a certain manner and of a certain material gives better results than one made otherwise and of a different material. Quoting again from *Thirty Years of Psychical Research*:

“The Abbe Caubin, a very experienced dowser, was able to reveal the presence of divers metallic masses. The kind of rod used has some influence on the result. With a wooden rod there were eight successes out of eight trials; with a copper rod four successes in seven trials; iron gave two in four; and glass none in five trials.”

The reason a rod of one material is not so good as that of another is much the same as that a microscope constructed of one kind of glass may be not so good as one constructed of another kind. Nor can one see without a microscope all that can be seen with one, even though in both cases the image is conveyed to the eye by rays of light reflected from the object. Certain substances, chiefly organic in nature, through the organization in their astral makeup, possess the power of collecting and transmitting inner plane and Boundary-Line vibrations more fully than other substances. They commonly are called mediumistic. Of them live ivory (as distinct from fossil ivory) has this power perhaps in greatest degree. Almost as mediumistic as ivory is witch-hazel. Next in value for this purpose is willow. Peach, almond and apple also are woods that are quite mediumistic.

The younger shoots or branches of the above named shrubs and trees are more mediumistic than the older growth. Also, the time when these shoots are cut has an influence upon their power to collect and transmit vibrations. It would seem that the general astral quality of the branch at the time it is cut from the main stem and thus exists independently is then somewhat polarized by planetary positions. The cutting of the branch from its parent, after a fashion is the birth of the severed branch, and the time it thus first exists independently is analogous to its birth time, from which a horoscope may be erected.

The one quality, however, which it is desirous that the branch so cut shall have, is mediumship. Therefore, for best results, a time should be chosen that will confer mediumistic quality upon the rod in the strongest degree. This time, as determined from astrological considerations, is just before midnight on the night of the full moon. That is, the night when the moon reaches its full after midnight, but before midnight of the following night. The moon should not have passed its full at the time the branch is cut. And if a month is chosen when the sun is in a negative sign, in which to cut the branch, so much the better. The most mediumistic time of year, and consequently the best time to cut a switch from which to make a divining rod, is just before midnight on the night of the first full moon after the sun enters the sign Capricorn. The sun then is in a negative sign in the fourth house of the chart, and the moon culminates in its own home, the most mediumistic of all the signs, Cancer.

After the shoots or branches are cut it is not necessary that they be made into divining rods at once. They may be put away until such a time as it is convenient to do further work on them, or they may be trimmed to the proper proportions at once.

The shapes of divining rods vary. The prevalent form, however, and the one that seems to give best results in the hands of the widest number, is that of a prong, or fork, or crotch. The switch is cut some three or four inches below where it forks, and a foot or eighteen inches of both branches above the fork is left, the ends exceeding this length being cut off. This leaves a crotch, preferably forking rather widely, each of its branches at the largest place being about the diameter of a man's little finger, and about a foot or eighteen inches long, although the size of the rod may vary greatly from this.

Using the Divining Rod

—The customary manner of using such a divining rod is to grasp the ends of the branches, one in each hand, with the thumbs and first fingers toward the crotch. This makes a circuit between the right hand and the left hand, yet the energy present also has opportunity to flow into the four or six inches of stub that has been left where the forks of the rod join, and which thus acts as a pointer.

The upper arms are held loosely close to, and parallel with, the sides. The forearms are held in front of the body at right angles to it. The divining rod, which is now directly in front of the solar plexus, is held with its point—the end where the two branches unite—turned toward the zenith. With the rod held in this manner, the diviner walks over the ground in the region where the substance sought is thought to exist. When he comes more or less close to the spot directly above the substance the point—the stub above where the branches join—will gradually turn toward the earth. The closer to the spot directly over the object sought he comes the more downward points the rod until, when he is directly over the spot where it occurs, it points perpendicularly downward to the earth.

By far the most potent force operating to turn the rod downward usually is the unconscious muscular action of the diviner. The involuntary muscular contractions, directed by the soul, are so strong often as to overcome any and all resistance the diviner may make to the turning of the rod. There are other cases, nevertheless, in which there undoubtedly is some psychic force present other than muscular contraction.

With a rod of the shape I have described, even though the rod turns in the hands with such force as to break it, and brings blisters on the hands of the diviner, it is difficult to prove that these results are not wholly due to involuntary muscular movements. Other forms of divining rods, however, are occasionally used. Sometimes a long, straight switch of hazel or willow is held with both hands near the large end. Such a switch will sometimes, in the hands of an experienced diviner, bend downward at the tip violently, much after the fashion of a fishing rod when a fish has been hooked. It will then continue with the tip bending down as if a weight were attached to it, a condition impossible to produce by any amount and kind of muscular movement of the hands where they hold the rod.

Another method of using a divining rod, although, I believe, not so good as the one I have recommended, is to grasp a straight switch of hazel or willow near both ends. The middle part, then, is supposed to bend downward when over the substance sought. This bending will sometimes take place when it is held so loosely in the hands as to make it impossible thus to bend it through muscular action. Then again, as shown by experiments carried out by Paul Memoine, when the ends of a divining rod are placed in sheaths, and these are held in the hands, the rod nevertheless turns in the sheaths. This could not happen if muscular action alone were responsible.

The novice at using the divining rod should not expect violent manifestations such as have just been described. With the first trials it should be sufficient if the rod turns down in a manner somewhat accurately locating the substance sought. The turning will probably be due to involuntary muscular contractions. Yet it should also be recognized, so the mechanics of the subject may be thoroughly understood, that even as when tea-leaves or coffee-grounds are being distributed in a cup, or when tarot cards are being shuffled, so also when using the divining rod there may be present a psychic intelligence which not only perceives the matter sought, but which also is capable of exerting an influence upon the movement of the rod quite independent of the muscles of the diviner.

Such independent movement is possible only when there is electromagnetic energy at hand in considerable volume, radiated from some person present. Therefore, these violent and independent manifestations of the rod usually occur only when the diviner is pronouncedly mediumistic. Yet a person not mediumistic in this sense may use the divining rod with quite as much accuracy. The movement of the rod may be only strong enough to act as a signal from the unconscious mind, yet give information of utmost value and precision.

Locating Substances Other than Water

—When water is the substance sought the diviner commonly uses the rod without anything in addition to it. But when oil or the metals are to be located some system must be employed that will impress the information upon the soul that water is not wanted, and just what the nature of the substance is that should be located. This is accomplished in different ways by different diviners, but the method most in favor is to hold a portion of the substance sought next to the divining rod in the right hand of the diviner.

Thus if oil is to be located, a small cotton cloth is saturated with crude oil and wrapped around the portion of the rod where grasped by the right hand. If silver is sought, a silver coin is held in the right hand against the rod where it is grasped. If gold is the metal to be found, a gold coin or a gold ring is grasped next to the rod in the right hand. A portion of the substance sought should actually contact the rod in a manner as if it were expected that the energy from the diviner should flow through this substance and out through the pointer of the rod.

And, in addition to astral energy, it seems that electrical energy—associated with both the earth and the diviner—must flow through the rod for its successful operation. Thus it has been proven by various series of experiments that rubber soles on the shoes, or glass insulation from the ground, or rubber, woolen or silk gloves on the hands, destroy the power of the rod. The feet must contact the earth in such a manner that there is no pronounced insulation, and even very heavy leather soles on the shoes are not best. There also must be no insulating material between the hands and the rod held by them. It is unlikely that astral energies are hindered by insulating materials, but astral energies to affect physical substances, such as the turning of the rod, impart motions through Boundary-Line energies. That these shall be adequately present it seems that the diviner's body must be properly grounded. That these electromagnetic forces may act upon the rod, it seems there must be no insulation between his hands and the rod.

Estimating Depth and Volume

—The mere matter of locating where there is underground water or underground oil or underground metal is the easiest part of a diviner's work. Were his work to stop here it would be of but slight value. It is his endeavor also to determine approximately the amount of substance present, at what depth it occurs, and in the case of water the direction of its flow.

The amount of the substance present is approximately determined by the violence of the pull on the tip of the rod. Only experience will teach the diviner how much pull on the rod represents a given amount of the material sought. An angler who has caught trout has an approximate idea of the size of the fish he has hooked before lifting it from the water. Another kind of fish of equal size may not exert so much pull upon the line as a trout. Yet if he knows the kind of fish he has hooked he may be able to tell something about its size by its pull on the line. So, in using the divining rod, knowing the material sought, the diviner from his previous experiences with this substance seeks to determine by the amount of pull on the rod just about how much of the substance there is.

It is common for diviners to estimate the depth of the hidden material in this way: The point where the rod first starts to turn is noted. Then the point is marked where the pointer turns completely down, perpendicular to the earth. Usually the diviner goes to some distance, and in a different direction, from where the pointer turns completely down, and again walks toward the spot and notes where it commences to turn, and also if it turns completely down at the same spot. He does this from several directions. Then in each case the distance from the point where the rod commenced to turn to where it turned completely down is measured and the average taken. If the diviner is quite precise in his work, this measured distance is the depth the substance sought is under the surface.

The point is approached from several different directions and the average of the distances is taken to lessen the likelihood of error. Experiments with the diviners in the oil fields, where the depth to the oil may be well over a thousand feet, and is often several times that, have yielded some amazing results. The distance between where the rod commenced to turn and where it pointed directly down, when tried from various points has, with some diviners, varied not more than a few feet. If this were guess work it is remarkable that a person could guess a distance so great as this, after having established it at first trial, again and again, from different directions, with not more than two or three feet difference as measured later by a tape line. But when this also has been found to coincide as closely with the depth of the well when drilled, it is truly a remarkable achievement. It must be added, however, that such accuracy and precision, among those who divine for oil, while attained by a few, has been fallen far short of by the many.

In some places, notably in France, the divining rod has been used successfully to locate not only minerals, but also to locate underground crypts and caverns. In locating coal, a small piece of coal is held in the right hand against the rod. Likewise in locating other minerals, a portion is held against the rod. How, then, is the diviner to distinguish an underground grotto? He holds in his right hand, next to the rod, a small piece of clay tubing or a small hollow clay ball. This focuses the soul senses on hollow spaces under ground.

Determining the Contour of the Deposit

—The approximate contour of the hidden deposit or cavern may be determined by using the rod at different points, and noting the amount of pull on the rod at each point. In the case of an underground stream the rod will point down almost immediately at any spot directly over its course. Therefore, to find its depth under the ground it is necessary to approach its edge from beyond its boundary, noting the distance from the point where the rod begins to turn to the point where it finally is perpendicular to the earth. If there is a distinct current in the underground stream, the direction of the current's flow will be indicated by a slight vibration of the tip of the

rod. The vibration, or series of slight movements of the rod, will be toward the direction in which the current is flowing. It will be felt, perhaps, by the hands of the diviner as a tremulous tugging of the rod in the direction of flow, more distinctly than it is seen. He is thus quite definitely made aware of the movement of the underground stream and the direction of that movement. But if the underground substance is not in motion, no such vibration is felt in the rod after it has turned directly down.

Many People Can Successfully Use the Divining Rod

—Experiments indicate that rather a high percentage of people can use the divining rod with some success at the first few trials. Some who have studied the matter have concluded that all persons, with sufficient training, could have some success as rod diviners. When we reflect however, that some persons never seem to be able to learn a simple strain of music, that others never master, even after arduous practice, the simplest mathematical problems, that there are persons in considerable number who cannot distinguish between the colors red and black, it seems probable that there are many persons also who could not develop the ability successfully to use the divining rod.

When we bear in mind that the greatest naturalist of the nineteenth century, Charles Darwin, in his maturer years lost the power entirely of appreciating music, and that another great naturalist and scientist, Louis Agassiz, had a decided weakness in mathematics, we are not likely to make the mistake of considering those deficient in some normal faculty as necessarily mentally inferior.

It would seem that the power of communicating in some small measure what the soul perceives to the physical brain is a normal faculty. It is a faculty, however, which has received scant attention in the past, and for that reason it performs its function imperfectly with most. The ability of the unconscious mind to communicate signals to the physical brain by means of involuntary muscular contractions, also is a normal faculty; for it is not altogether dissimilar, although there is an element of objective consciousness present in them, from winking the eye involuntarily or Jerking the hand away from a very hot object or recoiling from a startling noise. In the case of many involuntary movements it is better to permit the actions to be controlled by the soul. Yet there are other instances, blushing for instance, where such control is inconvenient, and still others where it might prove dangerous. It is well, therefore, carefully to watch the effect of practice with the divining rod.

The distinction here between utilizing one's own faculties, and that of being under the control of some other entity should be kept well marked in the mind. The irresponsible medium permits whatever intelligence is present to use his brain and nerves and muscles. The diviner instructs his own inner-plane senses to perceive what is sought. He instructs his soul, or unconscious mind, to use his nerves and muscles to impart this information to his brain through turning the rod. He does this much as he would instruct his soul to supervise the function of digestion for acquiring better health, or instruct it to awaken him at a specified time in the morning, or instruct it to aid him in the performance of some work requiring exceptional skill.

When we thus instruct our unconscious minds to bring about certain results, and those results follow, we are still in command of ourselves. But when we vacate control and permit another to take charge we are breaking down our power to direct and control ourselves in the future. Nevertheless, both Feeling ESP and employing involuntary muscular movements such as are present in rod divining, need to be approached with caution. The caution is necessary to insure that conditions which are well within the individual's control at start do not develop into conditions which are not thus completely under his control.

The faculty of finding substances may be cultivated by using the rod to find a portion of the chosen substance which has been buried, or which has been placed under the floor, by an acquaintance. In this way the rod may be used to locate the exact spot where a small portion of the substance has been hidden close to the surface. To practice estimating the depth of the deposit a dry well may be utilized, and the substance may be suspended in the well at depths unknown to the diviner. The rod should commence to turn at a distance from the well equivalent to the depth of the substance under the ground.

Coin on a String.-Another form of divining instrument occasionally used in locating hidden deposits is a coin tied on the end of a string. The prospector walks over the ground where the mineral is likely to be. The coin on the end of the string performs no unusual movements so long as there is no mineral deposit underneath. But as it approaches such a deposit it begins swinging around in a circle, due, no doubt, to the unconscious muscular contractions of the diviner. The swinging, and also the spinning of the coin, become more violent as the deposit is neared becoming most violent when directly over the deposit.

There are variants from the common usage, but it is usual to use a gold coin for locating gold, a silver coin for locating silver, etc. The coin, like the divining rod, is a means by which the soul signals objective consciousness what it has perceived by its inner-plane senses.

There are other rods, used by metal prospectors, in which a little chamber at the end of the rod farthest from the hands contains metals, or other substances, in various combinations. The principle on which they operate, however, is essentially the same as that employed in the ordinary divining rod as already described.

Bible on a String

—There is also a method of divination common in some sections which employs a small Bible to answer questions. No doubt there are many variants of the method, and that it can be practiced by one person, but as I have witnessed its use two persons acted as diviners.

The small Bible is tied to a string and the other end of the string is tied to the middle of a cane. One person holds one end of the cane and the other person holds the opposite end. The Bible is thus suspended about a foot from the floor by the string tied to the middle of the cane. The Bible is then permitted, by the movements of the hands holding the ends of the cane, to sway gently to and fro.

The question to be asked is clearly formulated in a manner that it may be answered by yes or no. One or more passage of Scriptures is chosen to repeat before the question is asked, such as two or three verses of the Twenty-Third Psalm. Then, after repeating the Scriptural quotation decided upon, one of the persons holding the cane, the Bible gently swinging meantime, follows the quotation with the question. If the answer to the question is no, the Bible will almost, or quite, stop swinging; but if the answer is yes it will begin to swing in circles that become wider and wider until this is recognized by the diviners as an affirmative answer to the question.

The religious element and the solemnity enjoined tend to direct the attention of the souls to the question. One question follows another, each preceded by the Scriptural quotations. In this manner, through affirmative and negative replies, considerable information of value occasionally is gained. Of course, as a usual thing, in this method of divining the unconscious mind merely makes use of the unconscious muscular contractions to signal what it has acquired through ESP to objective consciousness.

Geomancy

—I have seen a native of Baluchistan give a divinatory reading, which subsequently proved quite correct even in detail, to another sorely perplexed native of the same country after the following manner:

He first brushed a space in the dust a yard or two square. Then he cut a switch from a nearby tree, trimming it so there were several prongs left at the smaller end. Grasping the switch by the larger end, he used the prongs to trace marks in the leveled dust. While making the marks on this dust blackboard he looked off into the distance in an abstracted manner and permitted the switch to perform whatever movements he felt impressed to make. He did not look at the design thus automatically traced in the dust until after such marks as he felt impressed to make were finished. Then he dropped the switch and directed his attention to the tracings.

The tracings, which presented a crazy-quilt effect, were interpreted much after the manner in which a divining cup is read. The combination of lines and spaces gave a bizarre resemblance to pictures of objects and animals. These were interpreted as symbolic of approaching conditions and events, the interpretation passing from one figure to another until the resemblances were exhausted.

On another occasion the same diviner was asked a question which could be answered by yes or no. In this instance one person was desirous of knowing if another person who had gone away would return.

He took up a small stick and looking into the distance made a row of marks in the dust, then below these another row, and below these a third row, without keeping track of how many marks were made in each row. He then counted the marks made in each row and by a single mark, or by two marks, made notation whether the marks in a row were odd in number or were even. These resultant marks then were counted and the number so found was seen to be an even number. His answer, therefore, was in the negative, that the person would not return. Had the final result been an odd number, he would have passed judgment in the affirmative.

This is but one of a great number of methods of divining in the earth, called geomancy. I will briefly give another method requiring a little knowledge of astrology for its interpretation:

Pencil and paper may quite as well be substituted for the earth. Four horizontal rows of marks, or dots, are traced on the ground, or on paper, without any thought being taken as to the number of marks made. The top row is then counted, and if the resulting number is uneven 1 cipher is marked down, but if the number of marks is even, two ciphers are marked down. Then the next row beneath is counted, and the cipher, or ciphers, designating whether the row is of even or uneven number is marked down directly beneath the cipher, or ciphers, marking the first row. The result of counting the third row is noted down beneath the others, and the result of counting the fourth row is placed beneath this. The result is a figure containing from four to eight ciphers, there being a possibility of sixteen different designs. These designs have arbitrarily been assigned to the ten planets, certain of them representing planets well aspected, and others representing planets much afflicted by aspect. This arbitrary assignment is given at the front of this booklet.

Now if the answer to a question is sought, the diviner, while keeping the question in mind, makes four rows of marks as above instructed. He then determines which lines are even, and which uneven, noting down the result as ciphers. These ciphers thus jotted down present one of the sixteen designs shown at the front of this booklet, and thus represent one of the planets. If this planet is favorable to the proposition, the reading is thus given; if it is adverse, the nature of the affliction is made known.

Should a complete reading be desired by this method of astrological geomancy, the diviner uses an ordinary blank astrological chart. The design resulting from the first four lines of marks corresponds to one of the planets, and he places this planet, with its aspect if it has one in the design, in the first house of the chart. He then makes four more lines of marks and places the planet and its aspect, if any, thus found in the second house of the chart. And thus he proceeds until each of the twelve houses contains a planet. These planets, by the nature and aspect of such as have aspects in the design, each indicate the events and conditions that are approaching in each department of the life. In this manner a very complete reading can be given covering all twelve departments of life.

Astrological geomancy requires that the diviner know something of the nature of the planets and of the houses of a horoscope. Such knowledge is not required, however, to consult other oracles, such as those commonly to be found in a Book of Fate. The designs formed by noting even and uneven lines, or the symbols found by some other apparently chance method of selection, then correspond to the answer to be found elsewhere in the book. The instructions often require that the resulting designs or symbols be combined, or that there should be other complex manipulation. The principle, nevertheless, is quite the same.

The accuracy of the information received by the methods of divination mentioned depends upon the ability of the diviner's soul to perceive conditions not known to the objective consciousness, and to communicate that knowledge, by means of involuntary movements of the body, to the objective consciousness. No one may say, without trial, to what extent reliable information may, or may not, be gained in this manner.

One thing seems sure: Now that man has conquered the air, the next realm to conquer is the astral. Had life in the past been content to function in a single realm there still would be fish in the sea, but no creatures on the land. I am inclined to believe that the conquest of the astral realm is no greater task for man, nor requires greater initiative nor courage, than the conquest of the land by creatures originally unable to breathe dry air, whose limbs were fins, and whose conception of what other environment than the sea is like could hardly have been more or less comprehensive than the conception now, of the majority of persons, regarding the astral region.

Chapter 4

Serial No. 121
Original Copyright 1940
Elbert Benjamine

Copyright
Church of Light
August 2002

Instantaneous Character Reading

Chapter 4

Instantaneous Character Reading

SINCE the world entered the Pluto Period of the Aquarian Age with the discovery of the tenth orb of our solar system March 12, 1930, cooperation, which Pluto rules, has gained a position of importance which is far superior to that which it has held at any time in previous history. Cooperation among certain nations, in response to the Lower-Pluto influence, may be the greatest threat of destruction to civilization. But on the other hand, the eventual cooperation of all the important nations of the world, in response to the Upper-Pluto influence, is the only hope that modern civilization can be preserved and advanced to make the world a happy place in which to live. Yet any effective cooperation between individuals or between nations implies that each shall understand the character of the other.

Without cooperation between men, mankind would be like the spiders; for they are among the few animals that have with each other almost nothing in common, no two occupying the same web for long. Or they would be like the grizzly bears, who also are hermits, avoiding contact with their fellows. But we look upon neither the spider nor the grizzly bear as examples for human emulation. Each is the most ruthless savage, the spider of that phylum of animals containing more species than any other, the Arthropoda, and the grizzly of the highest class of animals, the Mammalia.

The history of human evolution is the history of forming cooperative groups. First the savages united in the family. When the family group became stabilized and various families united in a cooperative effort to repel invasion and procure food, another step had been taken toward civilization. Family life resides at the very core of human progress. Next, when various tribes composed of united families came together under a common leadership and for a common purpose, there was formed a nation. Then when such a nation had been stabilized over a sufficient period of time savagery vanished and barbarism took its place.

These steps in progress are clearly illustrated by the North American Indian. Existing in isolated groups he is found with little culture even for a savage. But where numerous tribes became banded together under a common leader, savagery vanished, and he rose even above barbarism; for ancient Mexico furnishes examples of culture and government that may well be styled civilization.

Undoubtedly the nation is a link in the chain of upward progress. But so long as each of the various nations of the world strives mightily for its own advantage, with little consideration of the suffering it may bring to other nations who have thus been deprived, there will be periodic conflicts which will threaten the destruction of civilization. There can be no permanent peace in the world until all important nations find the common basis for cooperating, not to gain an unfair advantage for one or a few, but in the effort to produce and distribute in a manner advantageous to all, the material things people need for the most abundant type of life, and the spiritual doctrines which, based on the laws of nature as they actually operate, alone lead to happiness.

The greatest obstacle to taking this final step in cooperation, which is the only way periodic destruction through vast wars can be avoided, is the failure of each race and nation to understand the motives and characters and needs of the other races and nations. It is not, I believe, as some think, that people do not desire to agree—for the vast majority are convinced of the futility of periodic wars—but that they do not know how. They are not sufficiently versed in each other's characters, and hence cannot exercise the skill necessary to bring about agreements which otherwise could be made of advantage to all.

Nor, as a rule, do I find the people whom I meet—and I have met a most wide variety—desirous of antagonizing other people. Mostly they wish to get on well with their fellowman, and to do a small part at least, toward keeping the affairs of common interest to mankind moving in the proper direction. But some of them do not get on well with others, not so much through perverseness as because they do not know how. Having little knowledge of the indexes of character they persist in doing the very things, unwittingly, that annoy and arouse antagonism in those with whom, to be themselves successful, they should cooperate.

There can be no doubt that the ability to judge character quickly and accurately gives a person a great advantage. He perceives both the strength and the weakness of the person with whom he is dealing. He is able, through appealing to his likes or through taking advantage of his weaknesses, unduly to influence him. But this phase of the matter, so often emphasized by those who teach character analysis, and so often, alas, taken advantage of by the semi-confidence man who studies character analysis and practical psychology for the purpose of forcing a victim to buy what he does not need at a price several times too high, is the inversive, or Lower-Pluto, side of the matter. It is but another instance, of those increasing in variety, of a power that should be used for construction being used destructively.

The constructive, and more important, phase of the matter, is to impart such knowledge as will enable one person to cooperate to the highest extent, and with mutual advantage to all, with any other person with whom he may be brought into contact.

Few men rise to great achievement without the ability, in considerable measure, to read character. The person who employs others must be able not only to judge his employees as to their integrity, but he must know whether a particular person is fitted for a certain type of work. He must, when hiring a man, perhaps, pass judgment on whether the latter has the ability to think quickly and to carry responsibility well.

To the employee the ability to read character is no less valuable, for it enables him to avoid the inconsequential actions and words which may, perhaps, prove particularly annoying to men of the type of his employer. It not only enables him to render better service through avoiding friction with his fellow employees and his employer, but it enables him to determine just the kind of service required and just how much initiative he is supposed to take, in order to rise rapidly to better positions.

In the home, also, the ability to read character is valuable. If husbands better understood the characters of their wives, and if wives better understood the characters of their husbands, there would be far fewer separations. Marriage, when successful, is a mutual adjustment of the tendencies of one person to the tendencies of the other. But anything like a satisfactory adjustment demands that both shall understand not merely what each states to be the likes and dislikes—for without character analysis few persons understand themselves—but that each shall have a comprehensive grasp of the true character of the other.

The Fundamentals of Instantaneous Character Reading

—Having indicated how important in the lives of most individuals and in the destinies of nations and civilization ability to appraise character is, the next step is to consider how it may be accomplished.

I am convinced that there is no better index to character, no better method of judging ability, and no system more reliable in determining where success will be greatest for energy expended, than natal astrology. Natal astrology, however, requires that the birth data be known. It requires also considerable special ability, and the time to erect a birth chart. Very frequently it is inconvenient, and sometimes impossible, to get the birth data. In the ordinary run of life one meets people under circumstances where an instant estimate of their characters and abilities must be made, which sometimes may, and sometimes may not, later be verified at leisure by the erection of an astrological birth chart. And it is for the purpose of making such quick estimates of character, when it is not feasible to use birth charts and thus acquire greater details, that these four lessons on character reading have been written.

As has been explained in a number of the B. of L. courses, and in considerable detail in Courses V, IX and X, the character, or soul, is the sum total of all past experiences. These experiences, through their accompanying states of consciousness, have added energy to the astral body. They, of course, include those rates of energy imparted by the mother to the child's astral body during gestation; for the mother provides the environment during this period, and this environment—even as do both earlier and later environments—affords experience for the evolving soul. The character at birth, then, is the sum total of all the energies that have been added to the astral body during its evolution through innumerable lower life-forms before its birth into a human body.

In the course of its evolution through these lower forms of life the requirements of environment have evolved states of consciousness, or intelligence-factors, relating to its survival. One set of these intelligence-factors revolves about the universal urge for self-preservation through seeking safety, another set revolves about survival through aggression, another set revolves about the care of the offspring, etc. Furthermore, these intelligence-factors are organized into thought-cells and thought structures.

The astral body is thus composed of the psychoplasm of experience organized into thought-cells and thought structures; and these are mapped by the chart of birth. The prominence of a given planet in the birth chart maps the power of the thought-cells of corresponding quality in the astral body.

The position of the planet in the birth chart is not the cause of certain qualities of character. The cause of the qualities the planet's position and aspects indicate lies in the thought-cells and thought structures which it merely maps. But it does map the strength of a particular family—one family of the ten—of thought-cells as they are present within the astral form, and their harmony or discord and relationship to others of the ten families of thought-cells that are also present within the astral body. The character, as we discern it, is the external expression of the energies of the thought-cells and thought structures which the planets merely map.

As will be explained in more detail in lesson No. 122, the physical body in its growth, and in the replacement of tissues in later life, tends, insofar as it has materials at hand with which to do so, to reproduce the astral body in physical substance. The physical body thus, in its shape and structure, is built according to the pattern of the various thought-cells and thought structures and their interrelations, as these at the time reside within the finer form. Therefore, by becoming familiar with the particular physical characteristics by which each family of thought-cells tends to express its power or weakness, we have a guide to the power or weakness of the given thought family. Then from knowledge of the relative power and intensity and interrelations of the thought-cell families thus revealed, we may form an opinion regarding what the person thus appraised will do under given circumstances, and can make a just estimate of his abilities.

It will now be apparent that the whole art of instantaneous character reading is based upon ability to judge by the external form and actions the intensity and relations of the various mental factors that persist as thought-cells and thought structures within the finer body and constitute the character, or soul.

Blondes vs Brunets

—Usually, when it is desirable instantly to form an opinion about a person's character or ability, the object sought is to determine if he is suited to fill a certain place, if he is a reliable person, or how he will react to a certain situation. Under such circumstances the requirements of the occasion do not call for a minute analysis of the character in all its aspects, but rather a judgment relating to a few qualities that have a direct bearing upon the matter at hand. And although practice will enable a person at a glance to note a wide variety of character expressions, and thus instantly form a very reliable opinion about the character and abilities even in minor details, yet the chief end sought in instantaneous character reading is to be able to single out those marks of character which indicate the qualities relevant to the matter at hand and pass instantaneous and correct judgment upon them.

In considering these external characteristics, by which the inner character may be judged, it will be advantageous, insofar as possible, to commence our studies with those that are most obvious and easily noticed, and proceed gradually to those which require more minute observation and detailed analysis.

One of the most familiar methods by which people describe each other is to class them as blondes or brunets. That this method of description is so popular proves that it is a distinction commonly and easily recognized. The races of the world readily fall into the category of light peoples and dark peoples. Likewise, among the white races, there are light whites and dark whites. The Nordic people are blond, the Alpine people and the Mediterranean people are brunet, yet these three races are all white, and the population of Europe as well as that of America is very largely a mixture, in varying degree, of these three white types.

Some people by their blondness, by the ranginess of build, and by the high-crowned, long, narrow heads, instantly show the characteristics of their Nordic ancestry. Some people, by their brunetness, by their rather frailness of build, and by their long, narrow heads, show the characteristics of their Mediterranean ancestry. And still other people, by their brunetness, by the rather short and quite stocky build, and by their low-crowned, broad heads, show the characteristics of their Alpine ancestry. But unless we are very careful we are apt to get the cart before the horse and conclude that races have certain characteristics because they are fair, or rangy, or brunet, or thickset, when the reverse is the case.

There is a constant action of environment to produce thoughts of a certain type, and these thoughts influence the shape of the head, the form and size of the body, and the color. Environment has a temporary influence directly upon the body, as when abundant food nourishes, or lack of it depletes, or when the sunlight produces a darkening of the skin. But the more permanent changes in color, form, and structure, are due to the persistent thinking of a certain type of thoughts that have been stimulated by the environment.

For this reason we need not go, to any great extent, into the racial history of the people whose characters we wish to analyze. The racial history, insofar as it affects the character, reveals itself in the physical form. Of more importance than racial history is the history of the soul as it evolved through the various lower forms of life. Its character when born into the human form depends upon the states of consciousness organized in its astral body before human birth. Whatever tendencies were most strongly accentuated by the demands of environment previous to human birth will be most strongly accentuated—due regard being paid to it now functioning on the human plane—in the human character.

The human character is but the expression, on the human plane of endeavor, of all the characteristics previously acquired. But as through the Law of Affinity a soul is attracted to parents whose vibratory rates at union correspond to its own vibratory rates, it is attracted to a race corresponding to its own qualities. And as the same thought-cells that constitute the character likewise tend to give the physical body its texture and form, from the bodily form we can infer the type of experiences in the soul's past that have developed the character, as well as read the character itself.

We find in astrology that any thought-cell family may be quite as powerful in one person as another, yet manifest through different departments of life. For instance, one person may be selfish where money is concerned, but not selfish about his family and friends. Another person may be very selfish where family and friends are concerned, and not very selfish about money. The selfishness, in each instance, may be due to an overdevelopment of the Safety thought-cells—astrologically ruled by Saturn—but in one instance organized about finances, and in the other instance about friends and the family. Therefore, we must be cautious in our interpretations not to confuse the very weak development of a group of mental elements with its expression in a single channel, for the element may be there but express through a different department of life in one person than in another.

From the color white all the visible light rays are reflected. It is the positive color. From the color black none of the visible light rays is reflected. It is the negative color. Furthermore, black skin through its absorbent qualities protects its wearer from the actinic rays of the sun. Fair skin is adapted to a region of less intense sunlight where such protection is unneeded. Blondes are blondes, however, because the Power

thought-cells and the Aggressive thought-cells are powerful in the astral body. This means astrologically the Sun and Mars are prominent in the birth chart. Brunets are brunets because the Safety thought-cells and the Domestic thought-cells are powerful in the astral body. This means that Saturn and the Moon are prominent in the birth chart.

Blondes love power. They like to dominate others. They like to handle large affairs. They have executive ability. Brunets are more submissive. They do not like too large responsibilities. They are good managers where aggressiveness is not required, and excel in administration.

Blondes act quickly and have great strength. Brunets act more deliberately and have greater endurance.

Blondes are inventive, creative, resourceful and original, but dislike the tediousness of carrying out their plans. Brunets are more patient, painstaking and thorough, and tend to finish what they start.

Blondes are hopeful, fearless, restless, and ever willing to take a chance. Brunets are meditative, more quiet, careful, conservative, and cautious about a hazard.

Blondes love excitement and the crowd, They love to mix with people. They like change and variety, and this is true even of their affections. Brunets love the home, their friends, and their immediate associates, but are not so fond of crowds. They are more constant in their likes, and in their affections, and resent too much change.

Blondes love new friends and pioneer work, and are given more to generalities. Brunets love to remain at home and develop the immediate resources. They are given to specialization.

Blondes tend to express themselves in physical action, and in terms of concrete material results. They thus may become scientists. Brunets tend to express more through their emotions. They are more mystical, more religious in the devotional sense of the word, and may become philosophers.

Blondes have a genius for government. Brunets prefer to let others govern that they may have time and energy for something else.

Blondes are creative and inventive. Brunets are imitative, and improve and perfect the inventions of the blondes.

Blondes fall in love quickly, and out of love quickly. Brunets fall in love more slowly, their emotions are more intense, and their affections are more enduring.

Blondes tend to brilliancy. Brunets tend to painstaking and thorough accomplishment.

Blondes are much more apt to dissipate than brunets. Brunets are much more apt to seek revenge than blondes.

Blondes want action, they want facts, they have little patience; and concrete things and commercial interests appeal to them. Brunets are dependable, they want theories and reasons, they have patience and endurance; and art, religion, literature and philosophy appeal to them.

In sickness the blond tends toward the acute complaints, the brunet toward those that are chronic.

It should be understood, in drawing these comparisons between blondes and brunets, that blondness and brunetness constitute but one of several factors that always must be considered, such as the type of body, general proportions of the head, and the tendency of the profile. Nevertheless, blondness or brunetness will modify the character as judged by the other factors perceptible toward the traits enumerated above. That is, no matter what the other factors indicate, blondness or brunetness must be considered as modifying what otherwise is indicated.

Interesting Blondes and Brunets

—The typical blond has a fair or ruddy skin, flaxen hair, and blue eyes. The typical brunet has dark skin, black hair, and dark brown eyes. A person with dark brown hair, a skin neither dark nor light, and blue eyes, has some traits of both blond and brunet. Likewise a person with light hair, a skin neither dark nor light, and brown eyes, has some traits of both blond and brunet.

Which type of tendencies will predominate may be determined, if two of the three factors—hair, skin, and eyes—agree, by casting the deciding vote somewhat in favor of these two. But where hair or skin is neutral, being about halfway between, the predominance is shown by the eyes. That is, if the hair is light and the skin neither dark nor light, and the eyes are decidedly brown, it indicates more of the brunet tendencies. Or, if the hair is black and the skin is neither dark nor light, and the eyes are blue, it indicates that the blond tendencies are more powerful. The color of the eyes is a stronger index to the blondness or brunetness than the color of the hair.

Now having decided at a glance that a certain person is a blond or a brunet, and at the same time noting that the bodily build, the proportions of the head, and the profile—all factors that need but a single glance to ascertain—do not counteract, in any marked degree, the tendencies shown by the complexion, let us see what practical application may be made of these observations.

If a person applying for a position as a salesman is a blond, we decide that such salesmanship as he possesses can best be exercised through going out and getting business. If he is a brunet, we decide that he has not the kind of initiative to go out and hunt business, but that he has the patience, the desire to render service, and the carefulness, to stay in a store, or place of business, and successfully transact the business that comes to him.

Blondes, by temperament, are business-getters, but through impatience with details it often becomes necessary for them continually to hunt business, because they do not properly take care of what they get. Brunets, on the other hand, are business builders. They are steadfast and reliable, and take pains not to lose a customer. In management they are careful and systematic, and in their investments are conservative. They are consistent and persistent in their policies.

Neither should it be lost sight of that the blond likes the new, the novel, the exciting; and that adaptation to new circumstances is the very essence of his life. The brunet, on the other hand, cares little for new fields, and finds it most difficult to adapt himself quickly to changes in circumstances or environment. Therefore, a blond should not be given monotonous detail work, nor work that requires a set routine. The brunet loves routine and excels in it. He thus becomes a good mechanic and an excellent manufacturer.

Almost every broad field of endeavor offers certain positions that may best be filled by blondes, and others that may best be filled by brunets. Journalism, for instance, appeals to blondes in the department of getting news, or in the capacity of traveling correspondents; while it gives opportunity to the brunet to write sober articles, or editorials, that they have had time painstakingly to prepare.

In artistic and dramatic work blondes excel where short periods of strenuous work are required and where they influence people by their personalities.

Brunets excel in those departments that require long tedious preparation, the monotonous work of developing technique over years of time.

In business, a partnership between a blond and a brunet is often greatly to the advantage of both. The blond develops schemes for expansion, and exerts himself toward the rapid development of the business. The brunet sees the flaws in those of the blond's plans that are faulty, and curbs the tendency to over-expansion, at the same time giving the needed attention to the details of the business already built up.

Where quickness, alertness, adaptability and initiative are required, the blond finds his best field of expression. Where reliability, persistence, reflection, and carefulness are required, the brunet finds his best opportunity.

To interest a blond, talk to him of sport and adventure. Tell him something new and startling. Speak of the progressive side of your business. He is naturally optimistic, and will enjoy looking at the bright side of things. Material advantages appeal to him. If you have something to sell him, or something you wish him to do, appeal to his enthusiasm, to his love of power, of display, and of publicity, and then get his decision before he becomes interested in something else. Although he may change his mind later, he tends to make his decisions quickly.

To interest a brunet appeal to his emotions. His friends, his home, his religion, his philosophy, his sentiments, are interesting to him. Matters that have to do with the home environment and his safety, both now and in the future, will appeal to him. The artistic and the beautiful are themes that to him seem important. If it is to mutual advantage that he should follow a certain line of action, give him plenty of theoretical reasons, show how it will conduce to his ease and comfort, and give him plenty of time to think it over. He will not be carried away by enthusiasm like the blond, but he may be urged more, for the blond will quickly resent something forced upon him. The brunet, however, needs time to reach his decisions.

The blond employer likes to know he is the master, and he likes obedience from those he employs. He likes to see a good showing in the work at hand, and very much dislikes having his own mistakes pointed out. The brunet employer is not so fond of exercising his authority, but he demands system, thoroughness, and attention to details. The blond employer is more apt to change his opinion from day to day than the brunet.

These outstanding characteristics of blondes and brunets might be carried into every occupation and into every department of life, and the reactions, and abilities, and tendencies, of each type pointed out in connection with them. I believe, however, that the brief contrast in temperament already outlined will be sufficient to enable the student, by using a little ingenuity, to picture to himself the manner in which a blond would feel and act differently than a brunet under almost any conceivable situation.

This knowledge is of value in selecting a vocation, in employing others, in working for others, and in dealing with others in various ways. It is knowledge that may be used to influence others, but this may legitimately be employed only where it is of mutual advantage. Yet it is certainly of mutual advantage to know what one's employer wants, or how to converse with another person without stirring up antagonism. And the very things that please a blond are often those that displease a brunet.

The Five Easily Recognized Bodily Types

—Another thing that commonly registers on our consciousness instantly when we meet a person is the size, contour and bodily proportions. One will hear persons described, rather vulgarly, to be sure, but nonetheless accurately, as a fat blond, a tall, bony brunet; a frail, nervous man; a florid, vivacious woman; a well-muscled youth; and so on. The universal use of such terms in describing people to those who have not seen them, or as a means of identification, indicates that these are physical characteristics that are most readily noted. Consequently, as it requires no special development of the powers of observation to recognize them, we may well make them the objects of our next consideration.

Considering the human body very broadly we find that it embraces seven somewhat distinct systems, each presided over by one of the seven lower-octave planets and cooperating for the welfare of all. There IS the bony system, presided over by Saturn, which affords stability and support for the body as a whole. The bones are the framework to which the muscles are attached, and without them man could neither stand nor resist pressure from the outside world. Then there is the muscular system, presided over by Mars, whose function, by virtue of its contractile fibers is to afford physical movement. The alimentive system, governed by the Moon, prepares the food taken into the body in such a way that it can be used for fuel or to restore wasted tissue.

The arterial system of the bloodstream, ruled by Jupiter, carries the food, and oxygen from the lungs, to the tissues where needed. The venous system of the bloodstream, presided over by Venus, carries away the waste products, delivering them to the organs whose duty it is to dispose of them. For character analysis purposes it is more convenient to consider these systems ruled by Jupiter and Venus as one circulatory system and thus related to one easily recognized bodily type.

The endocrine gland system, governed by the Sun, exerts a directing and controlling power over the other six systems. Its prominence, however, is more easily recognized by the height of the head above the ears than by a special type of body. But the nervous system, ruled by Mercury, at whose apex is the brain, whose organic wires carry messages to the other six systems, and which is responsible for all objective processes of thought, expresses its outstanding prominence in a characteristic type of physical body.

The seven complete systems of the human body as a rule are not equally prominent in one person. Instead—omitting the endocrine glandular system type and merging the arterial system and venous system into one circulatory system type—more often than not one of the five types is prominent enough to give a quick classification. Of course, some people are so nicely balanced that the preponderance of one of the five systems is not easily noted. But in the majority of people we meet, a first glance reveals the accentuation of one or more of them. Inelegantly we say that a person is raw-boned, meaning that the bony system is so prominent as at once to catch the eye. We say of another that he is decidedly muscular, or athletic, acknowledging the dominance of the muscular system. A third person we speak of as being heavy, or fat, indicating that the alimentive system is so active that it has produced a surplus of flesh. A fourth person we speak of as being vivacious, indicating that the strength of the circulatory system and the consequent supply and oxygenation of the blood is such that there is an appearance of unusual life. Of still another we say he is of the nervous type, or mental, indicating that the brain and nervous system are developed proportionately more than the rest of the body.

Now if the bones have developed proportionately more than the other systems of the body, it indicates that there are certain thought families in the astral body, which as the physical body grew, were powerful enough to select more material from the blood than other thought families were able to select.

The fact that the form is bony indicates that there are thought structures in the astral body of the particular type that correspond to this bony structure. In other words, the chief qualities of the character stand in the same relation to the average character of mankind as the chief system of the body stands to the average bodily structure of mankind. Therefore, as a preponderance of bony structure gives unusual rigidity, firmness, strength, resistance and awkwardness to the body; so do these imply thought-cells in the astral body which cause the character to be unusually unbending, strong, fixed, firm, conservative, and undiplomatic.

If we keep in mind that the external form is the expression of internal attributes we will not go far wrong in our judgment of character.

How to Recognize Bony People

—We might very well use more elegant terms than bony, muscular, fat, vivacious, and mental, to designate the types under which mankind may be classified due to the preponderance of one of the five great bodily systems. However, as our aim is to classify them instantly, it will be of advantage to have such a name to designate each type that it comes spontaneously to mind. The names mentioned do not need to be learned; they instantly suggest themselves.

The bony person, of course, is one in whom the bones are noticeably large in proportion to the rest of the body. He may be either large or small, although more often he is tall. His elbows, wrists, ankles, and other joints are prominent. There is an appearance of physical rigidity that is difficult to mistake. He looks rugged and immovable, and often has a prominent “Adam’s Apple.” When he sits in a chair he does not slouch, nor does he twist and turn when seated. He sits deliberately, and sits rather straight and immovable. When he walks he swings along with deliberation, without looking much to either side, and turning as little as possible from the direction he has chosen.

The face is rather angular also, tending to be long rather than broad. The cheek bones are often high and prominent, although not noticeably the widest portion of the face. The body and the face do not impress one as being triangular, round, hexagonal, or square. They give the impression of an oblong, and the general contour is rugged rather than smooth. The hands also are oblong and the knuckles of the fingers being large gives to them a gnarled appearance.

In astrology we find that Saturn rules the bony framework of the body. We find also that Saturn rules the Safety thought-cells. This does not imply that the bony person is timid, or that he avoids difficulties, for the Safety thought-cells obviously have not here been evolved under conditions demanding flight. In its evolutionary past the soul has had to provide for its safety through resisting the encroachments of environment. By its ruggedness, tenacity, fixity of purpose, and ability to endure hardships and yet live, it has provided for its safety.

Not by conforming to changes in environment, but by building up organisms that would compel the environment to adapt itself to them, has such a soul made progress. Plodding persistence in the face of all obstacles has so organized the thought-cells in the astral form that when human birth takes place they tend to the growth of a body of the bony type. And we shall find, in analyzing the character of the bony man and woman that the key-word best describing them is INFLEXIBILITY.

How to Recognize Muscular People

—The muscular person is one in whom the muscular system is more in evidence than any of the other four systems. He may be large or small, although when typical he is not over medium height. He has not the raw-boned appearance of the bony man, nor the plump appearance of the fat man, but a certain well built appearance. His bones are well covered with muscles, but with little or no excess fat. His appearance does not so much suggest rigidity as physical force. And he confirms this by his actions. He speaks with a loud voice. When he walks, he steps with vigor. When he sits down, he does so solidly and with energy. His neck is not fat, neither is it long, but strong and thickset. His shoulders are square and his arms unusually long. When he shakes hands there is nothing half-hearted about it. In fact, in all his movements force and decision are discernible.

The face is not so rugged as that of the bony man, for muscles better cover the bones. Neither is the face so long. It has, when viewed from the front, a decidedly square appearance. This is the “iron jawed” man we sometimes read about, the jaw being decidedly square. Not only, as mentioned, are the shoulders square, but the whole contour of the body, instead of being long or plump, impresses one with its squareness; The hands also, instead of being pointed like the vivacious hands, or rugged like the bony hands, or soft like the fat hands, or frail like the mental hands, are well muscled, of the type known as useful, the tips of the fingers, and the outline of the hand as a whole, being square.

In astrology Mars rules the muscular system. It also rules the Aggressive thought-cells. In supplying the needs of the organism, as well as in repelling invasion, rapid movement is a great asset. Activity is also useful in flight, but those mental factors which are responsible for building up a proportionally large muscular system in man have largely been organized in the soul’s past evolution through strife and conflict. The muscular man, tending to shortness and heavy-setness rather than to length and slimness, is better fitted by his strong muscular development to fight than to run away.

Not by fleeing from antagonistic factors in the environment, but by fighting and overcoming them, has such a soul made progress. Tireless energy and ceaseless movement have so organized the thought-cells in the astral form that when human birth takes place they tend to the growth of a body of the muscular type. And we shall find, in analyzing the character of the muscular man and woman that the key-word best describing them is ACTIVITY.

How to Recognize Fat People

—The fat person is one in whom the results of the activity of the digestive and assimilative functions are more markedly in evidence than any of the other four systems. Owing to the undue activity of the system that takes care of the nutrition of the body there is a surplus of fatty tissue. The bones of the typical fat person are not large, but are well padded with soft, spongy flesh. As a consequence, in sharp contrast to the bony type, the joints are the opposite of being prominent, being marked rather by depressions. The suggestion is that of plumpness, and often there is a large waistline or ample hips.

The lines of the fat person are neither oblong nor square, but are curves tending toward the circle. The body is rotund and largest at hips or waist, the shoulders are sloping, the face is circular. The hands are short, plump and soft. The fingers are round, the neck is short and round. These people do not move much, resent being hurried, and when they do move, take their time about it. They usually lack grace in action, and when they sit down, rather slump into their chairs.

In astrology we find that the alimentary system is governed by the Moon. The Moon also governs the Domestic thought-cells. These Domestic thought-cells relate to the home life, to providing for the family and to rearing the young and taking care of the helpless.

These thought-cells have not been organized as structures within the astral body by seeking to resist changes in environment, or through activity triumphing over them. They have been organized through the utilization of materials for sustenance. The selection of an enjoyable home, free from the rigors and inclemencies of the weather, and the stocking it with ample provender, has been a decided factor in such a soul's progress. The recurring desire to procure these pleasurable conditions has so organized these thought-cells in the astral form that when human birth takes place they tend to the growth of a body of the fat type. And we shall find, in analyzing the character of the fat man and woman that the key-word best describing them is COMFORT.

How to Recognize Vivacious People

—The vivacious person is one in whom the circulatory system of the body in proportion to the other four systems is unusually strong and active. Because the arterial stream distributes oxygen and nutrition so thoroughly, and because the venous stream removes the waste products of combustion so quickly, there is an unusual amount of buoyant vitality expressing itself continuously in thought, feeling, and action. To pump the large amount of blood to supply the vivacious person adequately with oxygen there must be ample room for heart and lungs, and as a consequence the chest is high and the waist long. The greatest circumference is that of the chest, rather than around the abdomen or hips. Also, on account of the strength of the bloodstream, there is considerable color to the skin. That is, the face and neck flush easily, or in extreme instances, there is a decided tendency toward being florid.

Either blondes or brunets may belong to the vivacious type, as recognized by the bodily form and the tendency of the skin to redden easily under emotion or excitement. More red-haired people, however, belong to this type than to any of the other four. The face is broadest at the cheek bones, which are unusually high. This gives the face something of a hexagonal (six-sided) appearance. It tapers above and below from the cheek bones, but not to a point, the top of the head and chin forming the top and bottom sides of the hexagon. The body, likewise, has something of this hexagonal appearance, tapering from the chest to the feet and from the chest to the head, the head and feet forming the two sides of the hexagon. The feet are long with high instep, and the hands are of the pointed type, the fingers long and tapering.

In astrology Jupiter rules the arterial system and Venus the venous system of the blood. They rule also the Religious thought-cells and the Social thought-cells respectively. These thought-cells have to do with responding by the individual to a complex set of relations governing his contact with other entities and forces in nature by which he is surrounded, and to a complex set of relations governing his conduct to other individuals of his own species. These thought-cells which externalize as the vivacious type have been largely organized in the soul's past evolution through ready and adequate response to complex stimuli.

Through a rapid and temporary adjustment to ever-changing conditions in the environment has such a soul made progress. Instantaneous and energetic response to complex demands of the environment have so organized these thought-cells in the astral form that when human birth takes place they tend to the growth of a body of the vivacious type. And we shall find in analyzing the character of the vivacious man and woman that the key-word best describing them is RESPONSIVENESS.

How to Recognize Mental People

—The mental person is one in whom the brain and nervous system are more fully developed than any of the other four systems. The head is large in proportion to the size of the body. The body tends to be frail. The fingers are smooth and the hands rather thin and delicate. The body appears widest at the shoulders, tapering toward the feet. The head appears widest near the top, tapering toward the chin. Thus the mental person suggests a triangle with the point down. The movements tend to be jerky and uncertain without the force of the muscular person or the elasticity of the vivacious type. There is discernible a certain lack of physical power.

In astrology Mercury rules the nervous system. It also rules the Intellectual thought-cells. In adapting itself successfully to any condition of life, perhaps nothing is quite so valuable to an organism as intelligence. The repeated use of intelligence is responsible for building up those thought-cells in the astral body that when the human form is attained externalize as a large brain and exceedingly sensitive nervous system.

Not by fleeing antagonistic factors in the environment, not by enduring them stoically, nor by fighting them, has such a soul made progress. It has outwitted antagonists and circumvented obstacles. Through the ceaseless use of intelligence it has so organized these thought-cells in its astral form that when human birth takes place they tend to the growth of a body of the Mental type. And we shall find, in analyzing the character of the mental man and woman that the key-word best describing them is THOUGHT.

Chapter 5

Serial No. 122
Original Copyright 1940
Elbert Benjamine

Copyright
Church of Light
August 2002

Significance of Body and Head

Chapter 5

Significance Of Body And Head

It has now become quite evident to material science that the conspicuous properties of the electrons, positrons, neutrons, atoms and molecules of matter are due to the immaterial Boundary-Line energy associated with them. Certain immaterial fields hold these particles apart and prevent the collapse of the matter composed of them. Otherwise the material of our earth, shrinking to a small portion of its present size, would be comparable in density to that of the white dwarf stars, and an amount such as could go handily into the pocket of a coat would weigh tons. Still other immaterial fields provide the chemical affinity of the atoms which holds them together in molecules. And immaterial gravitational fields attract the objects built up of molecules each to the other. Likewise it is the immaterial fields of the thought-cells which determine the form into which any living organism shall grow.

The thought-cells are composed of the psychoplasm formed on the astral plane by states of consciousness derived from any and all experiences. According to the type of experience which organized them, these thought-cells belong to one of ten thought-cell families. And these various thought-cell families have been organized by the experiences that brought them into existence into definite thought structures. The sum total of the thought-cells and thought structures associated with an organism, and their relation each to the other, constitutes the character, or soul, of that organism.

Thought-cells and thought structures, residing in a realm where the velocities are greater than that of light, cannot exert an influence directly upon matter which has a velocity much less than that of light. But where the essential conditions of contact are present they can, and do, exert a directing and molding force upon matter through Boundary-Line energy which has a velocity approximately that of light. The physical body of living organisms is composed of protoplasm and its secretions. Protoplasm is a complex mixture in which the elements carbon, oxygen, hydrogen and nitrogen are always present, and in which many other elements such as sulphur, iron, calcium, phosphorus and iodine frequently occur. These elements appear in three complex classes of chemical compounds, and in many others which are intermediate, or which are waste products of organic chemical processes.

The three classes embrace the proteins, the carbohydrates and the fats. The proteins are composed of carbon, hydrogen, oxygen and nitrogen and usually sulphur. The carbohydrates and the fats both contain carbon, hydrogen and oxygen, but the carbohydrates contain the hydrogen and oxygen in the same proportion as does water, while the fats contain relatively a much smaller proportion of oxygen. In the muscular type of person the proteins are more in evidence, while in the fat type of person the fats have a more outstanding role. The proteins are chiefly materials of construction. The carbohydrates and fats are energy sources.

In protoplasm these materials are associated in that finely divided condition known as the colloidal state, in which the extensive surface contacts of particle with particle or with surrounding fluids facilitates all the chemical interactions of which they are capable. Some of the proteins in both the nucleus and the cytoplasm of a living cell are in a colloidal state in which matter is suspended as small drops having high electric charges which are variously distributed in the interior or the drop or on its surface according to the special kind of protein. In other words, the structural materials of the body, the proteins, as they are formed from the amino-acids, not only are in the special condition which facilitates every chemical change of which they are capable, but they are so charged with Boundary-Line energy that these chemical changes and the distribution of the proteins about the body most readily can be, and are, directed by the thought organization of the astral body.

Proteins from dead organic life when eaten by man are split up into amino-acids by the enzymes in the processes of digestion. The amino-acids are carried by the blood stream to every part of the body, and accompanying the lymph seep through the tissue walls and thus are brought into contact with the walls of all the cells. They penetrate the walls of every living cell and enter into its cytoplasm.

Twenty of these amino-acids are known, and they enter into combinations which build up an infinite variety of proteins. The proteins of the body are not all alike, some being suitable for building glands, some for building one organ and some for building another. To form them the amino-acids combine with each other not only in various amounts but in various relations to each other. And the thought organization of the astral body not only has all the facilities at hand for determining which proteins shall be formed, through manipulating the fields of the protein drops already present, but the high electric charges of the small suspended drops when formed permit them to be guided, and the form composed of them to be molded, with great ease.

In lesson No. 123 more about the electrical properties of colloids, and how fats are handled, will be explained. The information it is here sought to convey is that the thought structure of the astral body, or soul, determines—to the extent the physical building materials furnished are able to duplicate that thought structure—the form and structure of the physical body, through exerting an influence upon the electric fields of the particles of which the physical body is composed as tissue is built or replaced.

The circumstance that an individual is lean and lanky, therefore, indicates that his thought-structure on the inner plane, his character, has a quality which expresses through this particular type of physical form. And when an individual has poor health we may know also that this is the outward expression of discords within the thought structure of his soul. While the physical structure is limited to the material available for its building, such materials as are used will tend, in the shape they are given, to be an expression of the more pronounced traits of the character.

At first thought, and without investigation, one familiar with astrology might think that as there are ten distinct thought-families there should be ten distinct types of people that could easily be distinguished from each other by their bodily proportions. And while it is true that the structure of the physical body responds in its shape to each of the ten families of thought-cells in relation to their comparative dominance, and thus reveals how prominent each family is in the character, the indications revealing the relative prominence of the Power thought-cells, the Individualistic thought-cells, the Utopian thought-cells and the Universal Welfare thought-cells are to be found in more special regions of the body rather than in its general proportions and contour. Thus in classifying the general build, we employ but the five types mentioned in lesson No. 121.

The five types of body chiefly relate to the prominence of the bony system ruled by Saturn, the muscular system ruled by Mars, the alimentive system ruled by the Moon, the circulatory system ruled by Venus and Jupiter, and the nervous system ruled by Mercury. Or to convert into birth chart terminology, a dominant Saturn tends to the bony type, a dominant Mars tends to the muscular type, a dominant Moon tends to the fat type, a dominant Venus and Jupiter tend to the vivacious type, and a dominant Mercury tends to the mental type.

A dominant Sun does not express as a distinct type of body, but it does express height of the head above the ears. Responding not only to thoughts of the Mercury type, of which we are objectively conscious, but also to unconscious trains of thought and feelings aroused through the thought-cells receiving the energy of progressed aspects, the secretions of the endocrine glands exercise a controlling influence upon both bodily functions and the trend of objective thought. The system of ductless glands which pours these hormones into the bloodstream in response to the activities of the thought-cells within the soul, is ruled by the Sun.

Through the suprarenal glands it regulates the supply of blood that goes to the various organs of the body. Through the thyroid glands it regulates the vitality, and hence the rapidity of growth of the tissues. Through the thymus gland it regulates the development of the sex organs. Through the pituitary glands it regulates sex differentiation and the growth of the skeleton. Through the gonad glands it regulates the growth of those bodily characteristics associated with one sex or the other, regulates the sex instincts, and controls the mental and nervous vigor. And through the parathyroid glands it regulates the calcium and phosphorus in the bloodstream

and through manipulating its chemical balance controls the stability and sensitivity of the nervous system. This system of ductless glands, only a few of whose functions I have mentioned, controls practically all the processes of the body. It is an expression of the Power thought-family within the astral form, mapped in the birth chart by the Sun.

The three families of thought-cells ruled by the three upper-octave planets are related in their expression more closely to man's finer forms. The Individualistic thought-cells ruled by Uranus have a powerful influence upon the electromagnetic form. The Utopian thought-cells ruled by Neptune have a special affinity for, and influence upon, the astral form. And the Universal Welfare thought-cells ruled by Pluto are related closely to the spiritual body. The activity of any one of these three super-material systems, however, is difficult to discern from the physical form. To detect them we must look to other physical characteristics such as the brilliance of expression of the eye, the actions, and any other manifestations which will give us a clue to the strength of these thought-cell families as influencing the character.

As already explained in lesson No. 121, in our endeavor to read character instantly we utilize the principle that the soul's experiences in lower forms of life have built into the astral body groups of mental energies. The sum total of these mental energies residing in the astral form constitutes the character at this time. These mental energies, which comprise the character, are also the energies that mould the form of the body as it grows or as new tissue replaces old. Mental energies of a certain type, which are likewise phases of the character, tend to produce a physical form also of a certain type. We strive, then, to recognize such physical characteristics as may be observed instantly, that experience has shown us to be the manifestation of certain mental energies, and in this manner determine the character.

We must be careful, however, not to overreach and read into a particular form a meaning foreign to the soul's past experiences that now result in this structure. We are not justified, for instance, in drawing the conclusion that because a muscular body is the manifestation of strong aggressive thought-cells that the muscular person will always be courageous, and that the bony person, showing as he does strong safety thought-cells will always lack courage. The bony person may also have aggressive thought-cells strong enough in his astral body to give him resolute and dogged courage, which will externalize in the body as a deep square-set jaw (more common to the muscular type), yet these thought-cells not associated with active aggression and therefore not evident in the development of the muscular system. If we are to avoid errors of judgment we must try not to judge too many qualities from a single indication, but rather learn to look for the one special indication that signifies the presence or absence of the quality we are looking for.

People, by temperament and natural endowment, are adapted to certain kinds of employment, to associate with certain kinds of people, to take pleasure in certain kinds of amusement, to thrive under certain modes of living and in certain environments. They are not so well adapted to some conditions, and still others cause them suffering. To find where his natural abilities lie is not the only factor in a person's success and happiness, but it surely is a factor of the very highest importance. Let us consider, therefore, the peculiarities and aptitudes of the five common types of people.

Characteristics of Bony People

—The typical bony person has a strong influence of Saturn in his birth chart. Of all the types he is the most steady and reliable, the least apt to lose his temper at trivialities, and the least responsive to the ideas and persuasiveness of others.

He is punctual, orderly and extremely systematic. He is a plodder. Slow in his movements, he is thorough, and finishes what he starts. Change irritates him. Too many irons in the fire confuse him. He is the type that does one thing and does it well. He has concentration and does best specializing along some one line. Mining and agriculture and wholesale dealing in building materials and products of the soil are pursuits to which he is adapted. He also may become a hardheaded business man. He attracts responsibility and likes it.

He is not a good "mixer" socially, and his vocation should not require that he should entertain or be entertained. Instead, it should be something in which system and order may be used to advantage. He is not given to trying to please others of either sex.

Such a person cannot be influenced through sympathy, but he may be influenced through an appeal to justice, or to utility. He likes others to be thorough, neat and punctual. Above all else he dislikes to be hurried. He also dislikes to be opposed in either his views or his plans.

He is not particularly apt at acquiring money, but he is a good saver and seldom is without some funds. He tends to be close in money matters, drives a hard bargain and plans ahead for a rainy day. He is exacting with others, yet pays his own bill when due. If he is an employee he should be given the responsibility of one department and then permitted to do his work in his own way. He resents suggestions from others. If he is an employer, his employees to give satisfaction should be prompt in going to work, and should take orders without argument.

The bony person makes few friends, but is very loyal to that few. Triviality of any kind disgusts him.

Display and flourish are annoying. He expects good service from others, and endeavors to render good service in his turn. He is thoroughly conservative in his views, and is the last to adopt new methods or new fashions.

He should not undertake work requiring versatility, responsiveness, or sociability. His work must be something in which system and persistence are the chief requisites. His viewpoint is that of utility, and he likes very much to have his own way. Therefore, in trying to persuade him, he should never feel he is being crowded into something, but that he has become interested in it because of the sound practicality of the proposition. He will take plenty of time to make up his mind, and will be more apt to look with favor on the proposition if he feels he has made the decision apart from outside influence. If unduly urged he becomes obstinate. When his mind is made up for or against a thing he will take his stand against the whole world. Of all the types he cares less for the opinions of others and is less moved by flattery or criticism.

Characteristics of Muscular People

—The typical muscular person has a strong influence of the planet Mars in his birth chart. The aggressive thought-cells thus indicated demand that he shall have a broad field for physical activity. He is apt to lose his temper rather quickly, and if he has been injured he will not forget it until there has been a settlement but he does not hold a grudge a lifetime as the bony person often does.

The muscular person is naturally a worker. He likes activity, and is always busy at something. He is dextrous with his hands, and those occupations, from mechanics to wielding an artist's brush or manipulating the keys of a piano, that require manual dexterity should be filled by those having the muscular element as at least the next strongest factor in their makeup.

All kinds of mechanical work, surgery, manufacturing, metal-working, and construction work, appeal to the muscular person. He loves the strenuous life, and gauges success by accomplishment. He puts force into all he does, and tends to overwork. If his work is somewhat sedentary it is unusually important that he have frequent vacations in the open. The strenuous sports appeal to him. He has little use for mere appearances. He demands that those who deal with him live up to their promises, and that those who work for him get their work done. Routine and detail do not seem particularly important to him. What seems important is that the work be accomplished. He therefore judges people not by their ancestry, but by what they have done. He resents snobbery, and will go out of his way to antagonize it. He is democratic at heart, and as a consequence, while not a brilliant "mixer" like the vivacious type, yet he gains considerable pleasure and profit in dealing with other people.

He is a practical person, and seeks durability and service rather than show and pretense. He wants necessities, not frills. At the same time he is generous to a fault, and often becomes a “free spender.” He is inclined to argue, but has a warm heart and may be moved by an appeal to his sympathies, or better still to his sportsmanship. He loves sports of all kinds. In this he is quite the opposite from the bony type and the mental type, who look upon sports as a whole as useless expenditure of time and energy. He likes very much actively to engage in sports as well as witness them, and in this he differs from the fat type) who likes to be entertained by watching the efforts of others.

The muscular type is a worker, a fighter, a builder, and often a driver both of himself and of those who work for him. Those who work for a muscular employer not only must accomplish what is required, but they must keep actively busy. He will not tolerate loafing, even when there is nothing to do. Those who have muscular people working under them will do better not to make their superior position too great a barrier. The muscular workman does not like to be bossed, but at the same time he likes to see his employer, and others, interested in his work, and he likes to talk it over with them, and give and receive suggestions as to how best his work may be done. He will take suggestions about his work if they are good, but he also expects his employer to adopt such suggestions from him as are meritorious.

To interest the muscular person, talk sport, action and work. To influence him treat him as an equal, and appeal to his desire for accomplishment. He will respond to enthusiasm, also to an appeal to his fighting qualities. He makes up his mind quickly. Therefore, in obtaining his support of any proposition, it should not be allowed to drag.

Characteristics of Fat People

—The typical fat person has a strong influence of the Moon in his birth chart. This signifies that the domestic urges have largely been responsible for the form of his body.

These domestic urges have to do with the home life and problems of nutrition and comfort. The fat person, therefore, whenever possible avoids strenuous work, avoids serious responsibilities, avoids strife and seeks comfort and enjoyment. Comforts and enjoyment, from his point of view, largely depend upon the things that money can buy. As a consequence, and because the thought-cells that have given him this particular form of body were largely organized in connection with providing nourishment and shelter, he is apt at acquiring money. It is the one thing to which he devotes considerable serious thought.

The fat man is naturally the middleman. He stands between the producer and the consumer as a go-between, taking a royalty for his services. He is a trader. He likes money, and dislikes hard work. So he finds a way to make money through dealing with others. He likes comfort, therefore he does not think about his troubles, neither does he tell them to others. He is an optimist, ever looking on the brighter (the more comfortable) side of things. He is a "jollier." He likes to joke and tell funny stories. He is deliberate and good-natured and people like him. And because people like him he gets along well in the world.

He has a pleasing personality and is a good "mixer." This helps him not only in business but in politics. When working for others he dislikes the hard work so strives to get a position as foreman. He is a good foreman, too, because he has a faculty of getting other people to do what he wants them to go. His strongest asset is his personality. His greatest fault is his tendency to self-indulgence. He will seldom take the blame for his own mistakes, usually passing the blame to another. He hates worry, loves to mix with people socially, does not hold a grudge long, and will have luxuries even when he cannot afford them.

To work successfully for a fat employer, save him as many steps as possible, and as much discomfort as possible. Do not tell him your troubles and do not worry him with difficulties, but solve them yourself. Do him favors when you can, and receive favors from him; for he likes to be helpful to others. If you have a fat person working for you, do not hurry him—as no fat person likes to be hurried—but at the same time insist on punctuality and adequate service. His tendency is to be late at work and to sidestep that which is disagreeable.

The fat person, unlike the vivacious type, is not a faddist nor a reformer. He is a leisurely, peace-loving, family man. He is good-hearted and sympathetic, and his best sphere of usefulness is where he can meet people both socially and in business. He thus often becomes a good salesman.

To interest him, talk about shows and entertainments, and good things to eat, and tell him funny stories. To influence him give him a good time. Take him to a banquet, to a good show, and in every way make him comfortable. He will then listen to an appeal to his heart, to his sympathies, or to a moneymaking scheme. But if there is an obligation on his part the agreement should be made binding enough so that he may legally be compelled to do his part.

Characteristics of Vivacious People

—The typical vivacious person has a strong influence from both the planet Venus and the planet Jupiter in his birth chart. The social urges thus indicated demand constant intercourse with other people to satisfy them, and the religious urges demand an expression that will place the person prominently and favorably before the attention of others. These urges are not so much toward power, as toward seeking approbation and plaudits. The vivacious person likes to be in the spotlight, and the one thing he cannot endure is to go unnoticed.

He is the best “mixer” of all the types, because he not only enjoys being with people, but enjoys entertaining them. And the people he particularly likes are those who are responsive to his entertaining qualities, and the people he most dislikes are those who are cold and unresponsive. He likes variety and change, and is a great hand to lead in reforms of all kinds. Monotony kills him. In everything he does there is quickness and dash. He is fastidious in personal habits, lives well up to his income, and likes to dress in the height of fashion, adopting the very latest fads, and even inclining toward flashy dress.

He is buoyant, optimistic, rebounds instantly from reverses, and has a quality of elasticity and resilience that prevents him from taking his failures seriously for long. Consequently he suffers from few regrets. The present is too interesting.

Whatever he feels he shows for all the world to see. Whatever he plans or thinks he tells all his acquaintances about. He becomes confidential on short notice even to the point of telling all his family history and affairs. And because he is so interested and feels so keenly, people quickly become interested in what he tells. He is a great talker, and cannot endure to be alone long. Companionship is the essential part of his life.

He has a keen sense of humor, loves the dramatic, and is a seeker of thrills and excitement. He likes to hear about adventures, and because he enjoys variety, the vaudeville appeals to him as an entertainment. He is very sensitive to his environment, and must have his surroundings just right to do his best work.

In spite of being temperamental, he is the most popular of all the types because of his personality. His conviviality, frankness, and spontaneity win instant admiration. He has not, however, either the application or the shrewdness to succeed in the trades, in those arts requiring long training, or in business. Of the arts—for any of which he may have a flare—dramatic work comes easiest, and when there is some other type in his makeup almost equally as strong, he often succeeds in vocal work. His best field,

as a rule, is in advertising, decorating, window display, or the professions. He is extremely skillful and quick with his hands, so that dental work and surgery come within the scope of his abilities. The main essentials in the vocation he should follow are that there should be plenty of variety and change—such as in traveling salesmanship—and that he may capitalize his personality.

To work successfully for a vivacious employer, dress neatly, keep things clean, make a good showing, and do not be too sparing of praise for him and his abilities. He likes to be appreciated.

The vivacious employee likes to do nice work, if there is not too much routine about it. Many barbers and beauty-parlor employees are of this type. He can make things look attractive, and if praised enough will work hard. His best efforts, however, are in short active spurts, not in sustained endeavor. Above all things he dislikes drudgery and any kind of work that soils his clothing, or otherwise detracts from his personal appearance.

To get the interest of a vivacious person, give him a Joy-ride, or other thrilling experience, entertain him, talk adventure, reform, and sports to him, and still more important, be a good listener and appreciate his ability as a “good fellow” and entertainer. To convince him, appeal to his enthusiasm and sociability. And if there is any matter of importance, get his signature at once, for if delayed he will change his mind.

Characteristics of Mental People

—The typical mental person has a strong influence of Mercury in his birth chart. This signifies that the Intellectual thought cells have largely been responsible for the form of his body. These Intellectual thought-cells have to do with ideas. Therefore, the mental person is more interested in knowledge and the exchange of ideas than he is in any physical accomplishment. As a secondary characteristic, or even as the strongest influence in his makeup with one of the other types almost as strong, the mental qualities are the most valuable of all; for they give the ability to plan and scheme how the ends sought by the other types may successfully be achieved. But, according to current standards, the extreme mental type is seldom a success. He is too much engrossed in acquiring knowledge, or in planning how things may be done, to have much time for anything else. Researchers in scientific lines, college professors, in fact, many of the brainiest men of the world, are notoriously impractical and underpaid. They feel amply rewarded for effort if they add something to the sum total of human knowledge; or if, in the capacity of teachers, they are able to communicate knowledge to others.

The true mental type cares little for dress, is indifferent as to his food, cares nothing for the opinions of more worldly people, tends to be unorthodox, and spends as much time in meditation and study as possible. He dislikes business because it takes time and energy he would rather spend learning something. He is clumsy in the use of his hands, and in his movements, because he lives so much in his thoughts. Social affairs are a bore to him. He cares nothing for ordinary conversation, and talks little. If he is asked questions about some serious subject he will talk endlessly about it in detail; but seldom ventures such discourse unless asked, as he feels it will not be comprehended, and furthermore, he is rather timid and lacking in aggression.

He is sympathetic and recognizes the rights of others. He is extremely sensitive, and discord and strife of any kind cause him great discomfort, from which he flees whenever possible. His great diversion is reading. He likes all kinds of reading, likes the serious drama, and the movies. He cares nothing for active sports, but has an interest in mental games. He avoids the spotlight, is shy and reserved, and lives so much in a mental atmosphere that he finds it difficult to adapt himself to the physical demands of life.

The only things the purely mental type has to offer the world are his thoughts. He has not the physique for physical work, and he detests it. It is therefore more important for him than for any other type that he should get an education. And he can educate himself, even if he starts late in life, if he but will. Teaching, lecturing, writing, journalism; anything that essentially is an exchange of ideas, is a vocational field open to him. Less congenial, but occupations that he can follow, are secretarial work, accountancy, typewriting and stenography.

To work successfully for a person having the mental qualities strong, show that you know all about your work, and why things are done as well as how to do them. He feels that people should know the theory as well as the practice of things.

If you have a person of the mental type working for you, do not expect much manual work from him. Give him work that depends upon using his brain, and that does not compel him to mix with people.

To interest the mental type, give him the history of the enterprise at hand, and plenty of theories and reasons. Tell him the how and the why of things. But do not think because he fails to offer argument that he agrees with all you say. Ask his opinion, and then meet it with a logical reply. Enthusiasm will have no effect upon him, but he will accept logic and reason.

Height of the Head Over the Ears

—To determine at a glance, the power of the Power thought-cells in a person's astral body—represented by the prominence of the Sun in the astrological birth chart—insofar as they affect the qualities of leadership, rulership, and will-power, observe the height of the head directly over the ears.

The person who is high over the ears is ambitious, craves leadership, has self-confidence and dignity, loves to direct and control others, and dislikes very much being dictated to. He has a restless desire for authority, and if the head is extremely high may be self-willed and opinionated. Such a person, if he also has ideals and intelligence, may become a business executive, a political leader, or with less advantage a shop foreman. To make a good executive, much is required in addition to a head high at the ears, but do not look for an executive in one who is low at this point.

Those high at the ears like to direct and to be served, and they do not like to work in any inferior capacity. Position, honor, authority and power appeal more to them than money or other considerations. These other things, like money, are merely means by which they climb. Therefore, to interest or convince them, appeal to their ambition to rise in the world.

On the other hand, a person who is low above the ears is quite content to let the other fellow do the worrying. He is willing to serve, if thereby he adds either to his income or to his comfort. He views the struggles of the high-headed type for honor and position as futile efforts. A person low at the ears has little executive ability. If the head is at the same time wide, he will be stubborn and obstinate, but he is lacking in self-confidence and self-esteem.

In appealing to the person who is low above the ears, show him how he will gain materially, how he will have an advantage without increasing his responsibility, for he shuns responsibilities, just as the man high above the ears seeks them. Successful politicians, and all those who govern others, are high above the ears.

Height of the Head Over the Temples

—When the Utopian and Religious thought-cells are powerful in the astral body—revealed in the birth chart by the planets Neptune and Jupiter being prominent—insofar as they express through reverence, veneration, benevolence, philanthropy, philosophy, idealism, imagination and visualization, they cause the head to be high and dome-shaped directly over the temples.

The man who is high over the temples is the philanthropist, the idealist, the reformer, the truly religious man. He has both faith and vision. Such a person is ever seeking to live a better and higher life, and to help others live better lives. Whether he is preaching the doctrine of saving mankind from the flaming pits of hell, or, like an Ingersoll, trying to help mankind by banishing the fear caused by a belief in the aforesaid flaming pits, depends upon other things. But the person high over the temples is striving for spirituality as he sees it.

The person who is low over the temples, on the other hand, has little interest in ideals, or visionary projects, of any kind. He lives exclusively in the practical, and looks upon those who have untried schemes of any kind as mentally inferior.

Imagination, vision and planning capacity are great assets in almost any enterprise. The man high above the temples has them; but if the head otherwise is not well proportioned he will never get any further with his ideas than talking about them. He will spend too much of his life telling people just how the world should be run, without doing anything practical to help change conditions.

The successful reformer in any line has intelligence, and is high above the temples, giving him ideals, and high over the ears, giving him the ability to handle others.

To interest or influence a person high over the temples, talk philanthropy and present the religious, the ideal, the humanitarian, side of the proposition. To interest or influence one low over the temples, stick to practical and demonstrated facts, and waste little time telling how it will benefit anyone but himself.

The Width of the Head at the Ears

—The Aggressive thought-cells—shown in a birth chart by the position of the planet Mars—as expressing their influence upon the vitality and the constructive and destructive qualities manifest in the form of the head as the width at and near the ears.

A head wide at the ears indicates great energy and the ability for sustained and active effort. People who are advocates of “the strenuous life” are wide at the ears. They can work hard enough, and long enough hours, to kill a person who is narrow between the ears, and maintain fine health. Courage is indicated also by the height of the head at the ears—by the Power thought-cells—as well as by its width, and also by the set of the jaws. But people who are wide at the ears when aroused are furious, and it takes great punishment to stop them. They have physical vitality and energy in abundance. People who are narrow between the ears are weak in physical vitality and energy, and as a consequence require shorter hours of work, better food and more of the comforts of life, to thrive.

The width immediately above the ears, also slightly in front of them, is an index of constructive qualities. The person who is wide here has mechanical ability, and the ingenuity and skill to build things. He may build a machine, or build a business, or build a political organization; but he has powers of construction and destruction.

The person wide-headed at the ears hammers his way through opposition, and pays not the slightest attention to discords. He is not sensitive, lacks in diplomacy, is blunt, forceful, and tends to crowd others out of his path with little ceremony. He uses force, and only greater force appeals to him. The person who is narrow-headed at the ears is sensitive diplomatic, considerate of the viewpoint of others and cannot endure harshness and discord. The person narrow at the ears is peaceful and easy-going, and must use tact and cunning when competing with the more aggressive person who is wide at the ears.

The Width of the Head at the Temples

—The Safety thought-cells and the Religious thought-cells existing in the astral body—indicated by the positions of Saturn and Jupiter in the birth chart—insofar as they have a determining influence upon commercial transactions, express as width of the head at the temples.

Saturn and Jupiter are the two business planets, and when they are prominent in a birth chart, the person is quite full at the temples, and as a consequence has a natural instinct for trading and for the value of things. The recognition of the value of material things, from a commercial standpoint, is a special ability. Intelligence in other directions has little or no bearing on it, and many persons almost totally ignorant in other matters have the business acumen to amass a fortune. These persons are wide at the temples. Yet the famous scientist, or artist, or philosopher, whose head shows slight depressions at the temples, has a hard time to pay for his food and clothing.

If you are dealing with a person, and you note that he is slightly full at the temples, it will pay you to be very careful how you trade. He is the man who, even though next minute he gives you part of it back, or turns most of it over to charity, glories in getting the best of a bargain, and knows how to do it. On the other hand, if you are choosing a man to handle your finances for you, either to invest your money, or to guide the financial end of some business in which you are invested, he is the very man. He feels a bargain, and can make money. He is not likely to be led into any wildcat enterprise. But the man narrow, or slightly depressed, at the temples, had better get some man who is full at this point to make his investments for him. He may be a good salesman, or an intelligent organizer and executive, but he does not know how to make money.

The Length of the Head from the Ears Back

—The domestic thought-cells, the Social thought-cells and the Universal Welfare thought-cells existing in the astral body—indicated by the Moon, Venus and Pluto in the birth chart—in their expression as affecting family life and the affections between people, and ability to cooperate with others, tend to cause the head to be long from the orifices of the ears back.

A person who has a flat back-head, the back of the head seeming to be but a continuation of the neck, has neither sympathy nor kindness nor cooperation in his makeup. He is woefully deficient in his knowledge of human nature, and has no conception of what the Brotherhood of Man means.

A true humanitarian not only has a head high at the temples, giving him ideals and inspired theories, but he has a head long from the ears back, indicating that he feels acutely for the sufferings of others, and that he knows how to treat kindly those less fortunate than himself.

The person with a short back-head, especially if the head is wide, is a ruthless individual, caring nothing for the comfort of his family or anyone else. Such a man values his wife and children much as he does his horses and cattle, by the amount of use they are to him. In his contact with his fellowman he instantly arouses antagonism; for his bluntness, and lack of feeling, soon apparent, are resented. Such a person, therefore, should not be permitted to contact the public. He is better working at some trade where he works by himself, for he is often a good mechanic. He has no ability to cooperate with others.

The person, on the other hand, who is long from the ears back, through his sympathy and kindness, wins people. They like him and will cooperate with him. He is a good family man, and will deny himself that his family and friends may be comfortable. He may, or may not, be a success in life in other ways, but people will call him a good and kind-hearted man. He may, or may not, be a good “mixer” in the accepted sense, but at least he can successfully meet the common people, and thus is well fitted for the retail trade.

The Length of the Head from the Ears Forward

—By the length of the head from the orifices of the ears forward may be determined the power of the Intellectual thought-cells in the astral body. These Intellectual thought-cells—shown in the birth chart by the planet Mercury—are in many respects the most important of all. They determine the capacity for expression of thought. The person who is long from the ears forward has the ability to think. To what extent he uses this ability depends upon other things, but the length of the head in this direction shows his capacity for intellectuality.

A person long from the ears forward, like the one long from the ears back, is of a friendly disposition. But his friendliness is based more upon the desire to exchange ideas, to learn and to teach, than upon sympathy and emotion. He also understands his fellowman, understands him not so much because he feels with him, but because he has studied his viewpoint. Just what turn his intellectual bent takes must be determined from other things. He may be a scientist, a business man, a philosopher, a preacher, or what not. But if he is long from the ears forward, whatever he does, he uses his brain in doing it.

The person who is short from the ears forward is lacking in true intellectual capacity. He may be very skilled in some certain line, but he lacks the ability to think clearly and protractedly on a variety of subjects. Those short from the ears forward permit others to do their thinking for them.

The person who is short from the ears forward will not be interested in, or impressed by, learning. He must be appealed to with tangible and not to remote advantages. The person long from the ears forward can perceive the advantage of something in the more remote future, and he is interested in the exchange of thoughts and opinions. If a position requires a thinker, the man with a long head from the ears forward is the man.

Chapter 6

Serial No. 123
Original Copyright 1940
Elbert Benjamine

Copyright
Church of Light
August 2002

Instantaneous Reading from Profile

Chapter 6

Instantaneous Reading From Profile

FOR a clearer comprehension of the ease with which any pronounced change in the thinking also changes the structure of the physical body, and thus not only affects the health but the discernible characteristics of the form, it is necessary to understand more details of the electrical properties of colloids. Some of the physical characteristics, such as the blondness or brunetness and the general size of the bony structure, are expressions of thought-cells within the astral form that are so stable in their organization that only a different manner of thinking carried out intensely and over a long period of time can have an appreciable effect upon them. But through the constant replacement of outworn tissues by materials which reach them in the colloidal state, other factors of the bodily form respond with great alacrity to any change of the inner thought structure which comprises the real character.

Water is a chief ingredient of the bloodstream; and water carries the materials assimilated from food not only in solution but also in emulsion. Oil, or drops of fat, will not mix with water. To understand why, it is necessary to know that, according to late findings of material science, water in the liquid form consists of a mixture of inactive atoms and active atoms. The two atoms of hydrogen and the one atom of oxygen comprising a molecule of water, in the active molecules carry a positive electric charge on one end of the molecule and a negative charge on the other. Sugar is a carbohydrate which quickly enters the bloodstream. When it enters into solution with water, it is because the relatively large sugar molecules have electric charges sticking out of their sides. The active water molecules, because they have opposite charges of electricity on their ends like a bar magnet, are called polar molecules. Due to the large electrical charges of the sugar molecules, these rapidly moving polar molecules of water, also carrying electrical charges, through the attractions of their fields for the fields of the sugar molecules, quickly pull these molecules of sugar away from each other and the sugar thus becomes dissolved in the water. The hotter the water, the more quickly the sugar dissolves, because the active water molecules are moving faster and more readily contact the fields about the sugar molecules.

Not all substances possess polarized molecules. Fats and oils, for instance, whether taken into the system as such or converted from carbohydrates, have nonpolarized molecules in which the positive and negative charges are so related that they neutralize each other. Carrying no appreciable charge for the fields of the water molecules to act upon, the water molecules cannot mix with them, cannot tear them from each other and cause them to dissolve.

There are other substances, however, unlike water, part of whose molecules have a charge on either end, and unlike sugar, with charges on the sides of its molecules, and unlike oils whose molecules are nonpolar. These substances have an electric charge at one end of the molecule, but the other end of the molecule is electrically neutral. Hence when they are brought into contact with the active, and therefore charged, molecules of water, if they are light enough to float the charged ends of their molecules stick down into the water, due to the attraction of the fields on the end of the water molecules. As the charged ends are down, this means that the neutral ends are up. And the attractive force of the down-pointing ends causes the substance to spread out as a film so that by occupying as large an area of contact as possible with the water more molecules can respond to this attraction between the two sets of molecules. Soap is such a substance, and this action of the fields of the water molecules on the fields of the soap molecules explains how a soap bubble is formed, and why, compared to its thinness, it is so very strong. It is strong because of the power of the fields of the two types of molecules composing it to attract each other.

Now as such substances as soap have one neutral end, when they are placed in oil, instead of water, their charged ends are not attracted to the non-polar molecules of the oil, but turn away from them, so that they float on the oil with the charged ends up. Then if water is added and the mixture is well shaken, the oil droplets are diffused throughout the water and we have what is called an emulsion.

The oil is not dissolved in the water, merely disseminated through it in a finely divided state. But it tends to retain this state because the soap, or similar substance, on the surface of each drop of oil, has the neutral end of each molecule sticking down into the neutral oil, and the charged end sticking out into the water and holding to the water molecule by the attraction between their mutual fields.

When the oil drops are very small, such as they are when taken into the human bloodstream in the process of assimilating butter, animal fat and vegetable oils, or the carbohydrates after they have been converted into fat, instead of calling it an emulsion, it is said to be in the colloidal state. And in the colloidal state these drops of oil which become fat, and the particles of protein which become muscle, are capable of carrying on their surfaces electric charges which are exceedingly large in proportion to the mass of the particles carrying them.

This means that the building and replacement material of the physical body, at the time it is being incorporated into the physical structure, is in that state which enables it to carry heavy electrical charges which permit it to be moved about and manipulated with the greatest facility by the electromagnetic energies generated in the nervous system. It is by means of these electromagnetic energies that the orders of the brain to the organs are delivered, that the thoughts we think reach the astral form, that we are able to remember past events by bringing them through from the soul, and that all control of our minds over our bodies is carried out.

The thought-cells and thought structures of the soul are at all times, while physical life lasts, in intimate contact with these electromagnetic energies generated by the nervous system. Through them they exercise a constant influence on the distribution of all materials furnished through the digestion and assimilation of food. And this influence, which is exerted through the electromagnetic energies of the nervous system acting upon the electrically charged particles of the physical materials being incorporated into the body, is toward building just such a physical form— including both the harmonies and the discords which express as health and disease—as constitutes an exact replica of the thought structure, or character, of the soul.

The Three Types of Faces

—In addition to noting the general form of the body—whether it is bony, muscular, fat, vivacious or mental, a first glance also gives an impression of the contour of the face. When we look at some persons the impression we get of their faces is of extreme pointedness, others impress us with the incurving quality of the countenance, and still others present faces in which all the lines seem straight and abrupt. These facial shapes, even as are the shapes of the head and body, are the expression of the internal mental forces that constitute the character. As true expressions of character they reveal to the discerning, only in less degree than do the acts, the qualities of character of the person possessing them.

Faces may aptly be classified into two shapes, and a third which is intermediate, even as nature's forces may likewise be classified into centrifugal forces, centripetal forces, and those acted upon by both of these and consequently intermediate between them. A centrifugal force is one which tends to move away from the center. It corresponds to the out-curving, or convex, face. A centripetal force is one which moves toward the center. It corresponds to the in-curving, or concave, face. It is the centrifugal motion of the planets—their speeds—which keeps them from falling into the sun. It is the centripetal force, expressing as gravitation, that keeps the planets from flying from their orbits into outer space. It is the balance between the speeds of the planets and the force of gravitation that holds them to their orbits. And it is the balance between the speeds of the out-curving faces, and the more thorough,

painstaking in-curving faces, that keeps civilization from dashing into exploits and ventures for which it is not yet prepared. For speed, look to the person whose features have an outward curve. For carefulness, look to the dish-faced person, the one whose features curve inward. For a useful combination of these two extreme qualities, look to the person whose features are straight, curving neither inward nor outward.

Some people, however, are quick to think and slow to act. Others are quick to act and slow to relinquish their endeavor. Then again, some are quick to speak, and slow to act upon what they promise, while others are slow to speak, but follow speech quickly with action. These and other combinations, are all revealed to the discerning in a single glance at the profile.

The profile, for practical purposes, may be divided into four distinct regions. 1. The forehead, embracing that region from the eyes up. 2. The nose. 3. The mouth. 4. The chin.

The shape of the forehead is an index to the rapidity of thought. The shape of the nose is an index to the rapidity of action. The shape of the mouth is an index to the rapidity of speech. And the shape of the chin is an index to the rapidity with which thoughts, actions, and speech are relinquished. It is an index to the general determination and tenacity.

A person's capacity for intelligence is not to be determined by the slope of the forehead, but by the length of the head from the ears forward. The kind of intelligence that a person possesses, though, may so be determined. A receding forehead is not the sign of a small intellect, it is the mark of a person who thinks quickly, and who thinks almost exclusively about practical things. What he wants is results. He cares nothing whatever about theories. He demands action. He may be a scientist or he may be a manual worker, depending upon the length of his head and other things, but he is a "low brow," because he demands that things be demonstrated. He takes no stock in things that have not a practical value here and now. And the more sloping his brow the faster he thinks. He does not bother with meditation and reflection, but draws his conclusions instantly from the evidence at hand and lets it go at that.

The Receding Forehead

—The convex, or receding, forehead is an indication of quick and accurate powers of observation. Such a person sees all that goes on about him, and instantly draws inferences from them. He is keenly interested in how things are done, not from a theoretical standpoint but from a visual advantage. He wishes actually to see all the links in the operation, and just how one process influences the next process. He is not content to be told about these things, he wishes to behold them with his own eyes. And seeing them, he remembers each step and object in its proper relation to other steps and objects. Therefore the best way to interest and convince such a person, is to give him an actual demonstration. If you cannot show him the thing itself, at least

show him numerous pictures; so that he will be able to visualize the proposition as a concrete reality. Better still, if it is something of a nature that can so be examined, permit him to feel it, to smell it, and if it has taste, to taste it. Appeal to his mind through just as many of the physical senses as possible; for he depends upon his physical senses for information rather than upon his reason.

Life offers innumerable opportunities for the slow but careful thinker who can reason and draw conclusions correctly. There are other places—anything from driving a motor through the traffic to a political caucus—where quickness of thought is a better asset than precision. The concave forehead is not suited to quick thinking, and should seek a vocation where correct thinking is better than fast thinking. Where fast thinking is requisite, such is the place for the convex brow.

The convex forehead indicates that the Intellectual thought elements are not pronouncedly associated with the Safety thought elements insofar as they influence the tendency for reflection. In its evolutionary past the soul has met the requirements of environment by a quick perception of relations. This is indicated in the birth chart by lack of pronounced associations between the planets Mercury and Saturn. The Key-Word for the receding forehead is PERCEPTION.

To make a successful impression with such a person, and keep up his interest, it is essential that things are not permitted to drag. He thinks quickly, and his mind passes from one thing to another, and unless kept occupied it will wander to something else.

Give him all the concrete facts possible, but do not argue with him. Show him all there is to be shown. And do it quickly. By the time this has been done he will have drawn his conclusions, and if there is a decision to make he will have made it. Such a person will be little interested in the history of the enterprise, or the romance attached to its development but if you can show him that something is actually being done, and that there are results in sight, he will have confidence in it, and if he can see his way clearly to do so he will make a favorable decision toward it.

The Bulging Forehead

—The person with a bulging forehead represents the opposite, or concave type. His head is built for reflection. Everything he does is duly weighed and every detail thought out far in advance. He depends upon reason to apprise him of things. You may sit in his office and explain the working of a distant plant to him, show him a few maps, tell him the history of the enterprise, just how each process follows another, how, perhaps, something is manufactured, and the various hands it must pass through before it reaches the consumer, and he will be interested and impressed. You do not need to take him to the plant and show him through it, and permit him to handle the product in its various stages of construction. Such would be the proper course with

the convex forehead type. But the concave forehead is a dreamer. He can see it mentally as you describe it He visualizes it in his imagination. Then he thinks things out at leisure. He is not to be hurried. He must be given time to decide, and as many reasons “why and wherefore” as possible. His questions must be answered and his objections met.

The concave forehead indicates that the Safety thought elements have been very strongly organized in association with the Intellectual thought elements. In its evolutionary past the soul has met the requirements of environment not so much by the celerity with which states of consciousness have responded to outside influences, as by the exactness with which the correct response was given. In the birth chart this is indicated by a strong association between the planets Mercury and Saturn. The Key-Word for the bulging forehead is REFLECTION.

The person with the concave forehead is the one that does most of the planning in the world. He is given to thinking of things and carefully working out means of accomplishment. His mental processes are slow and deliberate, but he can handle abstract notions in a way that will enable him to arrive at correct conclusions. These conclusions are sometimes scoffed at by the convex type, because they represent something that has never been attempted before, or represent methods that are different from common usage.

The Straight Forehead

—I have so far been dealing with extreme cases. The majority of foreheads are somewhere between these two extremes. The forehead that is perpendicular from the eyes up—the straight forehead—is just midway between the two extremes. There is not the unusually strong and pronounced association between the Intellectual thought elements and the Safety thought elements in such a person’s astral constitution; nor are Mercury and Saturn so closely linked in his birth chart as to excite comment. The faculties of perception and reflection are just about equally active. As a consequence he sees and then reflects upon what he has seen. His mental processes are neither rapid nor slow. He is to an extent practical, yet also perceives the value of theories and plans. He, therefore, is regarded by his fellows as a level-headed man, one whose judgment may usually be trusted. In all things he keeps away from extremes, and prides himself on being sensible.

He is not so set on getting things done as is the convex forehead, yet practical accomplishment has considerable appeal to him. He is not so desirous of having time for meditation and dreaming as the extreme concave forehead, yet anything that will give him some time for thought, and such theoretical and explanatory matters as are essential to make the situation clear, all have a certain amount of appeal. He is not in too big a hurry to make a decision, yet too much time spent in talking about a proposition seems a waste of time to him. He wants what facts are at hand. He wants to see what is readily seen. He desires also a reasonable amount of explanation. It must then appeal to his "common sense" if he is to make a favorable decision.

Thinking, of course, is man's greatest asset. And because he thinks moderately fast and at the same time organizes his thoughts somewhat carefully as causes and effects, as reasons and results, the person with a straight brow tends to represent the all-around man. He thinks quickly enough so that he does not find it difficult to drive his car through the thickest traffic in the city, yet he thinks slowly and carefully enough that a reasonable plan, even though it has never been tried before, gains his attention, and if it has merit he will become a party to it. He has enough of the convex brow about him that he can understand science, engineering, mathematics, manual arts, surgery, agriculture and the occult sciences; and he has enough of the concave brow about him that he also can understand philosophy, theology, sociology, political economy, history and mysticism. He has not the capacity for specialization that either extreme has, but neither has he their limitations. Perception and Reflection are balanced.

The Nose

—Now let us apply our principle—that the out-curving, or centrifugal, outline is the form indicating speed and that the in-curving, or centripetal, outline is the form indicating slowness—to the nose.

But first let us inquire about the function of the nose. The nose is the organ through which air customarily reaches the lungs. Its size and shape, undoubtedly, have been determined by the requirements of environment. A large nose indicates a copious air supply. A copious air supply, in turn, indicates complete and rapid oxygenation of the blood. Movement depends upon oxygenation of the blood. That is why a person pants when running—speeding up the activity demands an increased supply of oxygen. There must be sufficient draught that the fuel in the human machine may undergo combustion. Large combustion is indicated by a large nose, that is, a nose with large nostrils. Large combustion implies the capacity for much movement and rapid movement.

The air supply furnished through the nose is not dependent upon the length of the nose. A very short nose may furnish quite as much air as a very long one. What, then, is the meaning of a long nose?

It is the function of the nose not only to furnish an air supply, but to regulate its temperature so that it will not unduly chill the tissues of the lungs. In its passage through a very short nose the temperature of the air is little changed. But in passing through a very long nose the air tends to acquire the temperature of the passage through which it flows. In the tropics there is little need to change the temperature of the air before it reaches the lungs. Hence we find the negroid races whose home since time immemorial has been in the tropics, with short flat noses. We find also that the requirements of life in the tropics do not demand long periods of sustained activity. Short periods of activity are followed by periods of rest. A short nose indicates inability for sustained activity.

Peoples whose homes for thousands of years have been in the North have longer noses. The winter atmosphere must be cooled before it reaches the tender tissue of the lungs. And the requirements of life in the North, where there are long periods during which there is no vegetable food and man in the past has been largely dependent on the chase, have been such that sustained effort was essential to survival. A long nose, therefore, indicates a capacity for sustained activity.

It will be seen, now, that as activity is so closely dependent upon the air supply, and that as the amount of air supply may be judged by the nose, that the size and shape of the nose is a gauge to the person's inclination and capacity for activity.

It will also be obvious that a sway-backed nose—one that is concave, or in-curving—no matter how long it is, cannot convey much air to the lungs. It indicates that the nasal passages are narrow and restricted. The air-supply of such a person is deficient. And as a result the person's movements are slowed down. If he has a convex forehead he will think quickly, but will delay about acting. He is slow to act. He tends to procrastinate. If the forehead is concave also, he both thinks slowly and acts slowly. The upturned nose indicates a tendency to deliberation where physical activity is concerned.

If you want a thing done promptly, do not depend upon a person with a sway-backed nose to do it. He may both think fast and talk fast, but in his physical movements he is slow and painstaking. He may be a good workman, but he is not a fast one.

The out-curving nose, on the other hand, indicates copious nasal passages, and an abundant air supply. The Roman nose, the eagle-beaked nose, the Jewish nose, as types are out-curving, and they indicate expedition in movement. The person to get something done quickly is the person with the large out-curving nose. He may think fast, or think slow, according to the shape of his forehead, but he acts immediately he has made up his mind. He either does a thing now as soon as he thinks about it, or he decides not to do it and turns to something else. His mental processes are followed by the execution of his thoughts instantly in action.

The straight nose—the Grecian nose—indicates a compromise between the person who acts swiftly upon the thought, and one who acts very slowly after deciding to do so. Such a person has not the fault of acting first and thinking about it afterward, as does the person with a convex nose when he is also a slow thinker. He is less impulsive. Yet he does not make so many good plans and then fail to carry them out as does the person with the extremely concave nose. His motions are moderately speedy, and he puts his ideas into action with moderate promptness.

Combustion, whether in a stove in the home, underneath the boiler of an engine, in the cylinder of a gasoline motor, or in the tissues of the human body, is a process of oxygenation, and in astrology is ruled by the planet Mars. The nose, then, is a very good index to the prominence of the Aggressive thought-cells in man's constitution and the planet Mars in the birth chart, insofar as they influence rapidity of movement. The nose with large nostrils indicates large combustion, hence physical rapidity. A broad flat nose may also indicate a copious air supply accompanied by physical activity. Usually, however, the large air supply is furnished by an out-curving nose. The large flat nose being short also, even when indicating speed, shows that the speed will be short-lived. The large out-curving long nose indicates both speed and the ability to maintain it. It may well belong to an aggressive and dominant person. The merchant who goes forth from his shop and takes the pedestrian by the arm and persuades him to come in and buy something has a long out-curving hooked nose. The most aggressive business men in the world—those that dominate commerce and industry—have this type of nose.

But the sway-backed nose indicates lack of strongly organized Aggressive thought-cells in the astral body. The planet Mars in the birth chart does not strongly influence physical activity. The straight nose indicates that Mars is moderately strong in the birth chart as associated with physical actions. If the straight nose is short there is an aversion to long periods of physical work. If the straight nose is long, long periods of physical work can be sustained without much fatigue.

The Mouth

—Some people think before they speak, and others speak before they think. Still other people act first and talk about it afterwards if at all, and yet others talk about what they are going to do and then take their time in doing it or fail completely to act. This readiness of speech is determined by the contour of the mouth in relation to the rest of the face.

The mouth may tend to project in relation to the balance of the face, or it may tend to set somewhat inward from what otherwise would be straight facial lines. In considering the mouth contour the lips should be included in the survey. It is the shape of the mouth as a whole insofar as it determines whether it is an out-curving or an in-curving or a straight mouth that we are here trying to decide. We are not now noticing whether the corners of the mouth turn up or down, if it is a cupid bow, a straight line, or crooked outline. To know if a person speaks quickly or slowly relative to his thoughts and actions it is but necessary to observe if the contour of the mouth is out-curving or in-curving.

The out-curving mouth is the quick talker. Whatever passes through his mind he tends to blurt out without thinking very much about how it will affect his audience. People with protruding mouths are incessant talkers and are never at a loss to find innumerable things to talk about. They may, or may not, talk well, and what they talk about may, or may not, be important or interesting; but they talk nevertheless. And it takes little encouragement to start them talking.

The in-curving mouth is a deliberate talker. When called upon to talk he may, or may not, talk well, and what he talks about may, or may not, be important or interesting, but it takes considerable provocation to get him talking, and he talks slowly and likes to think things out before speaking about them. In the extreme type he thinks things out and then never reveals his conclusions except in his actions. If his mouth is in-curving to the extent of appearing to hold in his words, you may be sure he is what is known as closemouthed. A secret that would be revealed by a person with a projecting mouth to the first person met is quite safe for all time with the person with the decidedly in-curving mouth.

In astrology the Intellectual thought elements are governed by the planet Mercury, and this same planet governs speech. When the intellectual thought elements are organized in the astral body through past experiences insofar as they influence speech closely in association with the Safety thought elements ruled by Saturn, we have the in-curving mouth. The less of this Saturn influence as affecting speech, and the more of the Mars influence as affecting speech, the latter being denoted by Mercury being associated with Mars where speech is concerned, the more out-curving does the mouth become. The careful talker has the in-curving mouth. The impulsive talker has the out-curving mouth. But whether the things talked about have value cannot be determined by the mouth, but by the head as indicating the trend and capacity of intelligence. The mouth but indicates one of the several avenues of expression of intelligence, and indicates the readiness with which the thoughts manifest through this avenue.

The Chin

—It is an erroneous impression held by many that a person with a receding chin lacks in aggressive qualities and is slow to resent injury. The person with a receding chin is as quick to fight as the one with the protruding jaw, but he is not likely to fight so long.

A study of the skulls of the cave men of the past shows that their heads were not as long from the ears forward as modern man's, and also that their chins were more receding. As primitive man advanced in intelligence two things were apparent in the proportions of his head. The head from the ears forward became longer, and the jaw became less receding. This does not imply that all men a hundred thousand years ago had heads less developed than modern man. It means that however developed some men of that day were, we have the remains of other men who have since become extinct who were more closely related in structure to the lower animals. And these men, such as the Trinil Man, the Heidelberg Man, the Neanderthal Man, and the Dawn Man, as do the apes, had less in the way of chin development than modern man. No one will say that a gorilla is less aggressive than modern man, or that the ancient extinct men just mentioned were less ferocious than moderns. They did lack, however, one trait that next to intelligence has been of utmost importance to man in his evolution, and that is the ability to follow out a predetermined line of conduct.

To follow out some plan once it is made and not be deterred from it even though it is disagreeable, and even though many interruptions come, and in spite of many incidents that tend to divert the attention elsewhere is the acquisition of highly developed humanity. Such ability is indicated by a concave, or well developed, chin. The Cro-Magnon, another ancient type of man, coming perhaps from Atlantis to rout the cave men and supplant them, not only had a good skull denoting intelligence in high degree, but he had a good chin, signifying that he would not be diverted from his purpose. He had will and determination. He overcame the people with receding or convex chins that lived in Europe before his arrival.

It is usually recognized that a receding chin denotes a weak character. And this is correct. But the weakness does not reside in inability to act with great force—for some of the ancient men mentioned were far superior physically to any living men of today—but in the inability to maintain fixity of purpose. The receding chin indicates changeableness, and if extreme it denotes a fickle person, one who does not know his mind from one day to the next.

On the other hand, the person with a chin that protrudes extremely never knows when to let go either of an idea or of a project. He is consequently lacking in adaptability. When he gets a notion in his mind he holds to that notion, and is quite fixed in it. He becomes lacking in receptivity. It is quite as valuable to know when to give up an old manner of doing something, or to acknowledge a loss and forget it without, if it is a financial matter, throwing good money after bad, as it is to maintain a firm front when necessary.

The strength of the Power thought-cells in the astral body, as influencing Will and Determination, is shown by the chin. If the chin is prominent, or concave, it indicates that the Power thought-cells have a prominent influence in this direction. If the chin is receding, or convex, it indicates that they do not externalize strongly in this direction. Astrologically, the prominent chin indicates that the Sun in the birth chart is powerful as affecting stability and determination, and the receding chin that the Sun has little influence in this direction.

If your adversary has a prominent chin, you may be sure there will be a long struggle. To convince such a person, do not argue with him, but lead him to believe he desired in the first place to do as you suggest. He is inclined to be set in his likes and dislikes, in his opinions, and in his way of doing things. The Key-Word for the prominent chin is DETERMINATION.

The straight chin is a combination, or happy medium, between the two extremes. Such a person has considerable determination, but also yields when it seems advantageous to do so.

The receding chin indicates a trait of unreliability. If you have an important piece of work to have done and there are many obstacles in the way of its accomplishment do not entrust it to a person with a receding chin. For a short time he may put up an excellent struggle, or work very hard, but he soon loses interest and becomes discouraged when confronted with difficulties. It is hard to discourage a person with a prominent chin to a point where he gives up. But the receding chin relinquishes its object and its plans readily. The Key-Word for the receding chin is VACILLATION.

The Jaw

—Now the gorilla, with a receding chin, may be quite as pugnacious as the bull dog with a protruding chin. The gorilla is faster, although he does not hold on so long. So in men also, the amount of pugnacity cannot be determined from an inspection of the chin. But it may be determined by looking at the jaw.

The jaw of the fighter drops well down below the ear, and where it turns forward there is a tendency to form a right angle. He has a strong jaw. It shows width, and angularity, and muscular power.

The person with a narrow jaw, which slopes from the ear forward in a mild rounded curve is not naturally pugnacious. But you can get a quarrel or a fight from the man with a strong square jaw any time you desire it, and on short notice. For fighting quality do not look at the chin, but at the angle of the jaw. The Key-Word for the deep angular jaw is PUGNACITY. The Aggressive thought-cells in the square-jawed person's astral body have in the past been organized through repeated conflicts with antagonists, and this is indicated in the birth chart by the planet Mars exerting a dominant influence over the personality.

Coarse or Refined

—There is still another matter of considerable importance in instantaneous character reading. It is to determine whether a person naturally is coarse and rough, or is sensitive and refined. The coarse rough-textured person does not do well in an environment requiring tact, delicacy, fine appreciation of values and an artistic viewpoint. Also, on the other hand, the refined, sensitive person always has a hard time in rough, uncouth and harsh surroundings.

Sensitiveness and refinement are not merely a matter of education. They are inherent in the character, and manifest in the texture of the body. Sensitiveness and refinement indicates that the Social thought-cells have been prominently organized within the astral body in such a way as to manifest through the character. This signifies that the planet Venus in some manner is closely and strongly influencing the personality in the birth chart.

To judge of the natural tendency toward refinement, first observe the hair. Very fine hair has a silky quality, and usually lies straight. Curly, or wavy hair, is usually coarser. Some very coarse hair, however, like that of the American Indian, is quite straight. This quality of fineness of the hair may best be learned by comparing the texture of different persons' hair. Fine hair is one indication of a refined and sensitive nature. In astrology the hair is ruled by Venus, the planet that also rules refinement.

The planet Venus also rules the skin. Therefore we may look to the texture of the skin as an index to the prominence of Venus and the Social thought-cells as influencing refinement. A soft, close textured, velvety skin is one indication of refinement in character. Coarse hair, and coarse, hard, or thick skin indicate that the Social thought-cells have been but slightly organized to soften the tones of the character, and that there is little appreciation of the finer and more artistic things in life.

Small hands and feet, and delicate, or finely chiseled features are other indications of refinement. Large hands and feet and coarse features indicate strength rather than taste and artistic quality.

Not only is the refined person uncomfortable in a rough or harsh environment, but he will enjoy numerous things that the coarse person will care nothing at all about. Consequently in pleasing or persuading the coarse person quite the opposite method must be used to that employed to gain the attention and interest of the refined person.

The refined person, if an employer, will require the place of work or business to be kept clean, he will require that the employees dress neatly, and that there is an artistic touch whenever possible. The coarse employer will care little about these things. He will care more about the amount of work being done and the immediate financial returns. Further, the fine man expects quality in all he buys, in his own work, and in the work of his employees. The coarse man demands quantity and utility rather than art and quality.

In entertaining the coarse man do not try too much for delicacy of surroundings, or for finer artistic effects. He will not mind if the conversation becomes boisterous, or if jokes are told that are none too elevating. He will like good food, but it does not need to be served delicately. Rich food in abundance pleases him.

But the fine man is repelled by boisterous conduct by unseemly jokes or language, by ugliness of any kind. He enjoys artistic surroundings, likes his food served daintily, even if there is none too much of it, and expects quality to be present in whatever form of entertainment is offered. The coarse man may enjoy the vaudeville, but the fine man will take greater pleasure at the opera.

To interest the fine person, do not offend by loud talking. He likes a soft, well-modulated voice. The more beauty and excellence of quality are emphasized the better, and if it can be done in nice language it will be so much the more effective.

To interest the coarse person, talk vigorously, and to the point. The fine man will understand subtleties and suggestions, but the coarse man needs to be told in plain, straight, forceful language. It is the only kind of persuasion he understands. Too much familiarity may offend the fine man, but the coarse man likes to be slapped on the back and observe heartiness and freedom in the conduct. Slang will not displease him, but is repugnant to the fine man.

To persuade the coarse man, emphasize the elements of popularity, show, utility, volume, and strength. These are the things that appeal to him. He likes contrast in colors, and showiness in his clothes. But the fine man takes to less conspicuous styles and to modest shades of color. The fine man is apt to be touchy and easily offended. The coarse man, although if once offended he will resent it more vigorously, is not apt to get insulted without adequate cause.

The fine man likes praise and flattery quite as much as the coarse man, or even more, but it must be more carefully veiled. Anything crude repels him. But the coarse man may be praised to his face, and in generous terms, without being offended, if this praise is not wholly unwarranted.

It is a mistake for the coarse man to try to handle or work with fine materials, or to be brought into contact with fine people, or to be compelled to live in delicately modeled surroundings. He is ill at ease here. He enjoys cleanliness, but respects utility and homeliness more than beauty. The coarse man likes to deal in coarse, rough materials, he likes to associate with other coarse persons, and he knows how to get along with them. A coarse foreman, by his forceful tactics, is able to handle a crew of coarse workmen, where a finer man would fail utterly. Coarse workmen have a contempt for the refined foreman.

On the other hand, the coarse salesman, by his mannerisms tends to repel the refined purchaser. Refined workmen look upon a coarse foreman with disgust. They feel immensely superior to him. So where the handling or dealing with fine materials are concerned, such as textile fabrics, jewelry, watchmaking, or delicate work of any kind, the fine man should have preference. The tradition of the “bull in the china shop” has direct application here.

Hard, Soft or Elastic

—People are not only fine or coarse, they are also hard or soft or elastic. Of course, broadly speaking the typical hard man is of the bony type, the typical soft man is of the fat type, and the typical elastic man is of the vivacious type. But in addition to the general type it is often worth while to note the quality of the flesh. It will be found that there is also a quality in the character of the individual that corresponds to it.

The person with very hard firm flesh tends to be hard and firm in his thinking and his acting. He is truly a hard-fisted man. He cannot be moved by sympathy, or driven by force. The appeal to which he responds is self-interest and utility. There is little use to talk about the beautiful, or the humanitarian, or of sentiment to the hard man. He believes in justice. He believes in “an eye for an eye, and a tooth for a tooth.” He dislikes discipline, and drives ahead to his objective with little regard for people’s feelings. Show him how he will gain by some transaction and he is at once interested. This is the chief avenue of appeal to him.

The person with very soft flesh needs an appeal of almost the opposite nature to arouse his interest. An appeal to his sense of ease, or to pleasure, interests him. Unlike the hard man, he is easy to convince, but tends to be unconvinced just as readily. He would rather agree with you than take the trouble to argue. He likes luxury and idleness and tends to self-indulgence in all ways. He has not the endurance of the hard man, cannot tolerate hardships, and while sympathetic, his feelings in any direction are short-lived. If you wish a soft person to do something, make it as easy for him as possible.

The person whose flesh is neither very hard nor very soft, but is exceedingly elastic, tends also to have an elastic quality in his character. In appealing to him do not emphasize its utility as you would to the hard man, or to the ease with which it can be done and the luxury which may be expected to follow, but to the love of accomplishment. The driving power of the elastic man is the love of doing something noteworthy. He is very adaptable and progressive and tends to put "pep" into all he does and to communicate this enthusiasm to his associates. The new and the original and the unique interest him. He wants something worth while to do, and liberty of action to get it done in his own way. The elastic man may have many a fall, but is seldom down long at a time. If he fails at one thing, or successfully accomplishes it, he soon takes up something else.

The quality of hardness, softness, or elasticity, is readily noted when shaking hands. If the hand gives the impression of softness and yielding, the flesh in general will be found soft. An extremely hard unyielding hand is the hand of a hard person. And the springy, elastic hand is the hand of the elastic person.

Chapter 7

Serial No. 124
Original Copyright 1940
Elbert Benjamine

Copyright
Church of Light
August 2002

Instantaneous Vocational Analysis

Chapter 7

Instantaneous Vocational Analysis

BEFORE indicating how certain actions betray traits of character, and what points should be noted in determining whether or not an individual is suited for a given vocation, the relative width of the head at one more point warrants consideration. Already, in lesson No. 122, we found that width between the ears denotes an abundance of vital force, and that fullness just above or in front of the ears denotes constructive ability. We found also that the head wide at the temples indicates a person who has good judgment where material values are concerned. The person prominent just above or in front of the ears is a builder. He may build on the intellectual plane, or in a mechanical sense, but he constructs something. The man, on the other hand, who is wide at the temples is neither a producer nor a builder. He is a trader. He devises ways by which, through his services in handling what others produce, he gains an adequate income. But what about the man who is wide or narrow across the forehead?

The Width of the Head Above the Temples

—A forehead may be narrow above the temples, or wide above the temples, whether it be of the convex or of the concave type. When the head is wide here it indicates an exceptional kind of intellectual ability. The thinking may be slow and ponderous if the forehead is of the bulging kind, or it may be quick and brilliant if the forehead is receding, but in either case there is the quality of cold calculating reason that is not influenced to any great extent by the emotions.

This kind of a head has the ability, moving swiftly or slowly, as the case may be, to synthesize facts, to weigh evidence, to form correct and just judgments from the factors submitted. It is the judicial head.

Such a head denotes a mind that may be predominantly perceptive or predominantly reflective, yet there is also a quality of imagination present that enables it to organize its thoughts. The Intellectual thought-cells are strongly associated with the Utopian thought-cells, somewhat associated with the Aggressive thought-cells, and quite dominated as a whole by the Safety thought-cells. But the Safety thought-cells, unless the forehead is bulging, have not the power unduly to slow down the processes

of thought. The power of reflection here shown, is closely allied with both perception and imagination. Mars, Neptune, and particularly Saturn have prominence in the birth chart. Whenever Saturn in a birth chart is unusually prominent you may expect to find that person with a forehead above the temples broad in proportion to the rest of the head. Such a person, consequently, does not pass judgment hurriedly, nor with too great slowness unless the forehead is bulging; but after some deliberation passes an opinion that from the evidence at hand is quite sound. Width of forehead gives what is very uncommon, yet is called “common sense.”

It also is the type of head that can successfully handle mathematical formulas. It has both perceptive and reflective powers well developed, the stronger of these qualities being indicated by the shape of the forehead, whether bulging, straight, or convex.

For intelligence look to the length of the head from the orifice of the ears forward. For judgment, look to the width of the forehead. The judge, under whom legal trials are conducted, should never be a man with a narrow forehead. A man with a narrow forehead may specialize along some line and excel in it, but he has not the brain capacity for the pursuit of knowledge along widely varied lines, nor has he the ability to bring together in proper relations, and carefully weigh the influence of, facts of widely different and numerous kinds. The all-around thinker has a head wide above the temples.

This type of head is the common one among the purely mental type. The mental type, however, are thinkers and not doers. And for accomplishment in various sciences, in engineering of all kinds, and in certain types of manufacturing, in all of which the ability to handle complex mathematical formulas is an essential—work that is performed more often than not by others than the purely mental type—at least a moderate width above the temples is of paramount importance.

Influence of Habitual Thoughts

—So far we have been dealing with those traits of character, organized as thought-cells within the astral body before human birth, that are so deep-seated that in general tendency they are seldom greatly altered throughout life. A person of the fat type may reduce through exercise, yet he is not apt to make such a change in his roundness of contour as to be mistaken for the bony type or for the vivacious type. The Domestic thought-cells are so strongly entrenched in his makeup that they constitute throughout life the dominant factor of his character. Even though a muscular person concludes that study is advantageous, and forces himself to gain a wide knowledge of literature, philosophy, and science, yet he does not thereby become a mental type. His general likes and dislikes, his spontaneous reactions to situations, will be those still of the muscular type.

Neither does a man with a wide low head become a long high-headed individual by any amount of thinking. He may, it is true, on realizing his weakness in a certain direction, cultivate in a superficial way some of the traits of the high-headed man. But it will be at the expense of great effort that he can attain even in moderate degree the power to direct the actions of others that the man high over the ears naturally possesses. Nor do we expect a person with a receding chin to cultivate a protruding chin, or a blue-eyed person by willing it to become a brown-eyed person.

The reason that cultivation will not bring about these changes in type, head-proportion, profile, and complexion is that the mental factors which express through these physical forms have been organized through all the soul's past evolution in countless lower forms of life. They are mapped by the positions of the planets in the birth chart. They are the product of a long period of growth and have great permanency in the character. Human life is too short to make an energetic aggressive traveling salesman out of a sensitive, retiring, stay-at-home type. The cost in energy necessary to bring about this result is too great. Consequently, where fundamental traits of character are concerned, it is much better to find a sphere of life for which the individual is adapted, than it is to try to adapt the individual to some sphere of life dissonant to his natural tendencies.

There are other traits of character, however, of a more transient nature. Even as in astrology the movements of the planets after birth add new energies to the thought-cells mapped by the birth chart, so there are other traits of character which are cultivated, or which are the result of habitual modes of action rather than of deep-seated tendencies. Although the thought-cells in the astral body at birth may predispose an individual to think in a certain way, a variety of factors may combine to cause a certain type of thought to be present or to be absent in his habitual thinking. We may be sure of this though, that any type of thought or emotion recurring day after day will impress itself on the person's appearance and actions.

The person who habitually is cheerful and happy shows it in his countenance. The person who is habitually sad cannot hide this fact from the observer by forcing himself temporarily to be jolly. Happiness and cheerfulness tend to draw the corners of the mouth upward, to expand the chest and keep the shoulders back, to keep the body straight and elastic. Pleasure expands, and this expansiveness is apparent in the elasticity and freedom of the stride, in the poise of the head, in the whole attitude and appearance. Sadness, on the other hand, droops the shoulders, causes the body to sag, the feet to drag, the corners of the mouth to turn down, and the whole body to contract and fold in upon itself.

The Mouth

—The straight mouth indicates a person of firmness and decision. The pouting type of mouth indicates petulance. The cupid's-bow mouth denotes affection. The sneering mouth indicates a person with whom it is difficult to get on well. Sourness, self-pity, discontent, irony, and secretiveness are all disclosed by the mouth. The man who keeps his lips tightly together and slightly drawn back is not one to tell a secret. He knows many things which he does not talk about. And the man who scarcely opens his mouth when he speaks, but talks through his teeth, is just as apt to lack freedom and generosity in other things. The mouth is exceedingly pliable, and any type of thought persistently held will have an effect upon its contour.

The Eyes

—Eyes, also, show the person to be shrewd, deceitful, timid, suspicious, bold, intelligent, mirthful, visionary, curious or desperate. It is difficult to describe how to distinguish these qualities by the eyes, but is not difficult to do through observation. A very good way to determine what a certain expression of the face signifies, or what any characteristic pose indicates, is to assume the expression or pose. Imitate it as closely as possible and then note what thoughts and feelings come into the mind. If the imitation has been accurate, and the mind has been free to grasp the suggestion, the thoughts and feelings spontaneously arising from a gesture, or attitude, or facial expression, will be such thoughts and feelings as when habitually held cause the expression to become a permanent attribute.

The Walk

—A good deal about the character of a person may be learned from his walk. The hurried and worried business man has a hurried and nervous walk. The man who feels very dignified and important walks slowly and with head erect. A swaggering walk denotes a boaster. A strutting walk is the expression of vanity. The shuffling walk is the expression of a shiftless or dispirited character. The mincing walk indicates desire for attention. The affected walk is that of one who craves admiration. The gliding walk is that of the confidence man. The man of firmness and energy has a firm and energetic tread. The pugnacious person walks with chin out and shoulders forward as if to encounter an adversary. The nervous, high-strung man walks with a quick step. The gait of the vacillating individual shows hesitation and little changes in its direction. The step is so characteristic of the individual that we learn to know the foot-falls of our intimates before they reach our door.

The Handshake

—Another index to character that may be noted instantly when meeting a person is the handshake. Of course, the temporary mental attitude of the person also will be indicated in the handshake. Yet the way a person shakes hands with a stranger becomes a good index to the person's reaction to people in general with whom he is not well acquainted, as well as his general attitude toward the person with whom he is shaking hands. The man who grips your hand as in a vise and pains it with his forceful squeezing is a ruthless individual who is hard in his dealings, who uses force in his efforts, and from whom little pity may be expected. The person of opposite extreme, who gives a drooping, lifeless hand, is a negative individual, lacking in stamina, courage and aggression. He has no more feeling and interest than his hand betokens. The hot hand indicates a fiery tempered individual. A cold hand indicates lack of warmth and enthusiasm. A clammy hand indicates lack of sympathy and affection. A warm hand signifies geniality, and a hand of moderate temperature denotes that the emotions are well under the control of reason. The person who shakes hands deliberately, is apt to be deliberate in other things. The impulsive handshake denotes general impulsiveness of conduct. The still, unyielding handshake denotes a conventional and unyielding nature. The warm, firm, elastic handshake in which the hand is not too quickly withdrawn, indicates a friendly nature. Usually the person who holds another's hand too long or in any way exhibits undue affection in his handshake is insincere and striving to make an impression for his own advantage.

The Voice

—In the voice, also, we have another index to the character. The low-pitched voice is that that of the man of action and that of the man of emotions. The high-pitched voice is that of the thinker, or that of the person under nervous tension. Coarse, harsh tones go with coarse, harsh natures. Hard tones and metallic qualities indicate hard qualities and irritability in the character. The complaining voice is high-pitched and has a suggestion of a whine in it. The thin voice of high pitch denotes lack of strength and virility. The loud voice is that of a person of energy which is not well controlled. Softer tones indicate better control. Resonance in the voice is an indication of reserve power.

The Handwriting

—The art of reading character by handwriting is a study of considerable proportions, as is the study of character reading from the hand. It is not my aim here to teach chirography or palmistry, but to indicate character expressions that may be recognized at a glance. The types of hands I have already considered under the five types of people and in the remarks on handshaking. Therefore a few words on handwriting may not be amiss. A person of careless disposition shows carelessness in his handwriting. Neatness and order are shown in the neatness and regularity of the letters. Large letters and generous margins indicate a generous nature, or if very large, one who is extravagant. Unnecessary flourishes to the letters indicate pretense and affectation. Heavy vigorous writing indicates force rather than delicacy. Small neat writing indicates a careful, modest nature. And if the margins of the paper are used to take advantage of all the available space it indicates extreme economy. Rounded letters show love of ease, angular letters indicate aggression and impatience. Mussy looking writing comes from the slovenly person. Every letter on the line and just the right height is the writing of the precise, even-tempered and conservative person. When the lines start large and get smaller toward the end it indicates the person is one who has a tendency to undertake more than can successfully be accomplished. When the letters commence of moderate size and are larger at the end the person is one who more than carries out his plans and obligations. Writing that slants uphill denotes optimism and buoyancy. Writing that slopes downhill indicates pessimism and despondency. When the letters are printed, or some unusual form is followed throughout, it indicates originality and independence tending toward radicalism. When the letters are often unconnected, and some of them run uphill and some down, and their size constantly varies, the writer is undependable and a changeable person.

Vocational Indications

—A little thought on the matter will suggest to the student the general significance of any particular type of writing, what is signified by wearing a particular type of clothing in a particular way, and what is indicated by any habitual gestures. It is but a reasoning from effect back to cause, and then verifying the correctness of the judgment by further observation.

But, after all, the knack of judging character instantly, or more deliberately either, for that matter, is not an end in itself, but a means to an end. That end is to know just what may be expected of a person under any given set of circumstances. It is advantageous to us to realize the motives of those who try to interest and influence us. It is to the advantage of all that when we select a vocation it shall be one in which we can attain greatest success. It is of equal advantage to society that when we employ another we shall employ a person fitted for the work at hand, and that when we work for another we recognize just the kind of service with which our employer will best be satisfied.

There are by far too many persons following vocations for which they are totally unfitted. As a consequence they manage to eke out a meager existence at some employment for which they have neither ability nor liking, when had they but chosen some vocation for which they were better fitted they would be much happier, much more successful, and of much greater value to society.

I know of no system of character reading other than astrology that can point out both the occupation for which there is the most natural ability and the particular department of it where the most harmony and the least discord will be attracted. Let me illustrate: A man may be fitted by natural ability to be a manufacturer. That is, his greatest ability is in connection with the manufacture of something. This can be determined by astrology, and it may be determined also by the methods of instantaneous character reading explained in the present course of lessons. But this man may have thought-cells so organized in his astral body as to cause him to be in great danger whenever he is associated with machinery. Or he may have thought-cells so organized in his astral body that in spite of his great ability as a manufacturer they bring him great and repeated financial loss through unforeseen conditions that crop up in the market or through fires that burn down his factories, or through labor troubles. A man might thus be a great success as a manufacturer, but early lose his life through being associated with such work, or he might be a good manufacturer, but constantly embarrassed financially through heavy losses that could not be foreseen.

Astrology indicates not only where a person's greatest talents lie, but also through associating with just what things, and where, that talent may be exercised to bring the greatest reward and success. The manufacturer who is in constant danger of accident from machinery could be warned of this by studying astrology, and could engage successfully in the manufacture of something where the danger would be very small or none. And the manufacturer who suffers repeated loss through unfortunate circumstances, might have been warned of this by studying astrology, and have made a pronounced success, not in the actual business of manufacturing, perhaps, but, say, in editing a trade journal having to do with such manufacture. Astrology indicates the particular associations that increase the harmony and decrease the discord.

In determining the vocation there are two factors that should be considered. The first factor is to determine in what department of endeavor the greatest ability lies. The second factor is to determine in just what environment, in association with just what things, there will be the most harmony. Association with certain things increases the harmony within the astral body, depending on how the thought-cells in it were organized at birth. Harmony attracts what is called "good luck." Discord attracts what is known as "bad luck."

The natural aptitudes of an individual do not depend upon the harmony or discords of the thought-cells, but upon the Power and volume of energy possessed by the thought-cells within the soul the expression of which is essential to the required activity. And as the power and volume of energy of each of the ten families of thought-cells not only manifests as a type of natural aptitude but also as a type of the physical form, we can employ instantaneous character reading quite successfully in selecting an individual's natural aptitudes. Usually in employing another an employer is more concerned about the character of the person and his ability successfully to accomplish what the work demands than he is about whether, in the long run, the employee will be more lucky in such employment or in some other. And in working for another, it is usually quite sufficient to know just what the employer expects, and just what will please him and lead thus to advancement, without bothering about whether the employer has chosen the most successful line to follow. And for such purposes instantaneous character reading will suffice.

The fact still stands, however, that the so-called LUCK factor is about as important for outstanding success in any vocation as is ability. And I know of no method other than through astrology by which this LUCK factor as influenced by each particular type of environment or each factor of association can be determined.

As a consequence The Brotherhood of Light Astrological Research Department has set itself the task of ascertaining, through analyzing the timed birth charts of 100 persons following each vocation, not only what groups of thought-cells must be unusually powerful to give an aptitude for the vocation, but also what degree of harmony must be present in the organization of certain groups of thought-cells to give sufficient LUCK to enable the individual to succeed in using such natural aptitudes amid the common surroundings of the vocation that he may make a success in it. The aptitudes are shown in the birth chart by the prominent planets, for these map thought-cells with more than average energy. The LUCK which will be attracted through a given association is indicated by the harmony or discord of the planet ruling that which is associated with, and this is indicated by the aspects of the planet thus signified.

At the time this is written The Brotherhood of Light Astrological Research Department has covered in this painstaking and thorough manner 25 different vocations. The detailed analysis of each, including the statistical presentation of the analysis in terms of percentages, is published in the Supplementary Writings on HOW TO SELECT A VOCATION. More vocations are being added to the list of those thus astrologically analyzed as rapidly as we can acquire the 100 timed birth charts of those following any one other vocation.

While these lessons on selecting a vocation through a careful analysis of the birth chart indicate the best possible method of selecting a vocation, in hiring others it is not always feasible to employ the astrological method. Furthermore, the minor qualifications and traits of an individual, such as often are revealed to one familiar with character analysis in one swift glance, require for ascertaining them a consideration of the various aspects in a birth chart, in addition to the prominence of planets and houses which so quickly denotes the individual's broader natural aptitudes.

In reference to these broader natural aptitudes as shown apart from any consideration of a birth chart, I have already pointed them out as associated with certain types of body, types of heads, types of profiles, etc. A little thought will reveal the chief qualifications essential to following a given vocation. These qualifications may be ascertained by a glance at the individual who aspires to follow the vocation. Not only to indicate how the qualifications for the vocations which follow may be ascertained at a glance but also through these examples to indicate the method which may successfully be used relative to the many other vocations which are not here listed I shall devote the balance of this lesson to as many important vocations as available space will permit. And in so doing, in connection with each vocation here listed on which we have completed the analysis of 100 birth charts of those following it, I shall note also the planets and houses which we have found must be prominent and more than usually active in the charts of those who have sufficient natural aptitude for it to be somewhat successful.

The Educator

—The analysis of the birth charts of 100 teachers indicates that they must have the Intellectual thought-cells active, for Mercury is prominent in most of these charts. Also, both the ninth house, which relates to teaching and expression of thought, and the fifth house, which relates to schools and children, nearly always are outstandingly active.

It goes without saying that the educator should be predominantly of the mental type. Yet in our public schools there are far more of the muscular type acting as teachers, and even more of the bony type than of the mental type instructing the children of the land. This accounts for the very low efficiency of our public schools. Of course, to give a sympathetic understanding of human nature that will conduce to imparting

knowledge, a teacher should have a full backhead; be long from the ears back. An instructor in science, and particularly one who does laboratory work, should have a receding forehead. If he is to teach history, philosophy or mathematics the bulging or straight brow is better. To speak readily, and thus give voice to his knowledge, he should be moderately full at the mouth. And if he is to be content as merely an instructor he had better be a brunet. to give him the ability to follow routine, and his head should not be too high above the ears, else he will soon be seeking a more suitable outlet for his ambition. If he is a blond, and rather high above the ears, he will irk at the routine work of acting as instructor, and had better take up lecture work, where he can exercise his personality on the public platform, and find both change and scope for the exercise of whatever creative talent he may possess.

The Doctor

—The analysis of the birth charts of 100 doctors indicates that they must have the Aggressive thought cells and the Religious thought-cells active, for both Mars and Jupiter are prominent in 99% of their charts. This means they should be wide just in front of and above the ears, and high over the temples. In addition, the thought-cells mapped by the sixth and twelfth houses should be more than usually active.

First of all a doctor must be a scientist of no mean skill and have the ability to apply his knowledge practically. This requires that his head should be long from the ears forward, and that his forehead be of the receding type rather than bulging. Then, to get the confidence of his patients, and not undo by his personality and suggestions what he is trying to do with his science, he should be long from the ears back. This gives him sympathy and a knowledge of human nature. The doctor should not be low over the temples, for he needs imagination in the solution of the baffling problems he meets in his profession. Neither should he be too narrow between the ears, as there are constant drains upon his vitality. If he is also to practice surgery he should be wide just above and in front of the ears. He should not be too fine in texture, and while having a good intellect yet not be too strongly of the mental type, otherwise he will be affected too much by the suffering of his patients. The fat type and the vivacious type are not suited to this profession, for there must be strong application to order, system and detail.

The Lawyer

—The analysis of the birth charts of 100 lawyers indicates that they should have the Safety thought-cells, the Intellectual thought-cells, the Individualistic thought-cells and the Religious thought-cells active; for Mercury or Uranus was prominent in 100% of their charts, Saturn was prominent in 99%, Mercury was prominent in 96%, Uranus was prominent in 95%, and Jupiter was prominent in 89%, of them. In addition, the thought-cells mapped by the ninth house should be more than usually active.

The practice of law exercises varied talents. The preparation of briefs requires sustained application, and a mind given to research and the coordination of facts. Such qualities may be expected from the brunet who is long from the ears forward, and who has a slightly receding brow. If the forehead is also wide, so much the better, for he will have the ability to analyze and weigh the evidence at its true value. As a pleader the blond has greater natural aptitude, for he is resourceful and more daring. He is apt to see a point quicker and take better advantage of it than the brunet, but his intellect must be logical and orderly, hence his forehead should be wide above the temples. The man who is high at the temples and long from the ears back and whose mouth is out-curving often has much success in swaying a jury, for his imagination and understanding of human emotions enables him to make an appeal to the sentiments that completely dislodges logic, facts, and argument. Such a man, however, has not the ability to collect the material for argument based solely upon facts. A partnership between a plodder with a head long from the ears forward, even with a bulging forehead, and one who has no knack for facts and logic but who has the gift of oratory, as indicated by height over the temples, long backhead and prominent mouth, often proves a great success.

The Clergyman

—First of all, the clergyman must be idealistic, hence he should be high over the temples. If he is to be able to interpret his ideals intelligently he should have a good intellect, and should both be long from the ears forward and have width of forehead. This width will give him the ability to reason. If his head is too high above the ears he is apt to develop into a bigot, for he will then have no regard for anyone's views but his own. He should also be long from the ears back, to give him sympathy and an understanding of human nature. Otherwise he may be able to reach the intellect of those to whom he talks, but he will not touch their hearts. The mouth should not be in-curving, lest his talk prove laborious. And he should have a prominent chin, so that he will not desert his calling for some other field at the first adverse wind.

The Entertainer

—Dramatic ability is ruled by Neptune. Entertaining of all kinds is ruled by the fifth house. The analysis of the birth charts of 100 moving picture stars indicates that they must have the Aggressive thought-cells, the Individualistic thought-cells, and the Utopian thought-cells active and usually also the Intellectual thought-cells and the Social thought-cells active; for Mars, Uranus, Neptune, and usually Mercury and Venus are prominent in their charts. In addition the thought-cells mapped by the fifth house should be more than usually active.

Those of the vivacious type make the best entertainers. The head need not be long from the ears forward, but should be high above the temples to give imagination and resourcefulness. It should be long from the ears back to give emotional quality and the knowledge of how to reach the emotions of others. This is work for the elastic individual. If there is also width between the ears so much the better, for it will endow a vital force which unconsciously others feel and to which they respond. Of those unsuited to such work the bony type and the mental type are least fit. Blondes do better in those roles that depend on spontaneity and personality, and brunets excel in those that require long periods of application and training.

The Musician

—The analysis of the birth charts of 100 musicians indicates that they must have the Aggressive thought-cells, the Safety thought-cells the Domestic thought-cells, the Utopian thought-cells, and usually also the Social thought-cells active; for Mars, Saturn, Moon, Neptune, and usually Venus are prominent in their charts. In addition the thought-cells mapped by the fifth house should be more than usually active.

The musician, to become successful, requires the ability to apply himself to sustained effort in the matter of practice. Such effort is better suited to the brunet than to the blond. The head should be long from the ears back to supply sympathy and human understanding that may be interpreted in musical terms. The head also should be high over the temples to give imagination and ideals. If the work be vocal the head should be quite wide between the ears, as great vitality is necessary for success in this field. If there is enough of the muscular type present also, the fat type succeeds admirably in the field of music. Being emotional, they love music, and have natural ability in its performance. But they dislike the effort and discomfort of persistent practice. If you will observe almost any large orchestra you will find by far the majority of players to be brunets, and mostly of the muscular or bony type. Perseverance is the keynote to their success.

The Fiction Writer

—The analysis of the birth charts of 100 writers indicates that they must have the Intellectual thought-cells exceptionally active, for in 95% of their charts Mercury was prominent and in 91% of their charts it was in aspect to Sun or Moon. An active third house is helpful. In addition, the thought-cells mapped by the ninth house should be more than usually active.

The fiction writer needs imagination, therefore his head should be high over the temples. He needs sympathy and understanding of human nature, hence his head should be long from the ears back. He needs to be theoretical and visionary rather than practical, hence his forehead may well be of the straight or the concave type. He needs also a wide knowledge of facts and conditions, which requires that the head be long from the ears forward. And he needs logic to weave his incidents together in a plausible manner, and this suggests that a wide forehead is no disadvantage. The brunet is more suited to this kind of work than the blond, for the blond chafes at the confinement and inaction. This is hardly the kind of work for the pure mental type, but it is well to have the mental as the next strongest element.

The Engineer

—The analysis of the birth charts of 100 engineers indicates that they must have the Individualistic thought-cells, the Aggressive thought-cells and the Safety thought-cells active; for Uranus Mars and Saturn were prominent in all.

Engineering requires ability to construct, mathematical ability of a high order, practical considerations as well as those theoretical, ability to command others, and the ability for vigorous and sustained activity. The head should be long from the ears forward and wide above the temples if there is to be the ability to handle intricate mathematical formulas, for such mathematics are the very essence of the engineer's profession. Then, to insure constructive ability, which is equally important, the head should be wide above and in front of the ears. To be able to direct others effectively the head should be high above the ears. The nose should be large, and straight or convex, to enable him to enjoy vigorous sustained physical activity, and the chin should be prominent to give the tenacity and determination to push a venture to a finish in spite of obstacles. The bony type and the muscular type, when the intellect is sufficient, are best suited to this profession. The mechanical engineer need not be a lover of change and movement, and this field is better filled by the brunet. But civil engineering, electrical engineering, structural engineering and mining engineering all require much movement and change and are better suited to the inclinations of blond men.

The Machinist

—The analysis of the birth charts of 100 machinists indicates that they should have the Aggressive thought-cells, the Safety thought-cells, the Individualistic thought-cells, and preferably the Intellectual thought-cells also, prominent; for Mars was prominent in 99%, Saturn was prominent in 98%, Uranus was prominent in 96%, and Mercury was prominent in 95% of their charts.

Working with machinery is employment better suited to the muscular type. The bony type is next best fitted for such vocation, and the third choice is the fat type. The chief requisite is that the head be wide above and in front of the ears to give constructive ability, and that there be skill with the hands.

The Structural Worker

—Much the same qualities are required in the structural worker. He may be an iron-worker, a carpenter, a mason or a plumber. As he deals with practical things, it is better if his forehead is convex. It is work for the muscular type, and the head should be wide above and in front of the ears to give constructive ability. Tedious work, such as plumbing, is better suited to the more plodding brunet. The blond delights in outside work where there is plenty of room for action by which to work off his surplus energy.

The Retail Merchant

—The analysis of the birth charts of 100 store clerks indicates they should have the Safety thought-cells, the Universal Welfare thought-cells, the Religious thought-cells, the Domestic thought-cells and the Intellectual thought-cells active; for Saturn was prominent in 100%, Pluto was prominent in 99%, Jupiter was prominent in 98%, the Moon was prominent in 97%, and Mercury was prominent in 96% of their charts. In addition the thought-cells mapped by the first house and those mapped by the seventh house should be more than usually active.

The type best fitted for retail merchant is the fat type. But if he is to succeed he should be wide at the temples to give him good judgment regarding material values, and he should be long from the ears back to give him knowledge of human nature and the ability to make his customers like him. If he is a blond he will draw trade by his qualities as a “mixer.” If he is a brunet he will keep trade by the quality of service rendered.

The Banker

—The first requisite of a banker is that he should be wide at the temples to give him good judgment as to material values. Next he should be long from the ears forward to give him intellectual capacity, for he must have many facts stored in his mind, and finally he should be fairly broad above the temples to give the power of cold analytical reasoning. If he is to be content with banking and the handling of gilt-edged securities he may be a brunet. But if he is to venture into the realm of speculative finances his chances are better if he is a blond, for the blond has a natural aptitude for taking hazards and coming through unscathed.

The Jeweler

—As the jeweler constructs, he should be wide above and in front of the ears. As he handles fine materials he should be a fine-textured person. His trade requires the use of delicate tools and painstaking effort, all of which is better suited to the brunet than to the blond. The work is of an artistic rather than practical value, which indicates that the forehead should not be receding. Imagination and art must be employed, which would be furnished by height of the head over the temples. Artistic appreciation, constructive power, and detailed manual application are the chief requisites.

The Dentist

—The dentist also needs artistic ability, and should be high over the temples as well as a person of refinement. He must have constructive ability of a high order, hence should be full above and in front of the ears. Further, to be successful he should be a “good mixer” and be able to turn quickly from working on one patient to work on another. This is employment for the vivacious type.

The Agriculturist

—The analysis of the birth charts of 100 farmers indicates that they must have the Safety thought-cells active, and that they should have also active Universal Welfare thought-cells and active Domestic thought-cells; for Saturn was prominent in 100%, Pluto was prominent in 92%, the Moon was prominent in 88%, and either Pluto or the Moon was prominent in 100% of their charts. In addition, the thought-cells mapped by the fourth house should be more than usually active.

Agriculture may be followed to best advantage by the bony type. The brunet takes better to raising crops, not minding the routine and drudgery. The blond likes better to raise cattle, which gives him occasion for wider movement and greater variety of experience, together with an occasional element of excitement. The mental type and the vivacious type should never try to follow agriculture.

The Politician

—The analysis of the birth charts of 100 politicians indicates that they must have the Power thought-cells and the Individualistic thought-cells active, and that it is better for them to have the Intellectual thought-cells and the Religious thought-cells also active; for the Sun was prominent in 100%, Uranus was prominent in 97%, Mercury was prominent in 86%, and Jupiter was prominent in 84% of their charts. In addition, the thought-cells mapped by the tenth house should be more than usually active.

The politician's greatest asset is his ability to influence his fellowman. His head, therefore, should be long from the ears back. And to give him the power to govern others his head should be high over the ears. In addition to this his head should be long enough from the ears forward to give him shrewdness and intelligence. The politician should be long-headed and high-headed. And if he is of the vivacious type, his success becomes so much the greater, for he will make everyone like him. Low-headed plodding brunets are not fitted for political work.

The Traveling Salesman

—The analysis of the birth charts of 100 salesmen indicates that they must have either the Religious thought-cells or the Individualistic thought-cells active, that it is better to have both, and also the Intellectual thought-cells active; for either Jupiter or Uranus was prominent in 100%, Jupiter was prominent in 92%, Uranus was prominent in 89%, and Mercury was prominent in 85% of their charts.

The traveling salesman needs a receding forehead to make him a quick thinker, and he needs a head long from the ears back to enable him to understand human nature and appeal to the emotions and sympathies of others. Blondes take to this work better than brunets, for they are greater lovers of action and change. The vivacious type excels in this field because of his ability as a "mixer." He should have a high head above the temples to give him imagination, for his is an art of persuasion in which it becomes necessary to create an atmosphere. And, because he sells through vocal expression, his mouth should be of the convex type to give him fluency of speech.

The Advertising Man

—Very different qualities must be possessed by the advertising man than by the traveling salesman. Both must have originality and imagination, and so should be high over the temples, but there the similarity ceases. The advertising man must be able to think ahead and plan a campaign in detail. He must visualize human desires and scheme out a way through which by persistent effort and suggestion he can turn those desires to focus upon the thing he is trying to sell. He must be long from the ears forward to give him intelligence, and he must be wide between the temples to give him order and system and the ability to organize his thoughts. Such work is not for the vivacious type, but better suited to the bony type who also has the mental as his second strongest characteristic.

The Aviator

—The analysis of the birth charts of 100 aviators indicates that they must have the Utopian thought-cells, the Aggressive thought-cells and the Individualistic thought-cells active; for Neptune was prominent in 99%, Mars was prominent in 96%, and Uranus was prominent in 94% of their charts. In addition, the thought-cells ruled by the ninth house and those ruled by the third house should be more than usually active.

The aviator should be quick to think and quick to act, therefore he should not have a bulging forehead or a swayback nose. The out-curving face gives quicker adaptability to the changing conditions and emergencies he must meet. While considerable endurance is an asset, such as a bony framework denotes, elasticity such as the texture of the flesh may indicate, is even more valuable. To handle the various gadgets the head should be amply long from the ears forward; but this is not work suited to the extremely mental type. Height over the head is a good indication as it denotes imagination; and imagination is of assistance in handling a craft far from easily recognizable landmarks. For the required mechanical ability the aviator should be amply broad at and above the ears. On account of the initiative required, and the necessity of change, and the meeting of new situations, the blond is better suited to this work than the brunet.

The Cosmetician

—The analysis of the birth charts of 100 cosmeticians indicates that they should have the Aggressive thought-cells, the Social thought-cells, the Domestic thought-cells, the Universal Welfare thought-cells and the Utopian thought-cells active; for Mars was prominent in 99%, Venus was prominent in 93%, the Moon was prominent in 90%, Pluto was prominent in 90%, Neptune was prominent in 88%, and either Neptune or Pluto was prominent in 100% of their charts.

Because this work requires constructive ability, the individual should not be too narrow at and just above the ears. The out-curving mouth often is an asset, as it gives ability to keep the customers entertained with ready conversation. The head should be long from the ears back, for the cosmetician should have sympathy for, and be able to deal readily with, people in general. While the others, except the extreme mental, can follow this occupation, it is particularly suited to those of the vivacious type.—

Book 12-1

Copyright
Church of Light
August 2002

Natural Alchemy Evolution of Life

Chapter 1

Serial No. 125
Original Copyright 1949
Elbert Benjamine

Copyright
August 2002
Church of Light

Origin of the Earth

Chapter 1

Origin of the Earth

BECAUSE it regulates his conduct, it is difficult to conceive anything of greater importance to man than his religion. Even though it be unconscious and ill-defined, every person has a philosophy of life which determines his thoughts and actions in the face of innumerable circumstances by which, from day to day, he is confronted. He is aware of his own existence, and he is aware of the existence of other entities and forces than himself. It is impossible to ignore these other energies and persons and things, for continued existence demands they be recognized and due allowance made for their value as life-supporting or life-destroying factors. Thus each person is constantly called upon to make an adjustment to meet the requirements of contact with this or that entity, person or force. The nature of the adjustment so made depends upon his philosophy of life, conscious or unconscious, and which, although he may be inclined to reject the word may, in its broadest sense, be termed his religion.

Because his conduct is regulated by his philosophy of life, perfect conduct depends upon a perfect religion, and a perfect civilization, depending as it does upon man's conduct, is impossible without a perfect philosophy. Such a perfect religion must define man's proper relation to all other entities in the universe. But we can only formulate a system of relations between man and other men and entities from a knowledge of the man and his functions and a knowledge of other men and entities and their functions. Perfect relationship can only be determined from a complete knowledge of the man and a complete knowledge of other men and other entities. Such complete knowledge of man and such complete knowledge of all other entities and forces in the universe is not at hand. Consequently there can be no such thing as a complete and perfect religion.

Perfection is too much to expect, for this is a progressive existence, and progress demands new adjustments from time to time. We can conceive of no limit to the information it may be possible for man to obtain. New information must be assimilated by any adequate religion, and is thus being assimilated by The Religion of the Stars as fast as it is amply verified. To be adequate, religion must be based upon as complete a knowledge of man and other entities as possible. It must not remain stationary. It must progress even as knowledge progresses.

Such knowledge is not to be obtained by theorizing, nor by building fantasies-much as the human mind is prone to follow this line of minimum resistance- but by painstaking observation of man and other entities, by careful research into the life-histories of men and all other living things, by investigating the psychology of the human mind and that of other creatures, and by extensive research on other than the physical plane. Only upon the most inclusive knowledge of both the inner plane and the outer plane can we hope, at last, to build a theory accurately and truthfully portraying, in so far as present day circumstances will permit, man's proper relation to all.

The theory of human life and conduct so derived, which we call The Religion of the Stars, must be logical inferences based upon as many inner-plane facts and outer-plane facts as it is possible to acquire.

Nature, in her various ramifications is so vast that any one man may personally investigate thoroughly only a small fraction of the whole. Hence, men of science usually specialize and devote their chief endeavor to some single section, or small department, of nature. They attain great skill in research, and gain much precise knowledge concerning the minute region of the universe to which they direct lifelong attention. But because of this they are hardly better fitted to pass judgment on the whole than the man who has made no study. To pass competent judgment about the universe, there must be available for comparison facts, not merely about a single department, but fundamental facts regarding as many departments and sections of nature as possible.

Nor are scientists who specialize in one field competent to pass judgment on the facts in an unrelated field of science. Yet often they are prone to do so. Comments Jan Ehrenwald, M.D., in an article on the Neurobiological Aspects of Telepathy, appearing in the October, 1948, The Journal of the American Society for Psychical Research:

“An increasing amount of experimental evidence of telepathy and related phenomena has been accumulated during the past fifteen years. The problem no longer is to convince the skeptics who, by their stubborn disbelief, prove only their inability to digest food for thinking that had not been included in their diet during their childhood years.”

During the first thirteen of the years mentioned, up to 1947, Duke University Laboratory alone conducted over one-million trials of extra-sensory perception; other university laboratories, following similar methods reported over two million trials, and there were something over a million trials, with responses from over 46,000 subjects made by the Zenith radio program in the winter of 1937-38.

Dr. J. B. Rhine, of Duke University, the instigator of the experiments there conducted, at the commencement of his book, *The Reach of the Mind* (1947) says: “Henceforth I will assume that science will in time accept ESP and PK and that Psi is a normal human capacity, nonphysical in nature.”

No intelligent person who follows the scientific experiments with psi phenomena over the years can fail to be convinced that the soul continues to live beyond the tomb, and that its personality there is in essential respects that which it exhibited while on earth. Nor can any intelligent person who learns to erect and progress a birth-chart fail to be convinced that the inner-plane weather, which consists of astrological energies, has as much or more influence over human life than the physical weather.

Man lives in, and is influenced by, both an outer plane world and an inner-plane world. And there has been a vast amount of observation, carefully checked, which indicates that if we consider man to consist of his physical body, his astral body, his mind or soul, and the thoughts which he thinks, the inner plane environment—which includes objects, the actions and thoughts of intelligent entities, and astrological energies—has as much influence over his thoughts, feelings and behavior as do all outer-plane conditions and energies, including the influence of his associates.

The facts thus far discovered relative to the inner plane, its energies and the way its inhabitants live are set forth in the other 20 Brotherhood of Light courses. In this course a survey of the fundamental facts having to do with the progress and development of life and religion on earth will be made, in so far as it is possible to cover so vast a field in so limited a space. Necessarily this outline must be brief, and because the scope of nature is so limitless, that which is included is as a pebble to a mountain to that which is both interesting and important that must be omitted. Yet if I can sketch even so brief, though clear a picture of the processes that, according to the latest findings of science, have brought the world from its primitive star-dust to where it is inhabited by civilized man, and show the steps by which his religion has reached the present stage, I shall be quite satisfied.

But in addition to explaining the processes by which life on earth has made constant progress, I believe I should also point out the factor which during 1900 years most retarded the acquisition of knowledge of the physical world, and which at the present time is the greatest hindrance to the dissemination of information about the inner world.

The Iron Curtain of Orthodoxy

—Orthodoxy for centuries kept the Western World behind an iron curtain by means of the Inquisition. It no longer resorts to ruthless violence, but it persists in building an iron curtain that effectively prevents most from learning the facts. In their emotionally impressionable childhood people are taught they should make no investigation of religion. They are impressed that instead they should place reliance on blind belief. And to keep them behind this iron curtain of ignorance they are threatened with eternal suffering after earthly life is done.

In 1163, acting in conjunction with the Council of Tours, Pope Alexander III forbade ecclesiastics to study “physics or the laws of the world.” Roger Bacon, over a hundred years later, failed to obey this order. He explained the rainbow and other natural phenomena by scientific methods. In 1278 the Franciscan order condemned his teachings, and later the Pope threw him in prison for 14 years. He was not released until he was 80 years of age.

In 1243 the Dominicans forbade every member of their order to study medicine or natural philosophy, and in 1287 forbade them to study chemistry. In 1380, Charles V of France, at the insistence of religious authorities, forbade any person to possess furnaces and apparatus necessary for chemical processes, and in 1404 Henry IV of England made a similar law, as did Venice in 1418.

Eufame Macalyane, a lady of high position, in 1591 was charged with “seeking the aid of Agnes Sampson for the relief of pain at the time of the birth of her two sons,” and as church authorities held that woman should suffer pain in childbirth, she “was burned alive on the Castle Hill of Edinburgh.”

Later, when James Young Simpson advocated the use of anesthetics in childbirth he was furiously denounced by church authorities and told that what he proposed was “to avoid one part of the primeval curse on woman.”

In England, Scotland and New England as late as the eighteenth century it was considered “flying in the face of providence” to attempt to prevent smallpox. God had sent it in his judgment, and to attempt “to avert it is to provoke Him more.”

The introduction of quinine in Europe was bitterly fought by orthodox Protestants, and it was not used in England until 1653. The natives of South America held coca in great esteem. But the Second Council of Lima, in 1567, condemned its use, and in 1569 a royal decree was issued declaring that “the notions entertained by the natives regarding it are an illusion of the devil.”

In spite of the fast accumulating evidence that the earth is a sphere, Luther, Calvin, Zwingli and Melancton among the Protestants held steadfastly to the Bible dictum that its shape is four-cornered. As to the possibility of people living at the antipodes, the early church held that to be heresy. Said St. Augustine, such teaching was to “give the lie to King David and to St. Paul, and therefore to the Holy Ghost.”

Having set the date of creation, orthodoxy did all in its power to discredit the records of the rocks and the evidence of early man. Fossils to it were the remains of the flood of Noah, and the artifacts of primitive man were those of people living later than 4,000 B.C. There was a great outcry when in 1844 Robert Chambers published his *Vestiges of Creation*, still greater anger when on July 1, 1858, the papers of Charles Darwin and Alfred Russel Wallace were read before the Linnean Society of London, and a tirade of abuse in 1859 when Darwin's *Origin of Species* was first published.

It is not surprising that man in the past had erroneous ideas about himself, about the earth, and about life after physical dissolution. Nor at the present day do we possess all important information on these subjects. It is not to criticize the ignorance of the

past, or that of the present, that these matters are being mentioned. It is to point out how the iron curtain of fear erected by orthodoxy has impeded investigation and has made people afraid to recognize facts which are essential to their present and future well being. And to emphasize that this iron curtain of fear erected by orthodoxy must be lifted if man is to live to best advantage. Raising the iron curtain of orthodoxy has been difficult even where the physical world is concerned. But to raise it where inner-plane facts are concerned, even though this is equally important, is a far harder job.

Relative to the earth itself, Archbishop Ussher of Ireland in 1654 declared from his study of the Scriptures that Creation had taken place in the year 4004 B.C. This was then inserted in the authorized version of the Bible. It became, along with the notions of other church men of previous times, part of the orthodox dogma.

As such it discouraged all research as to the actual age of the earth, and brought denunciation on the head of any person who made such investigation. Yet in 1778 Buffon had the courage to estimate the age of geologic time as 75,000 years. In 1860 Phillips shocked his contemporaries by placing the age of the earth at 60 million years. But by 1900, as the result of studies of time taken by erosion to level mountain chains, build sedimentary rocks, and to cut canyons thousands of feet deep in these rocks, geologists usually accepted 100 million years as the probable age of the earth.

They found that in recent years Niagara Falls had retreated 5 feet a year, wind erosion at certain places in the Gobi Desert was at the rate of 5 feet in 156 years, the bluffs of till along the shore of Cape Cod were receding at the rate of from 1 to 3 feet a year, peat was accumulating in marches at Lynn, Massachusetts, at the rate of 3 to 4 inches in 50 years, the rate of down cutting of the Nile at the Cataracts has been at the rate of 25 feet in 4,500 years, and certain glaciers deepen their cirques 0.57 millimeters a year.

Where periods are not too long, estimates derived from such rates of change are fairly accurate. For shorter periods where each annual layer of sediment remains distinct enough to be counted, as are rings of a cut tree, there is a still more precise measure. For instance, such annual varves of clay representing 20,000 years or more have been counted in many lake beds.

There was no precise measure of the longer periods of time which had elapsed since the rocks of earth were formed until after 1902. That year radium was discovered, initiating the study of simple elements which are subject to spontaneous disintegration. About twenty such atoms are known in nature which expel parts of their nuclei. The process is quite regular, very slow, and the speed of such disintegration cannot be changed by heat, pressure, or any other known external influence. In one year heavy uranium spontaneously loses one atom out of 6,570 million; light uranium (actino-uranium) loses one atom out of 1,030 million, and thorium loses one atom out of 20,000 million.

The atoms thus lost go through various changes some of which require only a fraction of a second and some of which not less than a million years. These changes follow a regular known sequence, and finally become stable nuclei each of which is an isotope of lead. Lead of non-radioactive origin always contains a slight proportion of an isotope with an atomic weight of 204. This never appears in the course of radioactive disintegration. Instead, the isotopes of lead resulting from the disintegration of heavy uranium, light uranium and thorium have atomic weights of 206, 207, and 208. Therefore natural lead in rocks can readily be distinguished from lead due to radioactive disintegration.

If a rock containing ordinary uranium was formed a billion years ago, about 14 per cent of the original uranium atoms will have disintegrated and been replaced by an equal number of atoms of lead. The weight of the lead will be 12 per cent of the original uranium, and the weight of the helium liberated in the disintegration will be 2 per cent. The ratio between the amount of lead and the amount of uranium found in the rock provides a faithful and very sensitive clock for timing the age of the rock.

On the basis of such calculations, uranite deposits at Great Bear Lake are 1,375 million years old, and dykes in the Black Hills at Keystone, So. Dakota, are 1,420 million years old. The oldest dated rocks thus far found are a formation in Carelia, Russia. They are 1,800 million years old. These dated rocks, however, are not the oldest, for they consist of intrusive material thrust through older surrounding rocks which contain no radioactive minerals. It is assumed, therefore, that the oldest rocks are about two billion (2,000,000,000) years old.

As to how old the earth was before it was cool enough for its crust to solidify as rock, science is today in as much of a predicament as it was at the turn of the century in estimating the age of rocks. To replace the nineteenth century Laplacian nebular hypothesis, there has appeared in the present century the tidal friction theory of Jeans and Jefferies, the planetesimal theory of Chamberlin and Moulton, and a still newer theory of Jefferies. The tidal friction theory and the planetesimal theory assume the close approach of two stars, and the newer theory of Jefferies a side swiping collision between them.

In each case one of the stars, or what is left of it after the side swiping collision, passes off in a hyperbolic orbit. The close approach or the collision is supposed to have caused the ejection of material from the star which we call the sun. The planetesimal theory postulates that the ejected material condensed and solidified quickly into small objects known as planetesimals, and that the planets were formed by the gathering together of the small planetesimals about nuclei. The tidal theory and the later one of Jefferies assume the planets were formed by the condensation of large masses of hot diffused material.

On the basis of these theories it has been assumed the earth was in existence about a billion years before it solidified. Thus a geological time clock in the American Museum of Natural History made in 1931 gives the gaseous stage of the earth as 400

million years, at which time, 2,600 million years ago, meteors began to fall. Then followed 600 million years of Azoic time before the earth's crust formed about 2 billion years ago.

However, not only have discrepancies been found in each of these three theories, but the most eminent astronomers in this year of 1949 believe our universe cannot be much more than 2 billion years old. Even as in the opinion of science since the turn of the century the age of the earth has increased, so in its opinion has the age of the universe decreased. Since the commencement of this century Milne demonstrated that the sun cannot have existed more than 5,000 billion years, and Eddington held that it seemed unlikely the age of the stars, systems and galaxies could go back more than 10,000 billion years.

The spiral nebulae, which are galaxies beyond our own galaxy of the Milky Way, are each made up of hundreds of millions of stars. And they all appear to be moving away from us and from each other at speeds that increase in proportion to their distance. If this expansion has been continuous at the indicated rate, not much over 2 billion years ago all of the observable universe must have been concentrated near one point. The theory is that the universe in its present form resulted from atomic explosion within this once compact mass.

The movements of stellar bodies can be observed only through the aid of light. The red shift in the spectrum indicates the movement of these galaxies away from us. One of the problems astronomers hope eventually to solve by means of the 200-inch telescope on Palomar Mountain is whether the red shift is due to some hitherto undiscovered law of nature, or actually indicates the universe is expanding.

In 1940 work was begun on the 4,000-ton atom smashing apparatus at the University of California. Its construction, interrupted by World War II, was resumed in 1945. Then the original design had to be modified to adapt it to the newly-recognized principle of frequency modulation. It had to be modified to make correction for the effect indicated by the Special Theory of Relativity which makes particles increase rapidly in mass as their velocity approaches that of light. And it is possible-as relativity affects not only gravitation, as is also demonstrated by psychokinesis, but distance, as demonstrated by its apparent lack of interference with extra-sensory perception and telepathy, and time, as demonstrated by the ability of extra-sensory perception to perceive events both in the past and the future-that light rays traveling through space for hundreds of millions of years are subject to laws not yet recognized.

Not only is matter converted into atomic energy for many present day uses, but it has been proved that when an electron meets a positron both are annihilated with the release of gamma radiation. And it has been proved that the action of a gamma ray on the electromagnetic field can call an electron and a positron into existence. That is, matter can be created from energy. Although other scientists do not all agree with him, Professor R. A. Millikan, one of the two outstanding authorities on the cosmic

ray, holds that in their primary form they are a result of the synthesis of certain types of atom in outer space and that they represent the “mass defect” energy of these atoms.

At least we now know, due to progress in photography, that interstellar space, two decades ago believed to be empty, contains a tremendous amount of microscopic matter. Jan Oort, in 1948 president of the International Astronomical Union, calculates that the interstellar gas and dust contains as much matter as all the stars. In the Milky Way, only a minute segment of the observed universe, this comes to 300 million million times the mass of the earth. Hydrogen and helium are prevalent, and some think these two gases are the building blocks from which by nuclear synthesis many of the other elements were made.

The most plausible theory of today (1949) is that our solar system once consisted of a vast dust cloud which began to condense under gravity. As the Milky Way itself rotates, dust clouds within this area would also rotate. According to the law of conservation of angular momentum, as it shrunk in size it would rotate more rapidly. With resistance diminishing and gravity increasing the cloud would collapse faster and faster, its final collapse to a size equal to that of the solar system requiring only a few hundred years. Due to increased pressure the temperature would rise tremendously, and in its final white-hot phase the sun would become hot enough to start the nuclear reactions among carbon, hydrogen and helium which some believe is the source of its continued heat.

It is held that some of the revolving cloud condensed into minor clouds and in the final collapse of the sun these were left stranded to become planets. A number of known laws, including that of the pressure of light from the sun, are called in to account for their behavior and that of their satellites. According to this theory, neither the earth nor the universe need to have been in existence over about 2 billion years, and thus its materials could have resulted from an atomic explosion of a central mass not much longer than that ago.

The Part Played by Psychokinesis

—The evolution of life, as will be made plain in subsequent lessons, is from the simple toward the more complex. But inorganic evolution, in obedience to the Carnot-Clausius law, moves successively from the more complex to the simple. According to this law every successive inorganic state entails a definitive decrease in its available energy. Unless it is able to borrow energy from some other system—such as the astral plane—the material universe is running down and in time will reach a state of inert symmetry.

From whence came these molecules, atoms, protons, neutrons, positrons, electrons, mesons, photons and possibly neutrinos of the inorganic world which are now running down? And from whence came life which is now evolving from the simple to

the complex? Lecomte du Nouy in 1947 showed by probability calculations the inconsistency of believing the appearance of the first living cell to be due to a chance combination of inorganic molecules.

Psychical researchers have found that whenever physical conditions were present that would permit the manifestation of intelligence, that intelligence always was present there to manifest itself. In other words, there is an inner plane, nonphysical in nature, and not subject to physical laws, where intelligence of incalculable grades at all time persists. It is on this plane that the unconscious mind or soul of man exists while it functions through his physical body, and it is on this plane that it will continue to function and develop after the dissolution of the physical vehicle.

There is no evidence of the existence of a God who has human frailties, a God who unjustly can be persuaded to favor some special nation, Who punishes those who strictly follow religious doctrines in which they believe, but which do not conform to those of some other creed, and Who can be cajoled or bribed into granting special, and quite unjust favors to those who give Him praise and beseech Him in prayer.

But that there is an all-pervading Super-Intelligence which can be contacted there is much ESP evidence to prove. But not a God of whim and cruelty, such as would condemn to eternal suffering those who had no opportunity to embrace, or whose early conditioning in belief determined by environment over which they had no control caused them to reject, some special faith.

If, as has been amply demonstrated in university laboratories, the mind can manipulate physical objects, and if, as psychical researchers have demonstrated, mind on the inner plane with various grades of intelligence is at all times present, there seems good reason to conclude that the trend of evolution is in response to the psychokinetic power of images within the mind of the all-pervading inner-plane Super-Intelligence.

Under the jurisdiction of the overall Super-Intelligence, lesser intelligences on the inner plane perform their psychokinetic functions. According to the old Hermetic teaching, substance, motion and intelligence are inseparable and eternal. According to this teaching the positron and the electron which can be manufactured from the energy of an electromagnetic field are merely the high-velocity astral substance of the inner plane which has been slowed down through polarity.

Lecomte du Nouy in his book *Human Destiny*, has pointed to the fact that material science has utterly failed to account for life even in its most elementary form. To account for it, and to account for its evolution, the existence of an inner plane where mind resides and exerts a formative pressure on the lower-velocity physical substance must be recognized.

The Material Universe

—After studies with the 200-inch telescope on Palomar Mountain, which start this year, have been completed, there will be much revision of present views about the universe. This glass will reach twice as far into space as the 100-inch telescope on Mt. Wilson, which is the largest used previous to this year.

According to calculations made from observation with it and smaller telescopes our sidereal universe, or galactic system embraced within the Milky Way, is in the shape of a lens between 200,000 and 300,000 light-years in maximum diameter and about one-tenth of this in thickness. It is estimated to contain about 100 billion stars.

Within this main galactic system in the vicinity of the sun is a local system which also is somewhat lens shaped, having a maximum diameter of about 20,000 light-years. The sun is about 275 light-years from the center of this local system, which inclines to the plane of the main system at an angle of about 12 degrees. The local galaxy is about 65,000 light years from the center of the main galactic system. In this main galactic system there appears to be a central condensation of material in the general direction of the constellation Sagittarius.

Beyond our sidereal universe are between 50 million and 100 million extra-galactic nebulae within the one billion light-year observational scope of the 100-inch telescope. These are of three types: spirals, elliptical and irregular. About 77% are spirals, 20% elliptical and 3% irregular. It has been proved that these extra-galactic nebulae are immense groups of stars. It is believed by many that viewed from the outside our sidereal universe, or Milky Way, which appears to be rotating, would appear as a huge spiral nebula, such as the spiral nebula in Andromeda appears to us. If this is the case, although other spiral nebulae are tremendously large, that of Andromeda, measuring 28,000 light-years (light travels 186,284 miles per second according to measurements in 1942) in greatest length, our Milky Way is the largest of any of the galactic systems thus far measured.

The Stars: The stars which are found both in the extra-galactic systems and in our own galactic system, are undergoing a process of evolution. Further advances in nuclear physics will shed light on the changes they undergo. In their early stage they are supposed to be of the type known as Red Giants, and in their last visible stage they are supposed to be of the type known as Red Dwarfs which, while so much smaller, have approximately the same mass as the red giants. The largest red giant thus far measured is the star in the constellation Scorpio known as Antares. Measured with the stellar interferometer it shows a diameter of 390 million miles. As the earth is only 92,897,000 miles mean distance from the sun, and Mars is only 141,500,000 miles mean distance from the sun, if Antares were to occupy the place of the sun, both earth and Mars would be far interior to its surface.

The giants are largely composed of diffused gas at low temperature. As they contract they are supposed to get hotter and hotter until they reach the blue-white stage, when they start cooling off. Like an iron in a furnace they first become red, then orange, then yellow, then yellow-white, then white and finally blue-white. To conform to the 2 billion year expanding universe theory they reach the blue-white stage quickly, from then on cooling gradually. Thus the red giant Antares, 480 times the diameter of the sun, has a density of only 0.000,000,3, and a temperature of only 3,100 degrees. But the orange giant Capella in the constellation Auriga, with a diameter only 12 times that of the sun, has a density of 0.002 and a temperature of 5,500 degrees, and the blue-white B Centauri, with a diameter 11 times that of the sun, seems to have reached the maximum temperature before it starts to cool. Its density is 0.02 and its temperature is 21,000 degrees.

After a star reaches the blue-white stage witnessed in B Centauri it begins to radiate heat faster than its continued condensation generates it. From then on radiation pressure acts against gravitational contraction and tends to hold the mass in approximate equilibrium and permits it to cool slowly. Growing smaller and smaller it passes in reverse order through the colors white, yellow-white, yellow, orange and red. Finally it becomes black and invisible. There are supposed to be many more black stars in our universe than those that emit light.

Sirius, in the constellation Canis Major, with a diameter 1.8 times that of the sun, has cooled to the white stage with a density of 0.4 and a temperature of 11,200 degrees. Our sun, an orange dwarf star similar in color to the orange giant Capella, has a temperature of 6,000 degrees, only 500 degrees higher than Capella, but has a density of 1.4, which is tremendously greater.

Antares has a luminosity 3,500 times that of the sun, Capella 150 times that of the sun, Sirius 26 times that of the sun, and Krueger 60A has a luminosity only 0.002 that of the sun. Our sun is well past its prime, for it is an orange dwarf. But it has a long way to go before it becomes one of the countless dead suns that clutter up the universe; even a long way to go before reaching the red dwarf stage of Kreuger 60A which, with a diameter of 0.3 that of the sun has a temperature of only 3,300 degrees, but a density of 9.

White Dwarfs: More than 99% of the observed stars fit into the evolutionary sequence of stars just set forth. But there are a few that do not fit into this general scheme. Because they are so small and faint they are difficult to locate. With the progress of nuclear physics more about their origin will be learned. The present theory is that they consist of atomic nuclei stripped of all external electrons and tightly packed together by gravitational compression. The first of these white dwarfs to be discovered was the companion star to Sirius. Its mass is about that of the sun, but although hotter than the sun, its luminosity is only about 1/360 as great. This means that about the same mass of material found in the sun with a mean diameter of 864,000 miles is compressed into the 30,000-mile diameter of the white dwarf. Its density, 30,000 times that of water compared with the earth's 5.58 times that of water, is such that a cubic foot of its material weighs 935 tons.

Multiple Stars: Not all the stars are single as is our sun. In many instances two stars form a system and revolve in elliptical orbits around their own common center of gravity. Sirius, the brightest star in the sky, is such a binary, its companion being the white dwarf just mentioned. Then there are triple stars, in which three stars form a system; and Theta Orionis, the star in the nebula in the sword of Orion, is composed of six stars. One multiple, as they are called, has been discovered that is really composed of a closely related system of 16 different stars. Such systems of more than one star often have one or more members of the family that are dark stars whose presence may be known only by their passing between us and some of the others.

Variable Stars: Any star whose light is known to fluctuate is called a variable star. At the present time 10,000 such variables are known, and it is estimated that not less than 5% of all stars are at least somewhat variable. One type, known as the Algol type because the star Algol behaves in this manner, shows a rapid diminution of its light at regular intervals. It is believed such stars have a dark companion, or one of less luminosity-and this has been definitely proved in the case of Algol-and as the two revolve the darker of the two periodically eclipses the brighter.

But there is another type of variable star whose irregular fluctuations cannot be explained in this manner. Some think they are dying suns, and that as a crust of thick vapor forms on the surface their light is shut off. Then, at irregular intervals, the molten interior bursts through and they again appear very brilliant. Others believe that they are suns traveling in a region rich in dark nebulae, and that when they enter successive clouds of dust or strike swarms of meteors the friction of the impact is the source of the added illumination.

Novae: Not only are there supposed to be many more dead and dark suns-suns that have cooled below the light-emitting stage-wandering about the heavens than there are luminous ones, but many new suns apparently are observed to be born. These are called novae. Many are detected each year, and it is estimated that ten or more reach a brightness of the ninth stellar magnitude or more annually. Photographic records indicate, however, that novae are not actually new stars, but are faint stars which for some reason suddenly increase in intensity. It is not uncommon for them to gain an increase of ten magnitudes, which means an increase of light intensity of 10,000 times.

At present no complete explanation is available, but with further advances in nuclear physics such an explanation may be forthcoming. The most commonly accepted present theory is that some faint star explodes and blows off its outer shell of gaseous material. This may be due to the release of atomic energy. As the shell would rapidly expand after leaving the star the displacement of spectral lines would be toward the violet, which is observed. Nor are these novae, whose brightness lasts only a short time and then rapidly fades confined to our sidereal universe, for they have also been observed in some of the extra-galactic systems such as the great spiral of Andromeda.

Star Clusters: Stars which move through space together in parallel paths are known as moving clusters. Many such moving clusters are known. The sun apparently is not a member of such a moving cluster, but at present is within the Ursa Major cluster, which has a diameter of 500 light-years, with its members moving past us on both sides.

Out on the far fringe of our galaxy are the globular star clusters. Sixty-nine of these are known, each consisting of an immense number of suns closely grouped, comparatively speaking, in a globular system of stars. Shapley, of Harvard Observatory, finds that these clusters themselves, taken as a whole, form a huge flattened cluster, probably 250,000 light-years in diameter, with its center about 75,000 light-years from the sun in the direction of the constellation Sagittarius. Sagittarius seems to be the bull's-eye center of both the globular clusters and of our sidereal universe.

Magellanic Clouds: Also on the fringe of our galactic system toward the south pole of the celestial sphere appear two luminous roughly circular objects. They are called Magellanic Clouds. Occupying areas singularly devoid of bright stars, the larger covers a space of 42 square degrees and the smaller covers 10 square degrees. They appear as a promiscuous intermingling of star-clouds, star-clusters, and gaseous nebulae. Little is known at present concerning them.

Galactic Nebulae: The nebulae within our sidereal universe, or Milky Way, are of three different types: dark nebulae, diffuse nebulae, and planetary nebulae. Several hundred dark nebulae composed of immense dust clouds and possibly other dark material have been photographed. They range in size from small spots up to the great black rift which can be seen with the naked eye that extends almost a third of the way around the Milky Way from Cygnus to Centaurus.

The diffuse nebulae have no more specific shape than the dark nebulae and appear much like clouds of vapor. Their density is very low, and apparently they differ from the dark nebulae only in being luminous through usually being associated with a star which illuminates them.

Planetary nebulae are so called because they have much the same appearance in a telescope as a planet. In most instances they have a star of the hot blue spectral class at their center which is associated with their radiation. These nebulae are rotating and are probably composed of ellipsoidal masses of gas.

Asteroids: According to Bode's Law there should be a planet between Mars and Jupiter in our solar system. But instead, in this orbit travel swarms of smaller bodies, perhaps 150 having a diameter greater than 50 miles and the majority having a diameter between 50 and 20 miles or less. The most widely accepted theory is that there was once a planet there, but that it broke up due to atomic explosion or to collision with another heavenly body.

Comets: Comets are the largest members of our solar system, but their mass is very small. A definite connection has been established between comets and meteors. A comet was observed to disintegrate and a meteor shower took its place. Often as a comet approaches the sun the pressure of the light from the sun causes fine vapor-like material to stream out in a direction away from the sun. The earth passed through the tail of a comet twice during the last century and nothing was felt. The head of a comet, however, consisting of a swarm of iron meteors is more formidable. Not long ago such a meteor flattened a big forest in northern Siberia, and Meteor Crater, near Canyon Diablo, in northern Arizona is supposed to have been formed by a monster siderite meteor of some 500 feet in diameter, that was one of a flock that formed the nucleus of a large comet that struck the earth not more than 5,000 years ago.

Meteors: In addition to the wholly metallic siderites, there are sideriolites composed of both metallic and silicate materials, and aerolites composed almost entirely of silicates. Recent calculations and observations indicate that about half the meteors are visitors from interstellar space, having their origin outside our solar system.

Zodiacal Light: This light is seen in the west after evening twilight in the spring and in the east before morning twilight in the autumn. It is a pearly radiance that, cone shaped, slants up from the sunset glory, or from before sunrise, sometimes almost to the meridian, but always following the zodiac, or path of the sun. In the northern hemisphere, therefore, it leans to the south. It is due to sunlight reflected from cosmic dust.

Aurora Borealis: This phenomena commonly seen in high latitudes is an electrical discharge in the ionized air exhibiting the characteristic spectrum lines of the rarer atmospheric gases. Sunspot maxima, with their eleven-year cycle, are always accompanied by maxima brightness and frequency of these Northern Lights which are always coincident with disturbances of terrestrial magnetism. At other times they are most commonly seen in March and October.

The Moon: Some scientists believe the Moon was formed at the same time and in the same manner as the earth. Others hold that after its formation tidal strain caused the earth to bulge until the Moon broke off, and the back-reaction of the lunar tides caused the Moon gradually to recede, and the solar and lunar tides, acting like a brake-shoe against the earth's rotation, caused the earth to slow down. The rate of slowing down, according to the records of eclipses preserved by the ancients, indicates that at present the day is lengthening about 1/1000 second per century, or a minute in 6 million years. This might mean the Moon broke off 10 billion years ago, or if all possible allowances be made for greater tidal retardation when the Moon was closer, the date cannot be less than one billion years ago.

Chapter 2

Serial No. 126
Original Copyright 1949
Elbert Benjamine

Copyright
August 2002
Church of Light

Origin and Development of Plants

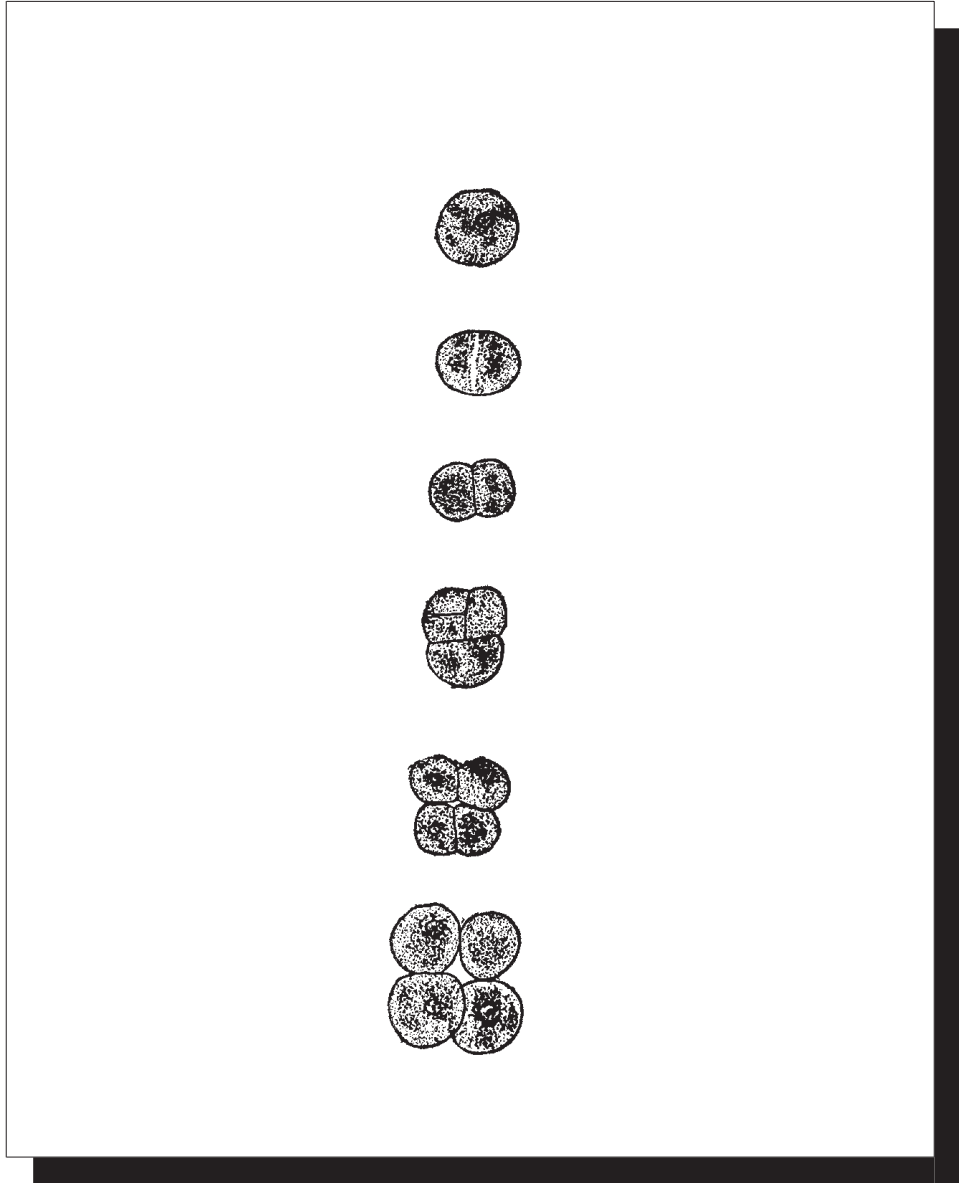

Diagram showing multiplication by cell division of single celled green algae.

Chapter 2

Origin and Development of Plants

IT is believed that after the moon broke away from the still hot earth it had a diameter of about 8,100 miles. Since that time it has shrunk in size, partly due to loss of heat, but to a still greater extent due to an internal rearrangement of its molecular structure, until its present diameter is but 7,918 miles. During the cooling the viscous material slowly continued to boil, and as a crust would form, hotter material from the interior would break through and the heavier portions of the crust would sink toward the center.

The fact that solid rock does not float on molten rock like ice on water, but tends to sink, is but one argument against the old notion that there is a crust at the present day supported by a molten interior. Undoubtedly the heavier materials would sink to the center of the earth. It has even been suggested that, as gold is one of the heaviest metals, the earth has a core of almost solid gold. This, however, is mere speculation. But from what is known of the weight and density of the earth, and of other celestial bodies like meteors, it is not improbable that the earth has a core some 4,000 miles in diameter mostly composed of iron. Other metalliferous and basic rocks, due to their relative weight, would lie above this iron core, while the acid rocks, chiefly granites, being much lighter, would rise to the top of the molten metal.

It is now quite well established that the continents are built of much lighter material than the ocean beds, the ocean bottom being of basaltic rock some 3% heavier than the granitic rocks forming the continents. Some now think that the region of the Pacific Ocean is where the moon broke off from the earth, the opposite section of the earth being where the tidal bulge was simultaneously formed on the other side of the earth. This then became the region where the granite frosting floating on the plastic and heavier basalt beneath, like the frosting on a custard pie, was left after the moon broke out from close to the surface on the other side.

Professor Wegener advances a theory that is finding considerable acceptance, that the continents were anciently much nearer together than at present. Nearly all geologists now believe that underlying the crust of the earth, say some 60 miles below sea level, there exists between the more metallic interior and the outer cover a rather thin layer of basaltic rock. It is also known, because the process has been duplicated in the laboratory, that under the pressure and heat known to exist in the

flowage zone—below about 60 miles depth—that the rock flows like ice in a glacier, through recrystallization. While still as rigid as steel, it nevertheless flows under pressure without breaking, just as a piece of hard pitch or asphalt may be made to assume any form without breaking by subjecting it to gradual pressure. Yet the same pitch or asphalt or the same rock, if subjected to quick strain, will break like glass.

Professor Wegener believes that South America, Antarctica, Australia and India were once much closer to South Africa than at present. In fact, they seem to fit to South Africa when their shore lines are brought together. And in like manner North America seems to fit Europe. This proximity of the Old World and the New does not fail to take into account Atlantis, for its existence is well established. Certain it is, from the similarity of their flora and fauna, that the continents were connected by land at no very distant date, geologically speaking. Professor Wegener believes that these blocks of granite frosting, floating on the viscous basalt beneath, broke apart in the Tertiary Epoch, and that America drifted westward away from the Old World. Such westward floating might naturally arise from the eastward rotation of the earth on its axis, and from other known forces.

Greenland at the present time is moving away from Europe at the rate of 50 feet a year. The American continents in their westward movement are supposed to have buckled up the crust toward the west, due to the resistance offered the advancing continental edges. This gave rise to the great mountain chains of the Rocky Mountains and the Andes. Along the western, or advancing, edge of the continents there would be a tendency to many minor adjustments of the floating crust. To the east of the Old Continent, however, there would be no pushing, but the eastern edge would drop off abruptly where it juts onto the heavier basaltic ocean floor. And in reality Japan and the Philippine Islands rest on the brink of a precipice, the deepest portions of the ocean adjoining them. On the edge of such a precipice we might expect sections to slide off, or other adjustments to take place frequently. Such disturbances undoubtedly give rise to the numerous earthquakes in the region mentioned.

Professor John F. Hayford of Northwestern University and Dr. Wm. Bowie, Chief of the Division of Geodesy in the U. S. Coast and Geodetic Survey, have worked out certain facts that help us understand the cause of the rise and fall and buckling of the earth's crust. They have shown that were the earth's crust cut into blocks 100 miles square and 60 miles below sea level, the various blocks would weigh the same, irrespective of the fact that some containing mountains would have larger volume. They have proved this both by astronomical and by geodetic calculations, and explain that unless such an equilibrium exists the Rocky Mountains would doubtless break down the terrestrial shell. They also point out that the lightening of a block as much as 3% would be sufficient to elevate the mass 9,000 feet. And as above explained, the lighter materials are close to the surface; for a weight of a cubic foot of earth at the surface is but $2\frac{1}{2}$ times that of water, while the weight of the entire globe is $5\frac{1}{2}$ times that of water.

With a few exceptions, such as the Alabama Hills in Inyo county, California, practically every portion of the globe at one time or another and usually numerous times, has been at the bottom of the sea. The silt and sand then deposited and later compressed into shales and sandstones, or other sedimentary rock may, after the region has become dry and lifted into a mountain chain, have been removed by erosion, leaving bare the granite mountain core. But land areas in general periodically rise as mountains, to be worn down by erosion and again form sea bottoms. This is due, not only to the possible westward drift of continents shoving up regions toward the front of their movements, and to the shrinkage of the earth causing the crust to become too large and thus wrinkle like the skin of a drying apple, but also to the constant shifting of weight of the land areas.

According to the ideas of Hayford and Bowie, above mentioned, as the mountains are worn down by erosion and carried into the sea, there is an increase of weight in the region where the material of erosion is deposited and a decrease of weight in the region from which it was removed. Now if the load on a raft is moved to one side, that side of the raft sinks and elevates the other side of the raft. Land areas are rafts of rock floating on a plastic ocean of basalt. But there is this difference between them and ordinary rafts, in that the region pushed down below some 60 miles depth becomes part of the flowage zone, melts off the bottom of the raft and moves to some region of lesser weight, there to push up some other section of the earth. According to the U. S. Geological Survey there is delivered into the seas and oceans from the United States alone 783 million tons of rock materials every year.

It will be seen that as the present mountains are due mostly to a shrinkage of some 200 miles in the diameter of the earth, that before such shrinkage there were probably no mountains. This is borne out by much evidence, and there is no doubt as time passes and new mountain ranges are formed that the new ones are larger than those of an earlier date. Throughout geologic time lands have gone down as well as up, but the sum of their movements have been upward, and the sea areas have gone up as well as down, but the sum of their movement has been downward. The land is gradually getting higher and the sea is gradually getting deeper.

At the commencement of geologic time it is thought our earth had an atmosphere similar to the present one except that there was very little oxygen in it. Although the oxidation of the rocks has consumed some oxygen, the influence of plant life has steadily been to increase the oxygen content of the atmosphere and make it more suitable for animal life. It has done this by utilizing the carbon and freeing the oxygen of the carbon dioxide gas in the earth's gaseous envelope.

This carbon dioxide gas is constantly replenished by volcanic activity. Volcanoes which are now thought to be due to local regions beneath the earth's crust becoming overheated through the activity of radioactive minerals, are not unmitigated evils as they are generally regarded. Instead of being vents through which the molten interior of the earth flows, they are vents for molten pockets of rock that have become intensely heated by radioactive minerals in particular regions. And they contribute carbon to the atmosphere. Carbon is one of the three fundamental materials at the

basis of life, and were there double the life on earth that there is at the present time, all life would cease; for all the carbon in the atmosphere would be in the bodies of plants and animals, and death would overtake all. Furthermore, should volcanic activity cease it would not be long before the existence of life would be impossible because of lack of carbon.

The water also, so the newer geology teaches, came out of the earth as the earth cooled, through volcanic activity and warm springs. Much of it was added, there is good reason to believe, in later geologic time. Thus the waters of the ocean tend to encroach upon the land, even while the water falling from the sky wears down the mountains and carries them out to sea.

Two mountain ranges in North America, bigger than the Rockies, were lifted up and then worn down by such agencies before the present mountain ranges were lifted up. Sand and clay and mud are all the products of rock worn down by frost and wind and rain and glaciers. From the depth and size of such sedimentation can be calculated with much accuracy the size of the mountains required in their formation. The water constantly tends to wear down and deposit land areas in the sea, and Sir Archibald Geikie calculates that if the continents were thus deposited in the sea the sea level would be raised 650 feet, and if North America remained stationary half of it would be covered by the sea to a depth of several hundred feet.

Small warpings of the earth's crust are going on all the time, due to the shifting of the weight of areas through sedimentation. Such warpings usually elevate local regions only a few hundred feet. Erosion continues on a continent until the land area is but a little above sea level—a condition which has prevailed during most of geologic time—and then, largely due to astrological tensions, the crust yields to the strain of shifted weight and slowly, near the margins of the continents, folds and breaks in the formation of ranges of mountains from 1,000 to 1,500 miles long. These are called Minor Crustal Adjustments, and at least eight are known to have occurred in North America.

At still greater intervals—also largely determined by astrological conditions—there is a more complete adjustment of the land areas the world over. As the result huge mountain ranges are formed and the continents are elevated to a much greater height above ocean level. These are called Major Readjustments, and at least six are known to have occurred during geologic time.

The elevation of such masses of land has a decided effect upon the climate. New land areas change ocean currents, new mountain ranges change air currents, and even as now it is cold on a mountain top, so excessive elevation of land areas causes the climate to become so cold that the snow does not melt as fast as it falls. The mountains first become covered with glaciers, and these lowering the temperature of surrounding territory tend to spread the glaciers until a continent may be covered with an ice sheet from the north down to a latitude where melting takes place faster than the snow falls. Geologists know of several such periods in the past—each following a very long time of warm climatic conditions—when there were decided

coolings of the climate, at least four of these periods being glacial.

A moment's reflection will reveal what a terrific effect such a change has upon life that has been living in a warm climate. A glacial winter lasting thousands of years causes the seas to deepen yet decreases their area, causing swift running torrents to flow where there was only sluggish water before, shutting off moist winds from the interior and turning that interior into desert, and in a dozen other ways upsets the conditions to which life has long become accustomed.

Origin of Physical Life

—So far as known, at the present time all living things come from previously existing living things through some method of reproduction. In obedience to the second law of thermodynamics (the Carnot-Clausius law) inorganic evolution moves from the more complex to the simple. But life in its evolution follows the opposite course, and moves from the simple toward the more complex. Whether it had its origin here, or was carried to the earth from some remote sphere as a spore or seed embedded in a meteoritic fragment, material science has been quite unable to account for its beginning. Lecomte du Nouy in 1947 showed by probability calculations the inconsistency of believing the appearance of the first living cell to be due to a chance combination of inorganic molecules.

Psychical researchers have found, however, that whenever physical conditions were present that would permit the manifestation of intelligence, intelligence was always present there to manifest itself. Thus has it now been demonstrated that there is an inner plane, nonphysical in nature, and not subject to physical laws, where intelligences of incalculable grades at all times persist. It is on this plane that the unconscious mind or soul of man exists while it functions through his physical body, and it is on this plane that it will continue to function and develop after the dissolution of the physical vehicle.

As psychokinesis, the power of the mind to move and manipulate physical objects, has now been amply demonstrated in many university laboratories, and psychical researchers have observed the production of ectoplasm and materializations under the influence of the mind of a medium or some other entity, there is no valid reason to believe that under proper physical conditions influenced by suitable inner plane weather, an inner plane intelligence could not combine the necessary molecules to form a single cell organism, and continue to manifest through this primitive cell. Such “demonstrating” a physical vehicle by an inner plane soul longing for physical experience would be no more remarkable than the occasional amazing “demonstration” by the psychokinetic power of the mind of health or some other physical condition that most of us have had opportunity to observe. The soul, launched on the Cycle of Necessity, as explained in lesson No. 4, has the power, now called psychokinesis, of attracting, molding and repelling the various forms that it needs for experience.

Whether it is the soul of a bacterium or the soul of man, it at all times resides on the inner plane. And so long as it manifests through a physical body it maintains its union with it through psychokinetic power. When, due to the stress of unfavorable inner plane weather, which is mapped by astrology, external conditions offer sufficient resistance to the psychokinetic control of the body that it can no longer manipulate the physical functions and handle the electromagnetism—which is the boundary line energy that links its high velocity to the low velocity of the physical—we say the body is dead.

That, however, merely signifies that it has lost this particular physical vehicle. It still persists on the inner plane, and if it is a form of life lower than man, it strives to make contact with the germ of another and somewhat more complex physical life form through the physical existence of which, as it grows to maturity and perhaps to old age, it can gain still other physical experiences.

The soul has two faculties that have now been amply demonstrated in university laboratories. It has the faculty of acquiring information through what is now called extrasensory perception. It can, without the aid of physical senses or reason acquire information about the distant present, the past and the future. Clairvoyance, telepathy, postcognition and precognition have now been thoroughly demonstrated. Extrasensory perception, including telepathy, is the normal manner in which information is acquired by inner plane entities. But when an inner plane entity forms a union with a physical body, it largely focuses its extrasensory power on the responsiveness of the physical organism and acquires most of its information from what happens to the physical body.

By the time it has acquired experience enough to be able to become united to a human being it depends very largely for its information on the sense organs and the brain. It retains its ability to get information other than through the nervous system; for it has been shown that while they may be objectively unaware of the information thus acquired, both man and animals often act successfully to adapt themselves to approaching situations of which they could have no knowledge through physical channels.

While its physical body lives, however, the soul of any life form, including man, uses its extrasensory faculty chiefly to keep aware of what happens to that physical body. It is united with that body to get physical experience, and its extrasensory faculty is chiefly concentrated on becoming aware of physical experiences, which in man, of course, include the electromagnetic processes within the brain that give rise to objective consciousness.

As university experiments also demonstrate, when a soul unites with a physical organism for the purpose of material experience, it does not lose its power of psychokinesis. It can still, on occasions, move and manipulate physical objects without physical contact. But while thus united to a physical body, its psychokinetic power is chiefly exercised in keeping in contact with that body, and controlling its movements. Every voluntary movement made by man is due to the soul on the inner

plane exercising psychokinetic power over his motor nervous system.

What has here been stated also explains why when people exert themselves to get information through extrasensory perception they usually fail. The willing effort has been conditioned throughout a long past to concentrate the extrasensory faculties on the reports of the physical senses. What is needed, instead, is a strong desire on the part of the soul, or unconscious mind, rather than of objective consciousness, to get the information more directly without the intermediation of the physical senses.

And it also explains why intense willing usually thwarts the effort of those who try to demonstrate something through mental power. The willing process has been conditioned throughout a long past to concentrate the psychokinetic power on moving the muscles to accomplish what was desired. But what is needed is a strong desire on the part of the soul, rather than of objective consciousness, to accomplish the demonstration more directly without the intermediation of physical movement.

Other factors, which will be considered in subsequent lessons, play a part in the evolution of life forms on the earth; but certainly the power of the soul to move and manipulate physical substance is a highly important factor in this progress from the simple to the more complex.

The First Life on Earth

—Apparently as soon as the earth had sufficiently cooled and other conditions developed that made it possible for life to function here, about 1750 million years ago, inner plane life succeeded in using its psychokinetic ability to get a foothold on this sphere. At that time the temperature probably was considerably higher than now, there was little free oxygen in the atmosphere, and sunlight was shut off by dense clouds. It is estimated that there is in the sedimentary rocks and in the fuel deposits of the earth, 30,000 times as much carbon as there is at present in the atmosphere. Higher forms of life could not live under such conditions as doubtless existed when all this carbon as carbon dioxide was in the atmosphere. Together with water vapor it must have formed an atmospheric blanket that absorbed the rays of the sun and kept the heat of the earth from radiating. Under these conditions bacteria, the lowest form of life of which we have any knowledge—although Coenocytes, Mycetocytes, certain molds and certain algae are amorphous living matter not divided into cells, while bacteria are unicellular but lacking in definite nucleus—would thrive and prosper.

Plants are dependent upon light for the assimilation of the carbon dioxide of the air, which is their chief and most essential food supply. The nitrogen bacteria have the power of assimilating free nitrogen from the air and at the same time and without the aid of sunlight can decompose carbon dioxide. They thus can live on inorganic products without the aid of sunlight, which plants are incapable of doing.

All life on earth—bacteria, plants, animals, and man—is associated with protoplasm. The four most important elements in protoplasm are nitrogen, carbon, oxygen and

hydrogen, which the primitive bacteria obtained from the free nitrogen and carbon dioxide, and the water, of the air.

Among the oldest rocks of the earth formed after the process of erosion set in and conditions developed that made it possible for life to gain a foothold—estimated by the most competent authorities as 1750 million years ago—at the commencement of the Archeozoic era, are to be found immense deposits of mineral that have been formed by bacteria which have developed from the simpler form. Iron bacteria, such as Lepothrix, obtain their energy from the oxidation of iron compounds. The iron oxide so obtained being insoluble, stays in the bacteria, and when the bacteria die this iron oxide remains as a mineral deposit. Vast beds of iron ore formed in this manner are known. Sulphur bacteria in a similar manner oxidize hydrogen sulphide, and the remains of their dead bodies form huge ancient mineral deposits.

Plant Evolution

—From its first appearance on earth life possessed and expressed the three hereditary drives (lesson No. 60)—the drive for significance, the drive for reproduction, and the drive for nutrition—which are the most powerful motives in human life. From the very first there is exhibited in the effort to develop new and more complex forms not required for survival—for iron bacteria and innumerable other forms of life still exist abundantly in practically the same condition that their ancestors existed when their earliest remains were deposited in ancient rocks—the drive for significance, the drive to ascend to something better. And in so doing not only did some individuals develop more complex structures, but the direction of movement of all such forms as are the ancestors of existing life forms on earth, was toward the fulfillment of God's Great Plan (lesson No. 56). It is true that inner plane and outer plane environmental changes at times forced certain life forms to alter structure and habits or perish. But there is evidence also of the drive for significance satisfied by more complex experience.

Animals are entirely dependent upon organic food for their existence, for they are not provided with chlorophyll. This organic food is supplied by plants. There are some plants—mushrooms, molds, mildews and rusts, as well as certain flowering plants—that have no chlorophyll. They must depend upon the organic food which has been gathered—that in some cases has decayed through the action of bacteria and in others yet exists in the living plant—for their food supply.

While some of the bacteria in the world today are injurious to mankind, through leaving their by products where they poison him, yet organic life is dependent upon bacteria for continued existence. Bacteria not only assimilate free nitrogen, and change certain nitrogen containing substances in the soil into forms that can be used by higher plants, but they bring about the decomposition of dead organic material, which is essential if it is to be used by plants. All organisms give off waste products, but with the exception of carbon dioxide little of this waste matter can be used by plants until it has been decomposed, or rotted, through the action of bacteria.

The nutritive liquid of animals is blood, and this in the higher animals contains the red pigment hemoglobin. It is chemically quite similar to the nutritive liquid of plants, but differs from the latter in that a molecule of hemoglobin contains one atom of iron, whereas the simpler molecule of chlorophyll contains one atom of magnesium. And there are certain lower type animals, including some snails, in which the blood molecule, instead of either iron or magnesium, contains an atom of copper.

There are also elementary forms of life that seem to have the outstanding characteristics of both animals and plants. The dinoflagellates are algae so small as to be visible only under the microscope. They are abundant in stagnant water. They move quickly through the water by the aid of long flexible tails, and as they breathe their cellular body inflates and deflates. In these motions they resemble animals. But they resemble plants in that they are single celled organisms containing chlorophyll and surrounded, as are many plants, by a cellulose membrane.

Life was not content with such simple existence as the bacteria. There was the urge for more complex expression. Under the stimulus of inner plane and outer plane environment its psychokinetic power produced alterations in some individuals which were transmitted through cell division. A very elementary plant appeared, the blue green alga, which still exists today. In some of these, which in form and reproduction resemble bacteria, there is no nucleus and no chlorophyll. Their pigment is phycocyanin.

Certain of the blue green algae occur as slimy blackish green films. They, like bacteria, reproduce by simple cell division. Some of them, similar to bacteria, are able to endure heat that would be fatal to ordinary plants. The sinter deposits, or formation, of the hot springs and geysers in Yellowstone Park are due to such algae. So also in cooler water the presence of a free floating form of blue green alga, so called but in this case red, gives the Red Sea its characteristic color.

The next step was the development of a nucleus in the cell and the ability to manufacture chlorophyll. Green plants are able to use chemical elements in such proportions as to manufacture the substance which gives to leaves their green color. This chlorophyll, in the presence of sunlight has the property of capturing carbon from the carbon dioxide in the atmosphere and releasing free oxygen. The process by which it does this is similar to that by which sunlight causes chemical changes to take place on a photographic negative, and is called photosynthesis.

The early plant, such as the green algae, consisting of but a single cell, needed a certain amount of protection, and this desire directed psychokinesis to the formation of a cellulose wall about the protoplasm within. The protoplasm in all but the very lowest plants, even as is true in all animal cells, contains a well organized nucleus. Growth in plants and animals alike takes place through cell division in which both nucleus and the cytoplasm—the protoplasm of the cell exclusive of the nucleus—split, a portion of each going into the production of new cells. The protoplasm in the body of man today may contain an infinitely small amount of the

protoplasm of a primitive one celled form of life that existed more than a billion years ago; for—even though psychokinesis was necessary to form the first primitive cell—so far as has been observed new cells are formed only by the division of cells previously existing.

Even as today it is necessary that nations cooperate, so it is evident that in many cases groups of cells could gain an advantage by cooperating. This need, recognized by the soul's extrasensory perception, was met through the psychokinetic power of its desire. As a result we find the next step in progress to be, instead of single celled plants, plants composed of a number of cells. The simplest of these are the filamentous algae, consisting of rows of cells somewhat like a chain, barely attached to one another. When such a colony of cells finally became established, the next step would be toward a division of labor, and we find a tendency in somewhat higher forms of algae for certain cells to specialize in gathering carbon from the air, and others to specialize in the storage of the food so gathered, and still others in protecting it from the evaporation of its water and the inclemencies of its environment.

Before we pass to the next step in the development of plants of more than one cell, let us pause a moment in awe before the vast work of the primitive algae that early in the geologic history of the world must literally have swarmed the seas. We are somewhat familiar with coral polyps, minute colonial animals which build islands and shore lines with their dead bodies; but such land building does not compare in its extent and importance with that of certain lime secreting algae. These calcareous algae, as they are called, are held to be responsible for the formation of the very ancient limestones. The rocks of the Grenville Series alone, a very ancient series of rocks, are nearly 18 miles thick, and half of this is limestone undoubtedly deposited by such algae. In other cases the algae and a lime secreting bacterium are jointly responsible, as in the case of the massive limestones of the Teton region.

This habit of secreting lime, which was later adopted by animal life, has a most important bearing upon any study of the past; for before this neither animals nor plants had hard parts that could be preserved as fossils in the rocks, and their presence can only be known from inference. Such an inference as to the extent of ancient life on the earth may be found in beds of iron ore and sulphur as previously mentioned, and in the existence of masses of graphyte in exceedingly ancient formation. Graphyte is never produced in nature other than through organic activity.

Most of us are familiar with green “pond scums”, which are chains of algae cells, all quite alike, floating on the water. These are fresh water algae, but certain kinds that have developed from them, and become more elaborate in structure have found their way to the sea and form the green sea weeds; and others, because they secrete lime, look very much like plant corals. The bulk of marine vegetation, or seaweeds, however, have developed other traits to suit their salt water environment and belong either to the Brown Algae or the Red Algae. The red algae, which constitute the greater bulk of seaweed, is thought to be but a more complex development from green algae. The red pigment and the brown pigment, by which the red algae and the brown algae are colored, is supposed to supplement the action of the chlorophyll in

utilizing the light which filters to it through the water.

The brown algae, including the giant kelps which are so common to the Pacific Coast of America and so familiar to those who visit the ocean beaches near Los Angeles, sometimes reach a length of one hundred yards or more. They are probably not direct descendants from green algae, but from the animal like Flagellates, to which group the previously mentioned dinoflagellates belong.

The ancient seas were fresh, for the salt now in the sea was gradually leached out of the land. The adaptation of life to salt water, then, is of a later date than the more ancient rocks that have formed by sedimentation. The giant kelps and the red algae have solved the problem of living in salt water better than any other plants, and seem to have reached a point, due to the restrictions of their environment, beyond which further progress is impossible. Their texture is such, due to the manner in which the cells join, that while immersed in water it freely circulates through them, yet the outer cells have been thickened and toughened to form a leathery skin which, when exposed to sun and air, due to low tides, protects it from evaporation. Some of them, like the giant kelps, have developed not only an anchoring device, called a holdfast, by which one end is attached to a pebble at the sea bottom, but also hollow bladder like buoys that may be as large as a child's head, by which their long stems, bearing floating leaves, may be made to reach the surface.

It is supposed by some naturalists that the fungi are descended from certain species of red algae. The fungi do not possess chlorophyll and depend upon other plants and animals to furnish their carbon food supply. They probably have degenerated from higher plant forms, finding an easy living at the expense of others. Parasitism, whether in plants, in animals, or if we may use the term thus, in man, is always followed by deterioration. These fungi—the molds, mildews, rusts, mushrooms, etc.—some 40,000 species of which are known—have degenerated to a very low level in plant life. They do not possess seeds, but propagate by means of spores. The smoke that issues from a puff ball when pressed consists of millions of such spores. In the case of the familiar mushrooms and toadstools the spores are developed in the gills on the under side. In fact these gills, or flutings, open for the express purpose of dropping the myriad minute spores by which they reproduce.

Fresh water ponds are in the habit of drying up. In such instances the green algae living upon their surfaces, unless possessed of some method of tiding over the dry spell, all die. The mud at the bottom of such a pond, when the pond first dries, is moist, and the algae would cling to it for moisture, for active life either in plants or animals depends upon the protoplasm being supplied with moisture. The water gives to protoplasm a semi fluid consistency which is absolutely essential to its movement.

Green algae, resting upon the drying bottom of a pond, would be hard pressed to prevent all its moisture being dried out by the sun, and to get an additional supply from the drying mud. The desire for life in some of these brought psychokinesis to bear to make necessary structural changes. The algae, by a thickening of the cell walls, escaped being completely dried up, and thus when the dry spell was over was

able to resume normal life. These special thick walled cells, which foreshadowed the development of seeds, are called resting spores. Some of the algae also, in their desire to follow the water as it receded into the mud and thus provide themselves with moisture, developed cells in the direction of the moisture, and these cells becoming specialized were the first roots. This was one of the greatest and most important steps taken by life since it started on our globe, for it gave rise to the ability of life to live upon the land.

Vegetable life in the water depends upon the water for support, but as life crept from the warm and shallow ponds and fresh water seas out upon the land it found it to be a great advantage to be able to lift its chlorophyll bearing surface to the sun, that it might draw a greater food supply from the air. Some of the liverworts, which lie prostrate upon the ground, have delicate hair like roots, and a structure not as complex as the algae, being composed of almost uniform cells. They live today as examples of what the first land plants must have been like. But with the desire strong upon them to reach the light, certain of the cells developed a harder, more compact structure, and gradually a supporting stem came into being.

With the development of firm supporting tissues the need arose also for special tissues for the rapid transportation of water, and a softer conducting tissue was developed. Not only are the liverworts prostrate, but so are some of the other low land plants such as the mosses. And to indicate that their ancestors came from the water we find that mosses and ferns are dependent upon the presence of free water for the development of certain phases of their life histories. Even as amphibious animals must return to the water to lay their eggs, and pass through the early stages of life in water, so familiar to us in the lives of frogs and toads as the tadpole stage, so these plants also may be considered amphibious.

The ferns, although reproducing by means of spores instead of seeds, are more complex in structure and in their life histories than the liverworts and mosses. A spore is a single cell, minute in size and without sex, and in the case of the fern a number are born in each little capsule on the under side of the frond (leaf). When this spore is released and germinates it does not grow into a fern, but into a very different plant, or prothallus, a green blade about a quarter of an inch long. On the lower side of this new plant grow the sexual reproductive organs which produce the egg cells and sperms. The sperm has a tail of minute hair like cells by which it swims through the film of water that must be present on the blade of the plant, to the egg, which it enters and impregnates. And from this the new fern grows. In the case of the mosses the generation that produces the sexual parts is the moss plant, the other plant essential in the life cycle being the capsule which bears the spores. This lives as a parasite on its parent. Spores are not seeds, but they serve as resting bodies through which later a generation may be perpetuated, and they serve as a convenient means for distributing the species.

Somewhat more complex than, yet evidently related to, the ferns are the curious horsetails that grow in low moist ground. Some twenty-five species are known to exist at present, representing, in a meager way, the gigantic species that once existed

upon the earth before the advent of flowering plants. The club mosses, also spore bearing plants, are supposed to be related remotely to the ferns, and once provided an important part of the land vegetation.

The dependence upon water for the propagation of the species became a serious handicap to land plants, just as it did to land animals, and the problem was solved much in the same way by both. In the case of a seed plant the pollen falling on the ovule develops a little tube that penetrates the egg and brings the fusion of the male and female elements that are necessary for the beginning of a new plant. This does not require the presence of water through which the sperm must swim, and has an additional advantage in that the young plant resulting from the fusion of male and female elements remains associated with the parent plant, drawing nourishment from it, and protected from inclemencies by being enclosed in a sheath and surrounded by nourishing food. When the little plant in the seed reaches a certain stage of growth its development is stopped for the time being, to begin again when the plant has left its parent and found its way into moist soil.

Seed bearing plants release their young alive, quite as effectively as do the higher animals. The young plant, or embryo, which can clearly be seen by opening a soaked pea or bean, has another great advantage over the plants growing from the sexual union of the parts that grow from a spore. The latter must procure all their own nourishment from the start. But seed plants have an abundance of food stored up in the seed to give them a good start on life's journey. They are as well provided for as the calf which grows inside its mother from an egg to considerable size before being born, and then after birth is provided with rich warm milk for six months or more. The seed plants take excellent care of their young.

The first seed plants were ferns, now extinct, but existing in great numbers during the Paleozoic era which began about 350 million years ago. These seeds were less perfect than those of today, and no fern now exists that bears seeds. The cycads and ginkgoes, once very numerous upon the earth, are clearly descended from ferns, and represent no great modification in structure. The "sago palm" of our greenhouses is one of the cycads, and the Ginkgo, or maiden hair tree, is quite common as an ornamental tree here in California.

It is thought that the conifer, or cone bearing trees, are modifications of certain club mosses whose fossil remains have been discovered. A small species of club moss is common on the hills of Los Angeles. The cones of conifers seem to be mere modifications of structure common to certain extinct club mosses which are known to have borne seeds. These cone bearing plants, represented most extensively by our pines and firs, are of a lower order of existence than most of our flowering trees and plants.

The thin, long, resinous foliage of our conifers is an adaptation to prevent the excessive evaporation of moisture from the plant in dry regions. Other plants of the same group, such as the Araucaria which is common in California parks, have broader leaves. These trees came into existence upon the face of the earth at an earlier

date than the common flowering plants. The seed, instead of being enclosed in an ovary, is naked like those of the cycads, and is borne on the surface of a scale. These scales, bearing naked seeds on their surfaces, form the cones of familiar trees.

Even though the conifers came into existence so long ago, they have proved exceedingly successful, as our vast northern forests prove. Some of them, too, have developed an uncanny way of anticipating the future, as in the case of the fire type pines, which hold their seeds for a dozen years until a fire destroys all other vegetation, and then, due to the heat that has passed, the cones gradually open and the seeds are deposited in the ground that has been well prepared for their being covered, and from which the competition of other growth has for the time being been eliminated.

Chapter 3

Serial No. 127
Original Copyright 1949
Elbert Benjamine

Copyright
August 2002
Church of Light

Progress of Invertebrate Life

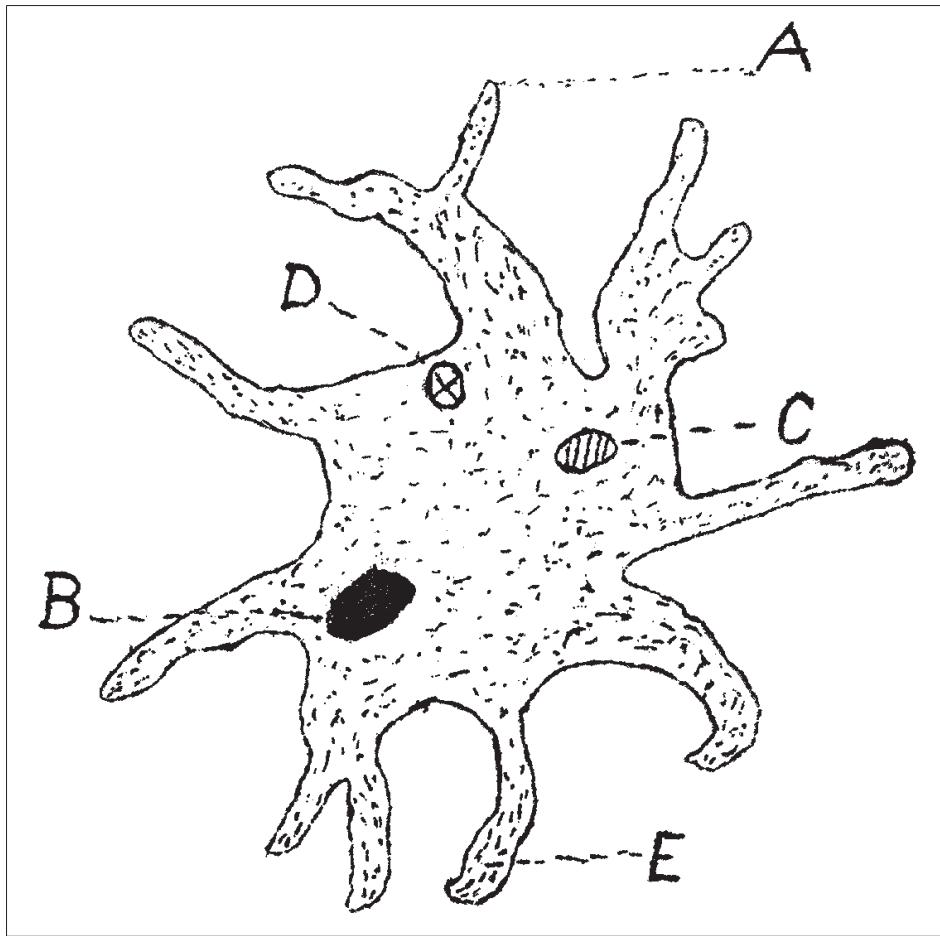

DIAGRAM OF AN AMOEBIA

The amoeba is a typical Protozoan. It appears as an irregular speck of greyish jelly about 1/100 of an inch in diameter. It is common in fresh water ponds, where it oozes along engulfing other tiny specks of organic matter by flowing over them. A represents one of the outflowing lobes that surround the prey. B is the nucleus. C represents food that has been ingested. D represents undigestible pieces of food that are about to be expelled. E points to the granular structure of the protoplasm.

Chapter 3

Progress of Invertebrate Life

WHEN the environment radically changes, most life forms must also radically alter either their structure or their habits or perish. It will be indicated in subsequent lessons how marked weather changes brought the extinction of numberless forms, and the kind of radical changes some made in order to adapt themselves sufficiently to the new condition to be able to survive. When previously arid regions became deluged with rain, their vegetation had to acquire new characteristics to prosper, and when previously well watered regions became arid, not only did plants have to change their structure to gain and preserve the scant moisture, but creatures whose young were hatched in the water and developed through the tadpole period had to so change that their young reached a land inhabiting stage without living their youth in the water.

In a previously calm region, when climatic changes developed powerful winds, both plants and animals, to survive, had to develop protection against such gales. When glaciers came down from the north and the previously warm weather became intensely cold, some animal forms developed feathers from scales, and others developed fur; and the young, to protect them from such inclemencies were either not born in the previously immature condition, or the eggs and young were protected by nests until the offspring had matured enough to be able to adapt themselves to the food and temperature conditions brought about by the severe weather.

Wind and falling water and the cold which causes the moisture in its capillaries and crevices to freeze and crack open or flake off pieces of rock, have cut canyons thousands of feet deep in the earth's crust and have leveled giant mountain chains.

These facts are familiar to all. But there is now good evidence that the inner plane weather, consisting of astrological energies, is fully as powerful to inaugurate changes in the rocks, and in life forms, as is the outer plane weather. Even though they are not aware it is influencing them, Church of Light research has proved that inanimate objects and other life forms as well as man are powerfully thus influenced. A machine built at one time will not last as long as a machine built at a more favorable astrological time. Crops, as many farmers have learned through experience, even

though planted when the outer plane weather is favorable, will not thrive and produce so well if planted when the inner plane weather is adverse as when planted while inner plane weather is more suitable.

So far as our research has gone we have found that progressed aspects affect animals in the same manner they affect men, due allowance being made for the normal level of the animal. It is not to be expected that an insect whose normal life span is only a few days will respond other than to progressed positions within those few days. And just how they so respond is yet to be ascertained by timing their births and calculating the aspects which subsequently form. But we have had ample opportunity to observe in cats, horses and dogs that on their level progressed aspects influence their lives as they do human beings.

A lady in San Francisco who raised show dogs kept a record of each puppy born, erected its birthchart and observed its progressed aspects. These charts were sent to us for our opinion. If one of her dogs had a good tenth house it had a good chance of winning a prize at the dog shows, and she found that this was almost certain to occur if it had a harmonious progressed aspect to the ruler of the tenth at the time of the show. The same kind of chart and progressions that belonging to a politician would insure he would win an election, if it belonged to one of her dogs would equally insure he would get a prize at the dog show.

Another gentleman in Montana used astrology in raising and training race horses. He learned to tell when the colt was first born what its prospects were, whether it would be subject to accident, and if it were worth training as a racer. And he could tell by its progressed aspects at the time of a given race whether the horse would get a good break, or whether he would have to overcome fortuitous obstacles in order to win.

The writer has watched the response of both cats and dogs to progressed aspects. The chart of his present dog with the dates of all important events that have entered his life during more than ten years is given on page 67, together with the significant major progressed aspects coincident with them. Due to lack of space the minor progressed aspects and transit progressed aspects are not there given; but anyone who wishes to calculate them will find that exactly as in a human horoscope, each of these major progressed aspects is reinforced by a minor progressed aspect, and released by a transit progressed aspect, within one degree of perfect at the time the event occurred.

Life must adapt itself to both inner plane and outer plane weather or perish. And the survival of the fittest is a factor in organic evolution. But as subsequently will be indicated, such progress is not in some haphazard direction. Every outdoor naturalist I have ever met has been convinced there is a Super Intelligence permeating and broadly directing all the processes of nature. Such direction is not that of whim or prejudice, but always according to well defined laws. And one of the outstanding laws is that the pressure of the inner plane weather and the outer plane weather is such that the overall progress made by life—even though innumerable forms do move up blind alleys and become extinct, and others finding satisfactory adaptation stagnate—is toward filling in the universal plan formulated in the mind of Deity.

Plants as well as animals and men have, in some degree extrasensory perception, and psychokinetic power (lesson No. 40). And in response to their desire to live and find an adequate food supply they have made many remarkable and intelligent variations. Our stone crops, for instance, finding competition unusually strenuous on fertile ground, gradually moved into rocky regions where other plants did not grow. In such ground moisture is retained but a short time. Therefore, to meet this condition the stone crop greatly thickened its leaves, so as to make a reservoir for holding the moisture and thus tiding it over dry weather. The various species of cacti, finding a desert environment developing around them, likewise thickened their leaves as water reservoirs. In addition they had to combat a scorching sun and numerous herbivorous animals, made voracious because other vegetation, always scanty, failed to grow during the long dry seasons. To meet the scorching rays of the sun they caused the outer cells of their leaves to harden, thus coating each leafy reservoir with horn like insulation against the evaporation of its water. To protect themselves from greedy animals many of their leaf parts were made slender and hard, so that their leaves were covered with thorns.

Botanists recognize the leaf as the basic form of all the organs of higher plants. However diverse in form and function a plant organ may be—bud, thorn, flower part, bulb, or fruit—it is but a modification of leaves. In the calyx of the peony, for instance, the sepals, while largely green like any other leaf, have a fringe of color, indicating the process of transformation. This change of leaf into petal has not been completed in the snowflake; for here we find the petal of the flower white, except the very tip, which is yet green like the leaf. In the begonia, also certain of the stamens often revert to their original leaf form; and in the water lily the stamens and petals grade into each other with such slight variations that it is easy to trace all the steps of enlargement, broadening and coloring, by which the leaf like stamen becomes the beautiful petal. Thorns and the stings of nettles are also mere modifications of leaf structure in answer to the intense desire of the soul of the plant to be protected from its numerous enemies. And even as the most delicate rose, or the most gorgeous orchid, results from modifications of leaves, so every animal on the face of the earth is but the result of modification of simple single celled protozoa.

Plants growing like the water lily, where there was little competition for sunlight, developed broad leaves. Those growing where there was much competition for sunlight, like our grasses, developed narrow leaves that were able to profit by whatever gleam of light filtered through the surrounding vegetation. We find, in fact, much the same tactics employed by plants that are employed by animals for the same purpose. Plants produce poisonous and evil smelling secretions to ward off enemies, much as do certain ants and beetles among insects, and as does the skunk among mammals. Some plants also are carnivorous. The sundews, the butterworts, the bladderworts, the Venus fly trap, and the pitcher plants—one of which grows in the mountains of California—all trap and assimilate insects.

In the Venus fly trap there is a rounded blade. On the upper surface of each half of this blade are three prominent bristles, and around the margin a row of stiff thorn like teeth. When an insect touches one of the bristles there is an electrical charge in the plant similar to that taking place in an animal when it contracts a muscle, and the two halves of the blade clap together the marginal thorns interlocking like the teeth of a rat trap. Then a digestive fluid is secreted and the insect so caught is digested and assimilated, after which the blade opens for another capture. It may be cheated by using a little piece of moist paper to take the place of an insect, but after twice closing on worthless material in rapid succession it usually will refuse to be duped a third time. It modifies its actions because there is memory of a previous experience.

It would be interesting to write a large volume citing the marvelous methods plants use to overcome the difficulties that have confronted them. It must suffice here, however, to say that every plant form and method of life holds the story of its endeavor to overcome certain limitations placed upon it by environment. The deciphering of these plant romances and adventures, as well as those of insects and other animals, has been my chief and pleasantest avocation for more than half a century, but they cannot be related here.

Early Animals

—Living matter is always associated with protoplasm. Protoplasm is an essential ingredient both of animals and of vegetables. Where, then, is the line of demarcation between them, and what were the incentives that produced the first animal?

As I have pointed out in lesson No. 126 there is no clear cut line between them; some animals, such as the protozoan *Luglena*, are provided with chlorophyll, and others, such as the ascidians, possess cellulose; both of which commonly are considered strictly plant features. Animals live upon organic matter, and in some stage of life possess the power of locomotion. Yet among plants the fungi live upon organic matter; and many algae, such as the diatoms, and the spores of the cryptograms, have the power of locomotion. To be sure, the male sexual element of most plants has the power of locomotion well developed.

In general, the source of food supply and the power of locomotion tend to distinguish animals from plants. Plants, with the exception of those that feed upon material already organized, possess the green coloring matter chlorophyll, by which, in the presence of sunlight, they are able to capture carbon, their chief food supply, from the atmosphere. Animals, on the other hand, are not capable of living upon inorganic matter. Their chief food supply is the organic matter stored up by plants. Animals also feed upon other animals. In fact, sea creatures form a chain from the smallest to the largest, the smaller in turn being devoured by the larger. But the original food supply sustaining the smallest, and hence the whole chain, is vegetable or bacterial in origin.

To obtain a vegetable food supply, either the plants must be brought to the animal or the animal must go to the plants. Water tends to bring the food supply of certain creatures, such as the sponges, yet even these usually have developed the power of producing the current of water which brings their food. But more often, to get an adequate food supply, the animal must go to its food. This necessitates locomotion.

We can hardly conceive of animals living before plants or bacteria, but so soon as these came into existence there was an available food supply, and it is probable that it was not long before there were animals developed to take advantage of it. In fact, it is even possible that animals developed before plants, as many of the protozoa feed freely upon bacteria, and today thus exert a limiting influence upon bacterial activity.

The urge to secure a food supply—the drive for nutrition—is a fundamental impulse common to all life. And this intense desire ever tends through psychokinesis to adapt the structure to the end of better securing its food. When a new condition arises the soul through extrasensory perception is dimly aware of its plight and feels the desire successfully to meet the new condition. Psychokinesis endeavors to provide the way, but subjective intelligence makes many mistakes. It is not reason, but the primitive working of psychokinesis based on imperfect perception and the memory of previous experiences, which may have been largely astral, stored in the astral form.

But desire changes the astral form and this in turn through psychokinesis changes the form and attributes of the physical structure. Thus we may conceive of a single primitive cell of living matter, stimulated by desire for food, departing from the custom of seeking nourishment from the inorganic matter and appropriating the food already secured by its neighbor. This then proved so successful an expedient that the cell adopted it, and when it divided to form two cells, each new cell continued the trait. But this method, to prove permanently successful, requires that the cell be able to move from place to place in search of other cells to devour. This desire actively to seek a food supply, through psychokinesis brought about a change in the physical structure that gave greater mobility and finally resulted in a cell having the power to move about ingesting less favored forms of life. Such was the primitive protozoan.

The protozoa not only were the first animals on earth, but persist today as the most abundant aquatic animals. Millions of them swarm in almost every drop of water. Not all of them are so small, however, for they range from those microscopic forms just mentioned up to a gigantic species two thirds of an inch in length found as a parasite in the intestines of lobsters. They are all single celled creatures.

Animal life is divided by naturalists into twelve great groups, or phyla. Unfortunately, knowledge of animal life is so greatly confined to the very few that there are no vernacular names for most of the great groups of animals living today. This is true with even greater force of extinct animals, of which I shall speak in treating of mammals. Consequently, while I desire to avoid technical names, I must be pardoned for occasionally using them in these lessons, because there are no other terms by which a great number of interesting creatures may be designated.

PHYLUM I, the Protozoa: These are infinite in the variety of their forms. The typical protozoa is the amoebae (page 68), which is abundant at the bottom of fresh water ponds and among decaying water vegetation. It is a microscopic mass of jelly like protoplasm containing a nucleus. It moves by changing the outline of its body, pushing out and withdrawing portions of the jelly like mass to produce a flowing effect. Its food consists of minute animals or plants or other bits of organic matter. When it touches such a morsel it gradually flows around and over it until the latter is quite surrounded. The protoplasm surrounding the food particle then secretes an acid which kills the prey and forms the soluble peptones or digestive ferment necessary for digestion. When the digestible portion of the food has been assimilated, the undigested particles are left behind as the amoebae flows on.

Such a simple organism is removed from certain primitive single celled plants only by a slight modification, for we must remember that some of these plants have the power of locomotion. Certain plants also feed upon organic matter. The protozoa, therefore, but utilize in a somewhat greater degree of coordination, two principles that also are used by plant forms. We may assume that the frothy chemical compound called protoplasm found it more expedient in the case of the protozoa to flow slowly about feedings on particles of life that had been already organized than to remain in one place and endeavor to transform inorganic elements into food value.

Yet because of its minuteness and simplicity of structure we should not hastily scorn the simple cell. The single celled protozoa have an infinite variety of modifications, and the cells that make up the body of both plants and animals are not widely dissimilar to these. Were it not, for instance, for the amoebae like cells in the human blood, man would soon succumb to infectious diseases. The white corpuscles of the human blood often are called amoeboid corpuscles, because to all intents and purposes they are amoebae cells belonging to the human organism that are fostered by it as soldiers to guard it against invading germs. The amoeboid corpuscles, when minute organisms of various kinds invade the human system, act toward them as the ordinary amoebae act toward their prey. They pursue them and flow over them, engulfing them in their protoplasm. They are then digested and portions not assimilated are carried by the blood stream to parts of the body where they may easily be expelled. It is only when microbes multiply to such an extent that they so outnumber the amoeboid blood cells that these cannot kill and devour them that such diseases prove fatal.

I have mentioned in lesson No. 126 that certain algae devised the expedient of secreting lime. Other early plants—such as the microscopic ones called diatoms, closely related to algae and supposed to be the source of the oil in Southern California oil fields—adopted the expedient of secreting a skeleton of silica. So we need not be surprised that early one celled animals also should secrete hard parts to protect themselves from other predatory one celled animals. Certain of the protozoa, called foraminifera, secrete a shell, or external skeleton, of lime. There are foraminifera also that secrete a covering of chitin. Chitin is the horny substance forming the outer coat of insects and the crayfish group. Others of the protozoa secrete an external

skeleton of silica. We see, therefore, that among the very primitive single celled organisms of both plants and animals there existed not merely the power of nutrition and reproduction, but also the power to secrete substances that were not protoplasm.

This is very important to us; for man's body, like all organic forms, is built up by cells. The skin and viscera, in fact, consist of cells. But the bones and muscles are chiefly the secretory products of cell activity which continues to renew and nourish them.

To a single celled animal living in the water a better mode of locomotion than mere oozing along would prove exceedingly valuable. So in those called flagellates, mentioned in lesson No. 126, which are on the borderline between plants and animals, we find the cell secreting one or two hair like lashes which carry them along swiftly by beating the water.

A certain amount of protection is afforded by a thin membrane enclosing a cell. Consequently, in a somewhat more developed form of protozoa, called the ciliated infusoria, such a membrane is secreted and the hair like lashes which are used somewhat similar to oars are numerous. Also, as the containing membrane does not permit food to enter, there is an aperture in it, and in some forms, such as sedentary verticella, there are long lashes around this aperture that cause a whirlpool in the water and so bring the food down into the animal.

I have now mentioned members of three classes of protozoa. The phylum consists of four classes, each containing innumerable species. The fourth class developed more recently. Its members are parasitic, and unlike more ancient protozoa, they reproduce by means of spores. Each spore contains one or more minute germ. These germs and the animals they produce are the scourges of humanity, causing malaria, sleeping sickness, and a multitude of other dread diseases.

The ordinary protozoa and the cells of higher animals multiply by simple division. The particle of protoplasm contracts from two opposite sides, getting thinner and thinner in the middle until at last the connection is severed. In this process of division the nucleus of the cell always is divided, half of it going to form the nucleus of each new cell. When the two halves of the cell exist separately they gather food until both nucleus and its surrounding cytoplasm in each attain to normal size. The cells of the higher animals, including man, multiply in the same way as a primitive protozoan—by the mother cell dividing into two daughter cells—except that the cells of the protozoan go separate ways, and the cells of higher animals remain united.

Always, to explain the processes of higher animal life, we are compelled to return to the primitive protozoan, the first animal on earth; for in it we can perceive all the attributes and functions, in their simplest form, that we witness in the highest animal. But for the moment let us leave the protozoan and his single cell of living protoplasm and observe the formation of the first animal of more numerous cells.

Colonial Life

—Some of the flagellates are considered the ancestors of brown algae, which are plants, and some are classified as protozoa. It is believed that a certain flagellate protozoan, on reproducing, instead of sending the daughter cells to some distant place, held them attached to the mother until there was a tiny plate like colony of sixteen cells. These sixteen cells, each like a single celled animal, also each discharged all the vital functions. Yet because such an aggregation has certain advantages it was continued, and it came about whenever any one of the colonial cells reproduced by simply dividing, that the new cell went by itself, but dividing still further until it also produced a colony of sixteen cells. Such a sixteen celled colonial animal is the *Gonium*, and another whose colony tends to spherical form instead of being flat is the *Pandorina*. Both at the present day are common in fresh water.

Colonial life affording certain advantages, as time passed there came into being, in response to psychokinetic power, not merely sixteen celled colonies, but colonies composed of a great number of cells. With the enlargement of the colony it became increasingly difficult for every individual cell in it to perform all the functions of life. Already in certain protozoa, where the front differed in shape from the rear, when it divided to form two, each half was compelled to reproduce features that it did not possess. This ability of the soul thus had been acquired before the development of colonial organisms.

As pointed out in lesson No. 126, in addition to the drive to express itself more fully, the two great primitive desires of all life are the desire for food and the desire for reproduction. In a colonial organism both functions will be performed more successfully if certain members of the colony specialize in securing and assimilating food, and certain other members specialize in bringing into the world offspring. Such a division of labor for the first time, in so far as living forms are concerned, takes place in the *Volvox*. It is a hollow spherical colony of several thousand cells in a single external layer held together by gelatinous material and fine protoplasmic threads.

In the *Volvox* there are two kinds of cells. The one kind, called somatic cells, perform the functions of nutrition and locomotion. The other kind, called germ cells, perform the function of reproduction. The germ cells, through division, are able to form not only other germ cells, but also somatic cells, and thus when separated from their parent build up a new organism. This primitive division of labor also holds in the higher animals and in man. The ovum, which is a germ cell, always consists of a single cell. This divides into two daughter cells, and these into four, these into eight, sixteen, and finally into a cluster which arrange themselves into two strata forming a sack. From this stage, which has already progressed further than the *Volvox*, the forming organism passes through those stages of development parallel to still higher forms of life to be considered later; some of the cells secreting muscular tissue, some secreting the skeleton, some the nerve tissue, until the complete animal is present.

But in the Volvox there is still another division of labor, for the germ cells provide two kinds of sex cells, one male and one female. In the union of cells for the purpose of reproduction two things are essential; that the cells shall find each other, and that the resulting offspring shall be supplied with nourishment. To insure their union the male cells are very numerous, and as economy of material is advantageous, they are very small. In order that they may find the female cell they have the power of locomotion well developed. This locomotion, even in the higher animals, including man, is provided for by lashes similar to those of the flagellate protozoa. In fact, the sperm of higher animals has many points in common with the flagellates.

That the offspring may be provided with nutriment, the female germ cell specializes, not in movement, but in storing food. Consequently it is much larger than the male germ cell, as is markedly the case in the domestic fowl; for the yolk of a hen's egg, while still inside the hen and before fertilization sets up cell division, is but a single cell.

Contrary to popular conception, the sexual union of cells is not primarily to enable reproduction to take place, and originally had nothing to do with reproduction. Naturalists hold that its purpose is to enable the qualities of both parents to be inherited by the offspring, and Hermetic Initiates believe it further serves the purpose of revitalization.

During the sexual union of two protozoa there is an exchange of chromosomes (lesson 167). When they separate the nucleus of each animal contains half of the chromosomes of the other and half of its own. This insures, then, when each cell divides in future, that the offspring shall, like the parents after fusion, contain the qualities of both. It also provides for another important attribute; for protozoa that from time to time enter into union continue to live and reproduce, or at least live and thus have opportunity for reproducing, while those that fail to do so die. Unless they meet with violent ends, protozoa that have the opportunity for union do not grow old and die. It might be well, therefore, for certain ascetic cults that herald from the housetops that union save for the rare purpose of reproduction is a crime, to pause and consider the biological fact, as stated by our best scientists, that the only animals on earth that are physically immortal can and do reproduce without union, but that union is absolutely essential to their physical immortality.

PHYLUM II, the Porifera: They embrace the sponges. The cells usually are arranged in the form of a hollow attached vase through the walls of which are many canals, or pores. This small vase, instead of being composed of a single layer of cells like the Volvox, is composed of three layers held together. Division of labor has here progressed further, with compensating advantages; for the cells of the inner layer have little hair like lashes. In fact, they greatly resemble the flagellate protozoa. They lash the water, causing a current to flow through the canals, and also take in and digest the food thus brought to them. The middle layer of cells helps with digestion, and also secretes the hard framework. And even as some protozoa secrete lime, some silica, and some chitin, so there are sponges whose framework consists of each of these substances. The sponge of commerce is the chitin skeleton secreted by a whole

colony of sponges. Such a colony held firmly together by a framework has the advantage of protection from enemies that would readily swallow and digest unattached individuals.

PHYLUM III, the Coelenterata: These embrace the hydroids, the jellyfishes, and the corals. The individuals commonly are called polyps. The body is a sack, in the center of which is another sack, an arrangement that facilitates digestion. Around this sack other membranes radiate. These radial members are usually tentacles, which assist in procuring food, and often assist in protection. The sea anemones, so common on rocky beaches near Los Angeles, are stationary polyps. Reef corals have the ability to secrete a skeleton of lime, which is securely fastened to the skeleton of their ancestors, making it difficult for their enemies to dislodge them. They are minute in size, but almost infinite in number. The reef, which is largely composed of their skeletons, rises at the rate of half an inch in ten years. The red, or pink, coral ruled by Venus, thought by the ancients to be a sure protection against evil influences when worn, is secreted by a coral called *Corallina rubrum*. The jellyfishes, which are colonial organisms, have developed the power of locomotion, which is an obvious advantage, and also in addition to feeding tentacles have others armed with stinging cells, such as are present in the Portuguese man of war, common in southern waters. In both digestion and defense the Coelenterata have made a distinct advance over the sponges.

PHYLUM IV, the Platyhelminthes: These embrace the flat worms. The flat worms are numerous on the land and in both fresh water and sea water, many kinds being parasitic. They are the first animals to have a right and left side and the first to have a front end which, although possessing no head, is carried forward. They have developed sense organs that enable them both to see and hear somewhat, which is a great advance over lower forms both in securing food and in escaping enemies.

PHYLUM V, the Nemathelminthes: These embrace the round worms. These worms are cylindrical in shape, and have a decided advantage over the flat worms in possessing a body cavity, which is a great aid in the digestion and assimilation of food. This valuable feature of an intestinal canal, however, often is lost when the species become a parasite.

PHYLUM VI, the Trochelminthes: These embrace the wheel worms, the rotifers or wheel animacules, of minute and various shapes. Some swim by means of hair like bands which resemble revolving wheels. They are rather more complex in structure, and in this respect have made an advance over the animals so far mentioned. Yet their general features were not of sufficient value to be adopted by life as it developed further.

PHYLUM VII, the Molluscoidea: These embrace the Bryozoa, lamp shells and sea mosses. Such animals live in the water, the Bryozoa being a colonial form greatly resembling plants, common on our rocky beaches. They have various ingenious adaptations, and possess a well developed digestive canal. Typical of this group is the lamp shell, abundant off the coast of Maine, and to be found near Los Angeles.

The animal secretes a shell of two valves, which it opens and closes by muscular action. There is a mouth, and a groove bounded by little tentacles to guide the food to it. There is an esophagus and a stomach, and a stomach gland for performing digestion. The blood is colorless, and although there is no heart, contains corpuscles. It seems to be the precursor of the true mollusks, and has made an advance over lower forms in the matter of digestion and circulation.

PHYLUM VIII, the Echinodermata: These embrace the star fishes, the sea urchins, sea cucumbers, etc. They all live in the sea and are built on a symmetrical radiate plan such as gives the star fish its name. They have an outside skeleton, usually protected by numerous spines. They also have a great number of tube like feet ending in suckers, by which they move, and in the case of the star fish by which they open the shells of their prey. There is a blood system, a nervous system, and also a water vascular system peculiar to themselves. This group is exceedingly well adapted to the environment in which it lives. They have not developed from any of the four groups of worms, but undoubtedly are superior modifications from Phylum III, the Coelenterata. Their chief advance over lower forms is the possession of a superior stomach and digestive system, and a superior circulatory system.

PHYLUM IX, the Annulata: These embrace the worms. There are a great many species of these, and they have made unusually important advances over any forms previously considered. Their bodies are elongated, and composed of ring like divisions, each segment containing a separate and similar set of internal organs. There is also a blood system. Our common earth worm is a typical example. The sense organs of sight and hearing are more developed than in lower forms, and more important still, there is a nervous system having distinct ganglia, the first and largest ganglion being a part of the head. This, of course, foreshadows a brain, and is the most important advance over lower forms. The nerve chain is supported by a bundle of fibres which run along with it, and both are enclosed in a common sheath of connective tissue. The highly developed nervous system is advantageous in enabling a ready response to be made to environment, and some naturalists believe the sheathed nerve chain, which lies in relation to other organs as does the vertebrae in higher animals, which is also segmented, is the ancestor of the true vertebrate structure.

PHYLUM X, the Arthropoda: These embrace the crayfish group, the thousand legged worms, the spiders and the insects. They are animals possessing an elongated and transversely segmented body, with muscles attached to the inside of an external skeleton. This is quite the reverse from still higher animals, which have an internal skeleton about which the muscles are attached. Some of the body segments bear appendages, such as legs or wings, which are moved by muscles. The external skeleton is composed of chitin, a substance which certain protozoa also secrete. This hard outside skeleton prevents increase in size, hence growth occurs through shedding, or moulting, the chitin. There is a heart in most species, and a well

developed circulatory system, as well as a suitable breathing apparatus. There is a mouth, intestinal canal, a brain, and a nervous system. The heart and brain are notable advances over lower life forms.

The crustaceans, such as the shrimp, crayfish and crab, which live in the water and breathe by means of gills are included in this group. It is probable as soon as plants moved out of the water in the Middle Ordovician period although the earliest so far found is the Psilophyton, a little plant about a foot high without leaves from the Devonian period which commenced about 350 million years ago that such animals as quickly followed this food supply found gills insufficient to supply them with the necessary oxygen for life. No doubt numerous experiments were tried through psychokinesis before this inner plane power devised the expedient of having a system of tubes, called trachea, that with their microscopic branches permeate the whole body, air entering these tubes by external openings called spiracles. This system of breathing, because air reaches all organs and parts of the body, is in many respects superior to the lung breathing of vertebrate animals. It conduces to great activity, and is the system used by spiders and insects.

Insects have been unusually successful, 250,000 forms now being known with the tropics yet largely to be explored. They have made use of every available position in nature, have developed colors to protect themselves by concealment, have developed offensive weapons such as the sting of the hornet, and of still greater importance, because facilitating locomotion, is the common feature of wings. The most primitive insects, such as the spring tails, have no wings. Instead, at the end of the body are two elongated prongs which are bent under the abdomen and when pressed down form a lever by which the insect jumps. Such leaps, still further amplified in the flea and grasshopper, were undoubtedly steps leading to the development of true flight.

As but a single instance of the wonderful extrasensory intelligence displayed by insects, let us consider the wasp. The various digger wasps, in need of a food supply for their young, capture other insects with which they fill their burrows and on which they lay their eggs. Meat after being killed does not keep indefinitely, so these wasps, anticipating cold storage, devised a method by which their young might be provided with fresh meat as soon as hatched. They sting their prey in such a way as to reach the main nerve and paralyze the creature without killing it. The wasps of the genus *Ammophila* have even gone beyond this and have arrived at the tool making stage of progress. After the burrow has been completed the female wasp fills it with paralyzed caterpillars and then packs earth over the opening, using a stone as a tamping iron (p. 21, *The Insect Book*, by Dr. Leland O. Howard) to pack this earth down. Later she visits the spot occasionally to see if all is well and to place disguising objects where they will conceal it. Such provision is taken for the young, even though in many cases the parents die before the young hatch out.

Instances of insect intelligence could be multiplied indefinitely. Ants, for example, keep slaves. They also keep the equivalent of cows, which they manage with great sagacity. These are aphides and in California the scale from which by stroking they get a sweet secretion. Some ants are excellent farmers, not only keeping plants not

desired for their seeds from growing, but as in the case of the leaf cutting ant, actually cultivating in prepared beds a species of fungus which is their sole food supply, and which must have been cultivated by them for an immense period of time, as it has never been found in the wild uncultivated state.

But of the various wonders of insect life none is more difficult to understand than the metamorphosis. Certainly the ability of the soul to live in and function through an inner plane form after the dissolution of the physical is no more amazing. Primitive insects do not experience this change but hatch as miniature adults. More advanced insects show only a partial metamorphosis, the change from the larval stage being made by a series of moults that do not prevent feeding. But in the higher forms the insect hatches from the egg as a larva, which feeds voraciously and grows rapidly. Then comes the pupal stage in which there is no external activity, the insect being in a trance or comatose condition. While in this trance state the tissues are broken down and form a homogeneous fluid underneath the external skeleton of the insect. It thus precisely resembles the ectoplasm (lesson No. 45) which emanates from a medium during materialization. This ectoplasm has been proved to be composed of organic substance drawn from the medium and sitters. At first it is plastic and without structure. but may materialize into a form of actual flesh and blood.

The caterpillar in its trance condition not only dissolves to a structureless plastic fluid, but this fluid is reconstructed along entirely different lines into a creature having almost no resemblance to its former self. Undoubtedly the ectoplasm from a human medium is organized by an intelligent agent employing the medium's astral body through which to exercise psychokinetic power. And it is equally certain that the soul of the insect acts through its astral form, in which its own and inherited experiences reside, in a similar manner.

PHYLUM XI, the Mollusca: These embrace the mollusks such as the clam, oyster, mussel, snail and octopus. In fact, it includes all the sea shells commonly found along the ocean beach as well as the slugs and snails found crawling in our gardens. The bodies are bilaterally symmetrical, unsegmented, and enclose a sack like fold or mantle, which usually secretes the external skeleton, or shell. They are mostly able to crawl, swim, and burrow. They have a head, possessing a mouth and other appendages, with organs of special sense. Respiration is by means of gills. Quite interesting has been the discovery, through the study of embryology, that the young greatly resemble segmented worms, and in their growth show the steps by which the mollusks developed from such annulata. There is a good digestive system and a liver, which is an important advance. But as marking a still more important advance over previously mentioned forms is the development of a three chambered heart, and blood which in some species is red. This gives vigor of movement, which is a great advantage.

PHYLUM XII, the Chordata: These embrace the vertebrate animals; those possessing a backbone and those that show the presence of a primitive backbone at some stage of development. The main advance of this group, which includes all the higher animals, lies in the development of a second body cavity which houses a central nervous system; the spinal cord and brain.

Physical life has ascended from a single celled ancestor. One may observe closely the steps by which all present day plant structures are but the result of leaf modification. And a detailed study of the functions of present day animals is convincing that the animals now on earth developed from a single primitive cell. From the standpoint of religion this is an important finding, one replete with hope and assurance.

If man is a special creation, put here by an arbitrary Deity, there may be a hell to be dreaded, and a heaven which as usually described would be so monotonous that extinction would be preferable. But as all evidence goes to show that the soul actuated by the drive for sustenance, the drive for reproduction, and the drive for more ample expression, has developed a lowly single cell into higher animals and man, the possibilities of still further progress on the inner plane seem infinite.

Chapter 4

Serial No. 128
Original Copyright 1949
Elbert Benjamine

Copyright
August 2002
Church of Light

Fishes and Amphibians

Approximate Geologic Time Scale

Recent period has lasted to date . . . 30,000 years

Recent period commenced 30,000 years ago

Pleistocene period lasted 970,000 years

Fourth glacial advance lasted . . . 50,000 years

Fourth advance commenced . . . 80,000 years ago

Third interval lasted 200,000 years

Third interval commenced 280,000 years ago

Third glacial advance lasted . . . 50,000 years

Third advance commenced 330,000 years ago

Second interval lasted 425,000 years

Second interval commenced . . . 755,000 years ago

Second glacial advance lasted . . 40,000 years

Second advance commenced . . . 795,000 years ago

First interval lasted 175,000 years

First interval commenced 970,000 years ago

First advance lasted 30,000 years

First advance commenced 1,000,000 years ago

Pleistocene period commenced . . 1,000,000 years ago

Pliocene period lasted 6,000,000 years

Approximate Geologic Time Scale

Cenozoic era commenced 55,000,000 years ago
Mesozoic era lasted 135,000,000 years
Cretaceous period lasted. 40,000,000 years
Cretaceous period commenced . . . 95,000,000 years ago
Comanchean period lasted. 25,000,000 years
Comanchean period commenced . . 120,000,000 years ago
Jurassic period lasted 35,000,000 years
Jurassic period commenced 155,000,000 years ago
Triassic period lasted 35,000,000 years
Triassic period commenced 190,000,000 years ago
Mesozoic era commenced 190,000,000 years ago
Paleozoic era lasted 360,000,000 years
Permian period lasted 25,000,000 years
Permian period commenced 215,000,000 years ago
Pennsylvanian period lasted 40,000,000 years
Pennsylvanian period commenced 255,000,000 years ago
Mississippian period lasted 45,000,000 years
Mississippian period commenced . 300,000,000 years ago
Devonian period lasted 50,000,000 years
Devonian period commenced . . . 350,000,000 years ago

Chapter 4

Fishes and Amphibians

MANY factors are involved in the evolution of life forms on earth. The soul attached to an organism through psychokinetic power has the desire to survive, the desire to reproduce, and the desire to express its potentialities through the organism. A certain life form may have so well adapted itself to its environment that most of its individuals are quite content. As has been pointed out, certain primitive bacteria, certain primitive plants, and certain primitive animals persist in vast numbers today in practically the same state of development their ancestors had reached a billion years ago.

Also at the present day the majority of the people of the earth are making no strenuous effort to progress. Those who have adapted themselves to modern conditions sufficiently that they have an ample living and can raise their children in comfort and give them the conventional schooling, as a rule make no effort to advance farther. But there are a few individuals who never are content to reach a static stage. There are a few individuals with tremendous ambition to express themselves more fully, and who develop their natural aptitudes far beyond the average level. The important inventions, the great scientific discoveries, the new ideals, and the leadership of mankind in economic, political and humanitarian progress are the work of comparatively few individuals who, irrespective of economic security, are unwilling to drift with the tide.

From our study of their birthcharts we know that these exceptional leaders were born, not from any different hereditary stock than others—for seldom is there more than one genius in the same family—but at a time when the inner plane weather mapped unusual natural aptitudes. This means that their experiences in lower forms had given them a thought cell organization quite different than that of the average individual. This exceptional thought cell organization was mapped by the inner plane weather coincident with their birth.

The other factor of significance is that subsequent inner plane weather gave additional energy to the thought cells endowing them with these aptitudes, and thus gave them the psychokinetic power both to develop the natural aptitudes into special ability, and to attract into their lives the physical conditions that permitted them to use these special abilities in a manner that assisted in the progress of the human race.

Heredity

—The nucleus of the reproductive cells carry filament like chromosomes, which in turn are made up of bead like strings of smaller bodies called chromomeres. The chromosomes, which in each species are of a definite number, are thus composed of many hundred bead like bodies, the chromomeres, strung together in a very definite order. These chromomeres not only are the physical carriers of heredity, but in a given species of animal each bead in the string always governs some particular characteristic, and always occupies the same position in the string. The hereditary characteristics which are carried by these chromomeres are called genes.

In the union of germ cells of higher plants and higher animals, as in the union of two protozoa, when the cell divides after fusion each resulting cell contains chromosomes derived from both parents. The offspring thus obtains half its chromosomes from the mother and half of them from the father. One string of genes is supplied by the mother, and one string by the father, so that for every hereditary characteristic there are two beads, one of the pair furnished by each of the parents. Each member of any pair of genes, one of the pair being furnished by each parent, thus always has the same general function.

This doubling of the genes is nature's insurance against defectiveness; for commonly if one member of the pair is defective, the other sound gene has strength enough so that no defect appears in the offspring. The normal gene, because of its strength to impress its qualities on the offspring, is called dominant; and the defective gene, because it has much less power to influence the offspring, is called recessive. How from the combinations of dominant and recessive genes offspring inferior to both parents, offspring like superior parent, offspring like inferior parent, offspring superior to both parents, and genius may be born to the same parents is explained in lesson No. 167.

These results are in conformity to Mendel's Law, which has a purely physical basis. But why certain chromosomes pair in one mating and other chromosomes, with dominant and defective genes different, pair in another mating is determined by the desires of the parents exerting a psychokinetic effect upon the germ cells as they thus unite.

But entirely apart from the chromomeres or genes that thus pair to continue hereditary traits, changes in the physical beads on the chromosome string often change the characteristics of the offspring markedly. These radical changes from the characteristics of any of their ancestors are called mutations. Such mutations are now induced by plant breeders for the purpose of developing new species.

A mutation exhibits some characteristic different from any in the ancestry of the individual displaying it, which breeds true. It once was thought that mutations were fortuitous changes issuing from heritage, but in recent years it has been found possible to increase their appearance by treating breeding stock with X rays, radium,

heat and other environmental factors. As there are radioactive minerals in the earth in certain regions, these radiations are probably responsible for physical changes in the hereditary genes which gave rise to important mutations in the past.

In addition to mutations, now that experiments with colchicine has demonstrated that acquired characteristics can be inherited, it must be taken into consideration that if the parents were successful in changing either structure or habits sufficiently to meet new conditions, some of the offspring would be likely to inherit the same traits. Furthermore, not only heat and other external environmental conditions are capable of producing mutations, but in like degree so is the inner plane weather.

The glands of internal secretion manufacture complex hormones from materials which they get from the blood and lymph. These hormones are released into the blood by nerve impulses. These nerve impulses which thus release the hormones may have their origin in the objective mind, in the desires and emotions of the unconscious mind without any objective awareness of them, or be stimulated by progressed aspects which constitute the chief inner plane weather affecting an individual.

That a given hormone commonly is released in unusual abundance in human beings during the time a certain planet forms a progressed aspect has been thoroughly demonstrated. In fact, such endocrine reaction is one of the outstanding observed factors upon which Stellar Diagnosis is based. The other outstanding observed factor is the thousands of statistically analyzed birthcharts and progressed aspects of people who have suffered from given diseases. And these hormones, which have been proved to be so susceptible to the influence of inner plane weather, determine the size, shape and texture of the body, make for intelligence or its lack, give courage or cowardice, imbue with ambition or saturate with laziness, and in general force the given attitude toward life.

Thyroxin deficiency, for instance, in a child produces a condition in which it fails to grow. Except the skull, the bones and cartilage fail to develop, the abdomen projects, the skin is rough, dry and bloated, the temperature is low, the hair is thin, the nose is flattened, and the hands and feet are clumsy. If the thyroid gland is removed from a tadpole it grows to large size but never becomes a frog. On the other hand, a tadpole less than a day old may be transformed into a frog by feeding with thyroxine. It will retain its small size, but will have all the characteristics of a mature frog. Tadpoles and rats given the growth hormone of the front pituitary gland grow to huge size. When at puberty the gonad stimulating hormone of the front pituitary gland which responds to Pluto fails to increase its secretion, an adolescent boy becomes excessively fat with folds of tissue around his girdle and with prominent breasts, and his sexual organs remain infantile.

Without indicating the physiological changes that other endocrines inaugurate when in excess or deficient, it will be apparent that astrological energies through thus stimulating or depressing the secretion of various hormones can exercise a powerful influence over structural changes of a life form. And it will be apparent that through

influencing these secretions the soul has at its disposal agents through which important physiological changes intensely desired can be brought about either in itself or in its offspring. Any such marked progress of its own can be handed down through heredity to its progeny; and any change far beyond its power to bring about in its own physical structure, through mutation due to a variety of influences can be brought about in some of its posterity.

But it should not be concluded that each effort of this kind results in progress or the desired adaptation. Even as the diffused primal sense of touch became canalized and specialized, so extrasensory perception by which the unconscious mind of creatures apprehends things on the inner plane, to become serviceable must have exercise in effort and discrimination. Both it and psychokinesis in the lower forms of life are much like the faculties of a child soon after birth. The child sees something it wants. But as yet its experience has not taught it how to reach for the desired object or if it is at a distance how to walk or crawl to it. But it does make random movements, and when these random movements bring success it learns how to touch the things within reach which it wants, and later how to move to a desired object at a distance.

When it is stuck by a pin in its diaper it does not know how to remove the pin. But it thrashes about and yells, and as a result its attendant searches to find what the difficulty is and removes the pin.

And in much the same manner a life form dimly sensing changed environmental conditions and impelled by the desire to survive, uses its psychokinetic power in a haphazard manner. Most of the improvisations better to adapt itself or its offspring to the changed condition even as most of the experiments of a scientist in trying to make a new discovery or of an inventor trying to devise a new gadget result in failure. The record of the rocks reveals innumerable changes in form and function which have proved successful only for a limited period and then in the long run have proved disastrous. One after another life form has moved up a blind alley only to be stopped by a wall it could not surmount.

But a few of these attempts to adapt to new conditions have been successful. And these life forms have continued, and their progeny have made further useful adaptations, so that the line of progress unbroken still continues. It moved upward until it reached the form of man, a miniature copy of the universe. Then it continued upward, not through further development of form, but through progress in knowledge.

Cooperation Between Plants and Animals

—But even forms of life lower than man have not confined their efforts to survive, to reproduce, and to express more fully, to changing form and function. Even as man makes use of other life forms so plants often make use of animals and animals often make use of plants. Plants in general found it of great advantage to reproduce by means of seeds instead of spores; and they found it a further marked advantage when

the male element from one flower could find its way to the female element of another flower and thus prevent inbreeding. Consequently, the plants, using such inner plane intelligence as they possessed, sought how this vitally important cross fertilization might be accomplished.

The first expedient was to use the wind and water to carry the fine grains of pollen, which contain the male sexual element, to adjoining, or distant flowers. To insure pollination in this hit or miss manner, however, required great quantities of pollen; for much is sure to be wasted. Therefore, as insects were in the habit of visiting the plants, which they used for food, the expedient gradually was adopted of using these insects to carry the pollen from one flower to another.

The problem then arose of making sure that insects would come to the flower. This was solved by secreting a substance, such as the nectar found in most flowers, that would serve the insect especially well for food. Next the problem arose of attracting the insect from a distance. This was accomplished by coloring the flower, or by giving it a pleasing odor, that might be noticed by the insect at a distance. The color of a flower, and its odor (unless this is offensive and used for protection) have been developed for a single purpose and no other; to act as advertisements that a banquet awaits the particular insect best suited to carry out its cross fertilization. These advertising banners have been subject to a special evolution. Thus the most primitive color for a flower, aside from the original green, is yellow. Later, plants developed red blossoms, and finally, as the very latest color scheme, and one that is recognized farther than the others, the blue and violet colors have been evolved. In some way, although not exactly in the way we discern colors, but perhaps by perceiving degrees of brilliancy, insects are able to distinguish the blossoms of their favorite flowers at long distances.

With the problem of attracting insects solved, the next step was to make absolutely certain that the insect securing the repast of nectar should pay for its meal by being dusted with pollen. Gradually an infinite number of cunning devices, in the form of differently shaped corollas, were evolved. Flowers that originally had numerous petals, and numerous pistils and stamens, securing fertilization in some few by sheer numbers, reduced the number of parts in favor of some shape that would permit the insect to enter, but which also insured that it carried away pollen. All the innumerable forms of our bright colored flowers tubes with little landing platforms, hoods, sheaths, and what not have been evolved in response to the plant's intense desire to compel the insect upon which it depends for cross pollination to carry pollen from the male portion of one flower to the female portion of another flower.

All those plants, then, that have small greenish inconspicuous flowers, like the grasses, depend upon the wind for pollination. The bright ones invariably depend upon insects or birds. Nevertheless, some that in the past depended on insects have now devised an unusually fine, light pollen which is produced in enormous quantities. At the time of bloom the air for miles around is full of this minute pollen dust. These plants, of which the goldenrod and ragweed are typical examples, are finding this new method even superior to depending on insects. They are, therefore,

abandoning the use of insects and returning to the use of wind, being now in the state of transition.

The problem of dusting an insect with pollen solved, the next thing was to make sure that the pollen would be deposited not on the female part of the same flower, but on the female part of some other flower of the same species. This objective is attained in many unique ways. For instance, the little filaments, or stalks, of the stamens of the cornflower, when touched, contract and draw instantly down over the stigma, or female part, protecting it; yet at the same time exposing the pollen on the anther to the insect which has touched it. The diplacus, or monkey flower, common on our California hills, has a stigma of two flat lobes that snap together tightly when touched. The stigma is placed so prominently that an insect visiting the flower is sure to touch it when alighting. It snaps shut on the pollen dusted from the startled insect, and the insect then gets covered with the pollen from the anthers of this flower with no danger that any of it will find its way into its own stigma.

To insure that they shall not be fertilized by their own pollen, the pollen of many flowers ripens only at a time, either before or after, when the stigma is not yet able to receive pollen. The larkspur has still another device. It bends down certain of its stamens on different days, so that if the bees that visit it do not on one day visit and fertilize other flowers with its pollen, those that visit it several days after this get still another load of fresh pollen. The larkspur, too, belongs to the buttercup family, and practically all of our wildflowers and garden flowers are thought to be descendants of a primitive buttercup. This early buttercup had numerous petals, numerous pistils, and numerous stamens; which were gradually sacrificed in the interest of greater efficiency. The modifications, in each instance, were toward securing pollination through the aid of some special insect or bird.

The hummingbird sage, common about Los Angeles, has developed such a long tubed corolla that few insects can reach the nectar in the bottom. It is a favorite flower of the hummingbirds, however, which its crimson blossoms attract from long distances; and it depends chiefly upon these for carrying its pollen. Other flowers depend upon bees. Here another problem arises; for if a bee visits one kind of flower and then another kind of flower, the pollen so carried will not fertilize. The pollen from white clover, for instance, will not fertilize the buckwheat flower which next may be visited. In this case it is the bee that has learned something; for as plants have progressed, so have the insects that live upon them progressed in parallel manner. Bees are absolutely dependent upon nectar and pollen for food. It is to their advantage that flowers shall be pollinated properly, thus providing for new plants to blossom the next year. And it has been definitely determined that bees do not indiscriminately visit different kinds of flowers. During the work of a morning a bee will confine its attention to one kind of flower. It does this even though it visits different colored flowers of the same species. On the next day it may turn its attention to a different species of flower, but it is too good a gardener to mix the pollen of a daisy with that of a dandelion.

Flowers that open by day depend upon day flying insects. Those that open at night depend upon insects that fly by night. Those with the nectar in short tubes depend upon bees and small insects. Those with long tubes depend upon butterflies and insects with long probosces. The red clover, for instance, depends entirely upon the bumble bee. Efforts to raise red clover in New Zealand were a failure until some naturalist suggested importing bumble bees. Plenty of bumble bees insured proper pollination and made the venture a success.

One might write on indefinitely of the manner in which flowering plants and insects have helped each other solve the problem of life and progress. One might write on indefinitely of the shrewdness of insects, such as the common harvesting ant of South Europe, which collects the seeds of clover like plants, lets them sprout until they burst, then exposes them to the sun to prevent further germination, after which it carries them under ground. Still later it chews them into dough and makes them into little biscuits which it bakes in the sun. These it then stores for winter use. Such wonderful habits, which in many cases parallel the efforts of humanity after reaching some degree of culture, are the outcome of extrasensory perception combined with experiences stored as knowledge within the soul, directing psychokinesis in response to the desire to live and express more fully.

Fishes Were the First Truly Vertebrate Animals

—Now moving back in time before there were any land plants and before there were any insects, in the Archeozoic era there were only single celled animals and single celled plants. Then came the Proterozoic era, which commenced about a billion years ago, and during which invertebrate animals developed innumerable forms which dominated the world. Following this was the Cambrian period of the Paleozoic era which commenced about 550 million years ago, during which the trilobites became the dominant life form. These are segmented animals belonging to the phylum Articulata, having for ancestors the segmented worms. They are primitive crustaceans, and other crustaceans like the lobster, crayfish and shrimp developed from them. The trilobites are the transitional form between the segmented worms and the insects; for after land plants developed the descendants of the trilobites took to the land to get a food supply and gradually became insects as we know them.

But before the trilobites, undoubtedly there were segmented worms. Let us now, therefore, visualize a world covered with shallow seas and lakes, crowded with innumerable kinds of invertebrate life. Then let us imagine the condition, as actually transpired, when numerous land areas the world over commenced to rise. Instead of placid lakes, large areas tilted up to form highlands and were drained by swift flowing rivers. At the same time the lake and sea expanses, already crowded, were greatly reduced in area and forms of life that had found a living there were sorely pressed for food. Many such forms finding the competition too keen died out and became extinct. But other more progressive kinds tried to adapt themselves to the new condition by finding a habitat in the rivers.

Rivers have a persistent and rather rapid flow of water in a fixed direction. To be able to live in a river, and not to be washed down it and out to sea, an animal must either have some means of clinging to the bottom or some means of locomotion sufficiently effective to overcome the current of the stream. Except for certain minor instances there are only three large groups of animals that have solved this problem. Some of the mollusks, like the mussel, are able to crawl along the bottom through firm contact with it. Certain crustaceans, like the crayfish, can crawl along the river bottom by means of many sharp claws that they hook into the river bed. The fish solve the problem by a mode of propulsion through the water.

When the segmented worms took to a life in the river to escape their numerous enemies and to find food, they found that the position enabling them best to meet the current is to keep the head directly upstream. They found also, by degrees, that a rhythmical undulation, similar to that of grass growing in the stream, is the movement best suited to overcome the momentum of the current. A fish moves by alternate rhythmical contractions of the side muscles, so that the pressure of the fish's body is brought to bear, first on one side and then on the other side, against the water of the incurved section. Such motion is not possible to most invertebrates of the sea; for usually they have compact or rotund bodies that make them sluggish. But the segmented worms had a suitable linear form, and already had a bundle of fibres running lengthwise with a nerve chain enclosed in a sheath. This was the commencement of a lengthwise supporting tissue that would prevent the shortening of the body due to the pressure of the water against the head.

There developed, therefore, such creatures as the enteropneusts, which are vertebrate like worms. They have numerous gill slits opening from the pharynx to the back surface of the body, and a body cavity similar to true vertebrates. They live at present off the coasts and eat their way through the sandy mud to get the small organisms living in it. A somewhat further development from the segmented worms is shown in the sea squirt. It begins life as a free swimming larva, like a small tadpole, with a brain and spinal cord, a notochord, or primitive vertebra, a brain, eye, and a heart. It fastens itself to a small shell or stone, and then degenerates rapidly as it reaches the adult state. Next above these come the lancelets, such as *Amphioxus*, that are found in most seas. They have no skull, no jaws, no limbs, no brain, no heart, and no eye; but they do have a spinal cord, a notochord, and gill clefts. They are translucent spindle shaped creatures about two inches long that are believed to have a worm ancestry, but which have developed the ability to swim with some speed.

A still more advanced transition type between segmented worms and true fishes are the round mouths, such as the lampreys and hags. The lamprey looks something like an eel, but has no jaws, no limbs, and no scales. It does have, however, a gristly skeleton, something of a skull with horn like teeth, and a number of gill pockets. Some live in fresh water, and some live in the sea, ascending the rivers to spawn. The hag is another eel like creature, one, the *Bdellostoma*, living off the California coast.

The first truly vertebrate animals were the fishes. These vertebrates are the group embraced in phylum XII, the Chordata. They have several distinct characteristics

that separate them from all other forms of life, and as all the higher animals, including man, belong to this group, it may be well to mention these characteristics. In the first place, in the earlier forms there is a notochord, or primitive backbone, running lengthwise of the body, serving to stiffen it, and thus prevent the shortening of the body which otherwise would take place when the muscles are contracted. This notochord is composed of membranous connective tissue. In more advanced forms it is formed of cartilage. And in those forms still higher it becomes a bony vertebra column.

A second characteristic of all vertebrate animals is the development of gill slits through the walls of the throat cavity. We have already seen that these gill slits are present in the vertebrate like worms. They are obvious in the true fishes, the gills being surfaces of considerable area where the blood is exposed to the oxygen contained in the water and respiration accomplished. In the mammals, including man, several pairs of gill slits are always well defined in the embryo, but as the form develops they are modified until a single pair are left, and these are no longer used for respiration, but form the eustachian tubes which connect the middle ear with the throat cavity and thus equalize the air pressure on either side of the ear drum.

All vertebrates also have a spinal cord, are usually segmented, and when paired limbs are present there are never more than four.

Most scientists believe the first fishes probably were not bony, but were gristly, with a mouth on the front side, like the sharks of today. Dr. W. K. Gregory, however, has advanced a theory according to which the Ostracodermi, which are fishes with an armor of large bony plates around the head, were the first vertebrates. Up to the present time no fossils of the earliest true fishes have been found. The earliest fossil fishes had traveled a long way along the road of vertebrate progress. The mentioned Ostracodermi left their fossils in the Middle Ordovician rocks, formed about 445 million years ago near Canon City, Colorado, in the Big Horn mountains of Wyoming, and in the Black Hills of South Dakota. The Ordovician period is the period immediately following the Cambrian period in which the trilobites dominated the earth. Before the Cambrian, in the rocks of the Proterozoic era, which commenced about one billion years ago, there are traces of one celled marine animals, the radiolarians, with shells of flint that could be preserved. And there are also traces of worms that burrowed in the mud; for these burrows are sometimes preserved as fossils. But with the coming of Cambrian times the seas and shores the world over began to swarm with sponges, jellyfishes, crustaceans, worms, lamp shells and mollusks.

Certain of these mollusks, the cuttlefishes, dominated the sea during the Ordovician period. They were fierce predatory creatures, even as is the octopus at this day, but their place as masters of the sea was disputed by the true fishes that developed at this time, and they finally had to yield to them. These first fishes were fresh water fishes, and it is thought that the habit of many marine fishes today, such as the shad, sturgeon, and salmon, of leaving the sea and ascending rivers to spawn is the following of a custom established early in fish history. After developing locomotion,

and the typical fish form, the fishes were better adapted not only to a life in swift moving streams, where they had their origin, but to water life in general. As a consequence they sought out every available nook of lake, sea and river, and so modified their structure as to make them specially suited to survive in the chosen habitat.

Intelligent Adaptations

—Space will not permit of even a superficial enumeration of the various wonderful adaptations accomplished by fishes. Many are quite unique, such as the one called “the angler” which has a fishing rod and tempting bait which it dangles in front of a cavernous mouth lined with teeth that are hinged at the base so as to bend backwards, permitting other fish to enter but quite preventing their exit. The eggs of the sea horse are placed in a skin pocket bringing to mind the skin pocket of the kangaroo where they are sheltered until developed. Some fishes also make nests, anticipating the birds in this respect. The stickleback, for instance, makes an elaborate nest of leaves and stems of water plants which he sticks together with glue like threads which are secreted at this time by his kidneys. This nest has two doors, and by coaxing and by using a certain amount of force, he persuades one female after another to pass into the nest by one door and out of it by the other, depositing her eggs in the nest as she goes. After this he sets himself to guard the nest, and drives away all other fishes that approach. After the young are hatched he is kept very busy herding the little ones together and keeping them out of danger until they are old enough to shift for themselves. This he does with the utmost diligence and solicitude.

Another male fish, the scientific name of which is *Semotilus Atromaculatus*, takes stones from the bottom of a stream, gripping them in his mouth, and builds them into a dam. Below the dam he builds an egg depository of stones so formed that the eggs when deposited by the female are held in the spaces between the stones, thus protected from other fish, and kept from being washed out by the dam just above them. Innumerable other examples of extrasensory intelligence as exhibited by fishes might be cited, but these two no doubt will suffice to show that the intense desire of the soul, even the soul of a fish, at times is able to find a means to the sought for end.

I have mentioned that the earlier fishes had a gristly structure and that those more developed had provided themselves with a bony skeleton. But there is yet another group of fishes that now needs to be mentioned. These are the Dipnoi, or double breathers, represented by the bony pike in the United States, and by the lung fishes of Africa, Australia, and South America. These lung fishes live today in regions where the lakes and ponds at one season of the year dry up. No doubt, in answer to the desire to survive in such an environment, fish were developed with the air bladder connecting with the gullet. In other fishes the air bladder serves as a means by which the fish rises or descends in the water, expanding the sack to rise and compressing it to sink. But in the lung fishes, when the pool in which they are living dries up, it is used as an accessory apparatus by which the blood is given oxygen from the air.

These lung fishes can successfully weather long periods of drought.

There is also a fish, the “climbing perch”, which abounds in fresh water throughout the Malay countries, Ceylon, India and Burma, that has the habit of leaving the water and traveling across the land, even over high hills and broad prairies, not infrequently climbing up trees on the way, to other water. This fish carries water in chambers of its head for the purpose of breathing. There is also a climbing catfish in the upper Andes of South America.

In an environment such as the present African mud fish live in, where the dry season lasts nearly half the year, a great premium is placed upon the ability to breathe air, and also to move about on land; for the water completely dries up. The persistent desire to survive and express more fully brought psychokinesis into play and undoubtedly developed the first amphibian, or land vertebrate, from the lung fishes.

In the Ordovician period the first fossil fish are found. In the next period, the Silurian, are found primitive scorpions, some of immense size; and it is quite certain that some of these took to life on the land; the segmented worms probably accomplishing this at an even earlier date. The oldest fossil amphibian is the footprint of *Thinopus*, found in the period following the Silurian, the Devonian period, which commenced about 350 million years ago. During this period, also, for the first time, flowering plants became established.

The next period after the appearance of the amphibians is the Carboniferous period, embracing the Mississippian and Pennsylvanian, during which the great coal marshes were laid down. Unlike the Devonian period, which was marked by aridity, there was a mild, moist climate that encouraged luxurious vegetable growth on low, swampy ground. This vegetation was mostly club mosses and horsetails that grew to immense size. Their spores and other debris is the source of the present day coal supply. The first fossil insects are found in the same period and undoubtedly the land swarmed with them. They provided certain cross fertilization for the flowering plants that had now become established, and they became a food supply for the amphibians which followed them over the land. It was no doubt at that time that the flowers first began to gain their colors and attract insect visitors. There were also land snails at this time. But perhaps of chief importance were the amphibians, some of which grew as large as a donkey.

The paired fins of the lung fishes, in response to the desire to facilitate eating, were gradually or perhaps more abruptly developed into limbs with fingers and toes, by which things might be grasped and food placed in the mouth. There was the development of an ear of three chambers, a movable tongue, true lungs, a drum to the ear and lids to the eyes, none of which a fish has. Furthermore, for the first time there was developed a voice. At first the voice served as a sex call, as it does today with our toads, hylas (tree toads), and frogs. The piping and croaking of these amphibians, so noticeable in the spring of the year, are love calls. As higher forms of life developed the voices came to be used to express a call for help, to convey the notion of danger, and to express other emotions.

The amphibians, represented by our frogs, newts and salamanders, are air breathers in the adult stage. They must return to the water to lay their eggs. The young are hatched in the water, and pass through a fish like period of infancy, breathing by means of gills. They thus, in the early stage of their lives, recapitulate their development from fish ancestors. Every schoolboy is familiar with the tadpole that lives in the water and later absorbs its gills and tail, gains four legs, and transforms into a frog or toad able to travel and live on the land.

The Record of the Rocks

—I have already been compelled to use geological eras and periods to designate the time in the earth's history when certain forms of plants and animals first developed. It will be well, therefore, before going further, to explain how we know the comparative ages of these periods, and how we know that certain life forms first occurred at stages of the earth's history corresponding to them in time.

We have all watched, during a rain, the tiny rivulets running down a hillside, cutting little gutters in the soil and carrying sand from the hill to a creek, thence into the river, and finally to the sea. This process is going on yearly, and at times great rivers go on a rampage and in a short while cut down their banks and carry great quantities of mud and sand into the ocean. Creatures that have died during such a flood often are carried into the sea and buried beneath the sand and mud. As time flows on they are buried deeper and deeper, until a great quantity of material lies above them.

This material is compressed and hardened by the accumulating weight above it until the sand becomes sandstone and the mud becomes mudstone or shale. If the creature thus buried has a bony skeleton, or other hard parts, and is buried in a deposit of lime forming near the shore, or in mud so that air and water cannot reach it, these hard parts are preserved in the forming rock as fossils. Sometimes, also, insects are caught in the resin exuding from trees, and encased in it. These trees then may be torn from the banks of streams by a raging torrent and buried in the mud. The mud then becomes stone, preserving the tree in it, and the resin turns to amber which encloses and effectually preserves even delicate insects. Volcanic dust occasionally overwhelms insects flying above shallow pools of water, bearing them down into the water and covering them with a layer of powdered stone that solidifies, encasing them in a hard shroud that effectively preserves them. They then become fossil insects.

The process of erosion, and deposition of sand and mud in the sea, is not uniform, but periodic. At more or less regular intervals great quantities of silt are deposited, and at other periods there is very little. Thus the sand and mud is laid down in layers; for deposits of one period often harden somewhat before the deposit of the next period is put down. The succession of layers is easy to determine, as one will learn by watching the fan like deposits of a hillside rivulet when it fails to reach a larger stream and must drop its load. Every rain increases the thickness of the deposit by one layer, and this new layer is always laid down on top of the layer previously formed by

the preceding rain. The oldest layer of sand and mud always is on the bottom and the newest always on top. Thus it is also with the mud and sand laid down in the sea. Those layers on the bottom are the oldest, those next above these are next oldest, and so on, until the top layer is reached, which is the newest.

If fossil remains are found in the oldest strata, those creatures were buried at the time the oldest layer was laid down, and must have lived at that time. If other creatures in a fossil state are found several layers up from the bottom, these creatures were buried at a later date than those buried in the bottom layer, and consequently lived at a later date. Those found buried in the top layer were buried at the very latest period during which the deposit was formed, and thus must have lived at the latest time during which the deposit was formed.

All sandstones and shales and other sedimentary rocks were formed by being laid down as fine material in water and later solidified by pressure. They form definite layers, one above the other, and even though at a later date these layers are tilted up by the elevation of a portion of the area they cover into hills, the order in which they were laid down is not difficult to ascertain if cuts have been made through them. Furthermore, the layers laid down at different times vary, not only in the kind of life found fossilized in them, but also in their structure and mineral composition, so that it becomes possible for one skilled in such work to say with great precision just which of these layers of sedimentary rocks are oldest, which are next formed, etc.

The various layers of rock that were formed by sedimentary deposits in North America have been carefully measured. Their combined thickness is estimated by some authorities to be as much as 67 miles, but an average of the estimates of the various authorities gives their total thickness as 53 miles. Most experts believe this to be very close to the correct figure.

It should not be thought, of course, that in any one spot the sedimentary rocks are 53 miles thick. This is the thickness of all sedimentary rocks in all localities that have been deposited at different times. In Ontario, Canada, the sedimentary rocks are 18 miles thick, but throughout one third of North America whatever sedimentation there was has been eroded away, leaving igneous, or crystalline rocks at the surface. And it is known that at the present time it takes 8,600 years to denude North America one foot. The igneous rocks left bare by erosion and the tops of the Sierras in California are thus bare, such gold as their previously overlying sedimentary rocks contained having been carried down the streams to be found in part by those who stampeded west in 1849 have cooled to their present state from a molten or plastic state. Over the balance of North America the sedimentary rocks are from one mile to twenty miles thick; perhaps but one eighth of the area along the troughs adjoining such mountains as the Appalachian and Rocky mountains attaining the greater thickness.

These layers of rock have certain structural characteristics by which they can be recognized. The order in which they were laid down has been determined by careful study of the relative positions of their layers. For convenience in speaking of them the whole system of rocks has been divided into five great groups classified

according to age. The great groups are called eras, and are each divided into several periods.

The rocks of these five geological eras have been carefully measured. The earliest era, the Archaeozoic, commencing about 1,750 million years ago and lasting about 750 million years, consists of 9 miles of limestones and 9 miles of mud and sand stones. The next era, the Proterozoic (sometimes called the Algonkian), commencing about one billion years ago and lasting about 450 million years, consists of one mile of limestones and 13 miles of coarse mud and sandstones. The rocks above these are the Paleozoic, which commenced about 550 million years ago and lasted about 360 million years. It consists of 3.4 miles of limestones and 4.6 miles of mud and sandstones. Next higher is the Mesozoic, which commencing about 190 million years ago lasted about 135 million years, and embraces 1.25 miles of limestones and 6.25 miles of coarse mud and sand stones. The latest era, the Cenozoic, which commenced about 55 million years ago and lasted about 55 million years, consists of 5 miles of coarse mud and sandstones. The other half mile to make up the 53 miles of thickness consists of small and undetermined formations.

Chapter 5

Serial No. 129
Original Copyright 1949
Elbert Benjamine

Copyright
August 2002
Church of Light

Reptiles and Birds

Recorded in the Rocks

Years Ago	Era or Period	The Record
1,750,000,000	Archaean	First record of bacteria.
1,350,000,000	Archaean	First single-celled plants.
1,250,000,000	Archaean	First animals- protozoa.
1,000,000,000	Proterozoic	First record of marine algae, worms, sponges, crustaceans.
550,000,000	Cambrian	Record of main invertebrates.
440,000,000	Middle Ordovician	First vertebrates-fishes.
440,000,000	Middle Ordovician	First land plants.
410,000,000	Silurian	First air breathers; scorpions.
410,000,000	Silurian	First lung fishes.
350,000,000	Devonian	First record of amphibians.
350,000,000	Devonian	First record of flowering plants.
300,000,000	Mississippian	Abundant sharks.
255,000,000	Pennsylvanian	First record of insects.
255,000,000	Pennsylvanian	First indication of reptiles.
215,000,000	Permian	First metamorphosed insects.
215,000,000	Permian	Indisputable reptile records.
215,000,000	Permian	Indisputable records of modern fern and conifer trees.
190,000,000	Triassic	First record of dinosaurs.
170,000,000	Upper Triassic	Record of flying reptiles.

Chapter 5

Reptiles and Birds

CHROMOSOMES, as the physical carriers of heredity, have already been considered. And before their discovery two other laws of heredity had been found that need mention. One is Galton's Law, purporting to show that $\frac{1}{2}$ the qualities of an individual are derived from its parents, $\frac{1}{4}$ from its grandparents, $\frac{1}{8}$ from its great grandparents, etc. The other is Mendel's Law, indicating how inherited characters are distributed, and that the fundamental cause of this distribution lies in the germ plasm. This law was worked out by Mendel on peas, and later by others on rabbits, guinea pigs, fowls, beetles, and silkworms.

It shows that inheritance is through unit characters—which has now been verified by a study of genes (lesson No. 167)—and that while it cannot be predicted what proportion of white and black will appear in succeeding generations from mating white and black individuals, yet once the proportion is known, it may be used with certainty as the basis of future production. Thus if in mating a white and a black $\frac{1}{4}$ of the offspring are found to be white and $\frac{3}{4}$ black, it may confidently be expected that again in mating white and black of the same species the same proportion of white and black will appear in the offspring.

But in order for a new species to be formed it is necessary that some of the offspring show marked tendencies that neither of their parents had. The mechanics of these sudden appearances, called mutations, has been explained in previous lessons. It is enough here to point out that whatever change of structure or functions such a mutation possesses is handed down to its progeny through the indicated laws of heredity.

Natural selection, which was given detailed study by Darwin, is based upon the principle that those creatures that are somewhat better fitted to live in a certain environment survive, and those less fitted perish. Furthermore, for the same reason, an organ or a function that gives an individual an advantage, and therefore makes him more able to survive than his fellows who do not possess the organ or function, is preserved and passed on to his offspring.

The offspring, then, by virtue of their superior adaptability, live and propagate, while less fortunate forms of life that compete with them for food and life become extinct.

Due to the prolific tendencies of nearly all life forms, there is available space and food on earth for only a very small proportion of those that are born. As a consequence of the limited area and limited food supply, there is a bitter competition between the limitless forms for possession of this space and food. At the date of this writing (1949), for instance, Milton S. Eisenhower, president of Kansas State College, states that only 11 percent of the world's land can be used for food production—a total of 4,000,000,000 acres. As there are about two-and-a-quarter-billion people now living, this means there is less than two acres available for each. Yet it takes not less than two-and-a-half acres to raise enough food for one person. Eisenhower makes the flat statement that today more than two thirds of the people of the world do not get enough to eat.

But considering physical life as a whole, the competition for space and food is in three different directions: First there is the struggle between different species. Of two species deriving their food supply from the same source, or occupying the same territory, the one most suited to that particular environment will survive and leave offspring, and the other will perish.

This principle is well exemplified in the struggle between sheep and cattle in the western United States. Cattle once thrived in vast number on the broad western ranges. There was plenty of food, and they multiplied rapidly. Then came the sheep. These could bite the grass clean to the roots, as well as live on brush and other unpalatable fare. They also left an odor where they passed that is disgusting to other herbivorous animals. Thus the cattle were forced out, for they cannot live where sheep thrive.

The owners of the cattle and the owners of the sheep then took up the struggle. The cattlemen, for a time, were greater in number and were skilled in the use of firearms. They realized that cattle could not compete with sheep, and made the issue in several sections of the West a war between cattle men and sheep men. This struggle later was carried to the courts, and finally to the legislature. Sometimes the victory has been with one and sometimes with the other, but the struggle is due to the fact that sheep have developed more ability than cattle to survive when there is keen competition for food.

Next, there is keen competition between the individuals of a single species. This is inevitable, because the rapid rate of multiplication, if unchecked, soon fills all available space and becomes greater than the food supply. Our two worst pests—because they carry deadly bacteria and deadly protozoa to the human race—the housefly and the brown rat, for instance, multiply at an enormous rate. It has been calculated that the offspring of a single pair of houseflies, if they all lived and reproduced and these lived and reproduced, would in a season be so numerous that their mass would be larger than the whole earth. The offspring of a single pair of brown rats, if all reproduced and none died, in a single year would number one million. It will be seen that at such a rate of multiplication there soon would be no food left, even though flies and rats had no other competing species to reduce their food supply.

We also see this competition between members of the same species in the circle of our human acquaintances. There is a struggle for money, for honors, and for special privileges. Some have millions of dollars and some have none, nor can find opportunity to earn their daily bread. We call ours a civilization, but surely it is not that so long as it deprives a single willing person of the opportunity to work for enough food to live. War, too, a barbarous ancient institution, is the direct result of this competition between individuals who have grouped together for mutual advantage. But the problem of the individual's food supply and the problem of war cannot be solved by any amount of sentimentality. They can only be solved by a discriminating use of carefully collected biological and sociological facts.

The third form of competition, about which considerable will be said later, is the struggle of both individuals and species with the forces of nature. Changes of temperature, in the amount of moisture, storms, and changes in elevation and amount of land areas, all require fresh adjustments of organisms living in a region where such changes take place. The struggle to meet the conditions imposed by environment results in a constant shifting of living things, only those surviving that are peculiarly adapted to the conditions that obtain.

Not only was natural selection given detailed study by Darwin, but Lamarck gave detailed study to adaptation, and de Vries brought to scientific attention the significance of mutations in making successful adaptations which would be retained, through inheritance, by subsequent generations.

Before the significance of mutations was understood it was held that those individuals who developed characters that were slightly advantageous in competition with their associates lived and produced offspring, and that those less well adapted died before reproducing. But there are innumerable developments in life forms that would produce very slight advantage until the new and highly complex structure was fully present. The simple sensitivity to light of the outer covering of a primitive creature, and this covering, or a section of it gradually growing more and more sensitive with succeeding generations, can hardly explain the development of an eye.

The eye could only help markedly in adaptation and survival after it had been fully constructed, and after it had been linked by nerve cells to a sensitive optical center in the brain. Any slow progress in the simultaneous development of these various factors would not have been of much assistance in the animal's struggle for adaptation and survival.

Nature employs both inner plane weather and outer plane weather to prevent life forms from stagnating. Climatic changes compel creatures to change their structure or their habits, or both, or perish. And the record of the rocks prove that the soul activating life forms has the ability thus to bring about the necessary changes. Using psychokinetic power it moves first in one direction and then in another until it finds the correct answer to its problem, even though the answer be highly complex.

Nor is the compulsion to make progress or suffer confined to creatures lower in the scale than individual man. Due to inner plane laws, each person has his own inner plane weather. It is mapped by his progressed aspects. At times this inner plane weather is favorable, and at other times it is severe.

Under progressed squares, semi-squares, sesqui-squares and oppositions, both the mental outlook and the outer plane conditions change. Difficulties enter the life that require the utmost effort to surmount.

The changing inner plane weather insures that the individual will be confronted with one problem after another. If he is to live as he desires, he must find ways of solving these problems. He must develop initiative, intelligence and ingenuity or severely suffer.

The Super Intelligence that permeates all nature, and whose mind has formulated the overall pattern of the universe, has wisely provided that nothing shall stagnate. Even the hardest rocks in time disintegrate. The only changeless thing we observe is change itself.

Within this overall pattern there seems to be opportunity for souls to exercise freedom of choice. They can choose this road or that road, but if the form they occupy strays too far from the broad highway which leads toward the development of those qualities which will be of assistance in realizing God's Great Evolutionary Plan, that form perishes and becomes extinct.

To develop those qualities of character, and those natural aptitudes, which eventually will be of assistance in realizing the cosmic plan, it is necessary that the soul which is being trained to become a useful workman in this vast constructive enterprise should undergo the kind of experiences that will provide that training. Other life forms or men only learn to overcome obstacles, which alone constitutes accomplishment, through encountering obstacles. Each obstacle surmounted adds to the ability to overcome other obstacles in the future. Only through overcoming smaller difficulties does the soul develop the ability to overcome larger difficulties.

The Universal Intelligence has thus provided the necessary obstacles, but not in some whimsical manner, and not as if actuated by human favoritism or prejudice, but chiefly through the inner plane weather and the outer plane weather. As we shall see, life forms on earth from time to time had to struggle and make new adaptations to meet the environmental conditions brought through a change of outer plane weather. And not only is outer plane weather—as a study and application of Course XV, Weather Predicting, demonstrates—influenced markedly by the inner plane weather, but through progressed aspects the inner plane weather markedly influences the individual.

The inner plane weather mapped by progressed aspects brings periods which are lush and easy, alternating with periods in which the individual is called upon to exert himself to the utmost to handle new and adverse conditions. And it is through

learning how to overcome the difficulties which thus are periodically presented that the talents of the individual are developed and he makes progress in character.

But in addition to bringing to each soul just the kind of conditions which it most needs to develop the qualities it should gain eventually to fill its particular job as a workman in God's Great Evolutionary Plan, this inner plane weather has held the progress of life within certain broad boundaries. Life forms that have strayed too far from the broad highway that leads to the development of a form which in itself is a microcosm, or miniature universe, have one after another become extinct. The inner plane and outer plane weather have made it possible only for those forms to continue their progress which have led in the general direction of developing the form of man.

Man, as a universe in miniature, is the climax of physical form and function. But he is not the climax of evolution; for by developed self consciousness he has become fitted to continue the evolutionary process indefinitely after physical life amid the far more advantageous surroundings of the inner plane.

The Carboniferous Period

—Progress had been such that by the Devonian period of the Paleozoic era there were not only land plants, but flowering plants, and not only land insects but vertebrate land creatures. These laid their eggs in the water and went through the early stages of their lives in the water. The earliest record of such an amphibian is the track of *Thinopis antiquitus*, found in 1896 by the late Professor Beecher of Yale, and presented by him to the museum.

The two periods following the Devonian frequently are considered together as the Carboniferous period, which commenced with the Mississippian period about 300 million years ago. They are so grouped because both favored vast and luxuriant vegetable growths. In the Mississippian, or Lower Carboniferous period, the climate changed from the more severe Devonian, becoming mild and moist and highly favorable for the growth of rank club mosses in the low lying swamps. The dominant life at that time were the sharks. They not only were abundant, but grew to immense size. Chiefly they were of the ancient type that fed on shellfish and later became practically extinct. The vegetation of this period in time became coal, and while the first record of an amphibian goes back to the Devonian, the first fossil bones of amphibians were found in the Edinburgh Coal Measures in Scotland which belong to the Mississippian period.

The sixth period of the Paleozoic era, the Pennsylvanian, or Upper Carboniferous period, began about 255 million years ago. Seed bearing shrubs and trees of many species are known to have existed at that time, but their flowers were small and inconspicuous. The mild climate continued, and throughout the swamps the coal plants reached their greatest size. These plants, largely club mosses, were of soft, spongy wood and made rapid growth. They propagated by means of spores, which were carried by the wind, giving a uniform character to the forests all over the world.

These coal swamps formed a suitable environment for spiders, scorpions, centipedes, ancient insects, snails and amphibians. Early in the period insects grew to enormous size. There are fossil cockroaches as long as one's finger, and dragon flies with a 29 inch wing spread. None of these insects, however, had voices, or were much specialized in any direction. The climate and the plants were of a monotonous sameness, and the insects needed little complexity to meet such conditions. At the end of this period, as the climate became more arid, the reptiles developed from the amphibians, as there is direct evidence to show. This was the time in which the great coal deposits were formed through the burial of great masses of swamp vegetation. It is also the period in which the earliest fossil remains of true reptiles have been found.

Once more let us return to the amphibians. As previously mentioned, they must spend the early days of their lives in the water. In this early stage they have gills like fish for breathing in the water, and must secure their food supply there. They are thus well fitted for a climate in which at certain times of the year there are heavy rains that fill the rivers and pools, and at other times of the year there is an arid condition in which the rivers and pools dry up. After their early growth they can live the balance of their lives on the land.

Now toward the end of the Pennsylvanian period climatic conditions in certain sections grew increasingly arid. The pools and rivers not only dried up for part of the year, but it gradually came about in certain regions that they remained dry the year round. Creatures that must lay their eggs and live their early days in the water could find no suitable habitat.

The soul struggling for life and expression was hard put to find some way of meeting and adapting its physical organism to this new situation. Probably innumerable amphibians, trying first this and then that failed. But finally extrasensory perception was able to guide the psychokinetic power in at least one female amphibian to a successful solution of the problem, and she handed on the knack she had acquired to her progeny. The solution took the form of making a more suitable egg.

Additional yolk was supplied to the egg, so that the young might have an ample food supply to nourish it beyond the larval stage and the metamorphosis in which it transforms from a tadpole with gills into an air breathing animal. Henceforth this transformation, which previously had taken place in the water, would take place in the egg before hatching, as it does in the embryo of all higher animals, including man. And to protect the egg better from the inclemencies of the weather, and from drying out, it was provided with a covering, or shell. The gills were lost forever, in so far as the hatched animal is concerned, and no longer did it need to have water in which to lay its eggs. They could be laid in the dry sand and hatched by the sun. Thus the true reptile was developed, many species of which no doubt were adapted to the desert, as they are today, where they live and thrive far from any pond or stream or spring of water.

Cold Weather

—During the Paleozoic era fish were dominant. Its seventh and last period is the Permian period which began about 215 million years ago. It was marked by a drastic change in climate. The land which had risen somewhat toward the close of the Pennsylvanian period continued to rise, so that after the arid condition at the commencement of the period, which was drastic in its way, there followed quickly a glacial age even more rigorous in its cold than the one so recently passed, which was successfully weathered by man.

The higher mountains become, the colder the atmosphere. This is the time of the Appalachian Revolution, in which great mountain chains were forced up in the eastern section of the United States. The ice age of early Permian times, however, started in the Southern Hemisphere. But from there it spread over much of the world. These harsh conditions destroyed the old forms of plant life, that were ill adapted to the cold, and developed hardier stock. The new plants, starting in the Southern Hemisphere because the cold became severe there first, spread northward. They consisted of cycads, ginkgoes, modern ferns, and conifer trees. These became the dominant plants during the Age of Reptiles which was to follow.

This cold period destroyed many of the invertebrate animals, and they became extinct. Those that did survive have changed little up to the present. It was due to these severe winters that the insects, in order to weather the cold and live through a long period in which there was no food, devised the method by which the larva encases itself in a cocoon, in which it lies dormant throughout the winter, to awaken when the weather becomes warm and emerge transformed from a crawling caterpillar into a mature insect with wings. Insects previous to the Permian period did not undergo this important change. They were compelled to devise some way to endure the long cold seasons of early Permian times, and met the situation in this way.

Just how much intelligence does the extrasensory capacity of an insect have? That is a hard one to answer. But here is an example of the exercise of that intelligence which takes place each year in the mountains near Los Angeles.

The southern slopes of these mountains in early summer are spectacular with the tall candle like stalks of Yucca plants white with bloom. They belong to the lily family, but depend for pollination on one particular insect, the Yucca Moth. This moth flies by night to a Yucca flower, collects the pollen from its stamens, and kneads this into a little ball which she tucks under her chin. Then she flies to an older Yucca flower and lays her eggs in some of the ovules in the seed box, being careful to leave plenty of ovules free from eggs so that they will mature into seeds and insure future plantings. Finally she applies the pollen from the little ball she carries to the tip of the pistil, thus insuring that the flower shall be fertilized and that the seeds, upon which her race depends, shall grow. Her larvae, when they hatch, live on the Yucca seeds. She thus

provides for the continuation of her race; for Yuccas do not bear seeds in regions where there are no Yucca Moths.

Dinosaurs Dominate the Earth

—Reptiles first appeared on earth during Pennsylvanian times, developing rapidly and specializing in many different directions during the period of aridity and cold of the Permian. In the layers of rock formed from the mud and sand laid down in the Permian period the presence of not less than five out of the total fifteen orders of reptiles have been discovered; and there is much indirect evidence that six or seven other orders were then present, such as the turtles, beaked lizards, and crocodiles.

Then came a new geologic era, the Mesozoic, which means the age of medieval life. It began about 190 million years ago and is often called the Age of Reptiles, because while both mammals and birds put in an appearance rather early in this era, they were not able to compete with the reptiles but were forced to live inconspicuously. The era is divided into four periods of unequal duration.

The first period of this Mesozoic era was the Triassic period. In the Permian period there were reptiles called cotylosaurs, and from these developed protosauroids. Then in the Triassic period from the protosauroids developed the parasuchia, and finally as modifications of these came the dinosaurs, meaning terrible lizards. They soon grew to be the most formidable and the largest land animals the world has ever known.

Their remains are first found in Middle Triassic formation, representing a time some 175 million years ago. There were other kinds of reptiles during the Mesozoic era, but the dinosaurs dominated all four periods. The imprints of their feet are to be found in the rocks of Colorado, Arizona, Utah and Wyoming as clearly as if they had walked over the muddy ground only yesterday. Some footprints are as much as fifty two inches long. But all became extinct at the close of Mesozoic times. They were giants, and some were terrible. But as colossal as they were, weighing up to eighty tons, they had minute brains and like that of modern reptiles, their blood followed the temperatures of their environment.

The Age of Reptiles, as the whole of the Mesozoic era is called, was a period of calm lasting perhaps 135 million years. To be sure, land rose and fell in different places, and some of the land went beneath the sea and some of the sea floor became dry land. But it was nothing like the Carboniferous period, during which volcanic action was intense and the atmosphere was humid and stifling, storms were almost constant, rain came down in torrents, and the sun was seldom seen because of the heavy clouds. Nor was it like the drastic cold of the Permian period. The reptiles, including the dinosaurs, were able to meet the problems of the more placid Mesozoic era with amazing success.

The first marked progress of the dinosaurs was probably hastened by a semi arid climate which compelled them to travel long distances for food and water. After they first became established, the climate underwent various changes and in response to these changes some of them developed new forms and new habits. In fact, their habits were quite as varied as those of the mammals at the present time. Some of them were no larger than a house cat, but some, like Brachiosaurus, reached a length in excess of 80 feet. Some fed upon vegetation; but some were carnivorous, preying upon the herb eaters. Practically the complete skeleton of one of the carnivorous kinds, Allosaurus, measuring 34 feet 2 inches in length, by 8 feet 3 inches high, was unearthed from Como Bluff, near Medicine Bow, Wyoming, and is now mounted and on exhibit in the American Museum of Natural History, New York City.

The largest of the carnivorous species so far found is Tyrannosaurus Rex. It is 47 feet long and must have weighed as much as the largest living elephant. It stood 18 to 20 feet high, and the hind limbs, which is as common among them supported the weight of the body, were larger than an elephant's. The great jaws were set with teeth an inch wide and from 3 to 6 inches long, and the feet were armed with great sharp curved claws. Being so large it could hardly move with great speed, and probably preyed upon the huge herb eating armored dinosaurs that lived at the same time. These had developed an armor of hard scales, and had horns with which to defend themselves.

There were also smaller carnivorous kinds, such as Ornitholestes, which was unearthed from the famous Bone Cabin quarry in eastern Wyoming. It was only seven feet long, being slender and no heavier than a setter dog. In contrast with the bulky forms, it was fitted for great agility. A common feature of many dinosaurs is that they walked on their hind legs and used their heavy tails as a balancing organ and auxiliary support when at rest. Brontosaurus, one of the herbivorous species, is now mounted in the American Museum of Natural History, measuring 66 feet 8 inches long, with a weight estimated at 38 tons.

The oldest dinosaur relic is found in the rocks of Central Europe; but in a layer of rock almost as old, dinosaur remains have been found in North America. Scientists conclude from this that they probably had their origin in a land mass then existing between America and Europe, where later lay Atlantis. They spread to almost all parts of the world, being found in Southern Asia, Africa, and Australia. What is now Connecticut Valley, late in the Triassic period was an arid region, like that now of the Southwestern United States. The plant life there was rushes, pines and ferns, with no sign of flowering plants. There were dry stream beds that occasionally became flooded with water; and extending down the valley was an estuary. In the mud about this body of water walked numberless dinosaurs, 150 species having been counted.

These footprints, some of which became uncovered, were first observed in 1802, but were thought to be those of birds. Their true nature was discovered in 1835. The mud had changed to brownstone, and a slab containing important records was for 60 years used as a flagstone with its reading matter turned down. This brownstone slab is now at Amherst College, and other slabs have revealed the presence of the 150 different species of dinosaurs mentioned.

For a long time it was a disputed question whether dinosaurs laid eggs or gave birth to their young alive; certain living reptiles following one method and certain other ones the other. The question was definitely settled by the American Expedition to the Gobi Desert in Mongolia where, in 1923, it unearthed 25 fossil eggs belonging to several species of dinosaurs. In several of these, which had been broken, could be discerned the delicate bone of the embryonic dinosaur. Furthermore, it was discovered that these giant reptiles had gizzards for grinding food, linking them more closely to the birds than hitherto had been possible. These eggs were laid during the Cretaceous period, about 50 million years ago.

Returning now to the Triassic period, in the upper layers of rock that were laid down at this time are found the fossil remains of the flying reptile, the Pterodactyl. Up to the present time the intermediate stages have not been discovered as fossils, and like the turtles, the pterodactyls suddenly appear in the strata fully developed, making little improvement later. At the present time there is an amphibian, several species of which live in Borneo, which has developed the ability to volplane to considerable distance. It is a tree frog which has broadly webbed feet, and also webs in the angles of the arms that sustain it somewhat in the air, increasing the distance of its leap. There are also at the present day two kinds of lizards, or reptiles, that glide very well. One, the Draco, is a little lizard whose sides stick out into a pair of wing like membranes supported by a number of long ribs. This apparatus folds like a parachute, anticipating the invention of man, and being used for much the same purpose.

The flying reptiles of the Upper Triassic period are not thought to be direct ancestors of our birds, although there is considerable structural resemblance between them. But both flying reptiles and birds are thought to have developed from a common ancestor that lived in Permian times. Some of these flying reptiles—and they not merely soared but were capable of sustained flight—were no larger than a sparrow. Other species were the largest creatures that ever flew. One from the rocks of the Cretaceous period, mounted at Yale, measures 18 feet wing expanse, and others are estimated to have had an expanse of 26 feet 9 inches. The best specimens come from the chalk beds of Kansas.

This is not the first instance in the world's history of an animal solving the problem of aviation, which only recently has been solved by man. The insects solved it first in the Paleozoic era, probably actuated by the necessity of escaping from the amphibians that fed upon them. But the wings of the insects, while serving the function of flight, are very dissimilar in principle to those of the flying reptiles, the birds, and the bats. An insect's wing is merely an expanded and greatly modified section of the wall of its body. The wings of birds, bats, and the ancient flying reptiles, as well as those of flying fish, are modified front limbs. That flying fish use this ability to soar to escape enemies—sailing above the water by means of large membranous front fins that vibrate rapidly—may be witnessed almost any day on the trip from Los Angeles to Catalina Island. The first fossil of a flying fish occurs also, as well as the first flying reptile, in the Triassic period.

The Triassic period was one of increasing aridity, which placed a premium on the ability to travel far and swiftly in search of food and water. As a consequence, certain reptiles learned to fly, and a large group of dinosaurs learned to run on two legs, just as today in arid regions modern lizards often tend to this mode of locomotion.

Solving the Problem of Keeping Warm

—An event of much greater importance than the development of the huge dinosaurs took place during the glacial period of Permian times, although the first records of it are not found until late in the Triassic period. The cold and aridity not only placed a premium on great speed of movement, but also on the ability to keep warm. Reptiles and fishes are very susceptible to cold. This in large measure is due to their imperfect blood circulation. The heart, unlike that of mammals and birds, has less than four chambers, and the oxygenated blood mixes with the impure blood before being sent to do its work throughout the body. Not only do the reptiles lack a pure blood stream, such as is present in the higher animals, but the heart is incompetent to keep the blood stream active enough to maintain a constant temperature in the body.

When the surrounding environment is warm the reptile or fish becomes warm, and when it becomes cool the fish or reptile becomes correspondingly cool and sluggish. This is a great disadvantage in a period of cold weather, such as Permian times are known to have been. The desire for greater activity, and to keep the body at a constant temperature in the face of cold weather, enabled the psychokinetic power guided by extrasensory perception, and no doubt stimulated by favorable planetary energies, to use hormones and other factors to change the scales of certain reptiles into hair, and to develop that great advantage, a four chambered heart.

This change was taking place before the Triassic period. In the rocks of the Triassic period in South Africa fossils have been found of a group of reptiles known as Cynodonts, that had discarded the type of teeth characteristic of reptiles, and had developed teeth like those of the modern dog. They well bridge the structural gap between reptiles and mammals. In addition to the incentive for warm blood and warm clothing, brought by the cold of Permian times, in the Triassic period there was increasing aridity, placing a high premium on the ability to travel far for food and water in a short space of time. The more perfect circulation of both birds and mammals enables them not only to endure cold without hibernating, as reptiles do, but also conduces to greater activity.

The first fossil remains of mammals are found in the late Triassic rocks both in Germany and in the eastern United States. These early mammals were small creatures, not larger than a rat. Some had teeth like the present insect eating animals, suitable to living on worms, insects, young reptiles and young birds, while the teeth of others were suggestive of the rat kangaroos of Australia, indicating a herbivorous

diet. Although the first mammal records thus date back about 170 million years, the mammals developed little until after the commencement of the Cenozoic era, over 100 million years later

That the mammals, which seem to have developed from reptiles that traveled on four legs, remained small and inconspicuous creatures for a period almost twice as long as has elapsed since they became important forms of life upon the earth probably was largely due to the inner plane weather at that time which, as well as outer plane conditions, favored the dinosaurs. During this period there was an immense number of varied forms of both large and small carnivorous dinosaurs which preyed upon all other living creatures. Only small forms of mammals which could dart into shrubbery, or into burrows in the ground on a moment's notice, could hope to survive the stalking terrors of that day; for no mammal that ever lived, with the exception of modern man armed with explosives, could have been successful in combat with them. It was only when the Age of Reptiles came to an end, and all these monsters mysteriously became extinct, that the mammals had a chance to become important creatures.

The second period of the Mesozoic era, the Jurassic period, commenced about 155 million years ago. It ushered in a mild humid climate in which vegetation grew lush and rank in vast swampy lowlands. As a result of this abundant and easily obtained vegetable food supply, many of the dinosaurs that hitherto had been rapid travelers and many that had been creatures of prey, resorted to the swamps and the easier method of living upon a vegetable diet. They became indolent, living much of the time in the water, and less and less adapted to a strenuous life on land. This possibly contributed somewhat to their extinction at a later period when a severe climate set in once again.

The First Birds

—Many of the dinosaurs of the Triassic period ran on two legs, and food seeking and the desire to escape terrestrial enemies caused some of the smaller species to take to the trees. A dinosaur running swiftly over the ground on its hind legs would be helped immensely in its speed by using its arms as does a human runner, if these became broadened to resist the air on the backward swing. This desire for speed may have been somewhat instrumental in changing, through psychokinetic power, the fore limbs into wings.

The species that went into the trees no doubt learned to perch there out of the way of predatory creatures below. They had, judging from their descendants, three long fingers provided with large claws which were used in climbing, even as a modern bird, the Hoactzin of British Guiana, still retains such claws on its wings for this purpose. The pursuit of their prey would lead them to jump rapidly from one limb to another, and if possible from one tree to another.

The desire thus to move rapidly through the trees without descending to the ground, which was full of peril, if intense enough would act upon the astral form of the creature and on the astral body of the offspring, modifying it in the attempt to find a method of accomplishing the sought for results. The scales of the reptile on both the fore limbs and on the rear limbs thus became modified to offer greater resistance to the air. Probably the primitive bird used the hind limbs as well as the front ones for soaring; for in young birds such as squabs there are quills that sprout on the legs so arranged as to indicate that in the remote past their ancestors had steadying feathers on the legs as well as feathers on the wings. In present day birds these quills do not become feathers, but on some early fossil birds just such feathers are present.

This development from reptile into bird seems to have taken place in the arid Triassic period, and as a result, early in the Jurassic period, which we are now considering, there may have been a four winged bird, although no fossil remains of it have been discovered. The oldest bird fossils so far found were buried in the sedimentation laid down in the latter part of the Jurassic period, something like 135 million years ago. Two specimens of this bird have been found, both from a quarry at Solenhofen, Bavaria. This bird (page 132) is known as the Archaeopteryx.

In many respects it is more of a reptile than a bird. It has teeth in both jaws. for instance. The bones of the hand have not yet fused into a modern wing, and although a wing is present, the fingers are yet armed with claws. The breast bone, which in modern birds must be very strong to support the Right muscles, is as yet quite feeble. In modern birds the tail is short and blunt and the feathers disposed about it fanwise; but this primitive bird has a long lizard like tail, along either side of which the feathers are arranged in pairs. It appears in the fossil records long after the first record of a flying reptile.

Unlike the primitive mammals, which lived by stealth and so in constant dread of the terrible reptiles that they had no chance to develop, the birds, well fitted to any extreme of temperature by their feathery covering—which in many respects is superior to hair or fur—seem to have undergone a steady progress from the very first.

The third period of the Mesozoic era, the Comanchean, or Lower Cretaceous period, began about 120 million years ago. During this period the larger reptiles that had developed during the Jurassic period became extinct. The world was still replete with reptiles, but they were more specialized and the monsters had disappeared. This result may have been brought about by the change that took place in the vegetable world, although throughout most of the world the climate was still warm and much like that of the previous period. Nevertheless, in Eastern America the ferns, ginkgoes and cynads began to take a secondary place, and true flowering plants commenced to be the dominant form. The Comanchean period, therefore, may be called the period of the rise of flowering plants.

The fourth and last period of the Mesozoic era, the Cretaceous period, commenced about 95 million years ago. The reptiles were smaller than previously, but were numerous and had reached the height of specialization. There were numerous queer

forms, some of which were unbelievably grotesque. Toward the end of the period, great mountain chains rose, there was considerable climatic change, and the reptiles were not so diverse in development, many of the queer looking ones having vanished. Here, for the first time, are records of the first placental mammals—those that do not lay eggs—the marsupials, being primitive forms of the opossum and kangaroo.

The records of this period are mostly marine, the chinks of Kansas producing the fossils of birds, as well as those of sharks, fishes, sea turtles, sea reptiles, and fish eating flying lizards. The birds of this period all retained the teeth of their reptilian ancestors. Two mounted skeletons of each of two birds from this period are preserved at Yale. One, *Hesperornis*, is a diving bird about four and one half feet long that, like our penguin, had lived so exclusively in the water that it had lost the power of flight, although small wings are present. The other is a bird much like our modern gull except that it still had teeth.

Among the dinosaurs there were two divergent races. One race kept all four feet on the ground and developed into the present day crocodiles. The other race moved on two legs and developed into birds. But toward the end of the Cretaceous period extensive land areas were greatly elevated and all the innumerable dinosaurs, for some reason not well understood, became extinct. Whether it was the cold, small mammals that ate all their eggs, or some infectious disease with which they were confronted, they were unable to meet the new condition successfully.

The mention of infectious disease brings up the question of the place of viruses in evolution. They give the appearance of being on the boundary line between organic and inorganic substance. When they appeared first on earth is not known. In fact, as they are invisible with the ordinary light microscope, little was known about them until 1941 when they were first made visible with the electron microscope.

Some live on animals, some on plants, and some are bacteria eaters. Outside the bacterium these latter seem dead, but when they enter the bacterium they quickly come to life, multiply rapidly through sexual union after the manner of most protozoa, and when the colony thus generated numbers several hundred they burst forth through the ruptured walls of the bacterium.

Chapter 6

Serial No. 130
Original Copyright 1949
Elbert Benjamine

Copyright
August 2002
Church of Light

Development Among Mammals

EVOLUTION OF MAMMALS

EOCENE	OLIGOCENE	MIOCENE	PLIOCENE	PLEISTOCENE
<p>Creodonts Fox-like mammals</p> <p>Moeritherium 3 ½ feet high long nose</p> <p>Eohippus 4 toes front 3 behind 13 inches high Epihippus middle toe dominant</p> <p>Protylopus size of jack rabbit</p>	<p>Daphniae —better teeth</p> <p>Palaeomastodon larger 4 tusks</p> <p>Mesohippus 3 toes in front 3 behind Size of coyote Miohippus larger</p> <p>Size of sheep several branches</p>	<p>Dogs as large as bears</p> <p>Dinotherium Tetrabelodons 4 tusks smaller than elephants</p> <p>Meryohippus 3 toes front 3 behind, size of pony. Protohippus teeth developing like modern horses.</p> <p>Protomeryx hoofs like deer. No teeth missing. Procamelus teeth reducing.</p>	<p>Giant wolves True dogs</p> <p>Tetralophodon 4 tusks Jaw 6 feet long Mastodon Imperial Elephant</p> <p>First modern horse, still with “dew claws.”</p> <p>Pliachenia more advanced</p>	<p>Wolves, Dogs</p> <p>Mastodon Mammoth, Colombian Elephant. Imp. Elephant.</p> <p>Horses, Asses, Zebra</p> <p>Giant Camels</p>

EVOLUTION OF MAMMALS

EOCENE	OLIGOCENE	MIOCENE	PLIOCENE	PLEISTOCENE
Small fleet mammals	3 groups small mammals horns develop	Larger in size more complex in structure	Abundant Rhinoceroses	Rhinoceroses
Mammals size of rabbit	Small hoofed mammals	Larger and more complex structure	Several Bison	Giant Bison, Ox
Mammals size of rabbit	Small hoofed mammals	Deer-like, antelope-like, but primitive	Sheep, Antelope, Deer	Deer, Sheep, Pronghorn
Mammals size of jackrabbit	Primitive peccaries, primitive giant pigs	Giant pigs as large as a horse Peccaries	Peccaries	Peccaries, Pigs
Small mammals size of coyote, without pronounced proboscis	Proboscis developing	Larger size, longer proboscis	Primitive Tapirs	Tapir
		Porcupine-like animals First bears	Many Porcupine Cave-bears of large size	Porcupine, Cave-bears Bears,
Creodonts Fox-like mammal	Claws developing	True cats Saber-toothed tiger	True Cats, Saber-tooth tiger	Lion, Tiger, Cats

Chapter 6

Development Among Mammals

ONLY a portion of the mammal species that existed a few million years ago have survived to this day. Yet the species that have survived are so numerous that any adequate history of their development would require several volumes. The various stages of progress of some kinds are as yet unknown; but there are a vast number which have left their bones at successive stages of development where they were covered by mud, sand, dust, or volcanic debris, to become fossils.

These constitute an indelible record by which modern mammals may be traced back unerringly through their genealogical chain to more primitive stock; link after link being revealed as new remains are uncovered, until the chain disappears in the primitive creatures of the Triassic period some 170 million years ago. Here, however, limitations of space will permit me to mention, and most briefly, the progress of only a few forms. And for that purpose I have selected a dozen species of mammals with which everyone is somewhat familiar, for they can be seen at any time on the farm or in the zoo: the dog, lion, elephant, horse, camel, ape, rhinoceros, porcupine, bear, pig, deer and bison.

It should be understood that only a few small and insignificant primitive mammals existed up to the commencement of the Cenozoic era about 55 million years ago. These minute creatures were the forerunners of modern marsupials. Their remains are found in the Triassic of North Carolina. These Allothera, as they are called, are also found in the Triassic of Europe and the Jurassic of South Africa.

That they must have had a terrible time trying to survive is indicated by the record that for 115 million years, more than twice as long as since their enemies, the dinosaurs, disappeared and gave them a chance really to progress, they remained little, sly creatures which were constantly on the dodge to keep from becoming food for the big lizards that dominated the world. But as soon as the dinosaurs disappeared they started rapid progress. And it may be assumed that the conditions under which they lived, with their lives in danger every moment, previous to this time had sharpened their wits and given them considerable intelligence. The dinosaurs, on the other hand, are noted for the minuteness of their brain in comparison to their brawn.

Even before the extinction of the dinosaurs, the little ancestors of modern mammals had made some progress, for in the Cretaceous period of about 90 million years ago

there are found the fossils of numerous minute marsupials which had developed from the older stock. And apparently contemporaneous with them, as indicated by their fossils, were also the first placental mammals, the undoubted ancestors of all modern forms. But all of both types, until the dinosaurs vanished, were constantly forced to hide, and given no opportunity to develop size.

The mammals of today all are of the placental type, with the exception of the opossums of both Americas, the *Coenolestes* of Ecuador and Colombia, and certain primitive types which live in Australia.

In the Triassic of South Africa a group of reptiles has been found which very closely approaches the form of the most primitive mammals. Three such primitive mammals, which have made little progress above the mentioned advanced reptiles, survive in Australia even to the present time. They are the duckmole, the spiny anteater, and the proechidna, which is an anteater without a vernacular name.

These mammals have pouches in which, like the marsupials, they place their young. But as do the reptiles, and unlike the marsupials, they lay eggs. They have never reached the stage of caring for their young by retaining them in their body until they are mature enough to make the hazards of external life less dangerous. The eggs they lay are large and contain much yolk. In the case of the duckmole, after the eggs hatch there are no teats for the young to suck, but the milk oozes out of numerous pores on the front of the mother's body and is licked off by the young. In the case of the anteater the egg is placed in a temporarily developed pouch and when it hatches milk oozes out into the pouch.

These mammals belong to the group lower than the marsupials. They are known as Monotremes. They seem to represent the transition stage between lizards and placental mammals. It appears that the desire to protect their young from the rigors of difficult environment had stimulated extrasensory perception and psychokinesis, and that psychokinesis guided by extrasensory perception had actually taken a long step to attain this desire; for, unlike the young of reptiles, their young are provided nourishment, the forerunner of true milk, until they are husky enough to forage for themselves. But as yet they have not provided the fuller protection that the placental mammals have devised for their offspring.

Neither have the marsupials, although they have made a decided advance in this respect over the monotremes. They no longer lay eggs, but give birth to their young. But unlike higher orders of mammals, the young are born prematurely, so helpless in fact that they cannot even suck. Thus the marsupials have only partially solved the problem. The mother takes the young one in her mouth and places it in the skin pouch and adjusts its mouth over the teat and then injects the milk down its gullet. A special arrangement of the glottis in the young enables it to breathe while milk is thus being pumped down it, without danger of strangling.

The kangaroo is the most familiar marsupial of today. With the exception of the dingo—a dog presumably reaching there through a human agency—all the mammals of Australia are monotremes or marsupials. This is due to the fact that

Australia was cut off from the balance of the world before the placental mammals developed. In Australia there are marsupials that have solved most of the other problems solved by various species of more developed mammals. Some are similar to squirrels, some to our wolves, some to our hoofed animals, some to our burrowers, etc. Being isolated from the rest of the world, the development of mammals in Australia and the adjoining islands has been along independent lines. The other continents having repeatedly been connected by land since placental mammals came into existence, have forms of life with much more in common.

That marsupial mammals and placental mammals solved the problem of adaptation to similar environmental conditions along almost identical lines, even though the problem could have been solved in different ways, was probably as much due to extrasensory perception and the inner plane weather favoring this particular solution, as to the outer plane conditions.

The Placental Mammals

—The placental mammals, to which group man belongs, made a distinct advance over the marsupials. Premature young are under a great handicap. The death rate due to enemies and climatic conditions is high. It is a decided advantage that the young shall have reached an advanced stage of growth at birth, and thus soon be able to endure severe weather and follow the mother about, or perhaps remain hidden by her without perishing.

This desire for greater protection for the young brought psychokinesis into play in the development of the placenta; a tissue that links the unborn young and the mother in a prolonged partnership. By means of this tissue the blood vessels of the young are brought into close contact with the blood vessels of the mother, and thus absorb from her dissolved nutritive matter, oxygen, water, and the necessary salts; also giving to her in return the dissolved waste products. One of the most important functions in this long sleep of the unborn is that it enables it to be born with a well developed brain.

Even to glimpse the development of the various present day species of mammals from more ancient and primitive types it becomes necessary to know something of the interrelations of land areas throughout the world at the times when important mammalian modifications were made. I will, therefore, make brief mention of the changes in land areas that took place at different times. Due to shrinkage of the earth, and to the impact of inner plane weather, land areas rise and sink. There are periods in which portions of continents sink below the sea, islands and other land areas disappear, and land bridges that previously have connected continents subside leaving no way open for long lapses of time by which land creatures or plants from one continent can find their way to another.

There are various ways of accurately determining the existing land areas at any period of the past. For instance, the shell fish and other marine forms that are able to

migrate only along a coast line and never across deep bodies of water, are entirely different along the warm Asiatic coast near Japan from those occupying the coast along the Arctic Ocean. When land rises across Bering Strait, making a complete land bridge between Asia and America, the Arctic waters no longer flow southward along the west American coast. Instead, the waters are warmed by the Japanese Current, and the shore life from the Japanese region spreads along the continuous shore line following the land bridge, and is found all along it and well down into California.

When this land bridge subsides, and instead of leaving a small shallow strait, as today, the Arctic Ocean is given free access to the North Pacific, these cold waters exterminate the Asiatic form of coast life that are suited to warm waters, and we find the fossils of the purely Arctic types. There is then no longer a route of migration open between Asia and North America, and the shell fish of the Arctic follow the cold waters well south along the western coast of North America. Thus, without taking the space to go into detail, it will be understood that when I speak of land connections between continents being made or broken, or of land areas being raised or lowered, I am not referring to tradition, but making the assertion upon sound and fully accepted scientific opinion.

In the Cretaceous period, something more than 55 million years ago, it is quite certain that all the continents of the world were connected by land; for dinosaurs, which were strictly land animals, have left their fossils in the non marine Cretaceous rocks of every continent. Because there were both marsupial and placental mammals during this period, it is possible that the latter also found their way to all the continents, although no fossils of placental mammals belonging to this period have thus far been found in Australia or South America. South America was then connected with Australia by land across Antarctica, which then had a mild climate; and there is strong evidence that this connection, and a land connection between Brazil and West Africa, existed into Basal Eocene times.

Eocene Period

—The first period of the Cenozoic era (meaning era of modern life) was the Eocene, which commenced about 55 million years ago. It is usually divided into two sections, the lower being called Basal Eocene, and the upper merely Eocene. In Basal Eocene times both Europe and Asia were well connected by land at the north with North America. South America was then cut off from North America, and continued thus cut off well into the Cenozoic era, the Pacific and Atlantic being connected across what is now Central America. The Culebra Cut of Panama, through formation belonging to the Eocene period, reveals marine shells which would not have been present if it had then been a land area.

The climate during the previous period, the Cretaceous, was very warm even into the Arctic regions; warm climate plants being found in Greenland and Alaska. In Eocene times it was somewhat cooler, but still genial, as shown by the innumerable remains

of great crocodiles and large palm trees in Wyoming and Idaho. North America in Basal Eocene extended further to the east than today, and Florida and the North Gulf Coast were submerged; but otherwise this continent was in shape very much as now. The Appalachian Mountains, older than the western ranges, were already worn down almost to a plain with a few peaks sticking up, as peaks thus stick up at present in large areas of Texas, the highest being in North Carolina. The Rocky Mountains and the Sierra were in existence, though much lower than today, and the eastern coast and the interior were vast plains. The continent was largely forested; willows, poplars, sycamores, oaks, and other modern trees being mingled with conifers. England was temperate in climate.

Lower Eocene rocks of northwestern New Mexico, and Upper Eocene rocks of eastern Wyoming, South Dakota, and Montana, have yielded numerous fossil mammals; but for the most part they are types that later became extinct, leaving no descendants. All are small, no mammal of say 50 million years ago as large as a sheep ever having been found. The ancestors of all modern mammals, then very small and primitive, had their origin probably in Cretaceous times on land well toward the North Pole, according to Wortman as a result of his studies of the fossils at Yale. From thence, as the then sub tropical climate cooled, they were forced south into Europe and North America, where they displaced more primitive forms that were less adapted to environment than are those of today.

In Eocene times proper, there was a submergence of the Atlantic Coast and Gulf Coast of North America, and the Gulf extended up the Mississippi Valley as a long arm of the sea. On the Pacific another long, narrow arm of the sea extended up the great valley of California to Oregon and Washington. The Mediterranean covered most of Southern Europe, the Pyrenees, Alps, and such great ranges not yet having been lifted. Europe was completely separated from Asia by a strait east of the Ural Mountains joining the Mediterranean with the Arctic Ocean. America and Europe were well joined by land, and the wave of mammal migration coming down into both continents from the north gave them mammals that were more nearly identical than at any time since. This is particularly true of the lowest formation of the Eocene proper, where innumerable fossil mammals have been found. Before the close of the Eocene, as shown by the Uinta formation in Green River Valley, northeastern Utah and northwestern Colorado, the mammals had become totally different from those of Europe; for the land connecting these two continents had sunk below the sea.

In Basal Eocene the carnivorous mammals were represented by the creodonts; nothing similar to the dog family or the cat family yet having evolved. These creodonts were flesh eating mammals, with teeth very much like cats, but with heavy tails and blunt claws. The first known member of the dog family in North America is a very small fox like creature living about 40 million years ago found in Upper Eocene. It is believed to be a direct descendant from the primitive creodonts. It also appeared in Europe at about the same date. Furthermore, about this period there is found in the Libyan Desert of Egypt an animal about three and one half feet high. It is the *Moeritherium* which, although having no proboscis as yet, shows by the nasal

openings the beginning of the development which finally supplied the elephant with a trunk. Fortunately, the intermediate links between this short faced creature and the elephant of today, to which it is the ancestor, have been found; showing a gradual development in size and length of proboscis.

The horse, on the other hand, had its origin, and most of its development in America. Eohippus,—the dawn horse, is found in the very earliest Eocenes laid down about 55 million years ago, in Wyoming and New Mexico. It was a small graceful creature twelve inches high at the withers, with an arched back. It had much the proportions of a fox terrier, except that the feet were already beginning to be modified from toes into hoofs. The hand had four complete toes, each with a hoof like nail. The foot had three such toes, although a splint shows where its ancestor had another toe which had atrophied. Animals which require speed run on their toes, not flat footed. This lifts the outer toes on either side from the ground somewhat, tending to place the weight on the middle and longer toe. Thus the middle toes become stronger and better adapted to carrying the weight, and fortified against the impact of the ground; while the outer toes, not getting much use, fail to grow.

In Middle Eocene, about 10 million years later, is found in Wyoming and New Mexico, Orohippus, the mountain horse. By that time this ancestral horse had developed in size to thirteen and one half inches tall. The splint remnant of the fourth toe had been entirely lost, the outer finger of the hand had been shortened, and the teeth had been modified. In Upper Eocene, another 5 million years later, is found Epihippus, still larger than Orohippus, yet with three toes behind and four in front, but with the middle toe of each front foot becoming quite dominant. From the vestigial structures of these early horses it is quite certain that they descended, as did all present day mammals, from a five toed ancestor. The five toed horse, however, while frequently mentioned, so far has not been found.

Strange as it may seem to some, North America is the original home of the camel, where he remained and developed for some 35 million years, only migrating to the Old World in Pliocene times. Before the Upper Eocene the camel is not to be distinguished from other small primitive mammals. But in Upper Eocene distinguishing characteristics were far enough advanced that in *Protylopus*, a creature the size of a jack rabbit in the Uinta formation, we can recognize the ancestor of modern camels, the intermediate steps being represented by a very complete series of fossils.

The Primate mammals, to which apes, monkeys, and man belong, there is much evidence to show, developed from the same small insect eating mammals of the Cretaceous period from which the carnivorous mammals developed. The descendants of this primitive Cretaceous insect eater diverged into two branches: those which were strictly flesh eating became the carnivorous mammals, and those which adopted a strict diet of nuts and fruit which took them into the trees, developed into the Primates. The remains of these first Primates are found in the Lower Eocene of both Europe and America, and the transitional forms between the insect eaters and the Lemurs are found in North American Basal Eocene of about 50 million years ago.

The first recognized Primate, such as Pelycodus, is found in the Wasatch formation of the Great Basin, some 45 million years old. In Upper Eocene formation of the Green River Valley, the Lemur, Northarctus, is abundant. These lemurs, so abundant in the northern hemisphere during the Eocene, have since that time been found only in Madagascar, tropical Africa, and southern Asia, where very similar lemurs still exist at present.

The earliest tapir is a mammal the size of a coyote, found in the Wasatch formation of the Eocene of the Great Basin of North America, of about 45 million years ago. Most of the development of the tapir was accomplished in North America. It migrated into Europe during the Oligocene period, about 25 million years ago, but only reached South America where alone it exists as a much larger animal today, in Pleistocene times, less than a million years ago.

Found in the Lower Eocene of North America, of about 50 million years ago, is a small animal that in the course of several million years developed into a huge creature with two horns on its nose, resembling in many respects the rhinoceros. This creature, the Titanotheres, very numerous at one time, is not the ancestor of the rhinoceros; for it became extinct. Why it died out no one knows; perhaps from disease, as there was no predatory animal at that time large enough to menace it. It is believed, however, that the true rhinoceroses had their origin and much of their development in North America. The earliest form is a small fleet mammal without the characteristic horn developed, from the Wind River formation of the Eocene period, some 45 million years old. From this developed a number of distinct forms, increasing in size as time rolled on, and finally becoming extinct in America in lower Pliocene, about three and one half million years ago.

Those animals which have an even number of toes like the ox, deer and pig, are called artiodactyls. The oldest members of this group so far found are from the Lower Eocene of the Great Basin. One of these little creatures the size of a rabbit is the ancestor of such mammals as chew the cud, as do sheep, bison and cattle. Another, somewhat larger, is the ancestor of the pig. Most of the development of the artiodactyls took place in the old world, to which they migrated very early.

Oligocene Period

—The second period of the Cenozoic era is the Oligocene, commencing about 35 million years ago. It was marked by the rising of a land bridge between America and Europe, across which mammals migrated both ways. This is shown by the close similarity of the mammals found in the White River deposits of the early half of this period in northeast Colorado, western Nebraska, eastern Wyoming and South Dakota, with those of Europe. The American climate was warmer than at present, although the gradual cooling that finally in the Pleistocene brought a glacial age set in during the second half of the period. In Europe the climate was sub tropical, being even warmer than Eocene times; palms growing in Germany. The latter half of the

Oligocene witnessed a great change; for the land bridge between Europe and America again subsided.

As a consequence the mammals of the two continents, as shown by the John Day deposits of eastern Oregon, being isolated from each other, and not able through interbreeding to disseminate to each other their developed characters, developed each along lines that were demanded by peculiarities of climate. Hence, while early Oligocene deposits reveal mammals in America and Europe that are almost identical, by late Oligocene the mammals of the two continents had so developed along divergent lines as to be quite dissimilar. Fortunately, Oligocene formation, both early and late, yield vast quantities of fossils.

In North American Oligocene formation there have been found many different kinds of primitive cats, some of which undoubtedly were the ancestors of modern lions, cats, leopards, etc.; but none of which had developed into a near likeness of these. The claws, however, in some species had become well developed, and two broad groups were emerging, one with teeth gradually becoming more and more like those of present day species, and the other with the upper canine teeth greatly elongated. These became the sabre toothed group, the most terrible cats of all time, and the dominant beasts of prey down to less than a million years ago.

In Oligocene times the dog group had quite distinctly separated from the cat group, although both certainly had a common ancestor in the creodonts of the previous period. The dog, represented by several species of *Daphaenus*, the largest dog of that time, was hardly larger than a coyote. The backbone greatly resembled that of the cats, and the claws were somewhat retractile, which is a cat feature. The teeth were small and had only partly developed the shearing edges characteristic of modern species, but the skull was dog like, rather than like that of the cats.

In both Africa and India the descendants of the more primitive elephant of the preceding period had developed in size, in the height of the skull, and in the length of the proboscis. As found in Oligocene deposits its lower jaw had elongated and short tusks had developed both in the upper jaw and in the lower jaw. It, therefore, had four tusks, instead of two as in modern species. This Oligocene ancestor of the modern elephant is called *Palaeomastodon*.

In North America, in the lower Oligocene formation is found *Meshippus*, a horse which now had developed to the size of a coyote, and in somewhat later formation to the size of a sheep. It no longer had four toes in front, as did its Eocene ancestor, but had three toes in front and three behind, the middle toe having developed to much greater strength and the missing toe being represented by a splint. In Upper Oligocene, representing several million years later, is found *Miohippus*, which is very much like its ancestor, *Meshippus*, except that it is much larger.

The camel of the lower Oligocene, about 35 million years ago, as shown by the White River deposits of North America, had developed to the size of a sheep, although more slender and fleet of foot. In the John Day deposits of eastern Oregon, representing Upper Oligocene some 15 million years later, the camels had

developed into several branches: the giraffe camels, the gazelle camels, and the two other groups which ultimately became the llamas and the true camels.

The Primates—monkeys, apes, etc.—became extinct in North America at the close of the Eocene period, although they existed in South America, and still continue there. They also became extinct in Europe during the Oligocene period, continuing their development in Southern Asia and Africa. The transitional form between *Northarctus* of the Eocene and the man like apes was discovered in the Oligocene of Egypt. It is *Propliopithecus*, which lived about 30 million years ago, and greatly resembles the gibbons of the present day.

There are a great many fossils of primitive rhinoceroses in the White River beds of North American Oligocene. There were three different groups, one of which was light and fleet of foot, another which was massive and slow, and still another which was the ancestor of modern species. Some of these had horns, and others had none, but they were larger than their Eocene ancestors, although not nearly so large as rhinoceroses at present. Tapirs also occur, larger and with longer proboscises than previously.

In this John Day formation, belonging to the Oligocene period, are also found primitive peccaries, and primitive giant pigs. There are found in this formation, likewise, innumerable small hoofed mammals that were developing into deer like, ox like, and sheep like forms. The ox, nevertheless, mostly developed in Europe.

Miocene Period

—The third period of the Cenozoic era is the Miocene period, commencing about 19 million years ago. The Atlantic Coast and Gulf region were again submerged, a cool current from the north driving out tropical forms along the eastern coast of America and replacing them with northern forms. On the west coast the sea again extended up the California Valley, leaving the tops of the Coast Range as small islands, Miocene formations in California being as much as from 5 thousand to 7 thousand feet thick. There was a good connection between America and Europe, but the bridge across Bering Sea was broken. Also, for the first time in the Cenozoic era, early in Miocene the principal elevation of the Coast Range took place, and the Sierra and Plateaus of Arizona and Utah were elevated higher than previously. It was warmer than at present, although not warm enough for crocodiles to be found far north. It was even warmer in Europe, due to the continent being broken and intersected by warm arms of the sea, the climate being like that of India. It was also a great period of mountain making in Europe.

This period is chiefly notable for the marked development both in size and number of the mammals. Many kinds of mammals in the Miocene period grew to much greater size than their present day representatives, and there were far more genera and species than now. Practically all families of mammals now on earth are represented by more primitive Miocene forms, and many groups then prevalent have since

become extinct. It was the period of greatest mammalian abundance, there being great numbers of hares, mice, pocket gophers, squirrels, marmots and beavers, as well as numerous larger animals.

There were many kinds of dogs, some of which were as large as any existing bear; truly formidable beasts. There were also true cats, developed from the more primitive forms of the Oligocene period, but they were not so large as the lion and tiger of today. The sabre tooth tigers were likewise present, having made notable advances, but not yet so large as the huge beasts that became extinct at the close of the ice age. The fossil remains of weasels, martins, otters, and raccoons have been found; but these too are represented by more primitive animals than those bearing the same name today.

The elephants of the preceding period had continued to increase in size, and had developed along several lines. One, the Dinotherium, found in Europe and India, had lost its upper tusks, and instead had a lower jaw that with its tusks bent abruptly downward. The four tusked mastodons increased in size and in tusk development, one genera, the Trilophodon found in France, not nearly so large as the Indian Elephant, had an enormously lengthened lower jaw. It represents an intermediate stage toward the development of the modern elephant. This was the first elephant to reach America, coming by way of Asia in early Miocene times, about 18 million years ago. The members of the four tusked mastodon group are called Tetrabelodons.

The considerable elevation of land areas and the growing aridity of North America during Miocene times caused much of the forested regions to lose their trees and shrubbery and become broad plains covered with coarse grasses. Animals, such as the horses, that previously had fed upon the succulent browse of the trees, were compelled to turn to the harsher and harder food found on the plains. Also, due to the drying up of the rivers, it became necessary to travel immense distances for water. The result of this was a pronounced modification in the teeth and in the feet. There were a number of horses in Miocene times. They had increased in size to that of small ponies. Most of them were three toed, although the outer toe scarcely touched the ground, the middle toe bearing almost the whole weight, being much larger and a well formed hoof.

Merrychippus, a horse of the Middle Miocene, about 15 million years ago, is the intermediate link between the browsing type and the grazing type of horse. The milk teeth in this species are short crowned and have little cement, as in previous horses; but the permanent teeth are higher crowned and quite heavily cemented. In Upper Miocene, developed from Merrychippus, is found Protohippus, still having three toes, but with teeth much more similar to those of the modern horse.

The camel of Lower Miocene times, Protomoryx, had made a decided advance over the camel of the previous period. For one thing, it is larger. All the teeth are present, which is not the case with modern camels; and the two toes, instead of having cushions as at present, are armed with sharp hoofs like those of a deer. The teeth also indicate a change to make them suitable for grazing rather than for browsing. The

first tooth reduction is shown in Procamelus, a descendant belonging to the Upper Miocene, showing changes in the shape of the foot and various other desert adaptations.

Descending from the ape like creatures of the preceding period, Sivapithecus, found in India in Middle Miocene deposits some 15 million years old, while still an ape, has numerous man like characteristics. From this common stock, about 18 million years ago, the Orangutan branched off, and since that time has developed away from its human characteristics. The Chimpanzee and the Gorilla branched from the common stock in Middle Miocene, some 15 million years ago. Instead of developing human characteristics, they developed other qualities, the Chimpanzee becoming less human than previously, and the Gorilla retaining its structure about such man like characteristics as were common to the original stock in Middle Miocene times. Since Middle Miocene times the living apes have mostly been developing along lines almost the opposite of those followed by the ancestors of man.

The bears are descended from the same ancestors as the dogs, the intermediate links having been found. Nothing that had developed far enough to be called a bear is present before late Miocene times. Its fossils are found in Europe, and it did not reach America until the next period.

The history of the porcupines is also quite well known. They, however, underwent their development in South America, where today no less than 6 families and 29 genera are known. Some are no larger than a rat, some are large; in fact the largest living rodent, the Wart Hog, belongs to this group. Some live in trees, some in water, and some in the ground, and some have long prehensile tails that they use as an extra hand. It was not until Miocene times, when a land bridge was formed between North and South America, that porcupines are found in North America, and then only a single species, as now, represented by the present day Short Tailed Porcupine.

The rhinoceroses of Miocene times were abundant both in North America and in Europe, and show considerable advance in size and structure over those of the preceding period. The ox and most of the deer underwent their development chiefly in the Old World, but the prong horn antelope and the Virginia deer have their ancestors well represented in American Lower Miocene, and can be traced accurately from that time to the present. Pigs were numerous in Miocene times, but for some reason not clearly known, but which no doubt was influenced by inner plane weather, the giant pigs, huge creatures as large as a horse, did not persist beyond the Miocene but, together with many other mammals, became extinct.

Pliocene Period

—The fourth period of the Cenozoic era, the Pliocene period, commenced about 7 million years ago. It was cooler than the previous period, and a complete land connection existed between North America and Asia across what is now Bering Sea, giving a marine fauna on the Pacific Coast like that of Japan.

Early in the Pliocene the true wolves developed, some of immense size, and by Middle Pliocene, about 4 million years ago, the modern genus of dogs had become established. Many cats are found in the formation, some of which are very large; both such cats as became lions and tigers, and those of the sabre tooth group. Of the elephant group of this period, now practically as large as modern genera, there was one, *Tetralophodon*, found in Nebraska, with four tusks, and a lower jaw six feet long. Another type, found over most of America, is *Dibelodon*, very much like a mastodon except that its teeth were not so developed. The mastodons, differing from the elephants in their teeth and in some other features, also were present in Pliocene times; and in America the Imperial Elephant, that then roamed the hills about Los Angeles and had a very wide range, was larger than any present day species.

The land bridge between America and Asia enabled horses and camels to migrate from America to Asia, and enabled elephants, now becoming somewhat similar to modern species, to migrate to America. The first of the modern horses is found both in America and Asia in Upper Pliocene, about 2 million years old. The feet have one toe each, but the splints are also prominent enough to be "dew claws." The camels of this time are somewhat more advanced in structure than those of the previous period, being represented by a mammal called *Pliauchenia*.

Bears reached America during this period, and the native pigs, called *Platygonus*, were numerous and more highly developed in many respects than the modern American descendant, the peccary. There was a great abundance of rhinoceroses, four or five kinds native to America, and several others that migrated in Miocene times from the Old World. Several different kinds of ox and sheep are also present and the prong horn antelope and Virginia deer; but the moose, caribou and wapiti developed in Europe and did not reach America until the next period.

Nothing has been found of the Primates in North America belonging to this Pliocene period, with the exception of a single tooth found in Nebraska of a man like ape, or an ape like man, called *Hesperopithecus*. In Bechuanaland, 80 miles north of Kimberley, in South Africa, late in 1924, Dr. Raymond Dart, professor of anatomy at the University of Witwatersrand discovered in a limestone cliff which at the time was thought to date well back in the Pliocene, the remains of a man like ape, which he called *Australopithecus africanus* (Southern man like ape of Africa). Some even yet are inclined to place this find back as far as the beginning of the Pliocene, 7 million years ago, basing their opinion chiefly on geological evidence. But in the 24 years since he made this find Dr. Dart, and Dr. Broom, chief paleontologist of the Transvaal Museum were able to find fossils representing possibly 15 individuals. And chiefly because of their high intelligence, as they were using fire, Dr. Dart now wishes he had named these Transvaal pygmies, which are believed by some to be the ancestors of modern man, *Homunculus* (little man). And according to an article by him in the Autumn, 1948, issue of *American Journal of Anthropology*, he places them contemporaneous with the Men of Java, who lived at the commencement of the Pleistocene period, about one million years ago.

Pleistocene Period

—The fifth period of the Cenozoic era is the Pleistocene period which commenced about one million years ago. Due to considerable elevation in land areas at the end of the Pliocene period, the climate of the entire Northern Hemisphere was greatly cooled, ushering in the glacial age. The Pleistocene is the age of ice during which the ice sheet came down from the north reaching as far south as 40° latitude, and over New York attaining a depth of 10,000 feet. During the 970,000 years of the Pleistocene the ice came down no less than four distinct times, each time again receding. Between these intrusions of ice there were long interglacial periods in which the climate usually grew even warmer than it is now.

At the commencement of the Pleistocene period had there been a primitive explorer roaming over America he would have found all the southern part of what is now the United States covered with such spruce and pine as at present grow in Canada. Had he gone north through this thick forest, he would have been stopped abruptly by such a wall of ice as is now to be seen when approaching Antarctica. It extended from what is now New York City to the State of Oregon, covering all of Canada and at least half of the United States.

In addition to the elevation of land areas, climatic changes are also influenced by the relation of the earth to the sun. Not only by the variation of the inclination of the earth's axis to the ecliptic, but also by the distance of the earth from the sun. The earth's orbit fluctuates considerably. It was elongated some 100,000 years ago, then was almost circular about 50,000 years ago, became elongated again in 20,000 B.C. and now is once more moving toward the circular. It will reach its nearest circular shape in about 20,000 years. Except as influenced by terrestrial conditions, the weather gets colder when the orbit elongates, and warmer when it is more circular. Therefore, we are now moving toward a warmer climate which will be at its hottest about 20,000 years from now, when it is expected tropical vegetation will grow on the shores of the Arctic Ocean. But, according to George Gamow, professor of physics at George Washington University, large masses of ice will again start creeping down from the north, by about the year 50,000 A.D., as the fifth glacial advance, and will completely cover all the cities of Canada and northern United States.

The animals of the Pleistocene period, though different in size and in other respects from those of the present, would readily be recognized as the general group to which they belong if seen today. The American Mastodon ranged the forests, and of the true elephants there were three species: the Mammoth, the Colombian Elephant, and the Imperial Elephant. There were giant wolves, and there were true cats, some of large size, as well as the Sabre Tooth Tiger, which was more massive than any living tiger.

There were camels that were considerably larger than those of the present. There were also several species of true horses, with a single hoof on each foot, and there

were bison that were much larger than any existing species. Moose, caribou and wapiti had reached America from Europe, and there were huge cave bears in various parts of the world. Furthermore, there were huge ground sloths, and armored glyptodonts, and a number of other mammals that have since become extinct. But in addition to these extinct forms there were those with which we are familiar, such as the peccary, mink, weasel, martin, skunk, otter, badger, wolverine, raccoon, fox, coyote, puma, etc., all present in America. And as there were rigorous climatic changes, the competition between forms and the struggle to survive must have been exceedingly intense.

Such a brief survey of the development of mammals is not altogether satisfactory, yet at least I trust it shows conclusively that all existing forms have developed from more primitive preexisting mammals. In many cases complete series of fossils have been found showing the chief steps by which changes in structure were made, so that to doubt their genealogy is to doubt the evidence of one's eyes.

A study of these fossils indicates that whenever members of a single species separated over a long period of time with an impassable barrier between such as the destruction of a land bridge between two continents, or in some cases by a desert, or a broad river, or a mountain range; that the members of each region developed along different lines. No longer able to commingle and breed, and thus impart developing qualities each to the other; being in a different environment, they each develop qualities called for by that environment. Both in structure and in habit they become further and further apart, until they become distinct species.

We have witnessed the creation of breeds by artificial selection; for all the tame pigeons—fantails, pouters, carriers, etc.—are known to be derived from the rock pigeon; and all domestic chickens are known to be descendants of the Jungle Fowl of India. There are instances, also, within the knowledge of man of new species being the result of isolation. Rabbits, for instance, were turned loose by mariners on certain islands off the southwest coast of Europe several hundred years ago. These rabbits, although of the same stock as rabbits on the mainland, are today a totally different species, quite incapable of breeding with the rabbits of the mainland.

Chapter 7

Serial No. 131
Original Copyright 1949
Elbert Benjamine

Copyright
August 2002
Church of Light

Development of Man

Chapter 7

Development of Man

IN lesson No. 127 the chief characteristics of the vertebrate animals were mentioned. Man possesses all of these characteristics. Furthermore, as his young are born alive and nourished by mammary glands, he is a mammal. Of the mammals, the method by which the young are nourished before birth places him among the placentals. These are classified into four groups: the clawed ungulates, the hoofed ungulates, the finned cetaceans, and the nailed arboreal primates. Obviously he has neither the structure and claws of a dog, the hoofs of a horse, nor the fins of a whale. But he does have the flattened nails, the clavicle, the simple stomach, the thoracic mammary glands, and all other characteristics of the primate group.

The ancestors of all Primates, as stated in lesson No. 130, there is good evidence to show, were small insect eating mammals that lived in the Cretaceous period some 75 million years ago. The first fossil Primates are found in the Washatch formation of the Great Basin of North America, some 45 million years old. Such is *Pelycodus*; but the transition between the earlier insect eaters and the true Primates is found in Lower Eocene formation, about 50 million years old. They had adopted a strict diet of fruits and nuts which took them into the trees. Still later, in Upper Eocene, the lemur called *Northarctus*, which resembles present day lemurs, is abundantly found in the formation of the Green River Valley in America.

The lemur is often referred to as a “half ape”; for the brain is not developed so extensively as in the true monkeys, and the second digit of the foot still bears a claw, instead of the nails which the other digits carry. It is thus much more closely related to other mammals than are the apes and monkeys.

The present day Primates are divided into several families. The marmosets belong to the family Hapalidae. The Capuchians, howler monkeys, spider monkeys, etc., belong to the family Cebidae. The Old World Monkeys, baboons, macaques, etc., belong to the family Cercopithecidae. The anthropoid, or man like apes belong to the family Simiidae. Man is classed in yet another family, the Hominidae.

The nearest relatives to man, structurally and biologically, are the anthropoid, or man like apes. There are four living genera of the anthropoids, and several extinct genera. The living genera are the *Hylobates*, or gibbons; the *Simia*, or orang; the *Pan*, or chimpanzee; and the *Gorilla*, or gorilla. The gibbons and orang at the present live in

the Orient, and the chimpanzee and gorilla are natives of Africa. The transitional form between *Northarctus* of the Eocene and present day anthropoids, *Propliopithecus*, was found in the Oligocene formation of Egypt dating back about 30 million years.

The orang branched off from one anthropoid geneological stem in Miocene times, about 18 million years ago. Somewhat later, in the Middle Miocene formation of India, representing an age of about 15 million years, there has been found the fossil of an extinct form, *Sivapithecus*. It lived rather close in time to another form, *Dryopithecus*, and not far from the time when both the chimpanzee and the gorilla branched off as different trends in anthropoid evolution.

To sum the matter up, we may say that the gibbon of today is somewhat less man like in its characteristics than its ancestor, *Propliopithecus*, which lived about 30 million years ago. The orang of today is less human in structure, and probably in its habits, than its ancestor of some 18 million years ago. The chimpanzee is less man like today than its ancestor of 15 million years ago, and the gorilla of today has at least no more likeness to man than its ancestor of 15 million years ago. We have much reason to believe, therefore, that there has been a constant widening of the structural breach between man and the living apes for not less than 30 million years.

The Most Recent Discovery of Primitive Man

—The Java fossil man (*Pithecanthropus*) and the China fossil man (*Sinanthropus*) go back a long way, but the fossils of the oldest man discovered to this date (1949) are those of certain pigmies of South Africa. In late 1924 such a fossil was dug from a limestone quarry about 80 miles north of Kimberly. The discovery was announced by Dr. Raymond Dart, professor of anatomy at the University of Witwatersrand. This man ape, as it then was called, was only a baby, not more than four years old, that had died in a limestone cave which slowly filled up with stalagmites, turning the skull into rock. Happily the entire skull was preserved, and Dr. Dart at the time stated: “It is a creature well advanced beyond modern anthropoids in just those characters, facial and cerebral, which are to be anticipated in an extinct link between man and his simian ancestors.”

He named it *Australopithecus africanus*, meaning southern man like ape of Africa. And some geologists placed its age as going back to the commencement of the Pliocene period, some 7 million years ago. But later digging has convinced Dr. Dart that the pigmies, of which this find was a member, often entered limestone caves in their hunt for baboons. And in the 25 years since this first find, Dr. Dart has kept persistently on the trail of this possible ancestor of modern man, and has unearthed numerous fossils of it, some quite mature. As a consequence of these later finds he says in the autumn, 1948, number of the *American Journal of Physical Anthropology* that now he wishes he had named it *Homunclus*, meaning little man.

These pigmies lived earlier than either the Java man or the China man. They lived on the treeless savannas of what is now central Transvaal. They had ape like faces, were about four feet high, and weighed around a hundred pounds. But in spite of their small size, their brains were almost as big as that of the oldest man previously discovered, the Java man, who stood around five feet eight inches.

Says Dr. Dart in the 1948 article: "These intelligent, energetic, erect, and delicately proportioned little people were as competent as any other primitive human group in cavern life made comfortable by the use of fire, in the employment of long bones as lethal weapons, in the cunning and courage of the chase and in internecine strife."

In 1947 Dr. Dart's diggers unearthed the back part of the skull, and a lower jaw from an immature pigmy. Near this skull were the skulls of many baboons which had been bashed in from above or behind with a club. The inference is that these pigmies hunted baboons by blocking all but one exit of a baboon cave colony, then as the apes ran out clubbing them from the side of this exit. As these pigmies lived at least 100,000 years, and perhaps many hundred thousand years before the China man, previously the earliest known man to have used fire, and as charred bones give conclusive evidence that they used fire, he named this new man *Australopithecus prometheus*.

After Dr. Dart's first find, others also took up the search. And in 1936, Dr. Broom, chief paleontologist of the Transvaal Museum in Pretoria, found several fragments of an adult which he has now renamed *Plesianthropus transvaalensis*. Then two years later he located, from some rocks casually picked up by a schoolboy, a third genus of the same subfamily as *Australopithecus*, which he named *Paranthropus robustus*, meaning manlike and strong. During 1948 Dr. Broom was able to locate the fossils of at least 12 and possibly 15 individuals of *Plesianthropus*, representing the adult from head to toe. The plants and animals with which the finds of both Dr. Dart and Dr. Broom were associated were definitely those of the early Pliocene. If they were contemporaneous, that would mean that the South African Man Apes lived about 7 million years ago. But Dr. Dart now doubts this, and tentatively places them at the end of the Pliocene or the commencement of the Pleistocene, only about a million years ago.

No doubt time and research will reveal not only the direct line through which modern man descended from *Propliopithecus*, but the significant successive steps. At the present moment the finger points at *Australopithecus* as the most promising ancestor, from one of the three genera of which, perhaps from *Australopithecus prometheus*, present man has evolved. The evidence is conclusive enough that present day man descended not from a monkey, but from an animal ancestor which was also the ancestor of the apes. But as to our immediate anthropoid ancestor, and just where on earth man developed, the evidence is as yet not conclusive, and must await the unearthing of new fossils.

The theory is that *Australopithecus* developed the erect posture and increased brain activity due to the section of the continent in which he lived becoming arid. But no

doubt inner plane weather conditions contributed to his progress as much as his outer plane environment. Approaching aridity, as we have indicated in preceding lessons, is more often than not the cause either of extinction or the development of new structural adaptations by which extinction is escaped.

In a forested country, life is easy, food abundant, and there is little urge for swift development. This may be one of the reasons the gorilla, living in dense forests far to the north of Australopithecus, has remained in development where he was 15 million years ago. But in a region growing arid, food diminishes, water may be had only in certain places, predatory beasts have a great advantage, and the struggle for life becomes strenuous. In such a hard existence, wandering from place to place in search of food, yet beset by numerous enemies, the development of intelligence would prove the best adaptation. The erect position would free the hands for the examination of objects. Such examination is the foundation of all knowledge.

There is a lot of mystical rubbish in print that places man on earth back in time hundreds of millions of years. And it may be that evidence in time will prove that some species of Australopithecus lived well back in the Pliocene period. But there is no evidence that man lived on earth prior to the Pliocene. There are eoliths, which are flakes of flint that some believe were roughly chipped by human agency and used as primitive weapons and implements, that certain scientists have thought might be a bit earlier than the Pliocene. But other scientists not only believe these eoliths assumed their present form through natural agencies, such as being struck by boulders rolling along a stream bottom, but they doubt that they belong to a time earlier than the Pliocene.

According to Dr. Dart's finds, however, man had made quite a development by the commencement of the Pleistocene. But before discussing the development of man since that time, during the last million years, let us consider some of the factors which show the close kinship between other animals and man. The proof of such kinship, which would require a volume for full discussion, rests upon at least the six following different and separate lines of research, any of which alone would be considered sufficient in a court of law to establish it as a fact.

Animals Have Extrasensory Perception

—Before taking up indications of man's kinship to animals, as I have repeatedly made reference to different life forms possessing in some degree both extrasensory perception and psychokinetic power, I believe I should elaborate somewhat on this repeated statement.

All my life I have spent as much time as I could spare from work in close contact with wild life, and have had opportunity to observe on occasions what seemed to me to be good examples of their extrasensory perception. But in reference to the kinship between animals and man it seems advisable to give conclusive instances in which animals have employed extrasensory perception.

Quoting from the November 15, 1945, Church of Light Quarterly Report:

“Even those customarily alert are at times caught napping. In the thirty years he has taught two Brotherhood of Light classes a week in Los Angeles, until this summer, Elbert Benjamine has missed working only one day on account of ill health. That was in the spring of 1922 when for a day he suffered from the 'flu.' But recently, during the second half of 1945, he has had a period of illness. It occurred merely because he failed to take the indicated precautionary actions for his progressed aspects. In his zeal for Church of Light affairs he permitted his adrenaline and cortin supply to become exhausted. In addition, war restrictions prevented him from obtaining his customary diet. But now he has recovered and is back on the job.”

The illness started July 22, 1945, under progressed Mars sesqui-square Uranus r and p, and progressed Moon square Mars p, reinforced by minor progressed Mercury opposition Mars p, and released by transit Jupiter conjunction Uranus r (birthchart in lesson No. 41).

On August 22 I was taken to a hospital. From the time I was carried on a stretcher from my home, my dog Duke (birthchart and progressed aspects in lesson No. 127) crouched in corners, whined almost continuously, and refused to eat. On the third day, between 10:00 and 11:00 a.m., all at once his behavior changed. He trotted about the room, wagged his tail, and in his dog way begged for something to eat. This sudden change in attitude was so marked that my wife, Maria M. Benjamine, at once left him and went to the mail order department, close at hand, where she reported how he was acting. Rev. Edward Doane at once said, “Duke knows Elbert is going to get well.” Maria then returned to our living quarters. Within ten minutes after she arrived there the telephone rang. The head nurse at the hospital, a mile away, told her over the phone that the doctor had asked her to call Mrs. Benjamine and inform her the crisis was past, and that Mr. Benjamine would certainly recover.

In The American Weekly for December 5, 1948, Dr. J. B. Rhine, Director of Parapsychology Laboratory, Duke University, relates a similar event, but in which the event was more drastic.

He tells of a cocker spaniel which watched the illness of his mistress in an old Georgia mansion. For days, exhibiting grief continuously by his demeanor, he stayed in the deserted bedroom beside the bed from which his mistress had been taken to a hospital.

He did not whimper, but mutely retained a sad expression. Then one afternoon, with nothing unusual happening in his vicinity, all at once, and quite unexpectedly, he started the mournful howl which dogs frequently give in the presence of human death. The servants in the house, giving it this common interpretation, at once said their mistress had died. Checking later with the hospital it was found that the woman did die at approximately the time the cocker started howling.

In the same article Dr. Rhine tells of a man in Canada who left his German shepherd dog penned up securely before starting on a train trip which he anticipated would

keep him from home some time. His orders were that the dog was not to be released until he returned.

Then something unexpected came up and the dog's master returned much sooner than he, or those he had left in charge of his estate, had expected. But he had to alight from the train several miles from his home at a flagstop. In the meantime the dog had chewed his way to freedom, and much to the owner's surprise—for no one but himself knew he would get off at this flagstop at that time—he was met there joyously by his dog.

This is an instance of either prevision, or of the dog getting the information telepathically from his master's mind. But, apparently, dogs also at times pick up the experiences of other dogs at a distance. In the same article Dr. Rhine tells of two dogs belonging to the same owner. One of the dogs became ill, and was taken to a veterinarian hospital. The other dog, a Boston terrier, had been in good health. Yet a few days later he was struck suddenly with convulsions as if suffering severely with abdominal pains. Very quickly he returned to his normal health again. But it was learned that his dog friend had died of violent convulsions at about the time the Boston terrier had unaccountably suffered temporarily a similar seizure.

There are a great many instances on record in which both dogs and cats exhibit great fear when in a room where a ghost is supposed to make visits. In the mentioned article such an experience is quoted from Dr. Walter F. Prince's book, *Human Experiences*. In this instance a Newfoundland dog of pronounced fighting propensities, in the presence of such a ghost, deserted the little girl it was his duty to guard and fled whining, with his tail between his legs, to the cellar where he hid in a coal bin; something he had never done before.

The scientists at Duke University investigate dogs that are reputed to have telepathic or extrasensory perception. And they have found some with quite extraordinary telepathic powers. One dog, Pikki, performing with a Russian circus, they gave a series of such telepathic tests. Pikki would do almost anything his master commanded him to do mentally. Screens and other devices were used to make it impossible for the dog's master, Professor Bechterav, to give the dog any kind of sensory clue as to what he wanted him to do.

Thus is there evidence obtained by trained scientific experimenters that dogs on occasion possess the ability to gain information telepathically.

As there is ample evidence that man's personality survives the tomb, the question next arises, does his kin, the animals, survive physical dissolution?

Many have recorded that a pet dog or a pet cat after it died had some time later been seen as a ghost in the locality to which it had become accustomed before its death; moving through the house, jumping up on an easy chair, or doing something else that it habitually did while alive in the physical.

Mr. Pierre Van Paassen in his book, *Days of Our Years*, relates his experience of a ghostly dog. He was in France sitting by the fire. It was about eleven o'clock at night.

Suddenly he felt cold. He went down stairs to throw some coal on the fire, and as he returned something brushed his leg. He looked back and saw it was a large black dog. He had never seen it before. He was surprised; for there seemed no way for a dog to get into the house. It scampered down the steps. He turned all the lights on and made a thorough search of the house. But no dog. So he went to the front door and unlocked it, all the doors and windows being shut and bolted, and called in his two police dogs.

The next night, and on several subsequent nights, he saw the same black dog again, but could find no way by which it could get into, or out of, the house. Then he was sent to Rumania on an assignment for five weeks. When he returned he found his servant, who was already sleeping elsewhere, leaving. Her reason was that she would not work in a haunted house. She said at night a big black dog pushed her door open and came into her room.

Mr. Van Paassen got a man and his nineteen year old son to watch with him. They were armed with a club and a pistol. At eleven o'clock they all heard the dog's footsteps as he came running down the stairs from the upper story. All three ran into the hall, and there at the foot of the stairs was the black dog, which calmly stared back at them. One of the men whistled to the dog, which wagged his tail in friendly fashion. But when they started to descend the stairs toward the dog, its figure began to grow hazy and dim, and long before they had reached it, it had completely vanished.

On an evening subsequent to this, instead of the two men, Mr. Van Paassen got his two police dogs to help him watch. When the patter of the black dog's feet were heard overhead the two police dogs pricked up their ears. Then the hackles on their necks became erect and both backed toward the exit door, growling and showing their teeth. Their master on this occasion, however, could not see the black dog. But apparently the two police dogs did; for they let out howls as if in pain, and began snapping and biting as if they were in a terrific fight with something. Mr. Van Paassen could not see what they were fighting, although he stood ready to take part with a stout club. But suddenly one of his police dogs let out a dreadful wail and dropped dead on the floor. The other one backed into a corner whining, whimpering and quivering. The astral dog had won the fight.

But dogs are not the only animals whose ghosts have been reported by reliable witnesses. Major General R. Barter, of the British army, a young subaltern in the Indian service, had an experience in 1854 with a phantom rider on a pony. In 1888 the General sent the story to the Society for Psychological Research, and it is recorded in the Proceedings in Vol. V, Page 459.

Barter, when he arrived for duty in the Punjab, rented a house which had been built a year or two before by another officer who had died some six months previously. One evening some friends had visited him and after he had gone up the trail some distance with them when they left, he turned around to go back to his house, accompanied by his two dogs. As he turned, he heard the ring of a horse's iron shoe on the rocks. Watching in the direction of the sound, presently he saw in the bright moonlight a

man riding a horse, a very strange figure; for attended by two grooms, he was in full evening dress, with white waistcoat and high silk hat. The horse was a strong hill pony, dark brown in color, with a black mane and tail. On either side of the pony's head walked one of the grooms. One of the grooms had his back turned and the other's face was hidden by the pony's head. But with one hand each held the bridle close by the bit and rested the free hand on the rider's thigh as if to steady him in the saddle.

The path they were on led only to Barter's house, so he shouted to them, but received no reply. When they came close to him he shouted at them angrily, for he was exasperated that they paid no attention to him.

To this there was no response, but the group halted, and stood motionless. Then Barter recognized the rider as Lieutenant B... who had built the house he was living in; for he had previously known him in the service. When Barter sprang to lay hold of the Lieutenant who had been dead six months, the whole group vanished. And he noticed that his dogs, who never strayed far from his heels, had taken to the underbrush.

The next morning he went to visit Lieutenant Deane, who had been in the same regiment with the man now dead. Among the questions he asked the Lieutenant was where the man now dead got his pony. The Lieutenant seemed startled, and said, "Why, how do you know anything about this? You haven't seen B... for two or three years and the pony you never saw. He bought him at Peshawar and killed him one day riding in his reckless fashion down the hill to Trete."

Proofs of Man's Animal Ancestry

—Within man's anatomy are nearly 200 vestigial structures. These are structures, such as the familiar vermiform appendix, that have served a useful purpose in lower forms of life, but which now serve man no useful purpose. He is in the process of getting rid of them. They have diminished in size, and although yet a part of his physical inheritance, he is discarding them as fast as his system can make adaptation. Thus they are small and inconspicuous. It seems strange if man is a special creation that he should be encumbered with nearly 200 structures that not only serve no useful purpose to him, although they do serve other animals a very useful purpose, but actually, in many cases, such as the appendix, which I cite because all are familiar with the fact that it is easily infected and causes so many surgical operations, encumber his activities and endanger his life.

In man's skeleton, muscles, nerves, nerve centers, alimentary canal and its tributary glands, the glands of internal secretion, and the respiratory and circulatory systems, he parallels in structure and function other mammals. The few differences, such as the erect attitude and the placement of the skull on the spinal column to permit this attitude (picture on page 194), and the enlargement of the brain, are specializations developed due to certain habits that have been adopted by man and not by other

animals, even as other genera of animals differ from each other because of their differing habits.

It also seems strange if man is a special creation, that in the development of the human embryo it is first like an invertebrate, then like a fish, then as development proceeds partly reptile like and partly bird like, then like a mammal, and finally like a man. The heart when it first develops has a single chamber like the heart of a fish. The auricle next divides in two, giving three chambers like the heart of an amphibian. Finally the ventricle divides and we have the four chambered heart of the warm blooded animals including man.

The blood as it develops also passes through the stages of its ancestral evolution. The first red blood cells are large and nucleated like the blood of fishes and amphibians. They then take on the characteristics of the blood of reptiles, and finally, before birth they lose this reptilian structure and become non nucleated and bi concave, the characteristic of the human blood.

Definite proof also is forthcoming as to man's nearest kin among the animals. Blood transfusion affords one such test. The blood serum, or fluid in which the blood corpuscles are carried, of animals of close blood kin when transfused mixes without injury; but the blood serums of animals not closely related is poisonous one to another. The blood serum of the horse is not injurious to the blood corpuscles of the donkey; the blood serum of the hare is not injurious to the blood corpuscles of the rabbit; and the blood serum of the wolf is not injurious to the blood corpuscles of the dog. But the serum of a horse is poisonous to the blood corpuscles of a dog, and the blood serum of a wolf is poisonous to the blood corpuscles of a rabbit. The immunity of the blood corpuscles of one animal to the serum from another undoubtedly is due to such animals having diverged recently from a common parent stock and therefore the serum and the corpuscles have undergone almost no modifications since the divergence occurred. Where the divergences from a common ancestor is so far in the past that the serum and the corpuscles of the different stocks have undergone considerable modifications they become injurious to each other.

The blood serum of man is poisonous to, and destroys the blood corpuscles of other animals, but does not injure the corpuscles of the anthropoid apes. Certain contagious diseases common to man, likewise, are not possible to other animals than the anthropoid apes.

Still a further test of man's kinship with the anthropoids has been discovered in the "precipitin" test of blood relationship. It has been discovered that if a fresh blood serum of any animal is injected into the veins of a rabbit there will be produced in the rabbit's blood an antibody. Now if into blood taken from the same species of animal originally used to develop the antibody in the rabbit's blood a few drops of the drawn off blood of the treated rabbit be introduced, a white precipitate is formed. If the blood used for the experiment is not of the same species, but of a closely related species, there will be a small amount of the precipitate formed; the amount being determined by the closeness of the relationship between the animal used to procure

the antibody and the animal used to get the precipitate.

Thus a scientist, without being made aware of the identity of the animal from which the blood was drawn to form the antibody, and without knowing from what animal the blood was drawn for the test, can determine to what extent they are blood kin. If a horse is used to get the antibody, another horse's blood will show a strong precipitate, indicating a very close relationship; while a donkey's blood will yield a precipitate, but less in amount, showing a relationship not quite so close.

When human blood is used to get the antibody, and other human blood is used for the precipitin test, the precipitate is pronounced. When anthropoid ape blood is used for the test there is a precipitate, but less marked than when human blood is used. And when monkey blood is used for the test there is still a precipitate, but not so marked as when anthropoid ape blood is used. When the blood of other animals is used for the test there is no precipitate. Thus is the relationship between man and the anthropoid apes established by the almost identical chemical composition of their blood streams.

Physical man and the anthropoids, however, as we have seen, branched from the same parent stock not less than 30 million years ago, and man has evidently been specializing in brains almost ever since.

The freeing of his hands due to his erect posture enabled him to hold things before his eyes for examination. This examination reacted upon the brain and made him more anxious to examine other objects; hands, eyes and brain each helping the other to develop. As the hands became more dexterous, the use of implements was discovered, and the thumb then rapidly developed.

In the same strata with the Ape Man of Java (*Pithecanthropus*), who lived something like a million years ago, possibly contemporaneous with, but by some scientists thought later than, *Australopithecus*, have been found flints that may have served him as crude implements. This point, however, is open to controversy. *Australopithecus*, however, who lived at least at as early a date, according to late finds, used both weapons and fire. The weapon which is found with his bones is a club which had a ridged head, the distal end of the humerus bone, with which he bashed in the skulls of the baboons he killed for food.

The China Man, or Peking Man, was unearthed in China near Peking. He lived perhaps 900,000 years ago. His chief claim to fame is that he is supposed to have had a larger brain than the Java Man, and had reached the fire using stage of culture.

The Piltdown Man, *Eanthropus*, found in England, belongs to still another genus of man. He lived perhaps in the First Interglacial Interval, something over 800,000 years ago; but the precise time is uncertain. The brain case, brow, and back of head are distinctly human of a very low type, the brain capacity being about that of the lowest living savage. The lower jaw and dentition are ape like, the chin being lacking. He walked erect, and in the pit where he was discovered have been found a

rough flint spearhead, a stone hide dresser, and a hammer stone. It is thought that he possessed fire.

Probably belonging to the Second Interglacial Interval, some 600,000 years ago, is the Heidelberg Man. His stock branched off from the main human stem at a much earlier date than that of the Piltdown Man. His jaw is remarkable in size and strength, being quite ape like, but the teeth are distinctly human. There was no chin, and no processes for fastening the muscles usually used in speech, therefore, it is doubted if he had language. Crude stone implements found in the same stratum indicate that he was a giant in size and strength; for modern man would find these tools too heavy to work with.

The first man of which we have the entire skeleton —although the fossil pieces of different individuals that have been found represent the complete skeleton of Australopithecus very well—is the Neanderthal Man. He probably descended from the Heidelberg Man, living as far back as the Third Interglacial Interval, at least 250,000 years ago, and up to the end of the last Glacial Period and slightly later, say up to within 25,000 years ago. He is the proverbial Cave Man; for he sought shelter from the cold, and protection from the Cave Bear and other extinct beasts, by taking refuge in caves, where in Europe numerous remains of him have been found. He had great beetling eyebrow ridges, massive jaws, was short of stature, and had a shambling gait. Nevertheless, he had a large brain, was a skilled worker in flints, buried his dead with an outfit for their long journey, and was a believer in magic. In 1921 an African species of this Neanderthal Man was found in Rhodesia, Africa. He is called the Rhodesian Man.

In fitting together the jigsaw puzzle of the time in which each of the mentioned primitive men lived I have presented it in apple pie order. But it is probable future finds will upset both the timing and relationship factors markedly. But as stated, it gives a fairly consistent picture of where, so far as at present known, each of these pre-human men fit into the puzzle. Neither the Piltdown Man of England, the Heidelberg Man of Germany, the Neanderthal Man of Spain and France, nor the Rhodesian Man of Africa left any descendants. They were genera of the pre-human race that became extinct. All the present day races of the world belong to a single species of a single genera—as shown by their anatomy—that branched into three distinct races, or subspecies, soon after the Piltdown Man branched from the same main human geneological tree.

Present Day Subspecies of Man

—Each of these three subspecies has certain well marked characteristics. One of the most easily determined is the hair, which not only differs in superficial appearance, but has a different structure when examined under a microscope. All the races of the world at present are thought to belong to one of the following groups:

1. The Polynesian-European Group: These have Wavy hair, fair skin, and long heads. They practically encircle the earth, occupying most of Europe and Northern Africa, and extending in a band through Southwestern Asia and Western America north of the equator along the shores of these two continents.
2. The Asian-American Group: These have Straight hair, yellow or red skin, broad heads and narrow eyes. They occupy Eastern Asia and Western America north of the equator along the shores of these two continents.
3. The Australian-African Group: These have Woolly hair, black skin, and decidedly long heads. They occupy Australia and Africa south of the equator.

As I mentioned, the people of these three groups began to diverge from each other some 700,000 years ago. First the Australian-African group branched from the main stem. Then, perhaps 600,000 years ago, the Asian-American group separated from the Polynesian-European group. Since this branching into three subspecies, the Polynesian-European group, which embraces all of the White race, developed fastest along special lines. The Asian-American group, embracing the Mongols and American Indians, developed not quite so fast, and not in just the same way. The Australian-African group, embracing the Negroes and Australian Black Fellows, developed still less rapidly than the other two branches. On the outskirts of the vast areas of the earth's surface inhabited by each of these three great groups are to be found other people, differing more or less from these marked types. It is supposed that these people, lying on the fringe of well inhabited areas, have been subjected to certain periods of considerable isolation from the main body of humanity, and have undergone considerable modification due to local environment. They are merely outlying groups of the three main groups which have become highly specialized in some direction.

I have already spoken of the jigsaw puzzle of the relation of the pre-human people of the earth to each other and to modern man. But its pieces are nowhere nearly so difficult to fit together as are those of the pattern showing just where present day man had his origin and from what precise pre-human people he descended.

He did not descend from the Neanderthal or any other known ancient man. Neither is there any evidence where he attained the development and culture that he possessed when he first appeared upon the scene of the world's records. The first record of the modern type of man is the Cro-Magnon. Just as soon as the glaciers of Europe receded far enough that the climate and conditions were in a measure endurable, the Cro-Magnon came on the scene. No one knows where he came from, but he was a big fellow, many of the skeletons showing him to be 6 feet, 4 inches in height. In intelligence and physique he was the equal of any race living today. His skeleton was like that of modern man, except that he was unusually wide across the face at the cheek bones. He had much culture, being possessed of rough implements of stone, and he drew pictures of animals on bone and on the walls of his caves. The Basques of the Pyrenees of France and Spain are supposed to be present day direct descendants of these Cro-Magnons.

He is also sometimes called the “Reindeer Man” because the reindeer which he had hunted over the steppes of Europe was one of his two chief food supplies, the other being the horse. He killed off the Neanderthal Man, who had no chance against his great intelligence, and possessed himself of their caves. In certain remote and secret caverns he built clay models of animals, and in connection with his religion went through magical ceremonies over these effigies; this magic being, it is thought, for the purpose of overcoming these creatures when he met them in the flesh.

He made very fair paintings of them too, on the walls of his caves, using a number of natural pigments, such as red and yellow ocher. The animals usually so drawn are the bear, the reindeer, the aurochs and the bison. Where did he develop? In lost Atlantis? He first appeared, so far as there are records to show, about 30,000 years ago.

Then about 12,000 years ago there came a new influx of people into Europe. And no one knows where they came from. But the climate by that time had become suitable for agriculture, and the people who then arrived were of the Polynesian-European group. They had long heads, fair skin, and wavy hair.

Previous to this there had been an invasion of negroid people, for their skeletons have been found in an European cave along with those of the Cro-Magnon. But this new invasion, probably the first wave of the dark white race usually called the Mediterranean Race, came to stay, bringing with them polished stone implements, and high culture in many respects, including the use of domestic animals and the cultivation of such grains as wheat, barley and millet. They had pottery, used milk, and lived a life differing very little from that lived a hundred years ago by the majority of European peasants.

But from whence they came, or from whence came later the wave of light Whites, called the Nordic Race, or where either developed their culture, there are as yet no records to show. At some period they set up huge rough monuments of stone; and similar monuments of about the same are found in India and America. Did this custom have its origin in an astrological cult developed in Atlantis?

There was an influx later of still a third type of white man. He is stocky in build, low crowned, and wide between the ears. His is the Alpine Race. He contrasts strongly in disposition and in his political ideals with either the tall, rangy, large boned, high crowned, lone headed, blond Nordic Race, or the slim, smaller, long headed, moderately high crowned brunet Mediterranean Race.

The Alpine has no governing capacity, has great vitality, little organizing ability, great endurance and plodding patience. The Mediterranean is intellectual, philosophical, musical and patient, but lacks the initiative of the blond Nordic. The Nordic is a politician, loves adventure and action, is a natural ruler, and is capable of high cooperation with his fellowman. These three types are to be found more or less segregated in Europe today, and constitute a great political problem; as the three types find it difficult, due to different religious, political and temperamental bias, to unite in a common effort for the good of all.

It should not be thought that any one of the something like fifteen great races into which ethnologists divide the three great subspecies of mankind are pure strains. There is an inter blending, a shading of the White group into the Yellow and Black, and of the Yellow into the Black. Mankind, being of a single species interbred freely. Different species when they breed produce sterile offspring, as is the mule, which is the offspring of mating a male donkey with a female horse. But the interbreeding of any of the human races produces fertile offspring.

This interbreeding of races has gone on almost constantly in the past. There is no such thing as a pure White Race, or a pure Yellow Race. Professor Dixon of Harvard University collected and measured all the human skulls he could procure, and collected the measurements made by other anthropologists. Many White skulls showed traces of both Black and Yellow, and many Yellow skulls showed traces of Black and White admixtures, and many Black skulls showed traits derived from Yellow and White ancestors.

Which of these races is superior? Time alone will show. Each has certain natural aptitudes not possessed in equal degree by others. Certainly the color of a man's skin, or the race to which he belongs, is no criterion of inferiority or superiority. Which is superior remains to be demonstrated; for whatever the color of a man's skin, or the character of his hair, we can judge his superiority only by one standard. That standard of superiority is the degree in which he can and does contribute to the welfare of mankind.

Today, with greater facilities of travel, the human species instead of diverging, is amalgamating more and more. More and more the Black Races are being mixed with the White and Yellow, and the Whites are being mixed with the Yellow and Black. Of the White Races the Alpines intermarry with the Mediterraneans and Nordics and the Nordics intermarry with the Mediterraneans and the Alpines.

Nowhere is this fusion being more rapidly accomplished than in the melting pot called America. But where any of these people had their origin or developed their culture previous to about 12,000 years ago there is at present no irrefutable evidence to show.

Chapter 8

Serial No. 132
Original Copyright 1949
Elbert Benjamine

Copyright
August 2002
Church of Light

Development of Knowledge

Chapter 8

Development of Knowledge

THE first record of the modern type of man is the Cro-Magnon. He appeared in Europe about 30,000 years ago. From whence he came, or where he developed his culture no one knows, nor from whence came either the Dark Whites or the Light Whites that much later followed him with a fully developed and highly complex heliolithic culture.

But the drawings of pictures of objects, such as the Cro-Magnons drew on the walls of their caves, is the commencement of writing. The American Indians drew the picture of a man shooting an arrow at an animal to convey the idea of a man hunting. To show that a river was crossed the crude picture of a man crossing a river was used. This form of writing, which may be seen on rocks and cliffs east of the Sierra Nevada Mountains along the trails and at the water holes all the way from Mexico to Canada, is called pictograph writing.

In Inyo County, California, the desert heat makes it imperative that the traveler find a water hole at the end of his day's journey. The Indian routes across the Inyo Range, several of which this writer followed on foot (as these were too difficult for a horse) in 1911 and 1912, would be unnoticed by one unfamiliar with Indian methods. But from the start, if one looks ahead as far as he can see he will discern a little rock perched on a larger rock. When he reaches this place, if he looks ahead about as far as he can see he will discern another small rock perched on a larger rock. These mark the route, and by following them one is not led into a box canyon or to an impassable declivity. On the top of the Inyo Mountains big horn sheep abound even to this day. The trails on the pictograph reproduced on page 228 show where big horn sheep may be found, and the water holes (which are far apart in this region) where those hunting them can camp.

In true pictograph it is very difficult to convey abstract ideas of any kind. Its use, therefore, is quite limited. But where there is also a spoken language it is but a step, though a long step and an exceedingly important one, to unite the picture of something having the same name as an abstract idea with the abstract idea, using the picture of the object to represent the more general conception. Thus the sound of not, and knot, is identical. It is impossible to draw a picture of the general conception "not." But it is easy to draw a picture of a knot in a rope. This picture then, because the

words sound the same, becomes the symbol of “not” as well as of knot. The picture of the knot is then said to be a phonetic sign.

Likewise, as James Henry Breasted points out, the picture of a “bee” may be phonetically used to stand for “be”, and the picture of a “leaf” may be used to stand phonetically for the syllable “lief.” The picture of a bee followed immediately by the picture of a leaf then becomes the phonetic sign for “belief.” These phonetic signs so used become real writing, such as the Egyptians employed. Professor Breasted holds that such writing arose in Egypt earlier than anywhere else in the world. But the Sumerians also possessed writing as far back as we have records of them, so it is difficult to decide which developed writing first. And there is much to indicate that both derived the general idea from a common source.

However, the writing of the Sumerians, while developed along the lines above illustrated, was very different from the Egyptian system, so different that it seem certain one system was not derived from the other. The Egyptians used pictures, called hieroglyphics. They also developed at a very early date a true alphabet in which a sign signifies a single letter instead of a syllable. This true alphabet contained 24 letters, being the earliest known alphabet, and the one from which our own has descended. At a much later date there was another alphabet developed of 22 letters, each letter being an abbreviated and conventionalized symbol for one of the 12 zodiacal signs or one of the 10 planets. The religious works and other important doctrines, however, were mostly written in hieroglyphics, which was the phonetic writing employed even at a late date by the priesthood.

Another method of primitive writing, usually employed in association with hieroglyphics or pictographs, is the use of ideographs. An ideograph is the use of a picture which is not that of the object but which symbolizes the object. Thus a feather may be used as an ideograph for a bird, a crescent as an ideograph for the moon, or a hawk as an ideograph for the sun god. Ideographs were employed both by Egyptians and Sumerians, as well as by the early people of other lands, but their method of using ideographs, as well as their method of writing in general, was very different. The Egyptians cut the pictures of their hieroglyphics into stone, and wrote them in black ink, and painted them in colors upon papyrus. The Sumerians did not have papyrus, but wrote upon thin tablets of clay.

Their method of writing was to use a clay tablet while it was yet soft. They wrote with a square tipped reed, or stylus, pressing a corner of this square tip into the soft clay for each line of the picture sign. Lines produced in this manner were broad at one end and pointed at the other, tending to be wedge shaped. Each picture was thus a group of wedges. Hence the writing is called “cuneiform”, meaning wedge shaped.

This cuneiform writing of the Sumerians evidently developed from pictographs to the use of hieroglyphics and ideographs. These became so conventionalized that their meaning seems quite arbitrary. They even verge closely to an alphabet. But the Sumerians never attained a true alphabet. In this way they were surpassed by the Egyptians. Yet even though the writings of the Sumerians and the Egyptians passed

through parallel stages of development, in the end the characters of the writing, as well as the materials used, were so different that it is difficult to imagine that one system influenced the other.

The Egyptians made no use of clay as a writing material. Instead, they made use of a tall rush like plant, the papyrus plant, which they cut into thin longitudinal slices and gummed together and pressed to form a sheet called papyrus. From this comes our word "paper." This papyrus, when prepared, formed a thin sheet which was usually something over twelve inches in width and from a few feet to over a hundred feet long. It was kept in the form of a scroll, and as written upon the part containing the writing was rolled up and the blank part unrolled. It constituted very convenient and durable writing material, papyri that was written on several thousand years B.C. still being in a good state of preservation.

Early Man

—In whatever region the existing species of man developed, whether from Australopithecus or some other ancient strain, it seems certain that there were succeeding waves of migration from this early home at widely separated intervals. A great wave of this primitive population left the parent group not less than 700,000 years ago and gradually filtered around the world south of the equator developing ultimately those characteristics which we recognize in the Negroid races. Then sometime later, possibly about 600,000 years ago, another great wave left the parent group and gradually spread around the world along the northern coastal lines, finally developing those characteristics that we recognize in the Mongolian-Amerindian races. Still later a third wave left the parental stock and in time encircled the globe somewhat north of the equator. This people developed the characteristics that came to mark the White race.

The physical and mental differences we observe in the races of man on earth today imply no unusual pressure from the outer plane environment or the inner plane environment. Although Australopithecus was a pigmy only four feet tall, and we may assume black of skin, a change in environment, including his food and factors of heat and cold and astrological energies might very well, in the course of time act upon his endocrine glands sufficiently to develop the characteristics of all people existing today. While psychokinetic energies may have played their part, no mutation need to have taken place.

The thyroid gland controls the development of the skin, the amount of hair, the moisture in the skin, and the development of the bones of the skull and extremities. It is well known that giants are due to an excess of the hormone of the front pituitary gland that responds to Saturn. The pigmies, if their front pituitary hormone was stimulated would have grown to larger size. On the other hand, pigmies commonly result from over activity of the pineal gland. Thyroid deficiency leads to obesity. Cortin, the hormone of the adrenal cortex, acts upon the pigment cells of the skin, blunting their sensitiveness to light. When there is deficiency of this secretion in a

white person, the skin becomes increasingly sensitive to light, bronzing until, if the deficiency is marked, there is the characteristics of negroid skin. Furthermore, when there is a certain deficiency of the thyroid gland, it produces in a white person decidedly mongoloid features.

For the past 30 years my home has been within four city blocks of the Lincoln High school in Los Angeles. Attending this school on equal terms, and mingling freely with each other are White, Chinese, Japanese, Mexican and Negro youths. The parents of the Chinese and Japanese youths, mostly working in markets not far away, usually are small in comparison to White Americans. But their children are not small. In size, scholarship and athletic ability they compare favorably with the Whites. And most of them are very much better looking than their parents. Furthermore, White children raised in this region commonly grow to larger size than their cousins who are raised in the colder states to the east. The sunshine, the mild climate, and the accessibility to vegetables and fruits the year round from which essential vitamins are obtained, are modifying both the size and the features of children whose Oriental parents probably before coming to America lived on a quite inadequate diet.

I have already mentioned that the three chief types of the White group of humanity finally settled in Europe. Along the Mediterranean coast of Africa was another race of Dark Whites, called Berbers; still other Dark Whites were the aborigines of Egypt, while to the south of these were the Ethiopians, also Dark Whites. Crossing the Red Sea to the east of Africa into Arabia there were other Dark Whites, the Semites, typified by the Arabs and the Hebrews. Still further east in India were still other aborigines, the original Dark White population, called Dravidians. And still further to the east of these, at least at a later date, and spreading across the islands of the Pacific, were still other Dark Whites, the Polynesians. All this great group of white people possessed, when first we find records of them, religious ideas evidently derived from some common source.

They came from some locality where they had the opportunity of developing much above the culture of the old stone age. There are three chief theories as to the locality in which they developed their culture. It is believed, on geological and other evidence, that the Mediterranean Sea, before the ice cap of the last glacial period receded, was not connected with the ocean, but was merely two fresh water lakes fed by the rivers of Europe and Africa. Much of what is now the Mediterranean Sea was then a fertile valley. Some think it was in this now submerged Mediterranean Valley that the White people gained their early culture. With the melting of the vast glacial ice cap, the level of the ocean rose and cut a channel through the Straights of Gibraltar, submerging this valley and connecting it with the Atlantic.

Another theory is that the early culture of the White people was developed in Egypt. But the preponderance of the evidence goes to indicate, I believe, that culture was brought to Egypt from some other region.

The third theory is based upon the tradition of lost Atlantis. Tradition has it that when darkness settled over Atlantis and Mu colonists were sent to what later became the

seven centers of ancient civilization. Deep sea divers have done some exploring on the ridge where Atlantis is supposed to have been located without finding evidence of any people having lived there. Yet there is considerable concrete evidence that both Atlantis and Mu had existence and civilization. Atlantis, by Ignatius Donnelly, The History of Atlantis, by Lewis Spence, and The Problem of Lemuria, by Lewis Spence, present this evidence in detail.

But wherever it developed, the very first records of Egypt, India, Crete, Peru, Mexico, China and Mesopotamia show a high degree of knowledge, and a culture similar enough to make it certain it was developed at a time when there was close communication between those who developed it, and dissimilar enough to make it equally certain that those whose earliest records are uncovered had been isolated from each of the other six centers of civilization for a long time. Even as the same species of animal when members move to a different environment and are isolated from each other over a long period of time develop quite distinct subspecies, so isolated cultures, although retaining their main features, after a time take on quite different minor characteristics.

Extrasensory Communication

—While there is similarity enough between the seven ancient centers of civilization to make it certain their cultures and their religious beliefs were developed from a common source, it is difficult to appraise the extent to which each had actual physical contact with that source. The tradition is that, as mentioned, the astrologers of Atlantis foreseeing the probable destruction of that land, were instrumental in having a colony set up in each of the regions which later became one of the seven ancient centers of civilization; even as precautionary actions are being taken in this year of 1949, that The Brotherhood of Light lessons shall survive for future generations in the event that much of the population of the globe is exterminated in a possible atomic war.

But there are many recorded instances in modern times of important new discoveries in science, important theories, and important inventions which have been made almost simultaneously by those, often in different countries, who have been quite unaware of the work being done along the same line by others. All of us who have been interested in science have read announcements of the same discovery made almost at the same time by scientists who have had no outer plane contact with each other. Practically the same theory about some phenomenon often is published in different countries by people who do not even know of each other's existence. And the same invention is so frequently sent to the patent office by those who live long distances apart that this is one of the big problems faced by those in this government service.

There can be no doubt that extrasensory perception often plays a considerable part in causing inventions to be almost identical in detail. But that both should be working

on the same problem at the same time in these cases is probable chiefly due to the general astrological weather.

In lesson No. 130 it was mentioned that the similar way in which marsupial mammals developed characteristics parallel with those of the various species of placental mammals from which they were isolated was probably due in about equal degree to the outer plane environment and the inner plane environment. Confronted with the problem of adapting to a similar kind of external condition, the creatures in both areas would struggle to find a solution. That they found a solution, and were able to adapt themselves successfully to the similar conditions is not surprising. But that the animals thus isolated from each other should solve the problem in an almost identical manner certainly was not due to chance. Nor, in many instances was the method used the only one which could have been made successfully to adapt to the condition.

And while, even as the marsupials and the placental mammals had a common ancestor, the heliolithic culture undoubtedly was the ancestor of all later civilizations, it must not be overlooked that even by peoples quite isolated from each other, developments from this culture along parallel lines probably was strongly influenced both by the extrasensory impressions each received from the other, and by the astrological weather stimulating the thoughts of each to follow a similar pattern.

The environment most favorable for inclining towards civilized pursuits is one in which there is a fertile land with an available water supply. For this reason the Valley of the Tigris and Euphrates became the seat of civilization in Mesopotamia, the Valley of the Nile became the seat of civilization in Egypt, the Valley of the Ganges the seat of civilization in India, and the Valleys of the Hwang-ho and Yangtse-kiang the seats of civilization in China.

Civilization not only requires a stable and never failing food supply that can be obtained close to the home, but it also requires some available building material out of which homes can be constructed. In the lower valley of the Euphrates-Tigris was a clay which was suitable for drying into brick. Of this brick the earliest known inhabitants, the Sumerians, who were a dark white people, built their homes, made pottery, and upon thin sections made records and wrote communications.

Mesopotamia

—It is still a matter of surmise which is the older, the civilization of Egypt or Mesopotamia. At Nippur, in Mesopotamia, an American expedition unearthed evidence of a city dated not later than 5,000 B.C. and thought by some to date as early as 6,000 B.C. This is earlier than anything of a similar nature found in Egypt. An inscription at Nippur says that the empire extended from what is now the Persian Gulf to the Mediterranean Sea. This is the first of all known empires, and its temples and its priest rulers are the oldest of which we have indisputable records.

In 1930, at Tepe Gawra excavations uncovered various occupation levels. Level 6 down is contemporaneous with the first Dynasty of Ur and mentions temples and

astrological emblems. At Level 13 down, which dates more than 6,000 years ago, was unearthed the oldest temple now known.

It is of advanced architecture, and the pottery motives and engraved seal stamps show not merely skill, but true artistic talent.

What astounded the University of Pennsylvania professors in charge of the work was that at such antiquity there were neither mud huts nor crude methods of life. As they stated it: "Those inhabitants of Level 13 were neither primitive nor normal; they were an abnormally gifted and wonderfully balanced people. And they left evidence of their achievements in more than one aspect of common life."

The oldest recorded religious beliefs are those of the Sumerians, written in cuneiform. These earliest religious records reveal that the people of the Tigris-Euphrates Valley believed in five chief deities: Sun, Moon, Storm-god, Vegetation deity, and deity of the Water. Each city had its patron deity, but although the names given to these patron deities differed, in attributes they were identical with these mentioned. At a very early date also, there was a deific trinity: Anu, the Heavens; Enlil, the Earth; and Ea, the Sea. At the same time, however, Anu was also considered the Sun-god, and Enlil the Storm-god corresponding to Jupiter. As the years rolled on the names of the gods changed. Thus the Sun-god in the north was called Ashur, the patron of the city of that name. Ninib was the Sun-god of Nippur, and Shamash was the Sun-god of another region. In Babylon, Marduk was the chief deity. He was originally the Sun-god, but gradually absorbed the qualities of all the various other deities of the surrounding territories. Later still he became identified with the planet Jupiter.

The Babylonians and Assyrians, nor the Sumerians and Akkadians before them, did not possess the scientific knowledge sometimes accredited to them. They had little ability to predict in advance the precise time when eclipses and other celestial phenomena would take place. According to A. T. Olmstead, Professor of History in the University of Illinois, who has been over the ground in person, they did have, however, great precision in observing and recording such phenomena. Speaking of fragments quite ancient he says that the fixed stars were mapped in three concentric circles belonging to Anu, Enlil and Ea, respectively. He assumes they possessed several machines for close reckoning of the stars, as star positions are given exact, and the circle is divided into 360°. A later fragmentary tablet has been found picturing a number of the zodiacal signs, each showing 30 vertical lines, corresponding to the 30 degrees of a sign. The position of a star is marked by a horizontal line over the vertical line, and on this tablet the position of the chief star in Libra is shown where it was in 800 B.C.

Other fragments are known from Assurbanipal's library, being copies of older originals collected by this literary monarch, showing the position of the equinox in Assyrian times when it was in Aries, showing it in the early Babylonian Dynasty when it was in Taurus, and one, called the Astrolabe, showing it in Gemini with the star positions as they were about the year 4,864 B.C.

All authorities agree that both the astrological positions and the important events coincident with them, as well as the astrological predictions made from such positions, were carefully recorded dating back to before the conquest by Sargon, about 2,750 B.C. This vast series of observations of the actual events which were coincident with certain astrological positions, were finally collected not later than 1,500 B.C. into what is known as the Anu-Enlil Series. This astrological handbook became the standard reference throughout Babylonia and Assyria, and as Jastrow says:

“It appears, therefore, that when an inquiry was put to an astrologer as to the meaning of a particular sign in the heavens, the Anu-Enlil Series was forthwith consulted, the sign in question hunted up, and copied verbatim, together with the interpretation or the alternative interpretations, and forwarded to the king with any needful explanation.”

No less painstaking and thorough were the comparisons with actual events that transpired, or predictions made by liver divination. The forms shown by the liver that gave rise to the prediction were recorded, together later with the extent to which the prediction was fulfilled. What might be predicted from a given condition, both in astrology and by other methods of divination, was based upon what similar conditions in numerous instances in the past had presaged. These careful experimental methods were followed over vast periods of time.

The Sumerians, Akkadians, Babylonians, and Assyrians believed the universe to be peopled with both good spirits and bad spirits. They also believed in sorcery, the power of one person to injure another by what is now called psychokinesis. There is a vast literature given to incantations to secure the help of good spirits, to avert the influence of malevolent spirits, and to annul the influence of sorcerers.

They universally believed in a life after death. There was no hell, but ordinary persons continued in a conscious or semi-conscious state after this life; a rather dour and inactive sort of existence in the dark, gloomy bowels of the earth. Those who won the favor of the gods went to the “Island of the Blest.”

As far back as we have any record of their laws, and the complete legal code of Hammurabi, 2,200 B.C., has been recovered and translated (picture page 130, lesson No. 137), they indicate that the aim was toward strict justice, being quite as fair and humanitarian as those of the present day. The kings prided themselves upon being just and benefiting their people, and the legal decisions show a full conscientious weighing of all evidence. The ancient Sumerians, Akkadians, and later the Babylonians and Assyrians, so far as there is evidence to show, were no more moral and no less so than the people of today.

Egypt

—History records that at the time of the early Sumerian kings in Chaldea the first dynasty of Lower Egypt was established, dated according to the Turin MS., 5,507

B.C. At this time no suitable calendar was in use and the Egyptian system of writing had not been evolved. Fifty kings were to reign before Menes, who commonly is considered the first historical ruler because, seven years after he came to the throne he established a calendar by which succeeding events could be, and were, recorded.

Menes, who thus established the First Dynasty, came to the throne 3,407 B.C. Khufu, whom the Greeks called Cheops, was the first king of the Fourth Dynasty. He ruled 2789-2767 B.C., up to within a few years of the date Sargon the Great founded his empire in Chaldea. According to our traditions, in the year 2,440 B.C. a group separated from the Theocracy of Egypt, and throughout all subsequent times, as a secret order, the name of which translated into English means, The Brotherhood of Light, has been perpetuated.

Amenhotep IV who ascended the throne in 1,375 B. C. through the death of his father, was born 1,388 B.C. At the age of 19 he contacted the same spiritual source from which now emanates The Brotherhood of Light lessons. This led him to perceive that the orthodox religion of Amen kept the minds of the people confused as to reality, steeped in fear, servile to the priests, and shut them from the knowledge which would lead to true spirituality, progress and happiness.

When the king became one of the Brethren of Light, he was determined to spread the gospel of The Religion of the Stars even as The Church of Light has determined to spread it throughout the world today. But having allied himself with the Legions of Light, he could no longer bear the name of Amen, a name which was associated with orthodox religion; for orthodoxy then, as now, kept people in spiritual darkness. He therefore renounced the name Amenhotep, and took the name Akhenaten, which means living in the Light. The details of his life and teachings, during the ten or eleven years he disseminated The Stellarian Religion before orthodoxy succeeded in bringing about his death, are set forth in the reference book, Astrological Lore of All Ages.

The orthodox religion of Egypt was no such simple system as that found in Mesopotamia. The Egyptian populace seem to have been cursed with the inability to forget or discard any belief once held. From time to time new gods and beliefs were adopted, but the old ones were not discarded.

Egypt in ancient times was divided into more than forty little principalities, called "nomes." Each nome, in addition to whatever gods it absorbed from without, had its own special god. This god frequently was worshipped in the form of some animal.

In so brief a space no attempt can be made to enumerate the gods of ancient Egypt. For this see, A Handbook of Egyptian Religion, by Adolf Erman; and the works of Wallace Budge on The Gods of Ancient Egypt. These gods, for the most part, seem to be secondary deities; for as far back as we have records we find in Egypt the grand idea of Divine Unity. Thus Herodotus states that the Egyptians of Thebes recognized a single god, who had no beginning, and who was to have no end of days; a statement confirmed by the sacred texts. Corresponding to the mother-god, Ishtar, of the Chaldeans, was Isis of Egypt. Osiris seems to have been the father-god, the creator.

And the son, the god of light, was Horus. In Chaldea, Tiamant was the god of darkness and evil, and the Chaldean mythology largely revolves around encounters in which Marduk, the god of light, vanquishes Tiamant. And in like manner Egyptian mythology largely revolves around encounters in which Horus, god of light, in the end defeats Set, the god of darkness.

Due to the continuous fluctuating names given the deities, sometimes it is Osiris, as god of light, who is pitted against Set. Osiris, again, was the sun of the lower hemisphere, Horus being the rising sun, Ra the sun at noon, and Kheper the sun when it produces and nourishes life. The sun thus became the symbol of the one supreme deity, and its journey about the earth typified the journey of the human soul. The soul, like the immortal Ra, the sun, when it descends into the tomb, is resurrected to lead a new life.

The outstanding feature of the religions of ancient Egypt is the universality of the belief that the soul lives in another region after the death of the physical body. In this after life the soul encounters certain obstacles to its progress, which may be overcome by adhering to a specific line of conduct and reciting appropriate hymns, prayers, and orations. The whole body of Egyptian religious literature has for its primary object the care of the soul after death. This literature is chiefly embodied in the Egyptian Book of the Dead.

Relative to these beliefs I will quote two paragraphs from E. A. Wallace Budge's, *The Book of the Dead*, a volume which may be consulted for further particulars:

“Osiris was the God-man through whose suffering and death the Egyptian hoped that he might rise again in a glorified Spirit-body, and to him who had conquered death and had become the king of the other world the Egyptian appealed in prayer for eternal life through his victory and power. In every funeral inscription known to us, from the Pyramid Texts down to the roughly written prayers upon coffins of the Roman period, what is done for Osiris is done for the deceased, the state and condition of Osiris are the state and condition of the deceased; in a word the deceased is identified with Osiris.”

“The preservation of the body was of vital importance, because the dogma of Osiris taught that from it would spring the translucent, transparent, immaterial, refulgent and glorious envelope in which the Spirit-soul of the deceased would take up its abode with all his mental and spiritual attributes.”

In this after life the good deeds done in the flesh are weighed against the evil deeds, and the soul is judged accordingly. Only the extremely wicked were supposed to be condemned, after much suffering, to final extinction.

The Egyptians also believed in, and practiced, what is now called psychokinesis, and was then known as magic.

In later times astrology was extensively practiced. At this date it is difficult to determine how early and how widely the priests were devoted to astrology. It is highly probable that only those who belonged to certain secret organizations were

initiated into astrological lore. We do, however, have positive evidence of very early and very comprehensive astronomical knowledge, and in those days astronomy seems to have been studied only in behalf of astrology. Thus the Solar Calendar was introduced into Egypt in 4,241 B.C., and is the earliest dated event in history. The earliest year list, dated from some event as we date from A.D., is the Palermo Stone of Egypt, beginning 3,400 B.C. and continuing without a break for 700 years.

The workmanship of the temple of Denderah seems to be of rather a late period, but also appears to be built upon a succession of older buildings dating back to very early times. Upon the ceiling of this temple is pictured a great zodiac showing the vernal equinox in the sign Virgo, where it was about 13,000 years ago. The Great Pyramid of Gizeh was built by Cheops, requiring the full period of his reign, 2789-2767 for its construction. Embodied in its measurements are as precise and as great a knowledge of astronomy as possessed by modern astronomers, and also in its symbolism is embodied the ancient Hermetic Doctrines.

Crete

—We are apt to consider the Greece of Homer's time as ancient; but recent excavations in Crete show there was an Aegean civilization extending into Crete, Cyprus, Greece, Asia Minor, Sicily and South Italy. This is not far from Egypt geographically, and it is apparent that some time in the past this culture developed from the same heliolithic ideas as that of Egypt, Mesopotamia and the other ancient centers of civilizations. And H. G. Wells holds that it is equally as old as that of Egypt, and that its inhabitants had become a people of sea commerce as far back as 4,000 B.C.

Although their writing has not yet been deciphered, it seems quite certain that Crete was united under one ruler, who was called Minos, about 2,500 B.C. From this time on until the disruption of the Empire about 1,400 B.C., there was a very high degree of civilization, including water pipes, bathrooms, pottery, textiles, ivory and metal inlaid work that has not been surpassed in quality, and female styles that include corsets and flounced dresses.

Peru

—Somewhat paralleling the civilizations of Egypt in Africa, Crete in the Mediterranean, Sumeria in Mesopotamia, and that of China and India in Asia, though never rising to so great a height, and probably being of much later date, there developed in America two apparently independent centers of culture. These were the Peruvians in South America and the Maya in Mexico.

Both of these people were of the Mongolian-American group, and both show indisputable evidence of rising directly from the heliolithic culture. From picture writing the Maya developed a hieroglyphic script. But this was used chiefly in keeping records in connection with the calendar system. The Peruvians seem not to

have gone farther than crude picture writing, but developed a system of keeping records by means of knots tied on variously colored and variously shaped strings.

It would seem that at least for a very long time there had been no more intercourse between Peru and Mexico than there had been at the beginning of their civilizations between Egypt and Sumeria. The potato, for instance, was one of the chief agricultural products of Peru, yet the Mexicans had never heard of it. Both people, however, worked in bronze and copper and in silver and gold. They were skilled in stone construction, made excellent pottery, did weaving, and were skilled in the use of dyes. Their architecture was of a very high order.

Among the Pre Incas knowledge of the stars and the spiritual teachings were in the custody of the Stellar Priests. Seven hundred years before the coming of the first Spaniards this people had a white granite city some distance down from the 14,000 foot Continental Divide of the Andes toward the Amazon. It consisted of 400 hewn stone houses. The temple was built of irregular, dissimilar, many joined stones of gigantic size fitted with Pre Inca nicety. One block in it is 14 feet long and 8 feet high. The city is called Manchu Picchu. Further details are given in the reference book, *Astrological Lore of All Ages*.

In America, among the Maya in Mexico and the Peruvians in South America, much the same beliefs prevailed in regard to magic, spirit communion, astrology, and the reward for righteousness, that we find among the Chinese. Each of these three peoples had great veneration for the movements of the heavenly bodies and ordered their lives largely through astrological considerations. When the first White men reached Peru they found at Curzco a great temple of the sun, in which was a huge sun of gold representing the figure of a human face surrounded by golden rays, so placed as to receive the first beams of the rising sun. The sun was the chief deity, the moon and stars were subordinate deities, and there was an order of Vestal Virgins. They were set apart at an early age for duty in the temple and to preserve the sacred fire there kept burning.

The religious ceremonies were numerous and elaborate and associated with festivals which were held at those times when the heavenly bodies were properly situated. They were for the purpose of securing rain, averting evil, producing abundant harvest, and other ends too numerous to mention. The burning of incense and offering of sacrifice to the various gods formed a part of these ceremonies, on very rare occasions human sacrifices being offered.

Mexico

—More is known of the religion of the early inhabitants of Mexico and Central America, because the string records of the Peruvians are not so well understood as the hieroglyphics of the Maya. With the latter the calendar is by far the most important religious feature. Not only were all religious observances according to the calendar, but an elaborate system of divination was worked out by the priests, whose

duty it was to note the movements of the planets. They had also observed that Venus disappears for eight days between the last glimpse of her in the West and the first glimpse of her as a morning star in the East, and that the same phases of Venus come back in about 548 days, so that five Venus years are equal to practically eight ordinary years. From this, in addition to an annual calendar, they had computed a Venus calendar.

Dr. Spinden, of Harvard, announced in December, 1925, that he had deciphered this Venus calendar, and that it was finally put in working order between two risings of Venus as morning star in conjunction with the summer solstices of 538 and 530 B.C. He has also proved that the first date on which the Maya gave each day its consecutive number, so that the records subsequently are complete, was August 6, 613 B.C., and that the perfected annual calendar was inaugurated on the winter solstice 580 B.C. Back of these perfected calendars must lie age long astronomical observations.

The sun was the chief deity of the Maya. He ruled the East. The god of storm ruled the North, the god of maize ruled the West, and the death-god ruled the South. There was a bat-god of the under world, and each day was ruled over by a special spirit. The unseen universe was peopled with such spirits, to whom sacrifices were made for special purposes. And to facilitate matters, images were made of stone, pottery, and other substances, of these spiritual entities, and the sacrifices made before the image. Such images, of course, are mere symbols of unseen presences and powers; therefore let no one who has ever knelt before a cross, or bowed his head in the presence of the image of a saint scoff at such modes of worship. There was also a system of confession by which through gifts and offering of some of his own blood obtained by pricking his veins, the penitent might obtain, through priestly intercession, absolution for sins. Sacrifices were made at time of planting, for harvest, for rain, and for many other boons. In time of national crisis, prisoners of war were offered as human sacrifices. As time passed human sacrifices became more numerous. Later, among the Aztecs, thousands of human beings were sacrificed to appease the angry gods, their hearts being torn out of the living bodies of the victims and held quivering aloft. Thus in the New World a priesthood developed which drenched the country with the blood of the innocent, even as in the Old World countless innocents were sacrificed by no less cruel means for heresy, all in the name of religion, but of religion gone to seed. Further details of the astrology of the Maya and the astrology of the Aztecs is given in the reference book, *Astrological Lore of All Ages*.

China

—Our first view of China is as a great empire, or group of principalities, about 2,700 B.C. to 2,400 B.C., ruled over successively by five emperors. The people are of the Mongolian-American group. They spread from the ten fertile valleys of the Tarim down into the valley of the Hwang-ho and later to the valley of the Yangtse-kiang. They also spread from the south, where they mingled with the heliolithic culture

people of Siam and Burma. Furthermore, as far back as we are able to trace them, they were in possession of writing.

This writing, from its form, evidently developed from pictographs through ideographs and phonograms. But when it reached the phonetic stage, due to the fact that the Chinese language consists of a very few simple monosyllabic sounds, it necessarily departed quite markedly from the writing developed in other lands. Thus in Chinese, there being no grammar, the same word when spoken is used to denote a large number of things. The particular picture of some object signified by the spoken word—usually a picture easily drawn—was used to signify any one of the numerous things denoted by the spoken word. In addition to this picture, representing the sound of the word, there was also necessary another picture to signify which of the various ideas was meant. It was thus possible to express practically any idea.

The second sign which gives precision to the first picture is called a determinative. Determinatives were also used in the Egyptian hieroglyphics. But the Egyptian language did not need such a complicated system of signs to express itself phonetically.

Because of the peculiar makeup of the Chinese spoken language it became necessary to use an almost unlimited number of written characters to express it. And for convenience in writing them with a brush, the pictures were abbreviated and conventionalized and represented by groups of marks each of which it was possible to make by a stroke of the brush. Such groups of brush marks gradually lost semblance to the original pictures, and it became necessary for anyone desiring to read or write Chinese to memorize a vast number of complex signs. This, because it required so much time and effort, developed a special literary class, the mandarins, who also became the rulers. And even among these it took so long to learn to read and write that it would seem they had little time left for other lines of thought. Furthermore, in learning the Chinese characters they spent so much time with the traditional literature of the country that these ideas gained a firm hold upon their minds. To such an extent is this true that it is with the utmost difficulty that they are replaced by more up to date notions.

That which is of more interest to us here, however, is that at the very commencement of authentic knowledge about the Chinese we find them with a knowledge of medicine, with a knowledge of astronomy, and in possession of the civilized arts and industries. Neither their writing nor their culture was obtained from, nor in any appreciable degree influenced by, Egypt or Mesopotamia. It seems to have been derived with them from a common source, but so far in the past that its subsequent development made of it a great contrast in every way to that developed in any other part of the world.

Book 12-2

Copyright
August 2002
Church of Light

Natural Alchemy Evolution of Religion

Chapter 1

Serial No. 133
Original Copyright 1949
Elbert Benjamine

Copyright
August 2002
Church of Light

The Foundations of Religion

Chapter 1

The Foundations of Religion

PRIMARILY the drive of all life is to attain significance. Attached to each life form through psychokinesis is a soul moving through its Cycle of Necessity. To attain significance it must express its potentialities. To express its potentialities through a physical form it must secure nutrition and protection for that form. And to provide opportunity for other souls to express their potentialities through a physical form, it must exercise the drive for reproduction.

Every step in evolution on this earth has been in response to one or more of these drives: the drive for nutrition, the drive for reproduction, or the drive for significance. And every step in evolution has been in the direction of attaining greater success in the fulfillment of one or more of these three drives.

In response to these drives the protozoa developed from some simpler form of life, then the sponges developed, then the jelly-fishes, then the flat-worms, then the round-worms, then the wheel-worms, then the bryozoa, then the star-fishes, then the worms, then the crayfish, then the oysters, then the vertebrate animals, and finally man. It took over 1,700 million years of struggle to move thus upward and develop the form of man, but every step on the way was in the direction of significance through greater freedom of expression.

Furthermore, every step of progress made by man also has been in response to these three drives, and has found more ample expression for one or more of them. The adaptations made by man, instead of being modifications of his body, have been through the use of intelligence. Since he developed from an early type of Propliopithecus, the ancestor he had in common with the anthropoids some 30 million years ago, he has directed his intelligence to solving the problem of survival and providing for his offspring and of more ample expression. And he has moved forward extraordinarily in the successful expression of all three drives in so far as the physical span of life is concerned.

But even as now university scientists have demonstrated that man possesses extrasensory perception by which he can gain information of the past, present and future not accessible to the physical senses and reason, so by this faculty primitive man sensed Deity. And by this faculty he also sensed the inner-plane environment

and recognized that it, as well as the outer-plane environment, exercised a profound influence over his life.

And even as now university scientists have demonstrated that man possesses the faculty of psychokinesis, by which physical objects can be moved by the nonphysical power of the mind, so primitive man also recognized this faculty, and tried to employ it for his own benefit. The use of what is now recognized as psychokinesis in the past has been called magic.

Scientists experimenting with psychic phenomena, and collecting data on their spontaneous occurrence, have during the past 67 years produced ample evidence that the personality of man lives beyond the tomb, and that those who have died sometimes appear to those yet in physical bodies, and on other occasions communicate with those still in the flesh. And primitive man, clairvoyantly seeing a relative or a friend who had died, or telepathically getting some warning or other message from someone long dead, quite logically concluded that some part of man lived after the dissolution of his physical body.

Anyone today who will learn to erect a birth-chart and work progressed aspects can demonstrate to himself that the inner-plane weather mapped by astrology profoundly influences his life. And, while he did not possess the ability to erect a birth-chart, primitive man sensed, and quite correctly, that the positions of the heavenly bodies have an influence over humanity and its affairs.

As all life is struggling for survival so that it can continue to express, and for the means of more ample expression, and primitive man was convinced through his deceased relatives visiting him that there was some kind of survival beyond the physical, it was quite natural that he should try to find the way to live on earth which would assure him continued life after he had left the physical. And that he should seek means by which in that after-life he could realize the drive for nutrition, the drive for reproduction and the drive for significance which have been the moving power behind all progress of life on earth. The effort more adequately to adapt himself to life on earth through understanding and employing inner-plane energies, and to continue to find satisfaction for the three irrepressible drives after physical dissolution, came in later times to be called his religion.

Instead of some foggy notion as to what religion is, all should recognize that today and at all times in the past it consists of the effort to employ nonphysical means to find on earth more ample satisfaction for the drive for nutrition, the drive for reproduction and the drive for significance, and to continue to find satisfaction for these three drives for as long a period as possible on the inner plane. In their expanded form, the drive for nutrition embraces all means of survival, the drive for reproduction embraces mental creation as well as physical progeny, and the drive for significance embraces the various means of expression.

Primitive man had little understanding of either the physical world or the inner-plane world. Knowledge is derived from experience. And to be of much value experience must be correctly interpreted. Primitive man gradually acquired information about

both the outer-plane environment and the inner-plane environment, and this information was handed down from one generation to another by word of mouth. But not only was the interpretation often erroneous, but the amount of information that could be handed down from generation to generation orally was limited. It was limited by the experiences and interpretations of individuals who sought to make it the property of the tribe; and it was limited by the ability of members of the tribe to remember what they had been told.

When through the accumulation and application of knowledge gradually gained over millenniums ancient civilizations finally came into existence, the crude pictographs by which more primitive people had sought to convey ideas and refresh their memories gradually were developed into writing by which records could be permanently made.

This tremendously aided man in the acquisition of knowledge; for he was no longer dependent upon anyone's memory to give him access to information based upon the experiences of generations upon generations of the past. To the extent these were recorded, those having access to the records could greatly expand what they knew.

But what was thus recorded often was sadly limited and frequently distorted, even when the experiences and the opinions were highly valuable and quite sound. Often it has been the case that if the people were given the facts, these facts would cause them to interfere with the plans and ambitions of certain powerful persons. These individuals then, as now, therefore, did all in their power either to suppress the facts, or to distort them in a way favorable to themselves, and thus information that otherwise would have been recorded and made available to others was never at their disposal.

This has been true relative to information about the physical plane; and scientists—as explained in lesson No. 125—often have been unable to get discoveries before the public because it would deprive some powerful individual or group of means of gaining additional power or wealth. In our own day, for example, there are many known instances in which great monopolies have purchased some invention and withheld it from the public because if it were used it would outmode and make unsaleable their products, for the production and promotion of which they had spent vast sums of money, and on which they depended to gain great wealth.

And throughout the past new and valuable information about the inner plane often has been suppressed or distorted because it would discredit the medicine man, or priest, or other religious authority, and deprive him either of his livelihood or his significance as the mouthpiece of God.

Yet, as man must depend not upon new mutations of his body, but upon additional knowledge for all further progress toward greater nutrition, greater benefits for offspring, and greater significance through more ample expression, both relative to the physical plane and the inner plane his only hope of bettering his condition either here or hereafter is through increasing and using knowledge of these two environments and the laws operating in each.

Thus to increase his knowledge, not only must the experiences of people be collected and analyzed and given sound interpretation, but there at all times must be additional research. And this applies with equal force to both planes; for man desires to find expression for the three irrepressible drives not merely during his physical life, but also after life on earth is done.

But in addition to acquiring new information relative to both planes, and giving it sound interpretation, if mankind is to benefit by this knowledge it must have ready access to it, and the facilities for using the knowledge thus acquired. This means that ways must be devised by which those with whose special privileges it would interfere to have people know the facts of both planes, whatever they may be, cannot suppress or distort the facts.

All should be made to recognize that neither science nor religion should remain static. Each should continue to develop and progress indefinitely. The aim of religion, whether so recognized by those who embrace it or not, is to afford optimum living for those who adhere to it. And to attain optimum living, effort must be made energetically and persistently to acquire as many new and significant facts as possible about the physical world and about the inner-plane world. As fast as such new and significant facts are discovered they should be included in religion in their proper relation to all facts about both planes already known.

It is not because it possesses all knowledge now, but because it strives energetically thus to gain new and important facts relative to both planes, and to incorporate them properly into its teachings as soon as they are adequately verified, and thus moves progressively ever in the direction of more perfectly teaching mankind optimum living, that The Religion of the Stars is the world religion of the future.

The Truth Alone Can Make Men Free

—While experience and extrasensory perception taught types of life lower in the scale of evolution than man methods of solving the problems with which they were faced, frequently the only avenue for the survival of their progeny lay in some quite drastic change of form. Scales had to be changed into fur or feather when the climate became icy; and herbivorous animals had to change the structure of their teeth when forced to graze on the tough grass of the plains instead of the tender browse of succulent shrubs and trees to which they had become accustomed before increasing aridity eliminated such food. But with the advent of man, whatever adaptation is necessary, not only to realize the drive for nutrition and reproduction, but also to realize the drive for significance, can far better be accomplished through the use of knowledge. Whatever man seeks to accomplish, in this life or the next, can be done to better advantage if he guides his efforts by adequate information.

Creatures lower in the scale of life than man, not having had the experience of their ancestors, or of other living members of the species, accessible to them through oral or written language, have had to rely largely upon instinct to guide their behavior.

Instinct derives from the information perceived by the unconscious mind. In the case of animals lower than man, as reason has not been developed, the exercise of instinct is largely confined to such conditions as have habitually confronted the race. Under usual conditions instinct is quite efficient; but as the unconscious of animals has had little experience meeting other than certain kinds of problems, when unusual problems are presented instinct often leads the animal astray. In spite of extrasensory perception which may prompt different behavior, the habitual method of meeting conditions is so strong that other promptings are overruled.

The instinctive method of meeting a particular situation is brought about through the habitual emotional reaction to the situation. In regions inhabited by man, deer have learned that the sound of a breaking stick often indicates the presence of a hunter. In such regions, whether a man is or is not present, the sound of a breaking stick arouses the emotion of fear in deer, and as a result the habitual reaction is to run from the sound of a breaking stick without investigating its cause.

The ancestors of the best known European lemming (*Lemmus lemmus*), a rodent about six inches long which inhabits the mountainous regions of Sweden and Norway, had found it advantageous at certain periods at the approach of winter to migrate in great number. At some ancient date the persistence and determination with which such migration was carried out probably prevented their extinction by taking them to a region where new food and other conditions were highly favorable. And thus also the religious instinct which impels people today to follow with equal persistence and determination the way to salvation believed in by their forefathers may have benefitted their ancestors.

But conditions in the world have now changed, and that which served the ancestors of the lemmings so well, and that which served the ancestors of man the best that religion could then afford, now lead both to disaster. The lemmings still migrate in vast multitudes, and people still follow the doctrine of vicarious atonement in great hoards. Both move in a straight line. The lemmings move in parallel columns, and nothing will induce them to deviate from the direct course they are taking. As a consequence of their stubborn resistance to new conditions that have arisen since their ancestors developed the emotional reaction to which they continue to respond, the vast migration when it reaches the last of the land—and it is inevitable that moving far enough in a straight line it must reach the last of the land—moves into the sea and all are drowned.

There is no intention here to disparage the usefulness of emotions. It is the way men feel, as well as the way the lemmings feel, that determines their behavior. Emotions are merely the release of tensions created by desires that are strong enough to develop a profound and widespread disturbance of the nerve currents. Desire is energy in a potential state, straining to be released and given activity. And both desire and emotion are due to the conditioning of certain thought-cell groups within the soul, or unconscious mind. Every activity of the mind and body, great or small, is due to the discharge of the energy which while stored and straining is called desire. Therefore, whatever the behavior of a man or an animal may be, it is due to desire; and as

emotion is the release of a desire so powerful that it liberates hormones from the endocrine glands into the blood stream and thus affects the nervous system, including the brain, and often various physical functions, emotion is one of the most useful tools any man can employ.

It is the tool which he must use to get what he wants; for it directs his actions. And it must be employed in gaining spirituality, as spirituality depends upon the dominant vibratory rate, and this is chiefly determined by the individual's habitual emotional states. But if he is to use it to get what he wants, instead of permitting it to impel him to march across the mountains and into the sea to be drowned, he must guide it by that which makes man superior to other animals. Instead of permitting it to drive him blindly into unreasonable courses of conduct, or into unreasonable beliefs, he must condition his emotions to conform to knowledge.

Within us all are stored the desires of our animal ancestors. Civilization, in great extent, may be measured by the degree in which certain of these bestial desires have been sublimated, have been channeled to express in behavior beneficial to society. And within us all are stored other desires which we acquired from our parents and associates during the highly impressionable years of our childhood. But if the desires thus acquired, which express as emotional reaction, tend to prejudice us toward facts and make us unwilling, or unable, to give a fair and logical appraisal of the significance of facts which are brought to our attention, we are reacting to emotion in the manner the lemmings do. And if we continue such unreasonable reaction our ultimate fate will parallel theirs.

The success of every undertaking in which man engages depends upon two things; the extent of his knowledge and the extent to which he follows the actions indicated by knowledge instead of those dictated by blind belief or prompted by irrational emotion. This applies to his health, his business career, his family life, his social success, his happiness, his spirituality, and to all other departments of his physical life. And it applies with equal validity to gaining what he wants in the life beyond the tomb. It is no more sensible for him to think that blind belief in some ancient or modern propaganda will give him happiness in the next life than it is for him to believe that blind belief in some present-day non-factual propaganda will get him what he wants here. And most have had experience enough to have learned that if they put their trust in non-factual sales talks here, they will lose their shirts. Those who rely on such propaganda in business are known in the vernacular as suckers.

Those in politics and those in religion, however, who want to make converts to some belief not based on logic and facts, commonly use one or all of three methods. As explained in lesson No. 125, they employ fear—fear of persecution in this life or of torture or misery in the life to come, whether that life is on another plane or reincarnated on earth—and other means to prevent the prospective convert from gaining the facts. Or they give an inversive twist to the facts and disseminate lies. Or they use the habitual emotional reactions of the prospective convert to override his reason and cause him to believe and act as the propagandist desires. Just how this is accomplished is explained in detail in lesson No. 188.

Here it is enough to point out that early in life most people have been so conditioned that they respond emotionally in a specific manner to certain phrases, certain words, and certain ideas. And the clever propagandist associates the ideas which he wants his prospective convert to believe with phrases, words and ideas which commonly bring a strong and favorable emotional reaction; and he associates the ideas he wishes to disparage with phrases, words and ideas which commonly bring a strong emotional revulsion.

We must realize in our effort to establish a sound religion and a higher civilization that the vast majority of people have not as yet evolved sufficiently above other animals not to be more powerfully influenced by their habitual emotional reactions—which have been thus conditioned early in life before reasoning powers were much developed—than by facts and logic. Therefore it is a major part of the task of all Stellarians to educate those they contact to consider facts, whatever they may be, unemotionally, and to weigh all facts without emotional prejudice, and to arrive at conclusions through logical consideration of all available facts. When the evidence is all in and a just and reasonable verdict reached is when emotion should be released to insure actions based upon that verdict.

Truth is the conformity of cognition to reality. Only if we are aware of reality can we act in the proper manner. And this applies to politics, to religion, to business and to every department of life. But we cannot learn the truth if facts are suppressed, if facts are distorted, if we believe in falsehoods, or if through early conditioning our emotions will not permit us to consider facts which are presented to us, or if these emotions censor or distort logical conclusions arrived at from a consideration of all the available facts.

It is a sad commentary on the evolutionary level of our civilization when public opinion condemns certain people for presenting facts that seem favorable to any political or religious movement. Anything conceivable warrants having all the facts about it known and given thorough discussion. If it is something inimical, the facts logically handled will prove it inimical. If it is something beneficial, the facts logically handled will prove it beneficial. But if, as most things have, it has some good points and some bad points, when all the facts are brought out and given full public discussion, each will be revealed, and thus people will be able to reject the detrimental factors and adopt those beneficial.

There is only one logical reason why those in political authority or those in religious authority should try to prevent all the facts being made available and given thorough public discussion. That reason is that they fear the facts and the logical conclusions drawn from them will interfere with their own special privileges.

People can only be free from want when they have the truth and act upon it; they can only be free from fear when they have the truth and act upon it; and they can only have freedom of expression when they have the truth and act upon it. It is the truth alone which can make men free. And people can learn the truth, and thus be able to

act upon it, only when there is freedom of information, and freedom to discuss before the public the logical conclusions to be derived from such information.

Such freedom of information, and freedom publicly to discuss the logical implications derived from all available facts, is even more important where religion is concerned; for religion should consider freedom from want, freedom from fear and freedom of expression not merely on the physical plane, but how best they can be acquired also when life on earth is done.

To this end religion should acquire as many significant facts as possible about both planes, and advocate the type of life that in greatest measure will insure these freedoms both here and hereafter. It is because this is what The Religion of the Stars does that it is the world religion of the future.

Naturism

—Now that we have discussed just what religion is, and exactly what an adequate religion should do, let us consider the various steps by which religion has reached the stage of its development common in the world today. To do this we should start with the belief called Naturism, which as man developed from his non-human ancestors it is assumed was his first religion. It is the belief that various things usually considered by us as having no life are alive and act much as living creatures do. As man developed self consciousness and moved to a state slightly higher than the more intelligent nonhuman animals, it is assumed he came gradually, and at first dimly, to distinguish the difference between himself and other objects.

At this stage it is assumed that if a tree moved in the wind, or a rock rolled down a mountain, or a log floated down a stream, he had the vague notion that it moved by its own self-power even as he moved by his. At this time, which is considered as that of transition to the human stage, he is supposed to have had no conception that his body and mind were different, no ideas about an after life, or that things were either natural or supernatural, and no thoughts concerning spirits. Like other animals he was supposed to be conscious of forces which he did not understand, and regarded these forces as other entities not wholly unlike himself. And because he did not understand, he feared them.

The classical example of the process by which Naturism, a religion so primitive that no people in the world today have not advanced above it, is an experiment by Mr. Romanes with one of his Skye Terriers (*Evolutional Ethics and Animal Psychology*, p. 355):

“He used to play with dry bones by tossing them in the air, throwing them to a distance, and generally giving them an appearance of animation, in order to give himself the ideal pleasure of worrying them. On one occasion I tied a long and fine thread to a dry bone and gave him the latter to play with. After he had tossed it about for a short time, I took the opportunity, when it had fallen at a distance from him and while he was following it up, of gently drawing it away from him by means of the

long, invisible thread. Instantly his whole demeanor changed. The bone, which he had previously pretended to be alive, began to look as if it were really alive, and his astonishment knew no bounds. He first approached it with nervous caution, but, as the slow receding motion continued and he became quite certain that the movement could not be accounted for by any residuum of forces which he had himself communicated, his astonishment developed into dread, and he ran to conceal himself under some articles of furniture, there to behold at a distance the ‘uncanny’ spectacle of a dry bone coming to life.”

While Naturism is a hypothetical stage which is assumed to bridge the gap between the intelligence of higher non-human animals and the religion termed Animism, we are not compelled to observe the savages to find behavior which in many respects parallels that of the Skye Terrier. Many people today in the presence of extrasensory perception or witnessing psychokinetic phenomena, or called upon to examine either, or to test out astrology for themselves, like the Skye Terrier, retreat to what they believe to be a place of safety. Instead of boldly investigating the inner-plane faculties and conditions, including astrology, and trying to find out how they occur and how they can be made to operate for human benefit, they fearfully state that all such things should be left alone, or if they are religiously inclined they piously state that all such things are the work of the devil.

Yet even in the hypothetical religion of Naturism there is, as in all religions, an element of truth. Professor Chunder Bose, D.Sc., a native of India educated in England, some years ago conducted a long line of experiments which he published in a book, *Response in the Living and the Non-Living*, that prove conclusively that any form of matter may be alive, intelligent and sensitive, and that the difference between a man and a metal, or a man and a vegetable is more one of degree than of kind. He demonstrated the results of his investigations before the leading scientists of London, and they were accepted as correct. The startling fact derived from these experiments is that all metals, and to an extent all substances, exhibit in some degree, the same kind of sensitiveness observed in the human nervous system.

The Skye Terrier overestimated the power of life in the bone, and no doubt the savage overestimates the power of life in various other things. For such exaggerated views we are warranted in calling either the Skye Terrier or the savage superstitious. But what are we to call the citizens of civilized society who equally underestimate the life and sensitivity of minerals, plants and animals, and who ignorantly refuse to recognize phenomena which are manifestations of inner-plane forces?

Animism

—From Naturism to Animism is but a step. In Naturism there is no notion of spirit. But in animism man has arrived at the conception that he is a spirit occupying a body. Having arrived at the belief that man has a spirit he takes another step and concludes that birds and beasts and plants and insects and even stones also have invisible doubles. And the fact that they actually do is being verified by scientific psychical

researchers today. If the ghosts of dogs and horses manifest to civilized people, instances of which are given in lesson No. 131, why should not the ghosts of other animals be seen by uncivilized people?

Animism is the religion that behind the various material and visible objects are invisible and perhaps intelligent forces that use these objects for expression. Furthermore, as usually believed in, it peoples the world with spirits of various kinds that, though unseen, nevertheless, under certain circumstances, may exert an influence upon human life.

It is ranked as the lowest religion of known savages today. And Mr. Risley in 1901 reported his belief that Animism existed in its lowest form as the religion of the jungle dwellers in Chota Nagpur, India. He reported that the various spirits which are there believed in and propitiated are indeterminate in nature and represented by no symbol. All over Chota Nagpur, he reported, there were sacred groves where these spirits, which have not yet been given individual attributes, are supposed to dwell. He concludes that this hazy belief represents a transition from an impersonal religion toward well defined Animism.

Undoubtedly savages draw wrong inferences from what they see, as does more civilized man. But there is a vast amount of carefully collected documentary evidence proving that the spirits of the dead return and are seen and communicate with those yet living. There is also a large amount of carefully collected documentary evidence that there are spirits other than human beings that cause material objects to move and various other violent phenomena to take place. Instances of both human and non-human hauntings are given in detail in *Haunted Houses*, by Camille Flammarion, and the whole subject is thoroughly discussed in lessons No. 43, No. 44 and No. 45.

Non-human spirits (astral entities) are at the present day called “poltergeists.” They are also called “elementals.” There is no reason to believe that materializations, etherealizations, table-tipping, and such phenomena are confined to present-day civilization. On the contrary, the evidence indicates that all manner of supernormal phenomena take place more frequently among primitive peoples than among those who have been educated to believe such things are impossible. Nevertheless, thousands of people, many of whom are educated and highly cultured, are at the present day willing to swear that they have talked to loved ones who have passed from the physical body. Among these are some of the world’s greatest scientists who have taken every precaution not to be deluded.

Primitive man believed not only in the existence of the spirits of his ancestors, but also in elemental spirits. If, as related in *Haunted Houses*, Chapter XI, noises like a thunderclap are produced on the roof of the house, stones are dropped through the roof without there being an opening in it, stones are thrown from a distance through windowpanes with unbelievable marksmanship, chairs and tables overthrown, and other manifestations take place without any discoverable human agency, why should not the savage believe in elemental spirits?

Among his people there would be some, just as there are clairvoyants at the present time, who would be able to see these elemental spirits. No doubt the savage would at times overestimate the importance of the part played in natural phenomena by these elementals. But as to this we cannot be certain, because modern man has not investigated how little or how great a part is played by elementals in wind and lightning and such physical forces.

But as to the efficacy of prayer to invoke psychokinetic power that influences such forces of nature considerable evidence has been collected. Mr. Rawson, a man of considerable attainment in commercial and scientific lines, wrote a booklet, "Protection for Garden and Farm," through prayer. And I have been told by three witnesses of the event—two witnesses being encountered a dozen years later than the other and in widely separated districts, and one at least having no incentive for prevarication as he was antagonistic to the Mormon faith—of a time of great drought that was broken by a venerable Mormon Bishop through prayer. The Bishop, who was a very old and holy man, went with the people of the town to a nearby hill and commenced to pray in an earnest and quavering voice. In a little while a cloud no bigger in appearance than one's hand formed overhead and began to grow in size. Before long it began to sprinkle and then the people disbanded and went home in the rain, the drought completely broken.

The American Hopi Indian snake dance (picture page 2) described in the reference book, *Astrological Lore of All Ages*, is to enable the Indians to contact their friends on the inner plane, and procure help, among other things, in warding off drought. Frequently the spectators of this impressive ceremony of an arid region are drenched with rain before they reach home.

Just how psychokinesis operates to produce or protect from natural phenomena, or to what extent it has power over them, awaits further investigation. But it explains why those believing in Animism propitiate elemental powers which some of their members see, and which they witness bring events of consequence to pass.

The conditions governing poltergeist phenomena are so little understood today that it is probable savages also fail to grasp fully the means by which elementals are able to produce physical results. No doubt their prayers and oblations to the elemental spirits, which they conceive to be behind natural happenings, often fail to bring about results. But also it is quite possible, especially when persons are involved who have considerable natural psychokinetic ability, that occasionally actual results follow the propitiation of elemental spirits. There are plenty of people today who believe that through earnest prayer they can be protected from injury by storm or flood. Some of these people cite very convincing instances to support their belief. Therefore, until evidence is collected about the power of psychokinesis to render such protection, we must not accuse the savage of having an altogether vicious superstition.

To give a list of the peoples of the world whose religion is largely that of Animism would be to name most of the uncivilized tribes, and many of the people who possess a civilized culture. Let us then take the next step, which is to consider fetishism.

Fetishism

—Fetishism is the belief that certain material objects, either in their natural state, or when prepared according to a special ritual by a priest, have the power of bringing the fulfillment of a hope.

In World War II innumerable soldiers wore St. Christopher medals in the belief the medal would protect them from danger and deliver them from death. The person who hangs a horseshoe over his door to bring luck is practicing fetishism. To pick up a pin, as some people do, instigated by the adage, “See a pin and pick it up, all the day you will have good luck,” is fetishism. Wearing a rabbit’s foot to keep evil influences at a distance is fetishism. The belief that good luck will follow looking at the New Moon over the right shoulder is fetishism.

Professor E. Washburn Hopkins, of Yale, in his *History of Religion*, states in regard to the word fetish that: “Many writers use the word loosely to indicate any material object from which, like a mascot, the savage expects good luck; but properly a fetish is portable and is unlike a mascot in that it possesses power and will to bless. Hence it is coddled, abused, prayed to and stormed at, exactly as one would treat a recalcitrant spirit who may or may not aid.” He also says that a fetish is a spiritual power; and does not contain a spirit.

In those places where fetishism is most prevalent, it seems to me very difficult to draw the line between true fetishism, as Professor Hopkins defines it, and allied beliefs. Thus it is a common belief, not merely among savages, but among some civilized peoples, that a curse, placed by a person dying a violent death, upon some coveted object, has an evil spirit thus attached to it that will bring bad luck to all possessors of the object afterwards. At the present day we would not call it an evil spirit, but a thought-force of evil psychokinetic power thus attached to the object.

One who will look carefully into the history of famous jewels, such as the Hope Diamond, will find a strange verification of the belief that evil befalls the owner of certain gems. Certain mummies taken from Egyptian tombs, and now in the British Museum, also have had an uncanny history of tragedy overtaking anyone possessing or handling them. These influences, by those who believe in them, are thought to be caused by elemental spirits that were attached to the objects by curses.

In *The Jungle Folk of Africa*, Robert H. Milligan, who lived among them as a missionary says of the Fang tribe of West Africa: “Ancestor worship is the highest form of African fetishism, and it is only called fetishism because the ancestor’s skull or other part of the body is the medium of communication.”... “The usual fetish of ancestor worship is the skull of the father, which the son keeps in a box. The father occasionally speaks to the son in dreams and frequently communicates with him by omens. He helps him in all his enterprises, good and evil, and secures his success in hunting and in war.”

Totemism

—Side by side with fetishism, though not dependent upon it, is to be found another belief called totemism. Totemism is a widespread belief among the dark-skinned races of the world, throughout aboriginal America, Polynesia, Australia, India, and Africa except the northern part. A totem is a class of material objects which a savage regards with superstitious respect, believing there exists between him and every member of the class an intimate and altogether special relationship. It differs from a fetish in that it embraces a whole class of objects. Thus to the Alaskan Indian of the Raven clan, all ravens are subject to the same veneration and esteem.

Believers in totemism claim that there is a bond of friendship and kinship between the clan or the individual (totems may be clan totems, or they may be individual totems) and the totem, that mutual advantages result from this relationship, and that the totem is actually in some sense the ancestor of the clan or individual to whom it belongs.

It is found that a clan or individual expresses the characteristics of its totem. The human group, or individual, vibrates to the same key that its totem does. The decave is different, but the key is the same; for the totem may be an animal, a plant, or other object. To state it in astrological terms, the totem is of the same astrological rulership as the person or clan claiming it as a totem.

This natural sympathetic relation is taken advantage of by the savage. He enters into rapport with the astral double of the totem. He does his utmost to protect and otherwise benefit the totem, and in return expects the astral double of the totem to warn him in time of danger, to afford him premonitions of important approaching events, and otherwise recompense him for his devotion to its welfare.

Through his friendship he attempts to use its double to attain certain advantages for himself. Although he does not hypnotize his totem, he talks to it, giving it suggestions, much as a hypnotist may suggest to his subject that the latter's astral shall go to a distant place and obtain certain information, or that it shall direct him to a lost article. Through the natural vibratory similarity between them, the savage is in rapport with his totem in a manner not widely dissimilar to the rapport between the hypnotist and his subject, or the rapport between the controlling entity at a seance and its medium. The totem is a medium somewhat controlled by its human friend.

This all seems to the average individual pure nonsense and deep-dyed superstition. But before final judgment is pronounced, an investigation should be made as to how often a clan is actually warned—probably through the extrasensory perception of the totem or the clan—of danger by the uncommon actions of some member of its totem. It might be well to know, for instance, how often a clan in search of game following the direction taken by the first of its totem met actually found abundant game in that direction. And bearing the power of psychokinesis in mind, and how little is known about how it works, it might be well to investigate the fortune in warfare of a clan

holding a dance in honor of its totem before entering battle, and what effect it had upon their endurance, their keenness of faculties, and the sudden impressions by which they took advantage of an opponent or escaped danger.

Hero Cult

—Next above totemism on the religions genealogical tree is the worship of heroes. We need not go back to olden times to witness how certain individuals with superior talents in some direction are endowed by their followers with perfections they in no wise possess. Multitudes of young people adore certain movie heroes. A statesman who has accomplished some outstanding service to his nation is raised on a pedestal which permits him never to be wrong. It has been proved that the George Washington cherry tree incident is a hero-worship fantasy.

Had Hitler won World War II he would have been acclaimed a god, as were certain Roman emperors. After they have been dead a hundred years or more certain individuals are proclaimed to be saints, and to them are directed the prayers of the devout.

Phallic Worship

—Because of the taboos of our society we cannot give this subject the discussion it warrants. While in its grosser aspect it is something quite repugnant, nevertheless it seems to be founded upon something that in its finer aspects is both constructive and beneficial; the use of the higher emotions of love between husband and wife.

Actual results need to be checked to give us anything conclusive, but the ancients made great claims for the finer relations between married couples, claims that in the light of modern psychological knowledge, and knowledge of the action of the endocrine glands, may be founded on fact. To what extent husband and wife may contribute, through the stimulation in each other of high ideals and emotions, through exchange of magnetism, and through the psychokinetic influence of their minds upon each other, should be investigated by competent scientists; for many have claimed to have been rejuvenated and given health, as well as the inspiration for high accomplishment, through marital love.

Chapter 2

Serial No. 134
Original Copyright 1949
Elbert Benjamine

Copyright
August 2002
Church of Light

Early Religions of the World

Chapter 2

Early Religions of the World

DESPITE the assumption that religion developed from pre-human Naturism, there are no extant proofs as to what man's earliest belief may have been. When he first came upon the scene of prehistory he already had developed quite complex religious ideas and observances. Even the cavemen, the Neanderthals, who belonged to a different species of humanity than any that survived, believed in magic, that man survived death, and, as attested by his burying a suitable outfit with the dead, he believed that the dead after passing to the next life instead of playing a harp before a great white throne in a city paved with gold, would follow much the same pursuits that he followed here.

The first truly human men, in the sense that they belonged to the same species as existing peoples, the Cro-Magnons, were great believers in magic—which is what is now recognized as psychokinesis—and also believed in life after death. Far back in the underground grottoes of France have been found the chambers in which their magic was practiced. Clay effigies of various beasts had been made, and then pierced with spears and arrows, and cut with knives. As similar practices exist among aboriginal people in certain regions today, we may assume that these magical ceremonies were performed to enable the hunters more easily to find and overcome the very formidable game which they hunted. It is believed also that the paintings of animals on the walls and ceilings of their caves had a religious significance. So little is known about these first men that the extent of their religion cannot be determined, but their ceremonial chambers, paintings, carvings on bone and ivory, and elaborate burial practices, lead to the conclusion that it was quite complex.

These Cro-Magnons belonged to the culture of the Old Stone Age. The next people known in Europe arrived about 12,000 years ago. They, and other people of the Polynesian-European group found elsewhere, had already arrived at the stage of culture where they used polished stone. It is often assumed that they passed through the stages of religious development starting with animism, in which there was propitiation of elemental powers, then fetishism, totemism, hero cult, phallic worship, stellar cult, lunar cult, and thus finally arrived at solar cult. And some such gradual development may have taken place; but there are no records or monuments of any kind known at the present time to prove it.

These people of the New Stone Age when they first arrived in Africa, Europe, Asia and America, in so far as at present known, already had practically all the mentioned forms of religious practices. Not all of these were practiced in any one spot at any one time, but all seem to have been practiced at a very early date in adjacent regions at times so far back that we cannot be certain which was practiced first.

It is not to be assumed that heliolithic culture—the culture and religion associated with erecting stone monuments to the Sun, who was looked upon as the source of all Life, Light and Love on earth—in all its complex associations existed from the advent of Neolithic man in Europe and farther east. Many of the practices associated with it in later times were highly artificial, and the dates when some of them began have been determined. Yet heliolithic religion, in its essential elements of venerating the sun and erecting monuments in its honor, goes back so far that it seems likely to have been possessed by man as early as there are records—not including the indications left by Neanderthal and Cro-Magnon—of any kind of his religious beliefs.

The best recognized authority on heliolithic culture seems to be G. Elliot Smith, Professor of Anatomy in the Victoria University of Manchester. Because it is so important a link in the evolution of religious ideas I feel justified in quoting at some length from his monograph, *The Influence of Ancient Egyptian Civilization in the East and in America*. It should be understood, however, that the heliolithic culture referred to in this quotation is not the earlier type, but perhaps the most complex dated by him as about 700 BC

“When one considers the enormous extent of the journey, and the multitude and variety of vicissitudes encountered upon the way, it is a most remarkable circumstance that practically the whole of the complex structure of the megalithic culture should have reached the shores of America. Hardly any of the items in the large series of customs and beliefs enumerated at the commencement of this lecture failed to get to America in pre-Columbian times.

“The practice of mummification, with modifications due to Polynesian and other oriental influences; the characteristically Egyptian elements of its associated ritual, such as the use of incense and libations; the beliefs concerning the soul’s wanderings in the underworld, where it undergoes the same vicissitudes as it was supposed to encounter in Pharoanic times (New Empire)—all were found in Mexico and elsewhere in America, with a multitude of corroborative detail to indicate the influence exerted by Ethiopia, Babylonia, India, Indonesia, China, Japan, and Oceana, during the progress of their oriental migration.

“The general conception, no less than the details of their construction and associated beliefs, make it equally certain that the megalithic monuments of America were inspired by those of the ancient East; and while the influences which are most obtrusively displayed in them are clearly Egyptian and Babylonian, the effects of the accretions from the Aegean, India, Cambodia, and Eastern Asia are equally unmistakable.

“The use of idols and stone seats, beliefs in the possibility of men and animals dwelling in stones, and the complementary supposition that men and animals may become petrified, the story of the deluge, of the divine origin of kings, who are regarded as children of the sun or sky, and the incestuous origin of a chosen people—the whole of this complex interwoven series of characteristically Egypto-Babylonian practices and beliefs reappeared in America in pre-Columbian times, as also did the worship of the sun and the beliefs regarding serpents, including a great part of the remarkably complex and wholly artificial symbolism associated with this sun and serpent worship.

“Circumcision, tattooing, piercing and distending the ear-lobes, artificial deforming of the head, trephining, weaving linen, the use of Tyrian purple, conch-shells, trumpets, a special appreciation of pearls, precious stones, and metals, certain definite methods of mining and extraction of metals, terraced irrigation, the use of the swastika symbol, beliefs regarding thunder-bolts and thunder-teeth, certain phallic practices, the boomerang, the beliefs regarding the ‘heavenly twins,’ the practice of couvade, the custom of building special men’s houses and the institution of secret societies, the art of writing, certain astronomical ideas, the entirely arbitrary notions concerning the calendrical system, the subdivisions of time, and the constitution of the state all of these and many other features of pre-Columbian civilization are each and all distinctive tokens of influence of the culture of the Old World upon that of the New. Not the least striking demonstration of this borrowing from the Old World is afforded by games.

“When in addition it is considered that most, if not all, of this variegated assortment of customs and beliefs are linked one to the other in a definite and artificial civilization, which agrees with that which is known to have grown up somewhere in the neighborhood of the Eastern Mediterranean, there can no longer be any reasonable doubt as to the derivation of the early American civilization from the latter source.”

Indeed, such identity of complex beliefs and practices extending around the world proves positively that all were derived from a common source. But as at least the fundamental ideas which thus became elaborated into an intricate and complex system arrived with the white population who entered the Mediterranean region around 12,000 years ago, there is no more evidence where it first developed than there is evidence where the higher culture, as shown by their first records, of Egypt, India, Crete, Peru, Mexico, China and Mesopotamia developed, which was contemporaneous with and exercised an influence upon, the less advanced heliolithic culture elsewhere. But Professor Smith’s description gives us a good picture of the religion of considerable of the world outside the seven ancient centers of civilization as it existed around 700 BC.

Religion of the American Indians

—The Indians of the two American continents embrace many hundreds of tribes speaking different dialects. It is not wholly justifiable, therefore, in view of their different cultures, to group them as a unit and speak of their religion as a whole. Yet in spite of the long period during which there has been little intercourse between some of them, as shown by their language springing from different linguistic roots, there is a remarkable similarity between the religious beliefs of primitive Americans.

There is no more evidence where the American Indian came from, or how he reached America, than there is to indicate where the Cro-Magnon came from and how he reached Europe. But in Virginia and North Carolina has been discovered evidence within the past two years that seems to indicate an eastern phase of the famous Folsom culture which flourished in the Western Plains during the last of the Ice Age more than 30,000 years ago.

When the white man first came to America he found a virgin wilderness. From this he assumed that the continent had a widely scattered and quite sparse population. But intensive archeological digging during the past few years has demonstrated that in ancient times there were numerous diverse tribes occupying almost every region on the continent.

At least we now know that the Amerindian appeared in America before the Cro-Magnon appeared in Europe. And there is considerable mystery about where he received some of his ideas. For instance, the Doheny Expedition of 1924, found some interesting wall carvings. Samuel Hubbard, Director of the Expedition, and Curator of Archaeology of the Oakland, California, Museum, reported the finding of a wall-carving of a dinosaur. The quite perfect wall-carving by prehistoric man was found in Hava Supai Canyon, Arizona, within a hundred miles of where fossil tracks of these monsters also were found.

There were also carvings showing man chasing ibex, and one showing man being attacked by an elephant. It seems certain that man was in America contemporaneous with mountain goats, mountain sheep and the Imperial Elephant. But according to all knowledge we have at present the dinosaurs had disappeared from the earth 50 million years before the advent of man. Did some early artist use his extrasensory perception accurately to reconstruct and picture on the canyon wall the monster which millions of years earlier had left its huge footprint in the mud which had hardened into rock?

To the Indian of North America or of South America, both past and present, in so far as there is evidence to consult, religion is not merely for special occasions, but is the very essence of his daily life. He believes in a Great Spirit, Creator of the Universe, Who is not to be represented by any object nor to be circumscribed by the walls of any temple. He believes also in a devil, called by some tribes Hobamoco, to whom, in the effort to attain his good will, or to keep from offending, devotion by some may be

paid. And residing in objects, such as the sun, moon, rain, and earth, as well as in minor things, he discerns an animating spirit to which in reverence he may address himself.

The typical Indian is reverent under all circumstances. On rising in the morning he breathes a prayer to each of the four cardinal points, and to the “here,” which is the place where he stands. Or if a Navajo, for instance, he addresses a prayer not merely to the spirits of the East, North, West, South, and “Here,” but also to the spirit of the Heavens above, and to the spirit of the Earth below. When the sun rises he offers a prayer to it, and often makes a secret prayer to the powers above and around him before partaking of food.

On more momentous occasions, such as planting grain, preparing the harvest, going on a protracted hunt, or initiating a war, he first prepares to merit success by an elaborate religious ceremony. There are war dances, ghost dances, snake dances, harvest dances, and a great many other solemn religious rites and festivals for the purpose of gaining the assistance of invisible powers in the Indian’s undertakings.

Civilized man is all too prone to scoff at the Indian’s belief that his ceremonies and prayers tend to cause his corn to grow thriftily, tend to protect him in time of battle, or tend to bring rain when needed. Yet Roman History records that in the time of Nero a Cynic laughed at the folly of the Aqualieium, but that the pontiffs solemnly carried the sacred stone to the Capotiline and prayed to Jupiter until, in response, the people were drenched like rats by rain that fell in bucketfuls. Or if you wish a more modern instance, here is a clipping from the Los Angeles Examiner (1925): “Atlanta, Ga., Sept. 13—(By Associated Press)—A break in the drought which has held most of the South many weeks, came today.

“The Governors of Georgia, Alabama, North Carolina and Virginia had issued proclamations calling on the people to pray for rain.”

Whether it is admitted that the rain in the above instance was influenced by prayer or not, at least when the governors of four states issue solemn proclamations calling on the people to pray for rain, it indicates a belief in the efficacy of such prayers. And if civilized people believe their prayers will be answered, but that the prayers of primitive people will not, it is because they are under the illusion that they are the favored or chosen people of God. But all the evidence indicates that God works His will, not through whim and prejudice, but through undeviating natural laws, and that psychokinesis is just as likely to bring the realization of the prayer of a devout savage as to bring the realization of the prayer of the most pious Christian.

In addition to believing in a host of spirits both kindly and malicious the American Indian is a firm believer in magic. The Medicine Man is the chief magician of the tribe, and is supposed to be the repository of secret wisdom and uncanny powers. Totemism is widely prevalent, and so sure is the Indian of a life after death, in which usually it is believed good deeds will find a reward and evil deeds will be punished, that he faces death without fear or hesitancy. The Indian about to die has no misgivings. It is only those who are left to miss him who bewail his departure.

This life after death is conceived to be very similar to the life on earth, except less sordid and harsh. Therefore, that he may have them (their astral counterparts) for his use in the Happy Hunting Grounds, it is not uncommon for the Indian's most cherished possessions to be buried with him, and that he may not be compelled to go afoot, his favorite horse may be slain on his grave.

The Indian is cruel in war, as are most modern people; the mass murders and cruel concentration camps of Nazi Germany, for example. Yet the Indian has a deep sense of honor, and a keen feeling of responsibility toward the other members of his tribe. Those who receive the highest praise and are the most esteemed are those who do most for the common welfare.

Indians believe the positions of the heavenly bodies have an influence on mundane undertakings. Thus the religious ceremonies more frequently begin under some special astronomical configuration. This may be merely according to some phase of the moon, or it may, as in the case of the Snake Dance of the Hopi Indians—details of which are given in the reference book, *Astrological Lore of All Ages*, and a picture of which is given on page 2 of lesson No 133—be determined by a special relation of the moon to the sun when the sun is in a particular part of the zodiac. To what extent astrological considerations enter into the life depends largely upon the culture of the particular tribe. As a general thing, the higher the degree of culture the more attention they pay to astrological factors.

The Indians of the larger part of Canada, except where there are towns, groups of white settlers, or trading posts, may be classed as animistic. They believe in a Great Spirit, in a Happy Hunting Ground to which they go after death, in spirit communion, and in the power of their medicine men to perform wonders. Totemism is in particular evidence along the Northwest Coast and the coast regions of Alaska. Sweat chambers are common, initiation ceremonies are considered important, there are religious dances and festivals differing with differing tribes, and also a number of methods of disposing of the dead; all of which to them has religious significance.

The Aleuts between Kamchatka and Alaska believe in ghosts; but they go somewhat further than primitive animism, for they believe certain priests, or ghost controllers, have the power to control and influence ghosts. They thus belong to an advanced kind of animism, such as is to be found also in Siberia, where a special priest is thought to have supernatural powers. This belief is called Shamanism.

Along the narrow sea-coast strips of Greenland which are inhabitable, we find Eskimos. They may also be found around the Bering Sea and on the northeast coast of Siberia. Wherever found their religion is the same, except that in some localities it has come to a greater extent than in others under the influence of Christianity. The Eskimo believes in a Great Spirit, or supreme god, called Tornarsuk, to whom all go after death if they have lived good, honorable lives. The after-death lives of such good people are happy and filled with joy. The after-death life of evil persons is a miserable sort of existence. The Eskimo is a firm believer in spirit communion? and in witchcraft. Their priest, called Shaman, is both a magician and one who converses

with the dead. In some regions Eskimos are regarded as Christians, but where uninfluenced by Christianity their religion is pure Shamanism.

At the opposite extreme of the Americas we find the big Patagonians, who believe that after death they will live in a pleasant grove. They also believe in evil spirits. In Tierra del Fuego there is a belief in a Great Spirit who knows man's actions and words, and has an influence upon the weather.

Indians of both Americas, even in the outlying wilderness, have traditions concerning some of the constellations. But the nomadic tribes, lying outside the region where squashes and maize are raised, including the mentioned Canadian Indians, were so much on the move, and had so little time to devote to anything except procuring their daily food, that their culture was small and found little room for astronomical notions. Those Indians, on the other hand that lived in the maize raising belt, had time to develop a high degree of civilization, and the nearer we approach the highest centers of civilization the more prominence is given to astrological ideas.

Thus near the City of Mexico is a pyramid temple to the sun, and not far from it a pyramid temple to the moon, each rivaling in size the Great Pyramid of Egypt. And farther south in more ancient times the Maya had quite effective observatories (picture page 35). In such vicinities, until suppressed by the Spanish conquerors, the religious ceremonies and also the important affairs of life in general, were regulated by a careful observance of astrological positions.

Religion in Oceana

—The native Australians may roughly be divided into two great divisions, the Eagle-hawk group, and the Crow group. The former are a much taller and stronger people. They are all quite convinced that the soul is able to leave the body and visit celestial spirits in sleep. They also believe it is dangerous suddenly to awaken a person from a sound sleep, as the shock may sever the connection, and the soul will then be unable to return to the body. They further believe that following death the dead often return to earth and linger for a time. In periods of great danger they call upon the departed for assistance. They believe in gods, who are supposed to live in a region above the earth. After his initiation is completed, it is customary for the Australian youth's father to lead him out into the bush and point up to a star, reverently telling him, "Now you can kill all kinds of animals but remember, He can see all that you do down here."

The most important religious rite of this whole region is that of initiation. The initiatory ceremony varies somewhat with different tribes. In some only the young men undergo initiation, which is usually accompanied by circumcision, and perhaps knocking out two front teeth, or other mutilation. In other tribes women have initiation ceremonies which, of course, are carefully guarded from the men. These initiatory ceremonies are quite protracted and very harsh. In them, communion with

spirits plays a part, and information is imparted by the older men. There are also Gomerias, or wizards, resembling the Indian Medicine Man.

Of course, among the different groups of islands customs and beliefs vary somewhat, but animism and totemism are the dominant features. Thus the Maoris of New Zealand have large piles of stones, of phallic import, upon which sacrifices are offered, the entrails being inspected to obtain omens of the future. In time of peril human prisoners have been sacrificed on these phallic altars. On Gilbert Island, midway between New Guinea and South America, such sacrifices, which date back to the heliolithic culture, are made to a single stone set within a circle of stones. On the Haides, east of Australia, the natives believe in two gods, both of rather beneficent character. One is the ruler of the upper world, and the other the ruler of the lower world. Once they quarreled, and the one threw the other out of heaven, and heaven became filled with a host of other gods, who still remain there, and who must be propitiated to prevent misfortune. They consider the worst sin to be disregard of the wish of their priest. The latter, they believe, has the power to condemn a man's soul to hell.

The Fiji Islanders, like the balance of Polynesia, were once of heliolithic culture. There are remnants of this belief, as well as strong influences from animism and totemism among them at the present time. They formerly worshiped sacred stones and sacred trees. But at the present time the dominant influence is Protestant Christianity. In Samoa, still farther east, there is a belief that gods incarnate in various beasts, birds, fishes, and shells.

Farther east than Samoa, and considerably north, are the Hawaiian Islands. The religion before civilized man arrived was animism, arising out of and associated with, the old heliolithic culture. As in Australia, the priests, called kahunas, at times, in addition to other magic feats, used psychokinesis to bring about the death of their enemies, or those they had been paid thus to kill. In Australia the magician makes use of a "pointing bone," a bone which he either holds while he points it at his victim, or which he fixes near where his victim sleeps so it will point in that direction. He keeps repeating an incantation while the bone is thus pointed, and the victim gradually becomes paralyzed and finally dies. The Hawaiian kahuna uses a "death prayer" to send his spirit slaves to enter the intended victim's body and remove the vital energy. The vital force is first removed from the feet, which become numb, then from the knees, hips and solar plexus. In the course of a few days the numbness gets as high as the heart and the victim dies.

Among the Polynesian priests there is a secret philosophy, not given to others, relative to what we call the astral double, and methods of performing various feats of magic. In Hawaii this is known as the Huna philosophy. But at present there is a strong Protestant Christian influence, which has converted a large part of the native population. And in addition, there is the Buddhism and Confucianism which is the belief of the quite considerable Mongolian population who are immigrants to the Islands.

In New Guinea, and such adjacent islands as Ladrone Islands, Yap, Caroline Islands, Lelew Islands and Guam, the earlier heliolithic religion is heavily overlaid with animism, in which charms and magic are prominent features.

Early Religion in Asia

—In south and east Asia, including the Malay Peninsula, Sumatra, Borneo, and the Philippine Islands, we find a people who in earlier times were essentially of the old heliolithic culture. Overlying this there later developed a less cultured form of animism, there being a strong belief in charms, in the power of certain idols, and the presence of altars and sacred groves. At the present day, however, while the Dyaks of Borneo still have wizards who perform rites, throughout the Malay Peninsula, Sumatra, Borneo and Java, another influence has become dominant. These regions are now strongly Mohammedan. Indo-China, on the mainland, however, including Siam, is predominantly Buddhist.

Off the north coast of Asia lie the islands of Japan. The primitive people here seem to have been the hairy Ainus. Their religion was on a par with that of the natives of Chota Nagpur, India, in being a quite nebulous form of animism. The present Japanese are supposed to be an invading race, in part racially allied to the Chinese. The religion that developed among them is called by them Kami no michi, meaning, The Way of the Gods, but is customarily referred to by the Chinese designation, Shinto, meaning, The Way of the Spirits.

The chief Shinto god is the Sun-deity, Amaterasu. There are a great many other deities, but the only other ranking close to the Sun deity is the Food-goddess. In the earliest traditional-times, beyond the exaltation of the sun to the station of chief and most powerful goddess, the religion seems to be little more than animism. The moon, fire, lightning, three watergods, volcanoes, trees, and animals were subjects of special veneration. There were also a host of other spirits. It was held that the soul persisted after death, at least for a time, although this belief was not clearly defined; and the abode of the dead was hazily considered as some subterranean region in which the departed persist for a time in an unenviable state, thus greatly resembling the belief of the early Sumerians. The chief Shinto ceremony is the Great Offering of the first fruits at the commencement of each new reign.

There was no special moral code associated with Shinto; but courage and kindness were endorsed because they were regarded as characteristic of the Sun goddess. Magic was believed in, but was considered an offense. The four distinctive emblems of the religion are the mirror, the rope, the torii, and the gohei. The torii consists of two stones, or two barked unpainted tree trunks planted upright in the ground, on the top of which rests another trunk or stone, and below this is another horizontal beam. In effect, it is the dolmen structure so frequently encountered in the prehistoric stone monuments of the West. The gohei is a slim wand of wood, with two pieces of paper, each notched alternately on opposite sides, hanging from it. These are supposed to attract the attention of the gods to the worshipers.

In the course of time, no doubt so his political supremacy might remain secure, it came to be taught that the Mikado is always a direct descendant from the sun. This being a god because he was the Son of God, is a regular feature of the Hero Cult as it developed in various sections of the world. It is the main doctrine back of Christianity. And the Mikado (chart of the last Mikado in lesson No. 219) thus held his subjects under complete domination until recently, when, as a result of losing World War II, he was compelled publicly to announce to his previous subjects that after all he was not a god, but merely a human being as were they. This was a terrible shock to the people of Japan, but it emancipated them from a previous form of slavery.

It was taught that because of the mischievous tricks of the violent god of the underworld, the Sun goddess once shut herself in a cave. The violent god thereupon by dancing attracted her attention, and showing her her own reflection in a mirror told her she had a rival, upon which she reappeared and all was bright in the world again. The violent god was then banished by the other gods, and the grandson of the sun came down to earth, and by slaying all who opposed him, secured peace on earth. This grandson of the sun was Ninigi, the great grandfather of Jimmu, the latter being the Mikado that tradition claims reigned 660 BC. It is also related that the empress Jingo, who lived a hundred years and conquered Korea, lived about 200 AD, but there is no certain date in Japanese history before 401 AD.

Up to the time of the Japanese defeat in World War II, the chief doctrine of Shintoism was unswerving loyalty to the nation. Patriotism was looked upon as the highest virtue. The implication was that any act, regardless of its effect upon other peoples, and regardless of justice, that benefitted the empire was commendable. There was no consideration for members of society other than the Japanese.

Early Shintoism had no organized priesthood. It is said there are 37,000 Shinto Shrines at present in Japan, but at many of these shrines the Buddhistic influence is practically as strong as that of Shinto. The service at these shrines is hand-clapping and bowing. The center of the Shinto religion today is at the shrine of Ise, to which pilgrimages are made from all parts of the country. At Ise there are two temples. It is here the custom for pilgrims to throw down their copper coins upon a white cloth in front of the gateway which is within a torii, bow a few times, and then depart in contentment.

In every Japanese household there is a "shelf for gods." This seems to be a development due to Buddhistic influence, which only began to infiltrate Japan after 600 AD. On this shelf it is the custom to have a little shrine containing paper tickets on which are written the names of the various gods. One of these tickets is supposed to contain in its makeup some shavings from the wands used by the priests of Ise at the two annual festivals, and is supposed to protect its possessor from misfortune for six months, at the end of which time it should be changed for a new one. These tickets and the priests, as well as the doctrine of the infallibility of the head of the government because of his divine descent, however, are no part of the original Shintoism. Even the mirror, symbol of the sun, which is shown in the present-day

Shinto temples, together with the jewel and the sword associated with the sun's struggle with her violent brother, is an importation from the Buddhist cult, and the real mirror is kept secretly concealed.

The Dravidian people of primitive India were of the heliolithic culture. Later animism developed the worshipers of Siva, which is one of the two great divisions of Hinduism to this day. Siva is the destroyer. A standard authority on the subject writes:

“But whenever one finds a true Sivaite devotee that is, a man that will not worship Vishnu but holds fast to Siva as the only manifestation of the supreme divinity, he will notice that such a one quickly becomes obscene, brutal, prone to bloodshed, apt for any disgusting practice, intellectually void, morally beneath contempt. If the Sivaite be an ascetic his asceticism will be the result either of his lack of intelligence, or of his cunning, for he knows that there are plenty of people who will save him the trouble of earning a living.

“But we must now give an account of the low sectaries, the miracle-mongers, jugglers, and ascetic whimsicalities, which together stand under the phallic standard of Sivaism. Ancient and recent observers enumerate a sad list of them.

“The devotees of the ‘Highest bird‘ are a low sect of ascetics who live on voluntary alms, the result of their affectation of extreme penance. The Urhvabhus, ‘Up-arms,’ raise their arms until they are unable to lower them again. The Akacamukkas, ‘Sky-facers,’ hold their faces toward the sky till the muscles stiffen, and they live thus always. The Nakhis, ‘Nail’ ascetics, allow their nails to grow through their clenched hands, which unfits them for work (but they are all too religiously lazy to work), and makes it necessary for the credulous faithful to support them.

“Some of these, like the Kanaphates, ‘Earsplitters,’ who pierce their ears with heavy rings, have been respectable Yogis in the past, but most of them have lost what sense their philosophic founders attached to the sign, and keep only the latter as their religion. Some, such as the Ukharas and Sukharas, appear to have no distinctive features, all of them being ‘refuse of beggars’ (Wilson). Others claim virtue on the strength of nudity, and subdue their passions literally with lock and key.

“The ‘Potmen,’ and the ‘Skull-men,’ Gudas and Kapalikas, are the remnant of a once thoughtful sect known by name since the sixth century, and Kanaphats and Kapalikas show that very likely among others these wretches are but the residue of ancient Sivaite sects, who began as philosophers (perhaps Buddhists), and became only ascetics and thus degraded; for Siva apparently has no power to make his worshipers better than himself, and he is a dirty monster, now and then galvanized into the semblance of a decent god.

“But none of the Sivaite sects that have been mentioned, imbecile as seem to be the impostors that represent them, are equal in despicable traits to the Shaktas. These worshipers of the androgynous Siva (or of Shakti, the female principle alone) do, indeed, include some Vishnuites among themselves, but they are originally and

prevailingly Sivaites. Blood offerings and human sacrifices are a modern and ancient trait of Siva worship; and the hill tribes of the Vindhya and the classical drama show that the cult of Aghoris is a Sivaite manifestation which is at once old and derived from un-Aryan sources. Aghori and all female monsters naturally associate with Siva, who is their intellectual and moral counterpart.”

To give in details the worship of Mehadevi, Durga, Kali, Uma, etc., the names by which Siva’s wife is known is not desirable, and non-permissible, because of the indecencies. Nor is it desirable to more than mention the rite-book called the Tantras, which enjoins indulgence in “wine and women.”

The wild tribes of India hold to still other religious beliefs. These tribes may be divided into two great groups, the dark-white Dravidians, and the yellow Kolarians, the latter being sometimes called Indo-Chinese. The general religion of the Dravidians is essentially heliolithic, and for that matter the sun is venerated and worshiped in nearly all parts of India. I shall have space to mention but two of the larger divisions of the Dravidian population, the Gonds and the Khonds.

The pure Gonds are junglemen, and are noteworthy for honesty, truthfulness, and courage. Those that have intermarried with the Hindus, however, are noted for their treachery and dishonesty. They venerate the sun, moon, and stars, and have stone idols, or symbols, which they venerate, and believe in magic. More anciently the sun was the great object of their veneration, to which they offered human sacrifices, a man of straw now being substituted as the victim of the rite. The chief ceremonies are the sun-feast and the snake-feast, in which worship is combined with drinking and licentiousness.

The Khonds make a human sacrifice to the earth-goddess their principal rite; but they also worship the sun as the supreme deity. The human victim whom they sacrifice is placed in a cleft of a tree to be crushed, or he is placed in the fire. Human sacrifices are also used to mark boundary lines. The victim is captured while quite young, and treated with kindness until he is grown; then he is sacrificed in a mud-bath and bits of his flesh are cut out and strewn along the boundary lines. This people are aborigines of the Eastern Ghats.

Of the yellow Kolarians, the Sunthals have immigrated into the West Bengal region. Their highest deity is the sun; and their religion is strictly animism. The Koles (pig-stickers) also worship the sun; and in addition worship the moon as his wife, and the stars as his children. Then there are the Garos, who live between Assam and Bengal; and the Kaaos, the Savaras, and many others whose worship is chiefly sun worship, totemism and animism.

To the north of India lies the mysterious region of Tibet. The religion of this country is Lamaism. This Lamaism has for foundation Mongolian Shamanism. This Shamanism still is the dominant religion of Northern Asia. The Shaman is the wizard priest, closely resembling the Medicine Man of the North American Indians. He is primarily a magician who holds communication with both good spirits and bad spirits, as well as with people’s ancestors.

Tradition relates that the Mongolian Shamans of Tibet were among the world's most powerful magicians, exceptionally well versed in necromancy. Later, Buddhism gained a foothold in Tibet as it did in Mongolia and China. In the course of time, however, the Buddhist doctrines in these regions underwent a gradual but radical change. Then, in the seventh century, the ruler of Tibet, Sorong Tsan Gampo, entered into negotiations with the Emperor of China, and founded Lhasa, the present capital of Tibet.

He was supported in his enthusiasm for Buddhism by two queens, who are now worshiped as being incarnations of the wife of Siva. The king also became a saint, and is looked upon as an incarnation of a divine being. From then on, as Rome became a holy city under Catholicism and strove for temporal power, so Lhasa became the Holy City of the Far East, and its religion began to take on an aspect of temporal power. In the West, in the fourteenth century came the reformation of Christianity led by Martin Luther, and in the fifteenth century in the East there was a so-called reformation which finally resulted in the Emperor of China recognizing two leaders, the Dalai Lama and the Pantshen Lama. These two had previously been abbots of the great monasteries at Geduu Dupa, near Lhasa, and the one at Krashis Lunpo, in Further Tibet. They each strove for complete dominance, and to prevent a long and bloody war the Emperor of China effected a compromise. Since then these two Lamas have been the temporal and religious rulers of Tibet; being supported in this by Mongolia and China.

These Lamas are supposed to be incarnations of divine beings, the Dalai Lama being an incarnation of the same divinity as Buddha. When either of them die it is necessary for the other to ascertain in whose body the celestial being will next incarnate himself. He, therefore, has collected all the names of the male children born soon after the demise of the other Lama. Out of these names he chooses three. These three names are placed in a casket provided by a former emperor of China. The abbots of the great monasteries then assemble after a week of prayer, lots are drawn while they, the remaining Lama, and the Chinese political resident, are present. The child whose name is thus drawn is the future Grand Lama.

The abbots correspond closely to the Roman Catholic Cardinals; but there are Chubil Khans who fill the post of abbots to lesser monasteries. These abbots are all incarnations of celestial beings. Below them are other ranks in a descending scale, corresponding to deacon, full priest, dean, and doctor of divinity, according to the standards of Christianity.

The Dalai Lama is the head of the Buddhist Church throughout Mongolia and China; and while his political authority has been confined to Tibet, and while there are Buddhists both in China and in Japan who do not recognize his authority—as the Greek Catholic church does not recognize the authority of the Pope—he is the head of a hierarchy that has sought, and still seeks, world dominion; using religion as a means of gaining temporal power. The parallel between the Buddhist Church of Tibet and the Catholic Church with headquarters at Rome, is amazingly close, both in the manner in which they manage their affairs, and in the ultimate ends sought.

But Buddhism is not the dominant religion in China proper. The strongest elements are Taoism and Confucianism. These have been slightly influenced by Buddhism, but in most respects retain their original elements. Temples are numerous, ancestor worship is prevalent, and while moral precepts are taught, a great amount of attention is paid to driving out evil spirits. Animism, therefore, enters largely into their present religion.

Religion in Africa

—It is true that some African peoples have advanced beyond fetishism. Thus the Bushmen, while still fetish worshipers, look upon the sun and moon as spirits to be venerated. The Guinea Negroes have also totem worship, religious cannibalism, and a moon-cult. The Wakamba Bantus in addition to fetishism have phallic cults, and the Hottentots have a benevolent god and a malignant devil resembling those of the Christian faith. But Africa as a whole is closely wedded to fetishism. This is particularly true of the West Coast.

Voodooism as practiced by the Negroes of the Southern United States and Haiti, and Obeah and Wanga, came from the West Coast Negroes. Voodoo means fearful, and as originally practiced by the Dahomy Negroes required a priest, a priestess, and a snake. The Wanga, which is still practiced by Voodoo Doctors in the Southern United States, shows the action of poison but does not require the spilling of blood. The White Voodoo requires the sacrifice of a rooster or a goat. The Red Voodoo, which has caused the authorities much trouble in Haiti, requires in its ritual the sacrifice of a human victim.

Chapter 3

Serial No. 135
Original Copyright 1949
Elbert Benjamine

Copyright
August 2002
Church of Light

Religion In Historic Times

Chapter 3

Religion in Historic Times



OUR knowledge of the beliefs of the early Nordic (light-white) people of Scandinavia and the Germanic tribes is largely derived from the so-called Norse Mythology as presented in the Edda. The principle of polarity is everywhere evident; for spirit and matter are considered eternal, fire and water are the two chief elements, and heat and cold the two chief conditions. There are two kinds of gods, the Vanir and Aesir, and two kinds of evil powers, the Thursar and the Jotnar. The Jotnar were giants. The first born of the gods was Wodan, who became the father of the other gods.

These Nordics believed in elves, dwarfs, and other spirits; the swarthy dwarfs being skillful workers in metal, and often friendly to man. The gods increased in number until there were twelve, and of course, following the principle of polarity there were also twelve goddesses. Wodan, who in astrology corresponds to Mercury and after whom Wednesday was named, as father of the gods implies that Mind is back of all orderly manifestation. Wodan desired to drink from the spring of wisdom, guarded by Miner, and to accomplish this was compelled to sacrifice one of his eyes. He was married three times.

His first wife was Jorth, the Earth, who became the mother of his eldest son, Thor, the strongest inhabitant of Asgarth, the middle region of the earth, which was the abode of the Scandinavian gods. Thor, after whom Thursday was named, and who corresponds astrologically to Jupiter, was famed for his hammer, essentially a phallic symbol. He was continually engaged in a struggle with the giants, and his hammer, which was used as an unerring missile, was the cause of lightning and thunder. He was thus, as was Jupiter always, the god of storm, to whom tillers of the soil prayed for rain.

The second wife of Wodan was Frigg, after whom Friday was named, corresponding astrologically to Venus. She was the goddess of mother love, the guardian of women and domestic life, and the protector of marriage. In one aspect, even as astrologically Venus rules Taurus, the sign of fertility, Frigg seems to represent the earth in a state of fertility.

Rindr, the third wife of Wodan, seems to represent earth in a frozen and barren condition.

Another son of Wodan was Tyr, after whom Tuesday was named, corresponding astrologically to the planet Mars. He was the god of war, the personification of courage and bravery.

To the gods, and also to other spirits, it was customary to offer sacrifices. On official occasions horses were offered, and in times of great stress there were even human sacrifices. Temples were built, images of the gods constructed, and in time a well-defined priesthood came into being to look after them. Magic and sorcery were practiced, and in their mythology their gods also employed such means. The earliest conception of the life after death was in Helheim, a cold, misty region, much like the early Sumerians believed in. At a later date a more cheerful abode for the dead came into recognition. This region, Valhall, was a most gorgeous hall where Wodan received his heroes who had lived noble lives and fallen bravely in battle. Here they lived a life of great happiness, every morning marching out to battle, yet at meal time those who had been slain rose in perfect health to partake of the wonderful feast, where they were served the beer, Saehrimmir, and copious draughts of mead.

Although the Nordic peoples had three annual festivals that correspond to well-defined astrological positions, and although their mythology is most successfully interpreted in astrological terms, there seems to be no record of their possessing astronomical or astrological information of much importance.

The Religion of Classical Greece

—Between Greece and Asia Minor is the Aegean Sea. On the islands of this sea, and on the adjacent mainland were the dark-white Iberians. Their religious beliefs developed from a simple heliolithic culture. Among their deities was a mother-goddess, with whom was associated a less important male deity, Velchanos.

When the fair-skinned Hellenes, those heroes of whom Homer sings, invaded the region, this Velchanos was identified by them as their Zeus, and certain myths about the former were thus attached to Zeus. The early Aegeans, however, followed the general practice of heliolithic peoples. They believed in spirits, nymphs, dryads, satyrs, fauns, spirits of the wood and mountain, and looked with reverence upon the sun, moon, stars, sky and earth. There were sacred stones and pillars, symbols of the creative principle, and the eternal belief in magic and in a life after death.

When the Nordic robber kings from Central Europe invaded the region, they brought with them the big turbulent northern gods, given to excess and violence, who later

became the Olympians. The religion of Homer's time then, about the ninth century BC, was a blend of the old Aegean beliefs—considerably modified through commerce with Egypt and the Orient—with ideas brought in by successive waves of big, rangy, fair-haired, blue-eyed Nordics.

Greece is divided by mountains and other topographical features into numerous sections, and each section, city, and valley had its own patron deity. The Olympian System of deities, with whose mythology nearly everyone is familiar, seems to have been a reformation brought about through the efforts of the Homeric poems to replace the aboriginal devotion to the mother principle and the sanction of polygamy, which were Aegean features, as well as those of the Hittites to the east, with devotion to the paternal principle and the endorsement of monogamy.

The old robber gods were gathered on Mount Olympus. These were pictured merely as supermen, who instead of looking after government or agriculture, spent their time feasting, fighting, and in love-making and intrigue. While immortal, Zeus, Apollo, Hera, Hermes, Athena, and all the rest were very human in that they required food, drink, and sleep. In fact, their devotees sought to gain their favor by offerings of meat and wine. To these gods altars and temples were erected, images were made, and there was even the beginning of a priesthood.

These mighty Olympian gods did not entirely displace the local deities and those of earlier times. Some of the older gods, such as those of the wind, the nymphs and fauns, Hestia, Helios the Sun, Selene the Moon, and Gaea the Earth, found their way into the Olympian System. Others did not, but continued to receive homage locally; for there was the utmost freedom in regard to religious beliefs and practices at all times in Greece. The only restriction, even in later times, in regard to religion, was that no one should be allowed to ridicule the gods in public. This, however, was rather to preserve the state than to preserve the religion; for at that time it was thought that a common religion, with its pomp and pageants and artistic displays, was a strong bond for political unity.

With the development of scientific methods of thought, and commerce with the Babylonians, the Greeks became interested in astrology. After about 600 B.C. their influence toward greater scientific precision is noticeable in the astronomy of Babylon, and from that time on the astrological knowledge of the Babylonians began to percolate into Greece. And as this Chaldean astrology came to be understood in Greece, more and more it came to have an influence on Greek religion. Even though the Olympian gods were described by the bards before there is record of astrology getting a foothold in the country, yet the characteristic actions of the deities leave no doubt in the mind of one conversant with astrology that the chief deities each acted in strict conformity to the characteristics of the astrological orb which later came to be associated with it.

The official Greek religion, in early times, concerned itself very little with death and after death life. These things, however, were fully revealed in the Mysteries. The greatest gods of the Mystery cult, Dionysus and Demeter, were not even given a seat

among the Olympians. These Mystery cults were secret societies where initiations took place. There were mysteries in honor of Gaea, Aglaurus, the Graces, Hecate, Themis, and more important still, Orphic mysteries and Elusian mysteries, and later those of Samothrace. In these mysteries, which had large memberships and which markedly influenced the later trend of religious thought, were taught the Ancient Hermetic Doctrines.

In reference to classical Greece, although he founded no religion, but because he refused to believe the orthodox doctrines of his times, and opened a new era of philosophy which called on men to seek self-knowledge, and thus started a movement which, instead of the prevalent blind belief, depended upon intellect, some mention of Socrates should be made. Born in 469 BC, near the end of his life those upholding the orthodoxy of his day charged him with not believing in the gods which the state worshiped, with introducing new divinities, and with corrupting the youth.

As a result of these charges he was sentenced to death. Between the imposition and the execution of this sentence thirty days elapsed, during which his friends were permitted to visit the old philosopher and carry on conversation as usual. His last conversation with them was about the immortality of the soul. His friends offered to devise means for his escape, but he refused. Obeying the command of the state, in 399 BC, with perfect composure he drank the poison hemlock and died.

He had a phase of extrasensory perception in remarkable degree. He was sensitive to what he considered a divine voice, his Daemon, even as many at the present day receive information thus from their unconscious minds. But instead of admonishing what to do, whenever he, or some of his friends, were about to make a wrong decision, or to do something that was unwise, the voice warned him against it. By experience he found it invariably right. He was one of the great teachers of the world, and his influence produced first Platonism, then the Aristotelian logic, and following this various system of philosophy which had much influence during a thousand years after his death.

Not, however, until after the founding of the Alexandrian School in Egypt, 332 BC, and the conquest of the world by Alexander, did Chaldean astrology play its important part in Greek religion. The wisdom of Babylonia then moved to Alexandria and to Greece. About 280 BC, Berosus, a priest from Babylon, established himself in the island of Cos. He taught astrology, and made known the contents of cuneiform writings which he had collected. Soudines, another Chaldean, about the year 238 BC, was invited to the court of Attalus I, king of Pergamus, to practice the methods of divination of his native country. In due time many Greek savants of high repute, including Epigenes of Byzantium, Appolonius of Mydus, Artemidorus of Parium, and Hipparchus, boasted of having been instructed by the Chaldeans.

Gradually thus the knowledge of magic, astrology, divination, mathematics and religion held by the Chaldeans came to have a dominant influence over the religious

life of Greece. Babylon, sacked and burned in 125 BC never recovered. The last astronomical tablet in cuneiform characters, so far as is known, is dated 8 BC. Babylon and her written language disappeared; but whatever of knowledge was hers became the property of the Greeks, and by them was perpetuated.

The Religion of Early Rome

—The old Iberian peoples who in Greece were overrun by certain Nordics, in Italy met a similar fate at the hands of other fair-skinned Nordics migrating from the Danube Valley and from North Italy. This northern people were at the time in the animistic stage of belief in which objects were venerated, magic was prominent, and the world was filled by various orders of spirits. By 1,000 BC the northern people had become well established, mingling their beliefs with those of the primitive Iberians, and with those of the more civilized Iberians of the old Aegean Culture who had also settled in certain parts. These, by the Latins, were called Etruscans. Although the founding of Rome dates 753 BC, beneath the Roman Forum are Etruscan tombs of a much earlier date. Not until the founding of Rome and the work of pious King Numa toward unifying religion was there any unity of religious belief.

Somewhat later Rome fell into the hands of the Etruscans, who built the Temple of Jupiter on the Capitoline hill. Although the Etruscan kings were expelled from Rome in the sixth century BC, the statues of their gods, and the elaborate rituals which they inaugurated became a permanent fixture of the Roman religion.

The chief religion of the more primitive inhabitants was the veneration for the spirits that lived in the trees, fields, stones, springs and other objects. These were called numina, and some of them came to be recognized as guardian deities. Propitiation of these numina existed down to the Christian period. And the gods received from the Etruscans, such as Jupiter and Mars, were conceived to be very powerful numina, each ruling over certain things.

Thus Jupiter's province was to govern rain and sunshine, his aid being sought for success with the field and vineyard. For the purpose of obtaining the good will and favors of these deified spiritual powers, the state built elaborate and precise rituals presided over by a priesthood. This state worship was conducted in sacred groves and holy places and at altars, by the Arvan brotherhood, the Salii, the Luperci, pontiffs, vestals, flamens, augurs, Fetial priests, and others. Rome has been the stronghold of Western orthodoxy's priesthood since 700 BC, even as Lhasa has been the stronghold of Eastern orthodoxy's priesthood since the fifteenth century AD.

Between the years 500 BC and 200 BC there were many national crises. Confidence was shaken in the power of the older gods, and to afford national religious support gods were imported from Egypt, from Babylon, and more particularly from Greece. The whole Olympian System thus found its way to Rome, and even previous to this period the worship of Castor came from Tusculum, the Hercules cult from Tibur, the goddess Minerva from Falorii, and Diana from Africa. In 399 BC, at the direction of the Sibylline Books, for the purpose of ending a pestilence, Greek ceremonies for the

first time were conducted at Rome. Then these famous books of Divination, after Rome despaired of driving an enemy from her midst, directed in 204 BC that the Phrygian goddess, the Great Mother, should receive worship. The result was as predicted, Hannibal and his Carthaginian hosts were expelled; but the worship of the Great Mother, as well as that of a host of other gods from Greece, Egypt, and Babylonia remained.

Yet even before this time, imported with the various deities from Babylon and Egypt, the astrological religion began to gain a foothold. No doubt, from the founding of Alexandria, 332 BC, its impetus increased. After 200 BC the state religion of Rome was rich in ritual and sacrificial offerings, in pomp and show, and in variety of gods worshiped, but sadly lacking in the emotional element that popularizes a religion. The result was that various cults gained sway, chief among them being the Mysteries of Mithra, in which the old Hermetic Teachings were perpetuated. That these mysteries were largely based on astrology is shown by the bas-reliefs, mosaics, and paintings of their subterranean temples, on which the emblems of the elements, the signs of the zodiac, and the symbols of the planets commonly appear.

Astrology had become so popular, and so widely accepted, by the time of the emperors that it was adopted by them as a matter of course. Official astrologers were quite the thing in the time of Augustus and Tiberius, and Nero's teacher, Chaeremon, a priest of Alexandria, brought to his attention the religion of the stars as taught and practiced in Egypt. The sun came to be looked upon as the symbol of the Universal Creator, and in the temples three times daily—at dawn, at noon, and at dusk—a prayer was offered to the source of Life, Light and Love; a custom which survived in the early Christian Church as three daily services. Then, when it became expedient for political reasons, the priests, with whom Rome seems always to have been well stocked, suggested that the Emperor was the representative of the sun on earth. Thus in later days—even as in Japan until after World War II—it came about that men were deified and emperors worshiped as gods.

Through all these importations of deities the Roman people still held tenaciously to their belief in sympathetic magic, and to their belief in the worship of ancestral, household, tutelary, nature, and other spirits. Although Christianity was adopted as the state religion in 325 under Constantine, nevertheless the venerable temple of Vesta, where these various spirits were worshiped, remained open until 394 AD, when it was closed by Theodorus, and all such worship forbidden.

The state religion of Rome gave to the world an impressive ritual that in a modified form persists in the Roman Catholic religion of today. It also gave to Europe the idea of the divine right of kings.

Certain customs of the common people also have come down to European peasants even from the old Aegean beliefs. Such is the custom of swinging magically to help the growth of the grain. The higher one swings the higher the grain will grow. Likewise the custom of hoop-rolling before the shortest day of the year to help the sun make this hard part of his annual circle. After the winter solstice this is no longer

tolerated and there is then the commencement of top whipping for the purpose of helping the sun to come back to his former heat and power. (The Hopi Indians of America, as set forth in the reference book, *Astrological Lore of All Ages*, at this time also have a ceremony for calling back the sun.) After Good Friday, of course, the top whipping must cease, otherwise the heat of the sun might be too intense. And as a further instance of the tenacity of old customs it may be noted that the temple of Vesta, above mentioned, which endured in Rome some twelve hundred years, retained its ancient Aegean architecture, being covered with the primitive thatch and wattle to the last.

Religion of Early Britain

—In the British Isles and on the west coast of Europe, during the development of the religions of Greece and Rome, was another religion very similar to that of the old Aegeans. This was Druidism. The Druids had an aphorism, God can not be matter and what is not matter must be God."

They worshiped one Supreme Spirit, whose symbol is the sun. Like the Greeks and Romans, they believed in unseen spirits, and that objects were the vehicles of other spirits, or subordinate deities, to whom they must render homage. They believed in the evolution of the soul through the various lower forms of life before becoming man, and were confident man, after death, lived in a spiritual realm very similar to this world. So strong was this belief that money was borrowed in this world to be paid back in the next, and except for animals inimical to man and those used in sacrifices, they refrained from killing.

In writing, the Druids used two methods, one common and one sacred, the characters being very similar to those used by the Etruscans. Their religious ceremonies and other events of importance were commenced at definite astronomical configurations. Midday and midnight were two important times, and New Moon and Full Moon were observed for some purposes. They venerated the sun, moon and stars, and gave astronomical dances in their honor on religious occasions. Many such services began and ended with the ceremony of going around thrice in the direction of the sun, commencing in the East. This signified a willingness to obey the will of Deity. To go around in the opposite direction at such a ceremony signified rebellion against deific law, therefore devotion to witchcraft and black magic, which was severely punished. Human sacrifices were offered in times of national crisis, and at five-year intervals, criminals being used for this purpose. One day out of every seven was held sacred.

As in nearly all countries at that time, information of value was imparted during the process of initiation. The chief method among the Druids was by means of oral verse. Before a candidate could enroll for the priesthood his moral qualities and intellectual powers were thoroughly investigated. When he was admitted as a candidate he was called Anewydd. After a time, if successful in passing the degree, he became a Bard, and later on might become an Ovate.

The final degree was that of Druid. It usually took about 20 years, largely spent in the forest, to become a Druid. In this initiation, in addition to religious and astrological matters, he was fully instructed in magic. He became skilled in the use of the magic wand, which is still known as the Rod of Druidism. He became a proficient healer, developed clairvoyance and prophecy, and practiced various forms of divination. Tradition relates that the Druids competed with the early saints in working miracles. The old Celtic Laws, revised 449 AD by St. Patrick, were the work of the Druids. In their social relations they believed in and practiced a high moral code. (For further information, refer to, *Druidism, the Ancient Faith of Britain*, by Dudley Wright).

Manichaeism

—This doctrine derived from the teachings of a Persian of the third century AD, called Mani, Manes or Manichaeus, who taught a dualism derived from Zoroastrianism. Manes, born 216 AD, either claimed to be, or was regarded by his followers as the Paraclete promised by Jesus (John 14:16-17). Following Zoroaster, he postulated two beings, Light (God) and Darkness. From the latter Satan and his angels were born. Adam owed his being to Satan. Continued conflict exists between the two kingdoms, and when the Kingdom of Light becomes victorious the world will be destroyed by fire and God will thenceforth reign.

This sect, in its time considered a Christian heresy, endeavored to reconcile Christianity, Buddhism and Mazdaism into a world religion much as present-day Bahá'ism (see lesson No. 136), which is a Mohammedan heresy, now seeks to reconcile Mohammedanism, Buddhism and Christianity.

The Old Testament was rejected and only so much of the New Testament was accepted as served their purpose. They had a kind of hierarchy, fasting was practiced, and among the later Manichaeans rites existed analogous to baptism and the Eucharist. The ethics of the sect were severely ascetic. Their members were divided into two classes, the “elect” and the “hearers.”

The “elect” were bound to observe three seals: (1) of the mouth, forbidding animal food, the use of wine and milk, and impure speech; (2) of the hands, forbidding the destruction of life, whether animal or vegetable; and (3) of the bosom, forbidding marriage and offspring, since woman was supposed to have been the gift of demons. The “hearers” were less severely bound.

This sect rapidly spread in the East and to North Africa. But it was drastically persecuted, and in the fifth century was completely stamped out, although some of its tenets reappeared later in the doctrines of the Paulicians and later on in those of the Albigenses.

Nestorianism

—Nestorius, Bishop of Constantinople from 428 to 431, taught that there were two persons as well as two natures in Jesus Christ, and that the Virgin Mary was in no

sense Mother of God; she was the mother of Jesus, but not the mother of the Word. Cyril of Alexandria, at the Council of Ephesus in 431, procured the condemnation of the Nestorian doctrines, and the deposition of Nestorius. The latter was banished to the deserts of Egypt, where he underwent much suffering, and died in 440.

Nestorianism made rapid strides in the East, and together with the Monophysites, also called Jacobites—who believed there was only one nature in Christ, namely that of the Word, who became incarnate, and that the divine and human elements in that one nature were blended as the body and soul in man—in the eleventh century outnumbered those of the Orthodox and the Roman Catholic churches together. After 1553 some of the Nestorians were in communion with Rome, and were known as Chaldeans.

Druses

—Another sect, this time arising in Syria where it has its strongest hold today—about 100,000 followers endeavored to unite Christians, Moslems, Jews, Buddhists and Mazdeans. According to their religion, dating from the beginning of the eleventh century, Hakim, the sixth of the Fatimite caliphs was the tenth and last incarnation of God. Hakim, who thus proclaimed himself, when walking in the vicinity of Cairo, his capital, disappeared. His followers believe he will return to earth to reign over it and propagate their faith.

Two Persians spread this doctrine with great zeal Hamzeh and Mohammed ben Ismailed or Durzi. The latter became known so widely that instead of calling its followers Hakimites they came to be known as Druses.

They believe in the unity of God, who they think was manifest in the persons of several individuals, the last being Hakim. They believe in the constant existence of five superior spiritual ministers, the greatest being Hamzeh and Jesus. They firmly believe in the transmigration of souls. Their day of worship is Thursday. They adhere to seven commandments given by Hamzeh, who succeeded the original founder of the sect. These are: (1) Truthful speech among themselves; (2) care of their brethren; (3) renunciation of all other religions; (4) separation from heretics; (5) confession of the unity of God in all ages; (6) resignation to His will, and (7) obedience to His commands. They believe also that to profess belief in another religion for the purpose of gaining the confidence of others whom they hope to proselyte is meritorious.

The Mormons

—Space does not permit me even to list all the Christian sects, let alone explaining their tenets. But they have sprung up, one after another since the dawn of Christianity. In addition to the few previously mentioned, for instance, in the first century there were the Ebionites, who held that Jesus was only a man, upon whom the spirit of God descended at His Baptism, and whom the spirit of God deserted at the time of the crucifixion.

Then there were the Adamites, an early Christian sect who held, as did another sect, the Nikolartans, that wives, like everything else should be held in common by true Christians. They celebrated certain rites in caves where all assembled naked and gave themselves up to promiscuous indulgences.

Of quite opposite character were the Christian Gnostics of the third century. These, for the most part, were learned philosophers who sought to reconcile Christianity and Greek philosophy.

Space does not permit discussing even the outstanding present-day Christian sects, but as throwing some light upon the manner in which a religion gets a foothold, and may at least temporarily be sidetracked, I believe I should speak of The Church of Jesus Christ of the Latter Day Saints, often spoken of as the Mormon religion, which has among its members many intelligent, capable, and conscientious people.

On September 23, 1823, the angel Moroni appeared to Joseph Smith thrice and commanded him to find in the forest a supplement to the Bible. Smith claimed later that an angel gave him the book, consisting of gold leaves in a stone box. This book was in the "Reformed Egyptian" writing, in size octave, 8x7 inches, and 6 inches thick, fastened with three gold rings. With it were a pair of spectacles with crystal lenses by means of which Smith could understand the writing. The contents of this book he dictated from behind a curtain to Oliver Cowdry; and Cowdry and Farmer Harris were induced to pay for its publication as the Book of Mormon. On this book The Church of Jesus Christ of the Latter Day Saints was founded.

This early book of Mormon forbade polygamy. But later Joseph Smith became enamored with a woman other than his wife, and about that time, July 1843, the prophet received a new revelation on the subject, and established "Sealed Wives" in addition to the legitimate wife. Then the religion became subject to relentless persecution, and its followers, after making several moves, finally went to the desert region of the Great Basin and made their headquarters at Salt Lake City, Utah, which is the present stronghold of the faith.

The doctrine of polygamy, however, gave them a great amount of trouble, being particularly used against them politically. Some in the church, even from the first, were opposed to it. This resulted finally in the establishment of the "Reorganized Latter Day Saints." This organization holds plurality of wives to be an abomination. They hold that the Book of Mormon is an authentic history of America between 2,000 BC and 400 AD. They are convinced that Jesus Christ is the Savior, that Mohammed is the second great prophet, and that Joseph Smith came to crown and complete the work of these other two, being the third and last great prophet. In their acceptance of the Bible and the Book of Mormon on faith, regardless of logical contradictions, they greatly resemble the Christian Fundamentalists.

Mystics and Monastic Life

—Instead of viewing religion as teaching how the ordinary life should be modeled, some in each of the more important religions viewed it as an end in itself. They became religious devotees to the exclusion of all other matters. Thus did monastic life spring into being.

Among the Hindus the fakir with his begging bowl, and perhaps his bag of tricks, is a common sight. The Buddhists have great monasteries where those who have turned from the world and adopted religion as their sole interest dwell. Among the Mohammedans there are dervishes. These correspond to the monks of Christianity, there being numerous orders of them. Some are on the plane of the low Hindu fakir, living by begging and a few tricks of legerdemain. Many of the orders of dervishes have no settled abode, but wander from place to place. Some are of a rather high order and possess pronounced occult powers. Among these are accomplished magicians and healers.

Of the Christians, there are several hundred orders of monks that have come into existence since the religion was founded. All have heard of the Wandering Friars, of the Franciscan monks, and of the Jesuits. Some of the orders that once had a membership, however, no longer are in existence. And if we were to take the pains to examine the requirements of membership of these monastic orders of different religions, and if we were to inquire the objective which they hope to attain, and if we were to learn how they live, and who supports them, we should find in essential matters all are remarkably the same.

Monastic life, however, is not the only by-product of the great religions of the world. Among all the great religions there have been groups of mystics, groups of those who believe they reach Deity by retiring within themselves.

I presume no one need be told that the Yogis of Hinduism, through meditation, breathing, fasting, posture, etc., enter into higher states of consciousness in which they claim to receive illumination. There are likewise mystics among the Buddhists, and among the Taoists. Mazdaism, which was a modified form of Zoroastrianism, once had many notable mystics. Among the Mohammedans the mystics are called Sufi, and the Sufi movement is alive today, and in the past profoundly influenced literature. Christian mysticism also produced a very extensive literature. I need but mention Jacob Boehme, Emanuel Swedenborg, Von Eckartshausen and Louis Claude de St. Martin to bring to mind a few of the later Christian mystics and their writings.

Modern Fetishism

—Egypt and the region bordering the Mediterranean are Mohammedan. But the balance of Africa is the present-day stronghold of Animism, Totemism and Fetishism. These beliefs and the practices arising from them vary with districts, and somewhat with different peoples, but almost everywhere in Africa these three forms

are apparent. The native African, North, South, East and West, in spite of any later modifying influence, is a firm believer in various orders of spirits, that the dead have the ability to return, and that they have an influence over the lives of those yet living. He is also a firm believer in magic, and ardently seeks to have it used for his personal gain. Oje men (witch doctors) of various kinds are sought upon all unusual occasions, and their offices are secured in attempts to gain whatever is desired. Among many tribes almost every ill is thought to be the result of sorcery. Totem restrictions are scrupulously observed, and fetishes are secured to assist its possessor, and also for the purpose of injuring his enemy.

In lesson No. 133, under the heading, Fetishism, a quotation was given from Robert H. Milligan's, *The Jungle Folk of Africa*, among whom he lived as a Christian missionary. It was about the skull of the father which the son kept in a box. Later he says, "They believe that the skull of the father or other ancestor when it has been properly prepared becomes the resident of the ancestor, who, however, is not confined to it, but wanders about returning to it as to his home."

Here we see not merely a high development of fetishism, but also the origin and significance of ancestor worship. The skull fetish is never abused, for it is believed abuse would cause it to become angry and bring evil upon its possessor. Being the home of the spirit of the ancestor, the skull is kept comfortable, warm and dry, rubbed occasionally with oil and red-wood powder, and well fed. Before going hunting the box in which the skull is kept is opened and the son addresses the skull as he might if it were still alive, asking his father to help him, and promising he will share the game killed with him. On returning from the hunt the son opens the box and places a portion of the game before the skull, himself leaving the house and locking it against intrusion while his father eats. The father is supposed to eat only the invisible double of the food. After giving the father ample time to do this, the son returns to the house and himself eats the food that was before the skull.

Before turning from these tribes of West Coast Africa, another quotation from Mr. Milligan may prove interesting. It reports the case of a native who believed in just such hauntings as the numerous instances cited in *Haunted Houses*, by Camille Flammarion. He says:

"On Corsica Island there lives a man who had been in contact with civilization all his lifetime and is fairly educated though he is not a Christian. His wife died, and shortly afterward she began playing pranks in his town and even in his house. She broke nearly all his dishes. Then, one night she struck him in the neck, and he instantly recognized her. His neck was stiff in the morning. That proved it! Not being able to strike back in the unequal warfare and preferring an enemy whom he could kick (for this individual wore shoes and scarcely anything else) he lost spirit and finally pulled down the entire town and built in another place."

The more common fetishes are not treated with the great respect accorded to the ancestor's skull. More often they are talked to and treated as if human. If a fetish fails to obtain the desired end it is either placated or punished. In Africa fetishes are

sometimes sprinkled with oil, rum, or blood to gain their favor, and they are maligned, beaten and abused when they fail in their performance.

A large number of fetish practices are to be found among those above savages, such as the general belief of the American trapper that if he sells all his fur he will have difficulty in catching more. He therefore keeps one piece of fur, even though the poorest pelt, that it may draw other fur to him when he starts trapping the next season. The relic of some saint, a piece of the cross, or a portion of the Koran, when believed to possess supernormal power is a fetish. Nor is the abusing of fetishes confined to savages. I quote from Professor Hopkin's *History of Religion*:

“It is exactly the attitude taken by the Egyptians and Greeks toward their gods. Even later Romans destroyed the temples to punish the gods on the death of Germanicus. So also in the seventeenth century a crew of becalmed Portuguese sailors tied their patron, St. Anthony, to the bowsprit till he sent a breeze. A Spanish captain once tied the Virgin to the mast with the same intent. There is, however, another element to be considered, which looks somewhat like simple abuse, but is not. Thus St. Peter's image was once immersed, in the sixteenth century, to cure a drought in France. This may have been a case of sympathetic magic, wetting the saint to cause him to wet the earth. But there are cases enough to show that abuse is reckoned a proper way to control a spiritual power. Russian peasants beat their holy pictures with no other idea.”

Fetishism may very easily lead to idolatry. The reverence for a fetish may lead to its worship. The desire to propitiate and gain the help of ancestors may lead to the worship of the images of such ancestors. In China pictures of ancestors are preferred to images. In India and New Zealand images of stone or wood are preferred. The Hindu Rajput occasionally wears an amulet to keep away evil spirits.

It will be seen that to the indiscriminating mind the image of the Virgin Mary, or of Jesus on the cross, or even the cross, from being a symbol of spiritual power to be venerated might easily by gradual steps degenerate into an idol to be worshiped.

Sankhya and Vedanta

—Among the more notable philosophic religions of India are the Sankhya and the Vedanta. The Sankhya is essentially dualistic, emphasizing the difference between spirit and matter. There is, however, a theistic form of Sankhya, which in its other forms is commonly atheistic, called the Puranic Sankhya; and Patanjali's Yoga is thoroughly theistic. Cankara was a great Vedanta leader in the ninth century, but in the twelfth century Ramanuja arose to dispute his interpretations.

The sectarian pantheism of the present time arose from Ramanuja's doctrines. The religion split into two sects, one numerically stronger, holding that the All-spirit, Vishnu, incarnated through Krishna, and the other that Vishnu incarnated through Rama. Thus we have the Krishnaites and the Ramaites. Then the Krishnaites split into numerous sects, and these into sub-sects; and the Ramaites split into numerous

sects and sub-sects, these smaller sub-sects mutually hating each other even more than they do their common adversaries of the larger division.

Panthia

—One of the most distinguished Vedantists of the fifteenth century was Kabir, who founded the sect known as Kabir Panthia. Their belief is an unsectarian unitarianism. That is, they have no rites, renounce idolatry, ridicule the scriptures, and broke with both the Mohammedans and the orthodox Hindus. There are twelve divisions of these Panthia, mostly in the South, near Benares in the East, and near Bombay in the West.

Sikhs

—In the fifteenth century was born Nanak, who about the year 1500 in the Punjab region started a religious reform movement. He claimed to be a follower of Kabir. The sect has a sacred work, the Granth, compiled by pontiff Arjun and others. The Sikh pontiff was Guru Govind, and under his rule in the eighteenth century the church became aggressive and developed into a powerful military organization.

Its followers believe in one god, prohibit idolatry, pilgrimages, the use of charms, belief in witchcraft, and in the caste system, and they refuse to recognize Brahmanical supremacy. They are renowned fighters, and take a vow to hate both Hindus and Mohammedans. Their early leader's orders were, "If you meet a Mohammedan, kill him; if you meet a Hindu beat and plunder him." Their chief stronghold still is in the Punjab region. There are seven well-defined sub-sects at present.

Jainism

—About the sixth century B.C. Mahavira Jnatriputra founded a religion in the Southern and Western provinces of Hindustan which attempted to reconcile Hinduism and Buddhism, embracing features of both. It is the religion of the Jains, with about a million and a half followers in India.

Its chief difference from Hinduism is that (1) it denies that the Veda is of divine origin, (2) it worships certain holy mortals who, by living exemplary lives here and by self-mortification had raised themselves above humanity to the station of gods, (3) it teaches extreme tenderness toward all animal life. In all of these three points it tends toward Buddhism.

Its moral code, or "great duties" consists of (1) refraining from injury to life, (2) truth, (3) honesty, (4) chastity, and (5) freedom from worldly desires.

Its four other teachings, or "merits" are, (1) liberality, (2) gentleness, (3) piety, and (4) penance.

Zenism

—In Japan, a sect revolted against the idolatry of the Buddhism as there practiced, and hold that book knowledge is in vain and that one must look within. Not long after the Zen sect came into existence in the twelfth century, two other popular sects arose sometimes called the Happy Land sects, because they teach that salvation may be attained not through knowledge of illumination, but through faith. The Jodo sect, one of the Happy Land sects, later branched and one section is called the Jodo-Shin-shu. At present this sect has ten sub-sects and not less than 20 thousand temples in Japan. The Zen sect is almost as strong.

Chapter 4

Serial No. 136
Original Copyright 1949
Elbert Benjamine

Copyright
August 2002
Church of Light

Tao, Confucianism,
Zoroastrianism and
Mohammedanism

Chapter 4

Tao, Confucianism, Zoroastrianism and Mohammedanism

TO understand the religion of China as set forth in their literature as far back as there are records of the Chinese people, is to understand their religion today. It is true that today in China there are three chief religions: Taoism, Confucianism, and Buddhism. Taoism is the older form of belief. Confucianism is merely a classical and orthodox interpretation of Taoism. And Buddhism in China is a belief grafted on the older stock without impairing the latter.

It seems to me there has never been a more scientific approach to religion than the fundamental tenets of Taoism. The weakness of the religion lies not in its fundamentals, but in the fact that as time elapsed everything connected with it was based on ancient authority. The Chinese came to assume that everything of value was already known about the universe and its manifestations. This led to crystallization and prevented growth. Instead of critical investigation, blind belief in the statements of those more ancient were accepted without question.

Taoism, even as does The Religion of the Stars, holds that the universe has intelligence, and that this cosmic intelligence is expressed through the movements that take place in the universe. If mankind acts against the will of the universe he meets disaster, but if he conforms his actions to the universal will he prospers and is happy. Man is considered a microcosm, a miniature universe; and the various movements of the macrocosm, including the planets in their orbits, have an influence upon man. Man, therefore, should intently study all the phenomena of nature, that he may by his actions cooperate with the intent of the universal consciousness.

Tao means Road, or Way, signifying the way the universe moves, Jen Tao being the manner of life man should live to conform with such movements. Tao is divided into T'ien Tao, the Tao of Heaven, and T'i Tao, the Tao of Earth. In fact, the whole system is based upon the thought which in Egypt was formulated, "As it is below, so it is above; as on the earth, so in the sky." Thus does the doctrine of correspondences lie at the base of Chinese religion.

Furthermore, the occult doctrine of polarity is clearly set forth: Heaven, or Yang, being positive to Earth, or Yin; there being souls having affinity with each. The soul

of man is dual, consisting of a shen, or heavenly soul, and a kwei, or earthly soul. At the death of the body only the shen, or as we would call it the divine soul, returns to its heavenly source. Other spirits that have an affinity for the spiritual side of the universe also are called shen, and those that have an affinity for the grosser side of nature, or as we would call them the animal souls, are called kwei. The universe is supposed to be crowded with shen and kwei, gods and demons, which are antagonistic to each other, the former to be propitiated that they may prevent the action of the latter.

We are apt thus to render as “gods and demons,” whatever helpful and harmful spirits are believed in by other people without considering that they would place our saints, angels, and evil spirits in the same classification. In *Cosmopolitan Magazine* for February, 1926, Henry Ford, the first great automobile magnate, is quoted as follows:

“I believe that there are entities or little auxiliary life atoms, or whatever you want to call them, flying about and when a person is doing something to help people—doing something for people and not for himself—that these entities fly to him and help him. The vital stuff we need is all about us—it feeds and strengthens our spirit. All we need is to keep our lives pointed in the right direction and what we need will come to us.”

I am sure no religious Chinese would find fault with such a statement, nor would the educated occultist of any land. The terminology is somewhat unique, but the facts coincide with observation in all lands and ages. And in China the belief, which I consider well founded, that evil actions attract evil unseen influences—what really happens is that through extrasensory perception one tunes in on intelligences of propensities similar to one’s thoughts—has been one of the strongest forces in behalf of morality.

The Chinese believe in a life of strict honesty, virtue, and beneficence, because they conceive the universal intelligence to possess these qualities. To be more specific, the four cardinal virtues are:

Benevolence, righteousness, laws and rites of social life, and correctness, or knowledge.

The doctrine of Tao is held to have been handed down from the earliest ancestors, who were perfect or holy men and knew better than any other creatures what Tao is because they lived while it was being established among mankind. All that has been done subsequently, therefore, has been to transcribe and interpret this ancient doctrine. In this work four names stand out: Confucius, Lao, Chwang, and Kwan.

The best known of the Taoist works to Western students is the *Tao the king*, by Lao-Tse. Lao admitted that information gained through the use of the five senses can be useful, and that reason can be employed to solve the less important problems, but that neither can lead man to spiritual knowledge. He held, more than 500 years BC—and people may well heed his advice today—that the first step in spiritual

progress requires the unlearning of much that civilization holds to be true, otherwise the mind is unable to act as a mirror of Tao.

This old philosopher who wrote the Bible of Tao understood very well the technique of extrasensory perception as employed today; for in contemplation as advised by him, he taught that in its practice all preconceived opinions should be dismissed, and that there should be a deliberate inhibition of cerebral activity.

Confucianism

—With the coming of the Han dynasty, two centuries BC, the interpretation of Tao given by Confucius was declared the official religion of China. His works became the orthodox Bible, while the works of the other three constituted the Bibles of the other Taoists who did not hold to Confucianism.

Confucius lived 551-478 BC. His code of morals, based upon Tao, has only been surpassed in that he gave the Golden Rule a less positive turn than it was later formulated by Jesus. He taught, “Do not unto others what you would not have them do unto you.” To give his code, and his doctrine of “The Perfect Man,” more in detail would be merely to state what is at present among all civilized people regarded as of highest virtue. Both the Taoists and Confucius taught the necessity of virtue and right action; but Confucius held rather to the opinion that the rules of right conduct may be learned through intellectual effort, while the Taoists held to the more mystical view that information comes from within when the intellect is Wu-Wei (quiet).

So thoroughly is it believed in China that death does not sever affectional ties, and that those who have passed to the next sphere may advise and assist those yet on earth, that it gave rise to ancestor worship. And so thoroughly are the Chinese convinced of the truth of astrology that its study and practice are deemed essential as an official part of the government. Almanacs were published officially as far back as the 24th century before our era. Magic, both white and black, is believed in, and various forms of divination are practiced. The most prevalent form of divination is called fung shui. It is a mixture of geomancy, symbol interpretation, and astrology, applied to selecting the proper location in every respect for the construction of houses, graves, and temples. (For further information consult especially, *Religion in China*, by Professor J. J. de Groot).

That man should study the universe that he might conform his actions to the universal will is as solid a foundation for religion as can be found. But when the state took over the religion, as it did in the age of Han, and declared that what had been taught about the universe in the past must be true, and from thence on permitted no new ideas to be taught, and vigorously and cruelly persecuted any infringement of this law, China crystallized. Then, as now, when any people become convinced they know all that can be known about the operation of nature, progress ceases and decay sets in. Considering Confucianism and Taoism as one religion—and they are really the orthodox and less orthodox conception of essentially the same religion—with its 310

million followers, it is second only to Christianity in having the most numerous adherents of any religion in the world.

Zoroastrianism

—Somewhere in Persia about 1,000 BC was born Zarathustra, later known as Zoroaster. In type he was much like the old Jewish prophets, although he probably was an Aryan, and most certainly propounded a religion which, aside from his visions, was derived from older Aryan sources and modified to suit his needs.

When he was thirty years of age he had a series of seven visions. The first vision was of Mazdah (the supreme Being) at the Last Judgment, and the second was of Mazdah at the Creation. The other five visions were of the archangel Good Thought, asking if he belonged to good or evil, teaching him the ways of Mazdah, observing his zeal in the cause of good, and finally sending him on his mission as a preacher.

Henceforth, in the face of relentless persecution and in spite of many obstacles, he taught his doctrines both by word of mouth and in writing. These sacred writings of Zoroaster were reputed to have contained over two million verses, written in golden letters on twelve thousand cow hides tied together with golden bands. At the age of 77 Zoroaster was slain by his enemies as he stood by the Sacred Fire in ministrations.

When Alexander invaded Persia it is said that about 333 BC, he destroyed the official copy of the Avesta, as the writings of Zoroaster are known. The religion then sank almost into oblivion for nearly 600 years. But at the end of this period the first of the Sassanian kings—226-240 AD—ordered whatever fragments had been preserved, and such portions as were remembered by the priests, to be collected. This was finally accomplished and constitutes the five books of the Avesta of today, although, of course, this is but a small portion of the original work.

The first book, the Yasna, contains the metrical hymns of Zoroaster and gives the main tenets of his teachings. The other books contain the litany, the priestly code, accounts of creation, accounts of the golden age, accounts of the first destructive winter, or age of horrors, songs, invocations to different angels, etc. Because the language spoken in the time of the restoration of the Avesta was so different from the language in which it was originally written, the latter was intelligible only to the priests who had preserved its significance in oral tradition. It was therefore translated into Pahlavi, and this came to be known as the Zend translation, also erroneously termed Zendavesta.

Zoroastrianism flourished in Persia from the time of the Sassanian kings until the country was conquered in 652 by Mohammedan invaders. From that time to the present, although there are supposed to be some ten thousand surreptitious believers yet in Persia, its adherents have been frightfully persecuted. Most of them fled, and after some wandering gained a foothold in India, where about 100,000 of them, known as Parsis, today are much respected. The Avesta is the sacred book of the Parsis. But Persia (Iran) remains a Mohammedan country.

According to Zoroaster, Mazdah, later called Ahuramazda, also Ormuzd, is the creator of the universe. Mazdah, however, has an enemy, and Evil Spirit, almost as powerful as himself, but who eventually, with the help of man, he will overcome. Perhaps the most characteristic teaching of Zoroaster is that every good has its evil counterpart, and that in all realms and conditions there is a struggle between the two influences. There are good spirits that inspire man toward righteousness and evil spirits that impress him to acts of iniquity, and throughout there is warfare between these two. Both strive for man's soul; for after death the soul is judged by Mazdah and if the good predominates it goes to a region of bliss and enjoyment, but if the evil predominates it goes to a region of eternal torment. Here we have, about a thousand years before the commencement of Christianity, a very clear picture of the Calvinistic heaven and hell. In the final judgment, if there is an equal balance between the good and evil, there is a middle realm—the prototype of purgatory—somewhere between heaven and hell, to which the soul goes.

Zoroaster, whose birth was announced by miraculous happenings, by the mercy of Mazdah was sent as a Savior to convert men from a life of wickedness to a life of doing good. And at the time of judgment in the after life he stands with the soul, that no good deed may be overlooked. In this judgment good thoughts, good words, and good deeds are the three kinds of merit, and these three are continually emphasized in the Zoroastrian teachings. It is also taught, and looked forward to, that a time will come when the Evil One will be completely overthrown and the world purged of sin. This latter will be accomplished by a flood of molten metal which will be but a pleasant bath to the righteous, but will destroy the wicked.

Ranged about the Supreme Creator, Mazdah, are seven archangels, called Amshaspands, or Cpenta Mainu. Each of these archangels has well defined attributes, and assists in the government of the universe. There are also seven archdemons surrounding the Evil One.

The main theme of Zoroaster's teachings is a zealous endeavor to convert people to right thought, right speech and right action. He continually holds before them the bliss of paradise for those who follow his precepts, and the torments of hell for those who permit evil to influence them. His followers, however, have added some important features to the faith. This is after the manner of followers; for more often than not the things that form the conspicuous phases of a religion were not taught by its first leader, and may even have been denounced by him. Thus did Zoroaster heartily and repeatedly denounce the ritual of haoma, which today is the most conspicuous feature of the Parsi ritual.

This haoma, or hom-juice, is the same as the Soma of the Veda, and the religious ceremony accompanying its preparation and its drinking probably dates back to a time before the Aryans had reached either Persia or India. Zoroaster tried to discourage the practice (it survives in an altered state in the wine of communion of Christian sects), but in spite of his efforts the old Aryan ritual is at present a dominant factor in Zoroastrianism.

Another conspicuous part of the modern Parsi practice certainly was not derived from Zoroaster's teachings, but from an earlier religion. This is their method of disposing of the dead. They build Towers of Silence, open to the sky, with a metal grating near the top on which the dead are placed. The vultures devour the flesh, and the bones drop through the grating to be caught by a special receptacle beneath.

The Parsis hold that earth, water, and fire are holy and that bodies, which would pollute these elements should not be buried, left in the water, or cremated.

The third unique religious practice of the Parsis is the so-called fire-worship. The fire is really not worshiped, at least no more so than the cross is worshiped by Christians, but is venerated as the symbol of Mazda. This important ritual is performed privately by the priests in special Fire-temples. The sacred fire in these temples is fed with holy fuel, such as aromatic sandalwood, and is never permitted to be extinguished. The priests who attend to this must be sons of priests, although such sons may reject the priesthood if they so elect.

Mohammedanism

—Jesus did not deny the value of the religion of the Jews, but added to it a message of hope and a teaching of love. Neither did Mohammed deny, or try to destroy, the teachings of the Bible or those of Jesus. He brought to his people a doctrine of life. Mohammed believed in the Jewish prophets of old, and that they were inspired, particularly stressing the doctrine that Moses, Abraham and Jesus were divine teachers.

Mohammed was an Arab, bringing his message to the Arabian people. This people, as well as the Jews, were a Semitic race. Their traditions, extending into the dim vistas of the past, tend to a belief in wise patriarchs and inspired prophets. Mohammed believed his mission was to crown and complete the teachings of Jesus and the older Jewish prophets.

He was born 570 AD, at the age of twenty-five married a rich widow, and later raised a family. He did not receive his call to act as the messenger of God until he was forty years old. At that time the angel Gabriel appeared to him and gave him instructions, and he spent the remainder of his life in preaching and spreading his gospel.

At that time, in addition to other forms of Animism, there were worshiped throughout Arabia something over 300 tribal gods. Of even greater power than these tribal deities, and acting as a protector over them, was a black stone at Mecca. This was a meteor which, some hundreds of years before Mohammed's time, had been used as a corner stone about which a small square temple of black stones had been built. Certain months of truce had been established among the warring Arabian tribes, in which they made pilgrimage to this Kaaba, marched about it, bowed themselves, kissed the stone, and then went their way.

Mohammed, living in Mecca, observed this; and also that idolatry was prevalent. Mecca, as a religious center, was making much money from its various gods. But

Mohammed's first revelation convinced him that there is but One God, and that the worship of various forces and objects is sinful. He began to talk about this, and of course the inhabitants of the town, with whose money making he was interfering, began to persecute him. He made converts slowly, and on June 16, 622—a date which fixes the commencement of the Mohammedan era—when he was fifty-two years old, he was forced to flee from Mecca and take shelter in the neighboring town of Medina. This flight, called the Hegira, marks also the beginning of Mohammed's success. The inhabitants of Mecca attacked Medina, where Mohammed was sheltered, but were unsuccessful; and at a later date Mohammed returned in triumph to Mecca as its master, and finally became the master of all Arabia. He died at the age of sixty-two.

Whatever other mistakes Mohammed may have made, he was not insincere and not dishonest. He claimed no infallibility, and on occasions admitted that he had made mistakes, and took pains to rectify them. Christianity at this time was particularly corrupt, which explains why so many of its followers were converted to the faith of Islam. Mazdaism, the cult of the Zoroastrian Magi of that day, also had fallen into a state of decay, and its followers readily adopted the more vital religion of Mohammed. Thus the Moslem Empire, under Mohammed and his successors, carried forward by successful warfare, by 750 extended along the south Mediterranean coast to the Atlantic Ocean and into Spain, and from the Mediterranean eastward to beyond the Indus in India. Had it not been for family quarrels over who was Mohammed's rightful successor, which split the Empire into warring factions, it is probable the whole world would have been conquered.

Now let us see what these doctrines are which have such a hold on 230 million people and give Mohammedanism the third largest following of any religion in the world.

In the first place to Mohammed the idea of three gods reigning over the world seemed illogical. His intellect demanded the worship of One Supreme Deity termed in Arabian, Allah. The Christians, according to Mohammed's idea, worshiped three gods—the Father, Jesus, and Mary—and certainly in his day the Christians were endlessly wrangling about trinities and various other obscure points. But Mohammed insisted, as the basis of his doctrine, that there was only One God. He did not believe in godlings, and while he believed in angels and jinns, these were not to be worshiped. Furthermore, the Jews claimed to be the special favorites of their god, Jehovah. But the One God, Allah, was alike and impartially the God of all the people of the world.

In the beginning Mohammed and his followers faced Jerusalem to pray. But meeting with great rebuffs from Christians and Jews whom he tried to convert, he finally permitted his followers their ancient custom of looking to Mecca for religious inspiration. The Kaaba had been a place of worship and religious pilgrimage for centuries, and Mohammed compromised enough in his denunciation of images to permit his people to use the venerable meteor stone at Mecca as a symbol of their faith, in the same sense that Christians adore the cross.

But while he permitted and encouraged the holy pilgrimages to Mecca, he strictly forbade mysterious symbolism, rites, chants, and such outward forms as encumber so many religions. And, moreover, there were to be no priests. To the devout Mohammedan Allah is near and hears his prayers without need of intercession on the part of any other.

The picture of a hell of torture for the wicked was made vivid. And for the faithful, who had lived charitable lives, he did not build a picture of heaven in which there would be saints, and priests, and kings, and ceaseless praise and worship and devotional music. A great city like heavenly Jerusalem, paved with gold, adorned with precious stones, and a great white throne occupied by a splendid ruler, about whom angels played on harps, with the elect close at hand to share the pomp, power, and glory, were well calculated to enthuse the Jews of those days. But to Mohammed's people such an environment offered little attraction.

They were a desert people, to whom a city paved with gold made no appeal. But after their hot dusty treks across the desert they longed for shade, and rest, and cooling drink, and the company of fair women. Therefore, in the heaven of Mohammed, all are brothers on equal footing, and the surroundings are just as these children of the desert crave.

In the Moslem paradise, the faithful are led to a garden of bliss, dressed in fine clothes, and permitted to repose on green cushioned couches, facing others similarly fortunate and enjoying "fruit and forgiveness. They eat fruit without indigestion, drink milk and honey and wine without headache; these draughts seasoned with various spices being carried about in silver goblets by comely youths. There are also present well-grown, chaste, large-eyed maids of the same age as the faithful. No deceit or folly comes into this blessed place. According to the Koran, which is the collected utterances of Mohammed and thus constitutes the Mohammedan Bible, these maids of paradise are very modest and well behaved, and the wine does not intoxicate. The picture is one that while appealing to the senses, has a refined and elegant turn rather than being of grosser mold.

As to hell, the condemned are said to be neither dead nor alive in hell fire, but greatly yet vainly desiring to end their eternal suffering.

In Mohammed's day, and for a long time afterward, women were believed to have no place in paradise. But in more recent times the women, now feeling less servile than then, also had need of a heaven to reward them for goodly lives. So it has come to pass that Mohammedan women have a paradise also, in which they rest at ease, and are waited on by comely young men, who bring them cooling draughts and provide for their comfort.

It would seem that expediency forced Mohammed, against his convictions, to modify his doctrines sufficiently to allow homage to be paid to the ancient Kaaba stone at Mecca; for there seems little doubt in view of his earlier denunciations, that he looked upon this veneration of the Kaaba as something evil.

But so strong was the custom that it seems evident that he felt that to continue to oppose it would weaken his power. It would seem that he came to believe that the pilgrimage to the Kaaba at Mecca was a unifying element among his people, and was to be endured as a necessary evil. And with the passing of Mohammed, and the rise of other Caliphs, one after another of the customs and ceremonies that had been in use before the advent of Mohammedanism crept back and became a part of the religion.

But Mohammed himself taught against offering sacrifices, and continually stressed the importance of good deeds. To quote passages from the Koran:

“Paradise is prepared for those who expend alms, for those who repress their rage and pardon men; God loves the kind.” “Free the captive, feed the orphan and poor, believe, encourage others in patience and mercy.” “Righteousness is not that one turns his face to East or West, but that one believes in God and the last day and the angels and the Book and the prophets and gives one’s wealth for the love of God to kindred and the orphans and the poor and the sons of the road and beggars and captives, that one is steadfast in prayer and gives alms, and abides by one’s covenant and is patient in poverty and distress and in times of violence; these are they who are faithful believers.”

One of the outstanding features of Mohammedanism is the strong insistence on kindness and consideration for others in everyday life.

Originally the profession of faith was: “There is no God but Allah.” Later this was modified into, “There is no God but Allah and Mohammed is his apostle.” The faithful are also expected five times a day to repeat a formula of prayer while bowing and facing Mecca.

After the time of Mohammed, in the eighth century, the Christian church split into the Eastern Church and the Western Church, the latter holding to the old title “Catholic,” borrowed from the New Testament, and the Eastern Church being content with the title “Orthodox.” They are sometimes called the Roman Catholic Church and the Greek Catholic Church, the latter being the dominant one in Russia before the revolution in 1917. Then in the sixteenth century, led by Martin Luther, the Protestants separated from the Roman Catholic Church. Thus in America the most influential religions are those of the (Roman) Catholics, Protestants and Jews.

These at this time, however, are divided into 259 different creeds, each of which bases its religion on the Bible, but gives the writings there found a somewhat different interpretation. And a leader of any of these 259 creeds usually will hold that only his interpretation is correct. And each demands that the view of his creed shall be accepted, not because it coincides with observed facts in nature, but on faith. Yet if people are educated to take the word of such leaders without question, and to refrain from demanding any proof that what the leader says is correct, not only do they become conditioned to accept erroneous religious ideas—for if one of these creeds is correct the other 258 must embrace some error—but they become conditioned to accept the ideas of their leaders without proof, and thus become easily exploited politically and economically.

The Christian religion is here mentioned because parallel conditions developed in the Mohammedan religion. The Sunnites hold that the Omayyads were the rightful successors to Mohammed, while the Shiites hold that his successor should have been Ali. The Sunnites are more numerous in and dominate Turkey and Arabia, while the Shiites prevail in Iran (Persia) and India, although like Protestants and Catholics they frequently live in the same country side by side. The Sunnites believe not only in the Koran, but also in the very extensive orthodox tradition (Sunna) surrounding Mohammed, as the word of God. The Shiites accept the Koran implicitly, but reject the tradition, and hold as an article of faith that Ali is the vicegerent of Deity.

Other disputes arose, such as whether the Koran was and always had been coexistent with God. The question of free will and predestination was also a source of argument. In the course of time, also apparently following the invariable rule in such matters, Mohammed, who undoubtedly had both good qualities and grievous faults, was made by his followers into a sinless being who performed miracles. The old Hero Cult trend, both then and at the present day, is difficult to avoid. But even more strange, for Mohammed denounced all such practices, a host of saints has risen, patron saints of villages to whom the Mohammedan prays for protection or for other boons. Nor, at the present day, is the religion which was to have no priests entirely free from them in some of its sects.

Mohammed apparently accepted the teachings of the Bible with one exception. He refused to believe in the work of creation, as related in Genesis, that God had rested on the Seventh day. Instead of Saturday, as with the Jews, the Mohammedan day of congregation is Friday. Preceding prayer, ablutions are customary; for it is strongly emphasized that godliness and cleanliness are closely akin.

Mohammedanism came to be called Islam, an Arabic word signifying "entire submission to the will of God." From this word also came the words Moslem and Musselman, meaning those who profess the religion of Mohammed. But due to incorporating various elements of older and adjacent religions, the Islam of today is as little like the religion of Mohammed as most Buddhism today is like the religion of Buddha, or for that matter, as the teachings in many present-day Christian Churches are like the humble teachings of Jesus.

Bahatism

—This is a heresy of Mohammedanism which endeavors to reconcile all religions, and especially Buddhism, Christianity and Mohammedanism. It had its origin in Persia (Iran) and is based upon divine revelations. The first of the Bahai revealators, Ali Muhammad, announced himself on May 23, 1844. He declared himself to be the Bab, or forerunner, of a still greater prophet. He suffered martyrdom at the hands of the Mohammedans. In fact, as late as 1901 there were at one time 170 persons martyred rather than deny the faith.

After the martyrdom of Ali Muhammad, an enthusiast, born in 1817, by the name of Baha Ullah, became the leader and revealator of the movement. He was imprisoned,

due to his effort to spread his religion in Bagdad, Constantinople, Adrianople and Acre. He died in 1892, but his son, Sir Abdul Baha Bahai, born on the same day Ali Muhammad made his first announcement, then took over the movement and became its inspired leader. Founding Bahaism, he taught that heaven and hell are conditions of the soul. He died in 1921.

The Bahaists during the past decade have finished a large temple of remarkable architecture at Wilmette, Illinois, on the spot which they claim is the center of the world. They hold that tolerance for the ideas of other people is to be cultivated, and certain special reforms are to be inaugurated, one of which embraces the adoption of a universal language Monogamy is taught, asceticism discouraged, drugs and intoxicating liquors are prohibited, and love rather than harshness is emphasized. There are temples and teachers, but no clergy apart from the laity. The movement stands for liberal education for both men and women, and emphasizes the importance of securing world peace.

The Two Great Weaknesses of Mohammedanism

—The greatest weakness of Mohammedanism is also the greatest weakness of the Christian Fundamentalists. The Koran and the voluminous orthodox tradition, as does the Bible, frequently makes contradictory and irreconcilable statements. But the devout Moslem is not permitted to inquire how or why. He must take everything on faith.

Islam, as well as orthodox Christianity, has had its iron curtain by which it has succeeded in hiding any information inconsistent with the Koran. It has successfully stifled thought; for numerous things are taught which are contrary to things proved by modern science. But education has been entirely in the hands of the ulema. The ulema corresponds to our clergy. They do not stand between the worshiper and Deity, but they act in the capacity of spiritual advisers; and a devout Mohammedan takes no important action of any kind without consulting his ulema.

Thus is it that the education of the people, or even the education of those who make a profession of scholastic attainment, cannot go beyond that which is compatible with the Koran. Christianity in the United States, at the present time, has succeeded in three states in passing laws making it illegal to teach evolution in public schools. And a few hundred years ago Christianity made teaching that the world was round punishable by death. In a similar manner, in the Moslem world, to teach anything that seems to be at variance with the ideas set forth in the Koran is punishable.

Yet any religious, political or economic doctrine that limits investigation of the facts, and prevents those facts from being given public discussion, by such actions confesses its fear that the doctrine thus protected is unsound; for if it is sound, investigation and unbiased discussion will only strengthen its acceptance.

To the devout Mohammedan, or to the Christian Fundamentalist, a thing may be entirely black and entirely white at the same time. Sacred writings must be believed, in spite of the logical impossibility of some of their statements. Thus the Koran affirms that there is reward and punishment in another life such as presumes moral responsibility and free will in man. Yet it also affirms predestination, a common Moslem teaching being that man from the very beginning is predestined by the will of Allah to live just such a life in every particular as he does live. Yet in spite of this teaching that he cannot change his life in the smallest degree from that which Allah decreed, he is asked to believe that he will be judged upon his merits, and sentenced to everlasting joy in heaven, or everlasting torment in hell.

This is parallel to the belief of Christian sects that only those will be saved who embrace the beliefs of the particular sect, but that God is responsible for the environment into which each person is born. As the environment commonly is responsible for the individual's belief, and millions of people never even hear of the particular sect in whose creed there must be belief to be saved, the reward of heaven or hell is entirely beyond their responsibility. As in the Mohammedan belief, God alone is responsible for the suffering of those in hell.

Aside from the absurdity of such ideas, the fatalism believed in by the Mohammedans is psychologically detrimental. And this Mohammedan fatalism is paralleled by the fatalism of astrologers of certain schools. These astrologers hold that instead of being the energies of the inner-plane weather, astrology fixes a pattern for the individual to follow from which he cannot deviate. Instead of teaching that astrology maps energies the impact of which enables the thought-cells to exercise their psychokinetic power to bring events into the life, and that it is possible to recondition these thought-cells and thus get them to work not for the things otherwise indicated, they teach that whatever is indicated by astrology is bound to come to pass, and there is nothing the individual can do to prevent it.

Yet experience refutes this view. Intelligence and initiative are, within reasonable limits, limits which will expand with more knowledge, able to overcome the influence of planetary energies and other forces of nature. The history of the human race is a record of difficulties that seemed to be the obstructing hand of fate that were surmounted and pushed aside. And any doctrine of predestination or of the fatality of astrology not only is unsound, but it is detrimental to humanity because it discourages the use of initiative and intelligently directed effort.

Conversion and Confession

—While it must be admitted that those converted at religious revivals by emotional evangelists in quite a large percentage of cases backslide within a few weeks to much the same kind of lives they lived before, yet the experience of conversion is a valid, and often useful, psychological experience. It is not confined to those who become converted to any particular religion. Mohammedanism and Buddhism, as well as the

various Christian sects, have devotees who have had this experience, as also have some who follow The Religion of the Stars.

For a further study of religious conversion, *Variety of Religious Experiences*, by Wm. James is a useful book. There are many cases on record, and not confined to any one or two religions, in which the life after conversion has taken on a radically different and markedly more constructive quality dating from the time of conversion. Furthermore, confession, when it is believed the sins are thus absolved, has often served a useful purpose.

From ample data collected on this subject, it would seem that people can be divided into two broad psychological types. One of them has few repressions, few conflicts between different sections of the unconscious, a general feeling that all is well with the world and that in the end everything will work out satisfactorily. A person of this type has few violent struggles with himself, and such adjustments to life as must be made are taken in well ordered steps. In the course of time he may join some church, Christian, Stellarian, or what-not. Or if he is a freethinker he may merely enter into a state of consciousness in which, like Walt Whitman, he feels all is well.

But though such a person joins a church or religious organization as a natural step in the development of his ideas and feelings, he never experiences the sudden psychological change which overtakes those who experience conversion. His psychology is such that he does not feel the need of being saved, does not feel inadequate to meet the requirements of life here and hereafter, does not require a revolutionary psychological process in which he is spiritually born again. And he is inclined to regard those who experience the more violent emotional form of conversion as nervously unstable and somewhat hysterical.

The other type has repressions and violent inner conflicts. Such a person has been taught in his early years that the feeling of animal desire is sinful, and he has crowded back down into his unconscious and refused to recognize these natural biological impulses. Or he has been given such a vivid picture of hell in his childhood that it has resulted in an inner chronic state of anxiety. Or he has tried to live up to certain high standards of conduct, and as a result of failing to live his ideals he has built into himself a guilt complex.

Still others of this type develop a fear complex because they feel so helpless in the midst of environmental forces over which apparently they have no control. They feel unable to meet and cope with the future. There is constantly present in the background of their minds a stratum of worry and anxiety. The teaching that man is conceived in sin, is born in sin, and lives in sin, when accepted, develops an inferiority complex closely linked with fear.

There are many factors which may contribute to this type of personality, but whatever they may be there is a split in his unconscious that causes him to feel that there are two lives; that the life he is leading is evil, or is unsatisfactory, and that there is another type of life which would bring him happiness and spiritual satisfaction.

What this type of person needs, unless he learns to employ mental alchemy (Course IX) is psychoanalytical treatment. He needs to have his repressions released through recognizing them for what they are, and he needs to have his conflicts reconciled. And that is what conversion does. It reconciles the conflicts and releases the repressions, giving a harmonious unity to the previously conflicting factors within the unconscious mind.

The devout church member who strives to live according to the tenets of his religion, whatever they may be, when he does something contrary to the teaching of his religion, feels guilty. He feels he has done wrong, and this sets up an inner conflict. And if he fears he will be punished for the deed in the hereafter, or lose some advantage in the life after death because of it, he develops anxiety. But if he is convinced a priest has the power to absolve him, and he makes a confession and fully believes his transgression has been completely forgiven by God, the inward anxiety is banished. He has had a very effective psychoanalytical treatment.

To many people who have few repressions and no inward sense of guilt, there is an intense desire to know the meaning of life so they can make something out of it. Yet to them the mad scramble for material wealth and position seems unattractive. They feel that life should have some better purpose, and that if material possessions and belief in some illogical creed is all it holds, that it is not worth while.

On many, many occasions those who have for the first time contacted Brotherhood of Light lessons and read some of them have said that the Stellarian teachings were just what they had been looking for all their lives. Furthermore, such conversion to the Stellarian Religion, and the release of the feeling of uncertainty as to the purpose of life, perhaps with a reconciliation of other inner factors, has often resulted in the convert permanently giving up the habit of becoming intoxicated, or the habit of sharp practice in business, or other bad habits, thenceforth to the end of his physical life living happier than ever before, and contributing far more than previously to universal welfare.

Chapter 5

Serial No. 137
Original Copyright 1949
Elbert Benjamine

Copyright
August 2002
Church of Light

Hinduism and Buddhism



Drawing by Mildred Schuler

Chapter 5

Hinduism and Buddhism

IN ancient India, coming from no one knows where, there was a dark-white population, called the Dravidians. They settled in the valley of the Ganges and there possessed a civilization. They had at this time already progressed above the older heliolithic culture. They knew considerable about astrology, practiced magic (psychokinesis), and believed in life after death.

Historians assert that these people never rose to the height of culture possessed by ancient Sumeria and ancient Egypt. Certain it is that they did not possess any form of writing, hence the assertions of the Brahman priests as to the high antiquity of the sacred writings of India must be discounted. If they existed, they existed elsewhere than in India.

Writing was brought into India at the time of the Aryan invasion, which was not earlier than the time of the great king Hammurabi, 2,200 BC, who conquered the Sumerian-Akkadian empire and founded the first Babylonian empire. About the time the Semitic Amorites, under Hammurabi, made this conquest—the second time the land of the Euphrates and the Tigris had been conquered by a great Semitic leader, the first time being by Sargon I, in 2,750 BC—history tells us that an Aryan-speaking people who then occupied North Persia and Afghanistan came down through the passes to the northwest and conquered India.

Previous to this time India, as already mentioned, had a civilization springing from heliolithic culture, as heliolithic monuments still standing in India attest. But this Aryan people brought the art of writing, the Sanskrit, for instance, being an Aryan language. Thus it is, in spite of frequent assertions to the contrary, that the first sacred writings developed in India are several thousand years later in point of time than the first sacred writings known either in Sumeria or in Egypt. (See, for instance, *The Outline of History*, by H. G. Wells, page 147).

This invasion of the dominant and aggressive Aryan-speaking people also had another, and far less beneficial, result. The invading people constituted themselves rulers of the aboriginal population. They became priests as well as rulers, and to maintain their ascendancy and to discourage intermarrying with the natives at least encouraged, and probably founded, the caste system. Certain of themselves they established as the highest caste. This caste, the Brahmins, constituted themselves the

exclusive teachers of the people, and the history of India is the history of the success of this caste, through sword and through the dissemination of cunningly devised religious dogmas, in keeping the rest of the population servile to them. The Aryan invaders of about 2,200 BC brought with them not only the art of writing, but also traditional ideas about religion and magic (psychokinesis) and sacrificial rites and propitiation, that when written became a literature of vast and indefinite extent, known as the Veda. To latter Brahmans and to other Hindu castes of like belief, this most ancient literature of India came to be regarded not as the work of man, but as revelations in fabulously ancient times, made through semi-divine holy ones, called Rishis.

The composition of the Veda extended over hundreds of years and probably dates back to about 2,200 BC. The oldest collection of sacred utterances are (1) the Samhitas, including the Rig Veda, embracing hymns of praise and prayer for use at sacrifices to the various gods; (2) the Atharva Veda, embracing the incantations used in connection with magic rites; (3) the Yajur Veda, embracing sacrificial formulas and litanies; and (4) the Sama Veda, embracing chants and rituals.

The priesthood later wrote extensive commentaries on the older Samhitas, and these were included in the Veda as the Brahmanas. Then as appendices to the Brahmanas, the Aranyakas and the Upanishads were written. These Upanishads, containing as they do the first extensive speculative philosophy, rose to very high esteem, and became the foundation upon which rests the varied and highly meritorious philosophies of India.

In some of the higher philosophies it is taught that deliverance may be had by mystical union with the Super-Intelligence of the universe. This mystical union is through extension of consciousness to high levels, a phase of what is now called extrasensory perception. Yoga explains the practices which lead to such union.

But there is a great abyss between such philosophies and the religion of the vast population of India. Animism abounds, and the masses commonly are ignorant idolators, worshipping objects that once were symbols of some principle to be venerated, but whose inner significance to them now is lost. Yet any and all of these devotees of Hinduism, so long as they obey the rules of caste and ritual demanded by the Brahmans, are not otherwise subject to religious coercion.

It seems that in the beginning any person was qualified to practice magic, to control the lower spirits, and to make sacrifices to propitiate the gods. But as the rites became more complicated and more traditional a special class of Aryans developed whose exclusive duty it was to attend to these things. Among these a special cult devoted itself to the offering of the sacred drink, soma; and these elaborated a ritual in which three sacred fires were used. The Rig Veda is largely a hymn-book for use at these three fire ceremonies, and so elaborate were the rites that only royalty and wealthy men could afford them.

As time passed, so important became the ceremonies, that instead of the gods being besought for favors, in the Brahmanas we find the thought that the sacrifice is able to

compel the gods, and finally that the ritual and sacrifice is the power that grants the desired boon. Also, by the time the Brahmanas were written the caste system was well developed and the priests were called “gods on earth.” That is, they were to be considered the equal of gods.

Thus the priestly Brahmins came to occupy the highest caste. Next to these were the nobles and warriors. Then all the free Aryan people not included in the two upper classes were included in a third caste. The fourth caste embraced the dark-skinned aboriginal population who had been enslaved and subdued. These became the untouchables, 60 million of whom in 1947, by proclamation of the new free nation of Hindustan, legally were relieved of their caste restrictions.

As time passed, the four original castes were split up into other castes and sub-castes. All the while the Brahmin caste imposed on the people ironbound domination to ceremony and ritual. This state of affairs, which up to the present has made of India a backward nation, however, cannot be laid at the door of the early Veda. It was cunningly devised by a priesthood seeking selfish advantages. Throughout the Veda are many high ideals and noble sentiments, and in the later works fine philosophic conceptions.

Because the Rig Veda was devoted to the ritual for the wealthy, the Atharva Veda furnished the material for the popular religion. There was a belief in various orders of spiritual beings, a belief that the planets influence human life, a belief in magic, and a belief that the soul of man exists in some other realm after death. But Hinduism, the dominant religion of India (the 60 million of Pakistan are Mohammedans), is not a religion of set beliefs; it is a religion of caste and ritual instituted by the priestly Brahmins.

Hinduism, which has the fourth largest following of any religion today—about 215 million people— as does Christianity, which has the largest following —about 600 million people embraces a large variety of cults and practices. It is the outgrowth, branching in various directions, of the old Vedic religion. While its adherents may give utmost precedence to this or that deity, they believe in the various gods of the Brahmin priests. At least up to the present time they have believed in the rules of caste and the various rituals imposed upon them by the priests, and in all essential rites, such as those associated with marriage, birth, and death, they seek the aid of the Brahmins.

It should be understood that in India there are innumerable gods. Anything and everything may be deified. Philosophic progress, however, gradually brought about the recognition of one supreme Creator called the Power (Brahma). Brahma, the Creator, also became identified with the old Father-god, and as such is recognized as the most important god of the orthodox Brahmins. But there was still another god who had a powerful following. This was the kindly Sun-god Vishnu who, at least before the time of the Bhagavad Gita, was not a war god, but a god especially worshiped by philosophers and agriculturists. In addition to these two Aryan gods, the original Dravidian population had yet another god to whom they clung

tenaciously. He is the terrifying deity whose worship was explained in lesson No. 134, a deity of wars and pestilence and destruction, the cruel god Siva who is particularly attractive to the wild tribes of India.

The religious textbooks of the Brahmans give instructions for offerings to be made to the spirits and gods of all the various sects and cults. Therefore, when the worshipers of Vishnu became numerous, and the worshipers of Siva also grew in number, to hold all under their dominion at least in matters of caste and ritual, the Brahmans joined these three gods—Brahma, the creator, Vishnu, the preserver, and Siva, the destroyer. These from that time on were taught to be the three forms of the one all-powerful god, even as Christians also worship a Trinity.

But while these three are the powerful gods, the matter did not stop there, for whatever god was brought to the Brahmans, instead of denying it, they said that it was merely a form taken by one of the three powerful aspects of the one god. Thus Vishnu, who bears the symbol of the Sun, was revered by the philosophers as Lord Ishvara. Next he was worshiped as a clan god under the name Krishna or Vasueda. Later, again as a clan god he was revered as Rama. Thus Vishnuism, which is popular in India today, has branched into the Rama sects, those who worship Rama, and the Krishnaites, those who worship Krishna, as well as into numerous lesser sects which each has a special deity to whom it gives chief homage. But this the Vishnu sects have in common, they are pantheistic, believing that the universe as a whole, embracing the seen and the unseen, is God.

While the various branches and sects embraced within Hinduism have been accepted by the Brahmans, it should not be thought that the Sankya and Vedanta religions, and many other philosophic sects, were also the offspring of expediency. On the contrary, they were the result of a deep longing to know the truth and concentrated intelligent application to finding it. These philosophical religions of India have much that is fine and true in them. They result from the strong pressure of intelligence being brought to bear upon the old beliefs.

But while under Hinduism almost anything could be believed and anything worshiped, the Brahmans saw to it that on one matter there was unanimous belief, that was the matter of the caste system.

This belief naturally arises from the dogma of karma and human reincarnation. If the station in life into which an individual is born is the just effect of his actions in past lives, whatever the environment and circumstances, they are merited.

If one is born into luxury and power, it is something to be proud of, a well merited reward for worthy effort in past lives. If one is born into poverty and servility, it is something about which no complaint should be made, for it is merited punishment for unworthy deeds in past lives. There is, therefore, no escape from poverty, misery, disease, and oppression to be had by endeavoring to alter these obnoxious conditions through initiative and enterprise. The way of escape from them lies in enduring them, and in such meritorious acts as are supposed to create good karma. The escape is not in this life, but in some future life when sufficient good karma has been accumulated.

Just what actions create good karma is a matter for the priest to decide, and his decision is based on the personal advantages he will derive from the actions he advocates.

The people are divided into numerous castes, between which there is little in common. Each caste has its iron-bound rules of conduct. Castes do not intermarry, may not eat together, nor touch each other. Even the shadow of a low caste man, according to the doctrines of Hinduism, defiles a high caste man if it touches him, and if it falls on his food makes it unfit to eat.

Those of the higher caste feel little sympathy for those of low caste, as they consider the latter are paying with their misery the just penalty for the sins of former lives. Nor are they inclined in any manner to alleviate that suffering, as they believe that only through great misery will the low caste person be taught to create enough good karma that in the next life he may be born into a better caste. Should the lower caste feel inclined to resent the oppression of their high caste neighbors, they are refrained from aggressive action by the belief that it is their lot to endure, and if they do not submit, it merely means greater misery and sorrow in the next life. Initiative and enterprise are thus effectively discouraged.

I shall not here discuss the unsound features of the doctrine of human reincarnation which results in the doctrine of caste, as I have devoted lessons No. 20 and No. 21 to discussing these factors. But the best way to approach the subject is to become familiar with the manner in which nature actually operates, and the laws that may be observed which give this information. These are given detailed discussion in Course 19, *Organic Alchemy*.

It is to be hoped that the political freedom recently given the 60 million inhabitants of India who belong to the lowest caste, the "untouchables," will in not too long a time abolish the whole caste system; for its doctrines hold the population in a straight jacket of iron from which there is no hope of escape to better things. The life of those belonging to each caste is bounded by unchanging rules. It is hedged in by innumerable restrictions. Not only is vast energy consumed in observing the particular rituals and observances of the caste, but a tremendous amount of it is spent in avoiding those things which the caste may not, in propriety, do. It hampers and restricts the life of the people as effectively as once did the hobble skirt of the Mohammedan women, or as once did the dwarfed feet of the Chinese women.

Where life is made to conform to fixed standards in so many ways there is no opportunity for progress. The people of a caste are forced to be, in all particulars, just what their ancestors have been. Furthermore, the system promotes the despoliation of the lower castes by those higher. The Brahmans in particular, who as priests are the highest caste, are given privileges by their caste which they grossly abuse. It enables them to live a life of ease and luxury, free from the toil of the lower castes, at the same time keeping the latter in dense ignorance, abject poverty, and unutterable misery. The caste system successfully thwarts progress, conduces to squalor and misery,

promotes ignorance among the masses, and in general imposes obstacles in the path of all worth while effort. It is a doctrine opposed to human welfare.

Buddhism

—The hopeless misery that has been the lot of the people of India from a very early date may very well be responsible for the Four Noble Truths propounded by Buddha. The idea had already been evolved by the Vishnuites that Vishnu at different times descended to earth in the form of an avatar, various notable persons in the past having been such manifestations.

Even in the Upanishads we find the Buddhistic idea that birth is sorrow" and the hope held forth that insight and communion with the Soul of All may lead the philosopher to become "Awakened," as later on was Buddha. And as far back as the Rig Veda we find the faint beginning of the doctrine of karma, for one is told to "join his good works" in heaven, and the implication that by good works merit may be so stored up that one can get "beyond the sun and so escape recurrent birth and death."

en in its later and more popular presentation it came to be recognized that between two successive physical lives there is an existence on a nonphysical plane where, as the case may be, there is an adequate taste of heaven or hell.

Siddhartha Guatama, supposed to be a prince of a Sakya clan living to the north of Benares, according to tradition was born about 562 BC Little is known about his birth and early life, for as falls the lot of great reformers his enthusiastic followers, under the impulse that earlier gave rise to the Hero Cult, have clothed this part of his life with miraculous happenings. Apparently he accepted the host of gods, godlings, spirits and demons generally believed in by his contemporaries. In this he may be compared with Jesus, who did not contradict or overthrow the teachings of Judaism, but accepted them, and used them as a basis for a still higher teaching. Both came not to destroy, but to fulfill the law. In many respects the lives of the three Saviors having the greatest following, Jesus, Mohammed and Buddha, run parallel.

This is particularly true in that their followers made claims for each that they had themselves taken pains to deny, and that in the course of time a great mass of custom, ritual, and doctrine from still older beliefs were adopted as if they also had been a part of the Savior's teachings. Jesus puts to one side the imputation he is a god, stating plainly, so it seems to me, that he is a man. Buddha rejected the notion of some of his followers that he was the Lord of the Universe, stating plainly that he is "only a teacher." We now hear of an Esoteric Buddhism, yet Buddha himself repeatedly denied having any esoteric doctrine, stating that "his hand was not the closed fist of the teacher who keeps some things back."

The various sects of Christianity today have added a great amount of custom, ritual, and doctrine to the simple utterances of Jesus. So also, though in each case the great underlying doctrine of the teacher is preserved, Buddhism has split into sects and factions, and a vast amount of ritual, custom and doctrine has been added to it. So, if

we are to get the original doctrine in its purity— either that propounded by Jesus or that propounded by Buddha —we must get as close as possible to the original source.

In neither case, so it seems, did anyone who heard the discourses write them down. One person told another, and this one handed it on to the next generation, and so on. It was probably even longer before any of Buddha's discourses were placed in writing than the time that elapsed after the crucifixion of Jesus before any of the Four Gospels were written.

The first proof of written scriptures in Buddhism is the edict of King Asoka in 242 BC—240 years after Buddha's death—that the sacred books of the Law of Buddha should be collected. In the Pitkas, or baskets of the Laws, we have the earliest and most authoritative account of the actual teachings of Buddha, as distinct from the teachings of later sects. Of these earlier teachings the *Dhammapada* undoubtedly was compiled to give a summary of the essential principles of Buddha's doctrines to those who were incapable of committing to memory the complete contents of the three Pitkas. Excellent translations of some of these early works may be found in *The Sacred Books of the East*.

While there are parallels in the development of Buddhism and Christianity, in doctrine there is a constant contrast. Buddha dispenses entirely with psychokinetic proofs, while miracles take an important part at the beginning of Christianity. Buddha has no concern for superhuman authority, while Jesus looks constantly to the Father in Heaven. Christianity seeks some saving grace, or blood of the Lamb, or other form of vicarious atonement, but—which all observation of nature indicates to be correct—Buddhism insists that each must redeem himself.

Christianity adopted the old Hebrew idea of the creation of the world, and the manner sin came into the world; but Buddha attempted no explanation either of creation or of sin. Christianity teaches that pain and suffering may be alleviated by prayer—and observation shows they often are; and that the Saviour takes upon himself the burden of his follower's sins. Buddha does not teach that pain may thus be alleviated, and states that each must bear the burden of his own sin, declaring that no god even, can do for any man that work of self-emancipation and self-conquest that leads to salvation. In the *Dhammapada*, 163, he says: "By oneself the evil is done, by oneself one suffers. By oneself evil is left undone, by oneself one is purified. Purity and impurity belong to oneself; no man can purify another."

The goal of Buddhism is Nirvana. To many western scholars this amounts to annihilation. Yet there is a finer interpretation, which is the view of many Buddhists, that Nirvana is a tranquil and perfect mind, thus promising security from all attacks of the senses and lower passions in an intellectual and spiritual life. But in whatever state of life man finds himself, Buddhism admonishes him to trust no one but himself, to rely only on himself, and to look to no other. "Not even a god can change into defeat the victory of a man who has vanquished himself." *Dhammapada*, 105.

Tradition states that Prince Guatama, driven by a sense of the vanity and misery of human life left the palace of his father to seek enlightenment. The Brahmans he

interviewed advised him, as was their doctrine, to seek it through self-maceration in the heart of a savage forest. After weary years of ascetic practices he found that he could not gain enlightenment in this manner. After adopting a more moderate way of life—the middle way—however, enlightenment dawned on him and he became the Buddha. He then immediately set forth teaching his gospel. He lived to be eighty years of age, and during his forty-five years of preaching made many converts.

The foundation of his teachings is contained in the Four Noble Truths concerning suffering, and the Noble Eight-Fold Path that leads to freedom from suffering. Other discourses and teachings of Buddha are merely an elaboration and a commentary on these.

To understand Buddha's viewpoint, we must recognize that along with the gods and demons of the Brahmans he had also been indoctrinated with the conception that the world of the senses is but an illusion, called *maya*. He held, then, that men are subject to pain and evil because they are dominated by the senses, by passions, and by selfish desires. And he taught that it is possible for man to transmute his interests from selfishness and carnal motives to the plane of pure intellect and spirit, and thus freed from the bonds of the senses to enter into the kingdom of Nirvana.

The view of many Buddhists, that life on earth is not worth while, that it is a painful experience to be avoided if possible, is the view quite generally held in India and not original with Buddha. He did, however, concretely formulate a related thought in his Four Noble Truths somewhat thus:

1. Birth and death are grief.
2. This grief of existence is caused by desire.
3. It ends when desire ends.
4. Desire may be extinguished by following the Noble Eight-Fold Path.

The Noble Eight-Fold Path by which Nirvana is gained is as follows:

1. Right Views (free from superstition or delusion).
2. Right Aims (worthy of intelligent man).
3. Right Speech (kindly, open, truthful).
4. Right Conduct (peaceful, honest, pure).
5. Right Livelihood (bringing hurt and danger to no living thing).
6. Right Effort (self-control).
7. Right Mindfulness (the active watchful mind)
- 8 Right Contemplation (on the deep mysteries of life).

Thus did Buddha teach that all the miseries and discontent of life are due to selfishness, that suffering is due to individual craving and greedy desire. These cravings are of three kinds; the craving to gratify the senses, the desire for personal immortality, and the desire for prosperity.

To attain Nirvana all these cravings must be overcome, there must be detachment from them, and the extinction of all personal aims. One must completely forget Self. He apparently accepted along with the opinion of his times certain ideas regarding karma, but he repeatedly condemned the prevalent belief in reincarnation. In fact, in one of the early well-known dialogues there is a destructive analysis of the belief in or desire for an enduring individual soul. Having tried it fruitlessly himself, his doctrines are firmly opposed to any form of asceticism, holding that it is merely an attempt to win personal power by personal pain. To sum the matter up in a single clause, Buddha taught Salvation from Oneself.

Buddha preached a very simple doctrine, and lived a very simple life; but his followers—as did the followers of both Jesus and Mohammed—immediately after his death began to weave a network of legend about his life. And because he took no pains to accept or deny most of the forms of worship by which he was surrounded, these began to creep into Buddhism as an integral part of it even as the pomp and ritual of pagan Rome infiltrated Christianity and became an integral part of the Christian religion. Nor is it confined to the church before the Martin Luther reformation; for nowhere in the Bible can be found sanction for Santa Claus, a Christmas tree, or eggs and rabbits at Easter.

Buddha did, however, deny the pernicious human reincarnation supported doctrine of caste. This took courage. “As the four streams that flow into the Ganges lose their names as soon as they mingle their waters in the holy river, so all who believe in Buddha cease to be Brahmans, Kahatriyas, Vaisyas, and Sudras.”

This attitude, of course, brought Buddhism eventually into conflict with the Brahmans, even as politically removing the caste restrictions from the 60 million “untouchables” in 1947 will bring opposition from the Brahmans, who then and now clung tenaciously to the caste system and to the prerogative of acting as the sole teachers of religious ritual and practice, and as the sole officials practicing sacrificial rites. Early Buddhists were not vegetarians, but this later became part of the Buddhist doctrine. They did, however, ignore caste, and needed no sacrificial offerings.

Under the patronage and wise leadership of King Asoka, about the middle of the third century BC, Buddhism spread far beyond India. Eventually it reached China, Japan, Tibet, Burma, Manchuria and Turkestan; being the religion today of a large following in these countries.

But in India, due to its denial of the caste system, it became the target of relentless persecution by the Brahmans. Eventually they were successful in driving it from India, and even while it remained there the early converts from Hinduism were successful in introducing into it much of the Brahmanic ideas and rituals.

Buddha taught a simple doctrine and simplicity of living. But the Buddhist church in India and elsewhere at a very early date began to adopt customs, rituals, and metaphysics from a wide variety of sources. The simple huts in which Buddha and his disciples lived gave place to pretentious monasteries, and later still there were temples. In fact, the practices and worldly show that Buddha held most in contempt

came to dominate the Buddhist church, and following the old Brahmanic doctrine of avatars, Gautama was proclaimed as one of the numerous incarnations of the superhuman Buddha.

To indicate how far Buddhism of today in most countries is from the simple and spiritual doctrines taught by Buddha I can do no better than quote two paragraphs from *The Outline of History*, by H. G. Wells:

“Tibet today is a Buddhist country, yet Gautama, could he return to earth, might go from end to end of Tibet seeking his own teaching in vain. He would find that most ancient type of human ruler, a god king, enthroned, the Dalai Lama, the ‘Living Buddha.’ At Lhasa he would find a huge temple filled with priests, abbots, lamas—he whose only buildings were huts and who made no priests—and above a high altar he would behold a huge golden idol, which he would learn was called ‘Gautama Buddha.’ He would hear services intoned before this divinity, and certain precepts, which would be dimly familiar to him, murmured as responses. Bells, incense, prostrations, would play their part in these amazing proceedings. At one point in the service a bell would be rung and a mirror lifted up, while the whole congregation, in an access of reverence, bowed low.

“About this Buddhist countryside he would discover a number of curious little mechanisms, little wind-wheels and water wheels spinning, on which brief prayers were inscribed. Every time these things spin, he would learn, it counts as a prayer. ‘To whom?’ he would ask. Moreover there would be a number of flagstaves in the land carrying beautiful flags, silk flags which bore the perplexing inscription, ‘Om Mani padme hum,’ ‘the jewel in the lotus.’ Whenever the flag flaps he would learn, it was a prayer also, very beneficial to the gentleman who paid for the flag and to the land generally. Gangs of workmen, employed by pious persons, would be going about the country cutting this precious formula on cliff and stone. And this, he would realize at last, was what the world had made of his religion! Beneath this gaudy glitter was buried the Aryan Way to serenity of soul.”

In Buddhism today—which with about 140 million adherents has the fifth largest following of any religion, although the total who believe in Animism is about the same number—there are about as many sects as there are in Christianity. One of the early divisions was the breaking away from the old faith about 200 BC of the School of the Great Vehicle. This school adopted the idea that Buddha was a superhuman, and promulgated the doctrine of avatars, and taught that Buddha’s mother was a virgin—as a few hundred years later it was taught that the mother of Jesus was a virgin—that his birth was accompanied by flowers falling from heaven, and that at his death the earth quaked—as a few hundred years later it was believed that there were earthquakes when Jesus was crucified.

The Church of the Little Vehicle and the Church of the Great Vehicle are somewhat analogous to the Greek Church and the Roman Church of Catholic Christianity. The primitive church had three articles of faith that its members confessed: “I believe in

Buddha as a sure guide; in the law of Buddha (Dharma); and in the Church (Sangha).”

About 200 BC Buddhism found its way to China, and eventually through Korea to Japan. We find in China alternating periods in which Buddhism flourished, and then, due to new political regimes, was suppressed by persecutions. It influenced Taoism, as for instance when in the fourth century it adopted the doctrine of future punishment. But even to a greater extent Taoism and Confucianism influenced Buddhism as found in China.

As early as 583 AD an image of Buddha was sent to Japan from Korea, and in 593 AD Prince Shotoku Taishi learned from a Korean priest the Buddhist moral code; not to lie, not to steal, not to get drunk, not to commit adultery, and not to kill. This prince, who was virtually the ruler of the country, used all his power in behalf of Buddhism. He built 46 Buddhist temples, erected many Buddhist images, and housed 1,385 Buddhist monks and nuns.

The Buddhist priests taught the barbaric Japanese that the Sun-deity that they worshiped was none other than the Buddha who was worshiped under the name of the Sun of Righteousness. The Japanese before this had largely been converted by the Koreans to ancestor worship, but the Buddhists discouraged this. They encouraged cremation instead of burial, advised that sacrifices be confined to vegetables rather than embrace slaughtered animals, identified the various Buddhistic gods with those of Shintoism, taught their moral code, introduced their figures, saints and incarnations. They effectively took over and transmuted the Shintoism and the Taoism and the Confucianism that had by this time permeated it, so that it all came to conform with the Buddhist doctrine. Thus from 673 to 686 Emperor Temmu made the Buddhist ceremony obligatory in every home and strictly prohibited the eating of meat.

Space does not permit going into the details of the belief of each Buddhist sect. Some of these sects have much in common with Christianity. Among most of them there has been much tolerance of the gods of their neighbors. And in many instances the gods and customs of their neighbors have been incorporated into Buddhism.

The Weakness of Buddhism

—From the viewpoint of The Religion of the Stars the basic premise of Buddhism and some other Oriental doctrines— that life is not worth while and should be escaped as early as possible, or that it is chiefly grief to be avoided—is erroneous. The urge behind life is to attain significance, more and more significance, through developing more and more ability, and thus instead of seeking either oblivion or some static condition in which effort is no longer necessary, the individual should seek to co-operate with other constructive intelligences in building a worthwhile civilization, and a worthwhile universe in which to live and function as a Self-Conscious Immortal soul.

As explained in Course XIX, to develop the qualities necessary to become a cooperative and valuable workman in the realization of God's Evolutionary Plan, the soul must undergo experiences. Only through learning to overcome difficulties can it acquire ability. Only through experience can consciousness be widened. And self-conscious immortality is possible only as the fruition of some such struggle with environment as that which man undergoes in physical life. Human life, therefore, instead of being a curse, as Orientals frequently imagine, is the doorway to better things, is, in fact, the one known doorway through which man attains the highest imaginable good.

Furthermore, now that the very initiative and enterprise that so systematically have been suppressed in India have improved living conditions in the West, the majority of Western people, I believe, enjoy living. That is, they glory in the struggle to accomplish something; and the pleasure of living more than compensates for its hardships. And the more people view life as a glorious opportunity, as something to be thankful for, and as something to make the best of, the happier they become, and the more they accomplish.

If we hate and despise the work we do, in this case life itself not only does the work cause us grief, but by our discordant attitude we build inharmonies into our thought-cells that cause them to use their psychokinetic power to bring misfortune into our lives. Furthermore, as explained in lesson No. 59, all action and accomplishment is due to the release of energy which while under tension is called desire. If we kill out desire, we kill out all power of accomplishment. Instead of killing out desire, we should recondition it so that it will give us the power to get what we want. And we should want, as all life does, greater satisfaction for the drive for significance, the drive for nutrition and the drive for reproduction. Instead of relinquishing life and effort, we should strive to realize these three drives not only on earth, but progressively after life on earth is done by assisting in the work of evolution, assisting in it by CONTRIBUTING OUR UTMOST TO UNIVERSAL WELFARE.

The Means Orthodoxy Has Employed to Enslave the People of the East

—As far back as there are records certain individuals have sought power and special privileges through being the interpreters of the will of Deity. In the West the priestly group cunningly created an imaginary heaven and an imaginary hell, and formulated other beliefs and usages to their own advantage. They made people believe that anyone who used facts and reason to reach conclusions about religious matters would be tortured, not for just a brief period, but everlastingly in hell. But those who confessed to the beliefs held by the priesthood would forever be happy in the imaginary heaven the priests had created.

Thus in the West the people were kept behind an iron curtain of ignorance relative to all inner-plane matters (see lesson No. 125), and held by orthodoxy in complete mental slavery.

More is said about this in lesson No. 138, but it is brought to attention here to show both the contrast and the similarity between the methods used by the priests of the East and the priests of the West to attain the same end; the end of retaining authority and material advantages not possessed by most. In the West much freedom of action is permitted; but there is slavery of thought. In the East, on the other hand, there is the utmost freedom of thought, but iron-clad slavery of action.

The soul in its Cycle of Necessity, through the experiences it acquires in one form, is able after the death of this body psychokinetically to attach itself to the fertilized seed of another and more complex form and live in it during its life. But the steps, as explained in Course 19, *Organic Alchemy*, are always progressive, always toward forms higher in the scale of evolution. And when the form of man is reached, the universe in miniature, the soul's evolution requires that it shall not return to occupy any other life-form on earth, but shall continue its development and progress in the high-velocity inner-plane regions.

This evolution of the soul through progressive forms was recognized by the initiates of each of the ancient centers of civilization. And the conception was brought to India by the early Aryan invaders, and may have been in India before they came. But to keep their position secure, they gave it an inversive twist. To keep the people servile they remodeled it into the doctrine of karma and human reincarnation.

The Brahman caste not only retained the position of highest social importance and influence, but it held to itself the prerogative of teaching others precisely how they must behave, and the prerogative of performing the rituals. But it did not attempt to stifle thought. Nowhere has there been greater liberty in thinking than in India. It has been the general custom there to permit people to think as they please, so long as they do not depart in the slightest degree from the actions which eons ago were established by the Brahmans, the priestly caste.

Mentally, the individual is free. But in his actions he is bound as in a vice, and hedged around by a multitude of useless observances. Should he neglect any one of these he loses caste, which is not merely a forfeiture of previous associations, but may mean starvation.

To enforce the rules they had made, and to maintain themselves in opulence and power, the old-time Aryan priests taught the transmigration of the soul. They taught the people that being born into the highly favored Brahman caste was the reward of good karma. These priests had been born into the favored position as a just reward for living exceptionally holy lives in lower castes. Those undergoing the hardships and suffering common to low castes, if they endured their lot with fortitude, and lived holy lives, might look forward, not to heaven, as in western lands, but in time to being born Brahmans. But if they transgressed the moral precepts laid down by the priests, they might look forward to being born in the next life as some loathsome animal.

However, the priests, the Brahman caste, were not strict and specific that the next birth of the evil doer would be in some creature lower than man. All they insisted on was that the person who made good karma would have a better time in the next life, and the one who made bad karma would suffer in the next life. And to make good karma the individual could think as he pleased, but he must behave according to the orthodox precepts laid down by the Brahmans.

As the Brahmans permitted freedom of belief, one after another they tended to absorb all the multitude of sects that developed in India. The moral code of Hinduism is that the evil received in this life is due to evil done others in a past life. Therefore, it behooves one to act kindly and justly—provided rules of action laid down by the Brahmans are not overstepped in such benevolent conduct—in this life, making good karma, that one may be born to a happier lot in the next physical incarnation.

While some of the higher philosophies of India teach that deliverance may be attained through a mystical union with Brahma (deity), that is, through attaining divine consciousness, and some teach that the wheel of rebirth may be escaped and nirvana attained by one who continues to live one holy life after another, and others teach various exalted ideas, the Brahmans are content with any philosophy that embraces karma and human reincarnation; for mostly transmigration into the bodies of animals has now been replaced by the doctrine of repeated births in human form. And the Brahmans, retaining as much as possible the privilege of being the teacher caste, see to it that each and every philosophy embraces this orthodox tenet.

As the orthodoxies of the West hold their followers in slavery by fear of hell and the promise of heaven, so the orthodoxies of the East hold their followers in slavery by fear of being born in future lives to greater suffering, and by the promise of being born to opulence and happiness in lives yet to come. The only real difference in the cunning and deceptive psychology used, is that in the West the punishment threatened or the reward promised is to be on the inner plane, while in the East the punishment threatened or the reward promised is to be realized on earth.

Chapter 6

Serial No. 138
Original Copyright 1949
Elbert Benjamine

Copyright
August 2002
Church of Light

Judaism and Christianity

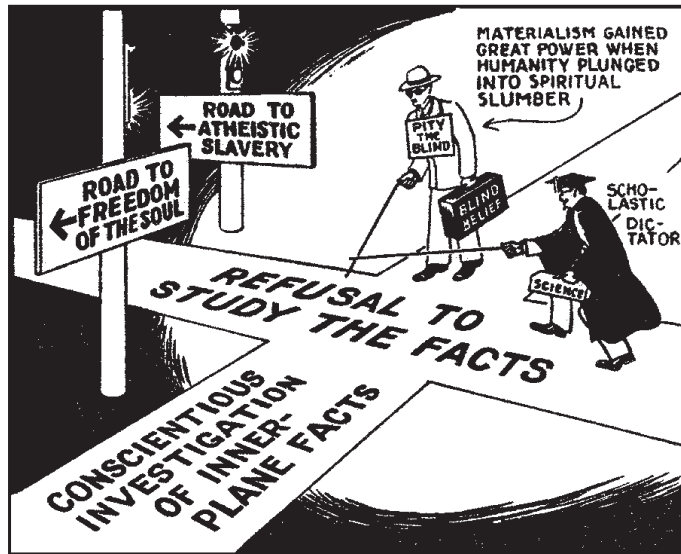

Drawing by Mildred Schuler

Chapter 6

Judaism and Christianity

AT a very early date the Hebrew religion was developing in the northwest corner of Arabia. As told in the Bible, the founders of the Hebrew nation, Abraham, Isaac, and Jacob, lived the typical life of patriarchal Bedouin chiefs. They were nomadic shepherds in the country between Babylon and Egypt. Canaan, later called Palestine, was at that time inhabited by another Semitic people, called the Canaanites. The country is about one-fourth the size of Pennsylvania.

Before the Hebrews contacted the higher culture of Babylon to the north or Egypt to the west, they were no doubt at the stage of heliolithic religion. Gen. 28 :18—"And Jacob rose up early in the morning, and took the stone that he had put for his pillows, and set it up for a pillar, and poured oil upon the top of it." Gen. 28 :22—"And this stone, which I have set for a pillar, shall be God's house: and of all that thou shalt give me I will surely give the tenth unto thee."

Before the Hebrews finally attempted to conquer Canaan, it had been invaded by the dark-white Ibereans from Italy and Greece, who brought with them the old Aegean culture. Such were the Philistines, with whom the Hebrews waged long warfare. Pressing Palestine from the far north were extensions of the Aryan-speaking Hittite Empire. Closer, to the north along the seaboard, were the sea-faring commercial Phoenecians, another Semitic people.

Through Palestine was the natural trade route, and also the war route, between the Hittites, Syrians, Assyrians, and Babylonians to the north and east, and the Egyptians to the south. And in the time of Solomon, Hiram, a Phoenecian trader-king, opened a trade route across Palestine linking the Mediterranean and the Orient by way of the Red Sea. All of these nations had some influence upon the religious views of the Hebrews.

If we are to credit the Bible narrative—there is no Egyptian record of the career of Moses, of the plagues of Egypt, or any Pharaoh drowned in the Red Sea—the Hebrews were slaves in Egypt for some time. The Bible gives an account of their forty years of wandering in the desert country after leaving Egypt before they successfully invaded Canaan. Later, Israel was overcome and at least ten of its tribes were lost to history and one was absorbed by its conquerors. The remaining tribe of

Judah, in 578 BC, except for a few common people, was taken captive into Babylon and held there until Cyrus of Persia overthrew the last Chaldean ruler in 539 BC.

During this captivity their hitherto divergent and bickering groups became welded by national consciousness into a common aim and toward a common destiny. They went to Babylon a barbaric people, as the Bible plainly shows, probably at the heliolithic level. But they came out of captivity a nation. This, perhaps, was not entirely due to what they had appropriated from the Babylonians, for they held stubbornly to certain ideas of their own. But they had both time and energy that need not be consumed in politics and warfare; and residing, as they did, in the seat of the world's highest culture at that period, they had opportunity to adopt ideas from others, to develop ideas of their own, and to climb well above the level of heliolithic religion.

There may have been secret records in their possession before the captivity, but they certainly had no commonly recognized literature. Yet at the end of the Babylonian captivity the Pentateuch was in existence as a sacred book, and other books of the Bible were extant as separate histories. From the Babylonians they had appropriated the two interlaced trines—which with the name of Deity in the center and astrological symbols around the outside was the emblem of The Religion of the Stars—and later called it Solomon's Seal, or the Star of David. And the square formed letters of the alphabet which they use, along with this symbol, also were appropriated from the Babylonians.

The two interlaced trines were used by the initiates of the older centers of civilization to signify, among other things, the involution and evolution of the soul through the Cycle of Necessity. The down-pointing trine, which often was dark in color, indicated the descent of the soul into material conditions for the purpose of gaining necessary experience. The up-pointing trine, which often was light in color, indicated the ascent, or evolution of the soul, back to the realm of spirit after gaining experience in matter.

The descendants of the tribe of Judah had, and still have, a perfect right to use this symbol which had been handed down from times far more ancient than that of their Babylonian captivity. But they have no exclusive claim on it merely because they appropriated it; no more than they have an exclusive claim on the money of the world because they have succeeded in various areas in appropriating it.

Two other religions also use it, and with equal right. These interlaced trines were used in ancient India; and today the Theosophical Society, with headquarters at Adyar, Madras, India, uses it as their symbol. As they use it, in the center is the phallic symbol—the symbol of life—around the outside is the serpent of wisdom, and at the top is a swastika in a small circle. Above this circle are some Sanskrit characters. Because the Theosophists use this so-called Star of David as part of the symbol indicating their philosophy and aspirations does not mean they took it from the Jews. India had it long before the Jews used it.

The Religion of the Stars also uses this so-called Solomon's Seal as part of the symbolism expressing its philosophy and the aspirations of Stellarians. Inside the interlaced trines, however, is the word of Deity, Jod-He-Vau-He, written in the square formed Chaldean letters, letters which were in use before the Jews started using them. Thus written, it not only signifies the belief that there is a Super-Intelligence Who interpenetrates and exercises a guiding power over, the whole universe, but sets forth the four universal principles through which this Super-Intelligence, instead of being moved by whim or prejudice, always operates. The joined sun and moon at the top of the symbol indicate that spirituality may best be reached, and still further evolution in spiritual realms accomplished, through the marriage of a male and a female soul. The seven stars and the astrological symbols around the outside of the interlaced trines indicate the belief that astrological energies powerfully influence all life, and that a knowledge of them will enable the aspirant to avoid many misfortunes he otherwise would encounter, and permit him to best advantage to develop his talents and so conduct his life that he can most successfully advance his own spirituality and at the same time contribute his utmost to universal welfare.

After the Babylonian captivity other works, such as the Songs of Solomon, the Psalms, Proverbs, etc., came into existence from time to time, and at last it became necessary to decide how much of this literature should be considered sacred. Not all that made claim to sacredness was retained. The Old Testament, venerated by both Christian and Jew, is a group of such books as most strongly impressed the priesthood as being of value and less self-contradictory in character than other similar books which they discarded.

One unique feature of the Hebrew religion is the stubbornness with which its devotees cling to the worship of Jehovah. Another unique feature is the exceedingly personal relation between Jehovah and his worshipers. He walks in the garden and converses with Adam, speaks directly with some of the prophets, who even see his face, and intervenes frequently in the affairs of his chosen people.

He is at first represented as a tribal god, early considered the most powerful god, next considered as a god above all other gods, then as the only true god, and finally with his evolution completed, as the god of the whole world. The Jews considered that Jehovah had promised to make the Jewish race the dominant people on earth, that they were the chosen people of the one God, and that to accomplish this a Messiah would arise.

Familiar as the Bible is to nearly everyone, I shall not detail its teachings. In it, as in other sacred books, may be found many astrological references and in its symbolism a complete exposition of the Ancient Secret Doctrine. But here we are concerned with its prevalent interpretation. To be sure, instances of divination are mentioned, and instances in which lying spirits deceive, and mediumship between the living and the dead, such as that of the so-called witch of Endor, to be mentioned later.

But as the story of the Bible develops we are struck by the influence of certain men who possessed extrasensory perception in considerable degree, and some of whom were able also to employ psychokinesis to perform greater feats of magic than the magicians pitted against them. These prophets, rather than being scientists, such as were some of the Babylonian priests, depended upon extrasensory perception implicitly. They thus became the avenues through whom Jehovah spoke to his chosen people, even as later Zoroaster became the avenue through whom Mazda spoke to the Persians.

These prophets demanded that the people should accept without question that which they claimed Jehovah said to them. Jehovah laid down laws for the guidance of human conduct, and the Hebrew religion is based on implicit obedience to such laws instituted by Jehovah in personal interviews with the prophets, and on unwavering devoted worship of him.

These prophets undoubtedly did contact, on the level of their intelligence and vibratory rate, through extrasensory perception, the all-pervading Super-Intelligence of the universe. But the scope of their contact was limited by their own mental conceptions, and what they did contact, of necessity, when it reached objective consciousness was limited and slanted by their intelligence and preconceptions. But the most significant thing about the Hebrew religion—now the Jewish religion—is not that it convinced the Jewish people that they would in Jehovah's appointed time rule the earth; but that it brought into such prominence the institution of prophecy. It thus paved the way for Jesus, for Mohammed, and for numerous lesser prophets, who from time to time, similar to Joseph Smith, the founder of the Church of Jesus Christ of the Latter Day Saints, became leaders of religious movements.

Early Christianity

—We will by-pass scholastic criticism which, having made historical research, claims there is no authentic record that such a person as Jesus ever lived. Instead of entering this controversy we will consider the Bible account as the valid basis on which early Christianity rests, and consider Jesus as one of the great religious teachers of the world.

He lived at a time when it was common to follow the Hero Cult practice of making a god of any highly endowed individual. Some of the pharaohs of Egypt were considered divine beings, some of the emperors of Rome were by their subjects considered gods. Up to the end of World War II the emperor of Japan was considered a god. And even today the Roman Catholic Pope is considered to be God's representative on earth, whose pronouncements must be obeyed as orders given from a divine source, and certain men and women after their death are made saints and prayed to in the effort to get them to intercede with God to bring the asked for boon.

When Jesus said that my father and I are one, he indicated that he had attained divine consciousness; had entered into rapport with the Super-Intelligence which guides the destiny of the universe. When any person attains this consciousness, quoting from lesson No. 53, “He becomes conscious of Divine Intention. and clearly perceives his own function in the Divine Plan, and just what he can do at any time to further cosmic construction.”

This is a very different thing than being the boss of the millions of galaxies, of which our earth is but a speck revolving about one of the hundreds of millions of stars embraced in each galaxy. Yet when Jesus is referred to as the Son of God that is quite correct; for the potential spark, or ego, which actuates and gives each soul its drive for significance is an emanation, or child, of Deity.

At the time Christianity began, God in various regions was worshiped as a Holy Trinity. In India, for instance, there was Brahma, Vishnu and Siva. In Egypt, Osiris the Father, Isis the Mother, and Horus the Issue, were popularly worshiped; and in addition there was a fourth deity which included the three others, and overshadowed them, as do the thoughts of a family, called the Holy Ghost.

Just what were, and just what were not, Christian doctrines was a matter of violent controversy during the first three hundred years of Christianity’s existence. Furthermore, the Christians were hated and persecuted. Diocletian in the latter part of his reign was induced by his colleague, Galerius, to sanction a particularly determined and sanguinary persecution of them.

Diocletian was proclaimed Emperor of Rome by the army in 284 AD, but because of the dangers threatening Rome was compelled to share the government with M. Aurelius Valerius Maximian. In 292 AD, Gaius Galerius and Constantinus Chlorus were also raised to share the empire, which thus became divided into four parts. As a result of the reconstruction they accomplished the barbarians were driven back on all frontiers and once again Roman power extended from Britain to Egypt.

The one later to be called Constantine the Great was the son of Emperor Constantinus Chlorus and his wife Helena. While Constantine’s father was associated in the government with Diocletian, the son was held at the court as a hostage. But after Diocletian and Maximian resigned, to escape the machinations of Galerius, Constantine escaped and went to his father who was in Britain. After his father died the soldiers chose him emperor in 306, and he took possession of the countries ruled by his father.

After defeating the Franks he directed his armies against Maxentius, who had joined Maximian against him. This required a campaign in Italy. During this campaign it is reported that he saw a flaming cross in heaven, beneath the sun, bearing the inscription, “In hoc signo vinces.” (By this sign thou shalt conquer). And that the following night Christ appeared to him and commanded him to take for his standard an imitation of the fiery cross he had seen. Therefore, he had a standard made in this shape, which was called labarium. Not many days after this, on Oct. 27, 312, he defeated the army of Maxentius under the walls of Rome, drove it into the Tiber,

entered the city in triumph, and liberated the political prisoners. He was proclaimed by the senate, chief, Augustus, and pontifex maximus.

In cooperation with Licinius, in the year 313, he published an edict of toleration, not only favoring the previously persecuted Christians, but permitting any person to embrace the religion of his choice. Thus for a very short time was there freedom of religion.

But Licinius, jealous of Constantine who had married his daughter, soon resumed persecuting the Christians. Their armies met in battle in Pannonia in 314. Not only was it a battle of armies, but a battle of psychokinetic power; for Constantine was surrounded by bishops and priests, who prayed for his victory, while Licinius was surrounded by soothsayers and magicians who called upon their gods to make him victorious. Constantine was victorious, but in later years Licinius was again able to gain enough power to renew hostilities. But in this engagement he was not only defeated but was taken prisoner and put to death. Thus in 325 AD Constantine now called the Great, became the sole head of both the Eastern and the Western Roman Empires.

He not only gave the Christians permission to erect churches, but the cost of these churches was met by the government. As had the Greeks and Romans of previous periods, he decided that one of the surest ways of consolidating an empire was to have its people believe in a single religion. Thus Christianity became the state religion of Rome. But if it was to be an instrument to unite the Empire the squabbling over its doctrines must cease. Therefore, in the year 325 AD he called what is known as the Council of Nice. He attended it in person to see to it that there should be an end of its schisms.

Nice, or Nicaea, as it was then called, was a city of Bithynia, in Asia Minor, on the east shore of Lake Ascania. It had been called Ancore, also Helicore, but Lysimachus, having conquered this part of Asia, changed its name to Nicaea, in honor of his wife who had that name. It was here that Constantine called together some 250 bishops, many of whom came from the East, along with numerous presbyters, deacons and other church dignitaries from all parts of the world. While other matters were decided, such as which books should be embraced in the Bible and which should be discarded, the chief controversy was over the so-called Arian heresy.

Alexandria for over six centuries had been the great seat of learning of the world. At Alexandria resided Arius, a Christian Presbyter. Earlier, Sabellius had held that there was only one god, as against the view that in the Godhead there are three distinct persons. But in 317 AD Alexander, Bishop of Alexandria, had publicly expressed the view that the Son of God is not only of the same dignity as the Father, but of the same essence. Arius did not agree either with Sabellius or Alexander, but declared that the Son of God was only the first and noblest of created beings, and though the universe had been brought into existence through his instrumentality by the Eternal Father, yet the Son was inferior to that Father, not merely in dignity, but also in essence.

Some of the Christians of that day held with Alexander and some held with Arius. The conflict threatened to cause the whole Christian world to take sides and engage in violent conflict. And this would bring disruption within Constantine's empire.

Having failed to bring peace by private means, Constantine called the Council of Nice. At that council, at which all church tenets were decided, was Bishop Athanasius who came from Alexandria, Egypt, particularly to help settle this matter of the orthodox trinity. It was he who insisted upon the Holy Ghost. Most contemporaneous nations, other than the Egyptians, held merely to the Trinity of Father, Mother and Issue. But the Holy Ghost came to Christianity at an opportune time; for due to the teachings of Paul, and the fanatic asceticism that was developing, it was becoming quite certain that woman could have no part in anything divine. The monks who retired to monastic life looked upon woman as an instrument of evil, a tempting agent of the devil strictly to be avoided. They characteristically shifted the blame for all the ills of humanity to her shoulders by teaching that the fall of Adam was due to the guile of Eve.

At the Council of Nice Athanasius, with his doctrine of Father, Son and Holy Ghost prevailed. The Council voted that Christ was of the same essence as the Father, and Arius was deposed and exiled.

Jesus Had Extraordinary Extrasensory Ability and Psychokinetic Power

—Jesus in an amazing degree was able to use extrasensory perception. With it he contacted the all-pervading Super-Intelligence of the universe on a high level. And apparently he was able to get information telepathically: St. Luke 22 :47-48—"And while he yet spake, behold a multitude, and he that was called Judas, one of the twelve, went before them, and drew near unto Jesus to kiss him. But Jesus said unto him, Judas, betrayest thou the Son of man with a kiss?"

He also used extrasensory perception in what is now called precognition, as indicated by this incident involving Peter: St. Luke 22 :33-31—"And he [Peter] said unto him, Lord, I am ready to go with thee, both into prison, and to death. And he [Jesus] said, I tell thee Peter, the cock shall not crow this day, before that thou shalt thrice deny that thou knowest me.

He not only had psychokinetic power in an amazing degree, using it to heal the sick, to feed the multitude, to walk on water, and to get a coin with which to pay taxes, but his disciples also employed psychokinesis. St. Luke 9:1-2—"Then he called his twelve disciples together, and gave them power and authority over all devils, and to cure diseases. And he sent them to preach the kingdom of God, and to heal the sick."

At the time Jesus lived there was almost no scientific knowledge, little was known about nature, and the people to whom he talked were quite illiterate. He had to speak

to them in terms they understood, telling them stories (parables) to illustrate his points.

He lived at a time when materialism and greed for material possessions were dominant, and when gross brutality stalked the earth. The tooth for a tooth, eye for an eye doctrine, and the belief in a cruel god, were orthodox tenets of his day. He was a great world teacher not because the religion which was derived from his life and teachings is the most powerful one on earth today, but because he brought three messages, which are as valid now as then, with which to combat the orthodoxies of his time. Each assists man to realize his drive for nutrition, his drive for reproduction, and his drive for significance.

1. Instead of a god of vengeance, he gave to the world the conception that the Heavenly Father desires the welfare of all creatures, even the sparrow.

2. Instead of the greed and ruthlessness which is still the great plague of the world, he taught that people should do unto others as they would be done by, and that they should treat their neighbors as themselves. And if people would thus be as helpful and sympathetic toward others as they would like others to be toward them, the ensuing co-operation would lead by way of specialization of parts and division of labor to freedom from want, freedom from fear, freedom of expression and freedom of religion.

3. He not only taught, but he demonstrated in a manner that the world has not been able to forget, that the personality survives the tomb and lives after physical dissolution on the inner plane. He said that in his Father's house were many mansions, implying that there was room for all to continue their lives and progress there.

Some of the things he taught which were sound enough in his day are not sound now; and some of them, if they are given the literal interpretation that is common from present-day pulpits, are decidedly erroneous. It may have been well enough in his day to sell all one had and give to the poor and then spend the life in disseminating his teachings, but it would not work today. To wander about the country completely broke is not the present-day efficient way to get a religious message to the public. At least, various ministers of The Religion of the Stars have found it more effective to have some income, and to use that income for a living while donating their time and energy to spreading the Stellarian religion.

It is quite proper for those where a missionary teacher or a minister of The Religion of the Stars goes to donate sufficient for his expenses. But there are many places where the teachings are needed that could not be induced to give sufficient donations for the one disseminating the religion to live on. Therefore, only if the missionary or minister has some independent income, or those in another region will foot his living expenses while he is teaching or lecturing in such a needy place, can the teachings be carried there.

Jesus did not try to destroy the Jewish religion, he merely added certain teachings that importantly, and for the better, modified it. Christianity still retains the Bible of the Jews, but accepts also the teachings of Jesus and of Paul.

The doctrines propounded by Jesus: return good for evil, love your enemies, and do good to those who spitefully use you, profoundly modified the older Jewish doctrine of an eye for an eye and a tooth for a tooth. But the doctrines of Jesus shortly underwent important modifications at the hands of Paul.

Paul taught—I Corinthians, 12—that woman should look up to man even as man should look up to Christ, that a man should pray with his head uncovered, but that it dishonored a woman to pray with her head uncovered, and that woman was created for man, but that man was not created for woman. He also taught, I Corinthians, 14—that woman should be obedient and should keep silent, and if she wished to know anything she should ask her husband at home, for “it is a shame for woman to speak in the church.” And Ephesians 5:22-23—“Wives submit yourselves unto your own husbands, as unto the Lord. For the husband is the head of the wife, even as Christ is head of the church; and he is the savior of the body.”

As the old Hero Cult still had such a powerful grip on the people, it was to be expected that any extraordinary person would be considered a god. And it was the custom to weave legends about gods and heroes that corresponded to astrological positions. Thus was there incorporated into the Christian religion a large variety of customs that had been part of the astrological religion practiced in Chaldea and Egypt. These had been adopted in Greece, and by Christian times in Rome. No one made any enquiry as to the date of birth of Jesus until 580 years after the approximate year he was born.

Mithraism had become the dominant religion in Rome about 60 BC. And Mithra, god of light, was, according to this religion, born in a cave on Christmas day. Mithraism not only celebrated Christmas as the day on which its god was born, but just before the Christian era haoma, the alcoholic drink of the early Aryan Persians and some of the Aryan invaders of India, had been abandoned in favor of partaking of wine and cakes at the ceremonies sacred to Mithra. Therefore, when Paul advised that this ceremony should be adopted by the early Christian churches, he but appropriated a ceremony that was already customary among the Roman people.

With the adoption of Christianity by Constantine as the state religion of Rome, a great many other modifications were made. The pomp and show and rituals, chants, incense, figures of saints, and other church accessories and ceremonies were, from motives of expediency—to gain a following and secure for the priests a position of influence and power through making the masses dependent upon them for entertainment and for everything pertaining to religion—adopted directly from the customs and ritualistic ceremonies as conducted by the priesthood of the Roman Empire previous to the advent of Christianity.

The Church also set the day celebrated in honor of John the Baptist and the day celebrated in honor of John the evangelist, according to the old Religion of the Stars.

And Christianity has, one after another, adopted a dozen other days and usages of the old Religion of the Stars. These are explained in the reference book, *Astrological Lore of All Ages*. No doubt if Jesus came to earth today he would marvel at church customs.

Modern Christianity

—We should appraise any religion, including modern Christianity, as to its true value by the extent to which its teachings increase the ability of man while on earth, and after earthly life is done, to attain in their extended sense, satisfaction for the drive for nutrition, the drive for reproduction, and the drive for significance.

Let us first consider the teachings of the Old Testament which largely revolve around the Ten Commandments. Deuteronomy 5:

“Thou shalt not make thee any graven image, or any likeness of any thing that is in the heaven above, or that is in the earth beneath, or that is in the water under the earth:

“Thou shalt not bow thyself down to them, nor serve them; for I the Lord thy God am a jealous God, visiting the iniquity of the fathers upon the children unto the third and fourth generation of them that hate me.”

Here we have the Old Testament deity injected into modern life; a deity with the attributes of fierce jealousy, and given to revenge. Not merely given to revenge upon those who transgress his arbitrary commandments, but extending that revenge to innocent children, and their children. Furthermore, if we are to interpret this commandment literally, all statues, all carvings, being graven images, are sinful. If we interpret it more liberally to mean only such images as are bowed down before, the cross, the Virgin Mary, and the images of the saints, before which some bow down, are still transgressions of this commandment.

We no longer thresh grain by beating it with a flail, we no longer use a crooked stick for a plow, we no longer use the ox or the donkey with which to plow, nor do we commonly go to the city well with an earthen vessel to get the necessary supply of household water. Why, then, should we permit orthodoxy to cause us to fear an invisible and all-powerful monster which was conjured up by the imagination of priests in the primitive days when the mentioned outmoded methods were used?

“But the seventh day is the sabbath of the Lord thy God: in it thou shalt not do any work, thou, nor thy son, nor thy daughter, nor thy manservant, nor thy maidservant, nor thine ox, nor thine ass, nor any of thy cattle, nor thy stranger that is within thy gates; that thy manservant and thy maidservant may rest as well as thou.”

Today the observance of this command would mean no electric lights on Sabbath evening, no street cars running on the Sabbath, and a great loss to our larger industries where fires must be kept burning that men may again work after their day of rest, and the flooding of many mines with water which must keep their pumps

going continuously if they are to be maintained in working condition. Happily this command is no longer taken seriously by most people.

Even the command, "Thou shalt not kill," needs to be interpreted according to the concept of universal welfare. Human slaughter is abhorrent. But it is less abhorrent than permitting some brutal and ruthless totalitarian regime to conquer the world and impose on it physical, intellectual and moral slavery.

The commandment, "Thou shalt not steal," should be broadened to include any method of unfairly exploiting, or taking unfair advantage of, another. Legally to acquire a monopoly on some natural resource or public commodity, and thus squeeze the public into paying an exorbitant price for it, is merely a legally unpunishable theft.

The commandment, "Thou shalt not bear false witness against thy neighbor," also needs expansion. It should be interpreted to include such reticence and silence as permits another to form misleading conclusions in matters where more complete information would be advantageous.

But let us now move from the doctrines of the Old Testament which were formulated by a people only recently evolved one step above the old heliolithic religion, to the New Testament, the gist of whose teachings are to be found in The Sermon on the Mount:

"Blessed are the poor in spirit; for theirs is the kingdom of heaven."

"Blessed are the meek; for they shall inherit the earth."

This is a good doctrine only for tyrants who wish to keep people in subjection; for it is certainly destructive to human progress. Initiative and reasonable self-esteem, as well as confidence, are necessary for success in any worthwhile undertaking. The attitude of meekness tends to servitude, and to discourage effort. The progress of society is built upon accomplishment, and accomplishment is thwarted by poorness in spirit and meekness. This doctrine, if adopted, not only would hinder the progress of the race, but it would thwart the drive for significance. It is thus an erroneous religious tenet.

"Blessed are those that mourn; for they shall be comforted."

Sorrow, next to fear, is the most destructive human emotion. Through its effect upon the endocrine glands, it poisons the body, inhibits effort, weakens the mind, and confers no benefit of any nature. Mourning never helped the condition occasioning it. It is one of the most pernicious of mental states, without a redeeming quality, unfitting the individual for constructive work, and building discords into his thought-cells that will cause them to use their psychokinetic power to attract misfortune into his life. As it thus hampers the drive for nutrition and the drive for significance, this also is an erroneous religious doctrine.

"But I say unto you, That ye resist not evil; but whosoever shall smite thee on thy right cheek, turn to him the other also."

Such a doctrine may be practiced by one who has attained so high a spiritual state, and developed so much psychokinetic power, that he can compel others through inner-plane energies to respect his person and his rights. But there are few spiritually and psychokinetically powerful enough to enforce respect for their rights by such means. The fallacy of this doctrine was demonstrated in the persecution and crucifixion of Jesus.

Although taught for nineteen and a half centuries, almost no Christian follows this doctrine. It is highly impractical, and teaching it in church and Sunday school is base hypocrisy. Those who in the past practiced this doctrine perished. Christianity did not persist because this doctrine was practiced, but because those who taught it carried it into various lands throughout the earth with the sword, and often violently crammed it down the throats of those who were less powerful. Had Christian nations practiced this basic Christian doctrine, today there would be no Christian nations, for many centuries ago they would have been vanquished by the warlike Mohammedans, and had they survived until recently they would have succumbed to Hitlerism, to prevent which World War II was fought.

The drive for nutrition expands into the first law of life on the physical plane, the law of survival, which implies resisting evil, resisting destruction. The organism, or group, that during the 1,750 million years life has existed upon the earth, has not protected itself from invasion—resisted evil—has invariably perished and been supplanted by a hardier stock.

The “sucker” who permits another to take his property, even lawfully, does not need to give away his cloak also; for other confidence men, appraising him as an easy mark, quickly relieve him of it.

Humanity should devise means by which war and violence can be avoided; but the history of biology and the history of mankind, show that higher forms of life can survive only so long as they can repel the attacks of lower forms of life. A civilized people can retain its culture, as history has repeatedly proved, only so long as it can, and does, repel the attacks of other people less civilized. Warlike aggression on the part of advanced people is intolerable; but if they are to remain advanced they must possess the ability—preferably through a United Nations military force having the duty of policing the world—to repel warlike aggression from others.

The Means Orthodoxy Has Employed to Enslave the People of the West

—As far back as there are records certain individuals have sought power and special privileges through being the interpreters of the will of Deity. Before there were kings there were priest rulers. Then there were, in Egypt and elsewhere, priest-kings. Later priests and kings divided their power.

To keep their people servile and obedient has been a prime objective of both kings and priests since they came into existence. How to do this was the big problem confronting them.

In the East the priests solved it by the doctrine of reincarnation and karma, in the West they solved it by the doctrine of heaven and hell. Certainly not from anything in the Old Testament, and certainly not from anything Jesus taught, they created a heaven and a hell, a static condition in the after-life in which those who followed the rules the priests laid down, whatever they might be, would reside for all eternity in a land of happiness and bliss; but those who did not live in the manner the priests prescribed—and the priests made the rules so the priests would have both material power and material abundance, even if it brought poverty and misery on their followers—would live for all eternity in the torments of hell.

Both in the Old Testament and in the New Testament are given accounts of those who once lived on earth and returned to converse with those still in physical form. And in each instance they retained their earthly personality, had no wings, and gave no evidence they had come either from heaven or hell. Such conceptions were foreign to those who related these incidents.

Saul consulted a medium, and talked with Samuel who previously had died. I Samuel, 28:14. “And he said unto her, What form is he of? And she said, An old man cometh up; and he is covered with a mantle. And Saul perceived that it was Samuel, and he stooped with his face to the ground, and bowed himself.”

Jesus took with him Peter, and James, and John to a high mountain. St. Mark, 9:4. “And there appeared unto them Elias with Moses: and they were talking with Jesus.”

The orthodox heaven and hell were created by the priesthood in times long past to make the people do just what the priests wished. The priests could lay down any rules they chose, and make people obey them by the promise of a spurious heaven, and the threat of a spurious hell. It was a most cunning device to keep people their slaves. How it hampered scientific progress is set forth in lesson No. 125 and lesson No. 139.

Intelligence was developed by life-forms for use in adapting themselves to the conditions with which they were faced. And man moved higher than other animals because he developed greater intelligence and drew logical conclusions from his observations and experiences. But as such logical conclusions about religion might interfere with priestly authority and privilege, the priests used their cunningly created hell to force people through fear of burning, not for a day or a year, but forever, to relinquish intelligence and logic and rely entirely on belief; the belief which was to save them thus from eternal suffering, of course, being belief in whatever the priests wanted them to think.

It was intelligent and logical to think that even as man's acquisition of knowledge and character on earth are the result of his own individual effort, and that neither knowledge nor ability can be acquired by one person for another, that an individual's

condition in the life to come would be determined by his own initiative and effort while on earth and after he had crossed to the inner plane.

But any such reliance on his own powers would release the individual from intellectual slavery to the priests. If the priests could offer an easy way, a plan of getting something for nothing, to the devotee, it would be more easy for the priests to retain their prestige. The doctrine of vicarious atonement thus appeals to the get-something-for-nothing desire which most people possess. The encouragement of this desire is highly detrimental to the individual; for the universal law of compensation is that the reward of effort is greater ability. Thus to discourage effort, and encourage the individual to believe someone else can atone for his sins, or someone else can without adequate effort on his own part, procure for him in the life to come a satisfactory environment, is highly pernicious.

The only things people can take into the next life are the knowledge they have acquired, the thought-cell organization of their finer form, the ability they have developed, and the dominant vibratory rate which determines their spirituality and the level to which they are attracted, this level having a similar vibratory rate. And none of these four things, which determine the condition of the individual on the inner plane after life on earth has been finished, can be provided by another. The most that anyone else can do to help the individual in this direction is to furnish guidance through supplying him with outerplane and inner-plane facts.

Therefore, it behooves all persons who wish to assist in the progress of the race, and enable people more fully to find satisfaction in this life and- the next for their expanded drive for nutrition, drive for reproduction and drive for significance, which all life-forms endeavor to find, to do all they can toward correcting the following four widespread erroneous orthodox beliefs:

1. The teaching that reliance should be placed upon blind belief, instead of upon demonstrated facts.
2. The teaching of vicarious atonement, instead of teaching that the individual's progress depends upon his own motives and efforts.
3. The teaching of a static heaven or hell, instead of the teaching that life after death is somewhat parallel to life on earth, and that there is always opportunity for progress.
4. The teaching of a personal and patriarchal God—a glorified and supernatural person of whim and prejudice—instead of an all-pervading intelligence Who works toward the realization of His cosmic plan through undeviating laws.

Chapter 7

Serial No. 139
Original Copyright 1949
Elbert Benjamine

Copyright
August 2002
Church of Light

The Stellarian Religion



Drawing by Mildred Schuler

Chapter 7

The Stellarian Religion

THOSE who adhere to The Religion of the Stars are known as Stellarians. Stellarians endeavor to handle every situation in conformity to, and measure their success in life by, The Church of Light slogan, CONTRIBUTE YOUR UTMOST TO UNIVERSAL WELFARE.

Religion should give instructions in optimum living. Optimum living embraces more than a few hilarious days, a few enjoyable weeks, or a few years of health and material prosperity which are followed by a long period of illness and misery. Optimum living gets the best out of life relative to its entire span. Considering the tremendous accumulation of scientific evidence that life persists after the dissolution of the physical, it must embrace both life on earth and life beyond the tomb.

Man can cope with life successfully, here or hereafter, only to the extent he has knowledge of the forces influencing him. While on earth his thoughts, behavior and the events which enter his life, are influenced about equally by his physical environment and his inner-plane environment. It is because, as fast as they are discovered and properly verified, each new significant outer-plane fact and each new significant inner-plane fact is added to it in its proper relation to all facts already known, that The Religion of the Stars will become the world religion of the future.

It is inevitable it will in time become the world religion, as mankind is becoming too well educated to be guided either in religion or in its political views by blind belief in propaganda. More and more, it is demanding demonstrated facts from those who preach religion and from those who advocate some economic or political system. The Religion of the Stars includes only demonstrated facts and logical inferences derived from them, and it excludes no facts which have been or can be demonstrated.

Materialism Is On Its Way Out

—Materialism is bound to crumble; for irrefutable evidence has been obtained by widespread university experimenters that man's mind does not operate in accordance with physical laws. Both telepathy and clairvoyance have been demonstrated to operate in the past and in the future as well as in the present. Neither time nor distance nor physical barriers has any appreciable influence on them.

And it has been demonstrated that the mind has a nonphysical force which can produce a physical effect upon objects. Within the limits of experiments thus far conducted in universities, this force is as effective when applied to a large object as when applied to a small one, and as effective when applied to a dozen objects at once, as when applied to a single one. On the inner plane, where the mind resides while functioning through a physical body, and where it will continue to reside after the dissolution of the physical body, gravitation, distance and time are of quite a different order.

Orthodoxy Is On Its Way Out

—Orthodoxy also is bound to crumble; for evidence is accumulating, and at no distant date will be overwhelming, that man's life on the inner plane is not as orthodoxy has pictured it, but due allowance being made for the laws of that plane, parallel to his existence while on earth. If the public were aware of the evidence that has been collected relative to inner-plane existence, evidence which in time it will accept, and which orthodoxy will be powerless either to suppress or to refute, it could no longer believe in a static heaven and hell, nor in vicarious atonement. People would no longer swallow the illogical propaganda that belief is the one important factor in reaching salvation, or that any power other than their own efforts could determine their fortune after physical death.

They would realize that character, not the mercy of another, is the factor which determines an individual's station on the inner plane, and that even as it is impossible to acquire an education vicariously, it is impossible to acquire character vicariously. No one can gain ability for another. Ability, knowledge, character and spirituality—and these are the only four possessions an individual takes with him when he loses his physical body—are the result of the individual's own efforts. In acquiring any of these the most another can do is give guidance.

The majority are not yet aware of the evidence that refutes the orthodox belief in heaven and hell and that proves salvation by the blood of the lamb is impossible. But at no distant date the facts of inner-plane existence will be so widely demonstrated that it will be no more possible to believe in these superstitions than it is to believe the earth is the center of the universe and that the sun and stars revolve around it.

Material science has made tremendous strides during the past few hundred years, and particularly during the last few decades. So short a time ago as 350 years it was dangerous for any man to say the earth moves, and is not the center of the universe. Science that short time ago was almost non-existent. Giordano Bruno, a pioneer in science, wanted people to know the earth moved and orthodoxy was in error. Less than 350 years ago, in the year 1600, he was burned for his effort to give people scientific information. And in 1615 and again in 1633—only a little over 300 years ago—Galileo was persecuted for teaching that the earth moves. He had to abjure belief in the Copernican system of astronomy, since universally accepted, to save his life.

Where knowledge of the outer plane is concerned mankind has come a long way in the last 300 years. The public has become so familiar with the facts of the physical world as discovered and utilized by material science that orthodox religion no longer tries to suppress these facts or refute them.

But no systematic effort was made to gather facts relative to the inner plane until 67 years ago. A vast number of phenomena had been reported before that time indicating inner-plane existence, and some of them investigated by men of outstanding scientific rank, but no organized effort had been made to collect and investigate them. But since that time such vast strides have been made that now no unprejudiced individual who is brought face to face with these facts which have been repeatedly demonstrated can believe in materialism. Materialism is now as outmoded, and on as valid proof, as the stationary world was outmoded somewhat after the time of Bruno and Galileo. To put it in the vernacular, although many are not yet aware of it, materialism is a dead duck.

And as soon as university men of science have time further to investigate conditions of life as they actually occur on the inner plane, orthodoxy also will be a dead duck. In fact, if the implications of what university scientists have already demonstrated relative to the powers of the mind were followed to their logical conclusions, and so presented that the public could grasp them, orthodoxy would almost at once be a dead duck.

Although the earliest records of mankind relate experiences in which certain individuals knew the unspoken thoughts of others, foretold the future, saw things at a distance beyond the reach of physical sight, and exerted nonphysical influence to bring events they desired to pass, it has remained for the present generation of scientists to develop laboratory methods which have proved that people—all people in some degree—have such powers.

These university experiments and some of their amazing implications are set forth in the book, *The Reach of the Mind*, by Dr. J. B. Rhine of Duke University. In it he points out that it is fear, more than anything else, that blocks scientific acceptance of extrasensory perception and psychokinesis. One of these fears is that such acceptance will destroy the very foundations on which materialism has been built. The other fear is what Dr. Rhine calls a social one: “The fear of losing caste in one’s profession.”

On pages 179-180 he points out that many scientists have experimented with ESP and PK in secret. It is quite creditable to publish their findings if these do not support that which is now called psi phenomena. Psi phenomena include gaining information (ESP) through other means than reason and the reports of the physical senses, and they include the moving (PK) of physical objects or otherwise influencing physical conditions without physical contact through the power of the mind. But all too often, when the scientist through experimentation finds that psi phenomena actually take place, he decides for professional reasons not to publish his findings. He finds a variety of excuses for withholding the results of his experiments.

Among those pointed out by Dr. Rhine which have come to his attention are that the reputation, and therefore the financial income, of the scientist would be impaired, the institution for which he works would object to a report indicating psi phenomena to be true, he would be subject to the criticism of his fellow scientists, he would not get the promotion he anticipated, and, after all, he carried out the experiments merely for his own satisfaction, not to present them for publication. Says Dr. Rhine: "One could write a book, a sad book about these fear responses.

And it may be added that the writer of these lessons, while not able to write a book about them, is aware of other scientists, including astronomers, who have investigated astrology and found it true, but refuse to acknowledge it in writing, or to others than their friends, because of the same fears

But the time will come when certain university scientists will investigate astrology, and have the courage to report their findings, even as already a large number of university scientists have refused to be coerced into silence about their experiments which have proved conclusively that psi phenomena do take place. Their work has enabled Dr. Rhine, at the commencement of chapter eleven of his book to say

Henceforth I will assume that science will in time accept ESP and PK and that Psi is a normal human capacity, nonphysical in nature."

These psi phenomena, demonstrated in various university laboratories, lead to the inevitable conclusion that there is an inner plane which influences physical life, and on which the soul will function after the dissolution of the physical body.

No intelligent person who follows the scientific experiments with psi phenomena over the years can fail to be convinced that the soul continues to live beyond the tomb, and that its personality there is in essential respects that which it exhibited while on earth. And the time is not too distant when means will be developed by which it can be proved, by university scientists, that the thousands of seers who have reported what they have seen of the manner of life on the inner plane are in the main correct, and that the notions of orthodox religion about afterlife conditions are as erroneous as were their equally dogmatic notions about the physical universe which they held a few hundred years ago.

The Religion of the Stars is the world religion of the future because it embraces, correlates, and formulates a pattern of life from, the facts of both planes.

For living to best advantage after life on earth is done, man must know as much as possible about the inner-plane realm, about its energies and about its properties. Certainly we do not yet know all there is to learn about the conditions that there obtain. But neither do we yet know all the laws and properties of the physical world. Yet relative to both regions science has made many discoveries of importance. And it is no more sensible to ignore these scientific findings in preparing to live well after physical dissolution than it would be to ignore the scientific findings of the last 350 years in preparing to live well while still on earth.

There are backward peoples who try to adjust themselves to physical life according to the scientifically disproved notions of their forefathers. But they live in abject misery. And there is no valid reason to believe that those who reject the discoveries of science relative to the inner plane, and try there to adjust themselves according to the disproved notions of their forefathers, are there going to prosper. On the contrary, there is every reason to believe they will have to abandon disproved notions and accept the facts of after-death life before they can adjust to that life in a satisfactory manner.

As he will have no physical senses when he loses his physical body it is obvious that all information after leaving the physical, other than inferences derived from experiences prior to death, must be acquired through extrasensory perception. As there is neither air on the inner plane, nor physical vocal organs, all his communications with others there must be telepathic. But innumerable experiments carried out in various universities prove that man, even while still on earth, can thus acquire information and communicate with others.

As man while still on earth, usually without being aware of it, occasionally does thus gain valuable information through extrasensory perception, and as the ability to acquire extrasensory perception on certain subjects, and to understand the information so gained, is the source of all genius on earth, the use of extrasensory perception is equally valuable during and after physical life.

Science has been investigating the physical world since about the year 1600, but it has been investigating the more elusive inner plane only since 1882. Yet the attitude of university scientists who have been conducting experiments in extrasensory perception, which includes telepathy, was stated thus in 1942 by Professor Thouless of Cambridge University:

“The reality of the phenomena must be regarded as proved.... Let us now give up the task of trying to prove again to the satisfaction of the skeptical that the psi effect really exists, and try instead to devote ourselves to the task of finding out all we can about it. With fuller knowledge of its nature, the difficulties of believing in its existence may appear less formidable than they do now.”

The Value of Extrasensory Perception

—Neither distance nor time nor physical barriers seems to interfere with extrasensory perception. So far as now known any possible information may, under favorable conditions, be acquired through such extension of consciousness, including, of course, information about the conditions under which people live on the inner plane after physical dissolution, and the laws there operative.

Extrasensory perception at the present day, however, is in a state comparable to that of the telescope in 1608 when Jan Lippershey, a spectacle maker in Zealand, placed a concave and a convex spectacle lens at either end of a tube about a foot long and an

inch and a half in aperture. That marked the discovery of an instrument that, improved step by step for 341 years, now is able to view in its 200-inch reflector on Palomar Mountain a sphere two billion light-years in diameter.

The year following its discovery Galileo made the first improvement on it, and in later years made a telescope that magnified 32 times. But not only was what he saw with it discredited, but the inference that he drew from what he saw—that the earth moves—being contrary to the teachings behind the orthodox iron curtain, he was, as already mentioned, persecuted, and to save his life had to renounce what to him was demonstrated fact.

Extrasensory perception at the present day is in a state comparable also to that of the compound microscope at the period in which Galileo lived. It, as well as the first telescope, was made in Holland. Their early magnifying power was small. But step by step they have been improved through the years until now not only can the single-celled bacteria which are responsible for many diseases be observed by utilizing rays of light, but microwaves are being used to learn new facts about the shape, size and arrangement of molecules, the orbits of electrons around atomic nuclei, and the spin of protons and neutrons within the nucleus of an atom.

In addition to the mentioned university experiments, there are authentic records of a vast number of instances in which individuals have acquired information spontaneously through extrasensory perception which otherwise they could not have acquired. In the spontaneous cases the individual commonly is aware that he has received the information through nonphysical channels. He has so strong a premonition about something, that nothing can shake his confidence it is true. He clairvoyantly sees the image of a relative or acquaintance in an air crash, and knows that person has been killed. Or he has a dream which impresses him emotionally so powerfully with its significance that nothing can convince him the event thus indicated will not actually take place. And later the information he is fully aware he has received through nonphysical sources is fully verified.

Sometimes in university experiments, and when people on their own try to get definite information through extrasensory perception, they are fully conscious that the extrasensory faculty is working. But in most of the university experiments, and in most of the efforts by others to use extrasensory perception, there is no consciousness of whether it has worked or not. It is a process carried out on the inner plane by the soul which commonly registers no impression of its activity on objective consciousness. Both people and animals often act upon its promptings quite unaware of the source of the impulse. And it is only on rare occasions that those most successful in university experiments are aware, until the results of the experiments have been checked, whether or not they have succeeded in bringing extrasensory perception into play.

While it is true that proper training increases the individual's ability to use extrasensory perception, and the frequency with which he is aware when he has been successful in calling it into play, for even the most skillful it is as yet highly elusive.

But neither was the telescope nor the microscope of much value to man in the year 1608.

The big problem at the present time where extrasensory perception is concerned is to find a technique by which an individual can know at the time he is trying to use it whether or not he is succeeding in employing this information-acquiring faculty of the soul. With this problem solved, ingenuity can be brought to bear to devise one method after another, and to test each through trial and error, until the best procedure to bring extrasensory perception into successful activity is understood.

Time, distance and physical obstacles seem to have no power to hinder it. Here we have a faculty from which apparently no secret of nature nor any information in the universe can be hidden. Any knowledge desired, whatever it may be, of past, present or future, seems to lie within the range of its acquirement. The implications are so great as to stagger the imagination.

By its use we may assume that both the cause and the best method to cure any disease might be learned. How to construct a mechanical device for doing any kind of work might be learned through it. Any discovery a scientist wanted to make would be available through this avenue. Crime could be detected before it happened, and criminals thwarted before they committed depredations. The war plans of any group or nations would be accessible to the whole world, and the United Nations could take steps to prevent aggression.

This is an amazing thought. But is it more amazing at this period of transition to the Aquarian Age, than the conception of the flying machine was at the period of transition to the Age of Pisces? At that time Greek mythology held that Daedalus and his son Icarus succeeded in propelling themselves through the air by means of wings secured to the body with wax. This experiment proved fatal to Icarus because in his exhilaration he flew too close to the sun and his wings melted off and he crash-landed in the sea. But more than two thousand years ago the Greeks did conceive the idea of flying.

Leonardo Da Vinci—1452-1519—went so far as to draw the plans of a flying machine. But in 1680 G. A. Borelli, also an Italian of great scientific authority, published a work deriding the possibility of aerial navigation, discussing it in connection with the strength of the human muscles, and concluding that flight was impossible.

But the idea persisted, and one after another people of inventive turn refusing to listen to authority, continued experiments in aviation. Before the turn of the century Sir Hiram Maxim of England, Professor Otto Lilienthal of Germany, and Professor S. P. Langley of the United States carried out experiments in aviation, as now other professors are carrying out experiments in extrasensory perception and psychokinesis.

In 1903 Langley and his assistant, Charles M. Manley, obtained an allotment of \$50,000 from the Board of Ordnance and Fortification of the United States War

Department which was used to construct a gasoline-powered machine. Langley attempted two unsuccessful flights, in the second one of which he wrecked his machine. Then the government refused further financial aid, and Langley's venture became a failure, even though in 1914 Glenn H. Curtiss took the original model, installed a new radiator, carburetor, and floats, and flew it successfully.

Flying for centuries was subject to ridicule, and at the time of Langley's tests, as this writer well remembers, it was something of a fad to poke fun at aviation experiments by quoting verses from "Darius Green and his flying machine." But in spite of these derogatory verses which implied anyone was crazy who tried to fly, on December 17, 1903, the Wright brothers at Kitty Hawk, North Carolina, actually flew.

This was the first instance in which a person had been carried from the ground in actual flight by mechanical means and without artificial aids. And once the problem of always being conscious of when extrasensory perception is active has been solved—and Church of Light research is doing all it can to solve it—the ability of humanity to acquire information through this faculty will progress as fast and as far as aviation has progressed since 1903.

It may take years of research and experiment before extrasensory perception is brought under proper control and can be used at will to perceive events happening on the inner plane, in the distant past and in the distant future, and to acquire information from far distant areas of the visible and invisible universe. But even as after years of improvement the telescope now enables us to see happenings a billion years ago and a billion light-years distant, and the microscope brings us information about the unimaginably small, so improvements in knowledge of, and ability to use, extrasensory perception will in time enable us to employ this faculty reliably and at will to gain information from both the inner plane and the outer plane. And it is because it embraces the facts of both planes, as fast as these are discovered and reliably demonstrated, that The Religion of the Stars will be the world religion of the future.

The Value of Psychokinesis

—Psi phenomena, which is mentioned in the quotation from Professor Thouless, embraces not merely extrasensory perception, but also psychokinesis. And psychokinesis also has been demonstrated by countless university experiments. It consists of moving physical objects, or otherwise affecting physical conditions, by the nonphysical power of the mind.

As when man has lost his physical body he will have no physical muscles, and as objects on the inner plane do not respond to gravitation or physical pressure of any kind, after death man will be compelled to employ psychokinesis to accomplish anything or to go anywhere.

Most have witnessed this power of the mind to produce miraculous cures, or to demonstrate some physical condition. But as yet this power of the mind to influence

physical objects without contact and to bring about desired physical events cannot be called upon at will and used effectively whenever desired. As is the faculty of extrasensory perception, it is still very elusive. But so was atomic energy as late as 1939.

Early in 1939 the artificial fission of uranium was discovered, and on the fifth of May, 1940, Alfred O. C. Nier, of the University of Minnesota, announced a method of isolating U235. But it took the emergency of World War II to concentrate scientific research and tremendous wealth on the problem of how to utilize the energy of fission. By August, 1945, this energy was used to destroy two great Japanese cities, and in 1948 the announcement was made that it was being used as the power to drive a new type of airplane. It is believed this atomic power eventually, if not used to exterminate too much of the population of the world, can be employed to run much of the machinery of civilization.

Although their existence has been demonstrated in university laboratories only since 1934, psychokinetic phenomena have been observed since 1882 by scientists who have conducted psychical research. But today psychokinesis is in about the same position atomic energy was in 1939. And no doubt if orthodoxy could continue to build a sufficiently impervious iron curtain, both it and extrasensory perception—which reveals its opinions on the conditions of life after death to be unsound—would receive no recognition, and little effort would be made to insure progress in their technique.

Yet here we have a power of far greater importance than atomic energy. To develop atomic energy from its position in 1939 to its practical employment in 1945 required a concentration of a large part of the world's most gifted scientists, and an expenditure of two billion dollars. What is most needed now is to get the attention of the world's greatest scientists concentrated on how to make psychokinesis available for practical use. And a government willing to spend two billion dollars to be able to manufacture bombs with which whole nations might be exterminated, should be willing to appropriate a like sum to carry out research on how psychokinesis, which is now meagerly used in psychosomatic medicine, and which could free humanity from want, can be made available for the use of mankind.

At least The Church of Light, through its research, will do all in its power to develop it to a point where it will be of incalculable benefit to the human race. And it is because it encourages acquiring such information, as well as that relating to the outer plane, and embraces all significant information as fast as it is acquired, that The Religion of the Stars will be the world religion of the future.

Man Is Influenced From Both Planes

—Man has a physical body, and he has an astral body. The physical body, and through its nerve currents, which are electrical in nature, his mind, or soul, which resides on the inner plane and is attached to his brain and nervous system by

psychokinetic power—the small emergent part of his mind being the Objective Mind and the submerged part the Unconscious Mind —are influenced by his outer-plane environment. His astral body and his mind, or soul, are influenced by his inner-plane environment; and the thought-cells so affected in turn influence his physical body.

Thus does man live in, and is influenced by, both an outer-plane world and an inner-plane world.

From the outer world he is influenced by the objects and people he contacts, by what people say either vocally or through screen portrayal or the printed page and by the weather.

Objects and people also influence him from the inner plane, but instead of through physical contact chiefly through their character vibrations. From the inner plane he is also influenced, not by what people say, but by their thoughts and the thoughts of other life-forms. From the inner plane he is also influenced by the weather; but this weather is not physical, it is the impact of astrological energies.

As to the degree in which man while still on earth is influenced by each of his two environments, there has been a vast amount of observation, carefully checked, which indicates that if we consider man to consist of his physical body, his mind or soul, and the thoughts which he thinks, the inner-plane environment—which includes objects, the thoughts and actions of intelligent entities, and astrological energies —has as much influence over his thoughts, feelings and behavior as do all outer-plane conditions and energies, including the influence of his associates.

The Inner-Plane Influence of Objects

—As objects on the inner plane are not physical, they cannot influence him there through physical impact or through their chemical properties. But they can, and do, influence him by their character vibrations. And while still on earth, even though he is usually unaware of it, objects powerfully influence him by their character vibrations. The fact that he may be unaware of such influence is no more significant than that he may be unaware of the radiations of atomic energy that unless he moves beyond their range may destroy his body.

Objects and people influence the individual from the inner plane by stimulating into greater activity the thought-cell groups within his own finer form which have the same type of vibration as have the objects and people. Through the principle of resonance, the astral vibrations of people and objects with which closely associated give energy to specific thought-cell groups. Not that physical proximity of itself is important, but the individual tends to tune in by his thoughts on the objects and conditions of his environment. Thus their vibrations reach and give added energy to thought-cell groups having a similar vibration.

If the astrological rulership of an object is known, or the dominant astrological influence of a person is known, this indicates which group of thought-cells within the

finer form of an individual associated with the object or person will be given greater activity. The thought-cell group thus chiefly influenced is the thought-cell group mapped in the birth-chart and by progression having the same astrological rulership.

If this thought-cell group in the finer form is harmonious, giving it additional activity increases its psychokinetic power to attract into the life fortunate events or conditions. If the thought-cell group in the finer form is discordant, giving it additional activity increases its psychokinetic power to attract into the life unfortunate events or conditions. The thought-cells use whatever psychokinetic power they acquire to bring into the life the type of events and conditions they at the time desire. The general characteristics of the event corresponds to the characteristics of the planet mapping the thought-cell group. The departments of life affected are determined by the houses of the birth-chart ruled by the planet mapping the thought-cell group.

The Influence of Thoughts

—As people on the inner plane have no physical bodies they cannot influence him there through physical methods. On the inner plane he is influenced by their thoughts. And while man is still on earth he is also influenced by thoughts from the inner plane. Thus learning how to handle the impact of thoughts is equally valuable during and after physical life.

From the inner plane people's thoughts influence the individual in two different ways. The thoughts of others carry psychokinetic power. To the extent this is true they exert coercive energy. Mass psychology, in which a group of people commit atrocities which none independently would commit, or are carried into unreasonable enthusiasm, is an example of this psychokinetic power; as is the influence of great orators who are said to have strong personal magnetism.

Some people are unusually sensitive to the thoughts of others. Doctors are beginning to recognize that such sensitivity to others' thoughts contributes to the development of certain kinds of diseases. Thus Dr. Jan Ehrenwald, a practicing psychiatrist of New York City, has written a book (1948), *Telepathy and Medical Psychology*, in which he points out that telepathic bombardment by the thoughts of others, to which the individual is unduly sensitive, is often a contributing factor to the development of schizophrenia.

All are more or less telepathically bombarded with the vibration of their name, or with the vibration of numbers with which they are so closely associated that other people while thinking of the numbers also commonly think of them. The name or number, through the thoughts telepathically reaching them, gives added psychokinetic power to the thought-cells within their finer form having the same astrological rulership as the name or number. And this psychokinetic activity contributes to the fortune or misfortune according to the harmony or discord of the thought-cells thus stimulated.

To prevent being influenced telepathically by the thoughts of others that have unusual psychokinetic power it is necessary to develop a mental attitude which repels or deflects such thoughts. But more commonly people are influenced not by any marked psychokinetic power of others' thoughts, but through tuning in on them.

When we think of a person, or a train of thoughts, we tend to synchronize our own vibrations temporarily with the vibrations of the person or train of thoughts. Distance on the inner plane is difference in vibratory rate. When we tune in on a vibration, whatever the physical distance, we have closed the gap and opened the way for an exchange of energies. Our thought-energies flow to that which is thought about, or from that which is thought about to us, according to which has the greatest potential. Thus the best way to prevent being influenced by another's thoughts is not to think about him or the thoughts he holds.

Of all the inner-plane energies, none is so powerful to influence the individual as his own thoughts. Under the impact of inner-plane weather, or the impact of the character vibrations of objects, or the impact of the thoughts of others, it is a serious problem to hold only the thoughts and emotions which we have decided are best under the circumstances.

But as his own thoughts and emotions are his inner-plane food, and properly selected and cultivated can control his destiny despite other influences, one of the greatest boons to humanity is for people to be made aware of what to think and how to develop the type of thinking needed to overcome discords reaching them from without and build into themselves the thought-cells which will enable them to be successful, happy, healthy and spiritual. And because The Religion of the Stars includes this information, as well as all other significant outer-plane and inner-plane information as soon as they are discovered and properly verified, it is the world religion of the future.

Moral Implications

—As on the inner plane there is no air, no moisture, and no molecular vibrations which constitute heat, man there is not influenced by the physical weather. But on the inner plane he is influenced markedly by astrological vibrations, which constitute the inner-plane weather. And even while on earth, though he may not be aware of it, the inner-plane weather has as much or more influence over his life as the outer-plane weather. Therefore, learning the characteristics of the inner-plane weather, how to forecast it, and what precautionary actions to take relative to it, are equally valuable during and after physical life. These matters are discussed in lesson No. 140.

Even relative to the span of physical life alone an individual ignorant of inner-plane energies is able to live up to only one-half his possibilities. Through knowledge of inner-plane energies an individual who will apply such knowledge should be able to increase his spirituality, success, happiness and health 100%. Whatever his objectives may be, he stands a far greater chance of reaching them if he understands

how the inner-plane environment influences his life, and how to take advantage of its energies.

Such increase in an individual's ability to attain his objectives at once raises the question of what those objectives should be. They raise the question of what is, and what is not, truly moral.

In general, the teachings of orthodoxies regarding how man should treat his fellowman are sound. Do as you would be done by, and treat your neighbor as yourself, are valid. They assist all to survive, they assist all to prosper, and they assist all to be happy and spiritual. But these teachings are so interwoven with erroneous beliefs and commandments that they are too often ignored in the effort to live up to the other unsound teachings.

There are innumerable creeds which hold that only those who accept their particular belief, and follow strictly their prescribed ritual, are to be saved, and all others, including the vast majority of the people of the earth, will simmer for eternity in hell.

What an individual believes is chiefly determined by his environment. If he is raised in a pagan land, and has not been brought into contact with Christianity, he will be pagan in his beliefs. If he is raised in a Catholic community, and by Catholic parents, with little chance to contact other ideas, he is almost sure to be a Catholic in his beliefs. If he is raised in a Protestant community, and by Protestant parents, with little chance to contact other ideas, he is apt to embrace Protestant beliefs. If he is raised among Jews, without much opportunity to get other ideas, he will likely embrace the Jewish faith.

The individual certainly is not responsible for being born into a Pagan environment, a Catholic environment, a Protestant environment, or a Jewish environment. Yet with far the majority of people such environment determines the individual's beliefs, and what he considers right and wrong.

Now if God, as many orthodox believe, determines the environment into which the individual is born, and the individual's beliefs and ideas of morality are determined by his environment, God, not the individual, is responsible for these beliefs. Yet many orthodox would have us believe that God will punish the individual for beliefs and acts which the individual thinks are moral, but for which God, and not the individual, is responsible.

That is the old anthropomorphic conception of God, a God Who has human frailties, a God Who unjustly can be persuaded to favor some special nation, Who punishes those who strictly follow religious doctrines in which they believe, but do not conform to those of some other creed, and Who can be cajoled or bribed into granting special, and quite unjust favors to those who give Him praise and beseech Him in prayer.

That there is an all-pervading Divine Intelligence which can be contacted there is much extrasensory evidence to prove. But not a God of whim and cruelty, such as

would condemn to eternal suffering those who had had no opportunity to embrace some special faith.

And there is ample proof that prayers often are answered, sometimes in a most miraculous way. But not due to the whim or prejudice or unjust favoritism of Deity, but through the operation of God's undeviating laws. They are answered through the psychokinetic power of those who pray. There is no more effective way to stimulate this nonphysical power of the mind into activity than through the prayers of a devout and righteous man.

In prayer, whether the words are uttered audibly or only mentally, the effort is not to reach Deity by physical means, but through the activities of the mind. It is, therefore—whether the devotee recognizes it or not—an inner-plane activity. Consequently, it is apt to be more effective if the devotee withdraws his attention from external things, ceases all irrelevant thinking, and causes his attention to be completely absorbed in the meaning and the feeling of the prayer.

But before this, there should be clearly formulated in the mind that the soul is one with the universe, that the spirit is an emanation of Deity, just what it is the prayer is expected to accomplish, and why the all-pervading intelligence and power of Deity should grant the prayer.

To get this realization clearly established it may be well for the devotee after withdrawing his consciousness from external things to repeat a few times:

My Soul is one with the universe, my Spirit an emanation from Deity."

When he feels this relationship has been firmly established in his consciousness, he is then ready to make more specific contact and appeal to Deity. If he is a Church of Light member he does this by starting his prayer thus: "O Thou Eternal Spirit, in Whom I live, move, breathe and have my being!" The mind should be lifted at this point in aspiration and devotion as high as possible.

A worthy prayer, one that can be expected to contact the all-pervading intelligence and power of Deity on a benevolent level, not only must not be to gain some unfair advantage or to injure some other person, but must have within it elements the realization of which will, in some measure, also aid in the realization of God's great plan.

This means that if the individual prays for health, he should pray that he may gain it for the purpose of being of more assistance to others. If he prays for money, he should formulate the prayer in such a manner that it will be clear the money when obtained will not be used exclusively in selfish gratification. If he prays for happiness, he should formulate the prayer in such a manner that it is clear the happiness so attained will be employed to bring happiness or benefit to his associates.

A devout prayer which thus conforms strictly to the universal moral code often has tremendous psychokinetic power to bring about its realization. For, as explained in lesson No. 214, there is a Universal Moral Code, quite apart from any sect or creed.

Against it can be measured the validity of any moral precepts advanced by any religion. It is that A SOUL IS COMPLETELY MORAL WHEN IT IS CONTRIBUTING ITS UTMOST TO UNIVERSAL WELFARE. This is also the moral code of The Religion of the Stars.

Chapter 8

Serial No. 140
Original Copyright 1949
Elbert Benjamine

Copyright
August 2002
Church of Light

Astrology is Religion's Road Map

Chapter 8

Astrology Is Religion's Road Map

THE Stellarian religion is called The Religion of the Stars because astrology affords the best possible road-map for guidance to the most effective and highest type of life. It not only gives the most reliable instructions as to what the individual's religion should be, and what he should do to live his religion, but it also instructs him how best he can do the things which his religion indicates he should do.

If astrology and other inner-plane conditions are so important in religion, and if knowledge of them when applied will increase the individual's success, happiness, spirituality and freedom from illness 100%, why do so many academic intellects refuse to consider or investigate them?

Parapsychology includes investigation of extrasensory perception and psychokinesis. It embraces such work as has been done by Dr. Rhine and his associates at Duke University. Dr. Jule Eisenbud is a practicing psychoanalyst and Associate in Psychiatry at the Columbia College of Physicians and Surgeons. He should, therefore, be able to speak with both practical and academic authority on phobias and irrational censorship of ideas by the objective mind. He specializes in such matters. And in the June, 1948, *Journal of Parapsychology*, he says:

“I should be loath to conclude without suggesting one other possible use for the psychoanalytical approach in a period so important to the development of parapsychology as the present; as a means of investigating more deeply the fundamental nature of the irrationally phobic (passing as critical) attitude of the world toward parapsychology and parapsychologists.”

He implies, quite correctly, that the majority of people at present have, unconsciously, ideas on the subject of extrasensory perception and other inner-plane phenomena, which have so much energy that they exercise a censorship over the acceptance of any evidence, however conclusive, that inner-plane energies exist. He classes the attitude as phobia. And the phobia embraces any evidence of those inner-plane weather influences mapped by astrology. Just how to cure this phobia is one of the big problems now confronting Stellarians.

With time, distance and gravitation on the inner plane having properties so radically different than they have on earth, should we expect inner-plane weather to operate

according to the same laws weather operates on earth? Einstein's Special Theory of Relativity carried to its logical conclusion indicates that inner-plane weather affects the individual, not merely according to his inner constitution, but through certain time-space relationships. These time-space relationships that indicate the inner-plane weather affecting the individual are measured by progressed aspects.

Just how the inner-plane weather affects an individual, however, is not dependent upon any theory. For even as time, distance and gravitation properties on the inner plane have been determined experimentally by university scientists, so have the properties of inner-plane weather, and how it works to affect individuals, groups, cities, nations and world affairs been determined experimentally through statistical studies carried out in the process of astrological research.

Wind, rain, heat, fog, snow, ice and cold do not exist on the inner plane, because these are all properties of physical substances made possible by their low velocities. Instead, on the inner plane, where velocities are too great to permit such physical properties, there are planetary energies the impact of which constitutes the weather of that realm. As there are ten planets, on the inner plane there are ten distinct kinds of weather, entering into endless harmonious and discordant combinations with each other according to the relative volume of each and the angle at which the planetary energies join.

Observation indicates what people's reaction to certain kinds of physical weather will be, and how their lives are apt to be affected by it. And observation also has taught how people react in thought and behavior to each typical kind of inner-plane weather, and what their thought-cells reacting to each uses their psychokinetic power to bring into their lives. What occurs is not inevitable. But what will occur usually can be predicted with considerable certainty because it is the commonly observed reaction to the particular kind of inner-plane weather present.

It may seem amazing that the inner-plane weather affecting one person at a given time may be quite different than the inner-plane weather affecting some other person working daily right alongside of him. But that it does so is a demonstrated fact. And it is no more amazing that the future can be perceived, than what an individual is doing on the opposite side of the world can be observed, or that physical objects can be moved by the nonphysical power of the mind.

People dislike to believe they are the puppets of fate. And some oppose the dissemination of astrological knowledge on the ground that astrology implies fatality. It does imply fatality in the same sense that physical weather implies fatality. Other than to use particles of dry ice dropped through cumulus clouds to produce rain, man has made almost no progress up to the present time in determining what the weather shall be. The wind blows, the temperature falls, the temperature rises, it rains, hails or snows, and the fog drifts in from the ocean as determined not by man, but by Nature. Man at the present is unable to prevent the day from being cloudy or sunshiny. And in that sense physical weather is fatality.

Neither can man, with his present knowledge, prevent the inner-plane weather being mapped by a progressed aspect in his chart involving Mercury, or Sun, or Moon, or Mars, or any of the other planets;

nor can he determine whether the inner-plane weather so designated shall be fine or stormy. If the progressed aspect is harmonious the inner-plane weather will be fine; if the progressed aspect is discordant, the inner-plane weather will be disagreeable.

Just what the inner-plane weather will be during a given period depends, not on anything he can do, but on the planets that form progressed aspects during the period, and what aspects they form. However, through calculating the progressed aspects ahead he can know with much greater precision than our physical weather forecasters can predict physical weather, precisely the kind of inner-plane weather a given individual will encounter in his life during any specific period of the future.

Up to the present time man has been able to do almost nothing to regulate either the outer-plane weather or the inner-plane weather. But he has learned how to conduct himself so that he can prevent unfavorable physical weather causing him the damage it otherwise might, and how to conduct himself to take advantage of favorable physical weather. And he is learning—through knowledge of what to do under certain progressed aspects—how to conduct himself so that he can prevent unfavorable inner plane weather causing him the damage it otherwise might, and how to conduct himself to take advantage of favorable inner-plane weather conditions. And it is just as important to him to know what to do under inner-plane weather conditions of a certain kind as it is for him to know what to do under physical weather conditions of a certain kind.

What would happen to much of the population of these United States if people did not know that crops would not grow over vast areas during the cold months? Unaware that crops would cease then to grow, people would not store up food for these months of frozen soil. The grocer, failing to take proper precautionary actions, would have no food to sell, and a majority of the people would starve.

What else would happen to much of the population of these United States if people did not know that over vast areas during the winter months it would be bitterly cold? They would not build cold-resisting homes, they would not lay in a supply of fuel. Many would freeze, and most would suffer.

What would happen if farmers did not know what to do when favorable weather arrives? Instead of planting crops when they would grow to best advantage, and when they would be ready to harvest before frost, they would pass these opportunities by and fail to gain food that otherwise they might have raised.

If man took no precautionary action against the physical weather he would not build a home in which to live, nor produce clothing to keep from his body the cold, the wind and the rain. And without knowledge of inner-plane weather, and what it is likely to bring, the individual is as helpless to prevent disaster and to take advantage of

favorable conditions as is the individual equally ignorant of what physical weather is likely to bring, and what he should do under certain physical weather conditions.

The individual aware of the functions played by extrasensory perception and psychokinesis, who is conversant with his birth-chart—which maps his own inner-plane thought-cell organization—who is conversant with the inner-plane weather conditions mapped by progressed aspects in his chart, and who takes the precautionary actions advocated for these weather conditions before they arrive and during the time they are present, doubles his usefulness to himself, and doubles his usefulness to society. He can double the chance of remaining in good health, he can double his happiness, and if he so desires he can double his spirituality.

The individual who is wise will thus strive not only to benefit himself, but also to render greater usefulness to society. For by so doing, in addition to the satisfaction such spiritual activities bring, he will insure his further development after life on earth is done, which if continued will lead to Self-Conscious Immortality.

All should learn the lesson taught by early life on earth, that for a better life there should be division of labor and specialization of parts. When protozoa cells joined to form a united cooperative colony, as explained in lesson No. 127, they gained a distinct advantage. And when there was further specializing of parts and further division of labor, as in the vertebrates, other tremendous advantages were acquired. Thus also in the universal scheme of things, as explained in lesson No. 151, there is a cosmic organization. All the information at present available indicates that the universe is an organic whole depending for its progress upon the co-operation of its intelligent parts. If it will make sufficient effort to find it, each soul has its own important work to carry out in this universal organization. And those that do thus contribute their share to the progress of the whole become immortal.

University experiments in telepathy now show that the minds of people are not insulated from each other. They are no more insulated than the various experiences and conceptions which constitute the mind of an individual are insulated from each other. And under suitable conditions for the Law of Association to operate, what one person thinks enters the consciousness of other persons as readily as under the same Law of Association what you think may recall some incident of your life that happened ten years ago.

But while your mind contains innumerable thought-cells and structures, each under the Law of Association capable of communicating its states of consciousness to any others, all are, or should be, under the guidance of the over-all authority which is you. The organization as a whole has a purpose. All the various factors which enter into the organization should, irrespective of their individual desires, cooperate in realizing the objective you have set for yourself.

Thus also should we, to the best of our intelligence and ability, cooperate with other souls in assisting to realize the purpose of the universal over-all authority which we think of as Deity.

Each ego, or spirit, is a spark or emanation from Deity, and thus has the potential of developing and exercising deific powers. And each soul is a cell of consciousness within the universal consciousness, capable of extending itself to partake of the thoughts and feelings not only of other souls and groups, but in some measure on the vibratory level to which its aspirations raise it, to partake of the all-pervading intelligence and power of Deity.

The way the universe is observed to be managed, the function of pleasure and pain in evolving ability, the fact that there is a universal law for all souls— embracing those that as yet are able to find expression only through a single protoplasmic cell, those that express through various plants, and those that have evolved enough to be able to function through man—and why the universal moral code reads, CONTRIBUTE YOUR UTMOST TO UNIVERSAL WELFARE, are set forth in detail in Course 19, *Organic Alchemy*.

Every Step in Evolution is Toward Greater Freedom

—Let us, therefore, instead of dwelling on the universal laws explained in Course 19, recapitulate some of the steps taken in the evolution of life as set forth in the first seven lessons of this Course 7, and observe how each step toward greater ability to perform a valuable function in the cosmic scheme of things has been a step also in the direction of greater freedom.

As indicated in previous lessons the soul is impelled to undertake its journey through the Cycle of Necessity in response to the Drive for Significance. This drive for significance which actuates all life-forms can find satisfaction only through expression. Through psychokinesis the soul attaches itself to one life-form after another, seeking more and more ample expression through developing, as the result of experience, the ability to manifest through successively more complex forms of life. Thus to continue to express itself it must provide nutrition for the form it occupies. And to provide means by which other souls can find expression, it must reproduce its organism. Thus from the primary drive for significance are derived the other two irrepressible drives, the Nutritive Drive and the Reproductive Drive. Every life-form is actuated by, and seeks to express, these three irrepressible drives. They are the motivation of every step in evolution.

All three are prompted by, and seek satisfaction of, the desire for more and more complete expression. In human life we strive, and rightly, for freedom from want. To the extent we attain it are we able to satisfy the nutritive drive; for we are then able to obtain food, shelter and clothing. We not only thus can provide for the continuance of our own life, but can provide for the necessary sustenance and maintenance of children, and in this way assist the reproductive drive to find satisfaction. And through the various gadgets, conveniences and luxuries freedom from want provides, we can find greater freedom of expression.

The nutritive drive, which is the drive for continued expression, does not find satisfaction solely in food. It seeks all means by which the organism can continue and keep healthy, including safety from inanimate things and from enemies. From the very first appearance of life on earth, therefore, we find each species not only seeking food and reproduction, but also seeking freedom from fear.

In religion man seeks to find guidance as to the type of expression while still on earth that will enable him to find satisfaction, and at the same time will insure that he will continue to find satisfactory expression after life on earth is done. He seeks freedom of religion because he wishes the liberty to decide what is best for him on earth, and best to insure continued satisfactory expression after the dissolution of the physical.

Thus in religion he is merely trying to find satisfaction for the same drives which are the motive force of every life-form on earth. All are seeking freedom from want, freedom from fear and freedom of expression. And the whole process of evolution is merely one step after another toward attaining in greater measure these three freedoms. Freedom of religion merely gives each person the opportunity to find for himself the best means for continuing these three freedoms after he has discarded his physical body.

Back at the commencement of life on earth, some 1,750 million years ago, there were iron secreting and sulphur secreting bacteria. They lived on inorganic material. They continue to live in great number to this day. They had a food supply and they had an adequate method of reproduction. But their field of expression was narrowly restricted. Some of them with the drive for significance unusually strong struggled for more freedom of expression, and as a result of using their psychokinetic power both single-celled plants and single-celled animals came into existence.

Both these primitive algae and primitive protozoa had a good food supply and multiplied by cell division. But some of them felt the need for greater freedom from fear. By developing colonial life, in which there was specialization of parts and division of labor, they could, and did, provide for more adequate nutrition and more adequate reproduction. But in addition to moving thus toward freedom from want, they also moved in the direction of freedom from fear; for the cells in the plant walls, and the cells surrounding the animal, provided for protection from enemies and environmental inclemencies.

Some plants, in their effort to secure freedom from want, moved from the water, in which previously all life had lived, onto the land. There they found a more adequate food supply. But thus to maintain themselves they had to develop roots. Driven by this desire to have freedom from fear, they brought their psychokinetic power into play and not only developed roots, but also stalks which would support them and protect them from the weather.

To insure that the reproductive drive might find more adequate satisfaction, the plants first developed spores, and later, so that their young might be nourished during the immature stage of life, they developed seeds. Striving for freedom from want for their young they devised innumerable cunning ways for the widespread distribution

of their seeds. Also for means by which the seeds might be covered with soil and thus assisted to start their growth.

Here in California, for instance, one of the best wild forage plants is filaree, a member of the geranium family. It provides its seeds on one end with a gimlet-like point, and on the other with a long filamentous tail. When the seed dries, during the long season devoid of rain, this tail winds into a spiral resembling an auger, near the end away from the auger point making an abrupt right angle with the general direction of the spiral. This provides a lever with which to gain a purchase against the stem of grass or other vegetation close at hand.

The spiral catches in their hair or fur of any passing animal, which thus carries the seed to some distant point where it is knocked or scratched off. In this distribution it is not more clever than the cockle bur or the dandelion. The cockle bur also depends on animals to carry its young to distant parts; and the dandelion provides its young with parachutes so that the wind will waft them over a wide terrain.

But the filaree seed has an additional advantage. When the rain comes and softens the soil, in response to the moisture its spiral tail determinedly unwinds. The brace, the right-angled arm of the seed tail, by catching against a blade of grass or other vegetation, is prevented from following the unwinding spiral. Therefore, this unwinding, with the upper tail held stationary, gimlet-fashion, screws the seed point down into the moist soil. The filaree seeds not only are distributed widely—they have thus spread all over the California mountains—but they are effectively planted beneath the surface of the soil.

To insure reproduction, plants have made use of insects and devised numerous ingenious methods to make pollination certain.

We might survey each phylum of animal life from I to XII, and observe that each higher step taken has been in response to the desire for freedom from want, freedom from fear, or freedom of expression.

And in Phylum XII, the Chordata, there are numerous examples in which, guided by extrasensory perception, psychokinetic power was brought into play to adapt either the form or the habits to enable the vertebrate creature to move nearer one or more of these three freedoms.

Fish developed strong powers of locomotion that they might leave the sea and move up swift streams where life was not so crowded, the competition for food was less severe, and their dangerous enemies of the ocean could not follow.

When the ponds for a portion of the year dried up in which mud fish lived, they sought freedom from fear by developing their swimming bladder into a sac with which they could breathe air. And in time, in response to this desire to survive, which gives rise to fear, amphibians came into being.

Amphibians had to lay their eggs in water, and their young had to undergo the tadpole stage in the water, before being transformed into land inhabiting animals. But when

the ponds dried up for the whole year round, and a desert-like condition took their place, amphibians no longer could lay their eggs in the water. But the soul striving for expression did not cease to struggle for survival and the perpetuation of its physical form. Thus bringing psychokinesis into play, no doubt under favorable inner-plane weather conditions, amphibians learned to lay eggs in which the young could develop to sufficient maturity that as soon as they were hatched they could forage for themselves.

When the cold shut down, in their determination to continue to find adequate expression for souls yet to be born, extrasensory perception, favored by astrological weather, guided psychokinesis into changing the reptile scales into fur and feathers. And it guided the development of the nesting habits of birds, and the development of a placenta and mammary glands in mammals.

In their desire to have freedom from want, freedom from fear, and freedom of expression, animals also developed intelligence, until in the form of man this intelligence became self consciousness, the power to use abstract symbols in thinking, and the ability to form judgments based on logic.

Man, no less than every lower form of life which preceded him on earth, is driven by the desire for freedom from want, freedom from fear, and freedom of expression. And he has found innumerable ways in which, through the use of the knowledge he has acquired, he can forward these freedoms.

His agricultural knowledge assists him in his effort to gain freedom from want. His knowledge of obstetrics and the infections to which babies are subject, assists him in his effort to continue his race so that other souls can attach themselves psychokinetically to the ovum at the time of fertilization, and undergo the experience of developing and functioning through a human form.

The automobile and the airplane have freed him from the old limitations which hindered travel. Books enable him to acquire more knowledge with which to combat the limitations still imposed by physical environment.

This writer does not assume to know to what extent private enterprise should manage economic affairs and how much should be turned over to the government. That must still be decided, not by arguing about some theory, but by actual experiment.

But the criterion on which the success of such experiment should be based is clear. It is the criterion by which we judge whether or not a life-form is a forward step in evolution. It is whether or not the method employed really adds to its three freedoms. And with the advent of man, freedom to decide the best means for continuing the other three freedoms in a future life—freedom of religion—is equally important.

But in human society we must not consider the freedom of one individual as of more importance than the freedom of another. Each should be permitted as much of the four freedoms as it is possible for him to have without restricting the similar freedoms of others. Nor must one freedom, such as freedom from want, take precedence over another. Freedom of expression, for instance, is quite as important

as freedom from want. Survival—freedom from want and freedom from fear—is not an end in itself. It is a means by which the soul gains experience. And to make that experience worth anything, as this brief survey of evolution indicates, there must be freedom of expression. But in our society the freedom of expression of some must not limit the freedom of expression of others.

To the extent they further the four freedoms for all, in a manner that limits the four freedoms of none, should the success of private enterprise and government ownership be judged.

Astrology is the Greatest Aid in Gaining the Four Freedoms

—With the techniques of their voluntary use properly developed, in the future both extrasensory perception and psychokinesis will tremendously advance man's progress toward the four freedoms. But at that time, because he should use it to guide him in their use, even as today, there will be nothing that will advance the individual or the race toward gaining the four freedoms in full measure as effectively as the knowledge, and the application of that knowledge, of the inner-plane weather conditions mapped by astrology.

From the standpoint of religion, nothing is more important than the development of character. The standards of morality differ with different religions, but all hold that certain actions are moral and that other actions are immoral. Thus, even as preceding each development in the evolution of life on earth, a problem is presented that needs solution. The problem in this instance is how the individual, and his offspring, shall not merely believe in a certain moral code, but can adapt their lives fully and successfully to the moral code in which they believe.

Merely a desire to adapt the life fully to the specific moral code is not sufficient to enable him to do it. No more than merely the expressed desire of an alcoholic is sufficient to make him consistently a sober citizen. To accomplish such adaptation the individual must know how to go about it to overcome tendencies which commonly defeat his intentions.

Within the unconscious of every individual there are thought-cell groups of great energy which, unless they are deliberately and intelligently reconditioned, will cause him to act in a manner that is the very opposite of his more considered conscious desires. These difficult to control trends of character, whatever they may be, are mapped in the chart of birth, along with the more desirable and morally acceptable trends. The individual is not born until the inner-plane weather is such as to indicate by the power, harmony and discords of the planets mapping them, the chief character trends, and the natural aptitudes of the one then born. Not that these trends—trends toward certain types of behavior, trends toward events of a particular kind—inevitably develop into the actions, abilities, diseases and events thus indicated. But unless such trends are perceived before they develop into the indicated

factors, and proper precautionary actions are taken, they usually do in time thus externalize.

In the training of children, including the development of desirable moral attributes, it is a great advantage for parents to know just what each child's weaknesses are. If the child's chart shows a predisposition toward being dishonest, the parent can start in early to apply the factors which are most suited to condition the child toward being honest. If the child's chart shows a predisposition toward trying to dominate others, or toward ungovernable and dangerous fits of anger, the parents can start early, and with much better assurance of success, to apply the psychology which will overcome these weaknesses.

Few people live up to the standards of morality they have set for themselves. Within the unconscious of each individual are stored trends which are derived from the soul's experiences before human birth. Psychoanalysis reveals that within the lower strata of the human mind lie primitive thoughts such as are common to the savage, and impulses that are common to lower forms of life. These primitive thoughts and animal impulses often have so much energy that an adult trying to the best of his ability to live a moral life—in spite of every effort on the part of his objective self—at times finds they take control of him and drive him to actions he later regrets.

Astrology not only reveals these primitive impulses, but it also indicates the best method the individual can employ to recondition them so that, instead of periodically conducting himself in a manner that later hurts his conscience, he can at all times act in the manner which his religion dictates. Astrology indicates just where and how induced emotion and directed thinking should be applied to enable the individual best to live the kind of life he has decided upon.

Under certain kinds of inner-plane weather the individual has both a stronger impulse, and unusual opportunity, to conduct himself contrary to his religious convictions. But a knowledge of progressed aspects, and the precise kind of inner-plane weather each brings, and what temptations are apt to be present during each period thus indicated, enables the individual to take specific and unusual precautionary actions to prevent himself from violating the moral principles in which he believes during any inner-plane weather thus foreshown.

Anyone who will become conversant with his birth-chart and the time and significance of each set of progressed aspects, and who will strive energetically to apply this knowledge, can insure his morality, double his spirituality, and thus in a personal sense attain a high degree of religious freedom.

A great amount of energy is lost through people entering some vocation for which they are unqualified either because they lack the particular kind of ability needed, or because in it they attract unusual misfortune. For the individual to have freedom from want, he should engage in the kind of enterprise in which he can make a success. And for the world to have freedom from want, its citizens should not dissipate their energies following occupations for which they are not qualified.

The birth-chart of a child does not show his abilities. Abilities must be developed through experience. But it does show the child's natural aptitudes, which are stored up experiences from his life previous to birth in human form. And, which in selecting a vocation is equally important, it shows his predisposition toward fortune or misfortune amid the conditions commonly encountered in following each vocation.

As it is a loss both to the individual and to the world for an individual to spend time and energy training for some occupation for which he has no talent, and which he either never follows or fails if he does, the earlier in life a child can begin to train his special aptitudes into definite abilities the better. And as from a chart of birth the natural aptitudes and the tendency to fortune and misfortune amid different surroundings can be ascertained, there need be no loss of time and energy in the training of a child; for in addition to his general education, his training may start at a very early age to channel the development of his natural aptitudes.

Astrological vocational guidance, however, is not confined to children. Adults often need to select a vocation, or to change from one vocation to another due to circumstances over which they have no control. In thus selecting the vocation to follow, the individual should always take into consideration supply and demand and other current physical conditions. But within the limits indicated by these, he can select the vocation, or business, in which he will be most successful, by combining his abilities—for some natural aptitudes need a high degree of training to develop them to a point where they can be used in following some technical or professional vocation—with the predispositions for fortune or misfortune within the environmental conditions of the various vocations which require the special abilities he possesses. His birth-chart indicates the natural aptitudes which can most readily be developed into abilities.

And in following the vocation, profession, or business, if he will take the trouble, through calculating his progressed aspects, to know just what inner-plane weather is ahead, and when it will arrive, and in view of the weather to be encountered will take the proper precautionary actions before and after it arrives, he will make a far greater success than if he neglects such inner-plane weather conditions.

When an individual constructively employs the abilities developed from his natural aptitudes he finds greatest satisfaction in expression. And as following such astrological guidance he can best acquire worldly possessions, he furthers in marked degree not only freedom from want but also freedom of expression.

Not only does ill health prevent many people from keeping continuously employed, depriving them through the expense of medical care of other things they need or desire, but disease gives rise to fear.

The Church of Light through the statistical analysis of the charts of numerous people who have had the disease, has determined the birth-chart positions and aspects for a great many diseases. Not all people who have these birth-chart constants of a given disease develop the disease; but only those who have its constants ever develop it.

Thus the birth-chart constants of a disease indicate, not that a person will have it, but that there is a predisposition toward it.

The Church of Light through the statistical analysis of the progressed aspects in these charts at the time a given disease develops also has determined the progressed constants that are invariably present at the time the disease develops. These progressed constants of the disease, mapping the inner-plane weather always present at the time it develops, do not indicate that the individual will of necessity encounter the disease during the period thus mapped. But they do indicate that the inner-plane weather at that time favors it, and that there is danger of it then developing.

The birth-chart and progressed constants of 160 different diseases are set forth in Course 16, *Stellar Healing*, and further studies of them are published from time to time in C. of L. Astrological Reports. Course 16 also indicates the precautionary measures that should be taken when the predisposition toward a disease indicated by the birth chart is given activity by the progressed constants of the disease.

Relative to diet factors which in general are precautionary actions to prevent disease, these are set forth in lessons No. 153 and No. 221. But the specific diet most suited as a precautionary action against the disease tendencies stimulated by the inner plane weather mapped by an adverse aspect involving each of the ten different planets is given in lessons No. 222, No. 223, No. 224, and No. 225.

In the prevention and cure of disease inner-plane diet is fully as important as outer-plane diet. Thought and emotion are the two factors of inner plane diet. Wisely chosen, they condition the thought-cells to resist and deflect adverse inner-plane weather which otherwise would cause these thought-cells to use their psychokinetic power to develop the disease indicated by the birth-chart and progressed constants.

Good health tends to greater efficiency and to banish the fear of disease, therefore where health is concerned knowledge of astrology and following its guidance markedly furthers progress toward freedom from want and freedom from fear.

The predisposition toward the events which are likely to occur affecting each of the twelve departments of life are mapped in the birth-chart. Such events have their birth-chart and progressed constants, those for 20 different events being set forth in the reference book, *When and What Events Will Happen*. These events, however, are not inevitable. By knowing there is a predisposition in their direction the environment may be selected which will favor those fortunate and hinder those unfortunate, and thus markedly improve the fortune.

An event of importance only occurs when the progressed aspects which are its constants are within one degree of perfect. The general type of event is indicated by the planets involved in the progressed aspect, and the departments of life that will be influenced are indicated by the houses ruled by these planets. With knowledge of how the inner-plane weather during a given period is apt to cause the thought-cells thus given new energy to use their psychokinetic power, and the type and departments of life apt thus to be influenced by an event, the individual is in a

position to use precautionary actions to take the utmost advantage of favorable inner-plane weather conditions, and to forestall and avoid the influence of adverse inner-plane weather conditions.

As through giving him knowledge of just the precautionary actions to take to improve the events which occur in his life relative to each of its 12 departments, astrological guidance can improve the fortune of all departments of life, it thus can contribute markedly to freedom from want, freedom from fear, freedom of expression and freedom of religion.

Outer-plane weather conditions are pronouncedly influenced by inner-plane weather conditions. For long range weather prediction astrology is many times more accurate than the weather bureau. What the season will hold of outer-plane weather conditions is important in many ways. This knowledge is especially important for those who plant and harvest crops. If there is going to be a late cold spring, certain crops should be planted later. If there are going to be floods, it is wiser not to plant ground which is apt to be inundated. If there is going to be a wet fall, it may be advisable to start harvesting earlier than usual, so that it may be finished before the wet sets in. If there is going to be an early freeze, certain fruit should be picked before it is damaged by the cold.

Astrological weather predicting also is valuable in other matters. It enables the individual to pick a day for a picnic, or for some other venture when the weather will be favorable for it. If there are to be heavy storms during a given period, it benefits various groups to know this ahead of time, and to make proper preparations.

Through indicating what the physical weather will be during various periods, astrological guidance contributes to freedom from want and freedom from fear.

The inner-plane weather affects not only individuals, but various groups of people. Progressed aspects made in the charts of the birth of corporations, cities, and nations give a good picture of what the attitude of the group will be during the period covered by the progressed aspects, how they will react to proposals made by other groups, and what fortune or misfortune they are likely to have in the various departments of their lives.

The biggest problem facing humanity as a whole is how to get the various groups of people, and the various nations, to cooperate for the advancement of all and the avoidance of war. Astrology cannot solve this problem, but it can give guidance as to the best way it can be solved. It indicates by the progressed aspects of a country, for instance, the best approach to win its approval of some plan for cooperation. And it indicates by the progressed aspects in the charts of the leader of the country the best time to approach him for such cooperation.

When the birth-chart of a group is known, it gives a better understanding of the aims, motives and methods of the group. And the progressed aspects in the chart of the group warn of its aggressive action before that action is taken, and even before it is contemplated by the group.

Astrology through giving better understanding of people, makes it easier for nations to get along harmoniously. Thus through its guidance both freedom from want and freedom from fear may markedly be forwarded.

Evolution is observed to be moving constantly in the direction of greater freedom; and where man is concerned it is the greatest of all aids in attaining freedom from want, freedom from fear, freedom of expression and freedom of religion. But are such freedoms the will of God?

The Stellarian religion holds that instead of relying on the opinions of people of the past who were wrong about much of the phenomena of the material universe, man should rely on his own observation of nature to determine the will of God.

The universe is the expression of the all-pervading Super-Intelligence. And even as we judge a man's character and what he wants by his actions, and not by some ignorant person's opinion based on no knowledge of his actions, so it is logical not to judge the character of God, and what He wants by the ignorant opinion of someone who knows nothing of His actions, but to judge what God wants by His actions.

Those actions are observed to be the evolution of life toward the four freedoms, broadly guided by astrological energies climaxing on earth in that microcosm we call man. And toward a perfection of intelligence and love that enables the evolution to be carried on indefinitely in the realms of after-death life. Toward also immortality, and the development of an effective workman with special talents, capable and willing to assist God to realize, throughout immeasurable vistas of the future, His Great Program of Eternal Progression.

Book 13

Copyright
August 2002
Church of Light

Mundane Astrology

Chapter 1

Serial No. 141
Original Copyright 1935
Elbert Benjamine

Copyright
August 2002
Church of Light

The Doctrine of Mundane Astrology

Chapter 1

The Doctrine of Mundane Astrology



UNDANE ASTROLOGY is the science of the influence of the heavenly bodies as they affect the world, nations, cities, communities and other groups of people. Any organization of individuals functioning under a common governing authority constitutes an entity. As such it attracts to itself fortunate and unfortunate events in a manner quite similar to that in which like events are attracted into the life of man. Both have birth charts which if known correctly map their characters; and both are influenced by picking up, radio fashion, four-dimensional vibrations through changes in their finer structures which are mapped by progressed aspects.

Progressed aspects indicate the release of energies within the astral body of man that build across his four-dimensional form temporary stellar aerials. These temporary stellar aerials, so long as they function, pick up planetary energies of definite type, endow them with discordant static or pleasing harmony, and transmit them to the thought-cells within the astral body at their terminals.

The astral body of man is composed of thought-cells, or stellar cells, as they also commonly are called. These thought-cells, receiving a new supply of energy from the temporary stellar aerials, acquire unusual activity. They thus work from their four-dimensional plane to attract events into the life.

According to their original composition, and the discord or harmony of the energy added to them as mapped by the progressed aspect, do they feel beneficent or malignant. To the extent they feel beneficent they work to attract fortunate events. But to the extent they feel malignant do they work to attract misfortune. The importance of the event attracted depends upon the amount of energy they acquire.

These stellar cells, of which the astral body of man is composed, occupy definite compartments within his finer form, as mapped by the houses of the birth chart. The department of life to which an event attracted by a progressed aspect relates is determined by the compartment in the astral body the thought-cells of which receive the additional energy. This is revealed by the house occupied by each planet involved in the progressed aspect.

This whole matter is set forth in all its details in Course 10. It is mentioned here, not to explain it, but because the individuals of a corporation, a city or a nation play very much the same part in Mundane Astrology that the thought-cells within the astral body of man play in natal astrology.

These individuals are thinking units within the body of the community. The community birth chart indicates the character of the community as a functioning whole. As progressed aspects form to the birth chart and progressed planets in this community chart, thought trains are released. These link certain individuals of similar motives and ideas together in a manner that enables them, and the thought-forms they generate, to perform the same function performed by a temporary stellar aerial stretching across the astral body of individual man.

Through this thought-chain, and those persons which thus act as receiving terminals, because they have so completely tuned in on certain planetary vibrations, additional planetary energy finds its way to various members of the community. These feel in a particular way in reference to community effort, depending upon the type and harmony or discord of their respective characters and the type and harmony or discord of the new energy thus received.

According to the way they feel and think and act, in response to the new four-dimensional energy received, is the event attracted through their activities harmonious or discordant. And according to the trend of their thinking and activities is one department of community life affected instead of another.

Progressions Are Calculated For Nations Cities and Corporations

During the seven years since this Course on Mundane Astrology was first published our research department has diligently investigated the birth charts and progressed aspects of all countries and towns for which it could obtain accurate birth-data. However, the number of authentic birth charts of these larger groups which it has been able to obtain is disappointingly small.

But it has not been so difficult to get the correct birth information of corporations.

The result of this research work indicates that while countries and sections of countries respond more pronouncedly to Cycles and current astronomical phenomena than individuals do, that they, as well as cities and lesser corporations, are influenced much as individuals are by Major Progressions, Minor Progressions and Transits.

A nation, or a section of the country, responds so pronouncedly to Cycles and current astronomical positions, that even when the birth chart of the nation is known, these should receive special consideration. But I believe that if reliance had to be placed upon only one type of influence that far greater precision could be obtained through the use of Major Progressions, Minor Progressions and Transits, than through the use of Cycles and current astronomical positions.

Our experience has been, although that experience has been limited by necessity in the case of nations and cities, that in predicting events for a nation, city, town or corporation, nothing else gives the details and precision that can be gained by the use of a correct birth chart and progressed aspects. The mathematical work is identical in working progressions for these larger entities, with that used in working progressions for an individual, as set forth in Course 10. The interpretation of the progressed aspects thus ascertained deviates from that given in Course 10 only to the extent made necessary in considering a group instead of an individual.

In the case of most countries and cities, however, the difficulty of obtaining a correct birth chart is so great as to prohibit their use. We are, therefore compelled to use, not what we prefer, but that which we can get. Cycles and Major Conjunctions thus give us much information as to what will happen at a specified time within a given area; but they do not clearly designate the city, or other small locality chiefly affected by the event. They do not point out the one specific enterprise, among many of a similar nature, which feels the full weight of the influence. Such details can be had only from progressions calculated to a correctly timed birth chart.

The Moment of Birth of a Corporation

Such correct birth charts are not so difficult to obtain for corporations. Particularly is this true in reference to the new corporations which are formed from time to time. The data are so fresh in the minds of those forming them that they are easily procured. And more frequently than the general public recognizes, an astrologer is called in to determine the most propitious time for launching such a corporate venture.

But whether to select the proper time to bring a new corporation into existence, or to be able to determine the characteristics and general fortune of one already in existence, and the event likely to be attracted by each progressed aspect that forms, it is essential that the true moment of birth be known, for which the birth chart should be erected. This raises the question as to just what marks the true moment of birth.

It is customary, in the formation of a corporation, for an attorney to draw up the Articles of Incorporation, have them signed by those forming the corporation, and forward them to the proper State authority. This State authority signs the proper papers giving permission to the corporation to function according to its Articles of Incorporation.

Before the corporation can thus function, however, it must formulate and adopt rules and regulations for the conduct of its affairs which are not specified in the Articles of Incorporation.

Commonly a set of By-Laws has been drafted by the attorney, and after he receives the charter of the corporation, signed by the State, granting the corporation permission to function, he calls the first official meeting of the trustees or board of directors. The chief object of this first meeting is to enable the trustees or board of directors to adopt the By-Laws which shall govern them in their subsequent business and other transactions.

The formation of the corporation, receiving a charter signed by the State, and the formulating of the By-Laws, all seem to me to belong to the period of gestation. The attorney acts as midwife. He delivers the State charter, Articles of Incorporation and By-Laws to the trustees or board of directors. Their signing acceptance of them is the first independent act of the corporation.

As the corporation does not function, but has merely been granted privilege by the State to function, until its directors or trustees have thus signed the By-Laws, or such papers as shall govern its future activities, this act of signing acceptance by those who are to handle its affairs, seems to me to mark the true moment of birth.

Coordinating the Heavens With Geographic Areas

Assuredly there is a definite correspondence between geographic positions and celestial influences. Many years ago Albert Ross Parsons, in a book now long out of print, published a map, which used the Great Pyramid of Gizeh as a starting point from which to coordinate geographic longitude with zodiacal longitude, and thus obtain the sign and degree ruling each degree of longitude on the earth's surface.

Later, Sepharial published his Theory of Geodetic Equivalents, in which he assumes that 0—degrees longitude on the earth's surface corresponds to 0—degrees Aries on the ecliptic, that 30 degrees longitude on the earth's surface corresponds to 0—degrees Taurus, that 60 degrees longitude on the earth's surface corresponds to 0—degrees Gemini, etc.

These correspondences are for the midheaven of the locality. Therefore, to find the rising sign and degree, simply use the degree thus indicated on the cusp of the 10th house, and from a table of houses for the latitude of the place ascertain the sign and degree on the Ascendant when this degree is on the M.C. The geodetic M.C. of Chicago, thus obtained, for instance, is Capricorn 2—0, and the Ascendant is Aries 3—53. The M.C. of San Francisco, following this procedure, is Scorpio 27—35, and its Ascendant is Aquarius 7 42.

L. Edward Johndro points out, with apparent justification, that the rulership of areas on the earth's surface according to the correspondence between geographic longitude and the signs and degrees of the zodiac, gradually shifts, due to the precession of the equinoxes. From pyramidal and other data, he places the correspondence of 0—degrees Aries on the M.C. as west longitude 29—10 on the earth's surface.

Paul Council, following rather closely the methods of Mr. Johndro, but using other data to establish the starting point, finds that 0—degrees Aries on the M.C. corresponds in 1930 to west longitude 36—42. Using this as a basic point of reference, he spreads the stars upon a map of the earth.

These efforts to establish the correct coordinates between each area of the earth and its celestial correspondence are deserving of every encouragement. Even though there is still a difference of opinion as to how the coordinates should be determined, still, such coordinates must exist, and when enough research has been done, no doubt, the correct ones will get proper recognition.

I feel quite sure that each area of the earth's surface does thus have its correspondence in the sky which has an influence over it. Yet in the Hermetic System of Mundane Astrology, instead of dealing chiefly with land areas, which are stationary, we devote our attention as largely as possible to actual groups of people.

In every birth chart the geographic position of the individual at the moment of his birth must be considered in erecting the chart. But after the individual has been born, the fact that he moves to some distant place is entirely subordinate in its influence over his life to the Major Progression in his birth chart which impelled him to make the move.

If, therefore, it is possible to secure the actual birth chart of an individual, a corporation, a city or a nation, I am convinced this chart, erected and progressed according to the accepted method, is the best of all indices as to when, and what, events will be attracted.

Yet entirely aside from such a birth chart, and aside from coordinates, practical experience indicates that the important events which are to happen within a given area are all foreshown by other astronomical relations, chiefly by the heavier aspects which have some influence over the world as a whole, and by Cyclic Charts and the Charts of Major Conjunctions erected for that area.

General Astronomical Phenomena

The sign occupied by each of the major planets, and the aspects that form between these planets from time to time, have an influence over the trend of world events. Where these events chiefly will take place must be determined from the specific birth charts and progressions, or lacking these, from the Cyclic Charts, of the nations, cities and communities of the world.

The whole world often is somewhat affected by a given astronomical relationship; but as a rule certain regions of the earth are much more affected than others. For instance, the discovery of the new planet, Pluto, early in 1930 was coincident with a financial depression which affected the whole world.

For about seven years after its discovery Pluto was continuously afflicted by the square of the disruptive planet, Uranus, and at times also by the square of Jupiter and the opposition of Saturn.

No country in the world escaped serious difficulties. But some countries were more influenced than others, and to determine where the influence would thus most pronouncedly be felt, something more than these general astronomical positions had to be known.

In the birth chart of the U. S., given at the front of this lesson, Neptune, the planet of inflation, of promotion schemes, and of exaggerated expectations, is in the house of speculation (5th). Mars is the planet of energy and of over expansion. In 1929, by Major Progression, Mars, co-ruler of the people of the U. S. (1st), came conjunction Neptune r, stimulating a wild period of stock-market and other speculation, in which a large part of the population took part. Any astrologer, observing this affliction in the 5th house of an individual, would have advised caution and conservatism. But typical of Mars conjunction Neptune, caution was thrown to the wind in the hope of some wonderful gain.

Venus in the U. S. chart is in the house of money (2nd). By December, 1929, the Moon, by Major Progression, was in the house of speculation (5th), making the perfect square to Venus r. Early November, 1929, was the time the stock-market broke. Mars had passed the perfect conjunction to Neptune r by only 20 minutes, and by mid-November the Moon was within one degree of the perfect square to Venus r, by Major Progression. This was the time when a vast number of people suffered financial loss.

It marked the commencement of a financial depression affecting the whole world, coincident with the influence of an afflicted Pluto. Pluto at that time, by Transit, was in the 2nd house (money) of the U. S. chart, and did not permanently leave it until 1933. Thus was it shown, by the progressions in its birth chart, that the U. S. would be more affected by the general afflictions in the sky than most other countries.

In the space at my disposal I can not give historical references covering many events of wide significance which have been indicated by current astronomical positions. All I can hope to do is to point the method of research to be followed by anyone desirous of tracing the pattern of history in its various details.

Merely as an example, necessarily curtailed, of what I mean, it may be noticed that before the disruptive planet Uranus moved permanently away from the aspect, it made the perfect square to Pluto five distinct times. And each time there was a shattering of precedent in America, in Europe, and in the Orient.

The first square occurred April 21, 1932. In the Far East, Japan decided to acquire Manchuria by military aggression. In Europe a financial crisis arose, with open threats of bankruptcy on the part of Germany, and a possibility of revolution. In the U. S., to avert the threatened condition in Europe, President Hoover declared a moratorium on the June payments due this country, thus setting a precedent and greatly deepening the depression in the U. S. (where Pluto by Transit was still in the money house).

The second square of Uranus to Pluto occurred Sept. 3, 1932. In Europe the League of Nations told Japan to get out of Manchuria. In the Far East, Japan told the League of Nations to mind its own affairs, and continued establishing herself in Manchuria. In the U. S., Bonus Marchers in Washington were fired upon, one was killed, and their shelters were burned. They were driven from Washington like starving cattle.

The third square of Uranus to Pluto occurred March 8, 1933. In the Far East, Japan withdrew from the League of Nations and started an invasion of China. In Europe, Hitler became dictator of Germany, compelled the religions to make revisions to his order, and started a campaign of persecuting the Jews. In the U. S., all banks in the country were closed for about two weeks.

The fourth square of Uranus to Pluto occurred Nov. 6, 1933. In the Far East, Japan, in a dispute with Russia over the Chinese Eastern Railway, threatened war. In Europe, Hitler demanded for Germany equality of armament, and thus started a war scare. In the U. S., a presidential executive order on Nov. 8, established the Civil Works Administration, and allotted \$400,000,000 to employ 4,000,000 men as a relief measure.

The fifth square of Uranus to Pluto occurred January 17, 1934. In the Far East the failure of the U. S. to recognize the Japanese puppet state, Manchoukuo, caused the Japanese Admiralty to state war with the U. S. is inevitable, and to ask for huge war appropriations. In Europe, Hitler defied all countries to invade German soil, and Mussolini warned that Japan is preparing for war, with Germany as a probable ally. In the U. S. strikes of major proportions developed in various areas, and the warlike attitude of Japan was answered by U. S. recognition of Russia.

Lest the impression should be given that only afflictions of the planets, as they are shown for the time in the ephemeris, influence the trend of events markedly, let us consider the trine of Jupiter, the financial planet, to Saturn, the business planet, on Oct. 26, 1933.

October 22, after the aspect had come within the one degree of perfect, Roosevelt in a radio address announced a managed currency program through attempting to control prices by establishing a free gold market. Oct. 24, Roosevelt ordered NRA Director Johnson to recommend prohibitive tariffs on articles whose importation hampers recovery, and Secretary Ickes allotted \$6,000,000 PWA funds for All-American

Canal in Imperial Valley, giving employment to 9,000 men. Oct. 25, Roosevelt ordered AAA to loan up to 4 cents a bushel on warehoused corn to farmers pledged to reduction program; and RFC set price of newly-mined domestic gold at \$31.36 instead of the former standard price of \$20.67 per ounce.

The aspect also had a constructive influence in many other countries, depending upon the progressions operative in their charts at the time. But I believe sufficient has been said about aspects as they are shown in the ephemeris.

In many countries the date of whose births are unknown, observation has caused astrologers to believe they are ruled by certain signs. When, through the observed effect of planets transiting a certain sign, or from other astronomical phenomena occurring in the sign, it becomes fairly certain of the sign ruling a country or city, the Transit of a slow-moving planet through the sign, or a Major Conjunction or other phenomena taking place in the sign, may be made the basis of determining some of the things which will happen in that country or city. The signs also rule certain departments of endeavor in the world's affairs. And such things in general as the signs thus rule are affected by the Transit of a heavy planet through the sign.

Examples of a Planet Transiting Through a Sign

Again I have space to devote to this merely sufficient to enable me to point out to such as are interested in tracing such matters, how to proceed. What follows, therefore, is not an attempt at a full exposition, but is put forward only to give hints which may advantageously be followed.

We know too little about Pluto's influence in the past to use this most slow-moving planet in our examples. But Neptune, next slowest in motion, takes about 14 years to Transit each zodiacal sign. I shall give slight attention to its beneficial influence, and confine my observations to its well recognized proclivity when afflicted of creating a chaotic state of affairs. As a matter of fact, such chaos frequently compels drastic steps to be taken in the direction of true progress.

Neptune was in the sign Cancer from June, 1902 to May, 1916. Cancer rules the home and it rules the ocean. It was during this period that the submarine was developed into an instrument of practical use in warfare. It became effective during the World War. Being hidden from view, and secretive in its method of attack, it well exemplifies Neptune.

Before Neptune entered Cancer, women found ample opportunity to exercise their skill and industry in the home. But not long afterward, machinery was doing nearly all of those things upon which they prided themselves. Deprived of self expression, the home became chaotic, and they began to seek employment elsewhere, entering industry in competition with men.

From May 1916 to July 1929, Neptune was in Leo, the sign ruling amusements and rulership. Chaos developed as to the ruling authority. Most kings were kicked off their thrones, and in some countries, notably Russia, Turkey and Italy, dictators took their place. Moving pictures developed into the dominant form of entertainment. Yet this industry was thrown into a chaotic state, and was compelled to develop a different type of talent through the introduction of talking pictures.

From July 1929 to August 1943, Neptune is in Virgo, the sign ruling agricultural produce and labor. To decrease the over-abundance of agricultural produce, the U. S. in 1934, paid farmers to reduce acreage and to plough under every third row of cotton. It bought up millions of sows about to farrow and slaughtered them that their pigs might not be born. Yet in the same year unprecedented droughts turned many of the agricultural states into almost desert conditions. Throughout the world the greatest problem is that of unemployment. There were 14,000,000 unemployed in the U. S. in 1933.

Next let us briefly consider Uranus, the planet of invention, of radical activities and of disruption. He takes about 7 years to pass through each zodiacal sign.

From December 1904 to November 1912 Uranus was in the sign Capricorn, which rules the country, Mexico, and in business and industry rules system. During this time a revolution overthrew the government of Mexico, and the development of mass production revolutionized industry.

From November 1912 to January 1920 Uranus was in the sign Aquarius, ruling Russia, and ruling the rights of man. A revolution overthrew the Russian government. The slogan of the nations winning the World War was to make the world safe for democracy. The treaties at the close of the war were based upon the rights of people to self-determination as to allegiance and form of government.

From January 1920 to January 1928 Uranus was in the sign Pisces, ruling restrictions, relief measures, disappointment and crime. In January, 1920, the prohibition law, which was repealed in 1934, because it was believed to be responsible for developing and financing organized crime, and creating the modern racketeer and gangster, went into effect. Disappointment was expressed in nearly all countries at the failure of ideals which had been encouraged during the war. Each country also felt disappointed at what it received in the final settlement.

In the U. S. relief measures were constantly before Congress, and those high in public office sold out vast holdings to corporations, and later were successfully prosecuted for bribery; the properties being recovered by the government.

From January 1928 to March 1935 Uranus was in Aries, the sign ruling Germany, ruling manufacturing, and ruling military leadership. A revolution gave Germany a dictator. Japan, hitherto of minor importance, took her place as the rival of both Britain and the U. S. in manufactured products and as a naval power.

From March 1935 to May 1942, Uranus will be in Taurus, ruling Ireland, and ruling the banks and money.

From May 1942 to June 1949, Uranus will be in Gemini, ruling the U. S. A., and ruling newspapers and transportation.

Cycles

A Cycle, as used in Mundane Astrology, is a chart erected at a given locality for the moment a planet crosses the celestial equator from south declination to north declination. The Cycle of the Moon is erected for the moment when the Moon is in conjunction with the Sun.

Each planet thus has its own Cycle, which governs those matters the planet rules. The planet for which the Cycle is erected, as it moves to aspects, by Transit, with the places occupied by the various planets in the Cycle Chart, indicates the time and nature of the events which takes place in the locality for which the chart was erected. The lessons which follow take this matter up in detail.

Major Conjunctions

The conjunction of two planets in the sky corresponds to the convergence of corresponding factors on the earth. And a chart erected for a given locality at the moment of such conjunction indicates the significance of the event thus attracted in that particular region. This also will be given detailed attention in the following lessons.

Birth Charts of Nations and Cities

In lesson No. 142 (see Serial Lesson Key), a list of nations and cities ruled by each zodiacal sign is given. The following is the birth data of some nations and some cities, according to the research of those who have made a special study of them.

In no instance do we vouch for the authenticity. They are presented merely as the birth charts commonly used by those most conversant with Mundane Astrology. Twelve of the more important are preceded by numbers. These refer to the table at the front of the lesson, from which the positions of the signs on the houses and the planets in the signs may readily be copied, thus giving the student the birth chart of the nation or city preceded by a number without the work of making the calculations.

319. Argentine Republic, July 9, 1816, 4:00 p.m. 66W. 26S.
320. Austria; Republic of, Nov. 12, 1918, 4:00 p.m. 16E23. 48N14.
Barkingtown, England, Oct. 5, 1931, 12:15 p.m. L.M.T.
321. Boston, Mass., May 1, 1822, 12:01 a.m.
322. Chicago, Ill., March 4, 1837, 2:05 p.m.

323. Cleveland, Ohio, March 5, 1836, 12:01 a.m.
 Ft. Myers, Fla., May 19, 1905, 11:44 a.m. L.M.T.
 German Republic, Nov. 9, 1918, 1:22 p.m. L.M.T. 13E. 52N.
 Jacksonville, Fla., May 31, 1887, 11:41 a.m. L.M.T.
324. Long Beach, Calif., Dec. 13, 1897, 10:00 a.m.
 Los Angeles, Calif., Sept. 4, 1781, 9:17 a.m.
325. Miami, Fla., July 28, 1896, 11:39 a.m. L.M.T.
 (Chart incorrect, accurate time is 2:39:16 p.m. LMT)
 Miami Beach, Fla., May 25, 1917, 11:40 a.m. L.M.T.
 Orlando, Fla., July 31, 1875, 12:00 noon L.M.T.
 Palm Beach, Fla., Apr. 17, 1911, 11 :39 a.m. L.M.T.
 Pensacola, Fla., Dec. 5, 1825, 12:01 p.m.
326. Russia; Republic of, Nov. 9, 1917, 5:16 a.m. L.M.T. 59N56 30E18.
 (Table chart in error)
327. Spanish Republic, Apr. 14, 1931, 4:45 p.m. L.M.T. 3W41. 40N24.
 St. Augustine, Fla., Dec. 28, 1824, 12:01 p.m.
 Tampa, Fla., Dec. 15, 1855, 11:37 a.m.
328. Toronto, Ont., Canada, March 6, 1834, 5 :15 a.m.
329. U.S.A. Chart as used by C. E. James, July 4, 1776, 5:00 p.m., Philadelphia, Pa. Chart
 of U.S.A. used by us is given at front of lesson, July 4, 1776, 2:13 a.m., Philadelphia.
330. Virgin Islands, U. S. A., March 31, 1917, 4:33 p.m. 65W. 18N20.
 West Palm Beach, Fla., Nov. 5, 1894, 11:39 a.m. L.M.T.
 Winnipeg, Man., Canada, Nov. 8, 1873, 4:00 p.m.

Examples of Major Progressed Aspects in the Birth Charts of Nations and Cities

The following is not an attempt to prove that the birth charts of nations and cities as here given are correct. It merely gives the dates of a few outstanding events, and the Major Progressions at the time in the charts here given. This is to indicate to the student of Mundane Astrology the method to be followed in his work, and what he may expect from progressed aspects.

Major Events are attracted to a nation or a city ONLY when there is a Major Progressed Aspect within one degree of perfect which relates by house position to the department of life affected. Furthermore, even as in natal astrology, Minor Progressed Aspects attract Minor Events, and Aspects by Transit attract Inconsequential Events.

These lesser progressions do not attract Important Events, but by adding accessory energy to Major Progressed aspects may precisely time Important Events.

In the following examples, unless otherwise expressly stated, all aspects mentioned are Major Progressed Aspects.

Chart 319 is that of the Argentine Republic. Sept. 6, 1930, the president having been forced to resign a few days earlier, the vice-president also resigned, and the Military Assembly took possession of the government: Jupiter, ruler of 1st (people), ad been square Saturn p, ruler of 2nd (money) a number of years, and discontent had arisen over the handling of finances. Mars, ruler of 12th (secret enemies), conjunction Jupiter r, ruler of 1st (people). Sun, ruler of 7th (open enemies), semi-sextile Uranus r in 12th (secret enemies). Mercury, ruler of 10th (administration), square Venus r in 7th (open enemies).

Chart 320 is that of the Republic of Austria. In the summer of 1934 revolution broke out; Asc. opposition Venus p, ruler of the 1st and 7th. Venus inconjunct Pluto r, shows the split into strong conflicting factions; and Mars in 9th (religion) sesqui-square Saturn r, is responsible for religion entering the conflict. Foreign powers aided the revolutionary movement; Sun conjunction Mercury in 7th (foreign nations). The sesqui-square of Mars to Saturn r, ruler of 10th (governing authority), brought an attempt to overthrow the government, and accomplished the assassination of its dictator, Englebert Dollfus, on July 25, 1934.

Chart 321 is that of Boston, Mass. The Great Fire took place Nov. 9-10, 1872. Jupiter, ruler of the 4th (buildings), had progressed to the square of Mars r (fire). Mars (fire) was sesqui-square Saturn r, ruler of 1st (people). Venus, inconjunct Mars in the birth chart, was in the 4th (houses), trine Mars p (fire).

The Police Strike, the settlement of which by Calvin Coolidge, then governor, gave him national recognition for his manifesto that, "There is no right to strike against the public safety by anybody, anywhere, any time," was Sept. 9, 1919: Mercury, ruler of the 6th (labor and police), semi-sextile Mars r in 7th (war); Sun sextile Mars p (strife), ruler of 10th (employers); Mars inconjunct Jupiter r, ruler of 12th (crime); Saturn conjunction Sun r.

Chart 322 is that of Chicago, Ill. In the birth chart Mars is in the 1st, conjunction Jupiter and opposition Neptune. At the time of the Great Fire, Oct. 8-10, 1871, Mars, after being retrograde had again reached the conjunction Jupiter r; and Venus, ruler of 4th (houses), was trine Mars r and sextile Neptune r, thus adding new energy to the heavy opposition in the birth chart.

May 4, 1886, following a strike there were serious Anarchist Riots: Mars (strife), ruler of 1st (people), square Saturn p, ruler of 6th (labor).

1893, World's Columbian Exposition put Chicago on the map as a city of unusual business enterprise: Sun in 10th (business and honor), square Jupiter r in 1st (people).

1933, Century of Progress Exposition brought a record attendance; Jupiter in 1st (people) had been trine M.C. r (honor) for some years. Mercury, ruler of 7th (other people), was sextile Jupiter p. Mercury was retrograde in motion and still closely sextile Jupiter p in 1934. The fair was continued that year, with vast throngs in attendance.

Chart 323 is that of Cleveland, Ohio. At the time of the serious labor difficulties and strikes of 1934, the Sun was sextile Venus r, ruler of 6th (labor), and was sesqui-square Saturn r, ruler of 2nd (wages).

Chart 324 is that of Long Beach, Calif. In the birth chart the Sun is heavily afflicted by the conjunction of Mars and the opposition of Neptune. Pluto is in the 4th (lands and buildings), and at the time of the earthquake, March 10, 1933, the Sun was exactly sesqui-square Pluto p. There was great damage to buildings.

The Moon (many people) is in the 7th, but is ruler of the 6th (illness). Mars (violence) was exactly inconjunct Moon r. Many persons were injured.

Mercury, ruler of 8th (death), was square Jupiter in 8th (death). There was heavy loss of life.

Finally, the Moon by Major Progression, had moved into the 10th, in sextile to Sun r. This gave the matter wide publicity, and the good aspect thus made by the Moon brought prompt and efficient relief to the many people who were in distress.

The Chart of Los Angeles is given at the front of this lesson.

1805—Locust pests destroy crops: Sun conjunction Neptune r in 12th (pests). Moon probably conjunction Pluto in 4th (crops on the ground).

1806—Indians taught to grow hemp: Sun, ruler of 10th (employers), conjunction Venus r (people). Mars, ruler of 6th (servants), trine Mercury in 10th (business).

1815—Floods: Mars on 4th (weather), opposition M.C. r (business).

1817—First record of a school in Los Angeles: Jupiter, co-ruler of 5th (schools), square Mercury r.

1825—Greater floods: Mars in 4th (weather), trine Venus, ruler of 1st (people). Mars is square Venus in birth chart. Elections were held, but thrown out as illegal: Mercury, ruler of 9th (law), sextile Sun r, ruler of 10th (administration).

1830—Elections again thrown out: Sun square M.C. r (government); Mercury, ruler of 9th (law), sesqui-square Moon r in 6th (laborers).

1847—Stockton arrives and there occurs near Los Angeles the Battle of San Gabriel River, resulting in the defeat of Mexican forces, Jan. 8. Los Angeles is again taken Jan. 10, signing articles of capitulation Jan. 13, 1847: Sun ruler of 10th (government), sesqui-square (agitation), Uranus r (disruption). Sun sextile Mars r, ruler of 7th (war). Venus, ruler of 1st (people), trine Mercury r in 10th (government).

1851—First newspaper in Los Angeles: Sun conjunction Jupiter r, ruler of 3rd (newspapers); Venus in 3rd (newspapers), opposition Uranus r in 9th (publishing).

1868—First bank opened in Los Angeles: Sun in 2nd (banks), sextile Jupiter p, ruler of 1st (people).

1934 Nov. 25th; street car strike: Mercury, ruler of 10th (employers), semi-square (friction), Moon r in 6th (employees). Mercury sextile Mars p, ruler of 3rd (railways), in 7th (war). There was much violence.

Major Progressions in U. S. Chart

Mr. C. E. James, who has made extensive research, believes the time for the U. S. chart should be 5:00 p.m. His chart is given in the table as No. 329. Examples that follow are for July 4, 1776, 2:13 a.m., the chart I have used since 1908, which is given at front of this lesson.

1807—Aaron Burr, intending settlement of Western lands or invasion of Mexico, leads conspiracy and is tried for treason: Mars, ruler of 12th (conspiracy), conjunction Sun r, ruler of 4th (lands).

June 18, 1812—War of 1812, ostensibly over violation of rights of neutral trade and impressment, but also with desire of repressing Indians through acquisition of Canada: Jupiter ruler of 7th (war), conjunction Sun r, ruler of 4th (lands); Venus conjunctions Sun p in 4th (lands; Sun semi-square Venus r, ruler of 6th (laborers); Mars (strife), square Saturn r, ruler of 9th (shipping).

Dec. 2, 1823—Monroe Doctrine declares America not subject to settlement by European powers: Sun, ruler of 4th (lands), in 4th (lands), semisquare Sun r.

1832—Oregon trail for settlement of Oregon: Mercury in 4th (lands), semi-square Mercury r in 3rd (trail or road). Black Hawk War: Sun in 4th (lands of Indians wanted by Whites), sextile Jupiter r in 7th (war).

May 13, 1846—War with Mexico, resulting in acquiring western territory; Texas annexed previous year: Sun, ruler of 4th (territory), square Mars r (strife); Sun, ruler of 4th (territory), sextile Jupiter p, ruler of 7th (war).

Jan. 24, 1848—Gold discovered in California: Jupiter in 2nd (cash), sextile Mars r in 1st (people), square Saturn p (planet of mining). This starts a vast throng traveling west: Mercury, ruler of 3rd (travel), sextile Mars p in 3rd (travel).

1849-50-51—Boom days in western gold fields: Sun conjunction Neptune r (booms), in 5th (speculation).

Apr. 19, 1861—First blood of Civil War: Sun square Jupiter r, ruler of 7th (war); Mercury, ruler of 1st (people), in 6th (slaves), sesqui-square Uranus p in 1st (people), Mars in 4th (territory), opposition (separation), Pluto(?) r (co-operating factions), in 10th (government).

Apr. 20, 1871—Ku-Klux Act is passed giving civil and political rights to Negroes: Sun conjunction Saturn r, ruler of 9th (laws); Venus, ruler of 6th (inferiors), trine Venus r, ruler of 12th (secret societies).

Sept. 18, 1873—Panic starts, causing several years' depression: Sun in 2nd (money), trine Pluto (?) r in 10th (business); Venus trine Venus r in and (money); M.C. (business), square Moon r, in 10th (business).

June 27, 1893—Commercial panic is started: Sun trine Jupiter r in 2nd (money); Mercury square Pluto (?) r in 10th (business); Sun sesqui-square Venus r in 2nd (money), M.C. (business) , connection Uranus r (disruption).

Apr. 25, 1898—War with Spain: Sun inconjunct Uranus p in 1st (people); Sun semi-square Neptune p; Mars (strife), square Asc. r (people); Jupiter, ruler of 7th (war), conjunction Mercury r, ruler of 1st (people).

Apr. 6, 1917—U. S. enters World War: Mercury inconjunct Uranus p, ruler of 1st (people); Mars (strife), inconjunct Moon r in 10th (government); Jupiter, ruler of 7th (war) , conjunction Mercury r, ruler of 1st (people).

Because Major Progressions of the Moon, Minor Progressions and Transits operate in the chart of a city or nation just as they do in the chart of an individual, it would be amiss not to give a few examples of Major Progressed Aspects of the Moon, at least, and the Sub-major events attracted by them. The Major Progressions around the outside of the U. S. Chart given at the front of this lesson are for March 5, 1933, when all banks in the country were closed. As the Moon is progressing about 1 degree a month, even without an ephemeris the student easily can trace the progressed aspects it makes during the balance of 1933, and it is these Major Progressed Aspects of the Moon in 1933 that now follow:

March 8—Currency inflation of 3 billion dollars promised by administration, scrip plan abandoned: Moon, ruler of 2nd (money), semi-square Neptune p (inflation), and Mars p in 5th (speculation).

Apr. 12—Two billion dollar farm mortgage relief and refinance bill passes house; Roosevelt's congressional message asks 2 billion dollars for home owners' Mortgage relief: Moon, ruler of 2nd (money), trine Sun r, ruler of 4th (homes and farms).

June 9—National Recovery Act passes senate, suspending anti-trust laws, giving President power to alter tariffs: Moon semi-sextile Saturn r, ruler of 8th (tariffs), and 9th (laws).

Aug. 1—NRA blanket code, regulating hours of labor, wages, and prices of goods proclaimed effective throughout nation: Moon, ruler of 2nd (prices and wages), in 6th (labor), square Pluto r (NRA) in 10th (business).

Sept. 14—R.F.C. offers billion for bank stock investment in NRA industrial credit plan: Moon sextile Venus p in 8th (debts), Moon sesqui-square Venus r in 2nd (banks), Moon semi-sextile Sun p in 7th (borrowers).

Oct. 9—Johnson recommends price-fixing in retail grocers' and similar codes: Moon, ruler of 2nd (price), square Moon r in 10th (business), from 6th (groceries) .

Dec. 15—Roosevelt orders navy to check liquor smugglers: Moon, ruler of 10th (administration),inconjunct Mars (liquor), ruler of 12th (smugglers).

Chapter 2

Serial No. 142
Original Copyright 1935
Elbert Benjamine

Copyright
August 2002
Church of Light

The Cycles of Pluto and Neptune

Chapter 2

The Cycles of Pluto and Neptune



HE thoughts of man, and his emotional reactions to events, enter into combination with related thoughts and emotions to build up the thought-cells, or stellar cells, of which his astral body is composed. And according to the department of life to which they are related do they thus build thought-cells within one of the twelve compartments of the astral body rather than within the others.

These twelve compartments are accurately mapped by the twelve houses of the birth chart. Each house indicates the composition, harmony and activity of the thought-cells within the compartment of the astral body relating to one department of life.

In the life of a nation or a city, the individuals composing it perform very much the same function that thought-cells do within the astral body of individual man. People, by their interests, activities and occupations, relate more pronouncedly to one department of the nation's life than to other departments. Thus it is that in a mundane chart the composition, harmony and activity of the human and other factors relating to a given department of life, are mapped by a house having a significance similar to that attached to it in natal astrology.

One, therefore, who is familiar with the department of life ruled by each of the twelve houses in natal astrology will commonly have little difficulty in selecting the house of the birth chart of a nation, of a Cycle Chart, or of a Major Conjunction Chart, which rules any given phase of activity.

All that is needed is to expand the function of the house, as recognized in natal astrology, to embrace group activities of similar purport. Yet as the significance of the houses is so important in any branch of astrology, as it is to them we always must look to determine the department of life affected, they should here be designated specifically in their relation to mundane affairs.

FIRST HOUSE.—The people of a country or city; their disposition, health and personal affairs as distinct from their foreign interests.

SECOND HOUSE.—The wealth and personal property of the people, the national treasury, banks, non-speculative bonds and securities, financial transactions, and places where money and securities are handled.

THIRD HOUSE.—Transportation, railroads, roads, motor busses, automobiles, local airplane traffic, local traffic in general; telegraph, telephone, and mails; printing, newspapers, magazines, other periodicals; literary work, intellectual activity, the thoughts of the people; neighboring countries.

FOURTH HOUSE.—The land, the homes of the people, buildings, hotels and rooming houses; the weather, agriculture, crops on the ground, mining; the political party that is out of power but opposed to the ruling party.

FIFTH HOUSE.—Entertainment and the motion picture industry, theaters, other places of amusement, the birthrate, speculation, the stock market and stock exchange, ambassadors from foreign countries, children and places where children congregate, such as schools and colleges. The education acquired is ruled by the 3rd, the teachers by the 9th, and the place where education or entertainment is dispensed by the 5th.

SIXTH HOUSE.—The illness of the people, their food; laboring people and their labor; employees in general, including the personnel of the army, navy and police force who are employees of the people, also all civil service employees; stored grain or other stored products of the land or mines, the garnered harvest, restaurants, cafeterias, drug stores and all places where food and drink are dispensed; small animals.

SEVENTH HOUSE.—Foreign nations and their attitude, war and international disputes, marriage and divorce.

EIGHTH HOUSE.—The death-rate and the kind of deaths suffered by the people; the debts due from foreign countries; tariffs, taxes, insurance, pensions; the cabinet of the president or prime minister and the chief appointees of the mayor of a city or governor of a state.

NINTH HOUSE.—Interstate and international commerce and traffic, the navy, foreign shipping, the radio, cable messages, interstate airplane traffic; the law, lawyers, the supreme court; churches, religion, preachers; teachers, lecturers, publishing, advertising, books, lectures, and all places where opinions are publicly proclaimed.

TENTH HOUSE.—The administration, president, dictator, monarch, governor or mayor; the credit and reputation of a nation; its business and its influence in world affairs; also eminent and famous persons, and those possessing unusual power.

ELEVENTH HOUSE.—The legislature or parliament, particularly the house of commons; the aldermen of a city; and ambassadors sent to foreign countries.

TWELFTH HOUSE.—Prisons, hospitals, asylums, workhouses, charitable institutions, relief work, crime, criminals, detectives, secret societies, spies, and the secret enemies of the people; large animals.

Sign Rulership of Nations and Cities

Because in attempting to determine the rulership of a country or city by observing the effect of the Transits of the heavier planets through the signs, it is easy to mistake the influence of a planet Transiting through the first house for its influence when Transiting through the tenth house, and vice versa; and as most of the sign rulerships which follow were determined by someone who observed that planets Transiting a certain sign commonly influenced strongly a certain city or country; it is probable that further research will make necessary a number of modifications in this list.

It is given, therefore, not because it is considered authentic, but merely because it represents the rulership most commonly used by astrologers at this time. In very few instances has our research department as yet had the time to test these rulerships. But as opportunity offers for such detailed investigation the findings will be published in THE CHURCH OF LIGHT QUARTERLY, and any changes will be included in future issues of this lesson.

ARIES—Countries: England, Palestine, Denmark, Japan, Syria, Lesser Poland, Bergundy, and the older authors give Germany.

Cities and Towns: Florence, Naples, Saragossa Verona, Marseilles, Brunswick, Capua, Leicester Oldham, Birmingham, Blackburn, Cracow, Utrecht.

TAURUS—Countries: Ireland, Asia Minor; Caucasus, Cyprus, Persia, Poland, Grecian Archipelago, Georgia, Austria.

Cities and Towns: St. Louis, Dublin, Palermo Rhodes, Mantua, Parma, Leipzig, Ashton-under-Lyne.

GEMINI—Countries: United States (7°), Lower Egypt, West of England, Belgium, Armenia, Flanders, Lombardy, Wales, Tripoli, Sardinia, Brabant N.E. Coast of Egypt.

Cities and Towns: San Francisco, London (17°-54'), Cordova, Bruges, Melbourne (10°-29'), Louvain, Metz, Nurenberg, Plymouth, Versailles, Wolverhampton, Wednesbury.

CANCER—Countries: Scotland, Holland, N.W. Africa, Paraguay, East of Mauritus, Zealand; Germany.

Cities and Towns: New York, Constantinople, Venice, Genoa, Tunis, Stockholm, Milan, Manchester, Algiers, Amsterdam, Cadiz, Berne, Lubeck, Magdeborg, Deptford, Rochdale.

LEO—Countries: France, Italy, Northern Roumania, Sicily, Chaldea, Bohemia, Apulia, the Alps, Phoenicia, round Tyre, and Sidon.

Cities and Towns: Chicago (1st decanate), Rome, Bristol, Philadelphia, Damascus, Portsmouth, Ravenia, Prague, Bombay (3rd decanate), Bath, Taunton, Blackpool.

VIRGO—Countries: Brazil, Assyria, Babylonia, Crete, Kurdistan, West Indies, Part of Greece, Croatia, Turkey, Thessaly, the Morea, Silesia, Switzerland, Virginia.

Cities and Towns: Jerusalem, Brindisi, Norwich, Lyons, Heidelberg, Corinth, Bury, Cheltenham, Maidstone, Reading, Todmorden, Paris (29°), Padua, Strasburg, Toulouse.

LIBRA—Countries: China, Indo-China, Tibet, Borders of Caspian, Upper Egypt, Savoy, Argentina, Livonia, Burma.

Cities and Towns: Vienna, Antwerp (21°), Charleston, Frankfort, Lisbon, Copenhagen (1°), Johannesburg (27°), Nottingham, Placenza, Leeds, Fribourg, Gaeta, Spires, Middleton, Los Angeles.

SCORPIO—Countries: Norway, Queensland, Transvaal, Algeria, North Syria, Morocco, Bavaria, Barbary, Jutland, Judea, Catalonia, Cappadocia.

Cities and Towns: Baltimore, Cincinnati, Dover, Fez, Halifax, Hull, Liverpool, Messina (18°), Milwaukee (7°), St. Johns New Foundland (2°), Newcastle, New Orleans, Valentia, Washington, Worthing (7°), E. Grinstead, Stockport, Glossop.

SAGITTARIUS—Countries: Arabia, Australia Dalmatia, Cape Finistere, Hungary, Madagascar Moravia, Province in France, Slavonia, Spain, Tuscany, Felix, Istria.

Cities and Towns: Avignon, Toledo, Rottenburg W. Bromwich, Bradford, Taranto, Sunderland, Budapest, Cologne, Stuttgart, Narbonne, Sheffield Nottingham.

CAPRICORN—Countries: India, Afghanistan Greece, Macedonia, Mexico, S.W. Saxony, Styria, Circan, Maraccan, Punjab, Thrace, Illyria, Romandiola, Orkney Islands, Mecklenburg, Albania, Bosnia, Bulgaria, Khorassan, Hesse.

Cities and Towns: Boston, Brussels, Oxford, Keighley, Tortona, Port-Said Prato in Tuscany, Fayence in Provence, Brandenburg, Constanz.

AQUARIUS—Countries: Sweden, Tartary, Lithuania, Piedmont, Arabia the Stony, Abyssinia, Circassia, Prussia, Russia, Wallachia, Westphalia.

Cities and Towns: Hamburg, Salisbury, Trent, Satzburg, Ingolstadt, Bremen, Brighton, Salzburg.

PISCES—Countries: Nubia, Normandy, Galicia, Calabria, Portugal, Sahara Desert.

Cities and Towns: Alexandria, Preston, Bournenouth, Cowes, Lancaster, Ratisbon, King's Lynn, Southport, Grimsby, Seville, Worms, Compostella, Farnham, Yiverton, Regensburg, Christchurch.

Thought-Trend, Business, and Political Group Ruled by Each Planet

Each planet rules definite activities and definite environmental influences. A list of these is given in lesson No. 107. But as the events shown by a Cycle Chart are chiefly brought about through the influence of the activities ruled by the planet for which it is erected; and as the events indicated by Major Conjunctions are chiefly brought about through the things ruled by the planets which are in conjunction; close attention should be paid in all Mundane delineation also to the trend of thought, the type of business, and the political group, governed by each planet, as follows:

SUN.—In thought, politics. In business, executive work and administration. In politics, bosses and the ruling class.

MOON.—In thought, the family and home. In business, groceries and other commodities. In politics, women and the common people.

MERCURY.—In thought, science. In business, literary work. In politics, the press.

VENUS.—In thought, the beautiful. In business, art. In politics, the so-called society element.

MARS.—In thought, mechanics. In business, manufacturing and the military profession. In politics, militarism.

JUPITER.—In thought, religion and philosophy. In business, finances and commerce. In politics, capitalism.

SATURN.—In thought, orthodoxy. In business, land and basic utilities. In politics, conservatism, the farmer and the miner.

URANUS.—In thought, the occult and ultra progressive. In business, invention and unusual methods. In politics, the radical element.

NEPTUNE.—In thought, the mystical and psychic. In business, promotion and stock companies. In politics, the ideal.

PLUTO.—In thought, spirituality or inversion, and the influence of invisible intelligences. In business, group activity, either for the selfish advantage of the group or for universal good. In politics, compulsory cooperation.

The Birth Chart of a Cycle

When a planet moves from south declination to north declination there is a definite change of polarity which marks itself in the astral substance which environs the world. The moment thus indicated is the birth of a new cycle of influence in so far as this particular planet and the things it rules are concerned. And a chart erected at any place on the earth's surface for this moment indicates, by the house positions of the planets, particularly when they aspect this particular planet, the influence of the things ruled by this planet during the ensuing cycle.

A Cycle Chart, except those of Sun and Moon, DOES NOT indicate the influence of a wide variety of things on the affairs of the locality for which erected. Its influence is narrowly confined to that which it is there possible for the things ruled by the planet for which the chart is erected to exert. A Mars Cycle reveals the influence exerted by mechanics, by manufacturing and the military profession, and by aggressive action; but it does not reveal the influence of orthodoxy, of land and basic utilities, of conservatism, or of the farmer and miner.

A Cycle Chart is the birth chart of the type of influence indicated by the planet for which it is erected. This birth chart continues effective until the commencement of the next Cycle of the same planet. It is possible, for instance, to gain some information from a chart erected for the time the Sun enters Cancer, for the time the Sun enters Libra, and for the time it enters Capricorn. But these quarterly charts are entirely subsidiary to the Ingress Chart for the year, erected for the time the Sun crosses from south declination to north declination.

The Sun and Moon and the things they rule are so important in human life that from the Sun Cycle for each year and the Moon Cycle for each month it is possible to determine much of what is going to happen in a country or city. But if dependence is placed exclusively upon the Ingress Map (as the Sun Cycle commonly is called), and the Lunation Maps (as the Moon Cycles often are termed), some of the most outstanding events will be overlooked; for these relate chiefly to the influence of things ruled by some other planet.

Progressing a Cycle Chart

A Cycle Chart, as the birth chart of a definite influence over a stated period, reveals the events that will transpire due to that particular influence, but not those due to other types of influence.

And, as in the birth chart of an individual, the time when the indicated events will happen is revealed by Progressed Aspects. But unlike the progressions in the birth chart of an individual, only one planet makes progressed aspects.

Also, unlike the birth chart of an individual, the progressions of this ONE planet are by TRANSIT only, and ONLY to the birth chart positions of the planets. That is, throughout the duration of the Cycle, the positions of the planets in the Cycle Chart, and not as they later appear, are the positions to which progressed aspects are made. And the progressed aspects to them, which indicate when the indicated events will happen, are those made by the position of the planet for which the chart was erected, as it moves forward by TRANSIT, as shown by the sign and degree it occupies on the same date in the ephemeris.

The Two Most Common Errors

The most common error of those who are unfamiliar with the use of these Cycle Charts is the attempt to predict events unrelated to the planet for which the chart is erected. The next most common error is to consider the progressed aspects made by planets other than the one for which the chart was erected. Both of these errors grow out of a misconception of the true nature of a Cycle; and either of them will lead to unreliable forecasts.

Erecting the Cycle Chart

A Cycle Chart is erected for the longitude and latitude of the place where its influence is to be ascertained, for the exact moment the planet crosses from South Declination to North Declination. The moment it reaches 0°N 0' declination is the correct time.

This time may very roughly be ascertained from the declinations given in Raphael's Ephemeris, using either proportional logarithms, or simple proportion, to find the time when the planet reaches 0°N 0' declination. Unfortunately, however, as the declinations are given only every second day for the slower planets, the time thus ascertained is not precise enough to give accurate house positions when the chart is erected at some particular place. Therefore, until more precise data is incorporated in this ephemeris, it becomes necessary to have recourse to The American Ephemeris and Nautical Almanac. This is published each year by the U. S. Government, and may not be had through book dealers, but must be obtained directly from The Superintendent of Documents, U. S. Government Printing Office, Washington, D.C.

In this annual publication the declinations are given each day with the variation in declination per hour. In the ephemeris for Greenwich time Uranus and Neptune are given only for every fourth day, but for Transit at Washington they are given for each day. As the variation per hour—amount of movement—is given to 1/100 of a second, and as their places are given to the nearest 1/10 of a second, the data is quite precise enough for the purpose of ascertaining the time for which Cycle Charts should be erected.

**All Cycle Charts in These
Lessons Have Been Erected
From the Precise Data
Afforded by the Nautical
Almanac**

As it is intended to publish in THE CHURCH OF LIGHT QUARTERLY both the time and the charts of more important Cycles in the future, the Nautical Almanac is indispensable only to those who expect to do considerable original research in Mundane Astrology. Throughout this entire Course, the time given for which charts are erected is LOCAL MEAN TIME.

**Orb of Influence of a Cycle
Chart**

When a new Cycle Chart comes in it is found that the events signified by it may begin to happen somewhat before the Cycle actually starts. The changing of the planet, from south magnetic polarity to north magnetic polarity, brings into considerable prominence the affairs under the rulership of the planet. The time of the commencement of the Cycle, therefore is commonly coincident with some of the matters foreshadowed in the Cycle Chart.

That which happens as the Cycle commences, and which comes under its influence, is seldom all that transpires of similar import during the Cycle. More often it foreshadows other events of similar nature which come to pass at the time progressed aspects form in the Cycle Chart. And not infrequently these later events are a further development of less outstanding events that arrive with the Cycle.

Astrological influences tend to bring a response from the physical environment, not merely at the moment the phenomenon is perfect, but for a certain time before and a certain time afterwards. In its change of polarity, from south to north, the change begins to exert an influence when the planet is within one degree of crossing the celestial equator, and continues to exert some influence during the time it is within one degree after crossing.

The influence is more pronounced while the planet is close to the exact line between south and north declination. But because the physical environment, by its resistance or lack of it, may require accumulated planetary pressures to manifest as a given event, the condition indicated by the changing polarity may develop somewhat before, or somewhat after, the exact moment of change in declination. There is an orb, therefore, of one degree of movement by declination, within which events signified by the Cycle may take place before the Cycle actually starts.

In a similar manner, the Progressed Aspects which form to the places of the planets in the Cycle Chart, also have an orb of one degree from the perfect aspect, within which the event signified happens. In the Moon Cycle, which is set for the conjunction of the Moon with the Sun, and not for change in declination, because the Moon moves so rapidly, an orb of 24 hours is allowed within which the event signified by the progressed aspect of the Moon happens. Any event which transpires outside of the orb of one degree from perfect, or in the case of the Moon, more than 24 hours before or after the perfect aspect, should not be attributed to the commencement of the Cycle or to the aspect.

Pluto In Mundane Astrology

The characteristic feature of most events attracted through the influence of the planet Pluto is group activity in the accomplishment of some purpose. Mob lynching, for instance, are typical; although the purpose of the group activity may be either beneficial to society or opposed to it.

Pluto is never milk and water. He always is either strongly for the right or strongly for the wrong. Cooperative effort to alleviate suffering and to administer justice are under his rule, as also are the activities of gangsters and racketeers. In this latter field his specialties are kidnapping and mass murder.

On the constructive side he accomplishes his work through commissions, bureaus, committees, or other groups who accept the responsibility of obtaining the desired results. Unlike Neptune, he has little regard for the voice of the common people. When he works for their welfare, as he does when his better side expresses, he delegates to a group of specialists the responsibility of deciding what is good for the people and how best to obtain it. Neptune would let every man have a voice in deciding important matters; but Pluto, through popular vote or force of arms, gives dictatorial powers to one person or to a small group of persons, and holds them responsible for results.

Pluto, whether dealing with the common man or with those of much authority does not ask, by your leave; but dictates what shall be done. Those under the leader, who has been elected by popular ballot or who has placed himself in power through force, are expected to carry out his orders unquestioningly. Subordinates who fail to cooperate are drastically and summarily punished. And all those coming under the jurisdiction of the group are compelled to cooperate in carrying out such plans as have been decided upon.

Pluto, when afflicted, tends to split a group into two rival factions. And even when unafflicted, the forming of one group to accomplish some purpose is usually the occasion for the formation of another group to prevent that purpose being realized. The conflict of opposing interests, next to group activity, is the most characteristic expression of his influence.

His worst attribute is Inversion. Thus the suppression of facts and the distortion of information to create a public opinion favorable to some group, or favorable to the purpose of some group, is the greatest menace he affords, and is perhaps also the greatest menace to human progress.

331. Chart of Conjunction of Uranus and Pluto, June 20, 1850, 6:52 a.m., Washington. Uranus (liberty) conjunction Pluto (organized group) in 10th (business interests), sextile Sun in 12th (slaves), semi-square Mercury in 11th (congress); Mercury square Neptune, ruler of 9th (laws). The underground railroad by which slaves escaped became the object of legislative controversy resulting on Sept. 18, in a New and Drastic (Uranus) Anti-Slave Law, intended to check Organized (Pluto) assistance to fugitives.

332. Chart of Conjunction of Neptune and Pluto, July 22, 1891, 10:24 p.m., Washington. March 14, eleven Italians were lynched (Pluto) in New Orleans. This crime (Jupiter in 12th square Neptune and Pluto) resulted in the recall by Italy (Uranus in 7th sesqui-square Neptune and Pluto) of her minister at Washington, and a demand for reparations (Neptune and Pluto in 2nd). The controversy continued throughout the summer, and not until Apr. 12, 1892 was the matter finally settled by the payment of cash (Neptune and Pluto in 2nd) to Italy by our State Department.

The Cycle of Pluto

The last Cycle of Pluto commenced Feb. 20, 1864. At the time this is written no tables are available covering the declination of Pluto in 1864 with sufficient precision to determine the time of day when it crossed from south declination to north declination.¹ Therefore, until such tables are calculated, we must be content with the Natural Chart of the Pluto Cycle, given at the front of this lesson, which is equally applicable to the whole world, and in which the house positions of the planets are completely ignored.

This was during the Civil War, and the North had failed to accomplish much, as its various military leaders each acted largely according to his own plans. But with the commencement of the Pluto Cycle the leaders were compelled to act as a unified group; for on March 12, Grant was given complete command of all the Federal forces.

1 *In a letter dated April 27, 1959 U.S. Naval Observatory states: "...no exact ephemerides for years as early as 1864 have been computed...but accurate basic tables are now available...in Greenwich Time Pluto crossed the equator from South to North within a few hours before or after the midnight between February 20 and 21, 1864."*

The following dates are those of heavy Pluto aspects, by Transit, to the places of the planets in the Pluto Cycle Chart. As the degree occupied by the Moon is unknown, aspects to it are neglected, and as house positions likewise are unknown, they also will receive no consideration. As many aspects are given as available space permits, and, except for those since 1920, which are not included in it, the events will be confined to those given in the brief Reference History of the U. S., in the back of Webster's New International Dictionary.

June, 1869, Pluto trine Mars r: June 15, Massachusetts Act for State Railroad Commission (Pluto), first of its kind.

1875, Pluto trine Venus r: Thirty nations form the Universal Telegraph Union, and twenty-three nations adopt the Metric system of weights and measures.

June, 1876, Pluto trine Venus r: June 25, Massacre (Pluto method) of Custer's forces in Montana by the Sioux, under Chief Sitting Bull.

May, 1877, Pluto trine Venus r: Reduction of wages causes railroad riots. Mob (Pluto) controls Pittsburgh July 19—23 and destroys much property.

1878, Pluto opposition Jupiter r: Sixty nations form the Universal Postal Union.

1883, Pluto square Sun r: At Berne Convention, nineteen nations ratify standardized international patent laws.

June, 1884, Pluto square Sun r: June 27, Congress authorizes the Federal Bureau (Pluto) of Labor.

August, 1887, Pluto sextile Neptune r, trine Mercury r: Sept. 5, Labor Day (labor acting as a group) first observed in New York as a legal holiday. Also, same year, fifteen nations at Berne Convention adopt uniform copyright laws.

1889, Pluto sextile Neptune r, trine Mercury r: The International Parliamentary Union is formed.

May, 1902, Pluto trine Saturn r, inconjunct Mars r: May 12—Oct. 21, strike (group activity) of anthracite coal miners (Saturn occupation); 145,000 miners stop work, coal famine (Saturn) results. Militia (Mars) ordered to the mines.

July, 1904, Pluto conjunction Uranus r: July 12—Sept. 8, strike of meat-packing employees in Middle West. July 25, strike of textile workers at Fall River, Mass. Radical activities are under Uranus. Collective bargaining is under Pluto.

June, 1915, Pluto trine Sun r: June 24, Secretary Daniels creates a general staff (Pluto) of the navy.

June, 1918, Pluto square Neptune r: June 3, treaty with Great Britain for reciprocal military service; citizens of either country resident in the other liable to conscription (Pluto rules conscription and Neptune rules involuntary servitude).

July, 1928; June, 1929; March, 1930; Pluto opposition Mars r, (not quite perfect in 1930), square Saturn r: The liquor racket reached its peak of lawlessness, gang slayings occurred daily, racketeers became dictators in politics, and the Federal Government was called upon to curb them when State authorities admitted themselves powerless.

June, 1934, Pluto opposition Venus r: In the U. S. a radical change in the NRA effort to fix prices and to compel shorter hours and collective bargaining. June 30, Dictator Hitler of Germany, without warning rounded up and had shot, Ernst Roehm, cabinet minister and chief in command of Hitler's troopers, together with more than 60 other leaders who were alleged to be implicated in a conspiracy. This mass (Pluto) execution was termed a "blood purge."

Neptune In Mundane Astrology

The most pronounced influence of Neptune is to exaggerate the hopes and expectations. He is thus the most active factor in promotion schemes, in vast undertakings of worldwide scope, in inflation of all sorts, and in socialistic and utopian enterprises.

Corporations of the type which draw together the capital of a large number of people in order to utilize it in business on a vast scale, and in which there is profit-sharing by many, come under his jurisdiction, as do colonies and enterprises in which many members share alike or on a pro rata basis.

He rules gas, aviation, moving pictures, and dramatic art through whatever medium it is expressed. On his adverse side, he is the particular patron of frauds, swindles, confidence men, graft, the watering of stocks, and all the more subtle methods by which, without violence, people are taken advantage of. On his better side he rules brotherly love and the ideal, mystical lines of thought, spiritual aspirations, and psychical research.

Pisces is the ruler of the natural 12th house, which relates both to crime and imprisonment. Neptune, as the ruler of Pisces, thus rules the more cunning nonviolent types of crime, and the various subtle forms of bondage. Kidnapping, as practiced by the violent methods of the racketeer, comes under Pluto; but involuntary servitude in general is ruled by Neptune. Slavery, drug addiction, undesired control by invisible forces, blackmail and other secret means by which people are kept in bondage are under his jurisdiction.

The table at the front of this lesson gives the charts of the eleven conjunctions of Jupiter and Neptune that have occurred since the year 1800, These charts, erected for Washington, D.C., reveal the influence of the things ruled by Jupiter (finances, commerce, religion, law) as they converge with the things ruled by Neptune, as affecting the U. S. The space at my disposal causes me to confine the events to those given in the brief outline in the back of Webster's New International Dictionary.

18. Jupiter Conjunction Neptune, Dec. 29, 1804, 11:35 a.m. The desire for commercial (Jupiter) and territorial expansion (Neptune) is fulfilled by the Lewis Clark expedition up the Missouri, down the Columbia to the Pacific, and return; giving a further foundation of claim to the Oregon country and the Northwest fur trade (conjunction in 8th).

19. Jupiter Conjunction Neptune, Dec. 24, 1817, 00:58 p.m. Dec. 10, Mississippi admitted as Slave (Neptune) State. Taken with Indiana the first clear case of admission of slave states in pairs (conjunction in house of government in a dual sign).

20. Jupiter Conjunction Neptune, Dec. 15, 1830, 4:52 a.m. Jan. 1, 1831, W. L. Garrison establishes the Liberator at Boston, as the organ of those who demand immediate abolition of slavery (Neptune). Mars, ruler of 1st, is sextile Uranus (freedom) in 3rd (periodicals).

21. Jupiter Conjunction Neptune, April 9, 1843, 1:31 p.m. John C. Fremont's warlike (conjunction in 7th) expeditions in the Far West furthers the ends of commercial (Jupiter) and territorial expansion (Neptune).

22. Jupiter Conjunction Neptune, March 17, 1856, 1:23 a.m. H. R. Helper, a Southern poor white, writes (conjunction in 3rd), and early in 1857 publishes, The Impending Crisis of the South, showing slavery (Neptune) to be a bad thing for the white laborer (Saturn in 6th, square conjunction).

23. Jupiter Conjunction Neptune, Feb. 26, 1869, 00:19 a.m. Feb. 27, the Fifteenth Amendment is submitted to the States; it (Mars, ruler of the first—the people—in the 9th—the law, trine the conjunction) declares that suffrage shall not be denied or abridged because of race, color, or previous condition of servitude (Neptune).

24. Jupiter Conjunction Neptune, June 18, 1881, 7:34 a.m. The conjunction is in the 10th (office and the president) with Saturn, and is trine to the ruler of the 8th (death). Mars is on the M.C. (president), sesqui-square Uranus, ruler of 8th (death). July 2, president Garfield is shot by a disappointed (Neptune rules exaggerated hopes) office seeker.

25. Jupiter Conjunction Neptune, June 1, 1894, 4:41 a.m. April 29, Coxey's Army of unemployed (conjunction in 1st, ruling the people) reaches Washington with a demand for the issue of \$5,000,000 paper money (exaggerated hopes).

26. Jupiter Conjunction Neptune, May 22, 1907, 6:43 a.m. May 22, New York legislature established a Public Utilities Commission (Pluto square Moon in 4th—utilities) to exercise control over public service corporations (conjunction in 1st—people, opposition Uranus and Mars in 7th—their exploiters); a policy also adopted by other states.

27. Jupiter Conjunction Neptune, Sept. 23, 1919, 8:46 p.m. Sept. 3, president Wilson starts on a nationwide speaking tour in behalf of unconditional acceptance of the League of Nations (conjunction on 4th—nations—exaggerated hopes of attaining an ideal).

333. Jupiter Conjunction Neptune, Sept. 18, 1932, 11 :30 p.m. The election (Moon ruling 1st—people, trine the conjunction) threw overboard (Uranus in 10th square Pluto in 1st) 250-year-old notions as to the relation of government (Neptune, ruler of 10th) to business (Jupiter) and to money (Moon, ruler of 2nd—money, trine the conjunction).

The Cycle of Neptune

Neptune crossed from south declination to north declination March 14, 1863. The most powerful aspect in the chart is Saturn opposition Neptune, Saturn representing property rights and the proverbial pound of flesh, and Neptune representing slavery, and on its better side the brotherhood of all men. The Keyword of the aspect is Separation, and the owners (Saturn) were separated from their slaves (Neptune).

Six weeks before the Cycle started, but well within the orb of its influence, on Jan. 1, 1863, Lincoln signed the Final Emancipation Proclamation as a war measure. Mars (war) in the chart is almost exactly trine Saturn and sextile Neptune. It is significant that the proclamation was signed by a man having Saturn conjunction Neptune on his Ascendant (see Lincoln's chart, lesson No. 105).

The Cycle of March 14 was a short one, as Neptune moved back south of the equator, and then again crossed to north declination Dec. 28, 1863 2:46 a.m. Washington. This Neptune Cycle Chart, which is still in force, is given at the front of the lesson.

The emancipation of the slaves remained merely a war measure until Neptune in the present Cycle came to the square of the Sun r, Feb. 1, 1865, when the adoption of the Thirteenth Amendment broadened its application to a peace time basis. Uranus, the planet of freedom is in the 8th house of this chart. Mars is ruler of the 6th (labor) and Dec. 18, 1865, the amendment was accepted by the States, when Neptune came trine Mars r.

The commencement of this cycle gave a tremendous impetus to mystical studies, to psychical research and to spiritualism. But as Pluto, ruler of Scorpio and thus of the natural 8th house, also governs information and influences from the dead, the Cycle of Pluto, commencing in 1864, was jointly responsible in these movements. It was out of psychical research, for instance, that, according to Col. Olcott, the Theosophical Society was founded in New York, Nov. 17, 1875. Pluto was trine Venus r in the Pluto Cycle.

At this time human reincarnation was not a tenet of the society, but when in the Neptune Cycle, Neptune came semi-square Neptune r, in October, 1882, Mr. Sinnett published in the Theosophist, Vol. IV, No. 1, the basis of the doctrine of human reincarnation.

Quoting from The World Almanac: “June 12, 1926, at London the young Indian Krishnamurti was accepted as the ‘world teacher’ by the Theosophical Society at its annual convention in Queen’s Hall.” Neptune (world-wide schemes) sextile Uranus r (independence), from the 10th (governing authority). The authority conferred upon him enabled Krishnamurti (who has Uranus prominent in his birth chart) later to disband the secret (Neptune) section of the society.

The Brotherhood of Light, in its object to cooperate for universal welfare, and as an organization which in no activity is secret, comes chiefly under the spiritual side of Pluto. Its teachings were first given wide publicity in modern times through the publication, in 1889, when in the Pluto Cycle, Pluto was sextile Neptune r and trine Mercury r, of Light of Egypt, Vol. I., by T. H. Burgoyne (his chart is in present edition of lesson No. 39). Volume II, compiled after his death is less authentic. Both volumes are now out of print.

May, 1915, B. of L. commenced its public work with headquarters at Los Angeles: Pluto trine Sun r, in Pluto Cycle.

Nov. 11, 1918 B. of L. opened membership to general public, and thus expanded (Neptune) its influence: Neptune trine Mars r from the 9th (religion), in Neptune Cycle, a few minutes more than one degree distant.

Nov. 2, 1932, united opposition of orthodox churches (Pluto opposition Venus r in Pluto Cycle) made it advisable to incorporate (Neptune trine Pluto r in Neptune Cycle) as The Church of Light, that our Religion (Major Conjunction of Jupiter and Neptune on Sept. 18) might not be at a legal disadvantage.

This is all the space that can be devoted to spiritual trends, and I shall, therefore, use such room as is left to more material events which have been influenced by the Neptune Cycle.

Industrial combinations and the movement toward trusts (Neptune) date from the Neptune Cycle of 1863. Certain pools (Neptune), as of the cordage industry were formed in the ‘60s; but immediately after the Cycle started the Michigan Salt Association was organized, and in the year of the Cycle Commodore Vanderbilt engineered a Wall Street coup of typically Neptune character, by which he annexed the Harlem Railroad as a first step in consolidation (Neptune).

1864, stimulated by the new Cycle, two far reaching international organizations were conceived. In 1864 the International Red Cross (Neptune trine Mars in the Cycle Chart) was organized at Geneva, and the same year the Marxian Socialists (Neptune) organized an “International” at London.

1867, Neptune semi-sextile Pluto r: Commodore Vanderbilt formed the New York Central out of previous consolidations.

1868, Neptune (ruler of 5th-speculation) opposition Saturn r (co-ruler of 3rd-railroads). “Watering stocks” became so common that the railroads were accused of increasing securities 150%, all water (inflation).

1870, Neptune (ruler of 5th-speculation) opposition Saturn r (ruler of 4th-underground products). Jan. 2, Standard Oil Company is chartered in Ohio. Vanderbilt makes further combinations.

1879, Neptune inconjunct Mars r: Original Trust Agreement of Standard Oil bears the date April 8, 1879.

1881, Neptune square M.C. r: The Kentucky Distillers form a gigantic trust in May.

1882, Neptune in seventh (international) inconjunct Saturn in twelfth (hospitals and relief work): Largely through the energy of Clara Barton, U.S. ratifies the Geneva Convention and becomes member of International Red Cross.

1884, Neptune semi-sextile Uranus r: Latter part of year American Cotton Oil Trust is formed.

1890, Neptune sesqui-square Mercury r, ruler of the 11th (Congress): Sherman Anti-Trust Law adopted.

1902, Oct. 1, Neptune square Neptune r: International Mercantile Marine Co., controlling 114 steamers, is formed with capital of 120 million dollars.

1903, Neptune square Neptune r: International Harvest Co. obtains control of smaller companies.

1917, Jan. 22, Neptune trine Neptune r: Supreme Court in Blue Sky Cases upholds the rights of States to guard against questionable stock and bond dealers and fraudulent securities.

Chapter 3

Serial No. 143
Original Copyright 1936
Elbert Benjamine

Copyright
August 2002
Church of Light

The Cycles of Uranus

Chapter 3

The Cycles of Uranus



WHILE the paramount influence of a progressed aspect in any cycle chart relates to those things which are ruled by the planet for which the cycle chart is erected, the manner in which those things affect the destiny of groups of people requires the consideration of other factors. Thus in making a prediction as to the exact nature of the events which will transpire when a given progressed aspect is formed in any cycle chart, there are four distinct factors, although by no means of equal importance, which require consideration.

Four Factors Determining the Events Attracted by a Progressed Aspect

In a cycle chart the only planet that progresses and forms aspects to the other planets is the planet for which the cycle chart is erected. That is, in the Uranus Cycle, all the other planets are considered only as they appear in the cycle chart. But Uranus moves forward, at the rate shown by its positions in the ephemeris, to make aspects with the positions occupied by the other planets in the cycle chart. In the Saturn Cycle, in a like manner, only Saturn moves forward to make aspects to the positions of the planets in the Saturn Cycle chart.

When in any cycle chart an aspect from the planet for which the cycle chart was erected forms to the position of a planet in that cycle chart, the event indicated is determined from the following four factors, which are here given in the order of their importance.

1. THE PLANETARY CYCLE

We do not expect the Uranus Cycle to reveal the influence of orthodox thought, land and basic utilities, or the miner and farmer; because these things come under the rule of Saturn. But we do expect it to show the strong influences of ultra-progressive thought, of invention and complicated mechanical devices, and of radical politics.

That is, the things ruled by the planet for which the cycle chart was erected are always to be considered as in some manner the active agents which bring the indicated event to pass.

For instance, in the current Uranus Cycle chart, given at the front of this booklet, there are three planets in the 12th house in Pisces. When Uranus moves forward into Taurus it will form the sextile aspect to each of these three planets. The events which will then come to pass, coincident with these progressed aspects, will all show the influence of those things which Uranus rules.

2. HOUSE OCCUPIED BY PLANET RECEIVING ASPECT

When an event comes to pass it relates chiefly to some particular department of life. Commonly the department of life affected stands out with even greater clearness than does the agent which brought the event to pass. And the department of life thus affected is chiefly to be judged from the house occupied by the planet receiving the aspect.

Thus in the present Uranus Cycle chart, as the Sun, Moon and Mercury are all three in the 12th house, when Uranus moves forward into Taurus and one after another forms the sextile aspect to each of these planets, the effect will chiefly be felt in the 12th house. As the 12th house rules prisons, hospitals, asylums, relief work, crime, etc., the events of outstanding importance attracted by these three progressed aspects will relate to these things.

Lesson No. 142 gives a rather complete list of the things which in mundane astrology are ruled by each of the twelve houses. When, therefore, a progressed aspect forms in any cycle chart, the house occupied by the planet receiving the aspect indicates, according to the things there listed as under the rule of the house, those things which will most pronouncedly be affected by the progressed aspect.

To a much less degree things will also be affected which are ruled by the houses on the cusp of which is a sign ruled by the planet receiving the aspect. For instance, in the current Uranus Cycle chart, the Sun is in the 12th, but rules the cusp of the 6th. When Uranus makes the sextile aspect to the Sun, therefore, 12th house affairs will chiefly be affected; but in a less pronounced degree labor, and other things ruled by the 6th house, will also be influenced.

3. SPECIAL AFFINITY OF THE PLANET RECEIVING THE ASPECT

Observation has shown that each of the planets has such a close affinity with certain things that, no matter what house of the cycle chart it occupies, when it receives a progressed aspect from the planet for which the cycle chart was erected, there is a pronounced effect apparent where these things are concerned. Next to the house occupied by a planet, as indicating the event which may most confidently be expected, there should be considered this special affinity.

As a matter of actual practice, in our mundane astrology class where the events for each day of the week ahead are forecast, and the more important events for years ahead are predicted, with later newspaper headline verification; predictions are made first as to the events affected, as shown by the house position, and then other predictions are made merely from the natural affinity of the planet aspected. These

classes which have been in existence for a great many years fully warrant at least two predictions from each progressed aspect; one based on house position, and the other, usually of less consequence, based upon the special affinity of the aspected planet.

These special affinities, which are derived from observing the verifications of day by day predictions over a period of many years in actual class work, rather than from what might logically be expected, are here listed in a manner to facilitate reference as follows:

SUN.—A progressed aspect to the Sun in a cycle chart, regardless of the house it occupies, tends to events in which those in power, particularly those high in politics, are affected.

MOON.—A progressed aspect to the Moon in a cycle chart, no matter what house it is in, tends to affect a large number of people.

MERCURY.—A progressed aspect to Mercury in a cycle chart, irrespective of the house it occupies, tends to give rise to much talk, and usually to controversy.

VENUS.—A progressed aspect to Venus in a cycle chart, regardless of the house it occupies, tends to events which affect women.

MARS.—A progressed aspect to Mars in a cycle chart, whatever the house it holds, tends to strife, violence and accidents.

JUPITER.—A progressed aspect to Jupiter in a cycle chart, irrespective of the house it is in, tends to events affecting finances. Under such an aspect the trend is toward expansion, expenditures and higher prices.

SATURN.—A progressed aspect to Saturn in a cycle chart, no matter what house it occupies, has an influence over labor and tends toward contraction, economy, loss and lower prices.

URANUS.—A progressed aspect to Uranus in a cycle chart, regardless of the house it holds, tends to bring radical activities and to bring an expose.

NEPTUNE.—A progressed aspect to Neptune, whatever house it may be in, tends to events affecting aviation and the moving picture industry.

PLUTO.—A progressed aspect to Pluto, regardless of the house it occupies, tends to bring events in which drastic action and cooperation of some kind play a part.

4. HOUSE OCCUPIED BY PROGRESSING PLANET

At the time the aspect is complete, the house occupied by the planet for which the cycle chart was erected cannot be ignored. In the cycles of the more slowly moving planets it is of much more consequence than in the cycles of the swifter planets. Sun or Moon, for instance, move so rapidly through a house that commonly the things denoted by that house are not strongly affected when the luminary makes a progressed aspect.

Those without experience are apt to conclude from their observation of progressed aspects in natal astrology that the house occupied by the progressing planet in a cycle chart should be as strongly affected as the house occupied by the planet in the cycle chart receiving the aspect. Such is not the case, however, and while predictions at times can accurately be made from the house occupied by the planet for which the cycle chart was erected, at the time it forms progressed aspects, predictions from this fourth, and least important factor, should be made with considerable reserve.

Thus in the seven years—1935 to 1942—during which in the current Uranus Cycle chart Uranus passes through the 2nd house, every aspect Uranus makes to the position of a planet in the cycle chart will tend to have some influence on money. But such influence on money at times will be greatly subordinate to the influence on the things ruled by the house occupied by the aspected planet, and even to the things which have a special affinity for the aspected planet.

Uranus in Mundane Astrology

Uranus is the planet of extremes and of unexpected happenings. He loves the new and the unusual, and hesitates not at all to discard the tried and trusted methods in favor of more original plans. Or if some new plan has been in operation, and has not proven entirely satisfactory, he influences the pendulum of public opinion to swing far in the other direction, and a demand arises that there should be a return to methods so old as to have been considered obsolete.

Two sets of things Uranus dislikes. He dislikes the usual things, and he dislikes things as they are. Whatever now exists, if it has been in existence some time, he wants changed, and is ready with something new and original to take its place.

He is the planet of rugged individualism, abhorring restraint of any kind. He likes to be a law unto himself and to feel that he is the equal of any man He is, therefore, the planet of liberty, and his influence in slavery as an issue was even more pronounced than that of Neptune, and as he favors direct action, was marked by more violence. Against economic oppression he feels equally rebellious, inciting to unrest, dissatisfaction and disruption.

Ruler of Aquarius, the sign of altruism, he is ever active to better the condition of the working man. Nor is he gentle in making his demands for different conditions. His influence is to be witnessed in most of the exposures of graft and corruption and in practically every effort that has been made by strikes, by forming unions, or by other means to shorten the hours, increase the pay, and make better living conditions for those who toil.

His is the method of direct action, applying whatever pressure and resorting to whatever violence is necessary to attain his ends. He is thus the planet of revolution. The chief reason why the strikes, boycotts and riots he incites so often fail is because he is so great an individualist that there is not the proper unity of action. Those undertaking to force a change by which they hope to better their conditions become dissatisfied with their leaders. New leaders spring up with still other plans, and the dissension within the organization leads it to block its own purposes.

Labor unions in their objects and the methods employed, such as strikes, are under the influence of Uranus. But to the extent there is actual cooperation of its members to accomplish a group purpose the influence of Pluto is apparent.

Reform movements of all kinds are under the influence of this planet. In thought he leans to the occult and ultra-progressive; in business to invention and unusual methods; and in politics to that which is considered radical. When, therefore, in a given city or country, a cycle chart brings a strong influence from Uranus to bear upon events, radical activities are brought to the attention, efforts are made to expose existing corruption, and important changes are advocated.

Nor does the matter merely stop with agitation if those advocating the change are strong enough to enforce their desires; for he is a planet of quick action as well as of flaming oratory. When, therefore, his influence is sufficiently strong, events which change the entire complexion of the things influenced come to pass with cataclysmic suddenness.

Calculating the Uranus Cycles

For the purpose of illustrating the method of calculating the time for which a Uranus Cycle chart should be erected, we will use the short cycle of Uranus of May 1, 1927, and the present cycle of Uranus which started Feb. 21, 1928. As we wish to know the influence of the Uranus Cycle on the affairs of the United States, the problem is to ascertain the time at Washington, D. C., when Uranus crossed from south declination to north declination.

The Nautical Almanac for 1927 gives the declination of Uranus at four day intervals for Greenwich Civil Time (commencing at midnight). The position on May 3 is given as plus 0 degrees, 1 minute, 9.5 seconds. The variation per day is given as 66.03 seconds. That is, Uranus moving 66.03 seconds per day, on May 3 had already crossed into north declination 0 degrees, 1 minute, 9.5 seconds.

24 hours (one day) equal 1440 minutes. 0 degrees, 1 minute, 9.5 seconds equal 69.5 seconds. Then $66.03:1440::69.5:?$ The answer is 1516 minutes, which equal 1 day, 1 hour, 16 minutes.

From May 3 Civil Time subtract 1 day, 1 hour, 16 minutes, and it gives the Greenwich Time as May 1, 10:44 p.m. As Washington is 77 degrees west, subtract a further 5 hours, 8 minutes, which gives the time for which the Uranus Cycle chart must be erected as May 1, 1927, 5:36 p.m. L.M.T. 77W. 38—56N. The chart erected for the time so found is No. 31 in the table at the front of this booklet.

The Nautical Almanac for 1928 gives the declination of Uranus at four day intervals for Greenwich Civil Time (commencing at midnight). The position on Feb. 23 is there given as plus 0 degrees, 1 minute, 50.8 seconds. The variation per day is given as 75.24 seconds. That is, Uranus, moving 75.24 seconds per day on February 23 had already crossed into north declination 0 degrees, 1 minute, 50.8 seconds.

24 hours (one day) equal 1440 minutes. 0 degrees, 1 minute, 50.8 seconds equal 110.8 seconds. Then $75.24:1440::110.8:?$ The answer is 2121 minutes, which equals 1 day, 11 hours, 21 minutes.

From Feb. 23 Civil Time subtract 1 day, 11 hours, 21 minutes, and it gives the Greenwich Time as Feb. 21, 12:39 p.m. Subtract the time difference of 5 hours, 8 minutes, that Washington is west, and it gives the time for which the Uranus Cycle chart must be erected as Feb. 21, 1928, 7:31 a.m. L.M.T. 77W. 38—56N. This last Uranus Cycle chart, erected for this time, is illustrated at the front of this booklet.

The Short Uranus Cycle of 1927

Chart No. 31 is that of the short cycle of Uranus, which commenced, as above calculated, May 1, 1927, 5:36 p.m. Washington. During the time of this cycle Uranus made only three progressed aspects to the positions of the planets in this chart. Just before the cycle, but well within the orb of its influence, on April 7, 1927, television (new invention) was demonstrated at New York City.

In the chart, two angular houses hold planets, which indicates a volume of energy flowing into these departments of life. Neptune, the planet of aviation, holds forth in the house of honor (10th), and the Sun and Moon are conjunction in the house of foreign nations (7th).

In the chart Uranus is conjunction with the financial planet Jupiter in the 5th, house of speculation, and during the following eight months there were more stocks sold on the New York Exchange, and more people of small means reversed (Uranus) their previous policy and invested in such stocks, than during any previous period in history. Uranus is trine M.C., and the speculative wave increased in intensity as, turning retrograde, Uranus came exactly trine M.C. r on Oct. 15, 1927.

Uranus also, in its retrograde movement, made the conjunction with Uranus r, September 20. Many inventions and new devices were brought to the public attention about that time, and as the conjunction took place in the 5th house, wild speculative activities occurred near that date.

The most important influence of the cycle was over aviation. There were rapid developments in mechanical aids to aviation as the cycle came in, and adding aviation honors (Neptune in 10th) to his country, on May 20, 1927, Captain Charles Lindbergh (his birth chart and progressions are illustrated in Lesson No. 109) made his historic and record breaking flight from New York to Paris.

Two planets in the 9th house turned energy into attempts at long journeys by new (Uranus) methods. But as Mars in the 9th received the square of Uranus, most of the transatlantic flights attempted under this cycle of Uranus ended in disaster. Nevertheless, there were two other outstanding successes: the flight on June 28, from Oakland, California, to Hawaii by Maitland and Hegenberger; and the flight of Chamberlin and Levine on June 4 from New York to Germany.

As to the accidents of others in attempting long flights; May 23 the Italian Commander Pinedo was forced into the sea near the Azores. Commander Byrd, on June 29, flying to France, was forced down off the coast and his plane smashed. The entire crew of the English Fokker plane trying to make Canada were lost Aug. 31. The entire crew of the monoplane leaving New York to Rome on Sept. 6, were lost. Ruth Elder and her pilot, flying from New York, bound for Paris, were forced into the sea on Oct. 11. Numerous other accidents related to less outstanding long journeys also attested to the power of the 9th house affliction.

In the chart, Uranus makes a trine to Saturn, planet of economy, in the house of money (2nd). Paper currency had been of standard size for a very long time, but it was now in for a radical change. May 26, 1927, Secretary of the Treasury Mellon authorized the reduction of the size of paper money by about one-third, thus saving millions annually.

September 26, 1927, Uranus progressed to semi-square Moon r, in 7th (foreign countries). Well within orb of this influence, on Sept. 9, the U. S. sent a protest to France against the new tariff which brought the sale in France of millions of dollars worth of manufactured goods to a practical standstill, due to the quadrupling of duties. This was a matter of controversy until Nov. 21, when a temporary agreement was reached.

Uranus rules astrology, and the first National Astrological Convention was held at Hollywood July 21-23, 1927.

The Uranus Cycle Now Effective¹

The influence of the current Uranus Cycle, chart for which is illustrated at front of booklet, will be in effect from 1928 to 1969. According to the calculations previously given in detail, the chart is erected for Feb. 21, 1928, 7:31 a.m. 77W. 38N56.

Two planets in the house of Congress (11th) indicate that during this cycle Congress will be strongly influenced by radical ideas. Two planets in the house of the people (1st) indicate that the people in general will be greatly influenced by the things which Uranus rules, and as Uranus, ruler of the cycle, is conjunction Jupiter, ruler of business (10th) and co-ruler of transportation (9th), the destiny of the people will undergo a radical change due to the mechanization (Uranus) of industry and transportation. As Jupiter is the planet of finances, matters relating to the financing of the people will also undergo a radical change.

Three planets in the 12th indicate that crime and relief are matters which will become of paramount importance due to the influence of mechanical contrivances which aid crime and perform work previously done by men.

Instead, however, of presenting a detailed analysis of what may be expected from the chart, it will probably afford better practice to give a complete list of every aspect formed in the cycle up to the date (mid-1935) of this revision of the lesson, quoting (with comments in parentheses) from THE WORLD ALMANAC one event influenced by each aspect.

Feb. 22, 1928, Uranus semi-sextile Sun r: Feb. 21, Harry F. Sinclair, oil operator, is found guilty (Sun in house of crime) of contempt by Justice Frederick L. Siddons in the District of Columbia Supreme Court and sentenced to six months' imprisonment. This is in connection with the famous Teapot Dome expose (Uranus) of corrupt officials (Sun).

March 22, 1928, Uranus semi-sextile Moon r: March 22, at Washington, John D. Rockefeller, Jr., appears before the Senate committee investigating (expose) the bituminous coal industry, denying any direct knowledge of violating (Moon in house of crime) the Baltimore wage agreement.

May 12, 1928, Uranus conjunction Jupiter r: May 11, the Hoover manager, Ex-U. S. Congressman J. W. Good of Iowa, told the U. S. Senate campaign probe (Uranus) committee that about \$250,000 had so far been spent for the Hoover cause, and the whole fight may cost \$300,000 (Jupiter).

Sept. 15, 1928, Uranus conjunction Jupiter r.

Sept. 15, Illinois coal miners vote to accept the new wage (Jupiter) scale, effective Sept. 16, ending the soft coal strike (Uranus).

March 3, 1929, Uranus conjunction Jupiter r: March 1, the most important English and American firms operating in the British oil market—including Sir Henry Deterding's company (the Royal Dutch) —have agreed (a radical change) to establishment of normal trade relations (Jupiter ruler of house of business) with the Soviet Oil Corporation.

April 7, 1929, Uranus semi-sextile Mercury r: April 7, a post office employee (Mercury ruling house of post office) makes a "dud" bomb (Uranus), and then discovers it at New York City (Mercury in house of crime).

Nov. 13, 1929, Uranus semi-sextile Mercury r: Nov. 13, at Rochester, N. Y., Robert M. Searle, who rose from office boy for Thomas A. Edison to an outstanding figure in public utility circles, commits suicide (Mercury in house of self-undoing) after worrying over stock market losses.

April 26, 1930, Uranus sesqui-square Neptune r: April 26, after passing over Paris, the only German airship (Neptune) to visit the British capital (a radical change) since the armistice, receives welcome.

July 4, 1930, Uranus square Pluto r: July 9, police at New York City raid Earl Carroll's "Vanities" show (Pluto in 5th) on 42nd Street.

Aug. 6, 1930, Uranus square Pluto r: Aug. 9, dropping a bottle of nitroglycerin to the floor of the Stockyards National Bank at Ft. Worth, Texas, Nathan M. Martin, 30, kills (Pluto ruler of 8th, and of drastic action) himself and Vice-President F. L. Pelton.

Oct. 24, 1930, Uranus sesqui-square Neptune r: Oct. 24, Gilbert Lane, youngest American volunteer in the French Army and an active member of the Paris Post of the American Legion, is killed when a plane (Neptune) in which he had started for Abyssinia to take motion pictures (Neptune) of the Emperor Haile Selassie crashed (Uranus) at Le Bourget Field.

Feb. 14, 1931, Uranus sesqui-square Neptune r: Feb. 14, Senate and House adopt the Interior Department bill, carrying an appropriation of \$20,000,000 for loans for farm rehabilitation, inclusive of food supplies (Neptune in the house of foods and farm products) for humans, and the President signed the measure.

April 4, 1931, Uranus square Pluto r: April 9 Fred J. Blumer, a brewer, is kidnapped (Pluto) at Monroe, Wis., and \$150,000 ransom is demanded.

April 29, 1931, Uranus semi-square Sun r: April 26, Jack "Legs" Diamond is shot at a roadhouse near Cairo, N. Y. Governor Roosevelt sends 20 state troopers and a deputy attorney general to Cairo to clean out (Uranus) the beer runners and racketeers (Sun in house of crime).

May 28, 1931, Uranus trine Saturn r: May 29, at New York City the first train (Saturn in 9th) is run in Nassau Street, from B.M.T. station under the Municipal Building at Chambers Street to Broad Street.

June 2, 1931, Uranus semi-square Moon r: June 1, Albert B. Fall, former Secretary of the Interior, convicted of bribery (Moon in house of crime) in accepting \$100,000 from Edward L. Doheny, prominent oil operator, is denied a review of his case by the Supreme Court of the U. S. (Uranus exposes graft).

Sept. 18, 1931, Uranus semi-square Moon r: Sept. 18, at Albany, N. Y., the Legislature ends its special session after passing the Wicks unemployment relief (Moon in 12th) bill, amended to suit Governor Roosevelt, and the anti-crime (Moon in 12th) measures desired by the New York City authorities.

Sept. 24, 1931, Uranus trine Saturn r: Sept. 23, U. S. Government investigation (expose of graft) into alien smuggling at Ellis Island has resulted in 861 deportations (Saturn in house of ocean journeys) and 26 arrests.

Oct. 29, 1931, Uranus semi-square Sun r: Oct. 28, President Hoover's Organization on unemployment relief (Sun in 12th) reports ten things essential.

Feb. 17, 1932, Uranus semi-square Sun r: Feb. 16, Sheriff Thomas M. Farley, of New York City, is given a public hearing (expose) at Albany by Gov. Roosevelt on charges (Sun in house of crime) made by Samuel Seabury, counsel of the legislative committee which is investigating the New York City Government (Sun).

March 17, 1932, Uranus trine Saturn r: March 17, a passenger plane (Saturn in house of journeys) bound from Phoenix, Ariz., to Los Angeles, Calif., crashes in a fog in San Gorgonio Pass, near Calimesa. Six of the occupants are killed at once and the seventh died soon afterwards.

March 21, 1932, Uranus semi-square Moon r: March 22, three residents of Norfolk, Va.—John Hughes Curtis, Rear Admiral Guy Burrage and Rev. Dean Dobson-Peacock—informed Colonel Lindbergh they had been in communication with the kidnapers (Moon in house of crime) and assured him they had been told the baby was being held, “somewhere in Chesapeake Bay.”

June 24, 1932, Uranus semi-square Mercury r: June 22, at New York City, a Supreme Court jury, at the judges' direction, acquit Isidore J. Kresel of a charge of perjury (Mercury in house of crime) growing out of the failure of the Bank of the United States.

Sept. 2, 1932, Uranus semi-square Mercury r: Sept. 4, Raymond Robins, prohibition advocate and reformer (Uranus), vanishes (Mercury in 12th) from New York City on his way to keep an appointment with President Hoover at Washington.

April 5, 1933, Uranus semi-square Mercury r: April 4, the U. S. dirigible balloon Akron, biggest on earth, sank in the ocean at about 12:30 a.m. off Barnegat, N. J., in the midst of a storm of wind (Mercury), rain and lightning (Uranus).

April 16, 1933, Uranus trine M.C. r: April 19, President Roosevelt orders an embargo on all exports of gold (Business ruled by M.C.) except that earmarked for foreign countries.

May 11, 1933, Uranus square Mars r: May 12, Wisconsin milk strike (Uranus) goes into effect.

Oct. 31, 1933, Uranus square Mars r: Nov. 1, at North Tiverton, R. I., 1,500,000 gallons of gasoline explode (Mars and Uranus) killing 4 workmen.

Dec. 22, 1933, Uranus trine M.C. r: December 28, at Washington, Henry Morgenthau, Jr., Acting Secretary of the Treasury, issues an order calling in all the remaining gold coin, bullion and certificates still outside the Treasury of the Federal Reserve banks and their members (M.C. affects business). The order eliminates the \$100 exemption heretofore allowed to individual hoarders of gold and imposes (extreme of Uranus) a new penalty of double forfeiture.

Jan. 13, 1934, Uranus trine M. C. r: Jan. 15, President Roosevelt asks Congress for authority to impound all gold (affecting business ruled by M.C.) in the Treasury and devalue the dollar to a maximum of 60 cents and a minimum of 50 cents. Bill passes House Jan. 20.

March 2, 1934, Uranus square Mars r: March 3, John Dillinger, the outlaw, and a Negro escape from jail at Crown Point, Indiana, and commence a series of crimes of violence (Mars) unparalleled in the 20th Century.

April 23, 1934, Uranus trine Neptune r: April 21, the bill for the compulsory control of cotton (Neptune in 6th, house of farm produce) is signed by the President.

May 9, 1934, Uranus square Venus r: May 4, the U. S. House (Venus in House of Congress) passes the Stock Exchange Control bill (very severe).

Nov. 13, 1934, Uranus square Venus r: Nov. 12, the U. S. Treasury grants a blanket License authorizing all transactions in foreign exchange, transfers of credit and exports of currency (Venus rules house of money), other than gold certificates but including silver coins.

Dec. 15, 1934, Uranus trine Neptune r: Dec. 15, Labor (Neptune in house of labor) and Business propose recovery measures as Ickes Board recommends lasting program of Public Works and use of resources.

Jan. 27, 1935, Uranus trine Neptune r: Feb. 2, House passes work-relief (Neptune in house of work) bill of \$4,880,000,000.

Feb. 26, 1935, Uranus square Venus r: Feb. 26, eighty girls (Venus) from Vassar, descended upon Albany by bus and taxi, grabbed the fleeing coat tails of surprised State Senators (Venus in house of senators) and launched a vigorous protest against the Numan-Devany student oath bill.

April 26, 1935, Uranus sextile Sun r: April 27, breach between Senator Long (Sun rules politicians) and his "Share the Wealth Plan" (Uranus p in house of money) and the Administration widens.

May 21, 1935, Uranus sesqui-square Saturn r: May 21, Representative Dobbins, of Illinois, proposes a resolution in the House which would require a two-thirds majority of the Supreme Court (ruled by 9th) in declaring any act of Congress to be unconstitutional.

May 24, 1935, Uranus semi-square Asc. r: May 25, for the first time (Uranus p in house of money) since March, 1911, the Treasury Department has offered bonds to be sold on a competitive basis. The money is needed to start financing the \$4,880,000,000 work-relief (affecting many people, ruled by Asc.) program.

May 25, 1935, Uranus sextile Moon r: May 24, five thousand persons (Moon) clamor for the 553 seats in the House galleries to see the spectacle no American has ever seen before—a president of the U. S. delivering a veto message to Congress in person. The measure vetoed is a relief (Moon in 12th) measure affecting World War veterans.

The Uranus Cycle of 1844

This Cycle of Uranus, which was in force from 1844 to 1927, started March 11, 1844, 7:30 a.m., Washington, D. C. The chart is illustrated at the front of this booklet.

The planet of drastic action, Pluto, and the planet of war, Mars, as well as Venus, occupy the house of the people (1st) in this chart, foreshadowing the Civil War. The cause of dissension is indicated by Uranus, the planet for which the chart was erected, exerting its disruptive influence in the house of slaves (12th). Three planets in this house give its affairs great importance. And as there are three Planets also in the House of Congress (11th), what this legislative body does is also of unusual importance.

Mars, the planet of machinery in the 1st, semi-sextile Uranus, planet of invention and new machines, heralds the mechanization of industry. The Moon in the 9th indicates the changes in methods of transportation brought about by new inventions.

Instead of listing every aspect Uranus makes by progression through the many years this cycle exerted its power, let us, commencing with the date the cycle started, select every event mentioned in the Reference History of the World of Webster's New International Dictionary, which clearly bears the nature of Uranus, in so far as there is space here yet available, and indicate the aspect in the cycle which coincided with, and affected, the event.

The first outstanding event under this Uranus Cycle was on May 24, 1844, with Uranus semi-sextile Mars r, when the magnetic telegraph (electricity is ruled by Uranus), invented by S. F. B. Morse, is first brought into practical use. The experimental work has been conducted under the influence of the cycle, and when the planet of construction (Mars) is aspected, the Federal Government having provided the funds for building a line between Baltimore and Washington, telegraphy comes into use.

Under the same aspect, Uranus semi-sextile Mars r, there is another invention which proves important, enabling us to ride comfortably in our autos today. June 15, 1844, Charles Goodyear patents (Uranus) the process of vulcanizing (Mars) rubber.

The next event relates to that freedom for which Uranus always struggles. August 8, 1846, under Uranus (still in house of slaves) semi-square Mercury r (in house of Congress), the Wilmot proviso passes the House. It prohibits slavery in any territory acquired from Mexico.

Sept. 10, 1846, under Uranus semi-sextile Jupiter r in the 12th (slavery) Elias Howe patents (Uranus) the sewing machine, freeing women from much drudgery. Uranus strives for economic, domestic, and political freedom, as well as from other types of restriction.

In 1847, under Uranus semi-square Mercury r, Richard M. Hoe invents the rotary printing press, thus greatly facilitating the distribution of news (Mercury ruler of 3rd).

Jan.-March, 1849, under Uranus trine Moon r, there is a struggle in Congress over the organization of the new territory (Moon ruler of 4th, house of territory), the South claiming the extension of the 36—30 line to the Pacific, thus dividing California.

Sept. 18, 1850, under Uranus semi-sextile Uranus r in house of slaves (12th) and Uranus sextile Mercury r, in house of Congress (11th), a new and drastic Fugitive Slave Law, intended to check organized assistance to fugitives, is passed; and on Sept. 20, slave trade is forbidden in the District of Columbia.

May 26, 1854, under Uranus sextile Jupiter r, in house of slaves, during the Burns fugitive slave incident in Boston the attempt is made by an antislavery mob to storm the courthouse. Also several new personal liberty (Uranus) laws are passed by Northern States in an attempt to hinder the operation of the Federal laws of 1850, and the Kansas-Nebraska Act of May 30 starts another controversy over slavery that is not settled until the Civil War.

May 5, 1857, about 6 weeks after Uranus makes the perfect square to Neptune r, co-ruler of the house of slavery, the Supreme Court, deliberating the Dred Scott Case, delivers the decision of the majority of the court, declaring the Missouri Compromise to have been always unconstitutional, as contrary to the rights of any man to take “slave” property into a Territory. The decision is contrary to the popular sovereignty theory of the Kansas-Nebraska Act and opens all territory to slavery (Neptune rules slavery).

Nov. 7, 1857, under Uranus semi-square Jupiter r, in house of slaves, a pro-slavery convention in Kansas frames the Lecompton Constitution, which is so worded as to permit slavery either directly or indirectly, no matter how the settlers vote.

May 4, 1858, under Uranus square Mercury r, in house of Congress, the English Act of Congress adjusts the Kansas difficulty and marks the high-water in the pro-slavery Congress.

March 7, 1859, when Uranus again made the square to Mercury r (planet of controversy), the Supreme Court declares that the fugitive slave law of 1850 is unconstitutional and that the jurisdiction over it is entirely in the Federal Courts, and that efforts of the States to obstruct it are illegal.

Oct. 16-18, 1859, under Uranus semi-square Pluto r (planet of mobs), occurs John Brown's raid at Harper's Ferry, Va. Nineteen abolitionists seize the government arsenal as an armed position to which slaves may rally.

June 19, 1862, under Uranus (planet of freedom) semi-square Uranus r (in house of slaves) Congress abolishes slavery in the Territories.

Sept. 22, 1862, under Uranus (planet of freedom) opposition Moon r, ruler of 4th (States), Lincoln in his Preliminary Emancipation Proclamation states as a war measure that he will on Jan. 1, declare free all slaves in the States then in rebellion, excepting certain loyal or occupied sections.

Jan. 1, 1863, under Uranus sesqui-square Saturn r, there is the Final Emancipation Proclamation.

June 13, 1866, under Uranus inconjunct Saturn r, the Fourteenth Amendment is passed and sent to the States, providing that Negroes and all others born or naturalized in the U. S. are to possess equal civil (Saturn ruler of 10th) rights.

June 25, 1868, under Uranus trine Jupiter r (more pay for shorter hours) an act is passed to establish an eight-hour day for laborers for the Federal Government.

Dec 10, 1869, under Uranus trine Sun r (planet of politics), Wyoming, the first territory to do so, adopts woman's suffrage.

1871, under Uranus inconjunct Neptune r, and later square Venus r, the Tweed Ring, which for years had controlled and systematically bled New York, and had embezzled about \$100,000,000, is overthrown.

1874, under Uranus inconjunct Jupiter r, ruler of the house of publishing, that great boon to all who write, the typewriter, is placed on the market, the Remington being the pioneer machine.

March 2, 1875, under Uranus inconjunct Jupiter r (in house of graft), scandals in the Grant administration cause the resignation of Secretary of War Belknap. In addition, a whiskey ring to defraud the internal revenue (Jupiter) is exposed (Uranus).

March 7, 1875, under Uranus inconjunct Jupiter r, ruler of 9th (long distance communication) Alexander Bell patents the telephone.

1877, under Uranus trine Pluto r, Edison invents the phonograph, although it is not made practical until 1888.

1878, under Uranus trine Venus r, opposition Mercury r, planet of education, a great help to reading and writing, the Brush electric arc light, forerunner of electric lighting, is invented.

1879, under Uranus trine Mars r, ruler of incandescence, Edison invents the incandescent electric light.

1884, under Uranus opposition Uranus r, ruler of electricity, electric trolley street cars are operated in Kansas City.

1886, under Uranus in the house of labor, inconjunct Mars r, planet of strife, there are great labor disturbances, the Knights of Labor endeavoring to force an eight hour day. In March under this aspect they promote the great strike on the Gould system of railroads in Missouri and neighboring states, which fails after lasting until May. Then May 4, occurs the anarchist riots in Chicago, following a strike there.

September, 1888, Uranus progresses from the house of labor into the house of arbitration (7th) making the opposition to the Asc. r (people), and on Oct. 1, Congress authorizes the appointment of a commission of voluntary arbitration between interstate railroads and their laborers.

July 2, 1890, under Uranus trine Neptune r (planet of restrictions), the Negro question having arisen, the House passes the Force Bill to protect the Negro voters of the South, but the Senate shelves it.

Nov. 1, 1890, under Uranus trine Mercury r, in the house of legislation, Mississippi adopts a new constitution, the first to restrict suffrage through the "Understanding clause."

1892, during the summer while Uranus was opposition Mars r, planet of strife, the country is affected by strikes accompanied by violence.

1893, under Uranus sesqui-square Sun r, ruler of 5th (entertainment), Edison develops the kinescope, starting the revolution (Uranus) in entertainment with the first motion picture.

June 26—July 14, 1894, under Uranus trine Jupiter r, ruler of 9th (interstate commerce), the strike of the American Railway Union starts at Chicago with the refusal to handle Pullman cars because of a strike of laborers in a Pullman factory. Strike extends all over West, accompanied by much rioting and completely stops transportation on 50,000 miles of railroads. Debs and other strike leaders are arrested on Federal injunctions for interference with interstate commerce and carriage of the mails. Local troops are called out in many places, and President Cleveland, without waiting for requests from State executives, employs Federal troops, especially at Chicago, to protect railroads. Strike fails.

1895, under Uranus semi-sextile Moon r, in 9th, the automobile comes into practical use, thus commencing a revolution (Uranus) in transportation which threatens the railroads not merely in short hauls, but also in interstate commerce (9th).

May 27, 1895, under Uranus semi-square Uranus r, the Supreme Court declares that an injunction to prevent strikers from interfering with interstate commerce or the movement of the mails is a legitimate means of exercising the power vested in the United States.

1896, under Uranus semi-sextile Moon r in 9th (interstate transportation) Rural Free Delivery is started in a small way and quickly develops into a great system. (Uranus favors government ownership of public utilities as a method of preventing exploitation and graft.)

Jan. 1, 1898, under Uranus trine Uranus r, the eight-hour day becomes an issue.

Feb. 18, 1898, under Uranus trine Saturn r, the Supreme Court rules that a State regulation for an eight-hour day for certain classes of mining (Saturn) employees, with emergency exceptions, is a proper police regulation for the protection and health of citizens and not contrary to the Fourteenth Amendment.

May 28, 1898, under Uranus trine Uranus r, the Supreme Court declares that native citizenship under the Fourteenth Amendment is without respect to race or color; a child born in the U. S. of resident parents is therefore a citizen and cannot be excluded under the Chinese Exclusion Act.

Chapter 4

Serial No. 144
Original Copyright 1936
Elbert Benjamine

Copyright
August 2002
Church of Light

The Cycles of Saturn

Chapter 4

The Cycles of Saturn



IN A CYCLE CHART, the house occupied by the planet for which the chart is erected becomes unusually important as indicating the starting point from which the influence emanates which brings about the most important events which transpire during the life of the cycle. Thus in the Neptune Cycle, illustrated at front of Lesson No. 142 (See Serial Lesson Key), Neptune is in the 11th house. This indicates that Congress becomes an influence through which the most important events signified by the cycle are brought to pass. That is, the things which Neptune rules are shown to be so closely associated with Congress that from December 28, 1863, until March 7, 1944, Congress will have a tendency to bring those things to pass which the chart as a whole indicates, and which specifically are timed and denoted by the progressed aspects of Neptune to the planets.

In the Uranus Cycle of 1844, illustrated at front of Lesson No. 143 (See Serial Lesson Key), Uranus is in the 12th house. This indicates that, until the next cycle started in 1927, bondage and limitations would be the things which Uranus would operate through to bring about the most important events. Slavery of the Negro was the earlier issue, and economic bondage was the later one. And Uranus being the planet of disruption, the influence of slavery and of economic exploitation brought sudden changes.

In the Uranus Cycle of 1928, illustrated at front of Lesson No. 143 (See Serial Lesson Key), Uranus is in the 1st house. This indicates that, from February 4, 1928, until April 1969, the starting point from which Uranus will exert its most important influences will be the condition of the common man. The common man is so closely associated with Uranus things in this chart that he can not fail to be the instrument through which abrupt changes will be brought to pass. Wherever Uranus progresses by Transit through this chart and makes an aspect to some planet in it, he will continue to carry some of the first house influence, the influence of the common people, and the more important radical changes will be brought about by, and affect the interests of, the masses.

In the Saturn Cycle of 1922, illustrated at front of this lesson, Saturn is in the 8th house. Death, Taxes, Debts, Pensions and Insurance, therefore, are so closely associated with Saturn that wherever he goes through the chart they will continually be bobbing up in connection with the most important events this planet brings to pass from March 2, 1922, until March 5, 1938.

Not all of the aspects he makes will bring things to pass related to the 8th house; but he carries enough of this influence with him that the most important events influenced by the things he rules will in some manner relate not merely to the house in which the aspected planet is located, but also will relate to those things which the 8th house rules.

Saturn in Mundane Astrology

Saturn is the planet of safety, economy and poverty; hence his most characteristic influence is to contract and depress. He is over cautious, and frequently lets golden opportunities pass him by through lack of courage to attempt.

He, as well as Jupiter, is a business planet, and has an influence over the business trend in a country; but where Jupiter tends to expansion, and when afflicted causes extravagance, Saturn tends to contraction, to over cautiousness, and to measures of protection.

Diseases in general are under his influence, as are sanitary and other measures taken to protect the public health. In fact, action of all kinds which is prompted by fear, and has for object protection, comes under his dominion. When afflicted he is responsible for various kinds of losses, including the loss of public health which occurs during an epidemic.

His nature is in direct opposition to that of Uranus in that he is the planet which is most conservative, and most persistently resists change of any kind. The things which were good enough for his father and grandfather are good enough for him. He fears the effect of anything which has not withstood the trials of time. In financial matters, his influence following the boom periods of Neptune or the extravagances of an afflicted Jupiter, leads to a time of depression. Jupiter and Saturn together are chiefly responsible for the rise and fall of markets. and the periods of business advance and the periods of business recession.

Saturn rules the land, the buildings on the land, the crops which grow from the soil, the mineral wealth under the ground, and basic utilities like steel, lumber and coal. He also has chief influence over the weather. The destruction of crops and buildings, therefore, through flood, storms, and when Mars plays a part even through fire, comes under his jurisdiction.

Hard work and those who perform it in general, and the miner and farmer in particular, are influenced by him. Hence measures to protect them, such as immigration laws which have for object the protection of those who work from an over abundance of laborers; and tariffs that are placed upon goods, not chiefly as a means of revenue, but to protect from the competition of cheap foreign labor, come under his rule. Some caution is here required in passing judgment on tariffs, however, as those which are designed chiefly as means of raising revenue come under the rule of Jupiter.

Furniture, fixtures of all kinds, and the crude materials from which other things are made, natural resources, and all movements toward conservation, are under Saturn's rule. And because he is so closely associated with the land, all acquisition of territory, bargaining for it, or its loss, relates to his influence. In his thought he is ultra-conservative, in his religion strictly orthodox, and in politics is represented by the miner and the farmer.

Calculating the Saturn Cycles

For the purpose of illustrating the method of calculating the time for which a Saturn Cycle chart should be erected, we will use the last two cycles of Saturn, January 23, 1909, and March 2, 1922. As we wish to know the influence of these Saturn Cycles on the affairs of the United States, the problem is to ascertain the times at Washington, D. C., when Saturn crossed from south declination to north declination.

The Nautical Almanac for 1909 gives the declination of Saturn each day at noon, Greenwich Mean Time, together with the variation per hour. The position on January 24 is given as plus 0 degrees, 1 minute, 0.8 seconds. The variation per hour is given as 5.21 seconds. That is, Saturn, moving 5.21 seconds per hour, on January 24 had already crossed into north declination 0 degrees, 1 minute, 0.8 seconds.

One hour equals 60 minutes. 0 degrees, 1 minute, 0.8 seconds equal 60.8 seconds. Then $5.21 \cdot 60 : 60.8 = ?$ The answer is 700 minutes, which equal 11 hours, 40 minutes.

From January 24, noon, subtract 11 hours, 40 minutes, and it gives the Greenwich Time as January 24, 0:20 a.m. As Washington is 77 degrees west, subtract a further 5 hours, 8 minutes, and it gives the time for which the Saturn Cycle must be erected as January 23, 1909, 7:12 p.m. L.M.T. 77W. 38—56N. The chart erected for the time so found is No. 52 in the table at the front of this booklet.

The Nautical Almanac for 1922 gives the declination of Saturn each day at noon, Greenwich Mean Time, together with the variation per hour. The position on March 2 is there given as plus 0 degrees, 0 minutes, 12.9 seconds. The variation per hour is given as 4.35 seconds. That is, Saturn, moving 4.35 seconds per hour, on March 2 had already crossed into north declination 0 degrees, 0 minutes, 12.9 seconds.

One hour equals 60 minutes. 0 degrees, 0 minutes, 12.9 seconds equal 12.9 seconds. Then $4.35 \cdot 60 : 12.9 = ?$ The answer is 178 minutes, which equals 2 hours, 58 minutes.

From March 2, noon, subtract 2 hours, 58 minutes, and it gives the Greenwich Time as 9:02 a.m. As Washington is 77 degrees west, subtract a further 5 hours, 8 minutes, and it gives the time for which the Saturn Cycle must be erected as March 2, 1922, 3:54 a.m. L.M.T. 77W. 38—56N. The chart erected for the time so found is illustrated at the front of this booklet.

The Cycles of Saturn

As an index of what may be expected to happen under the influence of aspects in a Saturn Cycle, we will follow two plans: First: commencing with the first Saturn Cycle since 1800, I will quote, with my own comments in parentheses, every event that is clearly Saturnine in nature that is of enough importance to be included in the Reference History of the World of Webster's New International Dictionary. Omitting none of these as far as available space warrants us following them, the progressed aspect in the Saturn Cycle then effective will be indicated. Second: I will list ALL the progressed aspects that have formed in the current Saturn Cycle, going as far as available space will permit, and indicate the event attracted by each of these aspects.

As the Saturn Cycles earlier than 1884 were calculated, not from the Nautical Almanac, but from the positions of Raphael's Ephemeris, these earlier cycles are approximate only, and too much dependence can not be placed on their house positions. The house positions of the Cycles since 1884 are precise.

The first Saturn Cycle of the Nineteenth Century commenced (Chart 45) April 4, 1820, approximately 9:16 p.m., Washington. The ruler of the cycle is in the 5th, house of speculation, and immediately there is an Act encouraging land (Saturn) speculation.

April 24, 1820, there is passed the Public Land Act which permits the purchase of tracts of 80 acres or more at a minimum price of \$1.25 per acre, and at the same time abolishes the credit system.

1821, under Saturn conjunction Sun r, co-ruler of the 9th (sea commerce), and later square Mars r ruler of the house of sea commerce, Russia lays claims to the North American Coast (Saturn) south to 51 degrees.

April 17, 1824, under Saturn sextile Mars r, Treaty with Russia; no Russian Settlements (Saturn) south of 54 degrees, 40 minutes, which becomes the recognized northern boundary of the Oregon Country.

April 30, 1824, under Saturn sextile Mars r, General Survey (of land) Act passed.

August 6, 1827, Saturn square Sun r, Treaty with Great Britain continues the joint occupation of Oregon (land).

May 19, 1828, under Saturn square Sun r, Tariff Act (Saturn p in house of tariff) of 1828, called the Tariff of Abominations. It is strongly protective (Saturn), and the South, especially South Carolina, declaring that the burden of it falls (Sun rules politics) on the slave States, threaten resistance.

May 28, 1830, under Saturn sesqui-square Uranus r, Jackson signs the Indian Removal Act, which embodies his policy for the general removal (Uranus ruling house of travel) of the Indians to reservations west of the Mississippi (so the whites can have their land).

July 14, 1832, under Saturn opposition Jupiter r, Tariff Act of 1832 continues the protective (Saturn) duties so obnoxious to the South.

March 2, 1833, under Saturn p in house of business, trine Venus r in house of opposition, Clays' Compromise Tariff Act, calling for a gradual reduction (Saturn) to a revenue basis in 1842. A Force Act is also passed to furnish means of controlling recalcitrant (7th house) States.

The next Saturn Cycle commenced (Chart 46) April 13, 1834, approximately 6:52 a.m., Washington. Saturn is in the 6th (harvest) trine to the Moon (common people), and trine to Neptune (schemes and promotions) on the cusp of the 10th, and opposition Mercury, ruler of the 2nd (banks and money). As the cycle came in the patenting of the horse reaper by C. H. McCormic made considerable change in the labor (Saturn) of harvesting (Saturn in 6th).

April 20, 1836, under Saturn opposition Venus r, ruler of 1st (people), and square Neptune r, Wisconsin Territory is set up out of Michigan Territory.

January 9, 1837, under Saturn sesqui-square Mercury r, Jackson's special message shows interest of United States in an Isthmian (Saturn p in house of foreign countries) Canal.

May 10, 1837, under Saturn opposition Jupiter r, (finances), Panic (Saturn) of 1837 begins.

June 12, 1838, under Saturn inconjunct Sun r and opposition Asc. r (people), Iowa Territory is created out of that part of Wisconsin Territory west of the Mississippi.

September 4, 1841, under Saturn sextile Uranus r, in house of business, Act for preemption of public lands and distribution of the proceeds of public land sales among the States. Settlers may once only preempt 160 acres at \$1.25 per acre.

August 9, 1842, under Saturn sesqui-square Asc. R, (people of U. S.), Ashburton Treaty signed with Great Britain. It settles the northeastern boundary (Saturn) dispute, which threatens war, by a compromise line.

August 20, 1842, under Saturn in 8th (Tariffs) sesqui-square Asc. r, Tariff Act of 1842, a protective measure (Saturn) without any distribution of proceeds of public lands.

March 1, 1845, under Saturn in 10th (business) square to Jupiter r, Joint resolution of Congress for the annexation of Texas, less favorable to the United States than the abandoned treaty.

June 15, 1846, under Saturn semi-sextile Mercury r, Treaty is signed with Great Britain adjusting Oregon; the United States confirmed in the portion South of 49 degrees.

December 12, 1846, under Saturn conjunction Uranus r, in house of business, Treaty with New Granada (Colombia): freedom of transit on Isthmus of Panama given to United States; in return neutrality of Isthmus and Colombia's sovereignty (Saturn) over it are guaranteed by the United States.

January 24, 1848, under Saturn (mines) conjunction Mars r, Gold is discovered near Sutter's Mill in California. A great immigration (Saturn ruler of house of long journeys) by land and sea follows (the gold rush of 1849 unequalled for roistering and crime, characteristic of Mars), with pressure for quick organization of civil government.

February 2, 1848, under Saturn square Moon r, Treaty of Guadalupe-Hidalgo is signed with Mexico. Rio Grande recognized as boundary (Saturn) and New Mexico and California ceded.

August 14, 1848, under Saturn semi-sextile Sun r, Oregon is organized as a territory, slavery being forbidden.

March 3, 1849, under Saturn semi-sextile Uranus r in house of administration, Act for the Department of the Interior; its head becomes the seventh member of the cabinet. Minnesota Territory (Saturn) is established.

Then follows a short Cycle of Saturn (Chart 47) commencing May 19, 1849, approximately 6:52 a.m., Washington. Saturn is ruler of the 7th (foreign countries) and is with Mars (war planet) in the 10th (business). Under this influence eyes are turned toward Cuba as a possible acquisition in the future and filibustering expeditions are sent against her.

The next Cycle of Saturn (Chart 48) commenced February 12, 1850, approximately 3:52 a.m., Washington.

April 19, 1850, under Saturn p in house of short journeys, sextile Mercury r, co-ruler of house of long journeys, Clayton-Bulwer Treaty with Great Britain. Acquisition of California has made the transit across the Isthmus important to the United States; and the British show intention of fixing themselves there. Treaty is recognition of equal interest in any canal (Saturn in 3rd) or line of transit on the principle of guarantee of neutrality.

September 20, 1850, under Saturn sextile Venus r, first act of Congress making land (Saturn) grants in aid of construction of railroads (Saturn in house of railroads).

March 3, 1851, under Saturn sextile Venus r, Congress reduces (Saturn) letter (Saturn in house of letters) postage to three cents per half ounce for carriage up to 3,000 miles.

March 2, 1853, under Saturn in 4th (house of land) square Mercury r, Washington Territory set off from Oregon Territory.

March 4, 1853, under Saturn in 4th (house of land) square Mercury r, Franklin Pierce becomes the fourteenth president. In his inaugural he declares for the annexation of Cuba.

December 30, 1853, under Saturn square Moon r, Gadsen Purchase Treaty with Mexico; for \$10,000,000 (Moon in house of money) a strip transferred over which the southern route of the proposed Pacific Railroad would pass.

March 7, 1857, under Saturn sesqui-square Sun r in house of money, Tariff Act of 1857: follows the plan of 1846, but further reduces (Saturn) duties.

August 24, 1857, under Saturn square Uranus r, Panic of 1857 begins; increase of gold and the rapid extension of railroads are underlying causes. The government surplus becomes a deficit (Saturn), and treasury notes and bonds are issued.

1859, under Saturn trine Saturn r, First oil well is sunk on Oil Creek, Pa.; the beginning of the petroleum industry. Silver discovered in the Comstock lode (Saturn), Nevada.

February 28, 1861, under Saturn inconjunct Saturn r, Colorado Territory (Saturn) is created.

May 15, 1862, Saturn, after being retrograde from conjunction Jupiter r, in the 9th in Virgo, turns direct again bringing to pass the things which were started three months earlier while the aspect was perfect. As this conjunction is in Virgo, the sign of farming, the events relate to this industry, and while the conjunction is applying the second time these events transpire before the aspect closes to the common orb of influence. May 15, Congress authorizes the Department of Agriculture (Saturn). May 20, Homestead (Saturn) Law is enacted. July 2, Morrill Agricultural College Act grants public lands to States for the support of colleges (Jupiter in the house of colleges) of agriculture (Saturn) and mechanical arts; origin of most of the State agricultural schools.

The next Cycle of Saturn (Chart 49) commenced January 16, 1863, approximately 6:52 a.m., Washington. Here we have Saturn, ruler of the Asc. (people) in the house of death in opposition to Neptune. Thus were the people in vast numbers in the house of death through the Civil War and the ravages of disease which accompanied it. Thus also were they depressed by the death of their President, Lincoln, who was assassinated when Saturn, April 14, 1865, was conjunction Jupiter r, ruler of house of secret enemies, and square Sun r (one high in political office).

March 3, 1863, under Saturn trine Venus r, ruler of the house of lands, Idaho Territory is created.

May 26, 1864, under Saturn trine Mercury r, Montana Territory (Saturn) is created.

July 2, 1864, under Saturn trine Mercury r, Northern Pacific Railway is incorporated by Congress to run from Lake Superior to Puget Sound: it receives a land (Saturn) grant.

July 27, 1866, under Saturn semi-sextile Saturn r, Atlantic and Pacific Railway is incorporated and given a land (Saturn) grant in connection with the Southern Pacific of California.

March 2, 1867, under Saturn sextile Sun r, Further internal revenue reduction (Saturn); and higher protection (Saturn) given to wool and woolens.

March 30, 1867, within a month after Saturn had turned retrograde from its sextile Sun r, which marked the negotiations, Treaty signed with Russia covering purchase of Alaska for \$7,200,000.

July 25, 1868, under Saturn inconjunct Mars r, Wyoming Territory (Saturn) is established.

September 24, 1869, under Saturn conjunction Moon r, sextile Mercury r, Black Friday in Wall Street, due to an attempt to corner (Mercury ruling house of speculation) gold, broken by action of the Federal treasury (Saturn ruling panics).

March 3, 1871, under Saturn trine Pluto r (in house of railroads), Texas Pacific Railway is incorporated by Congress and given a land (Saturn) grant, the last of the land grants.

October 8-10, 1871, under Saturn in the 12th square Saturn r, Great fire in Chicago; loss \$200,000,000. Shown in Mars Cycle also, indicating the nature of the agent which brought the loss of property (Saturn).

November 9-10, 1872, under Saturn inconjunct Uranus r, Great fire in Boston; loss (Saturn) of \$70,000,000.

September 18, 1873, under Saturn conjunction Sun r, square Jupiter r (financial planet), failure of Jay Cooke and Co. starts a great panic (Pan is one of the ancient names of Saturn); caused chiefly by over-building of railroads in the West.

March 3, 1877, under Saturn square Moon r (common people), Desert Land Act provides special conditions for patenting such land, subject to proper development and irrigation.

June 3, 1878, under Saturn conjunction Neptune r, Timber and Stone Land Act provides a further special means of securing public land. (Has been used by large corporations—Neptune—to secure vast holdings at little expense—Neptune in house of cash.)

Another Cycle of Saturn (Chart 50) commenced March 20, 1879, approximately 2:52 p.m., Washington. Again Saturn is in the 8th (house of death) this time conjunction with the Sun (persons high in political office). The significance of this position was verified by the assassination of two presidents of the United States. Garfield died September 19, 1881, as Saturn came close to the conjunction of the M.C. r, and McKinley died September 14, 1901, as Saturn came close to the trine of Neptune r; but the actual assassinations belong under the influence of, and are shown in, the Mars Cycles.

In addition to the 8th, the other important houses are the 9th, holding three planets, and indicating outstanding developments in the domain of commerce; the 7th, holding two planets, and indicating relations with foreign countries; and the 6th, because Mars, the planet of strife is there located and in sextile to Saturn, both Mars and Saturn at the same time being inconjunct Uranus, the planet of disruption, in the house of the people. As Mars also rules the 4th, house of lands and homes, in addition to strife where labor and farm products are concerned, the deadly influence of Saturn strikes hard in the destruction of these possessions.

November 17, 1880, under Saturn semi-square Moon r in house of foreigners, Chinese Exclusion (Saturn) Treaty (affecting labor) is signed with China, removing Hayes' objections to an exclusion act.

January 24, 1881, under Saturn conjunction Venus r, in house of court, In *Springer v. United States* the Supreme Court holds the Federal income tax (Saturn in cycle in house of tax) of 1862 to be constitutional, not being a direct tax.

March 1882, under Saturn conjunction Neptune r, Disastrous overflow of the Mississippi River; some 85,000 people made destitute (Saturn).

May 6, 1882, under Saturn semi-square Sun r, First Chinese Exclusion (Saturn) Act suspends immigration of laborers for ten years.

August 3, 1882, under Saturn conjunction Pluto r, First Act to restrict general immigration excludes (Saturn) defectives and convicts and imposes a head tax.

March 3, 1883, under Saturn semi-square Saturn r, Tariff and Internal Revenue Act to reduce (Saturn) the surplus.

October 1, 1883, under Saturn semi-square Venus r, ruler of the house of letters, Letter postage is reduced (Saturn) to two cents a half ounce.

July 1, 1885, under Saturn square Sun r, Letter postage reduced (Saturn) to two cents an ounce; second class postage to one cent a pound, causing a continued deficit (Saturn) in the department.

August 2, 1886, under Saturn in Cancer (stomach) square Mercury r, Congress places a tax on oleomargarine; an early Pure food (protecting the public) law.

October 12, 1886, under Saturn sesqui-square Moon r, Gales and floods in Texas and Louisiana destroy property and 247 lives.

January 29, 1887, under Saturn semi-square Uranus r, Mexican War Pension Act becomes law; age, dependency, or disabilities are pensionable (Saturn in house of pensions in cycle chart).

February 8, 1887, under Saturn semi-square Uranus r, in house of citizens, Indian Allotment Law is enacted; under stipulated conditions Indians may be given land in severalty and become citizens. During this period the reservations are being rapidly reduced (Saturn) in size and number and the land (Saturn) opened to white settlement.

February 11, 1887, under Saturn (in house of pensions in cycle chart) semi-square Uranus r, Cleveland vetoes (Saturn) the Disability and Dependent Pension Bill for Civil War Veterans. He relentlessly uses the veto power against private pension (Saturn) bills.

March 2, 1887, under Saturn square Mercury r, in house of colleges, Hatch Act authorizes the establishment of agricultural (Saturn) experiment stations in connection with Morrill Act colleges.

September 5, 1887, under Saturn, planet of labor, opposition Mars r, in house of labor, Labor Day is first observed in New York as a legal holiday.

October 1, 1888, within three weeks after the aspect was perfect, Saturn trine Mercury r, in house of foreign travel, Second Chinese Exclusion (Saturn) Act prohibits the return of laborers (thus protecting American labor) who have left the country.

February 9, 1889, under Saturn trine Mercury r, Department of Agriculture (Saturn) becomes an executive department and its secretary a cabinet officer.

1889, under Saturn trine Mercury r, in house of shipping, Bankruptcy (Saturn) of the French Panama Canal Company; of importance to the United States, where the concession is deemed contrary to the nation's policy and welfare, if not to the Monroe Doctrine. Interest in an American canal is stimulated; an American company organizes for work through the Nicaraguan isthmus (Saturn).

April 22, 1889, under Saturn sesqui-square Sun r, ruler of the people, Part of Indian Territory is opened, and a wild rush to settle ensues.

June 14, 1889, under Saturn sesqui-square Sun r, Tripartite agreement with Great Britain and Germany for the independence and joint control of Samoa (Saturn).

August 30, 1890, under Saturn opposition Moon r, in house of foreign Nations, Congress passes an act for the inspection of pork products intended for exportation (a protection); the outcome of controversies with foreign nations, especially Germany. President given power to retaliate on unjust discriminations (a protective measure) against American products. Federal encouragement of agricultural education is increased by an act for an annual grant to the Morrill agricultural colleges.

September 29, 1890, under Saturn sesqui-square Venus r, ruler of house of railroads, Act for the general forfeiture (Saturn) of unearned Federal land grants to railroads.

October 1, 1890, under Saturn sesqui-square Venus r, Act for Weather (Saturn) Bureau. McKinley Tariff Act. Increases and systematizes protection (Saturn); revenue is reduced (Saturn) by prohibitive duties and the placing of raw sugar (basic commodity) on the free list, a sugar bounty being given the domestic producer as an offset.

The next Cycle of Saturn (Chart 51) is a short one. It commenced April 29, 1908, 0:02 p.m., Washington.

Then follows the Cycle of Saturn (Chart 52) previously calculated in detail, commencing January 23, 1909, 7:12 p.m., Washington. This leads up to the current Saturn Cycle.

The Cycle of Saturn Now Effective¹

The Cycle of Saturn effective at the time this is written, as per detailed calculations given earlier in these pages, commenced March 2, 1922, 3:54 a.m., Washington. The chart is used as an illustration at the front of this booklet. One important influence of Saturn things during the period of this cycle—March 2, 1922, to March 5, 1938—as shown by three planets in the house of money, will be to make a scarcity of cash. Mercury, ruler of the 6th (labor) and co-ruler of 8th (pensions) in the 1st, will make employment insurance and old age pensions popular demands. Neptune in the 7th (foreign countries) will give dreams of receiving pay from foreign nations that will never be realized.

Saturn in this chart makes only two close aspects. An aspect from the planet for which the cycle is erected to another planet indicates a direct thought current relating the things the cycle planet rules to the department of life indicated by the house occupied by the aspected planet. Thus in this cycle. Saturn is in the house relating to death, taxes, insurance, pensions, and debts due; and it is in square to Pluto in the house of work. It has an influence, therefore, to make a scarcity of work, which in turn brings a demand on the part of labor for greater security (Saturn) in the future in the matter of employment. And as Saturn is also sextile Mars in the house of Congress; that legislative body will become aggressive (Mars) in making laws having the security of the aged (Saturn) and of those who toil (Mars inconjunct Pluto in 6th) as their object.

Commencing with the beginning of this Saturn Cycle I will now start to list ALL the progressed aspects that have occurred in it, and go as far as available space will permit. In connection with each aspect I will quote an event of importance enough to be included in the WORLD ALMANAC, with my own comments in parentheses. These events, all showing clearly the influence of Saturn, will afford opportunity to study, not merely how the heavy progressed aspects in the cycle affect events, but just about what may be expected to happen under each type of aspect which would receive any consideration in practical work.

On the Cycle: March 1, 1922, U. S. Senate, 67 to 22 ratified U. S. Japan Yap (territory) treaty.

March 5, 1922, Saturn sextile Mars r: March 4, N. Y. Court of Appeals rules Housing (Saturn) Law is not retroactive.

May 3, 1922, Saturn sesqui-square Mercury r: May 4, tornado (Mercury rules wind) killed (Saturn in 8th) ten or more and damaged property (Saturn) in and near Austin, Texas.

July 3, 1922, Saturn sesqui-square Mercury r: July 2, Lightning burned 500,000 bushels of grain (Saturn) and 60 cars of tobacco at B. and O. Locust Point terminal, Baltimore.

August 23, 1922, Saturn sextile Mars r: August 23, U. S. House, 219 to 55 passed President Harding's Coal (Saturn) Inquiry Commission Bill.

August 25, 1922, Saturn conjunction Saturn r: August 25, N. Y. City skyscrapers (Saturn) begin to install oil burning equipment for light, heat and power owing to coal (Saturn) shortage.

September 12, 1922, Saturn square Pluto r: September 13, U. S. House, 177 to 130 reject dye embargo and potash duty (Saturn in 8th) in conference report on Tariff Bill.

September 26, 1922, Saturn inconjunct Uranus r: September 23, New Yorkers are limited (Saturn) to two weeks coal (Saturn) supply at a time.

October 1, 1922, Saturn semi-sextile M. C. r: October 2, Inquiry by The World shows that America "invested" (M.C.) \$960,000,000 since the world war in German paper money (Saturn in cycle in house of foreign money) now almost worthless (Saturn).

October 7, 1922, Saturn inconjunct Sun r: October 8, "Safety (Saturn) Week" begins at New York.

October 31, 1922, Saturn sextile Neptune r: November 2, Mexico (Neptune in house of foreign countries) suspends (Saturn) all commercial relations with New York.

November 21, 1922, Saturn inconjunct Venus r: November 22, blast kills 84 miners (Saturn) in dolomite iron mine near Birmingham, Ala.

November 25, 1922, Saturn trine Mercury r: November 25, 7 dead in coal mine (Saturn) explosion at Cerillos, New Mexico.

November 28, 1922, Saturn square Asc. r: November 27, States may impose tax (Saturn in 8th in cycle) upon products produced within the borders before such products enter interstate commerce, U. S. Supreme Court holds, in deciding the constitutionality of the Pennsylvania anthracite coal (Saturn) tax.

December 7, 1922, Saturn conjunction Jupiter r: December 7, the business (Jupiter) district of Astoria, the oldest city in Oregon, was destroyed by fire which swept over 30 blocks; hundreds of persons are homeless (Saturn) and property loss is estimated at \$15,000,000.

January 20, 1923, Saturn opposition Moon r: January 19, at Marion, Ill., the jury (Saturn p in house of court) in the first trial growing out of the Herrin coal mine (Saturn) massacre return a verdict of not guilty after being out for 26 hours.

February 8, 1923, Saturn opposition Moon r: February 8, 120 die in an explosion in a soft coal mine (Saturn) of the Phelps-Dodge Corp., at Dawson, New Mexico.

March 25, 1923, Saturn conjunction Jupiter r: March 24, U. S. Government begins inquiry (hoping to lower price—Saturn) into boost (Jupiter) in sugar (basic commodity) prices.

April 5, 1923, Saturn square Asc. r: April 6, union miners (Saturn) charged with Herrin murder riots are acquitted (Saturn p in house of court) at Marion; on April 7, all the untried indictments are dismissed.

April 10, 1923, Saturn trine Mercury r: April 9, N. Y. Conference of M. E. churches (Saturn p in house of church) 35 to 31 opposed women (Saturn the conservative) as preachers.

April 15, 1923, Saturn inconjunct Venus r: April 16, U. S. Supreme Court (Saturn p in house of court) upheld Grain (Saturn) Futures (Venus in 2nd, Mercury, ruler of 5th still in orb) Act.

May 22, 1923, Saturn sextile Neptune r: May 24 at the request of the State Department the Republican National Committee “withdrew” (Saturn) a statement which it issued in which the Allied Powers of Europe (Neptune in house of foreign countries) were referred to as planning to “bilk” (Neptune) and “job” (Neptune) the United States to join in partnership (Neptune in house of partners).

July 11, 1923, Saturn sextile Neptune r: July 11, the French Senate (Neptune in house of foreign countries), 287 to 3, adopt all of the Washington Arms Conference treaties with reservations (Saturn) as to aeronautics (Saturn p in house of aeronautics).

August 15, 1923, Saturn inconjunct Venus r: August 15, U. S. and Mexico representatives sign at Mexico City an agreement on oil rights (Saturn in house of foreign commerce) in Mexico.

August 20, 1923, Saturn trine Mercury r: August 22, gasoline (basic commodity) sold at 6 cents (Saturn poverty) at Los Angeles.

August 24, 1923, Saturn square Asc. r: August 24, the U. S. Coal (Saturn) Commission having failed to settle the anthracite dispute, President Calvin Coolidge appointed Governor Pinchot of Pennsylvania Mediator.

September 1, 1923, Saturn conjunction Jupiter r: August 31, the Missouri Supreme Court (Jupiter in house of court) outlaws St. Louis Lumber Trade Exchange in “open price association” suit, and fines (Saturn) members \$96,000.

September 21, 1923, Saturn opposition Moon r: September 21, New York City Board of Estimates extends \$5,000 tax exemption (economy) on new homes (Saturn).

September 28, 1923, Saturn semi-square Mars r: September 27, Governor Walton, Oklahoma, orders troops (Mars) into Sulphur County to stop flogging and house (Saturn) burning (Mars).

October 30, 1923, Saturn sesqui-square Uranus r: October 28, a slide (disruptive Uranus) develops on the west bank of Panama Canal.

November 11, 1923, Saturn sesqui-square Sun r: November 11, U. S. Supreme Court (Saturn in house of court) declares valid the laws of California and Washington prohibiting alien—including Japanese and Chinese—ownership of real estate (Saturn).

January 5, 1924, Saturn sesqui-square Venus r: January 6, cold wave (Saturn) in Mid-West and East kills 17 at Chicago, 6 at New Orleans, 2 at New York.

March 19, 1924, Saturn sesqui-square Venus r: March 19, the story of a “tentative reduction” (Saturn) of taxes (Saturn in house of taxes in cycle) of the Standard Oil Company from \$23,000,000 to \$5,000,000 was told to the U. S. Senate committee investigating the Internal Revenue (Venus in house of money) Bureau by E. E. Rossmore, a former employee of the bureau.

June 6, 1924, Saturn sesqui-square Sun r: June 6 Governor (Sun) William S. Flynn issues a denunciation of the Ku Klux Klan and an Order that the Klan be kept out of all State-owned buildings (Saturn).

July 21, 1924, Saturn sesqui-square Sun r: July 17, 13 Negroes die in fire and explosion in Kansas City tenement (Saturn).

September 24, 1924, Saturn sesqui-square Venus r: September 22, storms (Saturn) kill 55 in Wisconsin and 5 in Minnesota.

November 2, 1924, Saturn semi-sextile Mars r: October 30, forest (Saturn) fires (Mars) in New York and Vermont cause hunting (Mars) season suspension.

November 4, 1924, Saturn semi-sextile Saturn r: November 5, the U. S. Department of Labor (Saturn) declines to deport (Saturn p in 9th) Firpo, Argentine boxer, and canceled the arrest warrant.

November 21, 1924, Saturn trine Pluto r: November 20, N. Y. State Board of Parole (Saturn in 9th) grants parole, as of December 26, 1924, to R. P. Brindell, convicted on charge of extortion (Pluto the racketeer) from laborers in the Building Trades Council and from contractors.

December 6, 1924, Saturn trine Uranus r: December 5, the charters of local branches of the United Mine (Saturn) Workers of America, near Scranton, Pa., have been revoked because of an outlaw strike (Uranus) of 12,000 employees of the Pennsylvania Coal Co.

December 12, 1924, Saturn conjunction M. C. r: December 10, Probate Court at Laconica, N. H., accepts the resignation of J. V. Dittmore of Boston, as a trustee (M. C.) of estate (Saturn) of Mary Baker Eddy, Christian Science leader.

December 20, 1924, Saturn trine Sun r: December 24, bursting dam at Parmatown, Pa., drowns 23 and leaves 200 homeless (Saturn).

January 30, 1925, Saturn square Neptune r: January 31, while 600 men and women look on, Edward S. Harkness, with a silver spade (Neptune dramatizes), turns loose earth in a 22-acre lot (Saturn) at 168th St. and Broadway, which he had donated, marking the beginning of a great new medical center in New York City.

March 16, 1925, Saturn square Neptune r: March 18, a storm (Saturn) in Missouri, Southern Illinois and Indiana kills over 830 persons, injures 3,800 and destroys property (Saturn) valued at \$10,000,000.

May 1, 1925, Saturn trine Sun r: May 1, the largest check (Sun in house of money) in recent times—for \$146,000,000, for payment of Dodge Brothers auto plants (Saturn)—is drawn at New York City and deposited in a local bank.

May 12, 1925, Saturn conjunction M. C. r: May 11, U. S. Supreme Court upholds the provision of alien land law of California imposing upon aliens ineligible to citizenship the burden of proving that their purchase of agricultural land (Saturn) was not for the purpose of defeating the statute.

May 19, 1925, Saturn trine Uranus r: May 18, the New York Baptist Ministers' Association (Saturn in house of religion) declined to reaffirm (Uranus tends to progressive views) belief in the necessity of baptism by immersion.

June 20, 1925, Saturn trine Pluto r: June 19, Gov. Ralph O. Brewster of Maine authorizes Donald B. MacMillan, who sails (Saturn p in house of voyages) to claim any territory (Saturn) he may discover in the Polar regions for the state of Maine.

August 1, 1925, Saturn trine Pluto r: August 3, a syndicate (Pluto rules cooperation) to control South African Diamond Mines (Saturn) is formed by New York capitalists.

September 1, 1925, Saturn trine Uranus r: August 31, 150,000 miners (Saturn) quit (Uranus rules strikes) the anthracite pits of Pennsylvania to enforce their demands for a 10 per cent pay increase.

September 7, 1925, Saturn conjunction M. C. r: September 5, fire destroys 250 dwellings (Saturn) at Shreveport, La.

September 16, 1925, Saturn trine Sun r: September 14, U. S. Secretary of Agriculture (Sun rules government officials) Jardine dismissed the complaint against the Armour-Morrison merger in the meat (farm product) packing industry.

October 14, 1925, Saturn square Neptune r: October 14, ratifications of the German (Neptune in house of foreign countries) commercial (Saturn in house of business) treaty with the United States are exchanged at the State Department by Secretary Kellogg and Baron Maltzan, the German Ambassador.

November 2, 1925, Saturn trine Venus r: November 4, a 50-car train from Omaha, Neb., containing poultry, butter, eggs and other dairy products (farm produce) valued at \$50,000,000 (Venus in house of cash) arrives at New York City.

November 6, 1925, Saturn square Mercury r: November 8, although submitting a brief in the U. S. Supreme Court, as law officer representative of the Government arguing in support of the constitutionality of the Futures (Mercury rules house of speculation) Trading (in farm products) Act, Solicitor General Mitchell expresses the personal opinion the law is invalid.

November 9, 1925, Saturn sextile Asc. r: November 11, 1925, the body of King Tutankhamen, who died 3,275 years ago at the age of 15 to 18, is taken from the coffin (Saturn in house of death in cycle) in the royal subterranean tomb at Luxor, Egypt, by Howard Carter (U.S.A.).

Chapter 5

Serial No. 145
Original Copyright 1936
Elbert Benjamine

Copyright
August 2002
Church of Light

The Cycles of Jupiter

Chapter 5

The Cycles of Jupiter



NO DIFFICULTY will be experienced by anyone who becomes even slightly conversant with the use of progressed aspects in Cycle Charts, in foretelling with precision the times when widespread interest in events of each planetary type will be exhibited, and, within a day or two, when important events of each planetary type will come to pass. In fact, by also considering the New Moon Cycle, or Lunation, such events can be predicted to within twenty-four hours of the exact time they actually transpire.

To predict the degree of importance which will attach to the event indicated by any one progressed aspect in a Cycle Chart is a more complex matter; for events are not isolated occurrences, but each an integral portion, great or small, of that total pattern which goes to make up our national and international life. This pattern has not only breadth, into which the occurrences indicated by the progressed aspects of each of the cycles and major conjunctions of the immediate period must fit; but it has length in time. The events which have gone before, as indicated by earlier progressed aspects in the various cycles, and by earlier major conjunctions, all have a bearing upon both the importance and the precise nature of the event attracted by any single progressed aspect.

When, for instance, the preceding cycles have led up to a condition in which the minds of the populace are filled with thoughts of war, any progressed aspect, either harmonious or discordant, in the Mars Cycle Chart, tends to fan the destructive flames. If a state of war already exists, such an aspect indicates the time of actual skirmishes or engagement, and if the aspect is a powerful one, it will mark the time of heavy actual fighting. But taken by itself, no progressed aspect in the Mars Cycle Chart can cause a country to go to war. A war is the result of a cumulative set of circumstances that are indicated in various cycle charts and major conjunctions.

We can be absolutely certain when a progressed aspect forms in the Pluto Cycle Chart that some important event will come to pass involving group activity, and with possibilities of drastic action in case there is resistance to the group decision. Thought currents within the world are then stimulated by energies coming from the planet Pluto, and these, linking certain people together in a chain of similar thought, lead to mass action.

The house position of the aspected planet, and the special affinity of the aspected planet, are good guides to the nature of the event to be expected. Yet at a time, due to preceding influences which have led up to it, when the attention of the world is focused on the League of Nations it is safe to predict that the most important event attracted by the Pluto aspect will relate to some action of this body. If, however, the progressed aspect occurs during a period in which some bureau, such as one of the various associations designated by letters which at times exercise dictatorial authority—NRA, AAA, PWA, etc.— holds the attention of the public, the most important event attracted will relate to this particular group.

A progressed aspect in the Saturn Cycle Chart, at a time when there is great public agitation for conservation of natural resources, can be expected to mark the date when some pronounced decision or action will be taken in reference to conservation. But the same aspect in a time of business depression would indicate the date on which some action would be proposed or taken having for its object economy or security, the more exact nature of which could be determined from the house position and special affinity of the aspected planet.

Or to take an actual example from the past, spiritous liquors are ruled by Mars, and actions concerning them are shown by aspects in the Mars Cycle Charts. But nation-wide prohibition, in addition to affecting the consumption of alcoholic beverages, was a radical departure from precedent. And all the important actions leading up to national prohibition were shown also by aspects in the Uranus Cycle Chart. Not only so, but after national prohibition was established, all the important actions leading to the abolition of prohibition also were shown by progressed aspects in the Uranus Cycle Chart, until the pendulum finally swung back and the freedom of the people to decide their personal habits for themselves, as indicated by Uranus in the house of the people in the Uranus Cycle of 1928, finally asserted itself.

I am here trying to point out that over one period of time the most important events attracted by nearly every progressed aspect in the Uranus Cycle Chart had to do with prohibition, at another period of time with strikes, and that during still another period of time with the exposure of graft among public officials.

These broad public trends are not independent of the influence of Cycle Charts and Major Conjunctions; but to determine them requires great skill in combining all the factors, including the Major Progressions in the nation's birth chart, the Transits of the planets through the signs, and the General Astronomical Phenomena, examples of which are given in lesson No. 141 (See Serial Lesson Key).

Because so many factors are involved, to predict the precise nature of an event years in advance, such as that one nation will declare war on another on a certain date, or that the government will devalue its currency on another specified date, is a difficult matter. But to make accurate short time predictions, after a certain trend has set in, giving exact dates and exact events weeks and months in advance, is not difficult and requires only a moderate amount of practice.

When the trend is seen to belong to the rulership of a certain planet, any progressed aspect in that planet's Cycle Chart will bring something of consequence to pass relating to the matter, and the nature of the event can be ascertained from the known trend combined with the house position and special affinity of the aspected planet, etc., according to the rules given in lesson No. 143 (See Serial Lesson Key). Also, progressed aspects in the Cycle Charts of the other planets, to the planet ruling the trend under consideration, will have an effect upon the development of such events. That is, such aspects show the influence of the things ruled by the planet in whose Cycle Chart the progressed aspect occurs, to bring events to pass which are of the trend of the aspected planet, and which, therefore, are related to the special trend under consideration.

When Pluto is involved in the aspect, group action with drastic implications may be expected; when Neptune is one of the planets, schemes and an involved condition may be expected; when Uranus is one of them, something new, sudden and a marked change from old conditions; when Saturn is a party to the aspect, a slowing down, economy, loss or restriction; when Jupiter is one of the planets, expansion, optimism, expenditure or higher prices, and when Mars is one of them, look for strife and struggle.

By considering these typical influences, whether in their own Cycle Charts or when aspected in the Cycle Chart of another planet, a very clear picture can be formed of just what is going to happen, and just when, in reference to any subject which already has come before the public attention. The Cycle Chart ruling the matter will, by the progressed aspects that form in it, give the larger turning points. The details are to be filled in from the progressed aspects to this planet which rules the matter, which are made in the Cycle Charts of the other planets, each affecting the situation, of course, according to the type of influence which it commonly exerts.

Jupiter In Mundane Astrology

The influence of Jupiter on everything he contacts is in the direction of expansion. He is the salesman, whose good will and joviality enable him to sell his wares or his services at the highest price. Large and generous by nature he spends no time in petty haggling over small differences in cost. His customers will buy from him, even if they must pay a little more than elsewhere, because he is such a good fellow.

This disregard of small imperfections in others, tendency to forgive transgressions, and the spirit of give and take which is so essential in life if friction and antagonisms are to be avoided, may well be symbolized by the belts of Jupiter which may be seen through a small glass; ever shifting zones of various colors formed by changes in the planet's atmosphere. Here there is no suggestion of restriction, of self-interest, or of coldness; but rather an impression as of a benign and genial giant.

Look at Saturn through a telescope and there comes a very different feeling. Its cold white is slightly tinged with yellow, but it lacks that glowing warmth with which the steadfast yellow light of Jupiter seems to pour forth to cheer his neighbors in the sky. Instead of the somewhat careless disregard of self which the larger planet seems to indicate, Saturn has built a ring completely around himself to protect his possessions. In his cautious and self-centered desire to insure that nothing from himself is given to others, and that in even the smallest way no one outdo him in bargaining, he has fenced himself and his possessions in.

The fact which Saturn constantly overlooks, is that a wall which prevents anything from getting out acts quite as effectively to keep anything from getting in. Jupiter gives and spends and makes pleasure for others; and this generous attitude awakens a like response in them. They in turn, feeling a sympathetic glow of generosity, give Jupiter more than he asks, and go out of their way to see him prosper. But when they come in contact with the cold ring into which Saturn has withdrawn, they recoil from the barrier and think to themselves that such a one deserves no favors, and that the best thing is to let him entirely alone.

Saturn, as one of the two business planets, therefore, to get trade must sell at a bargain. But not so Jupiter. Whether in matters of wages, in the price to be paid for produce, or in the investment of capital, he ever tends to higher prices and more lavish expenditures. This tendency, when he is afflicted, leads to extravagance and to purchases at a price far above their real worth or what may reasonably be expected from them in the way of financial returns.

Religion and philosophy in thought, finance and commerce in business, and the influence of capitalism in politics, are the most outstanding things through which Jupiter, when he makes progressed aspects in his cycle chart, brings things to pass. More progressed aspects will be found to attract events relating to finances than to any other one thing.

Yet, as Jupiter is the ruler of the natural ninth house, it will be found that various ninth house matters are also at times brought into prominence through progressed aspects of Jupiter in his cycle chart.

As the ninth house is the third house of foreign countries, so treaties, which are contracts with such countries, come under Jupiterian rule. Commerce, interstate commerce in particular, ships which travel the sea, and long journeys in general, relate to this planet's cycle, as do cable messages, books, publishing and advertising. Here a careful distinction should be made between printing and the circulation of the news—things which are ruled by Mercury—and the public expression of opinions, whatever the channel employed, which is ruled by Jupiter.

Thus not only teaching, lecturing and preaching are Jupiterian functions, but advertising or lecturing over the radio, although the radio is ruled by Pluto. It is Jupiter placing opinions before the public. Mercury rules speech; but when that speech is used as indicated, rather than in conversation, it partakes of Jupiter's rule.

The courts also are under Jupiter's influence, and arbitration between countries, which is the placing of differences before some chosen judiciary body to decide.

Calculating the Jupiter Cycles

To illustrate the method of calculating the time for which a Jupiter Cycle should be erected, we will use the short cycle of Jupiter of July 7, 1927, and the present cycle of Jupiter which commenced February 5, 1928. As we wish to know the influence of the Jupiter Cycle on the affairs of the United States, the problem is to ascertain the time at Washington, D. C., when Jupiter crossed from south declination to north declination.

The Nautical Almanac for 1927 gives the declination of Jupiter on each day for Greenwich Civil Time (commencing at midnight). The position on July 7 is given as minus 0 degrees, 0 minutes, 31.0 seconds. The variation per hour is given as 2.65 seconds. That is, Jupiter, in south declination, is moving north at the rate of 2.65 seconds per hour, and must travel 31.0 seconds to cross into north declination.

One hour equals 60 minutes. Then $2.65 : 60 :: 31.0 : ?$ The answer is 702 minutes, which equal 11 hours, 42 minutes.

To July 7, Civil Time, add 11 hours, 42 minutes, and it gives the Greenwich Time as July 7, 11:42 a.m. As Washington is 77 degrees west, subtract 5 hours, 8 minutes, which gives the time for which the Jupiter Cycle chart must be erected as July 7, 1927, 6:34 a.m. L.M.T. 77W. 38—56N. The chart erected for the time so found is No. 75 in table at front of this booklet.

The Nautical Almanac for 1928 gives the declination of Jupiter on each day for Greenwich Civil Time (commencing at midnight). The position on February 6 is given as minus 0 degrees, 0 minutes, 31.2 seconds. The variation per hour is given as 12.39 seconds. That is, Jupiter, in south declination, is moving north at the rate of 12.39 seconds per hour, and must travel 31.2 seconds to cross into north declination.

One hour equals 60 minutes. Then $12.39 : 60 :: 31.2 : ?$ The answer is 151 minutes, which equals 2 hours, 31 minutes.

To February 6, Civil Time, add 2 hours, 31 minutes, and it gives the Greenwich Time as February 6, 2:31 a.m. As Washington is 77 degrees west, subtract 5 hours, 8 minutes, which gives the time for which the Jupiter Cycle chart must be erected as February 5, 1928, 9:23 p.m. L.M.T. 77W. 38—56N. The chart erected for the time so found forms the illustration at the front of this booklet.

The Cycles of Jupiter

To give examples, not of what may be expected from the common run of aspects in the Jupiter Cycle Chart, such as will be considered later; but to indicate the aspects in the Jupiter Cycle charts which coincided with the most important past events which are under Jupiter's rule, over a certain period of time, I will quote events and dates from an authoritative publication.

That the student may have all the Jupiter Cycle Charts since the year 1800, to facilitate his own researches, these are given in the table at the front of this booklet. Yet as for dates earlier than 1884 the charts are erected for approximate times, such as could be calculated from the positions in Raphael's Ephemeris, too much dependence should not be placed upon the house positions of these earlier charts. The dates for which these earlier charts have been erected now follow:

No. 60, Jupiter Cycle, March 27, 1809, approximately 10:24 p.m. 77W. 38—56N.

No. 61, Jupiter Cycle, April 8, 1815, approximately 9:52 a.m. 77W. 38—56N.

No. 62, Jupiter Cycle, March 11, 1821, approximately 11:52 a.m. 77W. 38—56N.

No. 63, Jupiter Cycle, February 22, 1833, approximately 2:22 a.m. 77W. 38—56N.

No. 64, Jupiter Cycle, June 28, 1844, approximately 9:16 p.m. 77W. 38—56N.

No. 65, Jupiter Cycle, February 3, 1845, approximately 2:04 a.m. 77W. 38—56N.

No. 66, Jupiter Cycle, May 22, 1856, approximately 7:57 p.m. 77W. 38—56N.

No. 67, Jupiter Cycle, January 10, 1857, approximately 6:52 a.m. 77W. 38—56N.

No. 68, Jupiter Cycle, May 1, 1868, approximately 4:28 p.m. 77W. 38—56N.

No. 69, Jupiter Cycle, April, 1880, approximately 6:52 a.m. 77W. 38-56N.

Commencing with the Jupiter Cycle which started March 1, 1886, 5:59 a.m., Washington, (chart 70) I will now quote, with my own comments in parentheses, ALL the events that clearly show the influence of Jupiter's rule, omitting none in the sequence, and covering a period as long as my space will permit, from the Reference History of the World of Webster's New International Dictionary. The progressed aspect in the Jupiter Cycle which attracted each event will be noted in connection with the quotation.

May 10, 1886, under Jupiter p in house of foreigners (7th) inconjunct Asc. r (American people), In *Yick Wo v. Hopkins* the Supreme Court (Jupiter) decides that a municipal ordinance designed to make arbitrary and unjust discriminations (unfair business regulations) against Chinese laundries is contrary to the principles of the Fourteenth Amendment.

October 25, 1886, nine days after Jupiter (Court) made the perfect semi-sextile to Mars r, ruler of the house of commerce, in *Wabash, St. Louis, and Pacific Railway Co. v. Illinois*, the Supreme Court (after having it under consideration) construes a State long-and-short-haul act as being a regulation of interstate (Jupiter) commerce. The court (Jupiter) reconsiders the Granger Cases of 1877, arguing that the question of interstate commerce was there only incidental. This decision shows the need of Federal regulation of the railroads.

February 4, 1887, under Jupiter semi-sextile Uranus r, ruler of reforms, Interstate Commerce (Jupiter) Act passes after an agitation (Uranus) of years. State regulation of railroads by legislation and commissions, though upheld by the Supreme Court, was not powerful enough or uniform and gave place to a demand for Federal regulation. Railroads become powerful and frequently affect or control State governments.

March 2, 1887, under Jupiter semi-sextile Uranus r, in house of foreign countries, the President is authorized to retaliate on Canadian trade (Jupiter) for the obstruction of the fishing rights; no action taken.

May 27, 1887, under Jupiter p in house of taxes (8th) trine Asc. r, In *Philadelphia and Southern Steamship Co. v. Pennsylvania*, the Supreme Court (Jupiter) holds a State tax upon the gross receipts of a steamship company derived from interstate and foreign commerce (Jupiter) contrary to the exclusive power of Congress.

February 20, 1888, under Jupiter in the house of treaties (9th) sextile Jupiter r in house of foreign nations (7th), Treaty signed with Great Britain to settle the fisheries dispute.

April 23, 1888, under Jupiter in the house of interstate commerce (9th) sextile Jupiter r, The Supreme Court (Jupiter) begins in the *Missouri Pacific Railway Company v. Mackey* its series of important interpretations of the Fourteenth Amendment as applied to labor questions, holding that a State statute abolishing the fellow-servant doctrine in workmen's compensation for injuries is not contrary to the amendment.

October 2, 1889, under Jupiter opposition Saturn r, ruler of house of Congress, and inconjunct Pluto r, in house of short journeys and co-ruler of house of long journeys, First Pan-American Congress meets at Washington. Delegates tour the country and hold sessions lasting until April 19, 1890 (to stimulate business—Jupiter—relations). A bureau (Pluto), later called the Pan-American Union, is organized with headquarters in Washington.

February 4, 1890, under Jupiter semi-sextile Asc. r, Centennial of the United States Supreme Court is celebrated at New York.

July 14, 1890, under Jupiter sextile M.C. r (business), Congress enacts the Silver Purchase (Jupiter rules finances) Act, which supersedes the Bland-Allison Act of 1878. It is a further compromise with the demand for free silver and requires the purchase each month of 4,500,000 ounces of silver and the issue of legal tender (Jupiter) silver treasury notes equal to the purchase value.

February 29, 1892, under Jupiter (ruler of arbitration) semi-sextile Asc. r, Conventions signed with Great Britain submitting to arbitration the right of the United States to prohibit pelagic (in the ocean) hunting of the fur seals in the Bering Sea.

The next Jupiter Cycle (chart 71) commenced March 27, 1892, 1:14 a.m. Washington.

February 14, 1893, under Jupiter semi-square Neptune r, Treaty of annexation with Hawaii is signed. This follows a revolt led by Americans, assisted by the American minister, and protected by American marines, by which the queen is deposed. Not ratified (Neptune often fails to fulfill).

March 2, 1893, under Jupiter in house of trains (3rd) inconjunct Saturn r (planet of safety) in house of commerce, Safety Appliance Act of Congress regulates brakes and couplers on trains in interstate commerce (Jupiter).

June 18, 1893, under Jupiter conjunction Venus r, sextile Moon r, Great Northern Railroad is opened; the first transcontinental (Jupiter) line to be constructed without a land grant.

January 17, 1894, under Jupiter conjunction Venus r, ruler of house of bonds (5th), Issue of \$50,000,000 in bonds is offered to replenish the gold reserve, which by February 1 falls to \$65,000,000 as \$100,000 is considered the minimum safety point.

March 29, 1894, under Jupiter conjunction Pluto r in house of speculation, Cleveland vetoes a bill to coin (Jupiter) the purchased silver bullion to the amount of the seigniorage.

April 29, 1894, under Jupiter in house of speculation, inconjunct Uranus r, in house of business, Remnant of "Coxey's Army of the Commonwealth of Christ," a demonstration (Uranus) of the unemployed, reaches Washington with a demand for the issue of \$500,000,000 paper money (Jupiter), especially the free coinage of silver, is presented as a panacea.

November 5, 1894, under Jupiter trine Uranus r, A second bond issue of \$50,000,000 (Jupiter) is made to replenish the gold reserve (Uranus in house of credit).

February 11, 1895, under Jupiter square Saturn r, ruler of the public (Asc.), Gold reserve is reduced to about \$41,000,000. Cleveland, February 8, contracts with a syndicate to buy bonds which they immediately resell (Jupiter) at a large premium. Much public criticism (public feel cheated—Saturn).

December 17, 1895, under Jupiter in house of foreign countries (7th), trine Sun r, Cleveland's message on Venezuela and British Guiana boundary controversy holds that the right of the United States under the Monroe Doctrine is involved in Great Britain's refusal to arbitrate (Jupiter) with Venezuela. He recommends a commission to decide (Jupiter) the rights of the controversy, Congress authorizes the commission.

February 5, 1896, under Jupiter trine Jupiter r, A popular issue of \$100,000,000 in bonds (Jupiter) is quickly subscribed at a premium, and the gold reserve rises to a point of safety.

November 12, 1896, under Jupiter sesqui-square Sun r, Great Britain and United States reach an agreement for the settlement of the British Guiana boundary by formal arbitration (Jupiter) treaty between Great Britain and Venezuela.

January 11, 1897, under Jupiter trine Mars r, General arbitration treaty (Jupiter) is signed with Great Britain; Senate rejects (Mars the planet of strife) it.

March 10, 1898, under Jupiter in house of the navy, opposition Sun r, Congress empowers the president to spend \$50,000,000 for national defense.

Then comes the Jupiter Cycle (chart 72) starting April 8, 1898, 8:47 a.m. L.M.T., 77W. 38—56N.

June 1, 1898, under Jupiter (planet of business) inconjunct Venus r, Exposition of the arts (Venus) and industries of trans-Mississippi States is opened at Omaha. Erdman Act authorizes governmental mediation (Jupiter) and voluntary arbitration (Jupiter) of disputes between carriers engaged in interstate commerce (Jupiter) and their employees, and forbids such carriers to discriminate against union laborers (Uranus in the cycle in house of labor, sextile Jupiter) or to blacklist them.

June 13, 1898, under Jupiter inconjunct Venus r, War Revenue Act provides for the raising of revenue by excise duties, tax on tea, and for a bond (Jupiter) loan of \$400,000,000, but only half the bonds are issued.

December 10, 1898, under Jupiter, ruler of house of foreign countries, semi-sextile Jupiter r and semi-sextile Uranus r, Treaty (Jupiter) of Peace is signed at Paris; Spain abandons Cuba, cedes Puerto Rico, Guam, and Philippines to United States, and is paid (Jupiter) \$20,000,000.

May 18, 1899, under Jupiter, ruler of house of foreign countries, semi-sextile Jupiter r, and semi-sextile Uranus r (something new), First Hague Conference. Convention for pacific settlement of international disputes, and to ameliorate war. Delegates from the United States sign (Jupiter rules treaties) with a reservation of the Monroe Doctrine.

September 6, under Jupiter, ruler of house of foreign nations, opposition Mercury r, ruler of the people (Asc.), Secretary Hay's open-door policy (business policy) for China receives recognition by other powers.

February 5, 1900, under Jupiter inconjunct Mercury r, First Hay-Pauncefote treaty (Jupiter) on Canal.

March 14, 1900, under Jupiter semi-sextile Moon r, Gold Standard Act makes gold dollar (Jupiter) standard unit of value.

May 14, 1900, under Jupiter inconjunct Mercury r, In Knowlton v. Moore the Supreme Court (Jupiter) decides that the Federal inheritance tax of June 13, 1898, is a constitutional indirect tax (a revenue raising measure, and thus under Jupiter).

May 27, 1901, under Jupiter sextile Moon r, In the Insular Case the Supreme Court (Jupiter) holds that Puerto Rico by the treaty (Jupiter) ceased to be a foreign country within the meaning of the tariff laws.

November 18, 1901, under Jupiter sextile Moon r, Hay-Pauncefote Treaty is signed; Clayton-Bulwer Treaty (Jupiter) abrogated and British consent given to American sole control of the Isthmian Canal.

January 24, 1902, under Jupiter semi-square Saturn r (lands), Second treaty (Jupiter) is signed with Denmark for the purchase of the Virgin Islands; the Rigsdag rejects (Saturn) the treaty.

March 8, 1902, under Jupiter square Mercury r, ruler of house of the people (Asc.), Act establishing tariff rates between the United States and the Philippines. Unrestricted trade (Jupiter) not granted.

June 28, 1902, under Jupiter semi-sextile M.C. r (business), Isthmian Canal Act authorizes the purchase of the rights of the French Canal Company for \$40,000,000 (Jupiter).

No. 73. Jupiter Cycle, March 11, 1904, 11:57 a.m. L.M.T. 77W. 38—56N.

No. 74. Jupiter Cycle, February 23, 1916, 4:26 p.m. L.M.T. 77W. 38—56N.

No. 75. Jupiter Cycle, the detailed calculation of which is given earlier in these pages, July 7, 1927; 6:34 a.m. L.M.T. 77W. 38—56N.

The Jupiter Cycle Now Effective¹

The influence of the current Jupiter Cycle, chart for which is illustrated at front of booklet, will be in effect from February 5, 1928, to May 26, 1939. According to the calculations previously given in detail, the chart is erected for February 5, 1928, 9:23 p.m. 77W. 38—56N.

The most outstanding feature of this chart is Jupiter, ruler of the cycle, in the house of labor, conjunction the disruptive Uranus, square Venus in the place of homes and farms, sesqui-square the Moon in the house of Congress, square the place of credit (M.C.), opposition the people (Asc.) and in close semi-square to the Sun in the house of speculation. In other words, every significant position in the chart, with the exception of a semi-sextile to Mercury, and no aspects to Saturn, Mars and Pluto, forms a decided affliction to the planet of finances and business in that planet's cycle.

The Sun being in the house of speculation and in close opposition to the Moon (common People), and both afflicting the financial planet, indicate that unwise speculation of the common people works in the direction of financial disaster. Pluto in the house of business in opposition to Venus and Mars, indicates that drastic measures will become necessary to preserve credit, and that business will be sorely distressed, especially as the M.C. also is so heavily afflicted. The two planets in the 4th, afflicted not only by Jupiter, but also by Pluto in the house of business, show that farms and homes will suffer great loss through dislocation of business and credit.

But more significant than any other position is Jupiter with Uranus in the 6th. Here we perceive that the real misadjustment, which is precipitated by a wild period of universal speculation, has its seat with labor. Uranus rules new inventions and intricate machines, and these have displaced more crude methods which required greater man power. This has not decreased wealth (Jupiter) but has brought about a dislocation in the distribution of wealth.

Uranus also rules new methods and changes, and thus points out not only the basic cause of the business and financial dislocation so clearly shown in this chart, but what must be accomplished before the financial difficulties here shown will be past. There must be a radical (Uranus) change in the distribution of wealth (Jupiter) among those who labor. It is chiefly the restricted buying power of the laborers, including agriculturists and clerical workers, that causes the business disruption here shown; and it can only be remedied by some new method which permits a vast number of people (Moon in aspect to Jupiter) to share sufficiently in the wealth produced with the aid of labor-saving machines (Uranus in 6th) that they provide a mass (Moon) purchasing (Jupiter) power.

So far as the finances of the people and general business conditions are concerned, this chart indicates that the whole period, 1928 to 1939, is one of adjustment to the mechanization not only of industry but also of the farm and home, as indicated by Uranus conjunction the ruler of the cycle and in aspect to nearly every planet in the chart.

To furnish examples, not of what is to be expected in the way of events from heavy and exceptional aspects in a Jupiter Cycle, but to give a clear picture of what should be expected also from the weak aspects, and those that occur at rather short intervals, probably the best method to follow is to take all the aspects that Jupiter forms within a given period in its cycle chart, and note one event under Jupiter's rule which was actually coincident with each such aspect. Commencing, therefore, with the Jupiter

Cycle of February 5, 1928, I will list, in their proper order of succession, ALL the progressed aspects that have formed, in so far as space permits, and quote the date, and event attracted, from the WORLD ALMANAC, my own comments being placed in parentheses. It will be apparent the events thus indicated are not inconsequential, for only the more important events are given mention in the WORLD ALMANAC.

On the Cycle: February 6, 1928, at Washington, the new arbitration treaty (Jupiter) with France was signed on the anniversary of the first Franco-American treaty of alliance, February 6, 1778.

February 11, 1928, Jupiter semi-sextile Mercury r: February 11, John D. Rockefeller Jr., testifying to the U. S. Senate Public Lands Committee in the Teapot Dome Oil inquiry, said he had tried in vain to persuade Col. R. W. Stewart, Chairman of the Standard Oil Co. of Indiana, to tell the committee all he, Stewart, knew of the Continental Trading Company's bonds (Mercury in the house of bonds).

February 13, 1928, Jupiter sesqui-square Moon r, opposition Asc. r (people): The New York City Transit Commission denied an Interborough plea for a 7-cent subway fare (Jupiter keeps prices up).

February 18, 1928, Jupiter square M.C. r: February 18, Mayor Walker (M.C.) of New York City, on a trip south hopped off the train at Baltimore and talked to the Advertising (Jupiter) Club about religious (Jupiter) prejudices.

March 9, 1928, Jupiter square Venus r: March 10, President Coolidge signed the alien property (Venus in house of real estate) bill, which calls for an expenditure (Jupiter) of about \$50,000,000 by the U. S. Treasury to cover the value of alien property seized when war was declared on Germany.

March 23, 1928, Jupiter sesqui-square Neptune r: March 23, U. S. authorities at New York City seized 5 tons of manufactured imported (commerce) quinine sulphate, alleging the Dutch owners are cornering the market (Jupiter) in violation of the antitrust (Neptune) provision of the Wilson Tariff Law.

March 24, 1928, Jupiter square Mars r: March 24, Albert D. Lasker, of Chicago, told the Senate oil probers at Washington, that in October, 1920, he gave \$25,000 in cash (Jupiter) to the late Fred W. Upham, the Treasurer of the National Committee.

April 1, 1928, Jupiter square Pluto r: April 1, L. S. Peterson, Dem., retiring postmaster at Douglas, Ga., shot and killed one of his clerks and himself. In a letter he accused Republicans of driving (gang methods of Pluto) him into debt by campaign money (Jupiter) levies.

April 4, 1928, Jupiter sextile Sun r: April 5, the \$5,210,000 of gold (Sun) which was received in New York from Soviet Russia on February 21, and which has been the center of international financial (Jupiter) and legal (Jupiter) turmoil, was sent back to Europe on the steamship Dresden.

April 8, 1928, Jupiter trine Saturn r: April 9, Jeddu Krishnamurti, the young Hindu who is accepted by Theosophist followers of Dr. Annie Besant as “a vehicle for the world teacher” (Jupiter), or spiritual equal of Christ and Buddha, arrived at New York City on the Leviathan.

April 15, 1928, Jupiter semi-square Mercury r: April 16, Dr. Walter F. Seymour, Superintendent of the Presbyterian Board of Missions (Jupiter) Hospital at Tsining, Southeastern Shantung, was shot to death by a Chinese soldier.

April 17, 1928, Jupiter trine Moon r: April 17, the U. S. Supreme Court declined to halt the action of the court below reversing the Interstate Commerce (Jupiter) Commission in the “Lake Cargo” coal case, prohibited the carriers in the South from making voluntary cut (Jupiter keeps prices up) in coal freight rates.

May 26, 1928, Jupiter trine Neptune r: May 25, the U. S. has collected to date over \$2,000,000 in back revenue (Jupiter) taxes revealed by Teapot Dome and Continental Trading Co. (Neptune rules oil) testimony.

June 8, 1928, Jupiter semi-sextile Uranus r: June 7, President Coolidge killed by a pocket veto, the Muscle Shoals bill calling for the U. S. Government operation (competing with private business) of the \$150,000,000 power plant on the Tennessee River in Alabama.

June 14, 1928, Jupiter sesqui-square Saturn r: June 14, Robert W. Stewart, Chairman of the Standard Oil Co. of Indiana, was acquitted by a jury (Jupiter) in the District of Columbia Supreme Court of contempt charges arising from his refusal to answer questions at the Senate Committee’s oil inquiry. The question concerned profits (Jupiter) of the Continental Trading Co.

June 17, 1928, Jupiter semi-sextile Jupiter r: June 15, near Bellville, Ill., an army dirigible balloon descended over a railway track as a train came in view. The airship crew, regulating the speed to correspond with that of the train, maneuvered into position over the mail coach. Then the dirigible was brought down over the train so low that the control car rested on top of the coach for a moment while a member of the crew handed a sack of mail to a clerk standing in the doorway of the coach (commerce and interstate transportation).

June 23, 1928, Jupiter sextile Mercury r: June 23, when the steamer (Mercury ruler of the 9th) Leviathan arrived at London from New York City, several of her sacks of registered mail (Jupiter ruling house of mail) were found to have been robbed; total loss not over \$10,000.

June 29, 1928, Jupiter inconjunct Asc. r: June 29, John Henry Mears and Captain B. B. Colyer, who are going to travel around the world (Jupiter ruling long journeys) by steamship and airplane in 23 days, left the Battery at 5:00 a.m. in a seaplane for Ambrose Channel Lightship. They got back to the Battery at 8:21.48 p.m., July 22, having circled the globe in 23 days, 15 hours, 21 minutes, 3 seconds.

July 2, 1928, Jupiter sextile M.C. r: July 2, interest rates (M.C. rules credit) on call money were raised (Jupiter raises prices) at New York City to 10% the highest since November 10, 1920.

August 10, 1928, Jupiter trine Venus r: August 10, Herbert Hoover, in the visible presence of 70,000 (Venus rules house of the people), and heard (Jupiter rules speeches given to the public) by radio by millions, delivered in the stadium of Stanford University, Calif., his speech of acceptance of the Republican presidential nomination.

September 18, 1928, Jupiter trine Venus r: September 18, Gov. A. E. Smith of New York, Democratic presidential candidate, reached Omaha, Nebr., in his special train, and made his first campaign address (Jupiter rules public speeches) there, mainly on farm (Venus in house of farm) problems.

October 29, 1928, Jupiter sextile M.C. r: October 29, dodging squalls and rain, the German airship Graf Zeppelin covered more than a third of the distance (Jupiter rules long journeys) to Friedrichshafen on her homeward flight after taking off from Lakehurst, N. J., at 1:55 a.m.

November 3, 1928, Jupiter inconjunct Asc. r: November 2, Gov. A. E. Smith was welcomed at New York City with a parade which was cheered by 1,500,000 (Asc. rules the public); he spoke (Jupiter rules public speeches) at night to a throng at the Brooklyn Academy of Music.

November 9, 1928, Jupiter sextile Mercury r: November 9, mail (Jupiter rules house of mail) robbers got \$53,000 in a train hold-up near Ft. Worth, Texas; all but \$2,970 was found hidden nearby and the bandits (Mercury ruler of house of crime) were captured.

November 18, 1928, Jupiter semi-sextile Jupiter r: November 17, The Board of Bishops of the M. E. Church of the World, at Atlantic City, publicly announced that under the decision of the General Conference of the Church (Jupiter) last May, ministers (Jupiter) may marry couples one or both of whom have been legally divorced.

November 24, 1928, Jupiter sesqui-square Saturn r: November 23, conductors and trainmen of Western railways (Saturn in house of railways) accepted a 6½% wage increase (Jupiter raises wages), retroactive to May 1, 1929, when their former agreement with the railways expired.

December 9, 1928, Jupiter semi-sextile Uranus r: December 9, "The St. Louis Post-Dispatch," in its fiftieth anniversary copyrighted edition, published (Jupiter) a 1,000-word article from President Coolidge, in which he tells of the many demands (Uranus in house of labor) on the time of the President, and suggests (a departure from tradition—Uranus) a country White House.

January 11, 1929, Jupiter semi-sextile Uranus r: January 11, testimony that the National Electric (Uranus) Light Association had contributed (expose—Uranus) \$80,000 between 1924 and 1928 to the General Federation of Women's Clubs, and that it also had paid \$600 each for twenty-four magazine articles (Jupiter), was presented to the Federal Trade (Jupiter) Commission.

January 25, 1929, Jupiter sesqui-square Saturn r: January 26, the Chicago Auditorium, which opened (public education ruled by Jupiter, although entertainment belongs to the 5th house) on December 10, 1889, with Gounod's Romeo and Juliet, closed (Saturn closes or otherwise restricts) with the same opera.

February 1, 1929, Jupiter semi-sextile Jupiter r: Col. Charles A. Lindbergh flew from Mineola, N. Y., to Jacksonville, Fla., refueled, flew to Miami; and on February 4 he opened the U. S. Central American air mail (Jupiter ruler of house of mail) from Miami to Havana, and thence to Belize, British Honduras (Jupiter rules long journeys).

February 15, 1929, Jupiter inconjunct Asc. r: February 15, The Interstate (Jupiter) Commerce Commission approved the plan submitted by a committee of railway executives under which the Railway Express Agency, which has been incorporated, will on March 1 acquire and operate practically the entire (Asc. rules the general public) express business of the country.

February 19, 1929, Jupiter sextile M.C. r: Herbert Hoover (M.C. rules president) returned to Washington from Florida and Secretary of State Kellogg, in an identical note delivered to diplomatic representatives of all governments which have signed the World Court (Jupiter) protocol, invited their governments to conduct an informal exchange of views among themselves with a view to admitting the United States into membership and participation in the court.

March 15, 1929, Jupiter trine Venus r: March 14, President Hoover issued an executive order that all future decisions of the Commissioner of Internal Revenue dealing with tax (Jupiter p in house of taxes) refunds in excess of \$20,000 (Jupiter) shall be open to public (Venus ruling house of public) inspection.

Chapter 6

Serial No. 146
Original Copyright 1938
Elbert Benjamine

Copyright
August 2002
Church of Light

The Cycles of Mars

Chapter 6

The Cycles of Mars

BECAUSE the planet for which a Cycle Chart is erected determines the things which exert the influence, the effects of which are shown by the positions of the various planets in the chart, the aspects made by this ruler of the Cycle are unusually important.

They represent trains of thoughts leading directly from the influencing condition to groups of people in the departments of national life indicated by the house positions of the aspected planets, and of the type indicated by these aspected planets. That is, the aspects of the planet for which the Cycle Chart is erected, indicate the types of people and the departments of national affairs most readily influenced by the energies which come under the cycle's rule.

Thus in the Mars Cycle Chart, illustrated at the front of this booklet, Mars in the 11th is also the ruler of the 12th (relief and crime) and of the 7th (foreign countries and war). It is sextile the M.C., therefore the strife and conflict it indicates tend to stimulate business; but as it is also semi-square Venus in the 10th, in certain respects it creates a friction in relation to business procedure that hampers prosperity. It is semi-square also to the Asc., so that the strife and aggression affect the personal welfare of many people. Its most important aspects, however, are the conjunction with the Sun in the 11th, influencing those high in political life, and the conjunction with the Moon in the 12th, bringing the populace an affliction through measures that must be taken for relief of the needy.

Thus while the other positions in the chart, such as Jupiter in the house of labor in opposition to Uranus in the house of relief, can not be overlooked in reading the figure, the thoughts of conflict and war, such as Mars rules, are shown to have direct access to the M.C., Venus, Asc., Sun and Moon, with greater facilities for influencing the persons ruled by these planets and positions—women, for instance, under Venus; politicians under the Sun, and the common mass of people under the Moon—and for stirring up unusual activities in the departments ruled by the houses in which these planets are found. That is, they have ready access to the 10th (business and administration), 11th (Congress and Governors) and to the 12th (charity, relief;

crime and prisons). And because the energy flows so readily to these persons and departments, they will respond in a more pronounced manner than other types of persons and other departments of national life. They, therefore, should receive special consideration in reading the Cycle Chart.

In any Cycle Chart there will be times when the planet for which the Cycle was erected makes progressed aspects to very few positions in the Cycle Chart. During such periods little activity will be shown regarding, and little attention on the part of the public will be paid to, the things ruled by the cycle. But when a period arrives during which the planet for which the Cycle Chart was erected makes many progressed aspects to the places of the various planets in the Cycle Chart, then will the things ruled by the Cycle come to the fore, exhibiting an activity which attracts much discussion and public attention. It is the progressed aspects that indicate the time the events shown come to pass.

The really important part of some events is not coincident with the final action taken; and when this is the case the progressed aspect in the Cycle Chart may occur somewhat before the final external act. That is, in negotiating a treaty or in a Supreme Court decision, the matter may be before the public attention, and be the cause of great interest and discussion, for considerable time before the actual signing of the treaty, or the actual publication of the decision reached by the Supreme Court. Under such circumstances, several of which have been noted in preceding lessons, the progressed aspect denoting the event may have moved more than the one degree, which we allow for an orb of influence for a progressed aspect, before the treaty is signed or the Supreme Court decision is handed down.

These events, however, should not be taken as exceptions to the general rule that events signified by a progressed aspect, either in the natal chart of an individual or in a Cycle Chart for a nation or city, come to pass while the aspect is within one degree of perfection.

A perusal of the newspapers at the time the aspect is perfect will show that the matter had reached a high state of public interest then, that the treaty was in the heat of discussion or the Supreme Court was engaged in deciding the matter; perhaps did decide the matter. The actual signing of the treaty or the handing down of the Court decision—the part alone which history records—was the result of the cumulative influence during the time the progressed aspect was within one degree of perfect. But it may have been something that consumed so much effort that by the time the final act, which history records, was taken, the ruler of the Cycle Chart had moved somewhat beyond the orb of its influence.

Minor Events Are Shown by Progressions in Other Cycle Charts

We must not expect all the events of national consequence influenced by Mars to be coincident with progressed aspects in the Mars Cycle Chart; all the financial events to be shown in the Jupiter Cycle; all the abrupt changes and radical activities in the Uranus Cycle. A progressed aspect in any Cycle Chart to the planet Mars tends to bring strife and accidents. A progressed aspect in any Cycle Chart to Jupiter brings financial matters to the fore. A progressed aspect to Uranus in any Cycle Chart tends to give prominence to sudden alterations and radical activities. In a like manner, an aspect in any Cycle Chart to Saturn attracts events having to do with safety, loss or poverty, any aspect to Neptune brings something to do with inflation or aviation, and any aspect to Pluto coincides with drastic action and cooperative effort.

Yet these events, shown by progressed aspects to planets in Cycle Charts not ruling the type of happening, are of much less consequence than those which are shown in the Cycle Chart which relates directly to the kind of event which comes to pass. These minor occurrences are played up in the newspaper headlines on the day they occur; but are not of significance enough to enter into historical records.

Thus when we take a reference history, such as I have consulted in the preparation of these lessons; because only the important events of a kind are there recorded, we may be sure that each date will coincide with an adequate progressed aspect in the Cycle Chart governing the type of event recorded. Furthermore, by consulting a record in which one or more of the outstanding events for each day of each year are recorded, we may be sure that we can find on the proper day the appropriate event for each progressed aspect made in the various Cycle Charts.

But, because a daily record, such as that in the World Almanac, covers many minor events, in addition to the major ones, we can not expect to find for each event there recorded a progressed aspect in the Cycle governing the event. Many of these events are indicated, not in the Cycle governing the event, but in the Cycle Charts of other planets, by a progressed aspect to Mars showing fire, to Saturn showing loss by hardship, etc.

Mars in Mundane Astrology

Mars is the most energetic of all the planets. It indicates the creative energy in operation. When it is harmoniously directed, therefore, it relates to all constructive activity in which force, quick action, or even violence is involved. Manufacturing and industrial progress, therefore, are typical of Mars. Those who guard the nation—soldiers and members of the navy—and those who guard the more immediate security of the population—policemen, sheriffs and other law-enforcement officers—are under his rule, and aspects to Mars tend to bring to pass events in which they are active.

Surgeons and the operations they perform come under this influence. Fires and firemen are also right in line, as are hunters, industrial workers, and those who engage in sports such as baseball, football, wrestling and boxing, in which muscular power and combat play an important part.

The energy of Mars moves so fast that, unless quite harmonious, it tends to accidents. Traffic accidents, for instance, may be looked for on the days Mars makes a progressed aspect in its Cycle Chart; more of them, of course, if Mars or the aspected planet is in the 3rd house.

The energy of Mars is so powerful that when it meets resistance there are destructive activities. Explosions, banditry, burglary and other violent defiance of the law, as well as acts of violence and combat in general, come under his jurisdiction. Intoxicants, being violent in their affect; drunkenness, gambling, houses of ill fame, assault, military activities and war are typical expressions of Mars. Even when harmonious his energy tends to so much force and speed that strife of some kind is always present in the events he brings to pass.

In thought he rules mechanics, in business he rules manufacturing and the military professions, and in politics he rules industrial workers (as apart from farmers and miners and other laborers ruled by Saturn), the law enforcement agencies, such as policemen, and the army and navy.

Calculating the Mars Cycles

Very recently the Nautical Almanac has discontinued giving the variation per hour of declination of the planets, and gives only the variation for the whole day of 24 hours instead. As this change might cause confusion in the minds of some students unless examples are given showing how to calculate the time when a planet crosses from south to north declination under both types of notation for the variation, I will present four examples of calculating the time for erecting a Mars Cycle. The first two, April 27, 1930, and April 5, 1932, are on dates when the Nautical Almanac still gives the variation in declination per hour. The last two, March 17, 1934, and Feb. 24, 1936,

are on dates since the Nautical Almanac adopted the plan of giving the variation in declination per day only. As we wish to know the influence of these Mars Cycles on the affairs of the United States, the problem is to ascertain the times at Washington, D.C.) when Mars crossed from south declination to north declination.

The Nautical Almanac for 1930 gives the declination of Mars each day for Greenwich Civil Time (commencing at midnight), together with the variation per hour. The position on April 28 is given as minus 0 degrees, 3 minutes, 15.0 seconds. The variation per hour is given as 46.40 seconds. That is, Mars, moving 46.40 seconds per hour, on April 28, must move 3 minutes, 15.0 seconds to reach north declination.

One hour equals 60 minutes. 3 minutes, 15.0 seconds equal 195 seconds. Then $46.40:60 :: 195:?$ The answer is 252 minutes, which equal 4 hours, 12 minutes. Thus the Greenwich Time sought is April 28 1930, 4:12 a.m. As Washington is 77 degrees west, subtract from this 5 hours, 8 minutes, and it gives the time for which the Mars Cycle must be erected as April 27, 1930, 11:04 p.m. L.M.T. 77W. 38—56N The chart for the time so found is No. 351 in the table at the front of this booklet.

The Nautical Almanac for 1932 gives the declination of Mars each day for Greenwich Civil Time (commencing at midnight), together with the variation per hour. The position on April 6 is given as minus 0 degrees, 0 minutes, 20.1 seconds. The variation per hour is given as 47.19 seconds. That is, Mars, moving 47.19 seconds per hour, on April 6, must move 20.1 seconds to reach north declination.

One hour equals 60 minutes. Then $47:19 :60::20.1:?$ The answer is 26 minutes. Thus the Greenwich Time sought is April 6, 1932, 0:26 a.m. As Washington is 77 degrees west, subtract from this 5 hours, 8 minutes, and it gives the time for which the Mars Cycle must be erected as April 5, 1932, 7:18 p.m. L.M.T. 77W. 38:56N. The chart for the time so found is No. 352 in the table at the front of this booklet.

The Nautical Almanac for 1934 gives the declination of Mars each day for Greenwich Civil Time (commencing at midnight), together with the variation per day. The position on March 17 is given as plus 0 degrees, 8 minutes, 8.1 seconds. The variation per day is given as 1140.1 seconds. 1140.1 seconds divided by 24 (hours in a day) gives 47.50 seconds as the variation per hour. That is, Mars, moving 47.50 seconds per hour, on March 17 has moved 8 minutes, 8.1 seconds into north declination.

One hour equals 60 minutes. 8 minutes, 8.1 seconds equal 488.1 seconds. Then $47.50 :60:: 488.1: ?$ The answer is 617 minutes, which equal 10 hours, 17 minutes. From 00:00 Civil Time March 17, subtract 10 hours, 17 minutes and it gives March 16, 1:43 p.m. Greenwich Time. As Washington is 77 degrees west, subtract from this 5 hours, 8 minutes, and it gives the time for which the Mars Cycle must be erected as March 16, 1934, 8:35 a.m. L.M.T. 77W. 38:56N. The chart for the time so found forms the illustration at the front of this booklet.

The Nautical Almanac for 1936 gives the declination of Mars each day for Greenwich Civil Time (commencing at midnight), together with the variation per day. The position on February 24 is given as plus 0 degrees, 1 minute, 58.5 seconds. The variation per day is given as 1134.4 seconds. 1134.4 seconds divided by 24 (hours in a day) gives 47.43 seconds as the variation per hour. That is, Mars, moving 47.43 seconds per hour, on February 24 has moved 1 minute, 58.5 seconds into north declination.

One hour equals 60 minutes. 1 minute, 58.5 seconds equal 118.5 seconds. Then 47.43 :60: : 118.5: ? The answer is 150 minutes, which equal 2 hours, 30 minutes. From 00:00 Civil Time February 24, subtract 2 hours, 30 minutes, and it gives February 23, 9:30 p.m. Greenwich Time. As Washington is 77 degrees west, subtract from this 5 hours, 8 minutes, and it gives the time for which the Mars Cycle must be erected as February 23, 1936, 4:22 p.m. L.M.T. 77W. 38:56N. The chart for the time so found is No. 353 in the table at the front of this booklet.

The Cycles of Mars

As examples from which to study the influence of Mars, and what may be expected from progressed aspects formed in its Cycle Chart, I will first commence with the Mars Cycle of 1889, and quote (with my own comments in parentheses) every event that is clearly under the influence of Mars which is of enough importance to be included in the Reference History of the World of Webster's New International Dictionary. Omitting none of these as far as available space warrants us considering them, the progressed aspect in the Mars Cycle coincident with each will be pointed out.

Then, as the second phase of our Mars study, we will take the Mars Cycle of March 16, 1934, which forms the illustration at the front of this booklet, and starting with its commencement, I will list ALL the progressed aspects in that Mars Cycle, and go as far as space permits, indicating the event attracted by each of these progressed aspects.

Mars Cycle No. 78 in the table commenced February 18, 1889, 5:54 p.m. L.M.T. 77W. 38:56N.

April 22, 1889, under Mars, ruler of the house of lands, sesqui-square Jupiter r in the house of lands (fourth): Part of Indian Territory is opened, and a wild rush to settle ensues. (The opening of the land was under the Saturn Cycle, but the wild rush and the extreme violence which accompanied it were under Mars.)

Mars Cycle No. 79 in the table commenced January 27, 1891, 4:59 p.m. L.M.T. 77W 38:65N.

March 14, 1891, under Mars trine Moon r, in the house of death (eighth), and ruler of foreign countries (seventh): Lynching of eleven Italians in New Orleans causes a protest and demand for reparations by Italy, her minister at Washington being recalled. (The mob activity is indicated in the Pluto Cycle by Pluto sextile Moon r.)

October 16, 1891, while Mars was still four degrees from square Asc. r and opposition Mars r; Attack on American Sailors by a mob at Valparaiso, Chile. War becomes imminent (as aspect completes) through Chile's delay to make amends. (The mob activity is indicated in the Pluto Cycle by Pluto sextile Moon r and sesqui-square Venus r.)

January 21, 1892, as Mars approaches trine Mars r: Ultimatum presented to Chile.

January 25, 1892, as Mars completes the trine to Mars r: Harrison sends a war message to Congress; but Chile soon apologizes and pays an indemnity.

July 15, 1892, under Mars inconjunct Saturn r: Harrison issues proclamations against striking miners in the West (strikes are under the Uranus influence), and Federal troops (ruled by Mars) are used in restoring order and to support injunctions of the Federal courts.

Mars Cycle No. 80 in the table commenced December 28, 1892, 2:35 p.m. L.M.T. 77W 38:56N.

February 14, 1893, under Mars conjunction Moon r (populace): Treaty of annexation with Hawaii is signed. This follows a revolt led by Americans, assisted by the American minister, and protected by American Marines (Mars), by which the queen is deposed. Not ratified.

June 26—July, 1894, under strikes (Uranus) started June 26, when Mars came to semi-sextile Moon r: Local troops (Mars) are called out in many places, and President Cleveland, without waiting for requests from State executives, employs Federal troops (Mars), especially at Chicago, to protect the railroads (ruled in the Cycle Chart by the Moon).

Mars Cycle No. 81 in the table commenced July 14, 1894, 5:30 a.m. L.M.T. 77W. 38:56N.

September, 1894, under Mars square Mercury r, and Mars semi-sextile Venus r, ruler of homes (fourth): Forest fires destroy 19 towns in Minnesota, Wisconsin, and Michigan, and 500 people are killed.

December 17, 1895, under Mars trine Mercury r, ruler of messages (third), and Mars semi-square Saturn in the house of lands (fourth): Cleveland's message on Venezuela and British Guiana boundary controversy holds that the rights of the United States under the Monroe Doctrine is involved in Great Britain's refusal to arbitrate with Venezuela.

Mars Cycle No. 82 in the table commenced May 26, 1896, 3:26 p.m. L.M.T. 77W. 38:56N.

July 30, 1896, under Mars semi-square Mars r, and opposition Uranus r (revolt): President's proclamation warning citizens against violating the neutrality laws by aiding the insurrection in Cuba.

February 15, 1898, under Mars opposition Jupiter r and sextile Mars r, ruler of war (seventh): U.S.S. Maine blown up in Havana harbor; more than 250 lives lost (leads to war with Spain).

March 10, 1898, under Mars square Uranus r in the house of money (second): Congress empowers the president to spend \$50,000,000 for national defense.

March 28, 1898, under Mars square Moon r: President sends to Congress report of Court of Inquiry into Maine disaster, attributing it to external cause.

April 11, 1898, under Mars square Neptune r: President suggests that he be empowered to use the army and navy to end disorders in Cuba, and placed with Congress the responsibility for dealing decisively with the "intolerable condition of affairs which is at our doors."

April 20, 1898, under Mars sextile Venus r and square Mercury r: Resolutions are passed by Congress that the United States intervene in Cuba to enforce her independence. Spanish minister leaves Washington same day. American fleet sails April 21 from Key West to blockade Cuban ports. April 23, while same aspects are within orb: President calls for 125,000 volunteers. April 25: Congress declares that war with Spain has existed since April 21 (when aspects were perfect).

May 1, 1898, under Mars conjunction Mars r: Dewey with Pacific fleet attacks and destroys Spanish fleet of ten ships in Manila Bay.

Mars Cycle No. 83 in the table commenced May 2, 1898, 6:50 a.m. L.M.T. 77W. 38:56N.

May 25, 1898, under Mars sextile Neptune r in house of people (first): President calls for 75,000 additional volunteers. 2,500 soldiers are sent from San Francisco to support Dewey in his operations against Manila.

June 2, 1898, under Mars sesqui-square Saturn r, ruler of ships (ninth): The fleet, under Sampson, blockades Santiago, Cuba, preventing the exit of the Spanish fleet under Cervera. On June 3 (same progressed aspect), Lt. Richmond P. Hobson sinks the Merrimac in the channel as an obstacle to the escape of the Spanish fleet.

June 10, 1898, under Mars semi-sextile Mars r and inconjunct Uranus r: Invasion of Cuba by the Americans begins with the landing of 600 marines at Guantanamo Bay, near Santiago. June 12, under same progressed aspects: Fifth Army Corps, 16,000 men under Shafter, sails from Tampa Bay for Santiago.

June 20, 1898, under Mars conjunction Mercury r: Guam seized by U.S.S. Charleston.

June 30, 1898, under Mars semi-square Mars r: First U.S. troops reach Manila. The outer defenses of Santiago de Cuba are carried by Shafter.

July 3, 1898, under Mars semi-sextile Neptune r: Cervera's fleet of six war vessels, escaping from Santiago harbor, completely destroyed by American fleet under Sampson.

July 17, 1898, under Mars conjunction Venus r (2 degrees distant): Santiago with all its forces is surrendered to Shafter.

July 23, 1898, under Mars opposition Uranus r: Spain inquires on what terms the United States would cease hostilities. July 25, as aspects has separated 2 degrees: General Miles lands with an army at Guanica and begins the conquest of Puerto Rico.

July 28, 1898, under Mars applying to opposition Saturn r (3 degrees distant): Ponce surrenders.

August 12, 1898, under Mars conjunction Asc. r and Pluto r (3 degrees past): A protocol is signed at Washington suspending hostilities. August 13, Manila surrenders to General Merritt and Admiral Dewey.

February 4, 1899, under Mars sextile Moon r: Filipinos attempt to capture Manila, but are repulsed with heavy loss. This begins the Philippine Insurrection.

July 19, 1899, under Mars square Neptune r: Sec. of War Alger resigns because of severe criticism of conduct of Spanish War.

December 16, 1899, under Mars square Mars r: Leonary Wood appointed military (Mars) governor of Cuba.

Mars Cycle No. 84 in the table commenced April 10, 1900, 7:31 p.m. L.M.T. 77W. 38:56N.

June 21, 1900, under Mars semi-sextile Neptune r: General MacArthur issues amnesty proclamation to Fillpinos.

November 12, 1900, under Mars sextile Neptune r: Military department of Porto Rico is discontinued and the forces there reduced.

February 2, 1901, under Mars square Jupiter r: Army Reorganization Act. Provides for a minimum army of 58,000 men, with a maximum of 100,000.

September 6, 1901, under Mars sextile Saturn r, conjunction Asc., and inconjunct Venus in the house of death (eighth): McKinley shot by an anarchist. He dies September 14. (The death is shown in the Saturn Cycle.)

December 13, 1901, under Mars inconjunct Pluto r: Findings of Court of inquiry as to Admiral Schley's conduct in Cuba (war) indecisive.

February 18, 1902, under Mars opposition Moon r in house of honor (tenth): Roosevelt adds a memorandum declaring that neither Sampson nor Schley was responsible for the victory at Santiago; it was a "captain's fight."

Mars Cycle No. 85 in the table commenced March 21, 1902, 6:30 a.m. L.M.T. 77W. 38:56N.

May 22, 1902, under Mars semi-square Mars r (2 degrees past): Military occupation of Cuba ends.

May 31, 1902, under Mars trine Saturn r (planet of economy): Army ordered reduced from 77,287 to 66,497.

July 4, 1902, under Mars trine Venus r (2 degrees applying): General amnesty in Philippines, and insurrection is declared at an end.

September 17, 1902, under Mars opposition Jupiter r: Secretary Hay protests against the outrages committed on Jews in Roumania.

January 21, 1903, under Mars semi-square Moon r in house of soldiers: Dick Militia Law provides for the optional federalization of State troops.

February 14, 1903, under Mars trine Pluto r: General Staff of the army is authorized.

Mars Cycle No. 86 in the table commenced March 29, 1903, 4:47 p.m. L.M.T. 77W. 38:56N.

November 3, 1903, under Mars opposition Neptune r, in the house of business (tenth): Panama revolts from Colombia. Independence is recognized by the United States on November 6. United States troops land to protect the canal and fend off Colombian forces.

February 7-8, 1904, under Mars square Pluto r (2 degrees distant): Great fire in Baltimore with loss (more clearly shown in Saturn Cycle) of \$80,000,000.

Mars Cycle No. 87 in the table commenced February 28, 1904, 5:40 a.m. L.M.T. 77W. 38:56N.

April 15, 1904, under Mars, ruler of the house of gifts (eighth), square Venus r in the house of chances (fifth): Andrew Carnegie establishes a Hero (Mars) Fund of \$5,000,000.

June 8, 1905, under Mars trine Sun r in house of war (seventh): Roosevelt offers his good offices to end the Russo-Japanese War.

Mars Cycle No. 88 in the table commenced February 6, 1906, 3:07 a.m. L.M.T. 77W. 38:56N.

September 22-24, 1906, under Mars trine Uranus r (planet of riots): there are race riots in Atlanta; eighteen Negroes and three whites killed.

September 29, 1906, under Mars sextile Moon r in the house of war: Military control over Cuba is resumed because of disturbed conditions there.

November 6, 1906, under Mars inconjunct Saturn r: Roosevelt directs the dismissal of three companies of Negro regulars for disturbances at Brownsville, Texas, on August 13.

February 6, 1907, under Mars trine Mars r in the house of relief (twelfth): Graduated pensions are granted to veterans of Mexican and Civil wars of 62 years of age or more; following an executive order making 62 years a pensionable disability.

December 16, 1907, under Mars trine Moon r in house of war (seventh): Around-the-world voyage of the American fleet of 16 battleships with destroyers begins at Hampton Roads, intended as a peaceful display of force, especially to influence Oriental conditions.

Mars Cycle No. 89 in the table commenced January 11, 1908, 9:35 p.m. L.M.T. 77W. 38:56N.

January 28, 1909, under Mars inconjunct Neptune r in house of business (tenth): Second military occupation of Cuba by United States troops terminates.

Mars Cycle No. 90 in the table commenced November 25, 1909, 3:45 p.m. L.M.T. 77W. 38:56N.

October 17, 1910, under Mars in house of illness (sixth), opposition Saturn r in house of hospitals (twelfth): The Rockefeller Institute for Medical Research is formally opened at New York City.

November 2, 1910, under Mars semi-sextile Mercury in the house of foreign countries (seventh): A fleet of sixteen American battleships sails, in two detachments, to pay visits at ports of England and France.

March 7, 1911, under Mars inconjunct Pluto r, ruler of the house of foreign countries (seventh): In consequence of revolution in Mexico, the president orders 20,000 troops to San Antonio and along the Mexican frontier, for division maneuvers and to check filibustering and border fighting on the American side.

That the student may have for reference all the Mars Cycles from 1889 to 1938, I will now list both their numbers in the table at the front of this booklet and the data on which they were erected:

No. 91, Mars Cycle, June 9, 1911, 12:10 a.m. L.M.T. 77W. 38:56N.

No. 92, Mars Cycle, May 12, 1913, 12:24 a.m. L.M.T. 77W. 38:56N.

No. 93, Mars Cycle, April 19, 1915, 6:42 p.m. L.M.T. 77W. 38:56N.

No. 94, Mars Cycle, March 29, 1917, 12:36 a.m. L.M.T. 77W. 38:56N.

No. 95, Mars Cycle, March 8, 1919, 1:42 p.m. L.M.T. 77W. 38:56N.

No. 96, Mars Cycle, February 14, 1921, 1:09 p.m. L.M.T. 77W. 38:56N.

No. 97, Mars Cycle, January 22, 1923, 6:55 a.m. L.M.T. 77W. 38:56N.

No. 98, Mars Cycle, December 20, 1924, 7:15 a.m. L.M.T. 77W. 38:56N.

No. 99, Mars Cycle, June 23, 1926, 7:28 a.m. L.M.T. 77W. 38:56N.

No. 350, Mars Cycle, May 21, 1928, 9:21 a.m. L.M.T. 77W. 38:56N.

No. 351, Mars Cycle, April 27, 1930, 11:04 p.m. L.M.T. 77W. 38:56N.

No. 352, Mars Cycle, April 5, 1932, 7:18 p.m. L.M.T. 77W. 38:56N.

Illustration Mars Cycle, March 16, 1934, 8:35 a.m. L.M.T. 77W. 38:56N.

No. 353, Mars Cycle, February 23, 1936, 9:30 p.m. L.M.T. 77W. 38:56N.

Another Mars Cycle, January 31, 1938, 1:55 p.m. L.M.T. 77W. 38:56N.

Later Mars Cycles, previous to their commencement, will be Published in THE CHURCH OF LIGHT QUARTERLY.

And now, to furnish examples, not of what is to be expected in the way of events from heavy and exceptional aspects in a Mars Cycle, but to give a clear picture of what should be expected also from the weak aspects, and those that occur at rather short intervals, it seems that the best method to follow is to take all the aspects that Mars forms within a given period in its cycle chart, and note one Mars event which actually was coincident with each such aspect. Commencing, therefore, with the Mars Cycle of March 16, 1934, which forms the illustration at the front of this booklet, I will list ALL the progressed aspects in the chart following its date, going as far as space permits, and quote the date, and the event attracted, from the WORLD ALMANAC, my own comments being placed in parentheses. As only the most important events of each day are listed in the WORLD ALMANAC, it will be apparent these events are not inconsequential. When the event falls on a day other than that on which the aspect is perfect, this will be duly noted.

March 20, 1934, Mars semi-square Asc. r (people): Fire at Hakodate, Japan, killed over 1,500, hurt 2,000, and destroyed 23,000 homes. At N. Y. City, 7 were killed by fire in a tenement on 2nd Ave.

March 23, 1934, Mars semi-sextile Mercury r: March 24, at Lynchburgh, Va., fire killed 14 at Federal Transient Relief (progressed Mars in house of relief, twelfth) Bureau, and injured 75 others.

March 26, 1934, Mars conjunction Moon r in house of relief (twelfth): At Washington, the Senate and the House passed the "billion dollar" Independent Office Bill granting \$228,000,000 in larger allowances to War veterans and government employees.

March 28, 1934, Mars inconjunct Neptune r (inflation): The United States Steel (Mars) Corporation and the Bethlehem Steel Corporation joined the movement to raise the wages of all steel workers 10 per cent.

April 1, 1934, Mars semi-sextile Venus r (in the house of the President): The President of the United States conducted divine service on the quarterdeck of the Nourmahal, Easter morning, attended by the officers and men of the U.S. Destroyer (Mars) Ellis.

April 11, 1934, Mars opposition Jupiter r from the house of imprisonment (twelfth): At Tokyo, Gen. Senjuro Hayashi, Minister of War (Mars) resigned from the Cabinet after his younger brother was sentenced to ten month's imprisonment for bribery.

April 12, 1934, Mars square Pluto r in house of short journeys (third): His plane caught in a "sleeve target" towed by another airplane, First Lieutenant David L. Cloud Jr., a Marine (Mars) Corps pilot whose squadron held the Schiff award for safe flying, plunged 3,000 feet to his death.

April 14, 1934, Mars sextile Saturn r, in house of elections (tenth): At San Juan, P.R., fire in the Capitol basement destroyed part of Puerto Rico's basic election records.

April 16, 1934, Mars conjunction Uranus r (unusual), semi-sextile Sun r in house of governor (eleventh): In Oklahoma, the National Guard (Mars) carried out the Governor's orders to stop delinquent tax sales of real estate.

April 23, 1934, Mars square M.C. r (honor): At Crocket, Texas, Ben Ellis shot to death in a crowded courtroom a Negro accused of slaying his uncle who had tried to collect a \$3.00 debt.

April 24, 1934, Mars semi-sextile Mars r (war equipment): At Balboa, C. Z., commercial vessels started late in the day to follow the last of the more than a hundred ships of the U.S. fleet which have been pushing through the Panama Canal toward the Atlantic in an unbroken line.

May 1, 1934, Mars sextile Mercury r: At Paris, May Day brought riots, with Communists firing at police from behind barricades. At Havana 10 were wounded when soldiers fired into a worker's parade.

May 5, 1934, Mars semi-sextile Moon r: N. Y. City Controller W. Arthur Cunningham, 39, was stricken with a heart attack while horseback riding at Duck Island, L. I. He fell (Mars) to the ground and was dead when a physician arrived.

May 6, 1934, Mars trine Neptune r (aviation), semi-square Sun r: May 7, the Army (Mars) Air Corps ended its task of flying the transcontinental mail with a flying record.

May 11, 1934, Mars square Venus r in house of business (tenth): In Illinois, the Legislature enacted that, on and after July 1, State and municipal employees of Illinois will become the policing (Mars) agency behind all national codes.

May 19, 1934, Mars conjunction Asc. r: Fire at the Union Stock Yards, Chicago, burned its way over 8 square blocks destroying 40 per cent of the cattle pens, and the livestock in them.

May 22, 1934, Mars inconjunct Jupiter r: Mexico proclaims an embargo on shipment of arms (Mars) to Bolivia and Paraguay.

May 24, 1934, Mars square Saturn r in house of business (tenth): At Toledo, 2 men were killed and more than 25 persons were injured in two battles between Ohio National Guardsmen and strikers.

May 25, 1934, Mars semi-square Moon r in house of crime (twelfth): At East Chicago, Ind., two policemen were shot to death when they tried to halt an auto supposed to contain John Dillinger.

May 27, 1934, Mars sextile Sun r (political authority): At Havana, Cuba, gunmen fired several shots at his home as U.S. Ambassador Jefferson Caffery was preparing to leave.

June 4, 1934, Mars sextile Mars r: Near Norman, Oklahoma, members of a seismograph oil exploration party were killed in an accidental explosion of a roadside dynamite magazine.

June 11, 1934, Mars square Mercury r, sesqui-square Jupiter r: Prof. Rexford G. Tugweli, ex-farmer, Presidential nominee for Undersecretary of Agriculture, under examination as to his qualifications by the Senate (Mercury in house of Senate) Committee on Agriculture, denies he is a Red or a Bolshevik Communist.

June 13, 1934, Mars semi-square Pluto r (gangsters): Bandits fatally shot C. N. Nunn, 55, of Muskogee, Democratic candidate for presidency.

June 15, 1934, Mars sextile Moon r in house of secret enemies (twelfth): In Cuba a bomb hidden under a stairway exploded in the naval station, killing a sailor and seriously wounding 11 others.

June 17, 1934, Mars semi-square Uranus r (revolution), square Neptune r: In Cuba, at Havana, 14 persons were killed and more than 60 wounded when a parade of 80,000 members of the ABC revolutionary organization was attacked by machine gunmen.

June 22, 1934, Mars trine Venus r: The yawl Cumberbunce II was stolen at New London, Conn., after the Harvard-Yale rowing race. On June 29, James A. Newton, 43, a farmer of Marlow, N. H., was found shot to death on the yawl in Cohasset harbor.

June 30, 1934, Mars semi-sextile Asc. r: In Germany (Mars rules the house of other lands, seventh), a plot by prominent Nazi leaders to overthrow Adolph Hitler was discovered; Ex-Chancellor Gen. Kurt von Schleicher, 51, was shot to death, his wife killed, Capt. Ernst Roehm, 46, national commander of the Nazi Storm Troopers was deposed and executed. In all 77 were killed.

July 3, 1934, Mars trine Jupiter r: In Germany (Mars rules the house of foreign countries, seventh), Chancellor Hitler flew to Neudeck to consult President von Hindenburg; von Papen's home was watched by Storm Troopers (Mars).

July 4, 1934, Mars semi-sextile Pluto r (drastic): Over 2,200 were hurt by fireworks during Independence Day celebrations at New York City.

July 6, 1934, Mars trine Saturn r in house of business (tenth): A bomb planted in a war of rival labor unions destroyed the ventilation plant of the Capital Coal Mining Company near Springfield, Ill., endangering 350 men working below.

July 9, 1934, Mars square Sun r, sextile Uranus r: A Negro, Andrew McLeod, 26, at Bastrop, La., charged with having tried to attack a white girl, was lynched by a mob.

July 14, 1934, Mars sesqui-square Venus r in house of business (tenth): Over 7,000 National Guardsmen and 2,000 policemen were put on duty in the bay district and Oakland (due to strike).

July 16, 1934, Mars inconjunct M.C. r (business): National Guard tanks and machine guns were put at strategic points (S. F. strike).

July 18, 1934, Mars square Mars r: At San Francisco, the General Strike Committee lifted the embargo on all foods, gasoline and fuel oil. At Oakland, across the bay, citizen-vigilantes guarded food and milk trucks.

July 25, 1934, Mars trine Mercury r: At Vienna (Mars rules the house of foreign countries, seventh) a group (Nazi) seized the building used by the Cabinet, shot Chancellor Engelbert Dollfus, 41, to death, and tried to hold other members as hostages.

July 29, 1934, Mars square Moon r in house of crime (twelfth): At Vienna, Otto Planetta, 36, dismissed from the Austrian Army as a Nazi, was put on trial charged with the actual shooting of Chancellor Dollfus.

July 31, 1934, Mars sextile Neptune r: August 1, at Port Au Prince, the United States relinquished control of Haiti in brief ceremonies marking the taking over of the Haitian Army (Mars) by its own officers.

August 6, 1934, Mars inconjunct Venus r: August 7, at Vienna, the only active member of the Austrian Army (Mars rules the house of foreign countries, seventh) who participated in the raid on the Chancellery was court-marshaled and hanged.

August 14, 1934, Mars trine Moon r: In Colombia, 17 were killed, 20 hurt, at Tolime Farm, in a clash between peasants and Civil Guards.

August 17, 1934, Mars sesqui-square Mercury r, ruling house of games (fifth), square Jupiter r: August 18, at Pontiac, Ill., a fight over a baseball game at the State Reformatory, caused a riot and the shooting of 23 convicts.

August 19, 1934, Mars conjunction Pluto r (gangster): Alphonse Capone (gangster) is one of 43 en route in barred railway cars from the Federal Penitentiary at Atlanta, Ga., to Alcatraz Island.

August 20, 1934, Mars inconjunct Saturn r in house of government (tenth): In Louisiana, Governor Allen signed the 27 Huey P. Long "dictator (Mars conjunction Pluto, the dictator, yesterday) bills." Meantime State troops and 500 special police under Mayor Wamsley are rival guards at the registration office in New Orleans.

August 23, 1934, Mars trine Sun r, square Uranus r, semi-square Neptune r: Homer Van Meter, 35, paroled convict from the Michigan City (Ind.) prison (Uranus in house of prisons, twelfth) and one of the members and best gunner of the gang that was headed by John Dillinger, was shot and killed in a street battle with St. Paul police.

August 31, 1934, Mars opposition M.C. r (business): Extension of the textile strike call to 150,000 wool and worsted workers in N. J. was announced.

September 1, 1934, Mars trine Mars r: Strike orders applying to the entire textile weaving industry of the U.S. went into effect.

September 10, 1934, Mars inconjunct Mercury r ruler of fifth: At Tyler, Texas, J. B. Willis, 41, ex-convict, was sentenced to death for tying a young husband nude to a tree and then stripping and assaulting the bride.

September 16, 1934, Mars sesqui-square Sun r, semi-sextile Neptune r: September 17, the textile strike brought martial law and concentration camps in Georgia.

September 22, 1934, Mars opposition Venus r: Pointing at the guards pistols made of soap, two cronies of the late John Dillinger tried to escape from death cells, both were killed.

September 24, 1934, Mars sesqui-square Mars r: At Lyman, S. C., 400 former strikers were driven away by the bayonets of National Guardsmen.

September 30, 1934, Mars square Asc. r (people): In a radio speech to the nation, Roosevelt called a truce between capital and labor.

October 3, 1934, Mars sextile Jupiter r: Assignment of naval officers to American merchant ships to inspect safety devices and lifeboat drills.

Chapter 7

Serial No. 147
Original Copyright 1938
Elbert Benjamine

Copyright
August 2002
Church of Light

Major Conjunctions

Chapter 7

Major Conjunctions



WHEN two planets in the sky come together, forming the conjunction aspect, it signifies that the things on earth ruled by these two planets also have come together in such a manner as to influence world affairs, national affairs and the affairs of cities. The type of influence exerted depends upon the type of energy radiated by the two planets involved in the aspect; and its harmony or discord depends upon the friendliness or enmity of the two planets forming the conjunction, and the way they are aspected at the time by the other planets.

To be more specific: if Mars is one of the planets in the conjunction, events are influenced by machines, manufacturing, industrial workers, soldiers and such things as are ruled by Mars. And because that is the type of influence of the Mars vibration, what comes to pass will involve accident or strife. If Jupiter is the other planet in conjunction, affairs are influenced by treaties, commerce, business, money, religion and the other things Jupiter rules. And because the vibrations of Jupiter are of that type, abundance of something and a tendency toward expansion will be involved.

On the other hand, if Saturn is the other planet making the conjunction, conditions will be influenced by the farmer the miner the common laborer lands mines, basic utilities, conservatism, and such other matters as Saturn rules. And because Saturn's vibrations are of that type, selfishness, greed, contraction and lack will be involved.

Not all the affairs of national life will be affected profoundly by the conjunction of two major planets. The house of the chart, erected for the time of the conjunction, in which the conjunction falls indicates a department of life strongly influenced by the coming together of the two groups of factors. And how the converging affairs influence other departments of life is shown by the aspects to other planets in the chart, their house positions and rulerships revealing the departments of life affected. Powerful aspects from the conjunction to other planets show, by the house positions of those planets, the departments of life chiefly affected. The nature of the aspect, and the planet aspected, indicate in what manner the department of life is affected.

When the planets form aspects in the sky, the union of their energy streams produce whirls and vortices which increase the power of these planetary energies to influence the unconscious minds of men.

Within the astral body of each individual are groups of thought-cells which act as receiving sets for the energies broadcast by each of the ten astrological orbs. The position of a particular planet in the birthchart maps the place within the unconscious mind where are located the thought-cells which act as a natural receiving set for the vibrations of that planet.

When, therefore, this planet is powerfully aspected in the sky, the unconscious minds of people in general are more noticeably influenced by its trend; not because they are more receptive to this planet's energies, but because this planet's energies reach them much more vigorously. More energy then is added to the thought-cells mapped by the planet in their birth charts, and because these thought-cells thus acquire a more than normal activity, they take a more prominent part in determining the thinking, the behavior and the type of events which are attracted.

Furthermore, due to the birth charts of nations and other groups, the receptivity to planetary energy reaching the earth during a given period, is not the same in all areas on the globe. Nations and cities, as indicated by progressed aspects and by the Conjunction Charts and Cycle Charts, vary in the degree of their receptivity to a given planetary stream. An aspect between planets in the sky, such as a Conjunction, broadcasts the same energy to the unconscious minds of all men; but the people in one country may be particularly receptive to it, while the people of another country may have so completely tuned in on another planetary vibration as to notice it hardly at all. It is the function of the Birth Charts, Progressed Aspects, Cycle Charts and Conjunction Charts used in mundane astrology to indicate the degree of receptivity of each important area of the earth to whatever energies are being broadcast from the sky.

All people within a group, however, are not equally receptive to what at the time is being broadcast from the sky; no more so than are all nations. Some individuals within a group may tune in scarcely at all on a given planetary vibration, while a few members may pick up its energies in tremendous volume. And it is these members of the group who respond markedly to a particular planet's vibrations who largely determine the effect of the particular energy upon the group.

Those having the planet prominent in their charts of birth are more responsive to its vibrations than are those who do not thus have it prominent. That is, they have thought-cells within their unconscious minds which act as natural receiving sets for this energy.

But to pick up the planetary energy, radio fashion, in most volume, there must be at the time, a progressed aspect to that planet in the birth chart. Such a progressed aspect forms an aerial which readily picks up the energies of the two planets involved. This energy is thus conducted immediately to the thought-cells mapped in the birth chart by the planets. And these thought-cells, acquiring so much new energy of their own type, powerfully influence the individual's thinking, his behavior and the events which at that time come into his life.

In Brotherhood of Light Research work we have had ample opportunity to work out the progressed aspects in the charts of those individuals whose activities were chiefly responsible for the effect produced upon a nation or a city by the heavy aspects present at the time in the sky. And we have found that such individuals had the aspecting planets prominent in their birth charts, and that at the time there was a major progressed aspect to one or both of them.

Heavy Aspects in the Sky Other than Conjunctions

Other aspects in the sky than conjunctions, particularly the heaviest aspects of the more slowly moving planets, have a noticeable affect upon the affairs of cities, nations and the world. And a chart erected for the city or capitol of the country, for the exact time the aspect is perfect, will give much information as to the department of life chiefly affected by the aspect there. Since 1900 the exact Greenwich Mean Time of such aspects is given in the back of Raphael's ephemeris.

In lesson No. 141 (See Serial Lesson Key), some five pages are given to these aspects in the sky other than conjunctions, under the heading: General Astronomical Phenomena. Perhaps these should here be supplemented by considering some other heavy aspects in the sky which have taken place since that lesson was printed. Quoting from the 1937 issues of THE CHURCH OF LIGHT QUARTERLY:

All the difficulties anticipated from the opposition of Saturn to Neptune in the sky on January 17, 1937, came to pass. Neptune was in Virgo, the harvest sign; and the citrus growers in California were beset with the severest cold in the history of the industry; while Saturn in Pisces, the sign of rivers, brought floods in the Ohio Valley of unprecedented destructiveness.

The hopes for peace agreements in Europe broke completely down; the Japanese cabinet was forced to resign by the military crowd for the first time in history; and in Russia 13 prominent men were executed, allegedly for attempting the overthrow of the government.

The shipping strike at that time was still under way in the U.S., and to this labor difficulty was added the General Motors strike, and the typically Pluto technique of its sit-down strikers.

On 22, April 22, 1937, Jupiter came to the opposition of Pluto: Clark Gable, popular moving picture star, who had been the subject of an extortion (Pluto) plot, was called by the government as a witness. For a week the newspapers of the nation gave the Extortion Trial, as they called it, tremendous publicity. The verdict, convicting the woman on trial as guilty of mail fraud, thus attempting to get money (Jupiter), was brought in by the jury on April 23.

On April 22, 1937, there were no less than a dozen major strikes in progress, some of the sit-down (Pluto) variety, and the C. I. O. came into unprecedented prominence. April 20, 1937, the newspapers chronicled that 27 nations had combined (Pluto) to place a sanitary cordon of warships (Pluto resorts to force) around Spain. And April 23 bears the headlines that London and Paris had formed an alliance for mutual defense.

Jupiter was again opposition Pluto on May 29, 1937, and on December 18, 1937. Each of these aspects, close to the dates indicated, brought outstanding conflict (opposition aspect) between the Administration of the U. S. and Big Business (Jupiter); the last one also a marked Business (Jupiter) Recession, with the Government demanding; that Labor and Business cooperate (Pluto). And each brought outstanding conflict between the two great labor organizations; the C. I. O. and the A. F. of L., and effort on the part of the Government to get these contending factions to cooperate.

December 12 occurred the malicious and intentional sinking of the American warship, Panay, and three Standard Oil tankers, accompanied by loss of life and machine gunning of survivors, by Japanese bombing planes. By December 18 there was grave danger of war between Japan and the U. S.; and this international incident led to a close co-operation between the U. S. and British navies. The strife was over the attempt of the U. S. to protect her commercial (Jupiter) interests in China.

Such aspects in the sky have some influence during the time they are forming and during the time they are separating over an orb of the same number of degrees that is allowed for the same aspect in a birth chart. In this they are quite different in their influence than the aspects made by progression in a Cycle Chart, which, with the exception of the so swift moving Moon, affects the event only during the time the aspect is within one degree of perfect.

And, just as in birth charts, aspects in the sky have an influence during the time they are within several degrees of orb, even though the aspect is not completed for a long time. For instance, in September, 1937, Uranus was Taurus 13, Neptune was Virgo 18 and Jupiter was Capricorn 17. They thus were in a Grand Trine. But Uranus was retrograde and did not complete the trine with Neptune that year; and Jupiter before reaching the trine of Neptune turned retrograde, and did not complete it until the last of October. Yet this Grand Trine was noticeable in all the fields these three planets rule.

Neptune is the planet of the movies, Uranus is the planet which has to do with new things, and Jupiter IS the planet of patronage. In September, 1937, a new type of movie was presented to the public. In the picture, One-Hundred Men and a Girl, for the first time in screen history, undiluted classical music was joined in dramatic unity with the comedy, pathos and suspense which go to make a great picture. And it was a box office (Jupiter) success.

Under this aspect also, to determine to what extent a telepathic (Pluto) sense exists capable of use by the general public, the radio facilities of the National Broadcasting Corporation were employed by the Zenith Foundation of Chicago, in comprehensive tests, and in giving to the public authentic instances in which occult powers, not recognized by material science, have been used.

Major Conjunction Charts

What has been said of the other aspects that form in the sky is equally true of major conjunctions. They have an influence not merely over the limited period of time while the two planets are within one degree of the perfect conjunction, but all the while the planets making the conjunction are as close to each other as the common orb allowed for their conjunction in a birth chart. The exact moment of the conjunction, which is the time for which the conjunction chart should be erected, is merely the peak of the influence. Yet the influence of the conjunction upon events can be discerned in a pronounced manner near this time of the exact conjunction.

Such a conjunction is a distinct astrological influence. But the more energy of a given planet present at a certain time, the more work it can do. Therefore, if while the conjunction aspect is within orb of influence, some pronounced aspect by progression forms in the Cycle Chart of one of the two planets; or if in some Cycle Chart one of the planets involved in the conjunction is powerfully aspected by progression, there is enough planetary energy of a particular kind present to attract an event of the nature of the conjunction on that day. Therefore, in determining the exact days on which the chief events indicated by the conjunction will occur, the various Cycle Charts should be inspected, to ascertain when there is an unusual supply of planetary energy present of the kind indicated by the Conjunction. Whether the accessory energy shown by the progressed aspect in a Cycle Chart is harmonious or discordant is not so important. The general rule is that the chief events occur on those days when there is the most planetary energy of the given kind reaching the earth.

The most effective method of becoming skilled in astrology is the case method, by which the student, after gaining some knowledge of theory, studies actual cases in which astrological positions have resulted in recorded events or conditions. It is my advice that students of mundane astrology copy off on blank charts all the various Cycle Charts and Conjunction Charts given in this course of lessons, and study them in view of what has been recorded relative to the events which they have influenced. Astrological forces often do not work in just the manner those inexperienced expect.

In the study of Major Conjunctions, this course offers 76 charts already erected, embracing examples in proper sequence of all 15 different types of Major Conjunctions, with at least some comment on the event or events attracted by each. Progressed aspects to the positions in the Conjunction Charts should be ignored; but the houses containing planets powerfully aspected by the Conjunction should receive special consideration.

For finding the time of day an aspect is completed, including the conjunction, Rule XI of lesson No. 111 (See Serial Lesson Key) may be used; and the time of all conjunctions here given earlier than 1900 has been calculated by that rule. Since 1900 the precise time of all aspects between the planets, including the conjunctions, are given in the back of Raphael's Ephemeris; and the time of all conjunctions here given since 1900 has been ascertained from this source.

As dates before 1920 are taken from the Reference History of the World of Webster's New International Dictionary, in which only a few events are given for each year, the events cited are not so close to the dates of the conjunctions as are those since 1920, which are taken from the WORLD ALMANAC, in which one event or several is given for nearly every day.

To accommodate so many conjunctions, it was found more convenient to distribute their charts in tables to be found in several lessons of this course. The prefix number here given refers to the number in the table, the serial number of the lesson in which the table may be found comes next, and this is followed by the data for which the chart was erected, and the event which coincided with the conjunction.

Neptune Conjunction Pluto

As Pluto rules groups, cooperation, the splitting into two opposing factions, and the exercise of dictatorial powers; and Neptune rules visionary schemes, involved affairs, involuntary servitude and dramatic art; the conjunction of Neptune with Pluto attracts events in which factors related to both planets are combined.

332, lesson No. 142 (See Serial Lesson Key), Neptune conjunction Pluto, July 22, 1891, approximately 10:24 p.m. L.M.T. 77W. 38:56N. The event is given in lesson No. 142.

Uranus Conjunction Pluto

As Pluto rules groups, cooperation, the splitting into two opposing actions, an the exercise of dictatorial powers; and Uranus rules independence, reform, exposure, invention and the new and untried; the conjunction of Uranus with Pluto attracts events in which factors related to both planets are combined.

331, lesson No. 142, Uranus conjunction Pluto, June 20, 1850, approximately 6:52 a.m. L.M.T. 77W. 38:56N. The event is given in lesson No. 142.

Uranus Conjunction Neptune

As Neptune rules visionary schemes, involved affairs, involuntary servitude and dramatic art; and Uranus rules independence, reform, exposure, invention and the new and untried; the conjunction of Uranus with Neptune attracts events in which factors related to both planets are combined.

334, table at front of this lesson, Uranus conjunction Neptune, March 22, 1821, approximately 5:09 p.m. L.M.T. 77W. 38:56N. Russian ukase (abrupt action leading to involvement) claiming coast south to 51 degrees and exclusive rights in North Pacific Ocean and Bering Sea (five planets in seventh, square Uranus-Neptune in house of territory).

335, table at front of this lesson, Uranus conjunction Neptune, April 22, 1821, approximately 6:52 a.m. L.M.T. 77W. 38:56N. Supreme Court reasserts appellate jurisdiction (involving the rights of states; Uranus ruling the house of government).

336, table at front of this lesson, Uranus conjunction Neptune, December 4, 1821, approximately 4:52 a.m. L.M.T. 77W. 38:56N. Monroe sends message to Congress advising the recognition (independence) of the Spanish-American states (Mars in house of business and honor, trine Uranus-Neptune).

Saturn Conjunction Pluto

As Pluto rules groups, cooperation, the splitting into two opposing factions, and the exercise of dictatorial powers; and Saturn rules safety, economy, poverty, lands, minerals, basic utilities, buildings, crops on the land, destruction by storm, the miner, the farmer and the common laborer; the conjunction of Saturn with Pluto attracts events in which the factors related to both planets are combined.

337, lesson No. 144 (See Serial Lesson Key), Saturn conjunction Pluto, June 5, 1851, approximately 11:46 a.m. L.M.T. 77W. 38:56N. March 3, 1851, Congress reduces (Saturn) letter postage to three cents per half ounce (letters have mass circulation).

338, lesson No. 144 (See Serial Lesson Key), Saturn conjunction Pluto, May 21, 1883, approximately 0:52 p.m. L.M.T. 77W. 38:56M. March 3, 1883, Tariff and Internal Revenue Act to reduce (Saturn) surplus.

339, lesson No. 144, Saturn conjunction Pluto, September 30, 1914, approximately 3:17 p.m. L.M.T. 77W. 38:56N. September 2, 1914, Bureau of War Risk Insurance (safety for shipping groups) is authorized as part of the Treasury Department.

340, lesson No. 144, Saturn conjunction Pluto, November 4, 1914, approximately 2:41 p.m. L.M.T. 77W. 38:56N. November 2, 1914, Federal quarantine is proclaimed to prevent (safety) the spread of hoof-and-mouth disease among cattle in many (groups) States.

341, lesson No. 144, Saturn conjunction Pluto, May 19, 1915, approximately 9:58 a.m. L.M.T. 77W. 38:56N. May 10, 1915, (after the Germans had torpedoed the Lusitania on May 7) in a speech at Philadelphia Wilson says: “There is such a thing as a man being too proud to fight.”

Saturn Conjunction Neptune

As Neptune rules visionary schemes, involved affairs, involuntary servitude and dramatic art; and Saturn rules safety, economy, poverty, lands, minerals, basic utilities, buildings, crops on the land, destruction by storm, the miner, the farmer and the common laborer; the conjunction of Saturn with Neptune attracts events in which factors related to both planets are combined.

100, lesson No. 144, Saturn conjunction Neptune, December 1, 1809, approximately 9:57 a.m. L.M.T. 77W. 38:56N. September, 1809, first experimental railroad in America (Neptune promotion), built by John Thomson in Delaware County, Pennsylvania.

101, lesson No. 144, Saturn conjunction Neptune, April 4, 1846, approximately 1:20 a.m. L.M.T. 77W. 38:56N. March 28, 1846, Taylor’s force occupies the strip between Nueces and Rio Grande (involved condition over Texan boundary).

102, lesson No. 144, Saturn conjunction Neptune, September 4, 1846, approximately 9:16 p.m. L.M.T. 77W. 38:56N. August 18, 1846, Kearny, after an overland march, occupies Santa Fe (acquires territory of New Mexico).

103, lesson No. 144, Saturn conjunction Neptune, December 10, 1846, approximately 7:58 p.m. L.M.T. 77W. 38:56N. December 12, 1846, Treaty of Granada: freedom of transit on Isthmus of Panama given to United States (safety).

104 lesson No. 144, Saturn conjunction Neptune, May 12, 1882, approximately 9:41 a.m. L.M.T. 77W. 38:56N. May 6, 1882, first Chinese Exclusion Act suspends immigration of laborers for ten years (protecting American laborers).

105, lesson No. 144, Saturn conjunction Neptune, August 1, 1917, 0:04 a.m. L.M.T. 77W. 38:56N. August 10, 1917, Food Control Act gives the president very wide powers in fixing prices and regulating the distribution of foodstuffs and fuels (a safety measure).

Saturn Conjunction Uranus

As Uranus rules independence, reform, exposure, invention and the new and untried; and Saturn rules safety, economy, poverty, lands, minerals, basic utilities, buildings, crops on the land, destruction by storm, the miner, the farmer and the common laborer; the conjunction of Saturn with Uranus attracts events in which factors related to both planets are combined.

106, lesson No. 144, Saturn conjunction Uranus, November 16, 1805, approximately 6:52 a.m. L.M.T. 77W. 38:56N. March 29, 1806, policy of internal improvement at Federal expense is inaugurated (development of natural resources) by an act authorizing the National Road between the Potomac and the Ohio.

107, lesson No. 144, Saturn conjunction Uranus, March 15, 1852, approximately 6:52 p.m. L.M.T. 77W. 38:56N. May 27, 1852, the court discountenances a bridge across the Ohio River, under State law, as being an obstruction (Saturn) to undisturbed interstate or foreign commerce.

108, lesson No. 144, Saturn conjunction Uranus, January 6, 1897, approximately 2:52 p.m. L.M.T. 77W. 38:56N. March 2, 1897, Cleveland vetoes a bill for a literacy test of immigrants (designed to protect American laborers).

Jupiter Conjunction Pluto

As Pluto rules groups, cooperation, the splitting into two opposing factions, and the exercise of dictatorial powers; and Jupiter rules finance, commerce, interstate commerce, treaties, arbitration, the courts, salesmanship, publishing, advertising, cable messages, ships which travel the sea, long journeys, religion and public expressions of opinion; the conjunction of Jupiter with Pluto attracts events in which factors related to both planets are combined.

342, lesson 145 (See Serial Lesson Key), Jupiter conjunction Pluto, May 5, 1845, approximately 2:27 p.m. L.M.T. 77W. 38:56N. March 1, 1845, joint (Pluto) resolution of Congress for the annexation of Texas (Jupiter-Pluto sextile Saturn), less favorable to the United States than the abandoned treaty (Jupiter).

343, lesson No. 145, Jupiter conjunction Pluto, June 11, 1857, approximately 0:46 p.m. L.M.T. 77W. 38:56N. August 24, 1857, panic (financial and affecting the masses) of 1857 begins.

344, lesson No. 145, Jupiter conjunction Pluto July 25, 1869, approximately 7:37 p.m. L.M.T. 77W. 38:56N. September 24, 1869, Black Friday in Wall Street, due to an attempt to corner gold (financial) broken (Pluto acts drastically) by action of the Federal treasury.

345, lesson No. 145, Jupiter conjunction Pluto, April 11, 1882, approximately 2:11 p.m. L.M.T. 77W. 38:56N. April 3, 1882, Supreme Court holds that a State tax on telegrams is void so far as it is laid on interstate (Jupiter) messages or on those sent by Federal officials.

346, lesson No. 145, Jupiter conjunction Pluto, May 18, 1894, approximately 1:36 a.m. L.M.T. 77W. 38:56N. April 29, 1894, Coxey's Army (group) reaches Washington with a demand for the issue of \$500,000,000 paper money (Jupiter).

347, lesson No. 145, Jupiter conjunction Pluto, June 26, 1906, approximately 5:43 a.m. L.M.T. 77W. 38:56N. June 26, 1906, cable (Jupiter) between Japan and the United States is opened.

348, lesson No. 145, Jupiter conjunction Pluto, August 10, 1918, approximately 4:17 a.m. L.M.T. 77W. 38:56N. August 27, 1918, Wilson places under the control of an Export Council (dictatorship) all articles of commerce (Jupiter) destined for neutral countries.

349, lesson No. 145, Jupiter conjunction Pluto, May 26, 1931, approximately 11:25 p.m. L.M.T. 77W. 38:56N. May 27, 1931, at Paris the 25 American Mayors touring France established a council (dictatorship) to govern their tour (Jupiter) after a difference of opinion (Pluto splitting) had led to a dispute over the leadership of their tour.

Jupiter Conjunction Neptune

As Neptune rules visionary schemes, involved affairs, involuntary servitude and dramatic art; and Jupiter rules finance, commerce, interstate commerce, treaties, arbitration, the courts, salesmanship, publishing, advertising, cable messages, ships which travel the sea, long journeys, religion and public expression of opinion; the conjunction of Jupiter with Neptune attracts events in which factors related to both planets are combined.

18, lesson No. 142 (See Serial Lesson Key), Jupiter conjunction Neptune, December 29, 1804, approximately 11:35 a.m. L.M.T 77W. 38:56N. The event is given in lesson No. 142.

19, lesson No. 142, Jupiter conjunction Neptune, December 24, 1817, approximately 00:58 p.m. L.M.T. 77W. 38:56N. The event is given in lesson No. 142.

20, lesson No. 142, Jupiter conjunction Neptune; December 15, 1830, approximately 4:52 a.m. L.M.T 77W. 38:56N. The event is given in lesson No. 142.

21, lesson No. 142, Jupiter conjunction Neptune; April 9, 1843, approximately 1:31 p.m. L.M.T 77W. 38:56N. The event is given in lesson No. 142.

22, lesson No. 142, Jupiter conjunction Neptune, March 17, 1856, approximately 1:23 a.m. L.M.T 77W. 38:56N. The event is given in lesson No 142.

23, lesson No. 142, Jupiter conjunction Neptune; February 26, 1869, approximately 00:19 a.m. L.M.T 77W. 38:56N. The event is given in lesson No 142.

24, lesson No. 142, Jupiter conjunction Neptune June 18, 1881, approximately 7:34 a.m. L.M.T. 77W. 38:56N. The event is given in lesson No. 142.

25, lesson No. 142, Jupiter conjunction Neptune June 1, 1894, approximately 4:41 a.m. L.M.T. 77W. 38:56N. The event is given in lesson No. 142.

26, lesson No. 142, Jupiter conjunction Neptune, May 22, 1907, 6:43 a.m. L.M.T. 77W. 38:56N. The event is given in lesson No. 142.

27, lesson No. 142, Jupiter conjunction Neptune, September 23, 1919, 8:46 p.m. L.M.T. 77W. 38:56N. The event is given in lesson No. 142.

333, lesson No. 142, Jupiter conjunction Neptune, September 18, 1932, 11:30 p.m. L.M.T. 77W. 38:56N. The event is given in lesson No. 142.

Jupiter Conjunction Uranus

As Uranus rules independence, reform, exposure, invention and the new and untried; and Jupiter rules finance, commerce, interstate commerce, treaties, arbitration, the courts, salesmanship, publishing, advertising, cable messages, ships which travel the sea, long journeys, religion and public expressions of opinion; the conjunction of Jupiter with Uranus attracts events in which factors related to both planets are combined.

33, lesson No. 143 (See Serial Lesson Key), Jupiter conjunction Uranus, September 15, 1803, approximately 5:32 p.m. L.M.T. 77W. 38:56N. April 30, 1803, Louisiana Purchase Treaty (U. S. pays France \$15,000,000).

34, lesson No. 143, Jupiter conjunction Uranus, November 9, 1817, approximately 11:40 p.m. L.M.T. 77W. 38:56N. December 10, 1817, Mississippi admitted as slave state. Taken with Indiana, the first clear case of admission of free (Uranus) and slave states in pairs (attempt to settle a vexatious problem through arbitration).

35, lesson No. 143, Jupiter conjunction Uranus, March 20, 1831, approximately 11:52 p.m. L.M.T. 77W. 38:56N. March 18, 1831, in the Cherokee Nation v. Georgia the Supreme Court (Jupiter) denies the right of an Indian tribe to sue in the Federal courts, because it is not a foreign (independent) nation.

36, lesson No. 143, Jupiter conjunction Uranus, February 8, 1845, approximately 9:16 a.m. L.M.T. 77W. 38:56N. March 1, 1845, joint resolution of Congress for the annexation of Texas (giving independence from Mexico), less favorable to the United States than the abandoned treaty (Jupiter).

37, lesson No. 143, Jupiter conjunction Uranus, May 23, 1858, approximately 9:10 a.m. L.M.T. 77W. 38:56N. May 11, 1858, Minnesota free (without slavery) State.

38, lesson No. 143, Jupiter conjunction Uranus June 5, 1872, approximately 0:52 p.m. L.M.T. 77W. 38:56N. September 14, 1872, Geneva Tribunal, sitting under the Treaty (Jupiter) of Washington, awards the United States \$15,500,000 damages against Great Britain.

39, lesson No. 143, Jupiter conjunction Uranus, August 18, 1886, approximately 3:52 a.m. L.M.T. 77W. 38:56N. August 2, 1886, Congress places a tax (financial levy) on oleomargarine; an early (Uranus innovation) pure-food law.

40, lesson No. 143, Jupiter conjunction Uranus October 20, 1900, 3:08 a.m. L.M.T. 77W. 38:56N. November 6, 1900, Twenty-ninth presidential election. Free Silver (financial innovation) and imperialism are the issue. (Uranus-Jupiter opposition Pluto in 10th; semi-square Sun in house of money.)

41, lesson No. 143, Jupiter conjunction Uranus March 3, 1914, 10:13 p.m. L.M.T. 77W. 38:56N. April 7, 1914, Treaty with Colombia is signed by which Colombia recognizes Panama (Uranus-Jupiter in third, relating to transportation).

42, lesson No. 143, Jupiter conjunction Uranus, July 15, 1927, 3:37 p.m. L.M.T. 77W. 38:56N. July 15, 1927, Governor Small gave the State Treasurer of Illinois a check for \$650,000 (Jupiter) in settlement of the judgment against him for an accounting (expose) of interest on State funds.

43, lesson No. 143, Jupiter conjunction Uranus, August 11, 1927, 7:00 a.m. L.M.T. 77W. 38:56N. August 11, 1927, thousands of Inca Indians (Jupiter-Uranus in house of war) have rebelled (Uranus) in the POCOALA region of Bolivia, armed with clubs and slingshots they are killing whites and burning farm houses.

44, lesson No. 143, Jupiter conjunction Uranus, January 25, 1928, 1:27 a.m. L.M.T. 77W. 38:56N. January 24, 1928, at Washington, Mahlon T. Everhart declared that in May, 1922, Harry F. Sinclair delivered to him Liberty Bonds (Jupiter-Uranus in fifth) of a value of \$233,000, all of which went to Fall (exposé).

Jupiter Conjunction Saturn

As Saturn rules safety, economy, poverty, minerals, basic utilities, buildings, crops on the land, destruction by storm, the miner, the farmer and the common laborer; and Jupiter rules finance, commerce, interstate commerce, treaties, arbitration, the courts, salesmanship, publishing, advertising, cable messages, ships which travel the sea, long journeys, religion and public expression of opinion; the conjunction of Jupiter with Saturn attracts events in which factors related to both planets are combined.

53, lesson No. 145 (See Serial Lesson Key), Jupiter conjunction Saturn, July 16, 1802, approximately 6:52 a.m. L.M.T. 77W 38:56N. April 24, 1802, Georgia cedes claims to all land (Saturn) west of present boundary.

54, lesson No. 145, Jupiter conjunction Saturn, June 19, 1821, approximately 4:28 p.m. L.M.T. 77W. 38:56N. Russian ukase claiming North American coast (land, Saturn) south to 51 degrees (this controversy over territory was the dominant topic most of 1821).

55, table at front of this lesson, Jupiter conjunction Saturn, January 25, 1842, approximately 10:52 p.m. L.M.T. 77W. 38:56N. June 29, 1842, Tyler vetoes new tariff bills that are tangled with the distribution of land (Saturn) revenue (Jupiter). (The bills were discussed earlier in the year.)

56, table at front of this lesson, Jupiter conjunction Saturn, October 21, 1861, approximately 6:52 a.m. L.M.T. 77W. 38:56N. December 31, 1861, general suspension (Saturn) of species (Jupiter) payments by banks; not resumed until 1879.

57, table at front of this lesson, Jupiter conjunction Saturn, April 18, 1881, approximately 10:18 a.m. L.M.T. 77W. 38:56N. January 24, 1881, in *Springer v. United States* the Supreme Court (Jupiter) holds the Federal income tax of 1862 to be constitutional, not being a direct tax.

58, table at front of this lesson, Jupiter conjunction Saturn, November 28, 1901, 11:28 a.m. L.M.T. 77W. 38:56N. November 18, 1901, Hay-Pauncefote Treaty (Jupiter) is signed; Clayton-Bulwer Treaty abrogated and British consent given to American sole control of the Isthmian Canal (Jupiter-Saturn sextile Mercury in ninth).

59, table at front of this lesson, Jupiter conjunction Saturn, September 9, 1921, 11:07 p.m. L.M.T. 77W. 38:56N. September 8, 1921, jobless (Saturn lack) men, stripped to the waist, were offered in vain on an auction block on the Boston Common. They were offered for “sale” (Jupiter) to work for a week.

Mars Conjunction Pluto

As Pluto rules groups, cooperation, the splitting into two opposing factions, and the exercise of dictatorial powers; and Mars rules war, army and navy, law-enforcement officers, doctors, industrial workers, fires, vice, gambling, intoxicants, banditry, accidents and strife; the conjunction of Mars with Pluto attracts events in which factors related to both planets are combined.

354, table at front of this lesson, Mars conjunction Pluto, July 1, 1921, approximately 5:40 a.m. L.M.T. 77W. 38:56N. June 30, 1921, President Harding signed Army (Mars) Appropriation Bill, reducing (Mars-Pluto in house of restrictions) army to 150,000.

355, table at front of this lesson, Mars conjunction Pluto, June 15, 1923, approximately 8:08 a.m. L.M.T. 77W. 38:56N. June 15, 1923, the N. Y. Stock Exchange and the N. Y. Curb Market accepted identical resolutions for suspension or expulsion (drastic Pluto) of any member refusing to testify or produce his books in any legal proceeding, civil or criminal (Mars-Pluto in twelfth).

356, table at front of this lesson, Mars conjunction Pluto, May 28, 1925, approximately 10:26 p.m. L.M.T. 77W. 38:56N. May 27, 1925, a special Grand Jury at Washington, D.C., reindicted Albert B. Fall, Harry F. Sinclair and Edward L. Doheny (Pluto group) on the charge of conspiracy to defraud the Government in the making of naval (Mars) reserve oil leases (Mars-Pluto sextile Mercury in fourth, and trine Saturn in ninth).

357, table at front of this lesson, Mars conjunction Pluto, May 10, 1927, approximately 8:59 p.m. L.M.T. 77W. 38:56N. May 10, 1927, a group (Pluto) of armed men overpowered guards and dynamited (Mars) the Los Angeles Aqueduct, tearing out a large section of pipe (Mars-Pluto in house of open enemies of people).

Mars Conjunction Neptune

As Neptune rules visionary schemes, involved affairs, involuntary servitude and dramatic art; and Mars rules war, army and navy, law-enforcement officers, doctors, industrial workers, fires, vice, gambling, intoxicants, banditry, accidents and strife; the conjunction of Mars with Neptune attracts events in which factors related to both planets are combined.

109, table at front of this lesson, Mars conjunction Neptune, August 25, 1921, 7:40 a.m. L.M.T. 77W. 38:56N. August 25, 1921, 5,000 armed coal miners (Neptune ruling house of labor) start from Mannet, W. Va. to unionize the Mingo mine district. They desisted at U. S. warning (Mars).

113, table at front of this lesson, Mars conjunction Neptune, August 12, 1923, 10:04 p.m. L.M.T. 77W. 38:56N. August 11, 1923, German Socialists (Neptune) split from Chancellor Cuno. A score were killed (Mars) in strikes and food riots throughout the country.

117, table at front of this lesson, Mars conjunction Neptune, July 30, 1925, 2:30 p.m. L.M.T. 77W. 38:56N. July 30, 1925, C. H. Schwartz blew up the company's plant at Walnut Creek, Calif., killing an itinerant laborer whose body he tried to have identified as his own in a plot (Neptune) to get \$200,000 insurance.

121, table at front of this lesson, Mars conjunction Neptune, July 17, 1927, 9:41 p.m. L.M.T. 77W. 38:56N. July 17, 1927, fighting (Mars) between 500 Nicaraguans and 40 U. S. Marines and 5 bombing planes (Neptune) has resulted in the death of 300 rebels and 1 marine.

Mars Conjunction Uranus

As Uranus rules independence, reform, exposure, invention and the new and untried; and Mars rules war, army and navy, law-enforcement officers, doctors, industrial workers, fires, vice, gambling, intoxicants, banditry, accidents and strife; the conjunction of Mars with Uranus attracts events in which factors related to both planets are combined.

112, table at front of this lesson, Mars conjunction Uranus) December 25, 1922, 5:39 a.m. L.M.T. 77W. 38:56N. December 26, 1922, Council of American Association for the Advancement of Science passed a resolution saying: "The evidence in favor of the evolution of man is sufficient to convince every scientist of note." (Uranus-Mars in house of science.)

116, table at front of this lesson, Mars conjunction Uranus, November 27, 1924, 3:12 p.m. L.M.T. 77W. 38:56N. November 27, 1924, the Republican Senate Caucus resolved that Senators La Follette, Ladd, Brookhart and Frenzier be not invited (Uranus-Mars in house of Congress) to future Republican conferences.

120, table at front of this lesson, Mars conjunction Uranus, June 13, 1926, 5:47 p.m. L.M.T. 77W. 38:56N. June 13, 1926, 12 were killed by coke oven explosion at Illinois Steel Co.'s plant (Mars-Uranus in fourth) at Gary, Indiana.

Mars Conjunction Saturn

As Saturn rules safety, economy, poverty, minerals, basic utilities, buildings, crops on the land, destruction by storm, the miner, the farmer and in the common laborer; and Mars rules war, army and navy, law-enforcement officers, doctors, industrial workers, fires, vice, gambling, intoxicants, banditry, accidents and strife; the conjunction of Mars with Saturn attracts events in which factors related to both planets are combined.

110, table at front of this lesson, Mars conjunction Saturn, November 13, 1921, 4:13 a.m. L.M.T. 77W. 38:56N. November 14, 1921, 11 died in fire on W. 17th St., New York.

114, table at front of this lesson, Mars conjunction Saturn, December 1, 1923, 2:58 a.m. L.M.T. 77W. 38:56N. November 28, 1923, in the 1923 hunting season 20 persons were accidentally killed in N. Y. State.

118, table at front of this lesson, Mars conjunction Saturn, December 14, 1925, 5:24 p.m. L.M.T. 77W. 38:56N. December 15, 1925, "Battling"; Siki (Louis Phal) Senegal boxer (Mars-Saturn in fifth), was shot and killed in New York City.

122, table at front of this lesson, Mars conjunction Saturn, December 26, 1927, 7:44 a.m. L.M.T. 77W. 38:56N. December 26, 1927, the bruised and strangled body of Amelia Appleby was found sewn in a sack just outside of Los Angeles.

Mars Conjunction Jupiter

As Jupiter rules finance, commerce, interstate commerce, treaties, arbitration, the courts, salesmanship, publishing, advertising, cable messages, ships which travel the sea, long journeys, religion and public expression of opinion; and Mars rules war, army and navy, law-enforcement officers, doctors, industrial workers, fires, vice, gambling, intoxicants, banditry, accident and strife; the conjunction of Mars with Jupiter attracts events in which factors related to both planets are combined.

111, table at front of this lesson, Mars conjunction Jupiter, November 26, 1921, 9:28 p.m. L.M.T. 77W. 38:56N. November 21, 1921, Premier Briand at Arms (Mars) Conference (Jupiter) said France was not militaristic, but needed protection against Germany.

115, table at front of this lesson, Mars conjunction Jupiter, February 13, 1924, 9:28 a.m. L.M.T. 77W. 38:56N. February 12, 1924, agreement for a \$150,000,000 loan (Mars-Jupiter in house of debt) to Japan was signed at J. P. Morgan's home at N. Y. City.

119, table at front of this lesson, Mars conjunction Jupiter, April 23, 1926, 5:20 p.m. L.M.T. 77W. 38:56N. April 23, 1926, hazers in a theatre play (Mars-Jupiter on cusp of fifth) broke the neck of Ralph MacKenzie, actor, when they tossed him up in a blanket.

Illustration at front of this lesson, Mars conjunction Jupiter, October 29, 1937, 8:42 p.m. L.M.T. 77W. 38:56N. October 29, 1937, the U.S. was participating at this time in a futile Nine-Power Parley (Jupiter) in Europe, in the hope of halting Japanese aggression in China. Japan flaunted the parley and became aggressive toward the U. S. (Mars-Jupiter in seventh). Germany made new demands for return of her colonies; Italy severed relations with the League of Nations; and while the aspect was operative a military alliance (Jupiter-Mars opposition Pluto) was formed by Japan, Italy and Germany.

Chapter 8

Serial No. 148
Original Copyright 1938
Elbert Benjamine

Copyright
August 2002
Church of Light

The Cycles of the Sun

Chapter 8

The Cycles of the Sun



THE ASTRONOMICAL year commences when the sun moves across the celestial equator from south declination to north declination. Because in ancient times it was discovered that the point in the sky occupied by the Sun when it thus crosses from south declination to north declination was the commencement of the zodiac, east and west measurements on the celestial sphere are calculated from this point. If they are made along the celestial equator, which is the projection in the sky of the earth's equator, they are expressed in degrees and minutes of Right Ascension. But if, as is required for astrological practice, they are made along the path of the Sun, or ecliptic, they are expressed in signs, degrees and minutes of zodiacal longitude. But in either case, the measurement starts from 0 degrees Aries, where the Sun is located about the 21st of March when it crosses from south declination to north declination.

Declination also is measured in a north and south direction from the position of the Sun at this time; a time commonly called the Vernal Equinox, because then is the commencement of spring (vernal) and the days and nights (nox) are equal (equi). That is, declination is measured north and south from the celestial equator, on which the Sun is stationed at the commencement of Aries and the start of the zodiac. When the measurement north and south is made from the path of the Sun, or elliptic, it is called latitude. All astrological aspects are calculated by zodiacal longitude, except one. Parallel of declination is calculated from the north and south distance of two planets from the celestial equator.

As with all the other astrological orbs, with the exception of the Moon which is a satellite of the earth, the Cycle of the Sun commences when that body crosses from south declination to north declination. But it will be seen from the fact that this Sun crossing establishes those electromagnetic relations which determine where in the sky each sign is located in the zodiac, that the commencement of the cycle of the Sun is an extremely important astronomical and astrological event. It is often referred to as the Vernal Ingress.

All organic activity and life upon the earth are dependent upon energy received from the Sun. And the vital force of every creature is determined by the thought-cells mapped in its unconscious mind by the position of the birth chart Sun. Furthermore, the activity of men and other creatures must depend upon their vitality.

Instead, therefore, of mapping events resulting from one special type of influence, as does Pluto, Neptune, Uranus, Saturn, Jupiter and Mars; the Sun Cycle, the commencement of which marks the beginning of the zodiac and determines the positions of the signs in the sky for that year, is a chart of events of all types and affecting every earthly relation for the year.

This does not mean that all the chief events of the year are signified in their relative importance by the Vernal Ingress, or Sun Cycle chart. The most important events of each type are indicated by appropriate progressed aspects in the Cycle Chart of the planet to which by type they belong. That is, the most important accidents and combats are dated and indicated in the Mars Cycle, the most important financial transactions in the Jupiter Cycle, and the most important innovations and inventions in the Uranus Cycle. But aside from these events, and in addition to them, the Sun Cycle chart gives a general picture of the events which will happen during the year affecting each of the twelve departments of life.

The time the events indicated by each house of the Sun Cycle chart will take place is when the Sun by progression, which in mundane astrology means its position as shown on that day in the ephemeris, makes aspects to the position of the planet in the Sun Cycle chart, ruling the house affected. That is, when the Sun reaches an aspect to the place of Mars in the Sun Cycle chart, not only are events involving accident and strife then attracted, but the accident and strife affect the departments of life governed by the houses Mars rules in the Sun Cycle chart.

While the planets aspected strongly by the Sun in a Sun Cycle chart have more significance as to events to happen during the year, yet any planets that are powerful by position or aspect in the chart, whether or not they aspect the Sun, are also significant of events. In fact, what the year holds in general in each of the twelve departments of life may be read from the twelve houses of the Sun Cycle chart. It thus serves the purpose of a natal chart for the year, for the place where erected, and should be read in all details almost precisely as if it were a person's birth chart. The only difference in such reading is that, because it relates to national or municipal affairs, some of the houses attain a peculiar significance.

Thus the eleventh house is not merely the friends of the city, but the aldermen. Or in national affairs, it represents the members of Congress and the governors of the various states. The tenth house, in addition to being the honor of the nation and its business, signifies the mayor of a city or the president or ruler of the country, and thus the Administration. And the ninth house in addition to relating to travel, has an influence over treaties and interstate and foreign commerce, over the District Attorney, and over the Supreme Court as well as over court proceedings in general. These house meanings are given in full detail in lesson No. 142 (See Serial Lesson Key).

In reading a Sun Cycle chart as a birth chart of the year, one can begin with the first house as representing the health and general welfare of the people, and their temperament; the second house as their money and expenditures; the third house as newspapers, science, postal service and local transportation; the fourth house as homes and farms, building and development of natural resources; and thus on around the chart, taking up in detail what may be expected to happen during the year relative to each department of life.

Such a reading, in the main, will be found correct.

But it is subject to intensification in certain directions, due to the progressed aspects which from time to time form in the Cycle charts of the other planets. A progressed aspect in the Sun Cycle may or may not coincide with some unusually important event. If the event is unusually outstanding, it probably is attracted chiefly through a commensurate aspect in the Cycle of the planet which rules the type of influence most involved. But if near the date on which the aspect is completed in this Planetary Cycle chart, there is also in the Sun Cycle chart a progressed aspect to this planet, there is on the day when the Sun Cycle aspect is completed an accumulation of planetary energy of a given type, and due to this added energy of the same kind, the event is usually timed as to the day it happens thus by the progressed aspect in the Sun Cycle.

Such also is common in the timing of the exact day on which the chief events attracted by a Major Conjunction take place. If near the time of the major conjunction there is a progressed aspect in the Sun Cycle to the place occupied by one of the planets making the conjunction, this accumulation of planetary energy of a particular type tends to cause the event then to happen. And to take the final step in such precise predicting, not only must the energy of a progressed aspect to one of the planets involved in the conjunction be considered in the Sun Cycle chart but also in the New Moon chart. That is, important events more commonly occur at such times as there is an accumulation of energy of a definite type; and progressed aspects to the planet signifying the event, in the Sun Cycle or in the New Moon Cycle, or both, usually give the additional energy which times the precise day of the events signified.

Calculating the Sun Cycles

The time each year when the Sun enters each zodiacal sign is given in a table in the back of Raphael's Ephemeris, a custom which quite recently has been adopted by some other ephemerides. The day and time of day when the Sun enters the sign Aries is the proper time to use for erecting the Sun Cycle chart.

The time there given is Greenwich Mean Time. Therefore, for erecting the Sun Cycle chart for any place east or west of Greenwich, the Local Mean Time at that place must be ascertained when the time at Greenwich is as stated for the entrance of the Sun into Aries. This Equivalent Local Mean Time is ascertained by subtracting the difference in time, if the place is West Longitude, and adding the difference in time if the place is East Longitude, from or to the stated Greenwich time. Thus from the time given in the ephemeris, if it is desired to erect the chart for Washington, which is 77 degrees west, 5 hours, 8 minutes must be subtracted; or if it is to be erected for Los Angeles, which is 118 degrees 15 minutes west, 7 hours, 53 minutes must be subtracted. But if it were desired to erect the chart for Berlin, which is 13 degrees, 24 minutes east, 54 minutes must be added.

Civil Time, as I have noted in connection with calculating the Cycle charts of the more slowly moving planets, commences at midnight, and therefore is 12 hours earlier than Mean Time. The present tendency is toward standardizing the time used by astronomers. There was a time when it was more convenient for them to use a day which commenced at noon, such as the English and American astrological students still use. But since 1925 the Naval Observatories who prepare the Ephemerides and Nautical Almanacs from which the more common ephemerides are prepared, have instead used Civil Time. For astronomical and astrological purposes, it is convenient to reckon time from 0 degrees Longitude on the earth's surface, which is the Longitude of Greenwich, and from 0 degrees Longitude in the sky, which is the commencement of Aries. And as a still further step in standardizing astronomical practice, I note that the 1939 Nautical Almanac, just at hand, refers to Greenwich Civil Time as UNIVERSAL TIME.

It is likely that the future will witness the adoption of this Universal Time among astrological students and the makers of the ephemerides they use. Already the makers of the German Ephemerides have adopted this time, and commencing with the year 1931, the positions are given for midnight instead of noon, that is, for what now is called Universal Time. These German Ephemerides now are available to and including the year 1950. This matter of Universal Time is mentioned here so that students will take note in consulting ephemerides which time is used.

The only planet progressed in a Sun Cycle chart is the Sun. When by its position, as shown in the ephemeris for that day, it makes an aspect to the place of a planet in the Sun Cycle chart, new energy of the type of the planet then aspected and of the harmony or discord of the aspect reaches the unconscious minds of men, and according to its power tends to attract events. These events are of the type of the

planet aspected, and chiefly affect the departments of life ruled by the Sun and the aspected planet. The affairs ruled by the house into which the Sun has progressed when the aspect is completed also are influenced, but usually in a much less degree.

The event attracted by the energy of a progressed aspect of the Sun in the Sun Cycle takes place within 24 hours of the time the aspect is perfect.

The Cycles of the Sun

The best way to learn what to expect in the future from astrological positions is to study what has transpired in the past under similar positions, and to observe current events as they transpire in their relation to astrological influences. In this lesson there are presented Sun Cycle charts for each of the past fifteen years, commencing with 1923 and ending with 1937 (this is being written in February, 1938), for such study. As events attracted by the less powerful aspects are apt to be much less important, in all but the last chart considered (1937), I will not indicate these less significant aspects, but will pay attention only to the events coincident with the progressed Sun coming to the conjunction, opposition, square and trine of the more prominent planets in the Sun Cycle Chart. Because, during a year the Sun makes so many aspects, if all were here considered, available space would be used on a single chart. But by thus selecting the prominent planets in a chart, and giving attention to only the 6 mentioned aspects (to the place of each planet the Sun makes each year one conjunction, one opposition, two squares and two trines) we can cover sufficient ground to give a good idea of what to expect, in different charts, from the more significant aspects. Starting thus with the Sun Cycle of 1923 I will go as far as space permits.

Allowing an orb of no more than 24 hours from the time the aspect is perfect, I will state each such aspect and quote from the WORLD ALMANAC (with my own comments in parentheses) the event coincident with it. When the event falls on a day other than that on which the aspect is perfect, this will be duly noted.

Then as the second part of our study, we will consider the Sun Cycle chart of 1937, which forms one of the illustrations at the front of this booklet, and starting with its commencement, I will list ALL the progressed aspects in that Sun Cycle, and go as far as space permits, quoting from the WORLD ALMANAC the event attracted by each of these progressed aspects.

Sun Cycle No. 125 in the table commenced March 21, 1923, 10:21 a.m. L.M.T. 77W. 38:56N.

Uranus in this chart is in the tenth conjunction the co-ruler of the people (first), promising to reveal graft; and as it is co-ruler of the house of shipping (ninth), and Neptune is in opposition to Venus in this ninth, sudden disasters where transportation are concerned are indicated. This prominence of Uranus also encourages uprisings. Mars conjunction the Moon and in opposition to Jupiter (courts) indicate severe accidents, and legal rulings concerning the liquor (Mars) question; and as Jupiter is

ruler of the seventh, business dealings with foreign governments. Neptune in the house of writing (third), opposition Venus and square Mars, Moon and Jupiter denotes large schemes for social betterment, and other schemes of a fraudulent nature, especially in connection with writing. I shall consider only the progressed aspects of the Sun to Moon, Mars, Jupiter, and Neptune.

April 6, 1923, Sun trine Neptune r (fraud) in third (writing): Martin E. Kern of Allentown, Pa., who in December, 1918, purchased for \$4,500,000 the American Bosch Magneto Company's property at Chicopee, Mass., seized and sold by A. M. Palmer as Alien Property Custodian, pleaded guilty at N. Y. to an indictment charging him with perjury in describing himself as an American instead of a Swiss citizen in a passport application made January 3, 1922. He was fined \$2,000 in Federal Court, which he paid.

May 4, 1923, Sun in eleventh (Legislature) conjunction Mars r (intoxicants): N. Y. Legislature just before the end of the 1923 session, repealed the Mullan-Gage "dry law."

May 6, 1923, Sun conjunction Moon r, ruler of house of money (second): Chinese bandits (Mars in conjunction Moon and opposition ruler of seventh) killed a foreigner and carried off a score of passengers in a raid at Shantung border on train on Tientsin-Pukow railway. Miss Lucy T. Aldrich (sister of wife of J. D. Rockefeller Jr.), Mrs. Robert Allen (wife of Major Allen, U.S.A.), and Mrs. Robert R. W. Pinger (wife of Major Pinger, U.S.A.) and other women (Moon) and children were released. Allen and Pinger were held with others for ransom.

May 7, 1923, Sun square Neptune r (fraud) in third (writing). Forged checks and forged buying orders from a score of cities caused commotion in N. Y. stock market.

May 10, 1923, Sun opposition Jupiter r in sixth (sickness): U. S. Judge Knox at N. Y. ruled that the Volstead Act cannot limit amount of liquor physicians may prescribe.

June 6, 1923, Sun square Uranus r (new contrivances), co-ruler of ninth (transportation): The army dirigible TC-1 was destroyed by thunderstorm at Dayton, Ohio.

July 7, 1923, Sun trine Uranus r, co-ruler of house of transportation (ninth): July 6, Lightning killed 5 at Pittsburgh. Balloon of U. S. Navy containing Lieuts. L. J. Roth and T. B. Null, fell into Lake Erie off Port Stanley. Roth's body was found July 9.

July 11, 1923, Sun trine Jupiter r (law) in sixth (inferiors): July 10, The U. S. Department of Justice has established a watch at Tuskegee, Ala., to prevent outbreaks between white residents and negroes over the new Veteran's Bureau Hospital there.

August 6, 1923, Sun square Mars r (violence): Philippine constabulary killed 50 Moros in battle near Lake Lanas, Mindanao Island.

August 8, 1923, Sun square Moon r, ruler of second (money): August 9, N.Y. State transfer tax appraisers fix net value of estate of late Wm. Rockefeller at \$67,649,660.

August 9, 1923, Sun conjunction Neptune r (gas) in third (auto-travel): August 8, South Dakota State oil stations cut price of gasoline in war on private dealers.

August 12, 1923, Sun square Jupiter r in sixth (labor): August 13, The 8-hour day plan was put into effect at Gary plant by U. S. Steel Corp.

September 6, 1923, Sun trine Mars r (violence): Five men were killed and 30 injured when tons of smokeless powder aboard a schooner and four freight cars exploded and hurled blazing debris on persons in automobiles at South Amboy, N.J.

September 8, 1923, Sun in fourth trine Moon r: Mexico-U.S. claims agreements were signed at Washington, D. C. (claims arising from oil and land, ruled by fourth).

September 8, 1923, Sun opposition Uranus r, coruler of shipping (ninth): U. S. Navy torpedo boats (destroyers) Delphy, S. P. Lee, Chauncy, Fuller, Woodbury, Nicholas, and Young, went ashore off Arguello Light, 75 miles north of Santa Barbara, California; 25 drowned.

November 5, 1923, Sun opposition Mars r: At Atlanta, Georgia, Phillip Fox, Publicity Director for the Klan and editor of the Nighthawk, official Klan Publication, shot and killed W. S. Corbin, former Kleagle of the Klan and attorney for W. J. Simmons, Emperor of the Invisible Empire.

November 7, 1923, Sun opposition Moon r, from cusp of sixth (supplies) to cusp of twelfth (hospitals): Testifying before Senate sub-committee in Veteran's Bureau inquiry, Brig. Gen. Charles E. Sawyer, chief of the Board of Hospitalization, stated that President Harding asked for the resignation of Col. Charles R. Forbes, former Director of the Veterans' Bureau, for insubordination in refusing to hold up shipments of supplies to the Thompson and Kelly Co. Inc. of Boston, from the bureau's depot in Perryville, Md.

November 8, 1923, Sun square Neptune r (corporations): November 9, The Sheffield steam plant, a unit of the Muscle Shoals project, has been leased for another year to the Alabama Power Company which has been operating it (part of a long fight for control).

November 11, 1923, Sun conjunction Jupiter r, ruler of seventh (aliens): U. S. Supreme Court declared valid the laws of California and Washington prohibiting aliens (including Japanese and Chinese) ownership of real estate.

December 7, 1923, Sun square Uranus r (the exposé): Oklahoma Legislature passed a bill prohibiting Ku Klux Klan and others from masking in public.

December 8, 1923, Sun trine Neptune r in third (transportation): December 9, The Marine Corps aviators (Neptune rules aviation) Lieuts. F. O. Rogers and H. D. Palmer, arrived at Santo Domingo City, thus completing their flight to San Francisco and return. The flight is declared to be the longest ever made by American aviators.

January 4, 1924, Sun trine Mars r from seventh (foreign powers): The U. S. Government has sold to the Mexican Government 5,000 Enfield rifles, 5 million round of ammunition, and 8 airplanes (Mars rules armament) .

January 6, 1924, Sun trine Moon r from seventh (other nations): Edward W. Bok announced that the \$100,000 prize offered by him on July 2 for the best practical plan by which the United States may cooperate with other nations looking toward the prevention of war (seventh house) has been awarded by the jury, headed by Elihu Root, for plan No. 1469 of 22,165 plans submitted.

February 2, 1924, Sun square Mars r from ninth (transportation): Twelve were killed when 2 traction trains collided head-on near Ingalla, Indiana.

February 4, 1924, Sun square Moon r from ninth (religion): N. Y. Presbytery, 111 to 28, cleared Rev. H. E. Fosdick, Baptist, of charge of preaching heresy.

February 5, 1924, Sun opposition Neptune r (schemes for social betterment): February 4, The American (Bok) Peace award has been won by Chas. H. Levermore of N. Y. City, who, at the Academy of Music, Philadelphia, was given \$50,000 of the \$100,000 prize. He is secretary of the N. Y. Peace Society.

February 8, 1924, Sun square Jupiter r (law) from ninth (courts): Frederick G. Bonfils, publisher of the Denver Post, testified before the Senate Public Lands Committee that he, his partner H. H. Tammen, and John Leo Stack, got a contract with Harry F. Sinclair whereby he paid \$250,000 outright and prospectively \$1,000,000 for their alleged rights in Teapot Dome oil fields.

March 5, 1924, Sun conjunction Uranus r (exposer) in house of Administration (tenth): Members of the Senate Committee investigating the oil scandal reported the finding of another telegram in the series sent to Edward B. McLean at Palm Beach.

March 9, 1924, Sun in tenth (business) trine Jupiter r (religion and law): 30,000 blue law offenders were named by police for Grand Jury action in Hudson County, N. J. They are mostly storekeepers (tenth).

Sun Cycle No. 126 in the table commenced March 20, 1924, 4:12 p.m. L.M.T. 77W. 38:56N.

As the Ingress (Sun at commencement of Aries) and two other planets are in the seventh, foreign affairs become the subject of much concern. Uranus in the seventh opposition Moon in the house of the people (first) signifies acute controversy with foreign powers, and as Jupiter is square to both, finances will enter the controversy. Further, as Jupiter is in the fourth, territory will play its part.

The Sun square Mars in the house of sport (fifth) and ruling the house of death (eighth) denotes the death of important (Sun) persons, death through violence and strife (Mars), and strife arising through sports. Venus in the ninth and Saturn in the third both aspecting the Sun, indicate important developments in transportation; and as the aspects are not altogether favorable, traffic accidents. With Uranus occupying so important a position, the radical element will be active, but as it is severely

afflicted they will suffer. I shall here consider only the six stronger aspects to Uranus, Jupiter, Moon and Mars. The first three are angular and making powerful aspects, and Mars aspects the Sun.

March 28, 1924, Sun square Mars r (accidents) from eighth (death): Twenty-six died in explosion in coal mine at Yukon, W. Va.

April 9, 1924, Sun trine Jupiter r (finances) from eighth (debts): The American (Dawes) and British (McKenna) committees of experts handed to the Allied Reparation Commission, at Paris, their reports on Germany's capacity to pay.

April 29, 1924, Sun in ninth (travel) trine Mars r (accidents): April 30, Major F. L. Martin, one of four round-the-world airplane flyers, left Chignik, Alaska, for Unalaska, but hit a mountain top; he and his mechanic, Sgt. A. L. Harvey, after many hardships, on May 9 (Sun sextile Uranus r) reached Port Moller, 200 miles west of Chignik.

May 17, 1924, Sun in ninth (journeys) trine Moon r (publicity): May 18, U. S. round-the-world airplanes flew from Paramashiru Island to Yotorofu Island, reaching there May 19, and on May 22 landed at Minato, Japan.

June 9, 1924, Sun in tenth (business) square Uranus r (strikes): June 10, Sun opposition Jupiter r (interstate commerce). June 9, A strike of employees against manufacturers when illegal picketing and intimidation are used to prevent production does not constitute restraint of international commerce, was held by the U. S. Supreme Court (Jupiter).

June 18, 1924, Sun, ruler of foreign lands (seventh) in house of business (tenth), square Moon r in house of people (first): China bade U. S., Japan and France not to interfere in arrangements between Russia and China as to the Chinese Eastern Railway.

June 30, 1924, Sun opposition Mars r (intoxicants and accidents): At Washington, Secretary of State Hughes and Ambassador Jusserand signed a treaty to prevent the illegal importation of intoxicating liquors into the United States. Eight were killed, 16 hurt, when mail train telescoped passenger train at Buda, Illinois.

July 11, 1924, Sun trine Uranus r (revolt against authority): Bootleggers bombed and partly destroyed Ottawa St. M. E. Church, Joliet, Illinois.

August 12, 1924, Sun in twelfth (prison) trine Jupiter r (law): At N. Y. City, for his services in testifying against William J. Fallon, lawyer, who was acquitted of jury bribing, Charles W. Rendigs, convicted perjurer, was released from the Tombs by Judge Talley of General Sessions, with a suspended sentence.

September 1, 1924, Sun trine Mars r in house of pleasure and speculation (fifth): Dawes German reparation plan went into effect at noon (causing speculative activity). August 31, The Prince of Wales practiced at polo at Westbury, L. I., and took a motor boat ride on Long Island Sound.

September 11, 1924, Sun opposition Uranus r, in seventh (war): September 12, 16,792,781 individuals took part in 6,535 Defense Day demonstrations throughout the United States, according to telegraphic reports to the War Department.

September 12, 1924, Sun square Jupiter r in fourth (hotels): Waldorf Astoria Hotel, N. Y. City, has been sold by the Astors to the du Pont-Boomer syndicate.

September 19, 1924, Sun conjunction Moon r (women): Mrs. G. R. Hunn, of Chicago, was beaten with a hammer and shot to death at her villa, Pasadena, California.

October 1, 1924, Sun in second (money) square Mars r in fifth (sports): Jimmy O'Connell, outfielder of the New York Giants, who cost \$75,000, and Cozy Dolan, one of the Giants' coaches, were found guilty by Commissioner Landis of offering \$500 to Heine Sand, shortstop of Philadelphia National League Club, to throw the game (September 27) when the Giants clinched the National League pennant.

November 11, 1924, Sun trine Uranus r in seventh (foreigners). November 12, Harry Katz, diamond broker, was killed in Los Angeles, Calif., in an alleged international smuggling plot (Uranus reveals graft).

Dion O'Banion (gangster chief) was assassinated in his flower shop, at Chicago.

December 10, 1924, Sun square Uranus r (radicals); and conjunction Jupiter r (law) on December 11: December 10, The conviction of Charles E. Rutenberg for the violation of the Michigan Syndicalism Act was affirmed by the State Supreme Court. The arrest and conviction of Rutenberg was followed by a raid on a secret convention of the Communist Party of America in Berrien County, in August 1922, by Federal agents and local officers. The Court upheld the constitutionality of the Syndicalism Act.

December 18, 1924, Sun co-ruler of house of sorrow (twelfth) in the fourth (grave) square Moon r (people): The body of Samuel Gompers, President of the American Federation of Labor, was buried in Sleepy Hollow Cemetery, Tarrytown, N. Y. (He was the common people's champion).

December 30, 1924, Sun conjunction Mars r, in fifth (sports) and ruler of death (eighth): A jury at Los Angeles found Norman Selby (Kid McCoy), ex-pugilist, guilty of manslaughter for the shooting of Mrs. Theresa Mors. An express messenger was shot and killed by one or more robbers who attempted to hold up a Chicago Northwestern passenger train (Mars co-ruler of third) as it neared Chicago.

January 17, 1925, Sun in fifth (social events) trine Moon r, co-ruler of eleventh (friends): Grand Duke Boris Vladimirovitch of Russia, wife and mother-in-law, arrived at New York.

March 9, 1925, Sun, co-ruler of foreign powers (seventh) conjunction Uranus r (radicals and strikes) in house of conflict (seventh): President Coolidge handed down his arbitral award in the controversy between Chile and Peru over the possession of Tacna and Arica, calling for a plebiscite by which these provinces shall determine their own nationality, and holding that the town and Province of Tarata shall revert to Peru. At Lima a general strike followed the decision. U. S. Senate, 64 to 11, approved Republican committee assignments demoting La Follette and other radicals of the party

March 10, 1925, Sun square Jupiter r (finance) in fourth (farming): March 9, At Washington, Senator Howell of Nebraska filed a report in the Senate exonerating Senator Frank R. Gooding of Idaho, who, it had been charged, obtained the Lion's share of War Finance Corporation money lent to farmers in his State.

March 17, 1925, Sun in seventh (war) opposition Moon r: Peruvian mobs, angry over President Coolidge's decision, attacked the U. S. Embassy at Lima.

Sun Cycle No. 127 in the table commenced March 20, 1925, 10:05 p.m. L.M.T. 77W. 38:56N.

While the Sun is in the fifth, influencing speculation, entertainment and children; as it is not powerfully aspected, this trend is less powerful than that restricting and limiting freedom, as shown by Saturn in the house of restrictions (twelfth) in conjunction with the place of the people (Ascendant) and in square with the Moon (populace) in the house of thought (third) and in square with Neptune in the house of teaching (ninth). Neptune, the ruler of plots, is in the house of law (ninth) afflicted. As there is space available for only three events, I shall consider only aspects to Saturn, Neptune and the Moon.

April 10, 1925, Sun trine Neptune r, ruler of social welfare schemes in house of treaties (ninth): April 9, President Coolidge refused to reopen for Peru his arbitration of the Tacna-Arica boundary dispute.

May 4, 1925, Sun opposition Saturn r (conservatism) in house of imprisonment (twelfth): May 5, John T. Scopes, a teacher in the Dayton, Tenn., High School, was arrested, charged with teaching evolution in violation of a State law.

May 6, 1925, Sun square Moon r in third (mails): At Great Falls, Mont., Gordon Campbell, finder of the Kevin-Sunburst oil field, was sentenced to 2 years hard labor at Leavenworth, when a jury in Federal Court found him guilty of using the mails to defraud in the promotion of an oil (Neptune opposition Moon and square Saturn in house of prisons) syndicate 3 years ago. A fine of \$1000 was also imposed.

Sun Cycle No. 128 in the table commenced March 21, 1926, 3:53 a.m. L.M.T. 77W. 38:56N.

Sun Cycle No. 129 in the table commenced March 21, 1927, 9:51 a.m. L.M.T. 77W. 38:56N.

Sun Cycle No. 358 in the table commenced March 20, 1928, 3:36 p.m. L.M.T. 77W. 38:56N.

Sun Cycle No. 359 in the table commenced March 20, 1929, 9:27 p.m. L.M.T. 77W. 38:56N.

Sun Cycle No. 360 in the table commenced March 21, 1930, 3:22 a.m. L.M.T. 77W. 38:56N.

Sun Cycle No. 361 in the table commenced March 21, 1931, 8:58 a.m. L.M.T. 77W. 38:56N.

Sun Cycle No. 362 in the table commenced March 20, 1932, 2:46 p.m. L.M.T. 77W. 38:56N.

Sun Cycle constituting first chart at front of this booklet commenced March 20, 1933, 8:55 p.m. L.M.T. 77W. 38:56N.

Sun Cycle No. 363 in the table commenced March 21, 1934, 2:20 a.m. L.M.T. 77W. 38:56N.

Sun Cycle No. 364 in the table commenced March 21, 1935, 8:10 a.m. L.M.T. 77W. 38:56N.

Sun Cycle No. 365 in the table commenced March 20, 1936, 1:50 a.m. L.M.T. 77W. 38:56N.

Sun Cycle constituting chart facing text at front of this booklet commenced March 20, 1937, 7:37 p.m. L.M.T. 77W. 38:56N.

Later Sun Cycles, previous to their commencement, will be published in THE CHURCH OF LIGHT QUARTERLY.

Taking Each Progressed Aspect of the Sun as it Comes

And now to furnish examples, not of what is to be expected in the way of events from heavy and exceptional aspects in a Sun Cycle, but to give a clear picture of what should be expected also from the weak aspects, and those that occur at rather short intervals, it seems that the best method to follow is to take all the aspects that the Sun forms within a given period in its cycle chart, and note one event which actually was coincident with each such aspect. Commencing, therefore, with the Sun Cycle of March 20, 1937, which faces the text at the front of this booklet, I will list ALL the progressed aspects in the chart following its date, going as far as space permits, and quote the date and the event attracted, from the WORLD ALMANAC, my own comments being placed in parentheses. As only the most important events are listed in the WORLD ALMANAC, it will be apparent these events are not inconsequential. When the event falls on a day other than that on which the aspect is perfect, this will be duly noted.

March 23, 1937, Sun trine Mars r in house of wages (second) from house of labor (sixth): March 22, Wage increases of 5 to 10 per cent and recognition of a C.I.O. union as a bargaining agency for its members ended a strike which had closed about ninety retail stores in Providence, R. I.

March 26, 1937, Sun semi-sextile Venus r in house of foreign lands (seventh): Mourning services in the Sistine Chapel, without the accustomed presence of Pope Pius XI, climaxed Good Friday (ruled by Venus) at Rome.

March 28, 1937, Sun semi-sextile Uranus r in house of foreign lands (seventh): March 27, The Soviet Academy of Science announced that insects and a small variety of lobsters born thousands of years ago (Uranus rules the extremely old and the very new) have been received and are pursuing a normal existence.

April 7, 1937, Sun sesqui-square Mars r in house of money (second), inconjunct Neptune r, co-ruler of the house of labor (sixth), and opposition the Ascendant (people): An angry mob of 3,000 farmers, who had lost pay for 800,000 gallons of milk because of a sit-down strike at the Hershey Chocolate factory near Harrisburg, Pa., marched into the plant and threw out the strikers. Many were injured (Mars).

April 9, 1937, Sun square Moon r in house of long journeys (ninth): Colonel and Mrs. Lindbergh arrived at their home in England after a ten-week air flight to India.

April 10, 1937, Sun square M.C. r (honor) from house of foreign countries (seventh): The monoplane, Kamikaze, owned by the newspaper Ashi and bearing Tokyo's coronation greetings, swooped into Croydon airfield, near London.

April 13, 1937, Sun square Jupiter r (treaty), ruler of railroads (third): At Washington, Secretary Hull and Francisco Castillo Najera, the Mexican Ambassador, signed a treaty providing for the termination of Article VIII of the Gadsden Treaty, 1853, which authorized the construction of a plank and railroad across the Isthmus of Tehuantepec.

April 15, 1937, Sun semi-sextile Mercury r and Saturn r in house of labor (sixth): The United Automobile Workers of America agreed in Detroit to settle the General Motors strike at Oshawa on a "Canadian" basis, without recognition of the C.I.O.

April 16, 1937, Sun square Pluto r (mobs) in the house of authority (tenth): April 15, The U. S. House, 277 to 118, passed the anti-lynching bill which provides for Federal fines or prison sentences for peace officers who permit a prisoner to be taken from them and injured or killed, and it also permits an injured person or his kin to institute suit against the guilty peace officers for personal damages.

April 23, 1937, Sun in house of war (seventh) inconjunct Mars r: Fifty persons were injured, some seriously, in a riot of cannery workers at Stockton, California. Police used shotguns and gas shells before a truce was arranged.

April 25, 1937, Sun conjunction Venus r (women) in house of foreign affairs (seventh): At Baltimore, the girlhood home of Mrs. Wallis Warfield Simpson (for whom King Edward gave up his throne), on E. Biddle St., was opened as a museum.

April 28, 1937, Sun conjunction Uranus r in house of foreign affairs (seventh): At Berlin, the People's Tribunal sentenced Rev. Joseph Rossaint, chief defendant in the Catholic treason trial, to 11 years in the penitentiary. He was found guilty of "preparation for high treason" (Uranus rules rebellion).

May 1, 1937, Sun semi-square Saturn r and Mercury r in house of labor (sixth): At Warsaw (progressed Sun in seventh), Fascists threw bombs and fired shots at a May Day (labor) parade of the Jewish Socialist Party.

May 6, 1937, Sun in house of foreign nations (seventh) semi-square Sun r: Women and children with aged and helpless are being taken from Bilbao, Spain, by British and other vessels, guarded by warships.

May 8, 1937, Sun trine Neptune r, ruler of aviation: May 9, The first attempt at a transatlantic airplane flight this year started at 4:36 p.m. when Henry T. Merrill and John S. Lambie, co-pilot, took off from Brooklyn on a projected non-stop flight to London. They made the trip in 20 hours, 59 minutes.

May 9, 1937, Sun in house of death (eighth) inconjunct Ascendant (people): Six high-school boys from Greensborough, Florida, were killed in a bus-truck collision near Chattahoochee, Florida.

May 10, 1937, Sun sextile Moon r (populace) in house of religion (ninth): May 11, At Hermosillo, Sonora, Mexico, church bells rang out as worshipers crowded into the cathedral closed for three years but reopened on orders from Governor Roman Yocupicio. Hundreds of women, many weeping and others screaming (Moon conjunction Pluto, ruler of mobs), crowded around the public plaza.

May 11, 1937, Sun sextile M.C. r, (place of honor): At London, King George VI gave a personal pledge "to carry on my father's work for the welfare of our great empire" in a ceremony in which the Prime Ministers of five dominions presented "Loyal Addresses" to him at Buckingham palace.

May 14, 1937, Sun in house of death (eighth) trine Jupiter r: The Soviet Russian government has shot 41 Soviet citizens on charges of espionage and sabotage on behalf of the Japanese (capitalism) at one of the strategic sections of the Transiberian Railway (Jupiter in third).

May 16, 1937, Sun in house of death (eighth) sextile Saturn r and Mercury r in house of subordinates (sixth): At Moscow, B. V. Pavloff-Silvansky, Soviet army commander and one of the country's experimenters with parachutes, was shot and killed by a civilian sentry whom he scolded for leaving a hangar door open.

May 18, 1937, Sun sextile drastic Pluto r in house of president (tenth): An electric alarm system whereby any one of the President's secretaries can call an armed guard at a moment's notice has been placed in the Executive offices.

May 21, 1937, Sun sextile Sun r in house of labor (sixth): May 20, At Pittsburgh, the 27,000 employees of Jones and Laughlin Steel Corporation, chose the Steel Workers Organizing Committee as their collective bargaining agent with the company.

May 24, 1937, Sun in house of insurance (eighth) opposition Mars r in house of money (second) and sesqui-square Ascendant r (people): The U. S. Supreme Court upheld in three opinions the constitutionality of the Social Security Act affecting 26,000,000 workers and 2,700,000 employers. The unemployment insurance and old-age pensions sections of the Federal law were approved respectively, by 5-to-4 and 7-2, while the auxiliary State laws were backed by a 5-to-4 vote.

May 26, 1937, Sun semi-sextile Venus r in house of foreign countries (seventh): The Special Assembly of the league of Nations admitted Egypt to membership.

May 26, 1937, Sun semi-square Moon r in house of religion (ninth): The Pope received Alfred E. Smith, ex-Governor of New York, at Castle Gandolfo, near Rome.

May 27, 1937, Sun semi-square M.C. r (business): At New York City, an agreement providing for a 10 per cent wage increase, a basic 48-hour week, a minimum wage of \$25, vacation with pay and the closed shop was signed between Thomas E. Murray Jr., receiver for the Interborough Rapid Transit Co., and the Transport Workers' Union.

May 29, 1937, Sun in house of death (eighth) sesqui-square Jupiter r (which is in opposition to drastic Pluto): Major H. H. Witt of the German Air Corps, a passenger who escaped from the airship Hindenburg when it was destroyed by fire at Lakehurst, N. J. on May 6, told the Department of Commerce (ruled by Jupiter) investigating board that the Zeppelin company had received sabotage warnings before sending the dirigible on her final voyage to the United States.

June 2, 1937, Sun in house of taxes (eighth) semi-square drastic Pluto r in house of president (tenth): June 1, President Roosevelt asked Congress to get after income tax dodgers—"a minority of very rich individuals."

June 8, 1937, Sun square Neptune r, co-ruler of house of labor (sixth): At Waukegan, 39 C.I.O. sitdowners in the Fansteel factory were fined and jailed. A La Follette agent was declared in contempt. Lansing was tied up a second day when A. F. of L. building workers followed the C.I.O. automobile employees and declared a work holiday (Neptune).

June 9, 1937, Sun trine Ascendant r (people): Industrial disputes held in idleness more than 123,000 wage earners in 18 states, a survey on the strike front showed.

June 11, 1937, Sun semi-sextile Venus r (women) in house of foreign countries (seventh) and semi-square Moon r in house of courts (ninth): In King's Court, London, Mrs. Joan Sutherland, wife of a British army officer, apologized for having said (Moon rules gossip) at a luncheon party, that Ernest A. Simpson had been paid for not opposing the divorce action of his wife, Wallis Warfield, now wife of the Duke of Windsor. Simpson had denied in court, under oath, that he had been paid in cash or otherwise.

June 12, 1937, Sun semi-sextile M.C. r (business): The Pan-American Exposition opened, at Dallas, Texas.

Chapter 9

Serial No. 149
Original Copyright 1938
Elbert Benjamine

Copyright
August 2002
Church of Light

The Cycles of the Moon

Chapter 9

The Cycles of the Moon

BECAUSE the Moon is not a planet, but a satellite of the earth whose luminosity, tidal influence, and electromagnetic power upon life is markedly altered by its swiftly changing relations to the lines of force flowing from Sun to earth, and from earth to Sun, the commencement of its Cycle is not determined in the same way that those of the Sun and planets are. The ebb and flood of magnetic and mental forces affecting all life upon the earth are as intimately bound up with the relation of the Moon to the line of energy exchange between earth and Sun, as the vital forces are dependent upon the relation of the positions of the Sun to the equator of the earth; positions which, one following another, bring the heat of summer, the declining days of fall, the winter's nights of icy chill, and then spring's glad renewal of dormant life.

Compared to Sun and Moon, the influence of the other planets upon the tides of earth, and upon the light which the earth receives, is small. Nor do these other planets in their cycles influence the affairs of cities and nations through more than a limited number of channels. But both Sun and Moon, by the positions of the planets in their cycles, and the progressed aspects made to these positions, utilize the channels of influence of all these planets, and through them affect every department of human life.

Due to the peculiar relationship mentioned between the Moon and the lines of exchange between Sun and earth, the Cycle of the Moon commences at the exact moment the Moon is conjunction with the Sun. This position often is called the LUNATION; but I find no occasion to depart from the popular custom of referring to it as NEW MOON.

A chart erected for the exact moment the New Moon (Lunation) occurs at a given place is a chart of the conditions and events relative to all twelve departments of human life, as they will develop at that place during the following lunar month. Such a chart is subordinate not merely to progressed aspects which during its existence may form in the Cycles of the planets, but also to the Sun Cycle chart for the year. That is, if the Sun Cycle chart for the year indicates passive conditions relative to a given department of life, violent conditions relative to this same department of life as shown in the New Moon Cycle, would be violent only in comparison with other

months of the same astronomical year. Or if the Sun Cycle chart indicated drastic occurrences affecting a certain department of life, and the New Moon Cycle indicated little action relative to this department of human affairs, it would only mean that, compared to the other months of the year, this one would be comparatively quiet and mild.

Subject to the general conditions affecting the world or a nation during a much longer period of time, a New Moon chart may be read as a natal chart of the month to follow. While planets strongly aspecting the New Moon (the Sun-Moon conjunction) have more significance as to the events which will happen during the month, yet any planets which are powerful by position, even if not aspecting the New Moon, also are quite significant of events.

This does not mean that all the important events of the month are signified in their relative importance by the New Moon chart. The most important events of each type are indicated by appropriate progressed aspects in the Cycle Chart of the planet to which by type they belong. In other words, the most important gangster and dictator activities are dated and indicated by progressed aspects in the Pluto Cycle, the most important dramatic events and promotion schemes by progressed aspects in the Neptune Cycle the most important radical activities and inventions by progressed aspects in the Uranus Cycle, the most important events relative to economy, lands and security by progressed aspects in the Saturn Cycle, the most important treaties and religious movements by progressed aspects in the Jupiter Cycle, the most important violence, accidents and strife by progressed aspects in the Mars Cycle, and still other important events by progressed aspects in the Sun Cycle. But aside from these events, which usually are more precisely timed by a progressed aspect to the same planet in the New Moon Cycle, and in addition to them, the New Moon chart gives a general picture of the events which will happen during the month affecting each of the twelve departments of life.

As the New Moon is a cycle dependent upon the position at the time of both the Sun and Moon, the time events indicated by each house of the New Moon chart will take place is when either the Sun or Moon by progression, which in mundane astrology means its position as shown on that day in the ephemeris, makes aspects to the position of the planet in the New Moon chart, ruling the house affected. That is, when either Moon or Sun reaches an aspect to the place of Pluto in the New Moon chart, not only are events involving cooperation or dictatorship then attracted, but the co-operation or dictatorship affects the department of life governed by the houses Pluto rules in the New Moon chart.

In reading a New Moon chart as a birth chart of the month, one can begin with the first house as representing the health and general welfare of the people, and their temperament; the second house as their money and expenditures; the third house as newspapers, science, postal service, and local transportation; the fourth house as homes and farms, etc. But in so doing it should be remembered that in mundane astrology the houses also attain a certain broader significance. Thus the second house also relates to bankers, the third house to railroads, the fourth house to crops on the

soil, the fifth house to the stock market, the sixth house to the personnel of army and navy, the seventh house to foreign countries, the eighth house to taxes, the ninth house to courts and the navy, the tenth house to the Administration, the eleventh house to Congress, and the twelfth house to crime, relief, hospitals and places of detention. More complete details of these house meanings are given in lesson No. 142 (See Serial Lesson Key).

Studying and Teaching Mundane Astrology

In the hope that both students and teachers may get suggestions thus that will assist beginners in their study of Mundane Astrology, I will explain the method we use in our Los Angeles classes. With the exception of some two months during the World War, during which I taught astrological classes elsewhere, and a month's vacation each summer during which another teacher taught the class, I have taught a weekly class in Mundane Astrology here in Los Angeles for 23 years.

In all our various astrological classes, the students are not permitted to know the answers in advance. When a natal chart is thrown on the screen (we use lantern slides in such work as well as blackboard) and read by the students, they are never permitted to know the identity of the person owning the chart until after the delineation is made. When in connection with a birth chart, progressions are stated for various events in some person's life, the students are required to give their opinion of the event attracted by each progression; and are told what actually took place only after they have thus expressed their opinions. And in Mundane Astrology, from the Cycle Charts thrown on the screen, and a statement of the dates when given progressed aspects will form in them, the students are required to state in advance what events will transpire, and the exact dates when they will happen.

The method followed, and one which can be used with equal success by students who do not attend classes, is first to observe the general trend of national and world affairs as revealed by Major Conjunctions and General Astronomical Phenomena. Then such cycle charts of the Major Planets are scrutinized as, during the future period under discussion, have progressed aspects forming in them. Every such progressed aspect indicates an event while the aspect is within one degree of perfect, characteristic of the manner in which the aspected planet works, and affecting the departments of life which the aspecting planets rule in the Cycle Chart. The heavier the aspect, the more outstanding the event.

We always employ Cycle Charts erected for Washington to indicate events of national importance, Cycle Charts erected for Los Angeles to indicate events of importance chiefly to Los Angeles, and charts for the capitals of foreign nations to indicate events most pronouncedly affecting those nations. As the newspapers feature events of national importance, in preference to those of a single city or a foreign nation, it is easier to get a newspaper check on events predicted for the charts erected for Washington. Nothing can be expected to happen from a progressed aspect in a Cycle Chart that is not plainly indicated in the chart itself.

After these future events are tabulated, without attempt at greater precision than the time the progressed aspect is within one degree of perfect, the progressed aspects in the Sun Cycle chart during the period covered are indicated. Each of these represents energy which will attract a Sub-Major Event during the 48 hours the aspect is within one degree of perfect. The event coincident with each aspect will partake of the nature of the planet the Sun aspects, and relate to the department of national or municipal life which that planet rules by house. These events are written down by the secretary, and by such members of the class as desire to do so.

Only then do we consider the New Moon chart.

The trend of this chart is taken into consideration. Each day the Moon by its movement, as shown in the ephemeris at the time, makes one, and usually several aspects to planets in the New Moon chart. Each such aspect it makes represents planetary energy of sufficient power in affecting the unconscious minds, and thus the behavior of people, and what their thought-cells working from the inner plane attract to them, that it coincides with some Minor Event in the nation or municipality. By scanning the various daily papers at the time, allowing 24 hours each way from the perfection of the progressed aspect, it is possible to find a published event coincident with each such progressed aspect that forms in the New Moon chart. Also for each progressed aspect of the Sun that forms in the New Moon chart.

However, significant events are attracted only by the heavier progressed aspects in the New Moon chart; that is, by the conjunctions, oppositions, trines and squares.

In connection with the progressed aspects which form in this New Moon chart, the class makes a day by day prediction for the week ahead. The truly important events indicated by progressed aspects in the Cycles of the Major Planets are listed weeks and months ahead. But as the class meets each week, the day by day forecast is commonly made only for the week ahead until the class again meets. But in this forecast, not only are several events, as shown by the progressed aspects made by the Sun and Moon in the New Moon Cycle, for each day stated, but using the progressed aspects in the Sun Cycle chart and those in the New Moon chart as adding energy of the same planetary type, or to the same house, to progressed aspects in the heavier Cycles, an attempt is made to gauge from such accumulations of energy on given days, the exact day when the Major Events indicated in the heavier cycles will transpire.

In predicting events from progressed aspects in the New Moon chart, as a rule the house into which the Moon has progressed is not of outstanding importance. But if outstanding headlines of the daily papers are used later to check accuracy, it is safe to predict from each heavy progressed aspect thus made in the New Moon chart, an event of the nature of the planet the progressed Moon aspects, in addition to an event relative to the most active house in the chart which this planet rules. That is, it can be counted, allowing 24 hours from the time the aspect is complete, that prominent newspaper headlines will verify two predictions relative to each powerful progressed aspect the Moon makes in its Cycle chart. And in addition, with practice in gauging the effects of accumulating planetary energy of the same planetary type, or as affecting the same department of life, the exact day when Major Events will take place, as well as their nature, can be forecast with accuracy. But in predicting what the NEWS will be, and such predicting can be as long range as desired, it must be remembered that newspapers seldom find fortunate and constructive events dramatic enough for publication. The favorable events indicated by progressions in the New Moon chart really take place, as often can be determined by enough personal effort. But only occasionally are they startling enough to make the newspaper headlines. Therefore, if the accuracy of the forecasts is to be determined, the predictions must be of the nature which commonly are featured in the newsheets.

Our Los Angeles class thus makes several predictions for each day of the week in advance. These predictions are written down by the secretary, and usually by others. When the class again meets, these predictions are read, and clippings of prominent newspaper headlines, or copies of these prominent headlines, published for the day indicated, are read to indicate the degree in which the class has been able to state these headlines days before the events featured happened.

Gauging Elections

In twenty-three years, with but one single exception, this class has picked the successful candidate in advance, not merely in national, but also in local elections. And this one error has taught us something quite important. I may say also that the class has picked the winner of every notable prizefight since 1915. Some of the students also have had much success predicting the outcome of ball games and horse races; but we do not permit charts relating to these, or to other things that might encourage gambling, to be discussed in our classes. In the important elections the predictions have been published months in advance.

The method followed has been to obtain the birth charts of the contending candidates and carefully weigh one chart against the other, special attention being given to the progressions in the chart of each at the time, and immediately following the election. Where, as sometimes happens, there is difficulty in deciding which chart with its progressions is most favorable toward acquiring the office, a horary chart is erected, and the question asked if John Doe (naming one of the candidates) will be elected. The chart is then judged according to the rules given in Lesson No. 91 (See Serial Lesson Key) for determining the winner of a contest.

In reference to elections, we have quite thoroughly demonstrated that Jupiter rules the Republican party, Saturn the Democratic party (at least as it existed before the New Deal), Neptune rules the Socialists, Uranus the Communists, and Pluto the New Deal policies inaugurated by President Franklin D. Roosevelt.

If on election day there is a good aspect in the Jupiter Cycle, as happened November 6, 1928 (Jupiter sextile Mercury r) it indicates that the Republican party will poll a heavier vote than expected. If on election day there is a good aspect in the Saturn Cycle, as there was November 3, 1936 (Saturn conjunction Venus r and semi-sextile Mercury r) it indicates the Democratic party will poll a heavier vote than expected, many changing at the last minute to vote Democratic. But a discordant aspect in the Cycle Chart tends to influence things adversely on the last days, or during the time the aspect is operative, for the party ruled by the Cycle planet.

The New Moon preceding an election also has considerable significance; although its trend should be considered in connection with the charts of the candidates. If the Tenth house and its ruler are powerful and harmonious, it indicates the party already in office is well entrenched. If the Fourth house and its ruler are powerful and harmonious, it indicates that the opposition to the party in office has much power.

If the Tenth house is more powerful and harmonious than the Fourth, the party in power will tend to remain in power. But if the Fourth house is stronger and more harmonious than the Tenth, it indicates that the party which is in opposition to the one in power has the advantage, and tends to gain the election.

The comparison of the strength of the birth charts, with the progressions then operative in both, as our Los Angeles class learned in the election of a governor for California in 1936, is not an infallible guide when taken apart from general political trends. Upton Sinclair (Chart is given in lesson No. 110 [See Serial Lesson Key]) has a stronger birth chart, and at the time his progressions were more powerfully favorable, than those of the opposing candidate for Governor. And his name (according to literary critics) will live long after most on earth today are forgotten.

But Upton Sinclair had formulated an EPIC plan which was decidedly Socialistic in nature, and which he proposed should be placed in operation if he became governor of California. It was so radical a departure from the past, that it became a national issue, with tremendous forces in opposition to it. These forces, which represented all factions desirous of preserving the economic structure of the past, were not interested in electing his opponent governor of California; but they were determined at all cost to see that Upton Sinclair did not become governor and start radical, far reaching economic changes.

Upton Sinclair was not elected governor. Probably no one could have been elected governor who proposed such radical changes. He did, however, increase his following in an amazing manner, forced liberal changes in the national political platform, and gained tremendously in publicity and in prestige. Even though not enabling him to be governor, his progressed aspects brought him what he considered great advantages.

He could not become governor, in spite of having a stronger birth chart and better progressed aspects than his adversary; because he had adopted a platform which was too far out of step with the trend of the times.

Calculating the New Moon Cycles

In Raphael's Ephemeris, and in some others, the exact time when the Moon makes the conjunction with the Sun each month is given in the aspectarian at the back of the ephemeris for that year. This conjunction of Moon with Sun is the New Moon. The time given in the ephemeris is Greenwich Mean Time. Therefore, if the chart for the New Moon is to be erected for some other locality, four minutes must be subtracted from this time for each degree West, or four minutes must be added to this time for each degree East, that this locality is from Greenwich. The time so obtained is the Local Mean Time of the New Moon at that place. And for this Local Mean Time at the place, the New Moon chart should be erected, just as if it were a birth chart.

To find the Local Mean Time of the New Moon at Tokyo, for instance, which is 139 degrees, 46 minutes East; 9 hours, 19 minutes must be added. To find the Local Mean Time of the New Moon at Madrid, which is 3 degrees, 45 minutes West; 15 minutes must be subtracted. To find the Local Mean Time of the New Moon at Washington, which is 77 degrees West; 5 hours, 8 minutes must be subtracted from the time of the New Moon as given from Greenwich.

Predicting the Date of a Few Outstanding Events During the Month Solely from the New Moon Cycle

To be able to determine, within 24 hours of the time they will happen, important events during the month solely from the New Moon Cycle, it is necessary to select the most prominent planets in the chart, and the dates on which the heaviest progressed aspects of the Moon are made to them. Starting with the New Moon of June 10, 1926, and taking the New Moon charts in chronological succession, I will give as many illustrations as space will permit, in each case quoting, with my own observations in parentheses, the event which actually happened from the WORLD ALMANAC. When the event falls on a day other than that on which the aspect is perfect, this will be duly noted.

New Moon No. 131, illustrated at front of this booklet, took place June 10, 1926, 5:01 a.m. L.M.T 77W. 38:56N. Mars is especially prominent through being in an angle conjunction Uranus and square Mercury, these two planets also being in angles. Each aspect the Moon makes to the position occupied by Mars in this chart during the subsequent lunar month, therefore, will coincide with events which partake of the strifeful nature of Mars, and events which relate to the houses Mars rules. Every such

event, however, will not relate to the houses ruled by Mars, as some will merely be acts of violence such as Mars energy stimulates. Here we will consider only the progressed squares, opposition and conjunction of the Moon to the position of Mars.

June 18, 1926, Moon opposition Mars r: Admission that the Pepper-Fisher campaign organization in Western Pennsylvania paid for the insertion of an advertisement (Mars in tenth indicates criticism of Administration and conflict in which it is involved) in which there was a forged letter bearing the signature of William Green, President of the American Federation of Labor (Mars trine Saturn in house of labor), was made to the Senate (Mars is co-ruler of house of Senate) Campaign Fund Investigating Committee at Washington.

June 25, 1926, Moon square Mars r: June 24, at Mineola, N. Y., the four volunteer firemen of Rockville Center who admitted setting fire (Mars with Uranus in the tenth tends to public exposé) for a thrill got prison and reformatory sentences.

July 1, 1926, Moon conjunction Mars r: Mrs. Alice M. Miller, art dealer, (because of business reverses, Mars in tenth) jumped to death from a hospital window at Baltimore.

July 8, 1926, Moon square Mars r: The U. S. Circuit Court of Appeals (Moon trine Jupiter r in ninth) ruled at New York City that foreign “booze” ships (Moon trine Jupiter r in ninth) and cargoes may be searched and seized within 12-mile limit, but American liquor carriers can be seized anywhere inside or outside that limit.

New Moon No. 132 illustrated at front of this booklet, took place July 9, 1926, 5:59 p.m. L.M.T. 77W. 38:56N. With the New Moon conjunction Pluto in the house of foreign countries (seventh), affairs abroad would attain prominence; but as these planets are closely square to Mars in the house of newspapers and transportation, the progressed conjunction, opposition, squares and trines of the Moon could be depended upon to attract events of a strifeful nature, and events relative to the houses Mars rules. Not all the Mars events, however, would relate to the houses ruled by Mars.

July 12, 1926, Moon trine Mars r from house of debts (eighth): An Anglo-French war debt agreement (Moon also conjunction Neptune r and Mercury r in house of debts) was signed at London (debts have continued to stir up strife). Sale of the Kansas City Star (Mars in third house) and its morning edition, the Kansas City Times, to the present management for years associated with Col. W. R. Nelson, founder, was announced by the trustees of the newspaper estate.

July 17, 1926, Moon opposition Mars r from house of preachers (ninth): Claiming self-defense, the Rev. J. F. Norris, pastor of the First Baptist Church Ft. Worth, Texas, shot and killed D. E. Chipps, lumberman.

July 22, 1926, Moon trine Mars r in house of transportation: The strike of the I. R. T. Subway men was ended by union leaders.

July 23, 1926, Moon square Mars r: Lightning exploded forgotten dynamite in stone quarry (Mars ruler of fourth) at Strasburg Junction, Va., killing 5. The heat (Mars rules house of weather) killed 9 in and near N. Y. City.

July 30, 1926, Moon conjunction Mars r: The Baroness Royce-Garnett leaped to death from a hotel (Mars rules house of hotels) at Miami, Florida.

New Moon No. 133, illustrated at front of this booklet, took place August 8, 1926, 8:41 a.m. L.M.T. 77W. 38:56N. Uranus in the seventh square Venus in tenth indicates important foreign developments, and also sudden and unusual events. Saturn in the house of money (second) square Neptune with the New Moon, indicate schemes relating to money which are unfavorable to the banks and the people. And as Jupiter is part of a T-square with Neptune and Saturn, and in the house of entertainment, loss or difficulty to entertainers is shown. Also, as Saturn rules the house of buildings, and is the planet of storms, loss may be expected through weather conditions. We will consider only the progressed conjunctions and oppositions to Uranus, Saturn, Jupiter and Neptune.

August 8, 1926, Moon conjunction Neptune r (planet of intrigue) and opposition Jupiter r (finances): Ex-Premier Clemenceau of France, in an open letter, appeals to President Coolidge to consider France's empty treasury and her sacrifices in blood and treasure (Moon is also square Saturn in house of money).

August 12, 1926, Moon opposition Uranus r: N. Y. City traffic was held up by a thunder storm, with 3.24 inches of rain, windows were smashed and cornices tumbled; lightning started 15 fires.

August 16, 1926, Moon conjunction Saturn r, ruler of destructive weather: Cyclones hit Ridgefield, N. J. and Glen Cove, N. Y., raising a dozen houses (Saturn co-ruler of fourth) at latter.

August 23, 1926. Moon conjunction Jupiter r in house of actors: Rudolph Valentino, 31, moving picture actor, died (Moon also square Saturn and opposition Neptune, ruler of movies) at N. Y. City after an operation for gastric ulcer and appendicitis.

August 25, 1926, Moon conjunction Uranus r: Miss Peggy Scott, 27, actress, killed herself at London (Uranus in house of other countries) because of Rudolph Valentino's death. August 24, at Pittsburgh, enraged at refusal to discount his note for \$2,000 (Moon trine Saturn in house of money), a man exploded a bomb (Moon trine Pluto the drastic planet) in the Farmer's Deposit Savings Bank. The blast decapitated him, fatally injured 20 persons (Pluto rules groups) seriously and partly wrecked the bank. 100 persons (Moon trine Pluto) were injured in a crowd of 30,000 that tried to get into the funeral church at N. Y. City to view the body of Rudolph Valentino.

August 29, 1926, Moon opposition Saturn r, co-ruler of the land (fourth): An earthquake, the third in 1926, jarred New England from Western Maine to Canada.

September 5, 1926, Moon conjunction Neptune r (planet of vacations) and opposition Jupiter r in house of pleasures (fifth): 30 were killed when the Scenic Limited (pleasure train) on the Denver and Rio Grande Western Ry. fell into the Arkansas River at Waco, Texas.

Predicting the Date of All Outstanding Events During the Month Solely from the New Moon Cycle

The progressed aspects in the New Moon Cycle alone do not signify the importance of all the events for the month, for the most important events are attracted by progressed aspects in the cycles of the Major Planets. But when these more important events take place commonly is when the progressed Moon in its cycle adds energy of the same type, or to the same department of life, as that which in the heavier cycle is responsible for the event. That is, the progressed aspects in the New Moon chart not only attract Minor Events, but tend to TIME the Major Events during the month.

To indicate just what is meant, I will take the last month for which at this time (1938) events are given in the WORLD ALMANAC, and quote, with my own comments in parentheses, ALL the events there given in so far as available space permits, and indicate the progressed aspect responsible for each event there listed. When the event falls on a day other than that on which the aspect is perfect, this will be duly noted.

New Moon No. 366, illustrated at front of this booklet, took place November 2, 1937, 11:08 p.m. L.M.T. 77W. 38:56N. As Pluto moved into Leo for the first time this cycle on October 9, and abides there temporarily until November 21, this accentuation of the dominance of the Dictator influence abroad, and New Deal policies in the U. S., must be given due allowance.

November 2, 1937, Moon opposition Uranus r in house of government: Fiorello H. La Guardia was reelected Mayor of New York City. As the Fusion, Republican, Progressive and American Labor candidate (rebellious against political bosses) he defeated Jeremiah T. Mahoney, the Democratic, Anti-Communist, Trades Union candidate by a plurality (quite unexpected) of more than 454,000 votes. Thomas E. Dewey (see chart with comments in lesson No. 10 [See Serial Lesson Key]), Fusion, was elected District Attorney in Manhattan (he also had broken with the political machine) Joseph D. McGoldrick, was chosen City Controller, Detroit elected, as Mayor, R. W. Reading over a C. I. O. candidate.

In Spain (Uranus ruler of foreign countries), the Rebels (Uranus) bombed the City of Lerida, killing 225, including school children.

The Duke of Windsor (Uranus ruler of foreign countries) toured Paris slums to inspect a model (Uranus, reform) housing project for French workmen.

In Brazil (foreign country), a passenger-freight train smash-up (Moon opposition Uranus) on the Central Railway, near Sao Paulo, killed 9 persons; 70 were injured.

In Paraguay, the famous Corrales regiment revolted (Uranus) at Concepcion in an effort to restore the Chaco war hero, Col. Rafael Franco to the Presidency (Uranus in tenth). The government insists that the trouble is isolated in Concepcion and that reinforcements are being concentrated there from Asuncion and also from the Chaco. Martial law (Uranus in tenth changing status of authority) was put into effect in Asuncion.

November 3, 1937, Sun opposition Uranus r in house of Government and ruler of house of other nations (seventh): The Conference called under the Nine-Power Treaty (Mars conjunction Jupiter in the sky October 29) to consider the Japan-China warfare, opened at Brussels. Ambassador Davis said means should be sought to end the conflict by peaceful methods. The British and the French seconded his words. The Italians warned (opposing our government) of any attempt to interfere in the conflict.

A resolution condemning (Sun, or royalty, opposed by radical Uranus) the impending visit of the Duke and Duchess of Windsor to this country with the announced purpose of studying labor conditions was adopted unanimously by the Baltimore Federation of Labor, a unit of the A. F. of L. The stated objection to the proposed tour was based on labor hostility (progressed Moon sextile Jupiter and Mars in sixth) to Charles E. Bedaux, a labor efficiency expert, who sponsors the tour and is author of a production speed-up (Mars in house of work) system.

Brazil (Uranus ruling seventh) closed its coffee markets, the government saying that it intended to abandon (Uranian sudden change) its price control program for coffee and adopt a policy of open competition, also reducing the present export tax (progressed Moon sextile Neptune in foreign nation's house of taxes, second) on coffee by about 75 per cent.

Near Seattle, 5 navy flyers (progressed Moon sextile Neptune, planet of aviation) were killed and two others rode to safety in parachutes when a bomber and a pursuit plane collided during gunnery maneuvers high above Boeing Field.

Pope Pius (progressed Moon sextile Jupiter) left the Vatican and went to the Church of St. John Lateran, where he inaugurated the pontifical Roman Atheneum, built out of his private purse at a cost (Jupiter) of about \$500,000.

November 4, 1937, Sun opposition Uranus r; Mars in orb of opposition of drastic Pluto r in Mars Cycle; Moon trine Pluto r and Saturn r in New Moon Cycle:

Germany (foreign nation) has offered her services for mediation (Moon trine Saturn r in house of treaties) of the Sino-Japanese conflict.

In Mexico (seventh house ruled by radical Uranus) President Lazaro Cardenas decreed the nationalization (Uranus) of 350,000 acres of oil lands under lease to the Standard Oil Co. of California, as part of the nationalization of 2,000,000 acres of oil territory in the three Southern States of Tabasco, Campeche and Chiapas.

A surrogate (Moon trine Saturn r in ninth) in N. Y. City admitted to probate the will (Moon sextile Neptune r, ruler of eighth) of the late Col. E. H. R Green which left most of his estate to his sister, Mrs. Matthew A. Wilks. The latter had agreed to pay \$500,000 in cash to Green's widow, who had signed away her dower right to one-third of the estate and thereby was given \$18,000 a year from a trust fund.

In Berlin (Uranus ruler of seventh), Adolph Rembte 35, and Robert Stamm, 37, Communist Labor leaders, were executed (Mars opposition Pluto r in Mars Cycle) on charges of attempting to recreate (rebelling at authority) an illegal political organization. William Green, president of the A. F. of L., cabled Chancellor Hitler, protesting (Sun opposition Uranus) the sentences and asking a pardon for the men.

November 5, 1937, Sun (royalty) opposition Uranus r still within orb; Moon inconjunct Uranus r, semi-sextile Sun r: The Duke of Windsor announced, in Paris, that he has decided to postpone his visit to America, and that he "arrived at this decision with great reluctance and after much deliberation, but he feels that owing to grave misconceptions which have arisen and misstatements which have appeared regarding the motives and purposes of his industrial tour there is no alternative but to defer it for the present" (sudden radical change of plans).

November 6, 1937, Mars on November 5 opposition Pluto r in twelfth of Mars Cycle; Moon square Neptune r and square Saturn r in New Moon Cycle; The Nine-Power Treaty Conference sent a conciliatory (Saturn in house of treaties, ninth) message to Japan inviting her to exchange views regarding the Chinese conflict (Mars) with "a small number of Powers (Pluto rules groups) to be chosen for that purpose." Norman H. Davis, U. S. delegate, was defeated in an effort to include a phrase declaring force (Mars) had never solved a dispute (Japan flaunted the Conference).

The American Med. Assoc. reported the 70th death (Mars rules the house of death in the Mars Cycle) is attributed to use of an elixir of sulfanilamide containing (Neptune rules poisons) diethylene glycol. The latest case (Neptune rules house of death) is in Porterdale, Ga.

In Cincinnati, a jury, (Saturn in house of jury) of 11 women and a man decreed that Mrs. Anna Marie Hahn, 31, should die in the electric chair for the poison murder of Jacob Wagner, 78, one of four men {Pluto rules groups} she is alleged to have killed (Mars opposition Pluto in house of crime in the Mars Cycle) for their money.

The U. S. State Department has been told that many Haitians, maybe 1,000 or more, who crossed the border into the Dominican Republic seeking work (Mars in house of work opposition Pluto in Mars Cycle), mostly in October, were killed (mass executions) by Dominican soldiers in expelling them (Moon square Saturn r in their house of travel).

Italy joined Germany and Japan (Pluto group of Dictators) in their pact (Moon square Saturn r in house of pacts) against communism, signing it in a ceremony at Rome. The Communist International, defying (Mars) the pact signatories, issued an appeal to the workers of the world to join forces against fascism in Spain and China.

Long Range Predicting of Newspaper Headlines for Each Day

The event which gets the largest headline on the front page of the newsheets is the one indicated by the most powerful accumulation of planetary energy on that day. Usually the front page of a newspaper will carry from three to five fairly prominent headlines, relating to that many different events, the relative importance of each being indicated by the boldness of the type. Therefore, using the progressed Sun and Moon in the New Moon Cycle both to time more significant events and to indicate less important ones, it is usually safe, considering progressed aspects in all the Major Cycles as well as those in Cycles of Sun and Moon, to predict from three to five definite events for each day. However, close to the time of a Major Conjunction, or to the time when some heavy progressed aspect forms in a Major Cycle, a single event, or train of events indicated thus, may so interest the public that the newspapers permit it to push other matters from the front pages, and all but the most important of other events are given no notice even on the back pages.

As an example of this run of the mill day by day predicting, such as we have done each week for the last 23 years in the Los Angeles class, I will use for example the last New Moon previous to the time this is being written, indicate the actual aspects we used in class work from which to make predictions, and quote the newspaper headline which coincided with each. In no case will such a headline be quoted unless dated within 24 hours of the perfection of the progressed aspect. Quoting thus from the LOS ANGELES EXAMINER, with my own comments in parentheses, I will continue as far as available space permits.

New Moon No. 367, illustrated at front of this booklet, took place March 2, 1938, 0:33 a.m. L.M.T. 77W. 38:56N. In estimating the trend of this New Moon it must be taken into consideration that when a new planetary Cycle starts, the things ruled by that planet tend to come into prominence; and that a new SATURN CYCLE commences March 5, 1938, 9:04 a.m. L.M.T. 77W. 38:56N. Saturn rules the weather in its destructiveness, and in this new Saturn Cycle drastic Pluto is in the house of the weather (fourth) square Mars and Moon and trine Saturn.

Looking ahead in the heavy Cycle charts we find Neptune, the promotion planet, progressed to sextile Jupiter r, the financial and religious planet, in the house of the people of the Neptune Cycle (chart at front of lesson No. 142 [See Serial Lesson Key]). The aspect is complete on March 12, but is within orb of influence all month. In the Jupiter Cycle (chart at front of lesson No. 145 [See Serial Lesson Key]), this planet of finances and religion comes to the sextile of Saturn r, in the house of roads and railroads (third) and co-ruler of weather and buildings (fourth), March 3, and is within orb of influence during the first week of March. In the Mars Cycle (data in lesson No. 146 [See Serial Lesson Key]) Mars reaches the square of the drastic planet and the planet of dictators, Pluto r, March 10. In the Sun Cycle (chart at front of

lesson No. 148 [See Serial Lesson Key]), the Sun progresses to sesqui-square Pluto r on March 2, to opposition Neptune r in house of Congress on March 8; and to trine Moon r in house of court on March 10. Bearing these heavy influences in mind, let us now look at the New Moon of March 2 (chart at front of this booklet).

There we find a concentration of four planets in the house of roads and railroads, with heavy afflictions, indicating disasters affecting such travel. Venus in the house of weather opposite Neptune, and Saturn also in that house, are not favorable to property; Pluto in house of death square Mars shows death of groups; Mars and Uranus in fifth, show prominence of vice, gambling, and misfortune to children.

March 2, 1938, Moon opposition Neptune r in house of business and the Administration (tenth): Baruch attacks U. S. in business. Baruch hits Government farm (Moon conjunction Venus r in house of farms) program.

Moon sextile Uranus r in house of actors and love (fifth): Stokowski, Garbo (both prominent in entertainment world) secret rites hinted.

Moon conjunction Venus r in house of weather: Heavy storm, landslides maroon scores in canyon.

March 3, 1938, Moon conjunction Saturn r in house of weather, and trine Pluto r in house of death (eighth): 28 die in storm; property (fourth) losses mount in millions. Return of kidnap (Pluto) victim predicted. Two leaders blame slump on New Deal (Pluto). Two killed (Pluto in eighth) when avalanche crushes house (Saturn in fourth).

March 4, 1938, Sun sesqui-square Pluto r in house of death (eighth); Moon sextile Jupiter r in house of roads (third:) 55 known dead (Pluto in eighth), 60 missing, 1500 homeless after flood. Railroads, highways (Jupiter in third) blocked and wires down. Logan asks churches (Jupiter Cycle aspect accentuated by Moon aspecting Jupiter r) to back U. S. defense.

March 5, 1938, Moon conjunction Mars r in house of entertainment, children and gambling (fifth), and square Pluto in house of death (eighth): 19 horses await call in big race. Kidnap (Pluto) boy (Mars in fifth) ransom ready. A father finds his dead (Pluto) child (fifth). 94 known dead. Chamberlain tries to calm Hitler (Pluto). Coast cities periled (in case of war, Mars) says Representative Maverick.

March 6, 1938, Moon conjunction Uranus r in fifth: Railroads (Uranus ruling cusp of third) reopen services with train-bus system. Says everybody is hypnotized (Uranus); maintains men and women capable of surprising feats. Child (fifth house) killed, five injured when train hits auto. New ramifications may be bared (alleged political exposé) in Neblett suit. Russian (Uranus rules Russia) woman may doom 21 to escape death. Stagehand (race horse which won Santa Anita derby) expected to win Kentucky derby (fifth).

March 7, 1938, Moon trine Neptune r, sextile Venus r, square Jupiter r, sextile Pluto r: Rebel war ship wrecked by Spanish flyers (Neptune). U. S. sacrifice of Philippine (Venus in house of territory) defense line urged as protection for West Coast. L. A. notables to attend lecture by First Lady (Venus and aspect to ruler of tenth). \$2,070,000 (Jupiter) request authorized by vote of City Council (of Government, Neptune in tenth). More bodies of victims (Pluto in eighth) found in L. A. County work.

March 8, 1938, Sun semi-sextile Jupiter r, conjunction Venus r, in fourth; Moon square Mercury r, square Sun-Moon r: U. S., State and City speed cleanup of damage in storm (fourth). House (Sun opposition Neptune r in Sun Cycle) limits publicity on pay (Jupiter) checks. Landowners (Venus in fourth) aided by court (Sun rules ninth) ruling. U. S. to colonize (Venus in fourth) two islands. 10 per cent raise (Jupiter) granted rails (third house).

March 9, 1938, Moon square Neptune r, square Venus r, trine Jupiter r, sextile Mars r: Proposed appropriation (Jupiter) by Legislature (Sun opposition Neptune r in house of Legislature in Sun Cycle) would save L. A. County \$3,000,000. Wheeler sees dictatorship in reorganization (Neptune in tenth) bill. Mystery (Neptune) surrounds Anglo-Italian peace discussions. Flyers (Neptune) rain bombs (Mars) in Chinese city. Terrifying power in arms (Mars) voted by British House. Youth (Mars in fifth) near death as mimicry of movie fails.

March 10, 1938, Mars square Pluto r in Mars Cycle; Sun trine Moon r in Sun Cycle; Moon sextile Uranus r, square Saturn r, trine Mercury r, Sun-Moon r: Hitler (Pluto) moves on Austria (Mercury ruler of foreign lands). Japan seeks to force (Mars-Pluto) China (to gain territory, Saturn) into peace pact. Convicted dynamiter (Mars square Pluto in house of crime) raps State Supreme Court (Moon in ninth of Sun Cycle). Spencer Tracy and Luise Rainer win motion picture (Uranus in fifth) academy awards. Neblett denies McAdoo aided postoffice deal (Mercury in third). Whitney, stock exchange (Uranus in fifth) ex-president, arrested on \$800,000 larceny charges. German (Pluto) envoy's arrival for London parleys draws threatening (Mars square Pluto) crowds.

March 11, 1938, Sun opposition Neptune r; Moon sextile Neptune r, trine Venus r, square Mars r: Card game (Mars in fifth) killing scene told to jury by neighbor. Hitler troops (Mars) seize Austria (Neptune in house of territory of other countries, tenth). Neblett, Hahn row over quiz on libel (has national repercussions). Blum (Popular Front premier, Neptune) fights odds to form cabinet. Roosevelt urges flood control (Venus in fourth) plan.

March 12, Neptune sextile Jupiter r in Neptune Cycle (a million Jews must leave Austria now because of race and religion); Moon conjunction Pluto r (Mars still within orb of square Pluto r in Mars Cycle early in the day), trine Saturn r: Hitler (Pluto) crushes Vienna government, takes personal control, purge (of opposition) under way. New Deal (Pluto) clauses rejected as House passes tax (Pluto in house of taxes) bill. Uncertainty grips Jews in Vienna. 18 (Pluto in house of death)

condemned in Soviet treason trial. Home (Saturn in fourth) financing in steady upturn over U. S. Says Hitler (Pluto) in speech, "Today All Germany is ours, tomorrow the whole world" (Saturn).

Chapter 10

Serial No. 150
Original Copyright 1938
Elbert Benjamine

Copyright
August 2002
Church of Light

Precise Predicting: Eclipses

Chapter 10

Precise Predicting: Eclipses



PRECISE PREDICTING of the time and nature of events affecting cities, nations and the world follows the same general procedure as that employed in the precise predicting of the time and nature of events affecting an individual. In natal astrology the truly important events in an individual's life are all indicated by major progressions, which at the time the events take place, are within one degree of the perfect aspect. And in mundane astrology, other than those events indicated by major conjunctions, other aspects in the sky, comets, new stars and eclipses, the truly important events are all indicated by progressed aspects in the Cycle charts of the heavier planets, which at the time the event takes place are within one degree of the perfect aspect.

In other words, new stars, comets, major conjunctions and other aspects in the sky, eclipses, and the progressed aspects which form in the Cycle charts of Pluto, Neptune, Uranus, Saturn, Jupiter and Mars, perform the same function in mundane astrology performed by major progressions of the M.C., Ascendant and planets other than the Moon in natal astrology. And when the influence is from the planets, the nature of the event will partake of the characteristics of the planets making the aspect; and the departments of municipal or national life chiefly affected are indicated by the houses ruled by the aspecting Planets.

But in addition to those events in an individual's life which he long afterwards remembers as important, and in addition to the relatively important events recorded in the history of a city or a nation, there are other events that have considerable significance at the time even though they are short lived in their memory. These happenings, far from trivial at the time, in natal astrology we call Sub-Major Events. In the individual's life they are attracted through the major progressed aspects of the Moon. In mundane astrology, events of comparable significance in the life of a city or a nation are attracted by the progressed aspects made by the Sun in the Sun Cycle chart.

Still other events have a significance over a period of a day or two, or at most over a period of a few weeks. These Minor Events are attracted to the individual by Minor progressed aspects and by the heavier transits, and occur during the time the aspect is within one degree of perfect. And in a similar manner the Minor Events which are attracted to a municipality or a nation are indicated by the progressed aspects made by the Moon to the place of the planets in the New Moon chart, and they occur within 24 hours of the time the aspect is complete.

Major trends in world and national affairs are indicated by the signs occupied by the planets, the aspects the planets make in the sky, new stars, and comets. The Major Events within these trends are indicated and timed by the progressed aspects formed in the cycles of the six Major planets. And even as events indicated in natal astrology by Major progressed aspects, need no assistance from Minor progressions and Transits, these events will come to pass regardless of whether or not within the designated time limit there is assistance from progressed aspects in the Cycles of the Sun and Moon. Nevertheless, either to the individual or to a nation, the bringing of an event to pass requires the expenditure of energy by thought-cells or groups of minds, working from the inner plane, of sufficient volume and intensity to overcome the environmental resistance that may be present. When a Major trend favors a given event, it requires much less additional planetary energy, in either case, to bring it to pass.

Furthermore, the more planetary energy of a given type is brought to bear upon thought-cells or groups of minds, the more power these have then to work. Consequently, when there is a progressed aspect in the Sun Cycle or in the New Moon Cycle, to the same planet which by progressed aspect in its Cycle Chart indicates a Major Event, while this progressed aspect is within one degree of perfect, the accumulation of energy of a given type on that day usually gives the unconscious minds of people sufficient impetus that the event happens on that particular day.

In addition to accumulations of energy of a given planetary type, which attract events characteristic of that planet's influence, either progressed aspects in the Sun Cycle or in the New Moon Cycle may add planetary energy to the same department of life, that is, to the same house of the chart, as that relating to a Major Event indicated by a progressed aspect within one degree of perfect in one of the heavier cycles. The event is far more likely to occur on the day when there is such an accumulation of planetary energy relative to the department of life affected.

Thus in addition to indicating and timing Sub-Major Events, the progressed aspects in the Sun Cycle often also time to the day the Major Events indicated by progressed aspects in the heavier cycles. And in addition to indicating and timing Minor Events, the progressed aspects in the New Moon Cycle often also lend force to certain of the Sub-Major Events indicated by progressed aspects in the Sun Cycle, and time to the day the Major Events indicated by progressed aspects in the heavier cycles.

This method of employing Cycles and the progressed aspects which form in them is used by Will P. Benjamine in, AROUND THE WORLD, TOMORROW'S NEWS—TODAY! which commencing with the March, 1937, issue, has appeared in each issue of American Astrology Magazine. It was employed by Maria Major in, COMING EVENTS FOR THE MONTH, A DAY BY DAY FORECAST, which appeared in each of the nine issues of International Astrology Magazine (1937) which were published, and it is now being employed by her (1938) in, COMING EVENTS FOR THE MONTH, in each issue of The Rising Star Magazine. It is the method employed by Elbert Benjamine in, MUNDANE EVENTS FOR THE MONTH, in which the exact day on which a number of important events will take place each month is stated, which commencing with the February, 1936, issue, has appeared in each issue of Student Astrologer Magazine.

These magazine articles are mentioned not merely because they have attracted wide and favorable comment, but because as such articles must be in the hands of magazine publishers at least two months before the date of publication, they afford anyone desiring to check the accuracy of the method an easy way of determining what is actually being done with it.

Significance of New Stars.—As the findings of THE BROTHERHOOD OF LIGHT ASTROLOGICAL RESEARCH DEPARTMENT in reference to New Stars was published in the September, 1935 issue of THE CHURCH OF LIGHT QUARTERLY, I shall here reproduce that article without change:

Although scientific records are lacking, it is believed that the star which led the wise men from the east to a manger in Bethlehem, nineteen hundred and thirty-five years ago, was of the same type as the New Star which flashed into brilliancy last December in the constellation Hercules, and which still chains the interest of astronomers because of its erratic behavior.

That earlier star marked the beginning of the Christian era. And if Nova Herculis 1934—as astronomers call this latest startling stellar appearance—has a significance which can be revealed by the same rules that the wise men of the east employed in determining the meaning of the Star of Bethlehem and allied celestial phenomena, it portends the commencement of the New Dispensation of Labor.

The wise men of the east looked to the heavens to apprise them of important events to come. Unusual phenomena in the sky, to them, portended unusual events which would happen on the earth. According to the rules they left, the appearance of a new star signified the commencement of a new condition in the world, which would have far reaching effects upon the affairs of men.

The phase of human activity thus affected, in which a turning point had been reached, and henceforth a new condition would manifest, was indicated by the constellation in which the new star appeared. As both the pictures of the constellations which they used, and the stories about them which preserved their meaning, are still accessible, they can yet be employed precisely as these ancients used them in their work.

Some centuries before the Star of Bethlehem appeared, the Greeks had contacted the wise men of the east and had adopted the 48 pictured constellations which they used in their predictions. They also attached to each of the constellated figures its precise significance as handed down through the Chaldeans, and wove mythological stories about them which should serve as commentaries on their meaning.

The purport of any influence found in the region of the sky pictured by one of the various heroic figures was always interpreted, according to still older precedent, by considering the pictured constellation as a universal symbol, more details about which could be learned from its mythological story.

Applying these same rules, which remain unchanged since long before the Christian era, any unusual occurrence in the constellation Hercules signifies some extraordinary occurrences affecting labor; for the outstanding story that has come down to us regarding Hercules is that of his twelve great works. And as the present phenomenon is a New Star, according to these same olden rules, it signifies that Labor is entering upon a New Dispensation. This latest celestial token of events to come, as pointed out in the March QUARTERLY, shows on photographic plates of November 14 as a star of the fourteenth magnitude; so small as to be invisible except to the most powerful telescopes. Yet by December 13 it had grown to third magnitude, and on December 22 when it reached its maximum as a star of the first magnitude, it had increased more than 150,000 times in brightness.

Since that time, instead of steadily fading to invisibility within a few weeks or months, as well behaved novae are supposed to do, to the amazement of astronomers it has been performing strange antics fluctuating in brightness, dimming somewhat and then flaming up again. And we can be confident, applying the ancient rules, that the nation's work situation will parallel the strange performance of this remarkable star.

Hercules, as pictured in the sky, is represented on one knee, while with his other foot he crushes the head of a dragon which winds its slimy coils of graft and corruption around the northern axis of the world. He holds aloft the fruits of his toil. Other objects no less significant also are in his hands; but according to the ancient rules, because the New Star is in the vicinity of the dragon-crushing foot, the stamping out of unfair dealing is the most striking feature of that which is thus foreshown.

But before applying these rules, which have come down to us from the wise men of the east, to the latest celestial manifestation, it would seem the part of wisdom first to investigate how perfectly these same rules have been borne out by world occurrences which immediately followed similar phenomena which have been recorded in the past.

These novae are not really new stars, but probably old stars which have exploded. Nor are they rare if all those at distances which enable them to be seen by the giant present-day telescopes are included. But the ancients considered only such as were of noticeable brilliance to have significance in world events.

Under favorable circumstances it is possible to see stars of the sixth magnitude with the unaided eye. But a star of less brilliance than the third magnitude, of which there are about 180, would attract attention only of a careful observer.

Astronomers estimate that during the past 2,000 years there have been about 30 new stars of sufficient brightness to be seen without a telescope. Only 12 of them, however, in addition to the Star of Bethlehem, the location of which is unrecorded, have been of third magnitude or brighter. It is not a difficult task, therefore, to apply the ancient rules to all the conspicuous novae that have been recorded since before the birth of Christ.

The mythology woven about the constellation Scorpio gives it two distinct meanings. Pictured as a scorpion it is related to treachery and to death. Pictured as an eagle, as it sometimes is, it signifies the soaring aloft of spirit and the conquest of limitations. The first new star of which we now possess records was observed in this constellation, and important events immediately followed which express both sides of the constellation's nature.

Rome, in that day, was supreme in the world. There were certain laws which related to the distribution of the land, called agrarian laws; but for some 200 years the wealthier families had continued to extend their possessions greatly beyond the limits thus prescribed, and as a result, although the empire had vastly extended its territory through conquest and confiscation, small proprietors had practically disappeared.

In 134 B.C. a new star of brilliancy appeared in the constellation Scorpio. Simultaneous with its appearance Tiberius Gracchus, one of the landed proprietors, proposed and carried a modification of the existing agrarian laws; which had for its object the restoration of land to the poorer people, whose poverty and number were rapidly increasing. The following year, however, before his policy could be carried into effect, death laid its hand upon him. Later, his brother Caius endeavored to put the same relief measure through; but he was slain. Thus did death, the eighth house significance of the constellation, defeat a reform measure that might have at least delayed the dissolution of an empire.

On the eagle side of the constellation's significance, the appearance of the new star so impressed Hipparchus that he set about making a precise catalogue of 1080 of the brighter stars, so that later observers might be able to recognize new stars or other alterations in the appearance of the sky at future dates. This is recognized as the commencement of scientific astronomy.

1572 was the year in which the Huguenots in France were having a terrible time. August 24 of that year, with the sanction of the king, there occurred the Massacre of Bartholomew. Then, on November 11, a new star suddenly appeared which for several days rivaled Venus in luster.

It was in the constellation Cassiopeia, which according to its modern key-word, was anciently considered to signify Vicissitudes, and to picture the last ten degrees of the zodiac before the Vernal Equinox, over which the sun each year passed from the bondage of winter darkness into summer freedom.

To the Huguenots, who had taken up arms, this new star seemed a messenger of hope from heaven. True to this belief, the following year they made a successful defense of La Rochelle and were granted new toleration. It proved to be the commencement of a new dispensation to them; for two years later Henry of Navarre escaped from Paris and became their leader.

Each year the ancients saw the geese and swans, after the sun turned back from its southern sojourn, wing their way northward at the approach of spring. In their flight to a new land of promise there was no helter-skelter movement, as with smaller birds, but each group had its recognized leader, which it followed in the well-known V-formation. Thus, when they pictured a swan in the sky, they had in mind not only travel to new parts, but, as the modern keyword indicates, Organization.

Four of the new stars have appeared in Cygnus, the constellation pictured by the Swan, and thus relate to some new undertaking of importance in the world's affairs in which movement to a new field and organization both play an important part.

The year 1600 saw the appearance of a new star of third magnitude in Cygnus; and the same year the English East India Company was formed, an organization whose trading activities and political influence later led to the addition of India to the British Empire.

Another new star of the third magnitude appeared in the same constellation in 1670; and in that year Hudson's Bay Company was chartered by the British Crown. This organization was largely responsible for the development of the Dominion of Canada.

Still another new star of third magnitude appeared in Cygnus in the year 1876, coincident with the invention of the telephone by Graham Bell and the founding of the electric industry. The vast holdings of the telephone and power organizations attest to the importance of the field of activity then entered.

The latest new star in this constellation of the Swan was brighter than any of the others, being of second magnitude. It made its appearance in 1920, along with the first meeting of the Council of the League of Nations, to be followed before the year was out by the plan for a World Court, and the next year by Disarmament Conferences at Washington. The extent of the influence of the League of Nations in world affairs is yet for the future to reveal.

Ophiuchus is pictured in the sky as a man engaging in a titanic struggle with a monster serpent. In 1604 a magnificent new star, often called Kepler's star because that famous astronomer studied it, suddenly blazed in this constellation. Strangely enough, at the time, England was the scene of a violent struggle between the government and certain religions. A convocation of clergy met, the acts of which were so oppressive to Puritans that 300 of them left their livings rather than conform to their dictates.

Furthermore, James ordered the judges to enforce the statutes against Catholics. This resulted the following year in the famous Gunpowder Plot to destroy the King, Lords, and Commons in revenge for the penal laws against Catholics. Guy Fawkes, the agent of the conspirators, was seized as he was about to fire barrels of gunpowder which had been placed under the House of Lords.

Corona Borealis, the Northern Crown, is a constellation depicting tribulations by means of twelve iron spikes. A new star of second magnitude was to be seen in this constellation in 1866. That year there were seven weeks of war in Europe, which the following year enabled Prussia to become the dominant power in Europe, and gave Bismarck the idea that a war with France was necessary to the firm unification of Germany. The difficulties then started have not yet subsided.

The chief significance of the stories relating to Perseus may be summed up in the key-word, Propaganda. In 1901 a very brilliant new star was seen in the constellation picturing this ancient hero. The two outstanding events of the year were dependent upon propaganda. The Pan-American Exposition was held at Buffalo; and there was a panic in Wall Street over control of the Northern Pacific Railroad, the stock of which reached 1,000.

June, 1918, witnessed an exceptionally brilliant new star in the constellation Aquila. This eagle among the stars is attached by legend to victory, and by its key-word to Exploration. Its appearance, therefore, was heralded by many as forecasting the end of the World War; and in fulfillment of this hope American troops, fighting on foreign soil, soon were able to turn the tide of battle and bring peace.

Way to the south is a big constellation picturing a ship which mythology and its key-word relate to Research. In 1925 a new star of first magnitude appeared just ahead of the bow of this stellar ship in a group unrecognized by the ancients but by moderns called Pictor. In various lands the freedom to express convictions based on research were sternly curtailed. In Italy and in Russia matters of belief came in for strict regulation by the government; and during that year, at Dayton, Tennessee, John Thomas Scopes was arrested, tried, and found guilty of teaching evolution in the public schools.

Of the twelve outstanding new stars which have been recorded during 2,000 years, history thus indicates that in eleven instances they were coincident with a turn in world affairs in which there was the commencement of a new condition, the nature of which was quite correctly indicated by the rules laid down by the ancients in reference to the significance of the constellation in which the phenomenon appeared.

If the twelfth outstanding new star be judged by the same system which fits so well when applied to the other eleven, the commencement of a new condition of far-reaching import in world affairs already is at hand. Nothing, I believe, in the stories relating to Hercules can be construed as relating to communism. But they do relate to the power and rewards of labor.

The club which as pictured he holds in one hand may signify collective bargaining. In the other hand he holds not merely the fruit which signifies his reward for labor, but also the guardian Cerberus. Law makers, this seems to indicate, will more willingly listen to his demands; for with the foot of better understanding, above which the latest new star appears he crushes the head of graft and special privilege.

Nova Herculis 1934, according to the rules left by the wise men of the east, signifies that already in 1935, we have entered, where its power and importance are concerned, upon Labor's New Dispensation.

In reference to the significance of Nova Herculis as implied in the article above reproduced in full, it may now (1938) be pointed out that since that article was published, Spain became dominated by a Popular Front government, resulting in a civil war; the laboring class in Mexico has seized not only the natural resources belonging to Mexico, but also the vast oil holdings of British and American oil companies; France is dominated by a Popular Front government in which labor's demands are supreme; and within the United States the Committee for Industrial Organization has come into existence, and now disputes power with the American Federation of Labor, and these two labor organizations are exerting a tremendous influence over the political and business life of the nation.

Significance of Comets

It seems to be quite well established that comets, when they enter the zodiac, bring with them new conditions affecting the affairs of men. The appearance of the more important ones in the past have always coincided with unusual events upon the earth. The old rule was that the influence would be felt chiefly in the country ruled by the sign in which the comet was first visible. Thus just preceding the great debacle of the Russian armies in the World War, and the revolution that followed, a comet, which later developed to important size, was discovered by means of a telescope in the sign Aquarius, ruling Russia. Astrologers the world over began to predict that startling things would happen in that country; predictions that were fully verified.

As comets actually belong to our solar system, which New Stars do not, I believe comets should be referred not to their place among the constellations, but to their place in relation to the zodiac. Perhaps, also, now that they may be discovered by telescopes long before they enter the zodiac, the signs in which they appear after thus entering the zodiac indicate more precisely the regions of earth affected. Thus Peltier's Comet, on August 3, 1936, entered the zodiac at about 28 degrees Aquarius, to leave again August 6, 1936, at about 14½ degrees Aquarius. The following year and a half witnessed blood purges in Russia, which Aquarius rules, in which most of

the important men who assisted in establishing the Soviet Union were executed on charges of trying to overthrow the government. Comets vary in size, in shape, in brilliancy, and even in color. Some of them, it is true, are periodic. But even these do not have the same appearance on successive returns; and may go so far away as to be beyond visibility in even the strongest telescope. Others come into our solar system from the spaces without, bringing their own astrological vibrations, and after making an arc about our Sun, pass on into space, never again to return. Having no previous acquaintance with such celestial visitors, their influence can not be known from earlier observation.

Some comets in the past have coincided with pestilence, some with great wars, some with disasters, some with revolutions, some with great constructive enterprises, and some with the birth of illustrious persons. The general rule has been that the shape and appearance of the comet signified the nature of its influence. If it looked red and angry, it signified disaster. If it looked like a sword it meant war. If it had a pleasing appearance, it heralded some great constructive enterprise.

As the matter stands there is need for much research as to just what may be expected from a given comet. And the only reason THE BROTHERHOOD OF LIGHT ASTROLOGICAL RESEARCH DEPARTMENT has not already contributed markedly to this knowledge is that the literature in which descriptions of the old comets are given seldom specifies WHERE they appeared in the zodiac or on the celestial sphere.

Significance of Eclipses

It seems likely that a great amount of nonsense has been written about eclipses. The Brotherhood of Light Astrological Research Department, for instance, has collected a large number of instances in which either a Solar Eclipse or a Lunar Eclipse took place in the same zodiacal degree occupied by the Sun or other planets in people's birthcharts. In none of these, so far as we have been able to discern, has the eclipse coincided with events not clearly and fully accounted for by the progressed aspects at the time.

Nor have we been able to verify the doctrine that the power of an eclipse persists, even if a long eclipse, over a period of years. We have, however, checked the influence of every Solar Eclipse since commencing with 1884 (back of which the Nautical Almanacs to which we have access do not go) that was visible in a part of the world fairly well populated. The result of this survey led to quite positive results, which over many years we have successfully used in predicting. The definite rule is that, if a Solar Eclipse occurs in a region where there is considerable population, within a few months before, or much more likely within a few months after the eclipse, there is a disaster in the region where the eclipse is visible.

While the disaster tends to be near the central path of the eclipse, it may be anywhere in which it is even partially visible. It seems likely that the exact place of the disaster attracted is determined by the progressed aspects in the birth charts of cities and regions, and the progressed aspects in the Cycle Charts affecting those places. But while, because the birthcharts of so few cities are known, it is difficult to determine where within the area of visibility of a Solar Eclipse the disaster will take place; the New Moon chart often reveals the nature of the disaster.

In the Nautical Almanac each year, published by the Government, is given the essential data regarding each eclipse of the year. In addition, for each eclipse of the Sun which occurs in such a region that it may be observed from an accessible land area, there is a map showing the exact region of the earth's surface where it is visible, as well as the central path of the eclipse, together with other information. It should be noted that, as an eclipse of the Sun is the relation of the Moon's shadow to the surface of the earth, the moment of eclipse is not exactly the moment of the conjunction of Sun and Moon, although the New Moon and the eclipse are never more than a few minutes apart. Some research in the future should be done, not merely in reference to charts erected for the exact moment of central eclipse as visible at a given place, but also in reference to New Moon charts in which parallax is given consideration. In other words, using charts in which instead of the conjunction of Sun and Moon being regarded from the center of the earth, they are considered from the point on the surface of the earth where at the moment the chart is erected. However, as New Moon charts erected in the customary way give good results, it is wise to use them until it has been proven by actual test that the time ascertained by including the parallax is superior.

For the purpose of study there follow all the New Moons which were also eclipses of the Sun, which were visible (as shown by the maps in the Nautical Almanac) in the United States since 1884. The Solar Eclipses earlier than 1900 I shall merely mention the date, and with each a coincident event. But for each such Solar Eclipse since commencing with 1900, the New Moon chart is given in the table at the front of this booklet. Due to limitations of space the comments on each such chart must be brief. But they are well worth copying off and giving serious study, relative to the house positions of the planets. The quotations giving the dates and events listed earlier than 1924, are from the REFERENCE HISTORY OF THE WORLD of WEBSTER'S NEW INTERNATIONAL DICTIONARY. Those since 1924 are quoted from the WORLD ALMANAC. My own comments are in parentheses.

March 16, 1885, Annular eclipse of the Sun visible in the United States and Canada:
June 30, Fisheries reciprocity with Canada under Treaty of Washington is terminated by the United States; because of Canadian obstruction of what the United States claims as rights under the Treaty of 1818 (controversy becomes acute).

March 5, 1886, Annular eclipse of the Sun visible in the U. S.: May 4, Anarchist riot in Chicago, following a strike there.

August 28, 1886, Total eclipse of the Sun visible throughout the S.E. United States:
August 31, Severe earthquake on the Atlantic seaboard, especially at Charleston.
October 12, Gales and floods in Texas and Louisiana destroy property and 247 lives.

January 1, 1889, Total eclipse of the Sun visible throughout North America: May 31,
Breaking of the Conemaugh Dam floods Johnstown, Pa., and destroys 2,295 lives.

June 6, 1891, Annular eclipse of the Sun visible in Western North America:
November 30, 1891, Partial eclipse of the Sun visible at the southernmost extremity
of South America: October 16, Attack on American sailor by a mob at Valparaiso,
Chile; war becomes imminent through Chile's delay to make amends.

October 20, 1892, Partial eclipse of the Sun visible throughout North America:
June-August, Country is affected by many strikes accompanied by much violence.
Harrison issues proclamation (July 15-30) against the striking miners in the West,
and Federal troops are used in restoring order and to support injunctions of the
Federal courts.

October 9, 1893, Annular eclipse of the Sun visible in Western North America and
Western South America: 1893, Commercial panic is started. Hard times continue for
several years.

February 1, 1897, Annular eclipse of the Sun visible in S.E. United States and Cuba:
May 20, Senate passes a resolution recognizing Cuban belligerency (Cuba is thus
recognized to be at war).

New Moon No. 151 in table, May 28, 1900, 8:30 a.m. L.M.T. Galveston, Texas.
Total eclipse of the Sun visible in the United States, at Washington as a partial
eclipse. In Gemini, conjunction Mercury (winds), opposition Uranus (extremes) and
Jupiter: September 8, Galveston and many Gulf towns are ravaged by a terrible
hurricane and flood- 6,000 lives lost, \$30,000,000 of property destroyed. (The
opposition is from the eleventh to fifth, and the loss of life among children was
disproportionately heavy.)

New Moon No. 152 in table, August 19, 1906, 5:18 p.m. L.M.T. San Francisco.
Partial eclipse of the Sun visible in the Western U. S.: April 18-20 Earthquake
followed by a great fire destroyed large portion of San Francisco, including the
business section. Loss about \$350,000,000. (Eclipse is in conjunction with Mars,
fires and violence, and in the house of foreign countries.) October 25, Japanese
Ambassador Aoki protests against exclusion of Japanese from the public schools of
San Francisco. (Controversy becomes acute, giving rise to talk of war.)

New Moon No. 153 in table, January 3, 1908, 2:43 p.m. L.M.T. Denver. Total eclipse
of the Sun visible throughout the S.W. United States. It is conjunction Uranus, the
planet of strikes, in the house of death, eighth, and opposition socialistic Neptune.
The death influence will be mentioned in connection with the June eclipse: March
31, Strike of some 250,000 coal miners; lasts about two weeks.

New Moon No. 154 in table, June 28, 1908, 10:31 a.m. L.M.T. New Orleans. Annular eclipse of the Sun visible throughout North America. Eclipse is conjunction Mercury (wind) and Neptune, and in opposition to unusual Uranus in the house of property (fourth) and square Saturn, planet of storms: April 24, Tornadoes on the Gulf Coast destroy much property and some 1,500 lives.

New Moon No. 155 in table, June 17, 1909, 6:20 p.m. L.M.T. Washington. Central eclipse of the Sun visible throughout North America. Eclipse is in house of foreign countries (seventh) square Mars in house of traffic (third). Neptune, planet of fraud, is on the cusp of the house of duties and taxes (eighth), opposition the planet of exposure, Uranus, in the house of money (second) and square Saturn in house of basic utilities (fourth): September 25, During the year great frauds in customs, especially on sugar imported by the sugar trusts, are discovered and published, and fines and unpaid duties amounting to millions of dollars collected.

New Moon No. 156 in table, April 17, 1912, 5:40 a.m. L.M.T. St. Louis. Central eclipse of the Sun visible in Eastern United States. Neptune in Cancer is in the house of property (fourth) square the eclipse; and Saturn, planet of storms and hardship, is in the house of the people (first): April, Floods in the Mississippi Valley devastate 200 square miles and render 30,000 people homeless (fourth house); loss \$50,000,000.

New Moon No. 157 in table, October 12, 1912, 8:01 a.m. L.M.T. Nicaragua. Partial eclipse of the Sun visible in Florida and throughout Nicaragua and Central America. Eclipse is conjunction Mars, the planet of war, square Neptune, planet of schemes in ninth; Saturn is in house of other countries (seventh): September, American Marines are landed in Nicaragua, at request of government for the time being, and aid in suppressing a revolution. Chief revolutionists surrender to American admiral on September 26, and marines are withdrawn after Nicaraguan presidential election on November 2.

New Moon No. 158 in table, April 6, 1913, 9:42 a.m. L.M.T. Sacramento. Partial eclipse of the Sun visible at extreme western edge of America. Chief affliction is Jupiter (finances) in house of other countries (seventh), square eclipse and opposition Neptune in house of money (second). The war planet, Mars, is on the M. C., square Saturn: May 19, California antialien landownership act; passed in spite of Japanese protest and Federal disapproval.

New Moon No. 159 in table, February 3, 1916, 8:56 a.m. L.M.T. Columbus, New Mexico. Total eclipse of the Sun visible throughout North America. Eclipse is conjunction Uranus, planet of insurrection, and opposition Mars, planet of army and navy: March 9, Mexican brigands under Villa attack the town of Columbus, N. M., and the camp of the Thirteenth United States Cavalry, killing nine civilians and eight troopers; the raiders are pursued into Mexico and more than 100 are killed. March 15, Military expedition to punish Villa enters Mexico, under Pershing.

New Moon No. 160 in table, June 8, 1918, 4:55 p.m. L.M.T. Washington. Total eclipse of the Sun visible throughout North America. Eclipse is on cusp of house of death (eighth) square Mars in tenth, ruler of the first (people). The only casualties of consequence that the American troops suffered during the World War were during the fall following this eclipse: September, Epidemic (Mars ruler of house of sickness, sixth, and health, first) of so-called "Spanish" influenza spreads throughout our country. On October 4 it is reported that only five States remain immune and that there are 127,000 cases in army (sixth house) camps (death rate was tremendous).

New Moon No. 161 in table, November 22, 1919, 10:12 a.m. L.M.T. Washington. Annular eclipse of the Sun visible throughout North America. Eclipse is in house of Administration and business (tenth): September 26, President (tenth) Wilson's tour is ended abruptly at Wichita, Kansas, by a stroke of paralysis. November 1, Strike (Uranus) of 600,000 soft-coal miners, demanding a 6-hour day, a 5-day week, and 60% increase in wages.

New Moon No. 162 in table, November 10, 1920, 10:58 a.m. L.M.T. Washington. Partial eclipse of Sun visible throughout eastern North America. Eclipse is in house of Administration (President remained stricken) and business (tenth), square Neptune in house of other countries (seventh), ruler of house of money (second): December 6, Twenty-three banks, including one national bank, in North Dakota have closed their doors as the result of the fall of the price of wheat (due chiefly to lack in foreign market).

New Moon No. 163 in table, September 10, 1923 12:52 p.m. L.M.T. Santa Barbara, California. Total eclipse of the Sun visible throughout North America. Eclipse is conjunction Mars and Venus in the house of ships (ninth) and opposition Uranus: September 8, Ten destroyers are wrecked on the California coast 75 miles north of Santa Barbara (a few lives lost).

New Moon No. 164 in table, January 24, 1925, 9:01 a.m. L.M.T. Indianapolis, Ind. Total eclipse of the Sun visible throughout eastern and southern North America. Eclipse square Saturn, planet of storms: March 18, A storm in Missouri, Southern Illinois and Indiana killed over 830 persons, injured 3,800, and destroyed property valued at \$10,000,000. The main path of the blow covered 165 miles from Annapolis, Mo., to Princeton, Ind., but as was the case at Lorain, O., last June, it "hopped off" in several directions. In places it cut a path only 300 feet wide. It was at its worst only about 5 minutes and struck West Frankfort and Murphysboro, Ill., with its greatest fury.

New Moon No. 165 in table, July 9, 1926, 5:47 p.m. L.M.T. Miami, Florida. Annular eclipse of the Sun visible in the western and southern sections of the United States, including Florida and the islands to the south. The eclipse is square Mars in the house of weather and houses (fourth). July 26-27, Gulf storms have done \$8,000,000 damage at Nassau in the Bahamas; \$3,000,000 in Santo Domingo; and \$2,000,000 at Miami and other Florida coast places. At Nassau, 146 were drowned with 400 missing, 75 boats sunk and 500 homes destroyed; near Santo Domingo, 54 bodies have been washed ashore; 5 were killed in Georgia and Florida.

New Moon No. 368 in tables, April 28, 1930, 1:16 p.m. L.M.T. Chicago. Central eclipse of Sun visible throughout North America. Mars, ruler of homes and weather (fourth) in house of death, conjunction Uranus and square Saturn (storms): May 1, 24 were killed in cyclones in the prairie states. May 6, 75 were killed, 100 hurt, by tornadoes in Texas.

New Moon No. 369 in tables, August 31, 1932, 2:58 p.m. L.M.T. New York. Five planets in house of death, including eclipse; and Uranus (sudden and unexpected) in house of short journeys (third) square Saturn (workmen) in house of people (first), and square Mars, Venus and Pluto: September 9, The 92-foot steamboat Observation, 44 years old, crowded with workmen bound for their jobs, had scarcely left the wharf at 8:00 a.m. (New York) when the Captain, George A. Forsyth and 70 others were killed and 70 injured (by explosion).

New Moon No. 370 in tables, February 13, 1934, 5:16 p.m. L.M.T., Pocatello, Idaho. Total eclipse of Sun visible on West Coast of America and eastern Asia: March 12, The 527-ton Japanese torpedo boat, Tomozuru, turned upside down off Goto Islands, west of Nagasaki; over 100 were drowned (eclipse in house of foreign countries, seventh). Earth shocks lasting three hours shook cities in northern Utah and southern Idaho, caused large buildings to sway, cracked the walls of some structures, and also jolted communities in western Wyoming, Nevada and California. Schools (Jupiter, ruler of 5th part of T-square) at Salt Lake and at Logan, and Pocatello, Idaho, were closed pending an examination of all buildings. Shocks were resumed March 15.

New Moon No. 371 in tables, February 3, 1935, 8:35 a.m. L.M.T. Los Angeles. Partial eclipse of the Sun visible throughout North America: The \$4,000,000 U. S. navy dirigible balloon, Macon, sank in the Pacific several miles off Point Sur, California (Mars, ruler of ninth part of T-square). January 26, The number of dead from the Tennessee-Arkansas-Mississippi flood was placed at 27, homeless 25,000, property damage \$5,000,000.

New Moon No. 372 in tables, June 8, 1937, 0:51 p.m. L.M.T. Los Angeles. Total eclipse of Sun visible in Pacific, West Coast America and Mexico: May 27, In Mexico 168 persons were killed and 300 homes crushed to bits by gold mine tailings. July 2, Amelia Earhart Putnam on an equatorial air trip around the world radioed that she was in the Pacific with a half hour's fuel and not in sight of land. That was the last message (eclipse in house of long journeys, ninth).

New Moon No. 373, illustrated at front of this booklet, December 2, 1937, 3:19 p.m. L.M.T. Los Angeles. Annular eclipse of the Sun visible west coast America, over northern Pacific, and Japan: Eclipse in house of foreign countries (seventh); Jupiter in house of ships (ninth) opposition drastic Pluto. (Events listed from newspapers as at this writing, April, 1938, World Almanac not issued covering these dates): Early December, \$8,000,000 liner, President Hoover, went aground in Pacific and broke up.

December 12, Japan sank U. S. gunboat Panay and three tankers leading to talk of war (New Moon in seventh) and bringing an immense increase in appropriations for navy building (Jupiter abundance). January 5, Giant Navy Patrol Bomber plunged into the Pacific with death of 7. January 11, Samoan Clipper burned in air with 7 dead. March 1, 1938, flood in Los Angeles region destroyed 50 million dollars in property (afflicted Pluto in fourth) and about 200 lives.

Book 14

Copyright
August 2002
Church of Light

Occultism Applied to Daily Life

Chapter 1

Serial No. 151
Original Copyright 1943
Elbert Benjamine

Copyright
August 2002
Church of Light

Finding One's Cosmic Work

Chapter 1

Finding One's Cosmic Work



OCULTISM, to the majority who come in contact with it, is considered in the light of a pastime rather than as something of the utmost everyday practical value. But whether we will or not, occult forces enter into the details of our lives each day and exercise an influence over all our actions.

They are energies that direct our efforts and determine the results of our labors to the extent that we fail to recognize their existence and neglect to utilize them. Yet if we recognize their presence, and understand their operation, instead of being directed by them we are enabled to enlist them as potencies by which the various aims of life may more readily be attained. And it is the purpose of this course so to familiarize the reader with this practical aspect of occultism that he will experience no difficulty in applying occult knowledge advantageously to every problem he meets in his daily life.

Since the Society for Psychical Research was founded in 1882, a vast amount of evidence has been acquired by men of outstanding scientific attainment, all indicating there is an inner world, not apprehended directly by the physical senses, that under certain conditions enables physical phenomena to take place that are quite inexplicable by the laws of the physical world. This evidence was well summed up in the book published in 1940, *EXTRA-SENSORY PERCEPTION AFTER SIXTY YEARS*, by five members of the faculty of Duke University.

The existence of extra-sensory perception has been demonstrated not only by the experiments of four of these and the Duke mathematician who established the statistical and probability values, but by experiments carried out in a dozen other universities. And since the mentioned book appeared, experiments with precognition have shown that extra-sensory perception applies to future events, such as being able to call the order in which cards will be found when mechanically shuffled ten days later, and to call the order in which dice will turn face up before the throws begin.

This careful research is in course of progress, the latest report at the time of this writing being, AN EXPERIMENT IN PRECOGNITION USING DICE, by J. L. Woodruff and J. B. Rhine, appearing in the December, 1942, issue of The Journal of Parapsychology. In these reported experiments, the predictions of the face to come up when the dice was cast was made before each throw in one series, and in another series predictions for 24 throws were made before the throwing began. In both the results obtained were well above chance.

Chance average is 4 hits per run of 24 trials. One subject's average score was above 5 hits per run. And when the probability was worked out for the combined result of this whole dice throwing precognition research it was found that the odds were about 10,000 to 1 that such a result would not occur by chance alone.

But in addition to faculties of the human soul which are not limited by the restrictions imposed by the outer plane when the soul becomes active in acquiring information on the inner plane and then delivering it, even imperfectly, to objective consciousness, there is another set of phenomena that quite as positively call for an inner-plane penetrating the physical to explain them. These phenomena have not as yet received the critical study of academic individuals. But they have been studied even more closely, and on a vastly larger scale, by many who have little academic standing, and have been studied some by a few outstanding scientists of the past.

The influence of astrological energies is here referred to. These await the kind of critical investigation Professor J. B. Rhine brought to extra-sensory perception. But the existence and potency of these astrological energies have been demonstrated by thousands of independent investigators. And more thousands each year are proving their existence through the simple expedient of learning how to erect their own birth chart and calculate its progressed aspects, and then going back over their lives to find whether or not each important event actually coincided at the time it happened with the particular progressed aspect that, according to astrology, must release energies during any period in which such an event takes place.

That there is an inner world where the soul resides, both before and after the dissolution of the physical body, as well as an outer world, and that there are energy exchanges between these two worlds through boundary-line electromagnetic energies, are the fundamental facts on which occultism rests. The Special Theory of Relativity which lies at the foundation of modern physics as now taught in most universities, holds that anything moving with the velocity of light no longer possesses length, has infinite mass and so is impervious to the pull of gravitation, and that for it time has come to a standstill. The inner world, or astral plane, has even higher velocities. Existence there has properties that contradict our experience with physical things. However, it can only affect, or be affected by, the physical world through the intermediary of electromagnetic boundary-line energies having approximately the velocity of light.

**The Universe Is An Organic
Whole Depending For Its
Progress Upon the
Cooperation Of Its
Intelligent Parts**

—When consciousness in some degree frees itself from the physical world, it is able to use the soul senses and gain information through what science now calls extra-sensory perception. And, at least in rare flashes, a person who has, or develops, his extra-sensory perception can extend his consciousness on the inner plane to acquire a convincing realization that the universe is not a machine, but a living organic whole guided by a Supreme Intelligence. When he has thus had even one convincing experience with Cosmic Consciousness he no longer considers entities as existing independent of other entities; for he senses that all in some manner are interdependent. The universe then presents the aspect of a single organism moving persistently toward the development of a structure of greater complexity and perfection. All entities enter into this structure, and play a part in its welfare, even as each cell and organ of the human body contribute to or detract from, the health and ability of man.

In the human body there may be cells, or diseased regions, which work contrary to the interest of other cells and the welfare of the body as a whole. In a nation there are antisocial individuals, and there may be groups that consider their personal gain of more importance than the welfare of the country. But when these become too numerous they defeat their own ends; for the body dies or the nation is destroyed, and thus terminates also the careers of the dissenting individuals. And even when these destructive elements fail to be thus widely disruptive, as a rule they fare badly; for the criminal has neither peace nor security, and the diseased cell knows no comfort.

In any organism or organization—and organization has become the fetish of American business life—the welfare of the individual is dependent upon the welfare of the organism or organization of which it forms a part. Laboring men, for instance, are learning that unless the corporation for which they work prospers, high wages cannot be had, and that the ability of the corporation to pay higher wages depends upon the collective efficiency of those employed by it. And business executives have long since learned that the success of an organization depends upon the specialization of the individual for the work he is to perform, and the cooperation of the various individuals comprising the organization in carrying out wise policies. In a somewhat similar manner a nation, a solar system, or the universe, is dependent for its welfare upon the parts composing it, and these parts are dependent for their welfare upon the welfare of the organization as a whole.

Thus it is that the occultist looks upon the universe. It is a vast organism composed of an infinite number of entities. The welfare of these entities depend upon the welfare of the cosmos, and the welfare of the cosmos depends upon the collective welfare of these entities of which it is composed.

Now in our large industrial corporations the workmen usually know by name the head of the corporation for which they work. Few, however, are acquainted with him personally, and few know the details of other departments than their own. The broad policies of the organization are known to all, but the rank and file of workmen know little and care less about the board of directors and the elaborate studies that lead to the adoption of policies. Just so, we speak of the guiding intelligence of the universe as God, and some there are who have developed a state of consciousness by which they contact Him directly. We also know something of the particular department of the universe, a minute department to be sure this earth—in which we labor. We have not concerned ourselves for the most part with spiritual and celestial realms; for we have been too busy learning the little we know about the earth on which we live. But we are not so dense, if we will but look up from our immediate tasks, that we are unable to discern the broad policies upon which the universe is run. Every crystal, every plant, every man, bears within the stamp of the policy of progress and evolution.

This policy is carried out along those lines that industrial captains have found alone capable of lending greater efficiency to organization. That is, a large merchandising firm, a bank with modern facilities, or a complex manufacturing plant, follows the same plan to get high efficiency that Nature uses wherever complex forms of life may be found. This plan undoubtedly is the best so far devised; for in each of the instances cited it has been tested in active competition against other plans and proved successful. It is the only plan that has stood the test of time.

It is based upon division of labor. When a colony of plant cells for the first time thicken the walls of the cells on the outside of the colony to resist destruction by the elements, and when a colony of animal cells for the first time set aside a group of cells to perform the work of digestion, they are examples of early division of labor. Division of labor, however, also implies specialization of parts. The plant cells with thickened walls specialized in resisting wind and wave, and being thus specialized were less capable of other plant functions. The animal cells specializing in digestive work performed it with greater efficiency than cells not so specialized, but lost the adaptability of cells not so specialized to perform a wide variety of other work. Specialization is procured at the expense of adaptability.

When Henry Ford first inaugurated his moving assembly line it was an innovation based on the highest degree of specialization; and it has since revolutionized manufacturing methods. The man who all day long did nothing but tighten up a particular nut, learned to tighten this nut with unusual speed, but while doing this he learned nothing else. He was a nut-tightener, and knew no more about the engine of an automobile than if he had never entered a factory. His work detracted from his ability as a general mechanic. And something similar is ever the price of

specialization. But it gave him higher wages than he had ever known before, and instead of a seven-day week, or a six-day week, it gave him something not before known in industry, a five-day week.

If, from a social standpoint, Henry Ford's methods were a success, the higher wages, and the opportunities for self-development and self-expression made possible by a five-day week more than compensated for the lack of adaptability caused by concentrating the efforts during working hours on some mere detail. In the world of plants and animals, division of labor accompanied by the specialization of parts, each to perform a given function and thus losing ability to perform other functions, is always compensated for by greater ability to live. When this is not the case the plant or animal dies, the species becomes extinct. Every plant and animal in the world today higher than those simple colonial forms in which there is no division of labor, is a living witness to the soundness of Nature's universal plan—the plan that progress is to be accomplished by specialization of parts and cooperation, through division of labor, between parts.

Now all this may appear to have little bearing on the daily life of the ordinary individual who desires to make the most of existence through the utilization of occult powers and knowledge. But in reality it is of the utmost importance; for man can neither know what he wants to do nor what is expected of him unless he has some idea of his relation to the rest of life. He cannot hope to succeed by opposing his will and endeavor to the will and endeavors of all other forms of life. And to use occult forces without destroying himself he should know something about how the universe is run. He should know as much in a general way of the policies and methods of the universe in which he labors as he should know about the methods of any large organization for which he goes to work. These he may learn through observation.

Each Soul Has Its Own Important Work in God's Great Evolutionary Plan

—As previously stated, the major policy of universal activity is progress. This is attained by specialization of parts, division of labor, and cooperation between functions. Each individual is a workman in the cosmic organization, and either helps or hinders the attainment of the universal plan. As in a well managed industrial plant new men are not employed unless some work awaits them, so in the cosmic scheme of things there is some particular work mapped out for each individual to do. The kind of work, in each instance, depends upon the ability of the workman. Furthermore, one of the important efforts of all well managed organizations is to educate individuals, each according to his own qualifications, to hold a more responsible position. That is, the individual is trained, both by Nature and by the industrial or commercial concern, to fill some one position for which he is by temperament best fitted, and as high a position as his qualifications at the time will permit.

Obviously, it is not to the advantage of the organization, nor is it to the advantage of the individual, for him to attempt work for which he is temperamentally unfitted. Some of our largest merchandising firms make it a point, when an employee makes a poor showing in the department where first placed, to move him about for awhile from one department to another until it is determined just where he is able to give maximum service. A person who is a rank failure in the selling department is thus often discovered to be a valuable find in the accounting department, and a mediocre floor walker may at times be transformed into an excellent buyer. One who may be able to sell dry goods with utmost difficulty may, through a natural aptitude, become an excellent salesman of mechanical contrivances. It is to the advantage of the organization for the individual to be in the place he is best fitted to fill; for this leads to maximum efficiency. And it is to the advantage of the individual to find the work in the organization for which he is best fitted, because in it, in addition to being happier than elsewhere, he gets the most remuneration and makes the greatest progress.

The practical occultist, therefore, very early in his application of occult laws, makes a study of his own temperament and abilities, with a view to determining just what work he is best fitted to do in the cosmic organization.

In arriving at this decision he proceeds very much as if he were selecting merely his vocation as a citizen of the country to which he belongs. Such vocation, to be sure, is of importance in his cosmic work; for if he follows a vocation for which ill-fitted he lowers his efficiency in the greater work of life, of which his vocation, though important, is but a part. In selecting the cosmic work, however, other factors that influence vocational selection may be neglected and the attention concentrated on developing the natural aptitudes in the direction of maximum efficiency in aiding universal progress.

That is, the selection of a proper vocation is very essential; for through his vocation man should contribute constructively to society. But for reasons to be mentioned shortly it is often impossible for man through his vocation to do his highest constructive work. This work, however, is facilitated by selecting the proper vocation. Such a vocation enables him to contribute through it directly to human welfare, and through yielding him an income sufficient to afford him opportunity for other work, as well as providing him with the necessities and facilities of life, enables him also to contribute to human welfare in other ways than those directly involved in his vocation.

Thus it is that most of the important steps in human progress have been taken by men utilizing time outside of vocational hours. These men, for the most part, have made their living at something else, and have made their great contribution to society by utilizing such leisure and opportunity as the remuneration from their vocations permitted. Only recently, for instance, and these few in number in the research departments of our great industrial and commercial concerns, have men been able to make a living by being scientists. For the most part, outside the occult field, those who have contributed to scientific knowledge have been professors in colleges and

technical experts in the employ of industry. Their contributions to science have been made possible because teaching or technical work has provided them with a living; and they could utilize time outside of working hours to devote to their favorite pursuit.

The great philosophies of the world have not been expounded as a means of making a living. Their authors may, or may not, have obtained some material recompense if their works were published, but they were mostly the work of time not employed in making a living. Sometimes inventors make money from their inventions, sometimes not; but in proportion to the number of inventions in the world there are very few professional inventors. Most inventions are the result of spare time work of people otherwise gainfully employed. Even in the arts and in literature, where definite professions exist, it is not infrequent to find contributions of great merit made by those who regularly follow other vocations. Thus it is that while the vocation should be an important accessory to the life-work, it need not be identical with it.

Furthermore, in a life economically well adjusted, there should be some leisure and energy available beyond that used in making a living. Even the animals below man make a living. If man does no more than this his life is a failure. Beyond making a living he should contribute, at least in some small way, to the welfare of the human race and the development of the cosmos.

This contribution to racial advancement need be no great undertaking. A smile and a cheerful word are truly constructive factors in the scheme of things. Effort toward the development of character is an endowment in favor of mankind. The helping hand is a boon extended far beyond the one in immediate need of succor. Opposing bigotry and intolerance by word and by influence has its value as a universal factor. None there is, if the desire be strong, but who can help make this world a better place in which to live.

But first of all, before surplus energies can be devoted to the welfare of others, a living must be procured. Nor must we overlook the fact that the work of making a livelihood may be a constructive element in human progress. In order that they may live and thus have opportunity to develop spiritually and intellectually people must have food, shelter and raiment. Providing these, therefore, is constructive work, cosmically considered. Education is an essential to human progress, and is afforded not alone by schools and the printing press, but also by travel and motion pictures. Recreation makes more efficient work possible, art elevates the soul, mechanical devices free man from drudgery to devote his energy to better advantage, and the myriad of articles that contribute to man's comfort mostly assist him to emotional refinement and intellectual activity through making it unnecessary to direct the energies against the harshness of life. The occupations concerned with supplying these wants, which give man greater leisure and energy for self improvement, are decidedly constructive.

Some occupations there are that supply things men should be better off without. Cosmically viewed they are destructive occupations. But most of the vocations of men have a very real value in contributing something that is beneficial to human welfare. They should be looked upon, therefore, not merely as means of gaining a livelihood, but as an essential part of the work of cooperating consciously in the advancement of the cosmic plan.

The first thing, but not the only thing, in selecting a vocation, is to select an outlet for the energies in which the natural aptitudes have full play. Temperamentally, physically, and mentally, a person is fitted for one vocation and unsuited for another. The impulsive man has no call for an occupation where patience is the prime requisite, and the meek person is miserable in a position that calls for strife and initiative. Some people take readily to speaking and writing, others to mechanics, and others to business or the professions. Each person has some natural qualification which should be utilized through his vocation. There are various ways, such as intelligence and aptitude tests, by which a person's abilities may be gauged; but I know no other half so accurate as natal astrology. The birth chart shows at a glance, and without fail, in just what things there is a natural aptitude, and in which with proper effort, one can excel.

But ability does not necessarily make for success. In exercising the natural talent the environment may be such as to bring death or disaster. Many who have had pronounced ability as aviators have met untimely deaths. The finest mechanics often lose life or limb. Excellent merchants lose all through fire or flood. Important statesmen at times are shot down by political enemies. Writers are made subjects of libel suits. Fine doctors early contract disease from patients. And whatever the occupation may be, it has the possibility in spite of ability and every care, of attracting misfortune. That is, the exercise of the natural talents may, and often does, lead to an environment that brings ruin.

But natural talents are not so restricted that they must find their maximum expression through one particular avenue. The aviator might have exercised his mechanical talent without taking to the air, and thus prolonged both his life and his usefulness. The mechanic might have worked at the building trades rather than in a machine shop, and avoided serious accident. The merchant might have been a successful banker and have had no loss. The statesman might have exercised his talent as a successful lawyer and still be alive. The writer might have written fiction instead of biography and have avoided trouble. The doctor might have been a druggist and lived long and successfully. Had they but known it, each could have found ample expression for his talent, been of greater use to society, and have avoided overwhelming misfortune.

Such misfortunes are due to the environment with which occupations surround those who follow them. Others, however, follow these vocations and escape difficulty. That is, the influence of a particular environment, or association, on one person may be entirely different than upon another person, irrespective of ability. The soldier who gets no injury in battle is no more skilled than the soldier who is killed; but he has

within his astral body thought-cells possessing different desires, desires that exercise extra-physical power to attract opposite events in battle. So it is with other environments. Irrespective of ability, a particular environment, or association with a particular thing, attracts to a person events that correspond to the way the thought-cells feel relative to it.

Nothing in the realm of practical occultism, it seems to me, is more important than determining the effect various environmental associations will have on the life of the individual. Because thought-cells of a certain type are harmoniously organized in one individual and are inharmoniously organized in another individual, the same environment will attract untoward good fortune to one and excessive misfortune to the other. But place the same two persons where the associations are markedly different and the roles are changed, fortune visiting the previously unfortunate, and misfortune dogging the steps of the one previously favored. The effect of environmental influences to attract harmony or discord is exceedingly diverse in its application, and I shall speak more fully of it in connection with a wide variety of things in another place; but here it should be stressed as of equal importance with ability, in the selection of a vocation.

Not only should the vocation be one that will permit the full expression of the temperament and natural abilities, but it should be one in which the environmental associations will tend to attract so-called good luck.

Good luck is as essential as ability in making a success of the vocation, and by no means should be neglected. It is necessary, therefore, to determine in association with what things the most good fortune will be attracted. Various avenues of divination, or the exercise of the extra-sensory perception, may be employed in this determination; but by far the most reliable means, and that giving the fullest information, is natal astrology. The birth chart maps each important group of thought-cells within the astral body, indicates whether it is organized harmoniously or discordantly, and indicates just what things tend to stimulate it into harmonious activity or into discordant activity. From a scrutiny of such a chart, therefore, can be determined whether a person will be lucky or unlucky due to the environmental associations of any particular occupation. In fact, it is better to select the environmental associations that will prove most fortunate, and then determine in what ways the natural abilities and the temperament can be used in such an environment to the best advantage. Such a combination, selected by the use of common sense, gives the vocation in life in which the individual can be both the greatest personal success and of greatest value to his fellow man.

The Vocation May, Or May Not, Be Similar to the Cosmic Work

—This occupation may, or may not, coincide with the individual's highest constructive work in the cosmic plan. That is, while it is a vital and essential phase of his activities, the work in the cosmic scheme of things which constitutes his particular function may be of somewhat different character. As previously indicated, each individual is a workman in the cosmic organization, and has mapped out for him some particular work to do. This work is progressive, and may change somewhat from time to time, as in a bank, for instance, one who starts as office boy, may become a filing clerk, later a teller, and finally, through other positions, arrive at the station of president of the bank. The ability at the time, together with the work necessary to be done at that time, determines whether he serves as office boy, teller or president. Just so, in the cosmic organization, the service that at a given period is most needful, together with the natural abilities of the individual as indicated by a chart of birth, determine his proper work at that time.

In selecting the cosmic work, more attention should be given to natural ability and aptitudes and less to the harmonious and discordant factors that determine good luck and bad luck in selecting a vocation. Very frequently the kind of work that most needs doing at a given time is sure to attract opposition and some misfortune to him who does it. Pioneering, overturning outgrown ideas, advancing new and better ways of living and doing things, campaigning against bigotry and intolerance, warring against injustice and tyranny, and numerous other things that are necessary for progress, usually bring much unpleasantness and misfortune to those who do them. Reference to the birth chart indicates that in the environment of such effort inharmony will be engendered leading to trouble. The birth chart also indicates through what channels the desired end may be accomplished with the least difficulty and misfortune. But in the case of cosmic work, in the case of work that is vitally necessary to human progress, it is well worth doing at the cost of discomfort and individual misfortune. As a matter of record, the most important work in the world is done by those who have the ability to do it, but who have no regard for recompense, and no thought of the consequences to themselves.

Viewed from the standpoint of practical occultism each person should take up some endeavor, either in connection with the vocation or aside from it, for which he has natural aptitude, that he feels is useful in the advancement of the cosmic plan. In the exercise of one's talents there is a certain deep satisfaction. In the conscious cooperation with the Divine Plan comes a peace and happiness not otherwise attained. Life is lived thus at its maximum. And as a workman constructively employed in the universal organization, contacts will be made, invisible forces

placed at his command, and he will receive help and cooperation from others on the inner plane as well as the outer plane, that otherwise would have remained foreign to him. To work consistently for the welfare of the whole brings rewards far beyond the grasp of those not so employed.

The earlier in life the vocation and the cosmic work are selected the better; for an early selection permits the energies, instead of being directed into channels unproductive of the end in view, to be directed toward gaining proficiency in the selected line. The education of children, instead of being standardized, should be conducted with the view of fitting each for the vocation and the cosmic work for which the birth chart shows best adaptation. This eliminates the waste of much unproductive effort, and permits the acquirement of maximum efficiency in the chosen field. Musicians do not require the same education as do mathematicians, nor do dentists require the same education as do lawyers. High attainment is the result of specialization. And while it is well at any time of life to discover the proper vocation and the proper cosmic work, if, through a careful scrutiny of the birth chart by the parents, these are ascertained early in childhood, greater success may be attained.

Turning now from the problem of vocation and the problem of the specific cosmic work to be done by each individual, both best ascertained from an analysis of the birth chart, the next most important consideration is that of living the Completely Constructive Life.

Living the Completely Constructive Life

— Throughout nature we find the One Principle manifesting itself under two modes of motion: Construction and Destruction. Practically every emotional state, every thought, and every action lend their energies as adding to or detracting from our success in life. After all, life is not just a few important decisions and actions; it is the sum of countless moods, perceptions, conceptions and movements, only a few of which are noteworthy, but all of which contribute their little or their much to the sum total of attainment. Every minute of our lives we are contributing to or detracting from ultimate success. A neutral ground is difficult to discover. At all times, to a greater or less degree, our energies are flowing in channels that are destructive or in channels that are constructive. Only when the sum total of constructive energies is far in excess of the sum total of destructive energies is there satisfactory accomplishment.

One, therefore, who expects to make the most of life through the application of occult knowledge should early resolve to live in such a manner that all the energies, instead of only a portion of them, are directed constructively. This resolve should apply, not merely to more important matters, but to every detail of thought, speech, feeling and action.

Such a course, at its commencement, requires the analysis of all details of the life, and gradual adjustments in the ways of doing things.

Each thought, each emotion, and the customary actions should come under careful scrutiny-with the end in view of discerning in them destructive elements. When such tendencies are discovered a plan should be formulated and followed by which these destructive energies, instead of being repressed, may be diverted into constructive channels. They should be taken under consideration, one by one, and the effort made to trace their true origin and meaning. Not too many at one time should be given whatever attention and effort is necessary to transmute them into constructive potencies; for if too much is attempted at one time the task is apt to prove beyond accomplishment. In attempting only one thing at a time the objective can be kept rather constantly before the attention, and there will be less likelihood of it being neglected through oversight. Thus the energies should be concentrated upon some particular condition to be attained over a long enough period of time that the desired manner of thinking, feeling or doing displaces the old manner, and becomes habitual.

So numerous are the phases of life, each of which may be approached from the destructive attitude or the constructive attitude, that the discussion of them in detail will occupy much of this course. But in general a thought, feeling, or action may be tested as to its constructive or destructive quality by referring to its harmony or discord. Harmony tends to construction through its attractive power, but discord, because it is repellent, tends to destruction.

It is true, of course, that discord has its proper function in life. But enough discord is attracted into the lives of most of us, even when we live to the best of our ability the completely constructive life, that we need not seek misfortune in the belief more is needful. It is true, also, that destructive forces have their part to play in the larger scheme of things. Even as when a malignant growth forms in human tissue it must be removed, so must be extirpated malignant ideas that thrive on the healthy tissue of our social organization. This is the function of the iconoclast.

Nor does the completely constructive life compromise with evil. If bitter medicine is needed for the recovery of the patient, there is no shirking in its administration. But such medicine is exceptional treatment and should be administered only after careful analysis and deliberation have convinced that it is required by cosmic welfare.

To get the most out of life, then, we must live the completely constructive life, and this implies that we live as much as practical in a condition of harmony. This applies to our inner life, our private life, and our public life; but inasmuch as we attract from our environment conditions that correspond in nature and in harmony or discord with the thought-cells within ourselves, the first consideration should be in reference to the inner life. Steps should be taken to make the inner life harmonious, not merely at times, but twenty-four hours a day.

To begin with, our inner life is not harmonious if in any measure we are dissatisfied with ourselves. There have been, no doubt, errors both of omission and commission in the past. As we view life in retrospect, many things there are that we might wish changed. But this is a common factor of every life. The child in school misspells many words, gets the wrong answers to many problems, incorrectly pronounces many words. If he needed no practice in reading, spelling and mathematics he would not be sent to school. And if we could solve correctly all the problems of life and make no mistakes in our actions there would be no need for us of earthly experience, and it is extremely doubtful if we would be here.

As does the child in school, we advance in knowledge through discovering where in the past we have made mistakes. These mistakes, these errors of judgment, of sentiment, of passion, may have been painful to ourselves or may have been painful to others. They may be mistakes that in this life we can never rectify with those wronged. Nor should we be callous about it. But we may take the view, and rightly, that society is a vast clearing house. We may not be able to pay the debt directly to the one to whom due, but we can pay the debt to society, pay it by constructive work and the assistance of others, and confidently expect, in the long reach of time, and in some manner, our creditor to receive his just due. We should resolve, by constructive effort for the benefit of society, to recompense such, if any, that we have gravely wronged; but for the past we should care only for its lessons. The past is gone, nor can we recall it, and the energy spent mourning over its failures or lost opportunities is energy that could better be used to provide for a satisfactory future. Dissatisfaction, as well as sadness, grief and despondency, is a destructive mood. It is discordant, and as such contributes energy and discordant desires to certain thought-cells within the astral body. The activity given these thought-cells completes the vicious circle and attracts unfortunate events which make the efforts seem even more futile. We cannot afford to harbor thoughts of dissatisfaction.

It is most difficult to form a just estimate of one's own true worth. It is easy to believe that one should accomplish that which at the time is impossible, and it is easy to believe that something which could readily be accomplished is quite beyond reach. The temperament, as indicated by the birth chart and as contributed to by childhood impressions, may be such that one believes he should be capable of great deeds, or it may be such that one expects almost nothing of himself. In the one case, no matter how much progress is made there is apt to be self-dissatisfaction; while in the other case there is satisfaction even if nothing has been accomplished. Who shall say, with certainty whether, all things considered, we should have done better?

At least, because it is gone, it is wasteful to spend time or energy in regrets. The present we have with us, and we will never know how far we can yet progress unless we try. And the first step in trying is to become satisfied with oneself. Such self-satisfaction comes to one who each day does the very best he knows how.

Each day is a cycle in itself. It is a complete phase of existence. Yesterday may have been a good day, or it may have been a bad day, but irrespective of it, today may be made successful. Great wars are not won without losing some battles, nor are new habits of life formed without there being days in which they suffer defeat. Each day, also, has its own victories and defeats. We do not accomplish at once the difficult things we set out to do. We accomplish them only by persistent and ardent practice. One does not learn to speak a foreign language in an hour, nor does one become expert at golf in a day. But by our repeated mistakes, by our recurrent failures, we gradually learn. So in learning to live the completely constructive life there will be many failures. Some days will be dark. But if each day is considered a new opportunity to test one's skill, if it is looked upon as a trial anew of one's ability, and this great game of life is played with zest and enthusiasm, the progress that after a time will be apparent will be more than gratifying.

In changing the life to conform to completely constructive habits, and thus enter into the consciousness that one is cooperating intelligently with the Divine Plan, one of the greatest obstacles is the tendency to forget, in the absorption of the affairs at hand, the details of what one is trying to do. If one but remembers that anger is to be converted into constructive activity, that irritation is childish, that discouragement is devitalizing, at the moment when these emotions are stimulated, it is not so difficult to transmute their energy into more harmonious channels.' But because the event at hand and the stimulus occupy the attention so completely at the time, the emotional reaction is apt to take place before there is serious thought as to its propriety. Consequently, one of the first things to learn is an attitude of constant vigilance toward the character of all thoughts, feelings and actions.

As a help in this direction, which has been followed by many sages in the past, it is well on waking in the morning to formulate as clearly as possible the activities for the day. In this plan of the day's efforts due importance should be placed on thoughts and emotions as well as on actions. Then at night, just before going to sleep, it is well to review the accomplishments of the day with the purpose of discerning to what extent the morning plans have been carried out, and what factors hindered the carrying out of these plans, and how such factors in future may be eliminated or overcome.

In the ordinary run of life as it is presented to the housewife, the business man, the artisan and the laborer, circumstances repeatedly arise in the course of the day's activities that bring more or less feelings of irritation. Some people are so situated and so temperamentally inclined that they express this irritation audibly or in other ways. Others, through consideration of the feelings of others, or through desire to hold their position, give little outward sign of irritation, but nevertheless feel it keenly.

All such feeling of annoyance, whether expressed, outwardly or not, is discordant and acts as a destructive force. The jangle of the nervous system, through its electrical energies, sets up a jangle of vibrations in the astral body. Through repetition these build up discordant thought-cells in the astral form. These thought-cells then work from the inner plane to attract inharmonious environmental conditions. They bring into the life events that make success in any line more difficult.

Such feelings of irritation go a long way back in the person's mental history. In fact, they go back to the time of birth as one of the three unconditioned responses of the new-born child—fear, rage, love—that may be aroused by unconditioned stimuli.

Hampering the movements of a new-born child causes it to express rage. As the child grows older it finds that the expression of rage or irritation or discomfort enables it at times to have its own way with parents or playmates. If crying brings it the things it wants, the crying habit is formed. If violent rages cause it to be noticed—for all children desire notice—the habit of violent rages is apt to be formed. If the child can get what it wants by making a scene, we have the infantile background for the hysterical adult. But after all, these are childish expressions. They should have no part in adult life because they detract from efficiency and success. They are one and all destructive.

They are on a par with the person who kicks a stone because he stumbles over it, or smashes a table because he runs against it in the dark. In the one case he hurts his own toe, and in the other must supply a new table or repair the old one. The child, and the primitive man, have a feeling that inanimate objects are activated by feelings of hostility or kindness. They abuse a stone that has hurt them because they have the feeling that the stone is responsible.

The feelings of irritation at the circumstances of daily life are but infantile hangovers. They are childish emotions that should have been outgrown. By attracting other events that give rise to further irritation they complete a vicious circle. They thus always defeat their own ends. Consequently, they must be transformed into constructive energies by those who would live the completely constructive life.

Chapter 2

Serial No. 152
Original Copyright 1943
Elbert Benjamine

Copyright
August 2002
Church of Light

Living the Completely Constructive Life

Chapter 2

Living The Completely Constructive Life

IN this Course of lessons it is my intention to bring up as wide a variety as possible of those problems with which people are confronted in their daily lives, and indicate the manner in which occult knowledge and forces can be used to gain a satisfactory solution. I have started with the most important problem of all, that of finding one's true work in the cosmic scheme of things, including the selection of the best vocation.

It is the most important problem at some time confronting every individual, because one cannot succeed in any worth while undertaking without having a proper objective toward which to work. With such an objective in view the next most important problem is how it may be reached. In this, because true success depends on cooperating with the Divine Plan rather than opposing or ignoring it, the most important step is the adoption of the completely constructive life.

And the first step in this, and the most important step, is the conversion of all discordant thoughts and emotions into those harmonious.

Lest anyone should think, because earthly life is so short, that the selection of some line of activity by which one may contribute somewhat to universal progress and welfare is of little consequence, it may be stated that such activity started here continues beyond the tomb. I do not mean that automobile mechanics will continue to repair automobiles, that the corner grocerman will continue to dispense vegetables, or that the banker will loan money and collect interest for the stockholders of the bank. But I do mean that every constructive line of work, every occupation that satisfies a human need, trains those who follow it for a special work needing the exercise of the same faculties that may be taken up on the next plane after physical death.

When we find our work in universal society, that work is not confined to any one plane. We not only follow it here, but we follow a corresponding line of activity in still higher realms at the close of physical life. What we learn about our work while still on earth becomes an asset to us in the spirit world. In the work—our cosmic work which we have adopted because in it we can best serve both our own interests and the interests of cosmic progression—we do not remain stationary. We move forward, advancing step by step to greater knowledge and efficiency. As we master certain

phases of it we progress to more complex activities. The successful grocer has developed qualities—particularly if his success is real in that he has rendered a public service through efficient distribution of produce at low cost—that fits him to distribute efficiently, not groceries but other things, in the life to come. The mechanic in the after life has no automobile to repair; but he does have ample opportunity to exercise all his mechanical skill and ingenuity. The banker has neither money nor bank after he passes to lower astral planes; but there is still a cosmic need for his ability to conserve and furnish on short notice certain resources found on the plane where at the time he dwells.

The nature of the various things with which man works when he reaches the higher astral and spiritual planes of life can only be referred to by comparing them to the things of physical life. They are things, however, of a higher higher-velocity region, and cannot be visualized in lower-velocity terms; nor is there a vocabulary to describe them; for our vocabulary all refers to low-velocity life. All descriptions, therefore, of the surroundings of man on the spiritual plane and of his activities there, are necessarily extremely unsatisfactory. In so far as such descriptions are accurate they contain contradictory statements that render them rather confusing; for so many things that are impossible and contradictory at the low velocities of physical existence, where time and distance and gravitation as we know them are limiting factors, are possible and are facts in a region where velocities are sufficient that the laws of Relativity demand that time, and distance and gravitation as we know them disappear, and other properties take their place.

Thus through correspondence only, do most things of the spiritual plane resemble the things of the physical world. Yet our objective experiences, and the images, thoughts, and vocabulary arising therefrom, all pertains to the slow-moving physical world. We have no mental images with which, even to ourselves as yet, truly to picture conditions which exist on inner planes; conditions which perhaps we are able to perceive with our psychic senses. The law of mental association, however, comes somewhat to our aid. What is perceived on the inner plane, through its correspondence, suggests something on the physical plane with which we are familiar. Instead, therefore, of the true image of what is transpiring on the spiritual plane which is actually perceived by the psychic senses if our psychic faculties are developed, when it is raised into the region of objective consciousness we see images and activities pertaining to the physical plane which the true image suggests.

That is, our perceptions of spiritual life, whether we get them clairvoyantly, through travel in other realms, or merely receive the reports of those who have died and passed to that plane, must all be translated from extremely high-velocity terminology into low-velocity terminology. Likewise, our perceptions of life on the astral plane, before we can be objectively conscious of them, must be translated from high-velocity terms to low-velocity terms. Consequently, it is futile to try to give a true picture of life in the spirit world. The very best we can hope to do, and this will necessarily include many contradictions because possibilities on one plane are often impossibilities on a lower plane, is to indicate those situations of physical life that

most closely correspond to the conditions of spiritual existence. This has been done in Course 20, THE NEXT LIFE. In that Course the principle is explained through which it is possible to tune in on the inner plane in full consciousness, what determines the inner-plane level which is thus contacted or on which a soul more permanently resides, how movement across the inner plane levels is accomplished, what determines the environment on a given level to which an individual moves, and the conditions to be encountered immediately after birth into the next life.

In that Course it is also explained how the strange properties that govern existence in the next life are consistent with Relativity, including the power of thought to build objects that seem as solid as concrete, and the influence of desire. Education, progress, domestic relations and social contacts are likewise considered, and the currency there used and the occupations followed. But these occupations, of course, are adapted to the laws and conditions of that realm.

I shall not attempt, therefore, to describe just what the work of a lawyer, a traveling salesman, or a farmer will be on the astral plane or on the spiritual plane. But in each case if the work is that for which the individual is best fitted he will find opportunity on higher planes to utilize his abilities and acquired knowledge in a line of effort corresponding to, and growing out of, the occupation he followed while on earth. The cosmic work, it will be seen, is not simply a line of effort during physical life, but a line of effort, utilizing the natural qualifications for cosmic welfare, that continues, one phase developing from another, into the vistas of life on successively higher planes after physical death.

Converting Discordant Thoughts and Emotions Into Those Harmonious

—Thoughts and emotions, as well as behavior and the events which enter our lives, all belong to one of ten distinct types. They are stimulated into activity by conditions encountered in the external environment. But even so, they are chiefly the expression of the thought-cells within the finer form. These thought-cells whose organization constitutes the soul, or character, or unconscious mind, are of ten different types, each type mapped in the birth-chart by its corresponding planet. It is the activity of these thought-cells which, under stimulation received from environment, influences the trend of the thoughts and emotions. If these thought-cells are mapped by planets discordantly aspected, it indicates that they have been formed through unpleasant experiences of their type, and that they therefore work to express through discordant thinking and discordant behavior and unfortunate events of their type. On the other hand, if the thought-cells are mapped by planets harmoniously aspected, it indicates they have been formed by pleasant experiences of their type, and that they therefore work to express through harmonious thinking and harmonious behavior and fortunate events of their type.

But as has been proved through CASE HISTORY STUDIES of the lives of identical twins, natural twins and astrological twins, either the harmony or the discord that has been built into the thought-cells of any one of the ten types can be altered through training (conditioning). That is, one born with harmonious thought-cells of a given type can train them to feel discordantly, and to strive to express discordantly; and one born with discordant thought-cells of a given type can train them to feel harmonious and to strive to express harmoniously. This process, whether carried on deliberately, or unconsciously through responses to experiences furnished by the environment, is called Reconditioning. And all persons are thus to some extent reconditioned after birth in reference not only to harmony and discord, but also in reference to the specific things their thought-cells work for.

The general characteristics of the thoughts which are the expression of the thought-cells mapped by a given planet cannot be changed. But it is not too difficult a task to train thoughts that habitually have expressed the destructive qualities of the thought-cells mapped by a given planet to express instead through that planet's constructive qualities. For example:

Sun thought-cells cannot be made to express inferiority, but instead of expressing through domination they can be trained to express through significance.

Moon thought-cells cannot be made to express aggression, but instead of expressing through mental instability they can be trained to express through domesticity.

Mercury thought-cells cannot be made to express blind belief, but instead of expressing through nervous disorders and restlessness they can be trained to express through intellectual activity.

Venus thought-cells cannot be made to express hatred, but instead of expressing through unrestrained emotion they can be trained to express through art or affection.

Mars thought-cells cannot be made to express caution but instead of expressing through demolition they can be trained to express through building something.

Jupiter thought-cells cannot be made to express discrimination, but instead of expressing through surfeit they can be trained to express through benevolence.

Saturn thought-cells cannot be made to express courage, but instead of expressing through fear they can be trained to express through systematization.

Uranus thought-cells cannot be made to express conservatism, but instead of expressing through agitation they can be trained to express through invention.

Neptune thought-cells cannot be made to express crystallization, but instead of expressing through fraud they can be trained to express through idealism.

Pluto thought-cells cannot be made to express isolation, but instead of expressing through coercion they can be trained to express through cooperation.

A New Habit Must Be Formed

—To carry out such training, a new habit must be formed of instantly noticing, at its inception, each disagreeable thought and feeling, and changing its direction so that its energy flows into channels that make it agreeable and pleasing. That is, new and permanent habits of thought and feeling are to be formed in which painful, disagreeable, and unpleasant states of consciousness have no place, but in their stead there are to be thoughts and moods of harmony, pleasure and joy. Such inward harmony is the most effective means of attracting pleasant and harmonious conditions in the environment, and thus conduces powerfully to all attainment.

New habits, however, are difficult to form, especially when their function is to displace others well entrenched. At best their adoption is rather slow, and requires both attention and work. But those such as we are now considering, because they make the life so much more happy and useful, are well worth the time, trouble and effort entailed.

The initial difficulty in forming a new habit is to remember at each proper time that a certain course of action has been determined upon. In the case at hand, in order to form the habit of changing discordant thoughts into harmonious thoughts, it becomes necessary instantly to remember every time an unpleasant thought or feeling commences that such thoughts are not to be entertained. It is all too easy to resolve not to permit thoughts of a certain type to enter the mind, and then when they appear to forget, in the mental and emotional activity they occasion, that they are forbidden.

To overcome this difficulty application may advantageously be made of an occult law, the law of suggestion (lesson No. 62 [See Serial Lesson Key]). In this case the suggestion may best be applied in the form of an affirmation (lesson No. 63 [See Serial Lesson Key]). To be effective the affirmation should be repeated several times on each occasion, and there should be several occasions each day. Then comes the problem of not forgetting to repeat the affirmation. This is best solved through application of the law of association (lesson No. 58 [See Serial Lesson Key]), tying the act of repeating the affirmation to some other action that has already become habitual. Such a habitual act is that of eating. Therefore, if the practice is adopted of repeating the affirmation several times before partaking of food, after a time, such is the force of habit, one will feel uncomfortable to partake of food before repeating the affirmation.

The affirmation, however, should do more than merely jog the memory whenever discordant thoughts enter the mind. It should also direct the attention of the unconscious mind to just what is to be accomplished. The powers of the unconscious mind are vastly superior to those of the objective mind, and they should be enlisted thoroughly in behalf of the new harmonious habits of life. Thus the affirmation should set forth in a clear cut manner the complete process. The following affirmation, I believe, fills these requirements: I AM ALERT TO OBSERVE THE

APPROACH OF THOUGHTS, FEELINGS, AND EMOTIONS THAT ARE DISAGREEABLE: AND IN THEIR STEAD I ENTERTAIN ONLY PLEASANT THOUGHTS, FEELINGS, AND EMOTIONS.

By repeating this affirmation several times before each meal, the attention of the unconscious mind is directed in an effective manner to what is expected of it. And as the idea embodied in the affirmation grows in power through daily repetition of the suggestion, it will gradually transpire that every time a disagreeable thought, feeling, or emotion commences, immediate notice of it will be taken, and one will be fully aware it is an important matter that it should be changed into a more pleasant channel.

Unpleasant thoughts, feelings and emotions cannot be changed into those pleasant by merely willing to change them. If they are to be changed, and each can be diverted into a harmonious channel, certain fundamental psychological laws must be observed.

Some things it is better not to think about at all. Other things are legitimate subjects of thought, but because of their real or fancied importance they occupy the mind too persistently. We think the same thing over and over without making any substantial progress. This we call worry. Worry, like other disagreeable thinking, not only creates discord in the astral body that tends to attract misfortune, but by wasting energy and destroying confidence works to defeat its own end. It is better, also, when the duties of life do not demand contact with such things, not to think about anything that gives rise to fear, hate, rage, disappointment, grief, sorrow, anxiety, or any other disagreeable emotion.

But it is not enough merely to will to stop thinking about a given situation or event. The laws of psychology demand that in order to stop thinking about one thing toward which the interest is attracted, that the attention must be diverted to some other thing that has about it an interest, spontaneous or acquired, that is equally intense.

Two or more thoughts or images cannot occupy a large part of the attention at the same time. The more fully engrossed the mind is with one set of thoughts the less room is there for any other set. The easiest way to stop thinking about one thing is to commence thinking about something else.

But unless the something else, artificially or spontaneously, can attract as much energy as the first thing thought about, the attention soon is drawn back to the first subject. Therefore, when first made aware that disagreeable thoughts, feelings and emotions are beginning to be entertained, the best plan, when it is not absolutely imperative that they be given attention, is immediately to begin to think about something else.

This something else, under these circumstances, should always be something intensely interesting and something pleasant. For this purpose it is well to think out in advance for use when the occasion arises several of the most interesting and pleasant experiences of life and several of the most interesting topics of thought. Then, when unpleasant mental states start to invade the thoughts these may be used as shock

troops to rout the invaders. Those thoughts having the most energy will retain the mental field. Therefore, that they may have abundant energy, those chosen for routing purposes should be about the most pleasant and most interesting subjects imaginable.

This plan of action is not only effective where feelings of fear, grief, anger, disappointment and self-pity are concerned, but may be used advantageously against worry and against malicious or annoying thoughts sent to one from another.

The latter subject has been discussed in detail in lesson No. 101 (See Serial Lesson Key). But it may be well here also to point out that this same method by which one may shut out disagreeable thoughts, feelings and emotions, may be used to shut out mental influences directed toward one by another. The thoughts of another will only enter and affect the astral form when there is some measure of rapport with the other person. By thinking about a person, or thinking about an unseen influence, we tend to tune in on the vibrations of that person or influence. Psychic energies, either from discarnate, incarnate, elemental or other sources, are contacted through rapport with them. But if we resolutely maintain another rate of vibration by thinking intently about something entirely different, psychic entities, malign magnetism, pernicious thoughts of others, or any one of the other invisible conditions by which people are sometimes afflicted, are unable to tune in on this vibration, and as a consequence are unable to exert an influence upon us.

When investigating spiritualism and other psychic phenomena, if we do much research we are sure to come in contact with cases of obsession. Black magic and obsession are pet subjects of conversation in many occult circles. But neither black magic nor obsessive influences are effective against any person who learns to direct his thoughts (lesson No. 58 [See Serial Lesson Key]), or who persistently applies the method of directing the attention given above. After all, thoughts are quite as obsessive as unseen entities. Of those in the insane asylums many, undoubtedly, are obsessed by unseen entities. But probably a greater number are obsessed not by another entity, but by their own ideas.

Obsessive Thoughts

—Of the two more common forms of insanity, dementia-*praecox* and paranoia, the latter is a condition in which undue importance is given to certain ideas, so that the thoughts no longer coincide with real conditions, but are warped from the normal. Thus we have megalomania in which the person so intensely desires to be important and do great things that he comes to believe that all he does is very wonderful, and so strong does this thought become that it creates a delusion and he believes himself some noted person and that the destiny of the world hangs on his word. Another common form arises chiefly from fear. The thought is persistently entertained that certain persons are endeavoring to injure him. This idea grows to undue importance until the delusion is entertained that certain individuals, often important and

powerful individuals, or it may be relatives who actually love him, are doing him harm. If the case develops far enough, the individual suffering from such a persecution complex may resort to violence to rid himself of his imaginary enemies.

Now an obsession may arise through an induced or a natural mediumship of an extremely negative character, in which some other entity takes control of the individual and causes him to perform acts that he would not do under normal circumstances. Or it may arise through some thought or emotion gaining such power over the individual that it causes him to think and act in an abnormal manner. People who think they are persecuted by unseen influences often merely are paranoiacs who have this as their dominant idea.

Yet it should be realized that paranoia and obsession are merely extreme developments of conditions obtaining in a much less degree in all. Most persons are not so symmetrically developed but that they permit one or more idea to warp their judgment about other things. The paranoiac, however, is so dominated by his pet idea that he can perceive nothing in the external world that interferes with the soundness of this idea. He thus, in this respect, retreats from the world of actuality and substitutes a subjective world of thought in which, in so far as this idea is concerned, things come to pass as he has decided they must. It will, consequently, be seen just how dangerous it is for one to shirk facing facts and the realities of life.

We thus perceive in the fundamentalist who refuses to believe the evidence of his own senses and reason rather than relinquish an emotional religious conception implanted in the plastic impressionable years of his youth, a condition which magnified becomes psychopathic. And taking one step further, we perceive in anyone who temporarily loses self-control through anger, fear, despondency or other emotion, a condition which magnified becomes an obsession.

Knowing, as we do, that disagreeable thoughts, feelings and emotions are destructive to our welfare, we only entertain them against our will. If, therefore, in spite of our resolution to keep them out, in spite of our efforts to eject them, they enter our mental dominion and remain for a time, they are obsessive in character. Recognizing this, we should at all times be alert to perceive their approach and to use our pleasantest memories and plans as forces with which to resist them.

To be sure, discords abound in our environment. Any accomplishment implies the overcoming of difficulties. In fact, the more numerous and the larger the difficulties surmounted the greater the accomplishment. Life should be a constant struggle to overcome the limitations of environment. Situations arise daily that to the mentally uncontrolled person cause annoyance, fear, irritation, anger, or other malignant emotions. But by other people similar situations are met not with discordant emotions, but by an energetic desire to meet each situation in a manner yielding the most constructive results.

I have already mentioned the danger of failure to face and recognize facts. When a fact is presented to us if, instead of recognizing its existence even by considering it unexplainable in the light of our present understanding, we substitute for this fact a mental picture of how we had preconceived it, and thus warp the fact to our preconception, we have taken a step, even though a small one, in the direction of paranoiac insanity.

But in addition to facts and conditions that are widely at variance with our preconceptions, life holds many situations that are difficult to face, many responsibilities that seem unduly heavy. Yet to flee from these, to shirk facing them, is even more dangerous than warping facts to mental images; for in this direction lies dementia-*praecox*.

When the individual finds the life of the external world so harsh that it is unbearable he retreats into his own mental images and lives, not in the world of reality, but in a world of imagination. Commonly, in this turning the mind inward, fleeing from the harshness of reality, he reverts to the infantile stage of development. In his infancy he had no responsibilities, was fed, and waited on hand and foot. So even though at the time of this mental retreat from life he has reached adulthood, when the mind, suffering from a shock in which it could not face some condition, turned inward, he reverts to the mental state of childhood, or even in extreme cases to the fetal stage, in which everything was done for him. In such cases, common to be seen in our insane asylums, the person is unable to feed or dress himself, and must be waited on as an infant. His mind takes little or no recognition of external events. It is absorbed completely with its own fantasies.

I mention paranoia, obsession, and dementia-*praecox*, not because the ordinary person is in any danger of developing such insanity; but because the ordinary person at times yields in minor ways to tendencies that are detrimental to him, and which in unusual and extreme cases do lead to the asylum.

During the course of nearly everyone's life situations arise in which it seems almost impossible to carry on. Tragedy, sweeping financial loss, sudden sorrow, loss of prestige. Suicide is but another way of retreating from reality. Instead of seeking the shelter of his mother by reverting to the infantile stage of development, the suicide tries to escape from reality by retreating into a state of unconsciousness. He lacks the courage to face life as it is presented to him. But one versed in spiritual alchemy (Course 3) is not apt to make such a mistake. For he realizes that the only permanent values he may extract from life are those that pertain to the development of character. He knows that the external circumstances of life, including the death of the body, are of much less importance than the manner in which he reacts to these events. Whatever conditions arise, he endeavors to meet them courageously as a necessary part of his training for a better life to come.

Courage Must Be Substituted For Apprehension

—The progressive soul should train itself to the view that no condition can arise in life which it will lack courage to face. There are things that it is much better not to think about, and there are conditions that occasionally arise in some lives that seem terrifying. Yet man should be unafraid, if necessity arises, to face any condition or to think clearly about any situation that exists in the whole domain of nature. Caution is a valuable asset, but fear paralyzes effort. Fear has no part to play, at any time, in the completely constructive life.

While, by using strongly pleasant thoughts to displace them, we can drive unpleasant thoughts and emotions from the mind, there are times when it is imperative to give thought and attention to conditions which tend to give rise to disagreeable emotions. If we are beset by a danger, for instance, it may not be wise to neglect thought of it. A danger, however, even though thought about, need not be feared. In the first place the mind should be trained by a study of spiritual alchemy not to place undue importance on physical welfare. It should be recognized, and this recognition so habitual as not to be obliterated by the presence of danger, that the really important thing about any situation is the manner in which one reacts to it. Then in the second place the attitude should be taken that a danger is a situation to be met and overcome.

No matter how serious the danger is, it should be accepted as all in the day's work, so to speak, to meet it and to give as good an account of oneself as possible. The energies should become so thoroughly enlisted in devising and carrying out means to meet the danger and triumph over it, that there is no room left in the consciousness for the emotion of fear or thoughts of disaster. In such a case, instead of using the most pleasant thoughts imaginable to oust the disagreeable and disintegrative thoughts and emotions, use is made to the same end of intense concentration to meet and overcome the danger.

Apprehensiveness is quite common with a certain type of person. He confronts various unknown quantities with a feeling of anxiety. When unexpectedly called by telephone he takes down the receiver while wondering if he is going to receive criticism or bad news. When unexpected mail arrives he shrinks from opening it for fear it will contain disagreeable information. Whatever is new or strange or sudden that confronts him he approaches diffidently with the half expectation that it holds something disagreeable or inimical to him.

Such a person is suffering from an anxiety complex, the usual cause of which is well recognized by psychologists, but which need not be considered here. What we are concerned with here is how to overcome it, for it is incompatible with constructive effort. To do this it is well to recognize that such a mental attitude is grounded in no more reality than the child's fear of the dark. In fact, in its manifestation, it is no more than a survival of the child's fear of the dark transferred to various other unknown quantities.

Whenever, then, there arises a feeling of apprehension when confronted by something whose factors are unknown, one should explain to oneself several times that this is merely the survival of a childish fear, and that it has no normal place in adult life. It should be reflected upon that most unknown situations in the past have offered no great difficulties when finally confronted. Again spiritual alchemy should be considered as indicating the things that are of real importance, and it should be realized, whatever might befall from this or other situations, that it may be made of spiritual value and advantage. And finally it should be affirmed in these words or in others of like import that: I Have Within Me the Power to Meet and Successfully Cope With Any Situation That May Arise In My Life.

The attitude should be so firmly established as to become a habitual mood that there is no shrinking from any situation, real or imaginary, that may arise in life. Instead of there being a dread of unknown factors, there should be supreme confidence that whatever the life attracts can be successfully met and mastered. Such self-confidence is not egotism; for it applies only to problems and situations that the person is required to solve, and does not imply that he can conquer any situation that he might seek. It is self-confidence that quickly proves itself founded on fact. It is the self-confidence of the completely constructive life.

**Constructive Action Must
Be Substituted For
Irritation and Sorrow**

—Nor usually can we merely set to one side the many incidents that tend to arouse in us the feeling of irritation. Mistakes are made by ourselves or our associates. Unexpected calls upon our attention and energy are demanded. Our employer is sharp spoken or unreasonable, or our employee is a blunderer and an incompetent. The wife nags or the husband is cross. Our mail goes astray. Someone fails to keep an appointment, or keeps us waiting. Bills are received that already have been paid. Our food has been overcooked or undercooked. Our competitor has gained an advantage. We have been snubbed by an acquaintance. And a thousand and one other things occur that tend to irritate us that we cannot afford completely to ignore, but to which, of necessity, we must devote thought and attention.

Now there is just one way to face any and all such situations as these. First, if we have permitted the feeling of irritation to enter, we should, as explained in detail in lesson No. 151 (See Serial Lesson Key), realize that irritation is the survival of a childish trait. Think about the childishness of the irritation until some conviction is felt, then turn the attention resolutely to the problem.

Come to recognize that every condition that stimulates the feeling of irritation presents a problem to be solved. Irritation is an expression of unwillingness or inability to meet and solve the problem as presented. It indicates weakness, for this situation is a part of life, and as such requires intelligent action.

But instead of intelligent action we waste valuable energy in an emotional display because the problem has arisen.

Yet all must recognize, who give it thought, that the measure of greatness in life, even the measure of any person's ability, is his willingness and capacity for overcoming obstacles. A man is considered strong when he triumphs over adversity, he is considered weak when he permits opposition of no great moment to deflect him from his purpose or to defeat his aim. Irritation at any situation that arises is a tacit admission for the moment that the situation is baffling, that it presents obstacles beyond the size of the individual to cope with successfully. The individual's desire to shirk the responsibility of meeting it expresses itself as emotion.

We should not choose for president of our country or for other high office, a man who often permitted himself to be irritated or oppressed by the inefficiency of his office staff, or by the mistakes of his subordinates. Instead we would expect him to remedy the conditions which tended to irritate. Unwillingness to meet the numerous small problems that tend to give rise to annoyance clearly shows that the job is too big for the man. It shows that the person is as yet unfit for heavy responsibilities.

There is only one proper way in which to meet every obstacle, every mistake that has been made, every loss that has been sustained, every problem that presents itself. That way is to view the matter coolly, unemotionally, and confidently, with determination to find the best course of action possible under the circumstances. Instead of expending energy emotionally, energy should be spent constructively. Instead of thinking; Why did that have to happen?; we should think; What is the best thing to do now? The energy should be diverted instantly, first to analyzing and formulating a plan of action, and then to carrying it out. Instead of energy being consumed in destructive irritation and annoyance, it all should move toward correcting the situation.

This applies also to loss and to those events which tend to occasion disappointment and sorrow. Life is not so ordered that we logically can expect to avoid periods when loss will occur. Our friends and relatives, some of them, will die. Mistakes will occur in which we will lose money. Events at times fall out in a manner that is decidedly distasteful, and perhaps imperils life, honor, or financial standing. Yet all time and energy spent grieving, feeling hurt, or in despondency not only tend to attract more misfortune in the future through building discords into the thought-cells within the astral body, but consumes energy that well could be used to remedy conditions.

Not all conditions can be remedied in the sense that a particular loss can be recovered; but at least the energy can be diverted into some channel that will bring, instead of additional loss in the future, some gain. If, after-careful reflection, it is decided that a loss is of a nature that it cannot be recovered, or a situation cannot be remedied, it should as quickly and as thoroughly be dismissed from the mind. Pleasant thoughts may be used to drive it out, as already explained. But if there is anything that can be done to retrieve the loss, or to remedy the mistake, the mind should so concentrate on this constructive effort that there is no room in it for thoughts and emotions concerning the loss or other disagreeable occurrence.

Effort At Self Improvement Must Be Substituted For Self Pity

—Still another type of disintegrative thought which is commonly met is self-pity. It manifests in quite a variety of forms; but the most usual are sensitiveness to criticism and slight, or otherwise permitting others to hurt the feelings; the thought that one does not receive fair treatment at the hands of fate, or proper recognition for meritorious actions and the conviction that one has an unusually hard time in life, a much harder time of it than most people.

Any such manifestation of self-pity, when we stop to analyze it, is seen to be a form of cowardice. It is one way in which the proverbial streak of yellow comes to the surface.

No one has the power to injure our feelings except as we permit it. If another person's actions are unjust, our conviction that he is malicious or misguided should turn immediately to a consideration if it is better to ignore the matter or to take some remedial action. Of course, if we magnify our importance, such megalomania may cause us to believe that fate and persons owe us special considerations, and thus, not getting it, we will constantly feel abused. But viewing things as they are, there should be no room left in the mind for feeling hurt. If the criticism or slight or other treatment is merited and deserved, instead of shrinking and whimpering about it, we should take our punishment stalwartly.

When we come to recognize, through a study of astrology that the circumstances of our lives are attracted to us because of the activity of thought-cells within our finer forms, and from astrological signatures (Course 2) that they are such as at the time we need for education, we are not apt to believe that either fate or people impose upon us without adequate cause. This cause lies within ourselves; and we should, instead of complaining at the injustices of life, and thus perpetuating the discord that attracts injustices, spend our energy altering ourselves (Course 9) so that better fortune will be attracted.

Furthermore, close observation of those persons who continually whine about being mistreated by others, and those who constantly complain of their hard lives, reveals, as a rule, that considering their traits of character as they impress others, they cause others to mistreat them to the extent they are mistreated, or have developed a martyr complex in which they would not be happy unless they could show cause for complaint. And as for their hard condition in life, it would be no harder than that of others if they would work constructively to change it, rather than bewailing their fate.

I could here also mention anger, despondency, discouragement and a number of other disagreeable emotions. But the same method of treatment may be applied to all of these, as to those types of disintegrative thoughts, feelings, and emotions already considered. If attention to their objects is not obligatory, they should be crowded out by pleasant thoughts. But if they demand attention, the energies should be so concentrated on finding and carrying out the best course of action that there is no room for anything disagreeable.

Proper Nervous Tension Is Important

—Aside from what is disagreeable and what is pleasant, our habitual mood may be lax and negative, or high-strung and spirited. If the nervous tension in which we hold ourselves is too low, we are too greatly influenced by our environment, take on too many conditions, and besides being too greatly influenced in thought and action, the stimuli thus received makes us weary. Under such circumstances our day's work becomes a great effort, and the last hours of it drag slowly. Too much negativeness, too much relaxation of the nervous system, makes small tasks appear large.

On the other hand, if the nervous tension is too high, if the mental reactions are too forceful, there is plenty of energy to start the day, but it is quickly consumed, leaving none for the balance of the day. A too positive attitude toward environment, too much enthusiasm exhibited, uses up the energy and leaves one nervously exhausted.

Somewhere between these two extremes is a mood suitable to each person. It can be learned only by experiment, watching the effect of different tensions. Instead of feeling listless, a person, unless he has decided to relax for rest, should at all times feel just enough tension in his nervous system to make him aware that he is putting conscious and volitional energy into what he is doing. Such physical and mental attitude actually increases his energy through generating electrical energies of proper

frequency by his nervous system. This is the energy that the yogi uses in his magical feats; but which may be generated by the simple means suggested in sufficient quantities to meet successfully the demands of daily life. The slight tension should be felt in every part of the body; but just how great or how little, must be learned by each person for himself.

I have now, at some length, discussed the general methods by which unpleasant thoughts, feelings and emotions may be made to give place to pleasant or constructive thoughts, feelings and emotions. First, a method was proposed by which it might be remembered on each occasion that unpleasant thoughts are not to be entertained under any circumstances. It was then shown how disagreeable thoughts may be put to flight by the use of pleasant thoughts and images. But as some disagreeable situations must receive attention, it was shown that these should be met in a different manner, by concentrating the attention on what should be done, rather than on that which is disagreeable.

For each type of thought, it is true, there is a specific thought antidote. And for each type of disagreeable event, there is also a specific thought treatment. These details are given in Course 9. But for the purpose of tuning in on the completely constructive life, the methods outlined in this lesson are adequate. It only remains, therefore, now that the relation of events to the individual as arousing constructive energies has been defined, to indicate the relation of each of these efforts to the whole.

Not only should all thoughts, feelings and emotions be pleasant, but every action should be considered in the manner in which it affects universal society. Each proposition that arises should be analyzed to see if, in the long run, it is beneficial to others. Every now and then the details of the everyday actions also should come under scrutiny to see if they are constructive in the larger sense. When the actions of the individual are directed to work that assists the Divine Plan of progression, and his thoughts, actions and feelings are habitually pleasant, he has entered into the completely constructive life.

Chapter 3

Serial No. 153
Original Copyright 1943
Elbert Benjamine

Copyright
August 2002
Church of Light

Diet and Breathing

**Edible portion of Foods in Which Alkali-Forming Elements Predominate.
Approximate Potential Alkalinity Reserve Per 100 Grams**

Olives	45	Chestnuts	7
Dried Lima Beans	42	Dried Peas	7
Spinach	27	Sweet Potatoes	6
Dried Beans	24	Dried Currants	6
Raisins.	24	Orange Juice	6
Chard	16	Tomatoes.	5
Almonds.	13	Lemons.	5
Parsnips	12	Cauliflower	5
Carrots.	11	Peaches.	5
Dates	11	Pears	4
Fresh Beets	10	Watermelon	4
Citron	9	Apples	4
Potatoes	8	Cabbage	4
Celery	8	Cow's Milk	3
Bananas	8	Radishes.	3
Rutabagas	8	Turnips.	3
Lettuce.	7	Onions.	1
Cantaloupe	7	Asparagus	1

**Edible Portion of Foods in Which Acid-Forming Elements Predominate.
Approximate Potential Acidity Per 100 Grams**

Oysters	30	Pike Fish	12
Egg Yolk	27	Egg.	11
Chicken Meat	17	Frog Meat	11
Venison	16	Average Fish.	10
Haddock Fish	16	Crackers	9
Rabbit	15	Rice	8
Veal	14	White Bread.	7
Lean Beef	14	Whole Wheat Bread . . .	7
Oatmeal	13	Dried Sweet Corn	6
Entire Wheat	12	Egg White.	5
Lean Pork	12	Peanuts	4

Chapter 3

Diet and Breathing



NO department of human life can be properly understood if it is considered solely from, the physical standpoint. Man is a two plane living organism, and all his functions and all the events which come into his life are the product of the interaction of both inner-plane and outer-plane factors. As his physical body is composed of physical cells and physical structures, so is his astral body composed of thought-cells and thought structures. The substances of his physical body have velocities which are low enough to give them material properties. The substances of his inner-plane body, whose organization is called the soul, or unconscious mind, have velocities greater than light. Such high velocities give them properties quite different from those encountered in physical things. Inner-plane energies do not contact or influence physical things, nor do physical things contact or influence inner-plane things, except through those boundary-line electromagnetic energies having velocities approximately that of light.

The thought-cell inner-plane body, whose organization is the soul, or character, affords the pattern which the physical body, in the process of growth before maturity, and in the replacement of tissues after maturity, at all times endeavors to fill in. And the physical body does thus follow the thought-cell pattern to the extent it has the physical materials with which to work, and has the facilities for manipulating them. The physical body which results is the product of the thought-cell activity and the facilities or remittances offered by the material environment, including food. Either a marked change in the diet, or a marked change in the thinking, shows before long in the countenance or general appearance. The change in diet gives the thought-cells different materials with which to replace tissues. The change in thinking gives activities to different groups of thought-cells, and these find it easier to handle some of the materials furnished in the food, and less easy to handle other materials, than they were handled before.

The birth chart maps the thought-cell pattern. and the measure of thought-cell activity of each of the ten types, and the organization of these thought-cells into structures, so that in the birth chart we have a diagram of the soul, or character, as it existed at birth. As revealed by their birth charts, with the possible exception of certain identical twins, no two persons are like. No two birth charts, with the exceptions mentioned, are the same. Therefore the inner-plane bodies which

correspond to the astrological positions in their makeup, are different. Furthermore, because the physical form is modeled by the astral, or thought-cell body, the same differences occur in the physical form. This means that the chemical composition of the body, to the extent physical elements are available, is mapped by the birth chart and progressed aspects. The physical bodies of people are of different composition. And this has been fully demonstrated in the laboratory of the biological chemist.

Now if the chemical composition of people is different, the chemical requirements of people likewise must be different. The same food, or chemical ingredients, added to one chemical constitution may produce exactly the opposite effect from that to be had by adding it to another chemical constitution. As has been handed down from ancient times, what is one man's food may very well be another man's poison. Nor is this merely a figure of speech. There are, for instance, in the neighborhood of 200 different things that are used by man as articles of diet, and there is not one in all this list that all persons can eat with impunity. Investigation by experts indicates that each one of these foods acts as a poison to certain persons, while acting beneficially to others.

Most people can eat strawberries, yet most of us know people who always break out with a rash after eating them. Others cannot eat boiled cabbage without suffering acutely from gas. And thus has it been found by wide investigation that every food known to man causes certain persons discomfort. In fact, nearly every person has such an idiosyncrasy in reference to some particular food. And aside from idiosyncrasies, some people have a low fat tolerance and other people have a high fat tolerance; which means that some people cannot assimilate fat and that other people can. Others have a low protein tolerance in contrast to those with a high protein tolerance. Still others handle sugar well in contrast to those who have little ability to burn sugar as fuel.

As the handling of food and other physiological functions, as well as the type of events attracted into the life, depend upon the activity of certain groups of thought-cells within the finer body, whenever one group of thought-cells becomes unusually active it influences how these foods perform within the body. Thought-cell activity is coincident with similar trains of thoughts passing through the unconscious mind. And these unconscious trains usually in some degree influence the trend of objective thinking. And both objective thinking and the release of planetary energies by progressed aspects give rise to unusual thought-cell activity.

This means not only that people differ basically as to their food requirements, but that during one period of their lives they need foods in different proportions than they do at other periods. It is a matter of common observation that foods which have been satisfactory for years often cause discomfort and ill health during a certain time, and that to keep the health certain food substances must during such a period be supplied in comparatively large amounts. The objective thinking and the thought-cell activity due to the release of planetary energy of a specific type through a progressed aspect to a given planet, tends to cause over secretion or under secretion of the hormones of corresponding endocrine glands. These hormones regulate all the processes and

functions of the body, including those of assimilation and metabolism. As a consequence, whatever the individual's average requirements may be of the food more readily influenced by a given planet, he needs more or less, as the case may be, of this particular food during the time a heavy progressed aspect to this planet releases its energy. He needs more or less then because the effectiveness of the unusual thought-cell activity to affect the body or affect events depends on the facilities or resistance to their influence provided by the environment. If the food elements are present in ample amounts for the tissues to use, it is far more difficult for thought-cell activity to deprive the tissues; or if the food elements are not present to promote some disease, it is more difficult by far for discordant thought-cell activity to manifest that disease.

From this it will be apparent that menus showing just what the normal man should eat, and how much of it, are only practical in so far as they indicate an average condition. Yet people are not average. They are different. Some are fat and some are lean, some are active and some are sluggish, some are emotional and some are placid, and so on through many pairs of opposites. Furthermore, they are not the same in chemical makeup and therefore in food requirements at different periods of their lives. Thus a diet to be most effective must be adapted to the individual's body chemistry as it exists at the time. And this body chemistry, as revealed by the birth chart, may be and often is basically different than the average, and at the specified time it may be temporarily quite different from its basic state due to thought-cell activity stimulated by a given progressed aspect.

But before we discuss the special diet needs, and why, of a person in whose birth chart a given planet is afflicted, or when the thought-cell activity it maps is given great impetus due to a progressed aspect, we need to know something of the functions of the different types of foods and the general dietetic requirements.

Man requires food for two purposes: to build or replace tissues and to furnish energy. Food is thus technically defined as that which, taken into the body, builds tissues or yields energy. And according to this definition air is a food. In fact, it is the one we can do the shortest time without. Also, according to this definition, foods may be classified into two broad groups, those chiefly used for tissue building and those chiefly used for energy production.

Proteins! such as those obtained from egg whites, curd of milk, lean meat, gluten of wheat, legumes, etc., are chiefly used to build or repair tissue. They are also used in the manufacture of the various enzymes which act as catalysts. And although expensive fuels, some are used for this purpose commonly, and when the other fuels are lacking the lean tissues of the body are thus employed.

Fats, such as that of meat, butter, olive oil, oils of corn and wheat, etc., are stored as fats and thus become part of the body tissue. But they are chiefly used as fuel reserves for the production of energy.

Carbohydrates, which embrace the various sugars and starches, are the most economic energy foods. They are stored in small amounts as glycogen, or animal starch, and are transformed into fat for more adequate storage.

Air affords oxygen for the tissues, but is more extensively used in energy production. Water is used in energy production, but is more extensively used in the structure of the body which is more than half water. The mineral salts share in forming bone and blood, in the processes of digestion, and in energy production; and the vitamins exercise vital control over tissue construction and the production of energy.

For our purposes, because discords in the birth chart and those induced by progressed aspects affect the foods ruled by each planet, a better classification is that of their planetary rulership, thus:

SUN: rules the life controlling vitamins.

MOON: rules the nutrient handling water.

MERCURY: rules the volatile and active air.

VENUS: rules the energy-yielding carbohydrates.

MARS: rules the muscle building proteins.

JUPITER: rules the opulent fats.

SATURN: rules the stabilizing salts.

Vitamins

—Vitamins are organic chemical compounds found in foods which taken into the body exercise a profound control over its metabolism. Although their presence is required only in minute quantities, health cannot be maintained when certain of them are absent or deficient. Not only is their presence necessary if the endocrine glands are to function properly, but they resemble the hormones secreted by the glands in that minute quantities exercise so profound a control over the body.

Not all of the vitamins need special consideration, as many of those less well known or postulated are commonly associated with the essential ones which are now generally recognized. Thus if one eats the foods containing the recognized essentials, there will not be lack of these others. At the time of this writing a dozen different vitamins have been chemically identified. The one which previously was called G is now called B-2. Vitamin B has been resolved into numerous distinct vitamins. B-1, B-2, B-6 and P-P have been identified and their functions studied. There are more than a dozen other vitamins in what was at first called B whose existence is postulated on physical evidence, but which at this writing have not been identified chemically. The whole of them, including the four identified, are embraced in the term B complex. Here is brief mention of the vitamins so far chemically identified:

Vitamins A-1 and A-2, chemical name, activated carotene. It is fat-soluble. Carotene exists in plants as a pigment. When this pigment is consumed by animals or man the liver converts it into active vitamin A, two forms of which, A-1 and A-2, have been isolated from fish livers. It is not yet known whether carotene can be converted into vitamin A other than in the liver. Carotene is present in yellow root vegetables, green leaf vegetables, and fruit. It may be present either as carotene or vitamin A in butter, milk, cheese, eggs and fish oils.

Its deficiency lowers resistance to infection and tends to prolong colds; encourages the skin to get dry and scaly and lose its sensitivity to touch, the improper formation and maintenance of enamel on the teeth, the inability to see in a dim light and adjust vision quickly after glare, the inability to nourish a fetus in the uterus, and the development of bladder stone.

Vitamin B-1, chemical name, thiamin. It is water soluble, and thus may be lost if the water in which foods are boiled is thrown away. Also it is destroyed by heat if exposed a sufficient length of time. 61 percent is thus destroyed in roast beef, and 55 percent in beef heart which is stewed one hour. It is present in high degree in cereal germs and yeast, and in lesser degree in most nuts, fruits, meats and vegetables.

Its deficiency tends to loss of appetite, to certain types of nervousness, to poor functioning of muscles of stomach and intestines, and to certain types of constipation. At the date this is written many foods are being fortified with vitamin B-1 for the purpose of increasing the morale of people in face of peril, or to increase stamina under conditions of strenuous work.

Vitamin B-2, chemical name, riboflavin. It is water soluble, and thus may be lost if the water in which foods are boiled is thrown away, but is not readily affected by heat. Its lack promotes nervous depression, digestive disturbance, loss of tissue tone, an unhealthy condition of the skin, and perhaps one form of cataract. Riboflavin is widely distributed in natural foodstuffs, one of the best sources being milk, or bread which has been enriched by the use of milk or milk powder. Vitamin B-2 was at one time called Vitamin G.

Vitamin B-6, chemical name, pyridoxine. Little is as yet known of its physiological function.

Vitamin P-P, chemical name, nicotinic acid. This is another member of the B complex, and should not be confused, because of similarity of name, with the nicotine contained in tobacco. It is present in many meats, in yeast and in wheat germs. Its absence gives rise to pellagra. It is used as a specific treatment for the lesions of pellagra.

Vitamin C, chemical name, ascorbic acid. It is water soluble and the juices of fruits and green vegetables are good sources. The citrus fruits are especially rich in it.

Its deficiency tends to prevent the proper formation and maintenance of teeth. tends toward bleeding of the mouth and gums, and toward making the capillaries fragile so that they bleed. If the deficiency is long continued, pains may develop around the joints, the food does not oxidize properly in the tissues, and scurvy develops. There is recent evidence that one of the two types of pyorrhea may be due to vitamin C deficiency.

Vitamin D-2, chemical name, calciferol.

Vitamin D-3, chemical name, 7-dehydro-cholesterol. There is no D-1, because that which was originally thus designated has been found to be a compound of more than one sterol. The irradiated 7-dehydro-cholesterol is the form in which it is found in cod liver oil and halibut liver oil and in the human skin. The irradiated calciferol is the form present in viosterols. The human skin contains vitamin D in the inactive, or pro-vitamin form, which when exposed to certain ultraviolet rays of sunlight become the active vitamin D, which is then absorbed and utilized by the body. Other than exposing the skin to sunlight, the fish liver oils, irradiated milk, and fortified cereals and bread are good sources of vitamin D.

Its deficiency prevents the proper use of the lime and phosphorus of the food, tends to affect the bones and teeth detrimentally, to promote faulty heart rhythm, to prevent proper clotting of the blood, and to prevent the proper transmission of nerve impulses to the muscles. In babies its lack gives rise to the faulty bone construction known as rickets.

Filtrate Factor, chemical name, pantothenic acid. Its lack causes dermatitis in chicks. Little is known of its action on the human body.

Vitamin E, chemical name, tocopherol. It is fat soluble, but its activity is rapidly destroyed when the fat or oil containing it becomes rancid. Its lack in the mature female leads to failure of the placental function and reabsorption of the fetus; in the adult male its lack may lead to complete sterility. It is found widely distributed in foods-which have not been artificially refined, in grains, vegetables, meat, milk and butter. As wheat germ contains it abundantly, whole wheat bread is a good source. Because this vitamin is so widely distributed among foods, it is seldom markedly deficient.

Vitamin K, chemical name, 1, 4 naphthoquinones. This vitamin occurs in several forms. The natural forms are fat-soluble and heat resisting. They are abundant in plants which show active photosynthesis, such as alfalfa, spinach, kale, dried carrot tops, oat sprouts and tomatoes. Their presence promotes the clotting of blood and helps prevent too profuse bleeding.

Vitamin P, chemical name, eriodictyol. It is present in fruit juices, and is believed to have an influence over the permeability of the capillaries.

Water

—Not only does water form considerably more than half of the bulk of all so-called solid organs of the body, but the tissues require to be bathed in a solution about that of sea water. Common salt (sodium chloride), therefore, is very important in human economy. If, for instance, the body takes on too great a supply of water without the addition of a proportionate amount of salt, the cells become flabby. In fact, without salt they cannot retain water, and would ultimately burst. Too much water dilutes the chemicals of nutrition. Excessive perspiration carries much salt out of the body, and if fresh water only is taken to replace the loss, the salt content of the body becomes too low. This leads to water poisoning.

A great deal of nonsense is afloat both about the amount of water people should drink, and as to the injurious effect of using salt on foods. It is taught that to drink much water is the sure road to health, and that table salt is always detrimental.

As a matter of fact, both the water needed and the salt needed depend upon the individual requirements. The thyroid gland reacts to the thought-cell activity mapped by the Sun. The back pituitary gland reacts to the thought-cell activity mapped by the Moon. When either set of these thought-cells becomes more active due to a progressed aspect to Sun or Moon the water requirements change. A person who has an active thyroid (Sun) loses water rapidly, and needs more water than a person who has a sluggish thyroid and tends to retain the water he drinks. But the person who has an active back pituitary (Moon) retains water tenaciously, and consequently, needs less water than the person who has a sluggish back pituitary.

Air

—Man can live weeks without food and days without water, but deprived of air for about five minutes he becomes unconscious. In such a case the heart goes on beating for hours, and the other vital processes continue, indicating that the brain is more dependent upon oxygen than any other organ of the body. Thus in drowning or asphyxiation the person may be resuscitated after being hours without air supply, but during all but a few minutes of the time the brain refuses to function.

By means of breathing we take into the blood, through the lungs, the oxygen that combines with the food to develop all the energy used in the human body. There are many kinds of food, some of which may be substituted for others, but they are all supplied to the tissues by the blood, and all must combine with oxygen to produce energy. And while the brain suffers most quickly from insufficient oxygenation, all organs of the body require oxygen, and the immediate cause of death in most cases is due to an insufficient supply of oxygen reaching the vital organs and enabling them to perform their functions.

The human body is quite an efficient combustion engine. Food is the fuel used with which to stoke this engine. Thus a pound of sugar burned in our body yields as much heat as if it had been burned in a chemical oven. But sugar will not burn in an oven, nor will coal burn in a furnace, nor gas in a range, unless sufficient oxygen is supplied to it for combustion.

We may eat ever so much, but unless we breathe sufficiently to afford oxygen for the combustion of this food that becomes stored in our tissues, it fails to afford us energy. Our physical and electromagnetic energy comes from the union of oxygen with this stored food. Excess of food beyond the oxygen supply to combine with it leads to sluggishness and inertia. In order to get an adequate oxygen supply, therefore, it is essential that the lungs perform their duty fully. Deep breathing, because it disposes of the product of combustion and affords oxygen for further combustion, tends to dissipate fatigue and supply energy.

The physical energy generated by the combustion

of oxygen with fuel is measured in terms of calories. The energy it takes to raise one kilogram (about two pints) of water from 0 degree to 1 degree C. is a calorie. Just to keep alive requires 1,700 calories a day. It takes 170 calories to digest a meal. Reading one hour consumes 5 calories. A 10 mile walk consumes 600 calories. One hour at a desk (being consumed in the work of muscles holding the body in position) requires about 21 calories. Yet it is found with the body so relaxed as to place no extra work on the muscles, but with the brain intensely active, that so little extra heat energy is consumed that it cannot be detected with a calorimeter.

The energy used in brain work (Mercury), that is, the real vitality of the body (Sun), and that may be diverted into any one of five other frequency systems—mediumistic (Moon), affectional (Venus), inspirational (Uranus), hypersensitivity (Neptune), and inner-plane (Pluto)—is electrical in nature.

The physical cells are composed of protoplasm, just as the substance of the inner-plane body is thought-organized psychoplasm. And each of these cells has a nucleus of protein, which is comparatively acid. Surrounding this nucleus is the cytoplasm, which is comparatively alkaline. Separating the acid nucleus and the alkaline cytoplasm of the cell is a semi-permeable membrane. Electrolytes are thus formed of the humors of the body in such a manner as to make of each cell a miniature electric battery. And material science now holds that the oxidation of the nitrogen fraction of these cells releases the electrical energies which runs the body and makes brain work possible.

The vital system embraces those phases of electrical activity which vitalize the physical cells and organs and express physical activity. The wavelengths of the electromagnetic energies radiated by this Sun type of activity are of lower frequency than those of the cerebral, the inspirational, the hypersensitive, or the inner-plane system. The potential of electricity used, however, is high, although not so high as that used in the inspirational system.

Many people who generate plenty of electrical energy never have vitality enough to maintain health or to do the things otherwise they would be able to do, because they have formed the habit of diverting so much of the total electricity generated into one or more of the other systems of activity. Too much is used up in sex, or in cerebral activity which accomplishes nothing, or in feeling things distressingly through the hypersensitivity system, in negative states which are partly mediumistic. If they would learn to direct their electrical energy in greater measure into the vital system, where it works to repair the cells, takes care of the organs, and directs the physical functions, they would have abundant vitality and longer lives.

It is attention which throws the switch from one electrical system to another, and it is mood which determines the frequency of the electromagnetic radiations. Both the mood and the subject of attention are powerfully influenced by thought-cell activity. Thus do people with different birth charts differ in mood and their mental interests. And the same person is influenced in his intellectual interests and the amount of cerebral activity by progressed aspects of Mercury, and his mood tends to change to a type corresponding to the planet which at the time receives the heaviest progressed aspect.

For vitality, when weary or exhausted, hold the mood of indrawing vitality while breathing rhythmically. Some people successfully turn the switch to the vital system and forget their other activities and problems in a game of golf, or in a stiff hike through the woods. The attention of the unconscious mind as well as that of the objective mind is taken from other forms of activity and directed largely to animal activities. The energies are thus diverted into channels which strengthen and vitalize the physical body and its functions.

Carbohydrates

—The carbohydrates are the starches and sugars. The starches become sugars in the process of digestion. The carbohydrates are the most economical energy foods, but they are not all handled in the human body with the same facility. Starch is the form in which plants store the largest part of their carbohydrate material. It represents from one-half to three-fourths of the solid matter of the common cereal grains, and at least three-fourths of the solid matter of mature potatoes. Unripe apples and bananas contain much starch which is converted largely into sugar as they ripen, and young corn and peas contain sugar which is converted largely into starch as they ripen.

Starch is a polysaccharide, and some sugars are disaccharides, and in the process of digestion these must be converted into glucose which is a monosaccharide. Glucose, or blood sugar, is the form in which the carbohydrates commonly are carried in the blood stream. Fructose, which is contained in the juices of many plants and fruits and in honey, and galactose which is produced in the digestion of milk, are other monosaccharides which are readily converted into glucose. Also they are handled to

some extent in the blood stream after the manner of glucose. And glucose itself is widely distributed, being abundantly present in plant and fruit juices, usually in association with fructose and sucrose. It may constitute 20% by weight of grapes; and unripe potatoes, onions and sweet corn are rich in it.

Mention of chemical technicalities would be unpardonable in a work of this kind were it not so important to point out that sucrose, commonly called cane sugar, which is obtained commercially from sugar beets, sorghum canes, sugar maple, the sugar palm and sugar cane is a disaccharide which neither the saliva or gastric juice is capable of converting into glucose. Sucrose to be handled must be acted upon by the hydrochloric acid of the stomach, or split by the sucrose of the intestinal juice into glucose and fructose which are then readily absorbed into the blood.

People with a prominent Venus crave sweets. But they may not be able completely to digest cane sugar and some forms of starch if Venus is also afflicted.

Furthermore, if Jupiter is prominent and afflicted, too much of the sweets, and particularly those made from cane sugar, may lead to an impure blood stream and blemishes, such as pimples, which mar the complexion, or to the development of diabetes. This because of inadequate insulin supply to handle the great demands made upon it.

In the process of digestion both the starches and sugars must be converted into monosaccharides so -the blood stream can handle them. These monosaccharides are all soluble, crystallizable, diffusible substances not acted upon by the digestive enzymes. They thus quickly find their way into the blood to be burned for fuel or stored.- As they are soluble, if left in this state they would be washed out of the body in the urine. Instead they are converted into a form of animal starch called glycogen, which is colloidal and not soluble. Thus the sugar in the blood remains constant at about 1 part in 1000 and the glycogen formed from some of the excess is stored in small amounts in the muscles and other active tissues, and specifically in the liver, which is the emergency fuel bin of the body. Yet as the amount of glycogen the body can thus store for emergency use is limited, the sugar of the blood also combines with fatty acids to produce fat which enters into tissue formation as a reserve fuel supply.

Proteins

—For years a vigorous controversy has raged among the dietetic experts as to the amount of protein that should be consumed. The Battle Creek health experts show that for tissue repair there is required about 1.3 calories of protein per pound of body weight per day. Thus a man of 150 pounds should eat 200 calories, or about 1 ½ ounces of protein per day. And they hold he should eat little more than this because protein, unlike the carbohydrates which are stored as fat, are not stored, but that any excess must be eliminated. Eliminating such excesses overworks the kidneys and liver and clogs the tissues.

They believe that the system should get from some source an adequate amount, and little more, of protein. If 1 ½ ounces of protein is all that is required each day for a man of 150 pounds it may be obtained from any of the following: 9 ½ oz. walnuts, 8 ½ oz. almonds, 4 ½ oz. soy beans, 7 oz. peanuts, 8 oz. beans or peas, 3 ½ pints of milk, or an 8 oz. porterhouse steak. In one way at least, the vegetable and dairy proteins are superior to those derived from meat. Meat proteins are accompanied by putrefactive bacteria which in time tend to injure the colon. On the other hand some people who handle the meat proteins readily have digestive systems that find trouble in handling beans, peas, nuts and peanuts and some are even allergic to milk.

At the opposite extreme of the protein controversy are the dietetic standards of the U.S. Department of Agriculture. They hold that the optimum of protein intake for a man is about 3 ½ ounces per day. The man they consider may be larger, and they specify that he is in full vigor and engaged in moderate muscular work. They estimate that of the food consumed about 95% is digested, and that such a man should develop 3,200 calories. A man leading a sedentary life uses some 2,500 calories, mostly derived from fats and carbohydrates. At hard work he burns about 4,000 calories, and at excessively hard labor, such as a stevedore sometimes performs, he may use 7,000 calories per day, and in all day racing contests possibly 10,000 calories or more.

Based on the high protein intake advocated by the U.S. Department of Agriculture, a man doing light work requiring a little less than 2,800 calories needs 3 ½ oz. proteins, yielding 406 calories, 3 ½ oz. fats, yielding 920 calories, and 12 ½ oz. carbohydrates, yielding 1,140 calories. However, this takes no account of individual differences in ability to use protein not merely for tissue building, but also as a fuel which stimulates the burning of fat and sugar at a higher rate than when protein is not present.

People vary in marked degree in the amount of stimulation which is thus caused by the protein foods. The proteins themselves are ruled by Mars, but those with strong thyroid and front pituitary glands (Sun) increase their ability to burn sugar and fat conspicuously after eating proteins. Those with weak thyroid and front pituitary secretions show almost no increase in the ability to handle the other fuels as a result of protein stimulation.

Certain people remain thin, even when unemployed, no matter how much they eat, because the added protein stimulates them to greater burning of sugar and fat. The stimulating effect of protein in the diet ordinarily raises the fuel consumption three times a day by twenty to forty percent above normal. But in these constitutionally thin people, Plaut found, by his experiments, that the fuel consumption thus increased from forty-eight to sixty-three percent. That is, the increase in the combustion of fuel due to protein stimulation was from one-hundred to two-hundred percent above that of the average person.

On the other hand, the people who remain fat, even when doing the hardest physical work, do not react to the proteins by extra burning of fuel. The proteins do not have any pronounced stimulating effect upon them.

Fats

—Fat from a calorie point of view is the most economical food, one pound being the equivalent in fuel value of 2 1/2 pounds either of the proteins or the carbohydrates. But fat, when eaten, must be subjected to a treatment in the process of digestion which splits it up into fatty acids and glycerol, even though these shortly recombine into neutral fat which is carried by the blood in tiny particles to the tissues. Some digestive systems, such as those of the Eskimos, are able to digest large quantities of fat; and others, such as some of the lean people we know, are unable to assimilate fat in any quantity, while still others find even a little extra fat in the food overworks their digestive powers. Nevertheless, in one pat of butter there is energy enough that if used will enable a man to walk more than a mile. And this one pat of butter a day, in excess of what a man actually burns, if assimilated as it commonly is in those people with a tendency to become fat, in the course of some years will double his weight.

Now to burn sugar in the body requires a relatively small amount of oxygen. That is, it will burn in a small draft. But fat requires more oxygen, and is slow burning. It is a reserve fuel, and only burns when there is sufficient sugar present to burn with it. The sugar acts like kindling, and the fat burns as long as there is adequate sugar, yet when the sugar gets low the fat does not burn completely, but just smolders. Diacetic and other fatty acids thus incompletely burned are added to the blood stream, and these narcotic and poisonous fatty acids accumulate throughout the body, producing ketosis, which is one form of acidosis.

Ketosis is not brought on through lack of minerals, although in this instance as well as in the mineral-poor acidosis, the acid-alkali balance of the system is upset. It is due to a diet too high in fat in relation to sugar, or to inability to burn enough sugar effectively to take care of the fat combustion.

This condition is promoted by the thought-cell activity mapped by an afflicted Jupiter, which encourages the use of too much of certain rich foods in proportion to the basic body chemistry. This state of affairs, often observed in overly-fat people, causes them to be chronically tired even when doing nothing. In fact, they often feel greater fatigue when they do nothing than when they work hard, because the exercise brings about better combustion and helps to remove the excess acids through better elimination.

Mineral Salts

—Saturn is the planet of work, and it is appropriate that the mineral salts, or their lack, play a most important part in fatigue. When a muscle is stimulated by a nerve (electric) current, lactic acid is liberated from the muscle, changing the hydrogen ion concentration in the cell of the muscle, and thus shortening the muscle, the glycogen (sugar stored as animal starch) of the muscle being called upon to supply the energy through combustion. Some of the lactic acid also is oxidized, the balance returning to the compound from which liberated.

Tissue metabolism adds other acids to the blood stream, and when it becomes filled with lactic acids and other toxins the symptoms of fatigue appear. Thus a sprinter, running at his best, produces nearly half a pint of lactic acid a minute. He therefore quickly becomes very tired, and remains so until the lactic acid that fills his blood stream becomes neutralized. Then whatever alkalis are in his blood, or enter his blood through eating alkaline producing foods, combine with the lactic acids and other acid toxins and burn them up. As the blood becomes free of these toxins he begins to feel refreshed and ready for further effort.

It is easy to confuse strength and endurance. Strength is due to the size and quality of the muscles. A small man may be unable to move a weight that a large man can lift easily; but in spite of this the small man may be able to work longer at some work within his strength without feeling fatigue than the large man. Endurance is ability to continue with some activity over a long period of time. It is not dependent upon the size of the muscle, but upon the purity of the blood stream.

Irrespective of the size of the muscle, its use liberates lactic acid into the blood, this produces the effect known as fatigue, and when the blood becomes too filled with lactic acid the muscle refuses to respond to stimuli, its power being exhausted.

If the blood stream carries a reserve of alkaline elements, some of the lactic acid combines with these and is burnt up and the person is not so readily fatigued as if his blood stream had not carried this alkaline reserve. Certain foods, notably fruits and vegetables, are rich in alkaline elements, and give the blood stream just such an alkaline reserve as has been mentioned. And in carefully conducted endurance tests in which nurses at Battle Creek who had been living on a diet designed to give an alkaline reserve, were brought into competition with Yale athletes, these athletes made an average of only 11 minutes, while the nurses made an average of 90 minutes.

If, as this indicates, we are to work strenuously without becoming tired, we must have a pure blood stream, and one that is slightly alkaline. Yet if a man eats too much acid forming starches in proportion to the alkaline forming foods, his blood has no power to neutralize the toxic acids it receives, and he remains tired even when at rest. He remains tired even though doing no work other than keep alive. Or, if for some reason, he fails to eliminate from his system the products of biologic activity, he continues tired, even though he does nothing but rest, because his blood contains the

materials which cause fatigue. In fact, it may refresh him greatly if he gets to work at some violent exercise, provided this exercise causes him to perspire and eliminate waste products more rapidly.

White bread, meat, potatoes and coffee when not balanced with fruits and vegetables, form a diet likely to develop the complaint known as acidosis. White rice, corn meal and white sugar also lead in this direction; for in processing not only are the vitamins removed, but the mineral salts which in small amounts enter into the composition of healthy tissue and contribute to the alkalinity of the blood stream.

While various mineral salts must be present in the food for vigorous health, this matter of acid-alkali balance is of tremendous importance to every person. The accompanying table will indicate which foods; and to what degree, contribute acid or alkali to the blood stream.

Yet it is apt to be confusing to those unfamiliar with organic chemistry to be told that the starches produce an acid reaction in the human system and that fruit juices produce an alkaline reaction. He is aware that white bread and white sugar do not taste like acid, but that fruit juices are pronouncedly so to the taste. The mystery lies in the chemical process which takes place after the food enters the body. As the flesh of animals normally contains the by-products of combustion in rather high degree, these toxic acids are naturally taken into the human system when these animals are used for food. Meat, therefore, ranks rather high in acid forming properties. White bread, white sugar, polished rice, coffee and white corn meal also rank high in acid forming properties, because acid is formed from them in the process of digestion.

Acids, however, are of two kinds; those that quickly combine with oxygen in the body and are thus burnt up, and others that do not thus combine with oxygen readily but continue in the human body as acids. Of the latter type are the inorganic acids: hydrochloric, phosphoric and sulfuric, and certain organic acids such as butyric, oxalic, benzoic and acetic. Those acids found in fruits, with the exception, of prunes, plums and cranberries, such as citric and malic, not only oxidize quickly in the human system, but they are combined with organic soda and potash, which are alkalis. When fruits are eaten, consequently, unless in too great quantity for the oxidization of their acids, their acids are quickly burnt up through combination with oxygen, leaving in the blood stream the alkalis with which they are associated as a reserve for combining with lactic and other toxins that lower resistance to infection and cause fatigue.

To those who get tired between meals because the fuel supply taken at regular meals is not sufficiently assimilated to last in full vigor through the interval, fruit juices are a great boon. In the first place these juices—apple, grape, orange, grapefruit, lemon, pineapple—contain the mineral salts in high degree, as well as vitamin C. They furthermore add alkaline reacting elements to the blood. And finally, they place no strain upon the digestive powers of the stomach, but enter at once into the blood stream and give it a valuable and immediate fuel supply. A glass of fruit juice contains immediately available energy to tide one over until the next regular meal;

and acid juices, such as lemon, orange, grapefruit and pineapple, because of their effect upon the digestion of other foods, should be taken thus between meals, or not less than half an hour before mealtime.

Chapter 4

Serial No. 154
Original Copyright 1944
Elbert Benjamine

Copyright
August 2002
Church of Light

How to Keep Young

Chapter 4

How To Keep Young



As every condition and event affecting physical life is due to the interaction of inner plane thought-cell activity with the physical environment, it is apparent that in maintaining youth both of these factors should receive adequate attention. Youth, of course, pertains not merely to the body, but equally to the intellect and the emotions. While it does not necessarily follow that one who well retains his youth will live to great age, it does seem reasonable to assume that those who do live long lives have within themselves qualities which are advantageous in retaining youth. And it so happens that even though no comprehensive astrological research as yet has been attempted relative to those who remarkably retain their youth, such research has been conducted relative to 80 men and 70 women each of whom lived more than seventy years.

The analysis of the charts of these 150 individuals, and the conclusions reached, constitute Chapter Four of the book, *BODY DISEASE AND ITS STELLAR TREATMENT*¹. This analysis reveals that Mars thought-cells in any association with Sun thought-cells, Mars thought-cells in any association with Moon thought-cells, Jupiter thought-cells in harmonious association with either Sun thought-cells or Moon thought-cells, active Sun thought-cells or active Moon thought-cells, each and all are conducive to length of life.

This in turn signifies that deliberately cultivating the aggressive type of thinking in association with thoughts of significance or thoughts of domestic life, cultivating an attitude of faith and good cheer relative to thoughts and events affecting the significance of domestic life, and cultivating thoughts of significance and thoughts about the domestic life will aid in lengthening any person's life. And because such thinking thus cultivated does lengthen the life, and has no age producing proclivities, we may be sure that the cultivation of such thinking, together with other thinking which is typical of youth, will greatly assist any individual to keep young.

1 Temporarily Out of Print

Any amount or any type of thinking alone, however, will not keep a person young; for what the thoughts can accomplish depends upon the amount of resistance encountered in the physical environment. Youth is not merely a particular desirable state of mind and feeling, but is also a particular and desirable state of the body. Body and mind have outgrown childish incompetence, they are prepared for the joys and responsibilities of maturity, but they have not yet acquired the physical disabilities, the dulling of interests, and the lack of emotional response of old age. Youth is not signified by years. Instead, it is represented by that period of life during which, apart from years and birthdays, maximum efficiency is present. And not only because of the opportunities for personal development, but also because of the possibilities in aiding the cosmic work, it is a period which should greatly be prolonged.

And it can be greatly prolonged through proper selection of foods and other physical environmental factors, and through the cultivation of properly selected thoughts and emotions. What is sought in making such selections is to keep the body active, supple and resilient, the mind keen, enthusiastic and forward looking, and the emotions strong, sensitive and harmonious. Regardless of years, any person having such a body, mind and habitual emotions is young.

Foods For Keeping Young

—It was pointed out in B. of L. lesson No. 153 (See Serial Lesson Key), that as the chemical composition of people is different, their chemical requirements in the way of foods also differ. And the chart of birth with the progressed aspects at the time, together with physical observations, indicate the foods of which a given individual at a certain time has special need. These foods, because they assist in maintaining health and vigor, also aid in keeping young. But as important as special foods are to individuals with a definite thought-cell, and therefore chemical makeup, it may be pointed out that in spite of any foods provided them all plants and animals higher in the biological scale than single celled organisms finally grow old because they cannot get rid of the products of combustion. The ashes from the fires of life gradually accumulate and clog the organic engine. Even the arteries of the human machine become impregnated with such impurities, harden and fail properly to perform their functions. No longer getting their accustomed nourishment from the blood stream, the tissues necessarily shrink from lack of food, and the skin that covers them, no longer held in place by vigorous flesh, wrinkles to adjust itself to a smaller area. It is thus obvious that proper elimination is one key to physical fitness and is an essential aid to keeping young.

As youth implies a vigorous physical body let us consider the relation of fuel to fatigue:

According to the Nutrition Laboratory of the Carnegie Institution the net efficiency of the human muscular system in relation to the fuel burned is slightly more than 21%. Steam engines have a net efficiency of from 15% to 25%. In a muscle is fuel brought by the blood and stored as glycogen, or animal starch. When the muscle is used this fuel is consumed, and after it is used up the muscle uses the sugar in the blood to continue its work. If the work is excessive, such as to call out the so-called second wind of the athlete, the adrenal glands secrete adrenaline into the blood, and this not only tends to neutralize the various toxins formed by fatigue, but causes the liver, which is the emergency fuel bin of the body, to release its glycogen into the blood stream as simple sugar. The adrenaline also speeds up the circulation so that the toxic acids formed by muscular activity are more rapidly carried away from the muscle, and the muscle is more quickly supplied with the simple sugar now in the blood for fuel.

When a muscle is used until the lactic acid and other toxins it contains are excessive it will no longer work and is said to be too tired. A little rest, however, enables the blood stream to carry away these fatigue products and supply the muscle with new fuel, and it is again ready for work. If overworked, a muscle may recover very slowly, but a muscle is rarely damaged permanently through over exercise, as repairs are readily made. But a muscle may be, and often is, permanently damaged through lack of exercise. When not exercised the waste products are not carried from the muscles properly, and the circulation being deficient it does not receive sufficient nutrition from the blood stream. Consequently the muscle weakens, grows flabby and subject to disease, and may even atrophy and become incapable of use. To prevent such conditions violent exercise is not necessary, but some sensible exercise is. Such exercise as is afforded by outdoor games or indoor setting up exercises increases the circulation, toning up the muscles and strengthening the internal organs. Keeping the muscles supple and well nourished is a valuable physical measure for prolonging the period of youth.

This necessary nourishment is not obtained, however, unless the chemical elements and vitamins that go to make up the human body are supplied in the food. The human body contains no alchemical laboratory for transmuting carbon into silicon or sulfur into potassium. Not only each of the sixteen chief elements that go to make up the physical constitution, but various other chemicals and compounds in less amounts must enter the body as a part of the food we eat. If we get no iodine, for instance, there is trouble with the thyroid gland, and goiter develops.

Iodine is abundant in sea foods, and those eating such foods do not have goiter. But whole sections of the world that are removed from sea foods and other means of getting iodine foods are now recognized as goiter areas in which this trouble is prevalent.

In addition to vitamins and small amounts of elements other than these sixteen, such as copper and nickel, the human body is made up of and requires for its maintenance, oxygen, carbon, sodium, sulfur, silicon, hydrogen, potassium, phosphorus, iron, fluorine, nitrogen, calcium, magnesium, chlorine, manganese and iodine. While a list of the foods containing each of these elements may easily be compiled, it would serve no practical purpose as many of the elements are common to the ordinary diet. Instead, we need to know the foods that are needed to keep the blood stream slightly alkaline and thus avoid easy fatigue and acidosis. These are given in a table in B. of L. Lesson No. 153 (See Serial Lesson Key). And we need to know what vitamins and what other foods are specially needed by a given individual most of the time, and what vitamins and what other foods are specially needed by most people at specific times in their lives. These special food requirements are explained in B. of L lessons No. 222, No. 223, No. 224 and No. 225 (See Serial Lesson Key).

In these lessons is indicated why an individual with a certain planet prominent and afflicted tends, because of the strain on certain endocrine glands, to need certain vitamins and elements, and what foods to eat to get them. And in them is indicated why an individual at the period of his life when a progressed affliction forms to a given planet needs—because of the tendency of the aspect to stimulate or depress the action of certain endocrine glands and thus disturb the chemical balance of the blood stream—more than the normal amount of certain vitamins and certain elements, and in what foods these vitamins and elements may be found. These lessons also indicate those who should refrain from eating certain foods, and the periods during which other people who usually can eat these foods with impunity, should refrain from eating them.

The information thus revealed by the birth chart and progressed aspects is of vast benefit not only to those who wish to keep young, but also to those who wish to keep in good health. But the foods which are the special requirements of a given individual, and those of which he will have special need at definite periods in his life, can be ascertained properly only by one conversant with astrology. To those who have no access to this vastly important information it may be pointed out that the selectivity of the nutritive system is highly specialized. In general, if we need certain vitamins and elements and eat foods containing them, unless we are very ill, these vitamins and elements will be extracted and proper use made of them. If, therefore, instead of confining our diet to a few staples, we vary our diet so that we eat at different times many kinds of food, we may be reasonably sure not only that such variety will afford the necessary vitamins and elements, but that these will be assimilated and properly used. Yet even when thus assimilated these afford energy only when brought in contact with oxygen. Therefore, as pointed out in detail in B. of L. lesson No. 153 (See Serial Lesson Key), proper breathing is necessary for health; and it is also necessary to retain youthfulness.

Food Combinations

—The foods that may beneficially be eaten at one meal are also worthy of some thought. As individuals vary in their reactions to foods, general rules are misleading, and one should rely more upon observation and experience. Nevertheless, acid fruits do not combine well with either starches or meat when eaten at the same meal. Bread and meat when eaten together with no vegetables make a poor meal because both are acid producing. They need the alkaline producing vegetables to balance them. Several different kinds of starches eaten at one meal, due to their different reactions to digestion, tend to cause fermentation. If potatoes are eaten, for example, it is better not to eat rice or bread. If rice is eaten, it is better to eat no bread or potatoes. Such starchy combinations, however, seem to be well handled by a strong active stomach.

At times there arises the custom of using bran bread and bran in the form of cereal. Its use has two results of some importance. It dilutes the food with roughage that both enables the stomach to handle the other food better and through its bulk discourages the eating of too great a quantity of rich and nourishing foods. And through its irritating effect upon the lining of the intestines it increases their peristaltic movement and thus acts in the capacity of a laxative.

Bran, however, has no food value to the human system. It is chiefly cellulose. Horses and cows have an extra stomach in which cellulose is broken down preparatory to digestion and assimilation. But man has no such organ, and its effect when taken into the human system is almost entirely mechanical. Irritating the walls of the intestines stimulates their activity. Too much irritation leads to inflammation. Some people can eat bran and bread made from the flour of the whole grain of wheat not too finely ground in a hand mill. The lining of the alimentary tract of other people is so sensitive that the eating of bran bread, or such whole wheat bread from which the bran has not been removed, leads to very serious intestinal inflammation. A better laxative for most people, although the seeds increase peristaltic action also through mechanical irritation, are figs either fresh or dried. They may be eaten just before retiring at night when constipation is severe. In addition to their laxative properties they are high in food value, being unusually alkaline in reaction.

Now in addition to eating the proper foods in the proper combinations there are at least two important occult principles that may be utilized to extract a greater amount of energy from them. One has to do with the pleasure in eating, the other with extracting the electromagnetic energy from the foods.

Pleasure in Eating

—Pleasure, other things being equal, is constructive. The attention of the physical cells, the nerves and the organs are directed harmoniously to that which is pleasant. If no pleasure is experienced in eating, the attention of the unconscious mind and the attention of the cells and nerves are not directed to the food. And if at the same time, through the consciousness being directed to some problem or painful thought, the attention of the cells and nerves is directed to some other interest, it is as unlikely they will perform their work well as it is that a workman in a factory will perform his work effectively if his mind is preoccupied with a baseball game or with discords that have arisen in his domestic life.

Worry, anxiety, anger or other emotions that are allied to emergency attitudes of the mind release adrenaline into the blood stream. This chemical withdraws the electrical energy and the blood from the organs of digestion and assimilation, leaving there not enough for the proper handling of the food. Other painful thoughts, through endocrine secretions, tend also to prevent the proper chemical conditions that enable the food to be handled effectively. And even if the mind is merely occupied with other matters, or if eating is looked upon merely as a necessary and perhaps annoying duty, full value will not be extracted from the food. To get the most nutriment from the food, and to insure its proper digestion, only the most pleasant things should be thought of while dining, and the attention should be directed repeatedly to the fine flavor and other attractive qualities of the food. Such an attitude will stimulate the cells of the alimentary tract to keen expectancy, and they will be alert to do their work in the most effective manner.

If such habits have been formed that the stomach and bowels do not perform their functions properly, it is well to use the law of suggestion to advise them just what is expected and just what they should do.

Remember, these involuntary functions are all under direction of the unconscious mind, or soul. Through negligence, or because of improper treatment, they may become lax in their duties. But if, before each meal, they are talked to in a firm manner and told precisely what work is expected of them, they will respond, take the orders, and again become excellent workers. Talk to them just as you would talk to a person employed by you. Let them work out the details, as you would a competent workman. But make it very clear, in each instance, exactly the result you expect. If the orders are given clearly and firmly they will not disappoint you.

Extracting Electromagnetic Energy From Foods

—The life principle of organic things is electromagnetic in nature. And if it is recognized that the foods contain such energies, and an effort is made to utilize them, this life principle which is so essential to keeping young and vigorous may be extracted from them in far greater measure than is customary. This may be done by taking a few minutes about an hour after each meal to center the attention on the body and to visualize the electromagnetic energy being extracted from the foods and sent along the nerves to the various portions of the body, at the same time tensing the muscles slightly.

A quick relief from fatigue may be had by several times a day standing before an open window, breathing deeply while the mind is focused on extracting the electromagnetic energy from the surrounding space, clenching the fists, flexing the arms, and alternately bending the legs at the knees. Then stand for a few minutes before going back to work and visualize the electromagnetic energy being extracted from the food.

The cells of the body are miniature batteries and, as explained in B. of L. lesson No. 153 (See Serial Lesson Key), the oxidation of the nitrogen fraction of these cells releases the electrical energies which run the body and make brain work possible. But in addition to the normal generation of electrical energies in this manner, it is possible through the process just described, or through other methods of tuning in on them, to utilize the principle of resonance to acquire additional electromagnetic energy from foods, from the surrounding space, and from living vegetation. In the method here described, after the exercises, stand for a few minutes before going back to work and visualize the electromagnetic energy being extracted from the food. This keeps tuned in on its wavelengths. The physical exercise squeezes the impure blood into the larger veins which carry it to the lungs. The deep breathing furnishes oxygen for generating electrical energies and for eliminating impurities. And the mental attitude, through proper tuning, not only enables the electromagnetic energy to be extracted from the foods, but distributes it to all parts of the body.

Sunlight

—The importance of the vitamins has already been stressed. The plants which manufacture most of these feed only in the presence of sunlight, the ultra-violet rays of which act on the plant chlorophyll. Sunlight, including these ultra-violet rays, is in fact very high frequency electromagnetic radiations. And in addition to permitting the photosynthesis by which green plants extract carbon from the air, and by which they manufacture various vitamins, these high frequency electromagnetic waves are able to manufacture Vitamin D in the skin of man. Vitamin D is produced through the irradiation of various sterols, one of which is found in the human skin, and another of which is found in yeast.

To maintain health and youth the vital ray responsible for photosynthesis and the manufacture of Vitamin D must enter the human body by direct exposure of the skin to it, or through vitamins in the food. And it should be noted that this vital ray does not pass through glass, and is effectively screened out of the atmosphere that is clouded with smoke, as is the case in winter in some of our large cities. Furthermore in our more northern cities, there is little of the ultra-violet ray that penetrates the atmosphere in winter even at mid-day and under favorable atmospheric conditions. This absence of the vital ray is in part responsible for the lower vitality and increased death rate in winter. Sunlight is also one of the best known exterminators of pernicious bacteria.

This beneficial vital ray of the sun not only fails to pass through glass, but will not pass through many of the substitutes for glass that do permit lower ultraviolet rays to pass through. That is, between the visible ray and the vital range there are ultra-violet vibrations of little therapeutic value. Exposure to the direct rays of the sun that pass through such transparencies as are approved by the U. S. Bureau of Standards has a vitalizing effect upon the human system. When such exposure to the vital ray is impractical, the next best thing is to take pains to get plenty of Vitamin D in the food.

But even exposure to sunlight may be overdone. I am not referring to sunburn, which may be very serious, but to the effect of the ultra-violet rays upon the brain. There is a fad at the present time to go about with the head uncovered. This, no doubt, is all very well in temperate climates, or even in lower latitudes when there is abundant hair. But in the tropics it is suicidal. Even as far north as Los Angeles, where many young men go about in mid-summer with close cropped hair and no hats, its practice is open to question. Ultra-violet rays are very penetrating, and too much exposure to them tends to deterioration of the nerve tissue.

The Negro, who developed in the tropics, has the bones of his skull much thickened to prevent the ultraviolet rays from penetrating to the brain. Some students of the subject hold that the failure of the white races to maintain a high and aggressive culture in the tropics, except by sending in new blood constantly from temperate regions, has not been due to the heat, but chiefly to the deteriorating effect of the intense ultra-violet rays of the tropics upon the white man's brain and nervous system.

The fact one does not feel the rays at the time received is no criterion of their effect. It was once thought that the X-rays and the rays from radium were harmless because they were not felt. Yet they are now known to destroy tissue much exposed to them. Sunburn, likewise, is not felt at the moment

the chemical change is taking place. The pain arises afterward. Sunlight, including the vital ray, is essential to man's well being, but like almost everything else, there can be too much of it as well as too little. Discrimination should be used to get the right amount.

Keeping in mind the therapeutic value of both sunlight and fresh air, it will be apparent that our homes and the building where we work should be properly ventilated, and should permit, when practical, the entrance of sunlight. They should protect us from the cold in winter, the heat in summer, and from the dampness at all times. Dark spots in them encourage disease germs, as do places unreached by fresh air; and dampness is favorable to the development of fungi (molds, etc.) some of which are not friendly to man.

Clothing

—The clothing worn also should be selected with similar requisites in mind. Clothing should, no doubt, protect from the inclemencies of the weather, but at the same time should not deprive the skin of proper air circulation. It is true that experiments have proved that the slight increase of carbon dioxide common when a crowd remains, as for a lecture, in a small room, although carrying plenty of germs, is not as detrimental to human welfare as it was once thought to be. In such a room a person yawns and grows sleepy, and even feels faint; but experiments show this is not due to the excess of carbon dioxide in the atmosphere, but to the increasing heat about the body, and perhaps the odor of perspiration and exhaled breath. This excess heat is chiefly confined to the air spaces between the body and the clothing. Pure air would be better, but even the air that is in such a room if kept vigorously in motion by electric fans conveys the heat from the body rapidly enough so that the stifling sensation, as well as the yawning and sleepiness, vanish. This result, which has been carefully tested, would indicate that in designing clothing some care should be used that there is opportunity for the air properly to circulate between the clothing and the skin.

Summary of Physical Measures

—To sum up the physical measures for keeping young: There should be proper variety of foods, so that they will afford all the elements and vitamins necessary to build and maintain the human body, the food should not contain too much of the acid and thus fatigue-producing compounds and enough of the alkaline and thus fatigue dissipating compounds. There should be enough, but not too much, and in sufficient variety of the muscle replacing proteins. The food should be partaken of in proper combinations, eating should be made a pleasure, and the electromagnetic energies should be extracted from the food and from surrounding space. Proper breathing is essential. Sunlight, within certain limits, is beneficial and, because organs not used tend to atrophy, the physical body should daily receive exercise. This tones up the system and keeps the muscles supple.

Youthful Thinking

—The mind, unlike the body, does not gradually clog up with refuse and finally refuse to function. It is true that when the physical body has advanced to a point where disintegration sets in that the brain begins to lose its power. But such physical disability of the brain may usually be postponed to shortly before death. Ordinarily, unless it is permitted to atrophy as any organ will atrophy through disuse, the brain continues to function with all the keenness of youth up to a very advanced age. Any person who keeps abreast of the times can call to mind a host of brilliant intellects no longer young in years but still vigorous in function who attest that brain power need not flag with advancing age. Some of these people are no longer supple of body, but their minds still grapple efficiently with the world's important problems.

The brain does atrophy with disuse. But if given proper exercise daily it will continue robust even after the limbs have lost their power to support the body.

One of the most obvious attributes of youth is the eagerness with which it seeks knowledge. Children are noted for their curiosity, for the persistence with which they ask questions. Nor is the mind that continues to ask questions, that eagerly attacks new problems, old. It maintains its youth, and through its youthful effect upon the body, contributes to the vigor of the latter. If we would remain young, let us eagerly seek new information.

To keep the mind from running in a set groove, and at the same time to give it healthy exercise and fresh interests, it is well each year to take up some definite course of study, some branch of knowledge with which to become familiar. There are many branches of science with which some acquaintance may be made, in addition to occult subjects. Or some definite amount of intellectual application may be outlined in connection with some study in which it is desirable to become proficient. Unless one has some definite physical exercise to take, one is all too apt not to get sufficient physical exercise. And unless one outlines some definite intellectual accomplishment, and sets aside sufficient spare time for its attainment, the mind, likewise, is apt to be neglected. Not only should it be exercised daily by application, at least for a short time, to serious thought, but the topic of thought should be changed from time to time and new fields opened up; for when a brain is unable, or refuses, to accept new ideas, so stiffened with age that it cannot change its opinion, its youth has passed and likewise most of its usefulness.

Not only is youth curious, but also intensely enthusiastic. There is a keen zest for life and activity. Therefore, if youth is to remain with us, not only must we be intently alert for new information, but we must be enthusiastic. Enthusiasm, in addition to being a youth preserving quality, is also essential to any great accomplishment. The really big men in all lines of life are noted for their enthusiasm.

Furthermore, enthusiasm is largely a matter of habit. Some people become so negative and listless that only the most unusual occurrence, or the most artificial conditions such as those that obtain in the night clubs, arouse emotional interest. Others, more fortunate, can so invest the common place duties of their lives with interesting qualities that they are eager for each new day, to see what it will bring. And, after all, there is something interesting about everything we contact, if we will put forth the intellectual effort to discover it. By looking for the interesting things, and thinking about the pleasant factors that are present in all we do, we can cultivate enthusiasm.

Aside from this enthusiasm for our daily work, there should be some avocation to which we can apply ourselves out of work hours and toward which we are spontaneously enthusiastic. A hobby is a good thing in more ways than one, not the least of which is its influence to build enthusiasm.

Youth plays. And when the play spirit is gone man is no longer young. After the energies have been directed in a certain channel for a considerable period of time, due to well recognized psychological and physiological laws, there arises a lack of responsiveness. This is noted even in reflex actions; for if a stimulus be repeatedly applied to a nerve at short intervals, the resulting reflex—such as flinching from a pin-prick—grows feebler and feebler. But after a short period of rest the reflex gains its normal strength.

When a person works persistently and intensely at some occupation during ordinary work hours, his attention becomes so absorbed in it that his thoughts continue to be occupied with it after working hours. His mind is still occupied with its problems when he should be resting. But if he is interested in some form of recreation, this interest is strong enough that while engaged in it he no longer thinks of his more serious problems, and his brain gets a chance to rest. Just as a nerve, after a period of rest regains its original responsiveness, so the brain occupied with some recreation becomes rested in that department used in daily work, and regains its powers successfully to attack the important problems.

Nor is this the whole story of recreation. During work hours objective consciousness is focused on the solution of certain problems. The intense desire to find a satisfactory solution directs the unconscious mind to searching for such a solution. But while the thoughts continue to stir up vibratory whirlpools in the mind about the matter the unconscious finds it difficult to select the various elements concerning it and bring them together in proper relation. And while the objective thoughts are thus radiating positive vibratory rates the unconscious finds it impossible to bring the results of its findings to the notice of objective attention. But if the objective mind becomes engrossed with some dissimilar subject, with some form of recreation, the unconscious mind gains a calm and impartial view of the factors of the situation, both those recognized by the objective consciousness and those perceived by the astral

senses. When the solution is completed, the preoccupation with something quite dissimilar gives the unconscious the opportunity to project the thought of the solution into the region of objective consciousness. The idea flashes suddenly into consciousness while the mind is engaged with something else.

Most of the big executives in the business world make use of this principle in solving their important problems. That is why they take so many afternoons for golf. Business magazines advise executives to play more and stay in their offices less. It is now well recognized in high business circles that the solution to the most intricate problems of management and procedure more frequently than not pops into the mind while playing golf or occupied with other pleasant recreation. All the factors known by the objective mind are given intent consideration before leaving the office. The matter is thought out as thoroughly as the objective mind is capable of thinking. Then the executive takes down his hat and announces he will have the afternoon off. He feels confident the solution to his difficulty will come to him. He puts it from his mind, and thinks only of the game he is playing. All at once, without warning, the answer to his dilemma flashes unannounced into his mind. His afternoon at play has made his company more money, through the new idea, than a hundred days of routine office work.

In addition to being so good an investment from the financial standpoint, recreation is essential if the spirit of youth is to be retained. Play is not wearing because there are no inner remittances to break down. A thing becomes work because some part of the mind does not want to do it, and in addition to the energy spent in the work, the part of the mind that does want the work done must overpower the part that is opposed to it. This often requires more energy than the activity involved in the work. By making of it something of a game, that is, creating accessory interests in it, most work may be made play. And because play is the attitude of youth, such a manner of working aids in keeping young.

Avoid Monotony

—It has been found through carefully devised tests applied to industrial workers that the most deadening thing in ordinary life is monotony. Watch a group of children. They are doing first one thing then another. There is a constant change of interest and of movement. Routine work, unless offset with plenty of recreation in which there is change, swiftly kills. To do the same thing over and over without deviation develops a habitual set of actions that become so dominant that they prevent flexibility. Like the nerve that is repeatedly stimulated at short intervals, the routine worker loses the ability to respond to the normal stimuli of life. Monotony is the quickest pathway to becoming old.

Habits are our best slaves, but unless developed wisely they also become tyrannical masters. Those things that are essential should be built into ourselves as habit-systems; but in non-essential things there should be left freedom for initiative and change. Every now and then it is well to do something different. Go to a different kind of entertainment than that commonly enjoyed. Take a different route to the office. Move the furniture into different positions about the room. Do something different; for the most vital element in survival is adaptability, and this depends upon the ability to change. Change also is the foe of monotony, and by routing monotony we stave off old age.

Keep Active

—Not only do children change from one interest to another with much rapidity, but they are, while awake, ceaselessly active. They run to and fro, first interested in this and then in that. Life and activity are closely related. When activity ceases life departs. But youth is full of interest and activity.

How often have I witnessed, in the Middle-West, a farmer who had worked hard all his life and made enough to live in comfort without further labor, sell his farm and come to town to take life easy. He expected to live fifteen or twenty years at leisure. But, perhaps, he lived only two years, or possibly three, until the grave claimed him. No longer active, no longer keenly interested in accomplishment, taking it easy after establishing habits of hard work. Such change is too much for the body to stand. The lack of interest loosens the hold on life. Many a man have I known, apparently hearty and sound, to die thus in a few years of idleness.

Business men, too, who retire from work often fill early graves. But business men are awakening to the fact that old age and death tread close on the heels of idleness; and more and more when they retire from business they take up something else that keeps them both active and interested. Those who have accumulated wealth often devote their later life to spending it for human betterment, finding in this the necessity for the exercise of their abilities, as well as an adequate interest.

Retirement from active life is the great chimera.

To retire from active life is to court old age and death. But one who has enough money need not continue to pile it up. There are a thousand avenues, each of great interest, by which an individual of ability may benefit, at least in some small measure, the human race.

As the years accumulate it is not wise to place the strains upon the body that could be borne in earlier life. Violent exercise is dangerous to persons beyond 40. The body is a physical machine, and there is wear upon its parts. An old automobile may outlive and accept more use than a new one, if it is given proper care and the new one is strained to the limit. But an old car should not be driven under the stress that a new one will easily stand. Nor will an old human body stand the violence that a young one does, nor should it be expected to do so. But it may outlive the young one both in

years and in usefulness, if not subjected to undue strains. Athletics are for the younger person. Yet there are many things that the older may do, and if he would stave off decrepitude he should not fail to keep active within these bounds of safety. Activity is a means of retaining youth.

Youth lives in the present, with a keen anticipation of future joys and attainments. With nothing to look forward to, life fades. The past should occasionally be reviewed; for it affords lessons that become a background for present decisions. But dwelling much in the past is retrogressive, it is a symptom of old age.

To live in the present and keenly anticipate the future, as does youth, is natural when one has some definite work to accomplish. So long as life lasts there should be something of interest to be done, some worth while work to be accomplished. When life's work is done we are useless logs in the stream of life, and are apt quickly to drift to the shore that is other than physical. The zeal of life is to do something. And if that something is of benefit to mankind, even to a few persons, it gives to accomplishment a satisfaction and interest otherwise unknown. Those who die in harness are apt to keep their youth and prolong their lives far beyond those who shift the harness to other backs.

Occult Considerations

—The region in which old age first will manifest in our lives need not remain a mystery. The human machine will wear most, and will break first, in that part of our makeup denoted by the worst planet in the chart of birth.

To prolong youth, therefore, the thought-cells thus mapped should be reconditioned and given a harmonious trend by applying to them the proper mental antidote, as explained in Course 9. To build up the weakest section of the personality is to postpone disintegration.

At the commencement of this lesson I mentioned certain types of thinking that will prolong the life and assist in keeping young. And without mentioning that change and novelty are ruled by the Moon, and that intellectual activity is ruled by Mercury, I have indicated that harmonious thinking and acting according to the nature of these two planets of youth aid in keeping young. The third planet of youth is Venus, and the thought-cell activity mapped by it, and the cultivation of its harmonious thoughts and feelings, other things being equal, are as important as all the other thinking combined in its effect toward retaining youth.

Mars and Venus rule the gonad glands, whose hormones are more important than any others in their power to rejuvenate the other glands and the cells of the body. Harmonious aggressive thinking in association with thoughts of significance and thoughts of domestic life will lengthen the life and prolong the youth. This means that through a positive attitude no feeling of failure, despondency, fear or humiliation shall be permitted when the significance is attacked. When a mistake is made it can

be laughed off, after admitting it, and instead of feeling humiliated the individual can feel that next time he will be able to handle the matter successfully. And it means that courage and constructive ability be used in protecting the young and helpless.

Saturn—whose discordant thought-cells express as selfishness, despondency, fear, worry, anxiety and discouragement—is the planet of old age, and Venus is its natural antidote.

Venus rules love, art, music, beauty and romance. It governs the feeling side of life. When feeling has fled, life also has vanished. Seriousness, gravity, responsibility, reflection and the constructive attributes of Saturn are necessary qualities exercised at the right time. But they are not conducive to youth.

To associate with old people (Saturn people) is to grow like them. To be with the young and take an interest in their activities is to adopt their years. To chase out worry and care with merrymaking is to discourage the reaper with the scythe.

Love is a natural attribute of youth. Almost any person of mature years, as I have witnessed time and again, who falls desperately and successfully in love sloughs off at least ten years. Heavy emotional strains, and violent passions of any kind should be avoided by those of advanced years. Through the hormones released into the blood stream they lower the power of the glands properly to respond later, and may raise the blood pressure to a point where the cerebral capillaries, not so strong as once they were, rupture, resulting in a “stroke.” But the milder experiences of the pleasant emotions give the glands just the exercise they need to keep vigorous and healthful.

If we would prolong youth to the utmost, in addition to selecting as youthful environment as practicable, we must avoid, as far as possible, undue tensions, disagreeable thoughts, and inharmonious feelings. The association with the color yellow, the number 6, names and objects with the Venus vibration, and with harmonious music can be used to give the Venus thought-cells additional activity. And, applying the most fundamental of all occult laws, we should habitually think of ourselves as in that state of energy and youthfulness which we desire to retain.

But why should life and youth be prolonged? To have a home, to enter into marriage and raise children under present standards, and to move within a selected social circle, people in early life often put forth great effort. But the majority after reaching these modest ambitions stop progressing. Life becomes a routine performance at this level. Instead of advancing from one level of accomplishment to another, stepping higher and higher, as nearly every person has ability to do, most are content to stop at the level reached at thirty years of age. The result is that at thirty years of age they begin to lose their youth; for when progress stops youth disappears with it.

Chapter 5

Serial No. 155
Original Copyright 1944
Elbert Benjamine

Copyright
August 2002
Church of Light

How To Be Attractive

Chapter 5

How To Be Attractive



PEOPLE are attractive or unattractive because of certain well defined characteristics of their personalities. The personality is the habitual method of activity. It is composed of a number of behavior patterns. These behavior patterns tend to be characteristic of the thought-cell activity mapped by the planet in the birth chart ruling the department of life relative to which a given behavior pattern functions.

They have been given more specific trends by the experiences which the environment has afforded since birth. Yet—and this is the most important factor to remember—regardless of the astrological influences at birth and the manner in which subsequent environment has caused the energies mapped by the birth chart habitually to express, no behavior pattern is unalterably fixed. By following proper procedure the individual can change it in the direction he selects. And as personality is the sum total of observable behavior, when the behavior pattern is thus changed, a different personality emerges.

Attractiveness relates to those behavior patterns which govern our relations with other people. Changing these particular behavior patterns in any way alters our attractiveness. Therefore, if we would become more attractive we should carefully select those characteristics which make up an attractive personality and build them into ourselves as permanent behavior patterns.

As occultists we are devoted to human welfare. We desire above all to be of as great service as possible in the progressive evolution of creation. Our study of the elements of attractiveness is not prompted by the desire to advance merely our personal ambitions. It arises primarily from the realization that to increase our attractiveness is to increase our power to serve. The ugly, the uncouth, the repulsive, find it hard to make those human contacts which are essential to the success of many enterprises. If people are attracted to us it broadens our influence for good. We live in a world filled with other human beings. It is easier to get assistance from them, and easier to be of assistance to them, if they feel attracted to us.

The quality of attractiveness or of unattractiveness, it should be repeated, is due to well defined qualities of the personality that manifest as habitual modes of action. If we are to become more attractive, it is necessary to desist from those actions which are unattractive, and adopt such actions as have a pleasanter effect upon those we contact. Just what these actions are we will consider a little later. But first of all, because unattractiveness and attractiveness both are the result of habitual activities, and to become more attractive we must change some of these habitual activities, we should get as clear an idea as possible of how the personality is built up.

How Behavior Patterns Are Formed

—Considerable has been done by the Behaviorist School of Psychology in clarifying our knowledge of the development of personality. But in 1929 a still further step in this direction was taken in the publication of *The Process of Human Behavior*, by Mandel Sherman and Irene Case Sherman. This work, as well as that of the Behaviorists, is based upon test experiments with infants and children. It shows quite conclusively that in the human species the whole mental life and the tendency to act in certain directions which we designate as personality, are acquired.

Instincts are common to other young animals, but are almost totally lacking in human infants. The new born babe, as the experiments of the Shermans indicate, has a few reflex activities. It can swallow, closes the eyes when the cornea is irritated, sneezes, and responds to deep pressure. Sucking is present in all infants after 24 hours, but in many even this most essential response is difficult to elicit earlier. Even the pain response to irritation, such as pricking with a needle, is low immediately after birth, but develops rapidly in the following days.

At birth the child is capable of random movements. Tensing and random movements occur in the presence of disagreeable stimuli. It is also capable of relaxing in the presence of pleasant stimuli. Thus when the child is fed, or when stroked and patted, it relaxes. This undifferentiated activity in the presence of that which is agreeable is the fundamental response from which develops in the course of time the attribute of love.

Any form of sudden stimulation, such as dropping the child, a loud noise, restraint, pain, or a sudden rush of air on the face produces aimless activity of the muscular system, accompanied by crying. This is the fundamental response in the presence of the disagreeable from which develops pain reactions and the emotions of fear and anger.

As the child grows older its aimless activity in the presence of stimuli gradually gives place to greater coordination between the muscle groups. In the presence of disagreeable stimuli the child very shortly after birth shows a disposition to withdraw from it, to get away from the pain. Even a one-celled amoeba, one of the simplest of living creatures, shows a like response. It withdraws from irritating stimuli. This muscular activity of the child in withdrawing from pain or that which is disagreeable

is accompanied by an emotion, and this is the commencement of fear. Here we have the fundamental emotional response that later gives rise to remorse, worry, sorrow, disappointment, fright, timidity, self consciousness, and the corresponding emotions ruled by the planet Saturn.

If, however, the infant is restrained so that it cannot move away from the pain or disagreeable condition, it ceases to try to do so, and instead tries to push the disagreeable thing away. If the restraint is continued it stiffens the whole body, slashes about freely with hands, legs and arms, and then the breath is held until the face appears blue. The fear reaction is no longer present, but in its stead there has developed an aggressive response accompanied by an emotion that is the commencement of anger. Here we have the fundamental emotional response that later gives rise to courage, initiative, combativeness, aggression, destructiveness, and the corresponding emotions ruled by the planet Mars.

The first emotional response of an infant to a disagreeable stimuli, such as pin pricking, being dropped, a loud noise, or being restrained in its movements is of such a general nature that it cannot be defined either as rage, pain, or fear. But quickly, with a minimum experience in trial and error, it learns to have a definite emotional response to pain, a fear response to being dropped or to a loud noise, and an anger response to being restrained. Nor when first stroked and patted does it smile. It merely relaxes. But in short order this relaxing of the mouth becomes more definite, and at the approach of the mother or nurse who usually feeds or strokes it there develops a well defined smile. Pain response, anger response, fear response, and love response, are the fundamental behavior patterns, modifications of which when they become habitual conduce to an attractive or an unattractive personality.

Well defined emotions are not present in the infant at birth, but develop as the result of experience. Nor are the reactions of fear and anger so widely divergent in adults as might be supposed. An aggressive response must be accompanied by an increase in muscular tone, a strengthened heartbeat and a rise in blood pressure which allows for physical exertion. The same set of physical responses is also required in a defensive response such as is associated with fear. Tests have shown, also, that it is impossible for observers to determine whether a person is frightened or angry merely by his appearance. In either case adrenaline is secreted into the blood, the body becomes slippery with perspiration, the hair tends to stand on end, the heart beats faster, the blood clots quicker, digestion ceases, blood is withdrawn from more vulnerable parts, and the whole organism is put on a flight or fight basis. Whether it will be fight or will be flight in any particular instance does not depend upon the organic activity involved or upon the specific facial expression, but upon the way somewhat similar situations have been met in the past.

Just why one person responds to a situation with a fear reaction, in which the whole body is "set" for running away and another person responds to the same situation with an anger reaction, in which the body is "set" to destroy opposition, is due to past experiences in the lives of each since birth, in which they became "conditioned" differently toward such situations. However, the same environment since birth may

have provided experiences that cause one person to become conditioned in the direction of fear and another person to become conditioned toward anger. In the same early difficult situation a child with a prominent birth chart Saturn and a weak Mars will try to evade the issue through retreat and cunning, while the child with a prominent birth chart Mars and a weak Saturn will try to overcome it by force and fury. In other words, conditioning is always the product of the thought-cell activity of the given individual and the physical environment which he encounters.

The classical example of how animals, including man, become conditioned variously to the same stimulus is that of the Russian scientist, Pavlov, with his dogs. A hungry dog is shown food and the sight of food stimulates the flow of saliva, an ingenious method being devised to measure accurately the amount of flow. Then for a long time, just as the food is shown the dog a bell is rung. Finally the bell is rung without showing the food, and there is the flow of saliva originally stimulated by the food, but now stimulated by the bell. If, however, even after this positive reaction toward the bell has been established, every time the bell is rung the dog is given an electric shock, instead of exhibiting a positive reaction toward the bell, it develops instead, fear reactions. Further elaborate experiments on both dogs and children show that through adequate associations a condition that normally calls for a particular type of action may be thus conditioned to call forth any one of a wide variety of other types of action. And a type of action that is usually called forth by one particular set of circumstances may be made, by this process of conditioning the response, to be called out by any one of a number of other apparently unrelated circumstances.

In other words, how a person acts later in life in the presence of a given situation depends upon the conditions surrounding similar situations that he was called to face earlier in life and particularly in childhood. Queer people, in the early stages of their lives when their habits were forming, underwent experiences that caused them to associate activities of an unusual nature with situations that in ordinary people call out an entirely different form of behavior.

Watson found, for instance, that the infant has no instinctive fear of furry animals. On his first acquaintance with them he has no hesitancy about reaching out and touching them. But if, on successive occasions, each time he touches a rabbit or mouse a loud noise is made close to his ears (a loud noise being one of two things that call out fear as soon as the response of fear is differentiated from rage and pain, which is very shortly after birth) he soon comes to exhibit fear whenever he sees the rabbit or the mouse. Furthermore, because of Resemblance (See Course 5) this fear becomes transferred to all furry things, and he will cry and try to get away from his mother's fur neck piece, or even from rough woolen garments.

Nor is there any instinctive fear of snakes. An infant allowed to play with snakes has no repugnance about them. But if he witnesses an adult exhibit fear reactions toward snakes, he also quickly becomes so conditioned that he has a fear of them.

Love of the mother, also, is found to rest entirely upon experience. Even though it may jar sentimentalism severely, nevertheless careful experiments prove that there is no instinctive love of the child for its parents. Whoever is with it and ministers to its wants, pets it, and gives it pleasure is the object of the infant's love. This person, in the absence of the mother, is often the nurse. If the child grows up in the home of foster parents believing these to be the real parents, it loves them just as it would its real parents if they had treated it in the same manner. When the mother, for some reason, does not administer to the child's wants in early years, the child is usually taught that it is the proper thing for it to love its mother, and because of the power of such teaching may love the mother with great intensity even though it has never seen her. But this love also is a result of conditioning, of experience acquired through precept.

Experiments carried out on infants and children in the John Hopkins Hospital and the Harriet Lane Hospital have given us much reliable information upon just how the manner in which a child reacts to a given circumstance is determined. It is determined, except the few unconditioned responses mentioned and certain reflex actions of the muscles, by the experiences of the child after birth. That is, both the mental attitude toward things and the skill with which actions are performed, all are acquired. They are not instinctive.

When something is placed near the infant that it desires, its first motions are at random. If it touches the object in these random movements, next time it reaches, it is less at random and with more certainty. With practice it learns to touch the objects it desires at once. So also in learning to walk. Its first efforts are not coordinated. Gradually it learns to use certain muscle-groups at once that enable it to walk. When these movements become habitual they constitute the walking habit-system, and perform their actions without detailed direction. All acts requiring skill are learned and become habitual in the same way. In fact, one never becomes skillful in an act until its habit-system has been developed to a point where the details are left to the unconscious, that is, to habit.

The child's social adjustments are learned in the same trial and error way. Imitation also has a strong influence in shaping the child's reactions. Thus the habit pattern of the parents or other close associates is profoundly effective. In learning to talk, the child adopts the peculiarities of accent and pronunciation of its associates. If it is constantly associated with a mother who is nervous and fearful, the child adopts this behavior-pattern, and we have a timid nervous child. If it is constantly associated with an irritable father, the child adopts this behavior-pattern, and is apt also to develop irritation. Children brought up in homes where there is refinement have better opportunities of rising in life not because of superior inheritance of intelligence, but because the early environment stamps upon them strongly the desire for and appreciation of culture.

A child early in life may be faced with a rather difficult situation. Its experiences up to this point have not led it in the direction of fear. Instead of seeking to circumvent by subterfuge it meets the situation squarely, truthfully, and is praised for this attitude. It finds that it gets more pleasure from the praise elicited for honesty, than it would get from what it acquired dishonestly. Should it try dishonesty and get caught and be punished, it still further tends to establish the habit-system of honesty.

Another child, differently reared, is always punished, sometimes for misdemeanors and sometimes when there is only suspicion of wrong doing. This child does something and fears punishment. It lies about it, and the lie is undiscovered. This leads to more cunning in the future. Other lies are undiscovered, and other punishments escaped. Additional desired results are also obtained through falsehood. This child is not a born liar, but the lying habit-system has by this time such a hold on him that he will probably be a great liar as long as he lives.

Still another child wants something, and filches it. He is undiscovered. Again he steals and is not caught. He finds that he gets what he wants by stealth and subterfuge, and this habit-system becomes so firmly established that if given a position of trust later in life he cannot resist the temptation to become an embezzler.

Yet another child early in life is alternately scolded and petted. Sometimes he gets what he wants immediately. At other times the parents deny him. The child tries various means—as most children do in early years—to gain his point. He tries sulking. He tries crying. He tries going into a tantrum. In a tantrum the child is a great annoyance to the busy parents. They yield to this violent outbreak which may take on alarming proportions; for the child may hold his breath until unconscious. Next time the child wishes something very much he throws another tantrum. Again he gains his point. When he goes to school he is known for his violent temper and uncontrolled behavior.

A girl growing thus to womanhood is temperamental and hysterical and may spend much money on doctor bills trying in vain to find a cure for her nerves. A boy growing thus to manhood may be known as a competent business man, except for his violent temper which makes it impossible for anyone to work with him, and which spoils most of the opportunities that are brought to him by life.

The fundamental urges back of human life are not learned. All normal persons desire security, self-respect, respect of others, adventure, and sexual expression. But the manner in which these fundamental urges, which may be classified in ten groups (Course 9), find expression is acquired through experience. We meet a situation in one way, and another person meets it in another, not because our fundamental urges, our primary desires, are different; but because the environmental conditions of our lives have been such that we have built into ourselves different habit-systems.

We have-developed certain work habit-systems, which determine whether we are industrious, neat about our work, thorough or careless, accustomed to watch the clock or to give good service, change employment frequently or continue in one place and in one line. Likewise we have developed study habit-systems, domestic habit-systems, eating habit-systems, sleeping habit-systems, recreation habit-systems, social habit-systems, etc. From knowing one habit-system of an individual it is impossible to form a judgment of his other habit-systems. A person who is always polite and agreeable in others' company may be a tyrant in his own home. He has developed a company habit-system that is in contrast to his home habit-system. On the other hand, some of the world's most notorious criminals have been unusually kind parents and loving faithful husbands or wives. Their domestic habit-systems were conditioned socially, but certain other habit-systems were decidedly anti-social.

What we should realize, and keep constantly before us, is that we are made up of various habit-systems. Such habit-systems become strongly entrenched, and greatly resist change. As a rule, however, it is not impossible to change them. The form of the body, except in the matter of weight, is not easily susceptible to much change. But the balance of the personality is made up of various habit-systems. Upon them depends whether or not one is attractive. By changing the habit-system involved the power of attracting others may be developed.

Before taking this up, lest someone jump to the conclusion that all persons are born with the same ability to acquire habit-systems, and that environment after birth exclusively determines the trend of life, let me explain further:

As a result of the experiences before human birth each person has groups of thought-cells organized in his astral body that relate to all the fundamental desires. He is born at such a time that the planets in the sky accurately map not only the degree of activity of each such group of thought-cells, and the department of life experiences with which formed them, but also their relation to other thought-cells, and whether their desires are harmonious or discordant. That is, the birth chart maps the result of all the experiences before human birth as these have formed thought-cells within the soul.

The events which are attracted after birth correspond in their characteristics to the planetary nature of the thought-cells and their harmony or discord. The more active thought-cells—those mapped by more prominent planets—attract more important events, and these events are characteristic of them. The more active thought-cells also influence the thoughts and the tendency to behavior. That is, the environment both in childhood and in later life which tends to condition the individual's attitude toward different departments of his life, is influenced by the factors mapped in the chart of birth. Furthermore, because certain groups of thought-cells are more active, and certain groups are more harmonious, in one child's astral body than in another's, one child will react to a set of circumstances quite differently than will another child, even though both have grown up in the same home and within the same general environment.

The child who has Mars dominant in his birth chart not only attracts the type of environment that conditions him to give the anger reaction instead of the fear reaction; but the anger reactions develop quicker and stronger than they do in other children even under the same environmental conditions. The child that has Saturn dominant in the birth chart, on the other hand, not only attracts such events as tend to develop in him fear reactions, but because of his astral makeup he develops fear reactions much more quickly and much more fully than another child would under the same circumstances.

But when we stop to consider it, this merely removes the source of our habit-systems to a more remote period in the past. The birth chart with which we are born indicates the tendencies to form habit-systems that result from experiences in the past. The formation of these habit-systems takes place after birth. Whatever we are, successful or unsuccessful, happy or unhappy, attractive or unattractive, is the result of habit-systems, and these are due to experience. And when desirable, through other intelligently attracted experiences, we can change in such direction as we desire, these habit-systems. If we are unattractive, by developing the habit-systems that cause one to be attractive, one may acquire that quality.

That Which the Birth Chart Indicates Can Be Changed

—This is not merely a theoretical assertion; it is based upon much painstaking research. The result of this research is set forth in detail, and comprises Chapter Two—Important Knowledge Gained From Progressed Aspects of Twins—of the book *WHEN AND WHAT EVENTS HAPPEN*,¹ and is still further considered in the chapter on The Astrological Quantum of Action in the book *ASTROLOGICAL LORE OF ALL AGES*.

The Brotherhood of Light Astrological Research Department carried out extensive Case History Studies of the events which come into the lives of people with practically identical charts and progressed aspects. These studies embraced the characters and lives of identical twins, natural twins, and astrological twins. And they show that such twins when reared amid different environments develop different attitudes toward things and different skills. As identical twins have exactly duplicate sets of genes, and thus the same physical heredity, these differences cannot be due to heredity. And when such identical twins have almost identical birth charts the differences cannot be attributed to differences in astrological factors. This means that the training they have received by being in different environments is responsible for the observed differences in personality.

University scientists have made a study of twins, comparing the lives and personalities of those who were separated from each other early in life with the lives and personalities of twins not thus separated. In some instances the separated twins had about the same educational advantages and a fairly similar social environment, and in other instances the environment was markedly different in both respects. Some of the separated twins had chances to visit each other at times, but in other cases there was no contact for years.

The result of the research of these scientists is the conclusion that human intelligence is not definitely fixed by heredity, but may be distinctly influenced by such environmental factors as education and social position. The conclusion reads: "Not only can intelligence be influenced by environment, but personal traits such as temperamental and emotional attitudes are affected by environment to an even more marked degree. But heredity is dominant in all physical characteristics except the obvious one of body weight."

Other studies conducted by Dr. Skeels, professor at the University of Iowa, showed that when children attended a nursery school or were transferred from a bleak orphanage to good homes, their I.Q.'s invariably improved. Dr. George Dinsmore Stoddard, Director of the University of Iowa's Child Welfare Research Station holds that, "With good upbringing even a dull child may become bright"

To support this view, in addition to his own observations he points to the report of the year book that identical twins reared in separate homes had different I.Q.'s, and that Southern Negroes who moved to Harlem, and thus got better schooling, raised their I.Q.'s. And Robert Ladd Thorndike found when he examined the records of some 1,000 children in three famed progressive schools (Horace Mann, Lincoln, Ethical Culture), that in two schools the children's I.Q.'s were static, but in the third (unidentified) there was an average I.Q. gain of more than six points.

In a similar manner our Case History Studies of people with almost identical charts show that while the thought-cell energy mapped by the birth chart tends to express in a manner characteristic of the planet mapping-it, and through the departments of life the houses of which the planet rules, the importance, the special manner, and even the harmony or discord of its expression, are largely determined by the environment.

This means that while it seems to be impossible to prevent the energy mapped by a given planet expressing in characteristic manner, that it is not too difficult to divert the energy into expressing the constructive activity of the planet rather than in something displeasing.

Furthermore, even as the scientists mentioned relative to increasing intelligence, any quality can be given greater activity through adopting a proper habit-system. The energy of a given group of thought-cells may be increased by giving exercise to the quality expressing them, and the quality of their expression can be improved by cultivating a habit-system which permits and encourages them to express more pleasantly. And if this pleasant expression is designed to give great attractiveness to the personality the individual will become an attractive person.

The Attractive Personality

—As already pointed out, there is no mystery why one person is attractive and another unattractive. If the attractiveness is looked upon as a single unit the differentiation becomes difficult, because there are a large number of factors which contribute to it. But if the qualities of the personality are broken up for the purpose of analysis into its various habit-systems, and each of these is considered as contributing to or detracting from the attractiveness, the mystery vanishes.

Thus, because of training from childhood—although many other animals than man also put forth much effort in the same direction—people desire to keep clean. Filth is repulsive to the normal human being. No one likes to see soiled clothing. No one likes to see dirt on the hands or face of another. Black-bordered and untrimmed fingernails do not induce the feeling of pleasure in others. Gleaming white teeth, well cared for hair, and a skin that if not fresh at least appears clean and wholesome, all have attractive power.

Neatness, also, is an asset to personality. People like to see clothes that are well cared for. It gives the impression that the person has some respect for himself if his trousers are always creased and his linen freshly laundered. Polished shoes, like a clean face, give pleasure to those who look at them. Dusty shoes and soiled or disheveled wearing apparel give those who look at them a feeling of displeasure. Slovenliness, however, is not confined to wearing apparel. Some people walk carelessly, slouching along; talk carelessly, mumbling their words; and sit carelessly, just slumping down in a heap, or sprawling in a chair in a way that is most distressing to others who have to watch them. How can one expect to have the respect of others if one lacks respect enough for himself to walk gracefully, to talk plainly, and to sit as if life had some meaning. Any form of untidiness, awkwardness, or carelessness in speech tends to give our associates a feeling of uncomfortableness. When we give others pleasure, and only then, are we attractive. Neatness and cleanliness and an appearance that indicates one has some respect for oneself, are all habit-systems that when established give other people pleasure, and hence attract them.

Even a very plain face may be made attractive if it shows life, sympathy, and a joy of living. People desire to live, and they find some vicarious fulfillment of this desire in witnessing abundant life in others. No one likes a frown. Sadness and sorrow are things we shun, and we recoil from them when mirrored in the countenances of others. A smile and a laugh are contagious. People enjoy themselves when they smile and laugh. The person who smiles gives others pleasure, and they like him. Cheerfulness likewise communicates its joy. Cordiality too has its value. Show that you are pleased to meet people and to be with them, and they will respond by being pleased to be with you. The face can show sympathy, interest, life, and pleasure, and these each have attractive quality.

People are attracted by the pleasure you give them. For that matter, the fundamental attractive principle of all life is pleasure, and the repellent principle is pain. But on this account do not become a “yes” man. No one likes a human jellyfish. People do not like obstinacy, or argumentativeness, but they like strength and character. To have the courage of one’s convictions tends to be an attractive quality among people worth attracting. This does not mean, however, the unnecessary intrusion of one’s personal convictions.

While it is known to be a fallacy that the person who looks one straight in the eye is more honest than the one who does not, yet to look straight at another when talking to him or when listening to him gives a favorable impression. The person who shifts his eyes when he talks to another is probably over sensitive, and may have an inferiority complex. He may be quite honest. Yet to be able to look men and the whole world straight in the eye conveys an attribute of character that most people admire. It gives most people more real pleasure to associate with a person of character than with a living door-mat.

I suppose nearly everyone is rather sensitive to voice quality. Few things have greater power to repel than does a rasping or a strident voice. The high-pitched voice denotes nervous tension. It is none the less disagreeable. Then there is the flat voice. That is, the voice without inflection or expression. Conversation is a part of our everyday lives, yet the tones most of us produce are anything but attractive. People who spend much money on clothes and much time on beauty treatments, often have voices that drive others almost distracted. A little time spent freeing the voice from its disagreeable contractions, and developing resonance, would yield far better results. We all must speak. The tones we utter are attractive or the reverse. We may not be able to take vocal culture, but at least we can listen to our speech and strive to soften and give resonance to the tones so that they will have a pleasant effect upon the ears of others. A pleasant voice is one of the most attractive attributes that a personality can have.

I suppose in some rather constrictive quarters I will be deemed a heretic when I voice the opinion that it is everyone’s duty as well as privilege to dress and act in as charming a manner as is practical. Some will say that clothes and voice and posture are only the external coverings of the real man, and the thing that counts is the character. What matters it that a man goes about in rags; and as we sometimes witness here in Los Angeles, with a flowing beard somewhat matted in spots with dirt, and incrustations of soil on the neck and behind the ears; if he has a beautiful soul?

To these I must answer that all we can know of a man’s soul is what he reveals to us through his actions. And it is true that some ragged and decidedly untidy individuals who occasionally appear on the streets of Los Angeles have kindly hearts and commendable sympathies for suffering mankind. That is, they have certain habit-systems of helpfulness to others that are admirable. Nor is anything detracted

from their usefulness, perhaps, by dressing in an unusual manner. Individuality is sorely needed in this land of standardization. But such habit-systems as repel people through untidiness or uncouthness, instead of adding to the saintliness, as seems to be expected, I am sure, detract both from the saintliness and the usefulness.

According to my standards at least, one of the qualities of saintliness is the faculty of giving pleasure and relieving pain. But a repulsive exterior, regardless of the inner motives, causes others aesthetic pain and by driving them away makes it more difficult to help them. It seems to me that the notion of severity of attire, like the attitude that poverty is linked with virtue, derives from a past in which religion perverted almost every fundamental principle of psychology to the lasting detriment of the human race.

One of these psychological principles is the law of change. Already I have mentioned the tiring effect of monotony. It is a strain to direct the attention steadily for long to any one object. In fact, unless the attention moves at least slightly the concentration results quickly in unconsciousness, in sleep. Life is activity. Where there is no change there is no life.

Life has become accustomed through its long evolution to rapid adjustments to new situations. The habit of constant change has become entrenched through a million generations. No wonder, then, that all human beings crave change! No wonder when the war bugles sound that a million men rush to the colors! Patriots? Yes. But more than patriotic, desiring change.

Without admitting it even to themselves they are tired of the monotony in which they have been living. There is no romance and too little variety in the daily occupation. Going at night to the same home, to the same wife, to eat the same kind of food, and retire at the same hour. Not but that their homes, their wives and their food are good; they simply have seen them so often that the monotony is irksome, Unconsciously they feel that almost any change is better than such deadly monotony. But to throw up a good job, a good wife and home and go rambling would be to acknowledge oneself a fool, and a knave as well. But when the country calls, adventure is in the air. Change is in sight, and such change as wins the approval of oneself and one's fellow man. As long as homes are dull and occupations largely routine there will be little lack of those who warmly welcome going to war.

But how is this psychological principle of change to be applied by those who instead of going to war go out socially to converse with others? It is to be applied by variety in attire, by inflection in speech, by new subjects of conversation, by new interests, by a having something new to do or to suggest doing, by acting differently at one time than another, and by consistent endeavor to break up monotony with something new and when possible something original.

It is a mystery to most men why women must have so many new clothes. But it need remain a mystery no longer. No matter how beautiful a garment, seen too often it loses its charm. Women have learned this no doubt through observation.

The clothing of men has become so standardized that the amount of change in appearance has been reduced to narrow limits. Still, wearing a different tie each day and a shirt of different pattern, gives a little variety. A golf suit for recreation, a business suit of a different shade now and then for the office, and an evening suit for after dinner wear offer some opportunity of change. How many suits a man should own, of course, depends upon financial and other circumstances.

But whether it is a man or a woman we are considering in relation to attractiveness we cannot neglect the manner of dress. We have been taught to love the beautiful in nature and to recoil from the sordid. Education has given us some appreciation of a well painted canvas or a finely proportioned statue. We are taught from childhood to be attracted to grace of line, to properly blended colors, and to the harmonious in design. When we see a person in whom the clothing is of such a nature and so worn as to suggest these artistic attributes we cannot be unattracted to that person without breaking up our long established habit-system of being attracted to the beautiful.

Considering the matter still further, is it not one of the functions of a useful life to give pleasure to others? Circumstances compel most of us to live among people. Is it noble of us to inflict the pain of compelling others to look at something disagreeable when in our presence? I think not. The beautiful and artistic have the power to exalt the spirit. They lift the soul from a contemplation of the mean and sordid in life. Why not, then, contribute to the joy and spiritual yearnings of others by making ourselves appear as artistic, as beautiful, and consequently as attractive, as we are able?

The very first step in attraction, of course, is capturing the attention. One is neither attractive nor unattractive to people who are unaware of one's presence. To be attractive one must, by some means, emerge into the field of people's attention.

The unusual always attracts attention. Also, action of any kind is quickly noticed. A bird in a tree is hard to see until it flies. Motion makes objects obvious. Therefore, when with a crowd, to stand out from the unnoticed mass, make it a point to be different enough from others to attract attention, or do something. Attention may be attracted, however, either pleasurably or disagreeably. Newspaper headlines are given over to people who are unusual, or who have done something. That is, they have attracted attention. But more often than not the manner in which they are different, or the character of their acts, causes people to be repelled rather than attracted to them. To be attractive one must not only attract attention, but attract it in a way that will give others pleasure.

One who desires to be a social success should have some "line." That is, he should have something that he can do well that in a gathering will contribute to the life and pleasure of the party. A good story teller is always in demand. One who plays some musical instrument, and is willing to do so tends toward popularity. Singing is an asset. One who can make a short speech, give a recitation, or otherwise contribute to the activity and variety of an evening also has some advantage. And on many an

occasion have I witnessed someone who could read the tarot cards, and was willing to do so, become the chief center of attraction of the evening. People are always interested in themselves. To be popular at a gathering, do something to contribute to the welfare or entertainment of those present.

Coming back to the thought just expressed that people are always interested in themselves, this peculiarity may be utilized by encouraging them to talk about their affairs and interests. Everyone is interested in something, and it never fails to give him pleasure to find someone else who has some interest in the same subject, and with whom he can exchange ideas. To talk to a person intelligently about his hobby is often to win his everlasting friendship. And why should we not be interested in people and in their ideas? Is life so narrow that we need confine our sympathies to a single highway? It will help us to get out of the slender rut in which we travel to become genuinely interested in other people and in their hobbies and ambitions.

This matter of talking, however, should not be one-sided. Give the other person opportunity to talk at least half of the time. When he is talking, especially if talking about something he is interested in, he is enjoying himself. By all means do not talk merely of the things that interest you. Such talking is not conversation, it is of the nature of a soliloquy in which the other person, out of politeness must listen though immeasurably bored. Conversation may be stodgy, commonplace, and verbose; but to be pleasant should have in it an element of life, and an interesting give and take of thought.

Another thing that gives pleasure, and is a saving grace in many situations is a sense of humor. When unpleasant things happen, and everyone is all keyed up, if someone can see and express the ridiculous side of the situation, in the laugh that follows the nervous tensions are released and everyone feels better. It is quite possible, even if it is naturally lacking, to cultivate the ability to perceive the incongruities and bring them to the attention of others. The perception of incongruities is the foundation of humor. Humor tends to bring people into sympathetic understanding, making them feel easy and congenial. Of course, one may become quite a pest by continued attempts to be "funny"; but such a state of affairs is but the miscarriage of a laudable ambition. People rarely fail to like the person who is exceptionally humorous.

Wit and humor, however, are in different categories. Fun at the expense of another's self-esteem is to incur the other's enmity. Nothing so humiliates a person as to be made the butt of a joke, to be made to appear ridiculous in public, and to be laughed at. It is a form of punishment that seldom finds forgiveness, and while others may laugh, no one really likes the person who habitually causes other people this kind of pain.

The Complete Circuit

—When we talk to another person, and when we think of another person, energy from us goes out to that person. Our words, perceived by the person, cause him to feel a certain way. Our thoughts, impinging upon his astral body have an influence upon it that causes him, without being consciously aware of the reason, to feel in a certain way. But feelings, to influence the unconscious mind of another, are stronger than ideas. That is, thoughts vitalized by emotions have dynamic power. But to exert their full power rapport must be established, as explained in lesson No. 101 (See Serial Lesson Key), between the two persons. If we would be powerfully attractive to others, we must sympathize with them, or get them to sympathize with us. This causes the establishment of rapport which permits the exchange of both electromagnetic and astral energies. Then we must strongly feel toward them as we would have them feel toward us. The circuit of energy is thus completed, energy flowing from us to them, and from them to us, of a kind determined by the person whose feelings at the moment are the stronger.

Chapter 6

Serial No. 156
Original Copyright 1944
Elbert Benjamine

Copyright
August 2002
Church of Light

How To Have Friends

Chapter 6

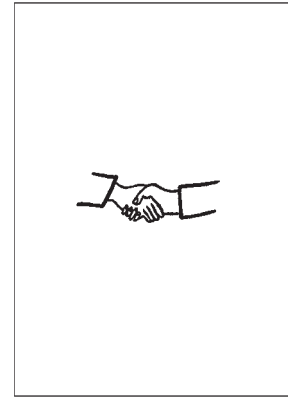

How To Have Friends

MAKING friends and keeping friends are no more mysterious than being attractive, when the various factors that contribute to them are considered separately. One makes friends or fails to make them because of very definite habit-systems. Presently I am going to discuss these factors that contribute to making friends and to keeping them.

But before giving further attention to the effect that our customary behavior has upon the attitude of others toward us, it seems highly desirable that we know more about these habit-systems, and in due time, also how to change them.

I am not in this place going to give a detailed explanation of the elements of the nervous system and the way they act. Anyone interested in neurons, with their axons and dendrites, and the synapses between them over which nerve currents must pass, may refer to some good physiology book. Nerve currents, thoughts, and actions once expressing in a certain way find it easier to express in that way in the future. Groups of muscles or groups of thoughts, in some manner cooperating once, find it easier to cooperate in the same manner again. This fact has been thoroughly established by experiments. This is due, no doubt, somewhat to the laws governing the nervous system, but even more, I believe, to the establishment of pathways of energy, and energy connecting lines between various factors, in the astral body.

Some of us have lived at times in parts of the world where in winter the ground became deeply covered with snow. After a heavy snow, and before trails were broken, the going was found exceedingly difficult. The first person to go from one point to another not only found it difficult to make headway through the deep drifts, but frequently, because of side interests, did not go the most direct route. The next person to go to the same place found travel less difficult, because the trail had been broken. He could, of course, by the use of effort and initiative, go the most direct route by leaving the trail where it departed from this route and break a new one. But unless the first trail were excessively circuitous he usually preferred to follow it, because on the whole it took less effort. And the next person over the trail found it still easier to travel. By the time it had been gone over a few times the trail became so well established that progress through it was very easy compared to progress where no trail existed.

Our Behavior is Made Up of Habit-Systems

— Our behavior in life is made up of habit-systems, and these are simply systems of trails that have been broken in our astral body. It required considerable energy to break each trail, to establish each particular action of a system. Certain of these trails converge and unite in a definite system. Thus in learning to handle a fork properly, the child must first learn how to grasp it. He must learn how to get it under the food. He must learn the distance from plate to mouth, and the direction of his mouth, and accuracy enough to find it without fumbling. A number of actions usually learned separately are required in this and in any act of skill. With these trails in the astral body, or if you prefer the materialistic view, in the nervous system, established separately, he joins them together as a single system. He no longer has to think of each separate movement. All he has to do is to think of eating with a fork, which places his activities on this system of trails, and because the trails are all well broken and joined together his activities follow them and he continues to eat properly with the fork so long as he holds the thought of so eating, all the details taking care of themselves. The details have become habitual, that is, they are governed by trails in the astral form which constitute a portion of the unconscious mind.

Some of these habit-systems are formed before birth into human form. The reflex actions, digestion, secretion, breathing, and assimilation are habit-systems built into the astral form in lives lower in the evolutionary scale than man. But as was explained in the preceding lesson, with the exception of a few fundamental responses, our likes and dislikes, our inclinations and our more overt behavior are all acquired after birth. Through early experiences in life we have formed the habit of behaving in certain ways toward acquaintances, behaving in other ways in reference to business, in still other ways in our domestic life, and according to other standards when engaging in recreation.

People usually believe that in these various relations of life they are acting according to the dictates of reason; but as a matter of fact reason plays a rather insignificant part in the behavior of most people. Their behavior when confronted with a certain situation, instead of being determined by a careful analysis of the circumstances, is usually determined by habit.

These habits were not formed because they are the best method of meeting such situations, but because of a variety of associations in early life that gave rise to pleasure or pain. If a certain situation in infancy was met by fear, and similar situations later in life were permitted to cause fear, no matter how unreasonable it may be, the adult will be very apt to experience fear whenever such a situation arises. The child who repeatedly gains his point by becoming angry, when he becomes a man in business will continue to try to gain his point through anger, even though his reason tells him it is the worst of all policies in his present situation. His Mars thought-cells will take the reins in spite of his attempts to remain calm, and anger will

take possession of him. Or if he has formed the habit of speaking disparagingly of others, even though reason indicates that such a course only brings enmity and no gain, out will come nasty remarks about others at unguarded moments in spite of himself.

Reason Customarily Plays An Insignificant Part

—That reason customarily plays so insignificant a part in directing human behavior is not due to lack of the power to reason, but to the circumstance that of necessity most actions of life are the result of habit, and that these habits were formed by conditions that arose in the life before the reasoning powers were fully developed. The early associations with certain words, with certain kinds of people, and with certain objects are such as to cause people to be attracted to or repelled by them. If these early experiences were pleasant, they continue to be attracted toward these words, people and objects later in life. If these early experiences were painful, they tend to continue to be repelled by them.

We are taught in life to be attracted by the words moral, good, true, and similar words associated with conduct beneficial to society. Our reaction to these words has become habitual. Consequently, when a politician stands on a platform and speaks of the high morality of his candidate, of his truthfulness, and of the good he will do if he obtains office, we warm toward that candidate. When he denounces the opposing candidate as immoral and a liar, and implies that only evil will result from his obtaining office, our habits make us shrink from this opposition candidate. And it is only the unusual individual, one in a thousand perhaps, who overcomes these habitual reactions to words to the extent of carefully analyzing the situation with a view of discerning the real morality, truthfulness, and benefit to be derived from each candidate. Orators play upon, and move people by, the words toward which habitual responses of a given character have been firmly established.

If early in life one is taught to look upon people dowdily dressed, or if in early life one's parents and those who are kind to one always appear well dressed, and such others as tease, annoy, and mistreat happen to be people poorly dressed, a truly democratic attitude will be very difficult to attain later in life. In the unconscious—that is, in the astral body—the association of that which is disagreeable will be closely linked up with shabbily dressed persons. One will feel uncomfortable in their presence, and—regardless of the ability or moral qualities—one will be repelled from them. And one will tend to like all well dressed persons, even though little ability and reprehensible morals are their outstanding characteristics.

If one has a very disagreeable experience of some kind when on a bridge very early in life, later in life, after the event has been forgotten, there may be an unaccountable aversion to bridges. If, in addition, the event is never spoken of through shame, and a strong repression results, the aversion may become pathologic. Thus do various phobias develop. There are otherwise normal people who are violently afraid of knives, of open spaces, of closed rooms, or of running water. In fact, I am inclined to think that most of us have what has been called nomic phobia, meaning the fear of going against custom or tradition.

Even the thought of changing something in the standard prayer book recently outraged the feelings of many good people. Just say "evolution" in the presence of a fundamentalist, and he immediately is insulted. Speak of astrology, or of the occult sciences, or of the abolition of armament in a conservative group and they become indignant. Not because they have investigated these things, or because they know of any careful analysis made by another, but because certain ideas have become habitual. Habits have been formed of accepting certain ideas as sound. Any departure from these ideas necessitates breaking up these habit-systems. With so strong a habit-system established regarding the sacredness of accepted ideas, even the contemplation of a new idea gives rise to a feeling of guilt.

Due to the circumstances surrounding certain early experiences, often habit-systems form that are of great detriment all through life. Excessive shyness in an adult, for instance, usually may be traced either to over-solicitous care or to unreasonable prohibitions in childhood. If a child is held back from entering into the games and sports common to childhood, usually a sense of shame develops. He fears these games but is ashamed to admit it. He is also ashamed to admit his parents will not let him play as other children do. This shame thus becomes a repression, which in adult life, in spite of his reason, causes him to be timid and unapproachable.

Real and imaginary inferiorities are compensated for often by habitual actions or emotions all out of proportion to the circumstances that give rise to them. In spite of the real qualifications, there is a tendency of the unconscious to refuse to admit unfortunate events are due to the person's deficiencies. And, where difficult conditions are met early in life, the habit of fleeing from reality by living in a world of fantasy develops. Mechanisms of defense, mechanisms of compensation, and the flight from reality, in some small degree enter into the habit-systems of all of us. In others these become dominant habit-systems. But whether to a great extent, or to a lesser, they hinder our successful adaptation to the circumstances of life, and should be replaced by habit-systems based upon straight thinking.

Every situation in life, everything we do, presents a problem. There are numerous ways of meeting each situation and of doing each act. Also there is a best way. The problem is to find this best way. It can only be solved through a cool and impartial analysis of all the factors involved. The more facts at the command the better. Due reflection, in which different methods are thought out and compared one with another is the proper method of procedure. And because so much of thought, activity

and feeling are based upon early acquired habits, it is well thus to carefully analyze every once in a while not only the more important activities of life, but also those apparently inconsequential. In the latter are often found the cause of larger failure or success.

I can think of no one thing that will conduce so much toward enabling a person to attain his desires as that of habitually considering every situation that arises as a distinct problem to be solved by finding the best possible way to think, feel, and act under the circumstances.

Merely to perceive the best way of thinking, feeling, and acting under a given circumstance, however, does not give one the ability to meet the circumstance in this predetermined way. Merely to know a beautiful tone when it is sounded on a violin does not give one the ability to produce that tone. Acts of skill are based upon habit. To think, and feel, and act as reason dictates, we must replace unadvantageous habits by those of greater value. That is, to change our lives to any appreciable extent, we must change our habit-systems.

Habit-systems are not changed by simply thinking about them. They are changed only through the application of much effort; and if the effort is applied according to the psychological principles underlying habit-formation, the change will be brought about more readily. Regarding the old habits, as old trails become obliterated when disused, they should be given no attention. Because habits feed on attention, the attentions should all be given to those that are to replace.

The Three Fundamental Principles of Changing a Habit-System

—Three fundamental principles should at this point be emphasized. 1. To break a bad habit, cultivate some good habit which by its nature is incompatible with the bad habit, and when practiced tends to displace the latter. 2. To remember something unfamiliar, associate it strongly with something else sure to be remembered. 3. In some manner, associate as strongly as possible with feelings of pleasure those acts and thoughts that it is desirable to make habitual.

As has been explained in some detail and illustrated by example in lesson No. 152 (See Serial Lesson Key), the initial difficulty in forming a new habit is the tendency not to remember at the proper time that the predetermined upon actions are to take place. As there illustrated, this difficulty may be overcome by linking up in the mind the desired actions with other activities that already are habitual.

Habits, as was explained in lesson No. 155 (See Serial Lesson Key) where the experiments with Pavlov's dogs are mentioned, are originally formed as reactions to pleasure or pain. They are formed to attain pleasure and to escape pain. Not that they always attain these results, for a habit that brings pain may arise through false belief that it will bring pleasure. But the principle underlying all animal activity is that movement is toward pleasure and away from pain. This principle should be utilized in the formation of new habits. Habits naturally form along the line of the most pleasant association.

There are, of course, two habit-forming techniques. There is the pleasure-technique, such as just mentioned, and the pain-technique. Not only does the burned child shun the fire, as we are often reminded, but it is customary, and no doubt necessary, to restrain and in some manner punish small children. When Willie at table dips his fingers into a dish of food he is usually reprimanded, and if he persists, his knuckles are perhaps rapped with the back of a fork. This is the pain-technique. Willie learns not to use his fingers where others use silverware. But the pain technique has two serious drawbacks that curtail its usefulness. First, it builds inharmonious thought-cells into the astral body that tend to attract misfortune. Second, it builds up an association of pain with the habit in such a manner that factors originally associated with the habit are intensely disliked, and in such a manner that when the element of pain ceases to be obvious the habit may be discontinued.

People who have had to make considerable sacrifice to get an education usually appreciate its advantages more than those who have not. Unless they had strongly desired an education they would not have made the sacrifices. They were doing something they desired to do, using the pleasure technique. Others who continued in school because compelled to do so by parents, or merely because it is the customary thing to do usually have less appreciation of learning, and are less likely to continue studying after they leave school and the compulsion ceases. This exemplifies the pain-technique; for compulsion is always painful.

- Probably the strongest reason why people after they leave school care so little about further improving their mind is due to the pain-technique commonly used in building the study-habit-system. In the first place, there were many pleasant things to do out of school, and being shut up in an unattractive room a greater part of the day in itself is monotonous. The school teacher compelled them to study, and as mentioned, being driven is painful to the self-respect of most persons. Perhaps, also, the school teacher was sarcastic, became angry on occasions, and made them sit motionless and in silence, gave examinations that frightened them with thought of failure, gave demerits, and caused them to stay after school. Always there was a great relief when the study period ended and they left the dull books behind to play and romp on the way home after school. Thus the habit was formed of feeling joy at getting away

from studies, and the feeling of pain of many kinds was closely associated with studies. Is it any wonder, then, when the pain-technique is so common in our schools, that so few people make an effort to improve their minds after leaving them. Unconsciously, because of school-day habits of feeling, they feel uncomfortable at the very thought of study.

What has been said will give an understanding of the most important principles to be used in building new habit-systems. There are still other factors worth mentioning also, but in order that we may now take up those habits that are conducive to making and keeping friends, we shall reserve them for the next lesson.

People Like Us When We Give Them Pleasure

— What has been said about the pleasure-technique has its application also to the subject of friends. Make no mistake about this, people like us or dislike us in the first place as we give them pleasure or pain; and they continue to like us while we give them pleasure and they begin to dislike us when we give more pain than pleasure. If we are to have friends, then, we must find out what gives people pleasure and what gives people pain, and build into ourselves those habit-systems that give others pleasure.

Of all the ten groups of fundamental urges into which the desires of human life may be grouped, experiments have convinced psychologists that the power-urges are strongest. To be more specific, the unconscious mind of the average individual has a stronger desire to keep self-respect than it has for food, sex, or safety. Anything, therefore, that tends to lower an individual's self-respect is resisted violently. This resistance to lowering the self-esteem commonly takes form of unconscious fiction. People excuse to themselves their short-comings by alibis. Even the most vicious criminal in prison says to himself that others would have done the same as he if they had had the courage; or others would have done no better if they had had the same temptation and the same early environment. The ways in which the feeling of self-respect is maintained are numerous, and because this desire is so fundamental, if we are to have friends we must use care not to attack their self-esteem. On the other hand, if we can increase their self-esteem the pleasure they thus derive will tend toward a feeling of friendliness.

One of the outstanding habit-systems to cultivate, if we would have more friends, is by various means to make people feel self-important, for this gives them a distinct glow of pleasure. This feeling of pleasure is associated with us, and gives rise to kindly regard. But if we criticize people in such a way as to make them feel less important, even though the criticism is deserved, they feel disagreeable, and associate this disagreeable feeling with us.

This does not signify that we are to go about flattering people, or that we are to refrain from pointing out their weaknesses. By the use of diplomacy another person's mistake, or his weakness, may be brought to his attention in a way that does not make him feel disagreeable. If brought to his attention in such a manner as not to attack his self-esteem he will also more readily put forth an effort to correct it. For when his self-esteem is attacked, his unconscious is too busy defending itself to be able to mobilize energies to correct the matter. Then again, nearly everyone has good qualities that are really worthy of notice. If these qualities are brought to his notice in a pleasant way, not only will he feel friendly toward the person who recognizes his worth, but it gives him the high pleasure technique incentive to put forth an effort to become even more worthy of praise. It is nearly always more beneficial to a person to be praised for good actions than to be denounced for errors.

Even to attack a man's opinions inflicts pain on his ego. People are not convinced by argument; for in an argument they are so busy defending their opinion that the logic of the opposition fails to gain proper attention. When we bluntly tell a man he is wrong he resents it. But if we ask him to explain why he thinks as he does, and make it plain we understand his viewpoint, and say frankly that we have been wrong in many things and may be wrong about the matter in question, he is apt to feel pleasant, even though in the end we do not adopt his ideas. In such points as we are in error we should quickly admit it. He will feel his own self-esteem raised by being able to point out an error which we admit. And when finally we present the strongest factor that leads us to an opposite view on the significant matter, he will be inclined to be kindly tolerant, if not actually agreeing with us.

When we fail to remember an individual's name he feels that to us he does not seem important. But if we not only remember his name, but also his problems and interests, his self-esteem is raised because apparently we consider him important enough to be interested in him and his affairs. If we greet him with cordiality, and make him feel that we are glad to see him, this still further raises his self-esteem. And if we smile and seem happy, this attitude on our part brings out a sympathetic response from him. Through associating with us he takes on the quality of our feeling, and if this is joyous and genial his pleasure is increased. People are not apt to like those who seem indifferent to their existence. A warm handshake and a smile gives evidence of pleasure and interest.

As people are interested in themselves it gives them pleasure to talk about their accomplishments, their affairs and their problems. Draw them out. Let them know you are interested in what they think and what happens to them. Give close attention to their recitals. Ask questions, and make suggestions designed to be helpful. But refrain from being dogmatic. Show lively sympathy and understanding. This will raise the other's feeling of self-esteem and conduce to the pleasure of your companionship.

When people have ideas that are adopted they gain in self-esteem. Abruptly disparaging the plans put forth by another gives him a feeling of distress. But if he can be led around to believing he originated, or is at least partly responsible for, the sounder plans that are adopted, he will gain in self-esteem, and experience the feeling of pleasure. Instead of at once violently opposing some unsound plan it often is better policy to get its sponsor to talking and gradually lead the conversation around to a point where he will see, largely of his own accord, the better way, and suggest it himself.

And while flattery is reprehensible, praise, and plenty of it, where praise is due, increases the individual's self-respect, and his friendship for the one who thus increases his enjoyment.

Next to Self-Esteem People Most Desire the Esteem of Others

—Next in power to self-esteem, and activated by the same group of thought-cells mapped in the birth chart by the Sun, is the desire for the respect of other people. It is probably the most dominant motive in the commercial world. People may want money for what it will buy, but they commonly want it even more to feel important in the eyes of others. To possess wealth gives a sense of power, and is to be envied by poorer people. If one has the money, one may have just as good a car, just as fine clothes, just as pretentious a home, as one's friends. Great effort is made, therefore, to acquire these things, not because they are necessary to life and comfort, but because they permit one to mingle on terms of equality with a certain social stratum. The working man strives hard to be worthy of a raise in wages, not because his family is in actual want, but because such a raise will enable them to have things and do things that give them social prestige.

When those who employ others learn the strength of the urge for self-esteem and the urge for the esteem of others, there will be less dissatisfaction among employees. A reprimand, even when deserved, tends to attack the self-esteem. When the reprimand is given publicly it outrages the esteem of others. Nothing is so resented by an employee as to be criticized in the presence of his fellow-workers. And the circumstance that commonly he must refrain from openly defending himself makes the hurt strike the deeper. It is forced down into the unconscious, there to rankle and grow more bitter until some labor dispute arises. Then it comes to the surface in full power and expresses itself in unreasonable demands and sabotage.

Moved by the universal human urge, your friends desire to have the respect of other people. If you are able to assist them attain this great desire they are sure to warm toward you.

There are two ways in which this aim may be advanced. Primarily, of course, through encouragement and support, they may be helped to do those things that spontaneously attract the commendation of their fellow man. Thus will you be doing them a favor, and at the same time be doing something valuable for a still wider circle.

The second way is to draw the attention of others to their good qualities. As previously mentioned, most people have some very good qualities. If these are brought to the attention of others and emphasized, it increases the esteem of these others for the individual under discussion. And if he responds in the normal manner, this increased esteem of others will stimulate him to make an effort to be worthy of it.

We should not leave this subject without a few words about the person who talks disparagingly about his friends behind their backs. He loses friends, of course, and rightly so, because more often than not his innuendoes are repeated and finally get back to his friends.

He does not openly attack his friends to others. Commonly he first speaks of some good quality possessed by the friend. "Yes, John is a wonderful fellow, so fine and upright. Isn't it a shame that ..." Thus does profession of friendship end up with some subtle remark tended to injure the standing of John. What is the underlying psychological urge that causes so many people thus cunningly to undermine the esteem in which their friends are held?

There is an unconscious recognition that superiority is relative. Every individual wishes to feel himself a superior person, and he wishes others so to believe him. There is also the tendency to feel that such superiority is to be gained through competition. In the case under consideration the speaker thinks others will be apt to compare himself with John. If John is given too high a reputation, by comparison, his own reputation will suffer. He feels friendly toward John, but at the same time his unconscious urge for the recognition of others does not countenance the thought of permitting others to think John is superior to himself. Consequently, almost unconsciously to himself, whenever opportunity arises he throws out a suggestion intended to undermine John's character, and thus relatively raise his own standing. Needless to say, few people are misled by such tactics. They attribute the "catty" remark to jealousy. He has thus really lowered himself in the estimation of the very people he was seeking to impress with his superiority, and his tactics cause him to lose John as a friend.

Another fundamental urge of great strength is the desire for response. This social urge manifests not only as sexual desire, but also as the desire to have the sympathy, help, understanding, interest, and companionship of others.

If another person realizes that you are interested in him and in what he is doing, it gives him pleasure. If he feels that you have his welfare at heart, he tends to respond by being concerned with your welfare. And if you show him that you understand his problems, and his viewpoint toward life, this forms a link of attraction between you. And why should we not be interested in others? Is life so restricted that we have no energy with which to sympathize with the problems and joys of others?

We shall presently consider at greater length this primary urge for response in its intellectual aspect. But first let us glance at the physical.

Professional politicians are looked upon by most with considerable contempt. They are often out to gain their own ends by fair means or foul. But if they are successful politicians they are excellent judges of human nature and understand how to influence human behavior. They are good practical psychologists. They also depend almost entirely upon their power to make friends and to hold friends for political influence. Thus they know how to have friends.

The political boss places one rule ahead of all others. He does favors for as many people as possible. He does not hesitate to spend time and effort to be of assistance to his friends. He gets out and does something that furthers the interests of as many people, individually and collectively, as possible. His next rule is that he never goes back on his friends. Those that help him in any way may be sure of his active service or influence whenever needed.

These rules, when they are used to advance the interests of one group at the expense of other groups, are not to be commended. But they do illustrate a vital psychological principle. If you desire to have friends, do not hesitate to be of material assistance to them whenever the opportunity arises. Do not hesitate to inconvenience yourself for them. Do not consider any of their interests unimportant to you. There are a thousand little things that can be done, things too numerous to mention, but which are suggested by the circumstances, by which we can be of assistance to others. Such assistance, through tending to dissipate selfishness, is beneficial to ourselves, and it is a sure road to friendship.

Security is another strong fundamental urge of all life. In the human family it takes the form of acquiring money and property to safeguard against future contingencies. If you assist another to get better employment, to get a better salary, or in any way advance his economic situation, you have touched upon and helped him realize a deep seated desire. And because of his interest in his family, if you can conduce in any way to their security and comfort you will have rendered a service which commonly is appreciated.

In these days, however, when the lives of comparatively few people are acutely in danger from lack of food, clothing and shelter, there is another urge that experiments show to be more actively dominant in the lives of most people. Strange as it may appear at first sight, this is the urge for adventure.

The desire for new experiences, for taking risks in the hope of greater accomplishment, has evolutionary value. When areas became crowded, those who moved to new lands had a better chance to survive. When one food supply began to be exhausted, those with originality enough—as did our English sparrows—to try out and adopt a new food, fared better than the less adventurous. Pioneers in any line are those with a strong urge for adventure. If, therefore, you are able to break the monotony of other people's lives by giving them a change, through planning outings, entertainments, or other activities in which there is a trace of adventure as well as a good time in general, you will not lack friends.

Having already considered the methods used by politicians to secure friends, we should feel no hesitancy about making another excursion into the realm of less idealistic practical affairs to find an illustration. It is the custom of the managers of small town stores to go to the large cities at certain seasons to make purchases. Larger firms have special buyers, who make all the purchases for certain departments. The wholesalers and jobbers, who sell these goods to the dealer, have a strong incentive to gain good will and sell as large orders as practical to these various buyers. In fact, competition is of the keenest, and in order to remain in business they must make sales. Under these conditions of practical competition, a workable technique is sure to develop.

The worth of the product is of course played up and its price advantages. But the general practice has been, first of all, for the salesman to get the buyer in tow, give him fine dinners, take him to the kind of entertainment he enjoys, and show him something of the night life of the city. He is given a good time where his physical appetite for food is concerned. His emotions are given pleasurable outlet through attending entertainments. And finally, he is given what he considers a real adventure. He has something unusual to think about and to talk about and to anticipate until his next visit to the big city. No matter if the whole affair is quite dull to the salesman, the buyer had a good time and some real excitement. He therefore feels unusually friendly to the salesman who made these things possible, and to the extent no great loss is incurred by so doing, gives this salesman all his orders.

Occult Influences

—In general, increasing the activity and harmony of the thought-cells mapped in the birth chart by Venus and the thought-cells mapped in the birth chart by Jupiter exerts a beneficial influence upon the ability to have friends. The Venus thought-cell activity may thus be accentuated by thinking light, artistic and cheerful thoughts, making pleasant social contacts, and cultivating artistic trends with the object of getting as much cheer, amusement and pleasant emotion out of them as possible. The Jupiter thought-cell activity may be accentuated by cultivating joviality and the feeling of good will toward all, and by placing faith in a higher than human source to oversee matters beyond control.

In addition to these general measures which may be applied by all, there are more special measures which may be ascertained only from an inspection of the individual chart of birth. The most important of these measures consists of increasing the activity and the harmony of the thought-cells mapped in the birth chart eleventh house. These thought-cells, working from the inner plane, have more power than any others to attract or repel friends. If they are already harmonious, they should be given greater activity. If they are discordant they should be harmoniously reconditioned by applying the proper mental antidote as explained in Course 9.

Each planet aspecting the ruler of the Eleventh House also should be inspected; for each indicates a line of influence affecting friends that runs from the department of life ruled by that planet to the house of friends. Such lines of influence as are indicated by harmonious aspects may be strengthened by appropriate thoughts and actions, and may especially be made use of where friends are concerned. Lines of influence indicated by inharmonious aspects may be neutralized by the proper mental antidote, and the department of life indicated by such inharmonious aspecting planets sedulously avoided in all contact with friends. Thus if a planet in the Second House (money) is in good aspect to the ruler of the house of friends, and at the same time a planet in the Sixth House (work and illness) is in evil aspect to the ruler of the house of friends, money transactions of various kinds may be counted on to assist in making and having friends. Such transactions, therefore, may be sought out for that purpose; and also, by proper thoughts and experiences this influence may be built up to greater strength within the astral body. But everything to do with labor and illness may be counted on to disrupt friendship. Under such circumstances it will be unwise to employ friends, or to seek them in time of illness. Where labor and illness are concerned, it is better to associate only with those the loss of whose friendship is of no great concern. Also a proper mental antidote may be applied for the purpose of giving the discordant thought-cells more harmonious desires.

Demonstrating friendship by means of visualizing (lesson No. 67 ([See Serial Lesson Key]) has possibilities, but should be used with considerable caution; because people attracted into the life are not passive objects, but often have a power for good or ill. Be sure of just the kind of a friend you desire, and that the person has just the qualifications you are led to believe he has, before demonstrating friendship. And furthermore, that the law of compensation be not violated, be sure that the friendship has possibilities of mutual advantage.

Selecting a house number, telephone number, a name, color, gem, locality and various other objects of the environment that vibrate to the thought-cells in your astral body most favorable to friendship (Course 6) all have a beneficial influence.

Friendship of the finest type, however, is always based upon a sympathetic understanding, and a peculiar mutual exchange of ideas and energies. The type of person with whom such relations can be established may be determined from the birth chart. Those whose dominant planet is a planet sorely afflicted in your birth chart may become good friends, but will not attract to you fortunate events. Those persons whose dominant planet is a planet well aspected in your chart, in so far as you

associate with them, will be friendly disposed, and will tend to attract to you beneficial events. But something more than this is required as the basis of a high and lasting friendship. In the first place the magnetic polarity, as shown by the birth charts, must not be too diverse. Next there must be some similarity of viewpoint as indicated by the signs occupied by Sun, Moon and Ascendant, and by the ruling planets. That is, if one is naturally conservative and the other is naturally progressive, these tendencies tend to clash. But if both are interested in some subject, as if both have Mars and Neptune so located as to give an interest in aeronautics, this forms a basis of friendship. The birth charts thus indicate the possibilities of friendship between two people.

In the development of a high type of friendship, such as we are considering, a very unique and socially valuable process is inaugurated. The mind of one person quickly grasps the ideas presented by the other. He may not agree, either in whole or in part, with the other's conclusions, but he understands how and why the other arrived at those conclusions. The two minds enter quickly into that state of sympathy termed rapport, in which there is an interchange of invisible energy. The thoughts of one flow into the mind of the other, and the thoughts of the other flow into the mind of the one. Even as an individual may set certain facts within his knowledge against other facts also within his mind, so two such friends unite temporarily as one mind, yet each maintains his individuality.

Under such circumstances the thought of one often is recognized by the other before it is spoken, or before completely expressed. There is a fusion and blending of ideas based upon mutual understanding and this exchange of astral energies. But not infrequently from this exchange of ideas both come into a comprehension of the matter not only far beyond what either alone had, but far beyond the sum total of what both had. In other words, through the unseen blending of thoughts on the astral plane due to their companionship new ideas are conceived, developed in the unconscious, and finally given birth to in objective expression.

It is true that many noteworthy examples that may be cited in which schools of thought have been brought into existence, scientific discoveries made, or works of art brought to the light of day, are the result of an association between persons of opposite sex. But other notable examples may also be cited of similar results arising from the friendship of two or more men, or from that of two or more women. Thoughts are sexed, but mind itself is not. That is, its temporary polarity is determined by its thoughts, and these may be held by either a man or a woman. But whether arising from persons of the same sex, or of opposite sex, where mind blends with mind thoughts tend to impregnate each other and to undergo progressive unfoldment below the threshold of objective consciousness, coming forth later as something new and better than either is able to produce alone.

I believe that the more enduring friendships are based upon such sympathetic understanding and exchange of ideas and energies as I have mentioned. Certainly such friendships as these are those that are most satisfactory and beneficial both to the individuals concerned and to society. At least there should be a process of give and take between the minds of friends. The individual who insists on doing all the talking, who consumes the time spent together in relating his adventures, telling about his business, or pouring out his troubles, does not make a high class friend. Nor does the one who never has anything to say, who merely absorbs what is said to him. He is not a friend, just a human sponge. And the individual who just talks small talk, or on conventional topics out of politeness, has no power to hold others. There must be earnestness, mutual understanding, and a mutual contribution to common mental processes.

Finally there is the person who wants friends for but one purpose: to tell troubles to. The right kind of friends, if the friendship is well established, will not hesitate to listen to and sympathize with another's troubles. But this is a strain upon friendship, not an aid to it; for people are attracted only by what is pleasant. Troubles are unpleasant, and therefore tend to repel. Unloading one's troubles in the presence of others is selfish, and should be indulged in only on rare occasions.

If one were to summarize very briefly the rules for having friends, it might be stated that first, last, and all the time, there should be an understanding of, and a sympathy for, the other person's desires and point of view. Those things, then, that give the other person pleasure, and assist him to realize his desires, are the things which make of him a friend.

Chapter 7

Serial No. 157
Original Copyright 1944
Elbert Benjamine

Copyright
August 2002
Church of Light

How To Get Employment

Chapter 7

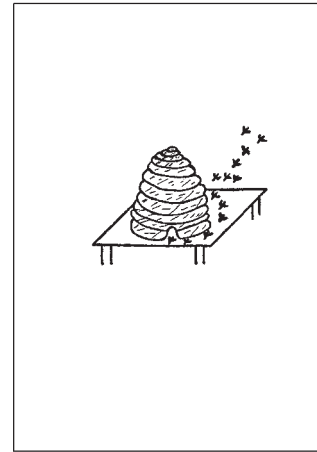

How To Get Employment

SECURING employment is a matter of salesmanship. It is based upon the same fundamental principles that underlie all salesmanship. There must be a desire, want, or need upon the part of the employer that can be satisfied by hiring an employee. If the desire is not already present, it becomes necessary to arouse it. When the employer feels this need, or it is brought to his attention, or is built up by showing him the advantages thus to be gained, it then becomes necessary to convince him that the one making application for the position can do the work in a satisfactory manner. When he becomes convinced of this, employment is certain.

Getting employment is selling one's abilities. These abilities, the impression made upon the prospective employer, and the success in every other department of life depend upon the habit-systems that have been formed. If there has been notable failure to secure employment, the remedy is not in something mysterious, but in the formation of new habit-systems that are conducive to getting employment, and to getting better employment. But to change the life markedly in this or in any other respect, not only must the objective behavior be altered, but new thought-cell habits must be formed.

Thought-Cell Habits Determine Both the Fortune and the Specific Nature of All Events that Enter the Life

—The planets in the birth chart merely map the volume of energy of each of the ten types of thought-cells and the trend of their desires derived from experiences in lower forms of life. The departments of life with which they were formed and relative to which they tend to express are indicated by the houses a planet rules. But in lower than human forms of life, while there were experiences of the Mercury type involving the use of intelligence, there were no experiences with bookkeeping or as a telephone operator. There undoubtedly were experiences with offspring, ruled by the fifth house, but none with stage and screen which also are ruled by the fifth house. In

other words, the desires and therefore the activities of the thought-cells at birth, even though harmonious or discordant, characteristic of the planet mapping them, and associated with definite departments of life were undifferentiated in so far as desiring events which are exclusively probable to human beings.

The activities of these thought-cells are chiefly responsible for each event entering the life. They not only influence the thoughts and the behavior, but work from the inner plane to bring into the life such events as they desire. But other than always desiring and expressing the characteristics of the planet mapping them, and always desiring the events of, and expressing through, one of the various departments of life the houses of which the planet rules, what they desire is mostly determined by the manner in which they have been conditioned by the environment since human birth, that is, by the habit-systems they have acquired after the infant was born.

And these habit-systems, whatever they may be, are subject to alterations, just as the behavior and thought habit-systems of the individual can be changed. The energy of a highly active group of thought-cells cannot be repressed. The attempt at repression merely causes it to utilize its energy working from the inner plane to bring the event it desires into the life. Nor can the thought-cell activity mapped by one planet be made to express through thoughts, behavior or events attracted characteristic of some other planet. The problem is, therefore, to form habit-systems of thought and behavior that will permit each powerful group of thought-cells to express its characteristic energy beneficially.

SUN: These thought-cells desire that the individual should have significance. In the effort to attain significance they may cause him to disparage others, to be dictative, to boast, to be a show-off, to do anti-social acts to attract attention, to develop an inferiority complex or a superiority complex, to refuse to speak or work before the public because of fear he will not live up to an exalted opinion of himself, or they may cause him to have difficulty with authority. Instead of these expressions the individual should set about resolutely and intelligently to acquire and use some knowledge or ability that he can employ in the community where he lives, or expects to live, that will secure the esteem of others, or at least through benefitting the community, increase his own opinion of himself. He should acquire the habit-system of doing something beneficial to society in which he can take pride, be firm in its accomplishment, and feel joy in the self-approval engendered.

MOON: These thought-cells desire that the individual should have home and offspring. They may cause him to be so interested in the private lives of others as to be a gossip, or they may express through the effort to gain notoriety, through incessant change, or through changing moods and mental instability. Instead of these expressions the individual should cultivate domesticity and develop a habit-system in which he is active, and experiences delight, in music and in contributing to the comfort of his family or to the welfare of the old or young who are helpless.

MERCURY: These thought-cells desire intellectual activity. They may find expression in nervousness and restlessness, or through an incessant flow of thoughts or words which accomplish nothing. Instead, the habit-system should be cultivated of finding pleasure in concentrating on whatever situation is present, or analyzing carefully all its factors, and of thinking it through with the object of ascertaining how best it may be handled.

VENUS: These thought-cells desire affection, companionship, and the beautiful. They may find expression through licentiousness, through pliancy, through love of ease, or through unwise or unrestrained emotion. Instead of these expressions, the habit-system should be cultivated of getting pleasure from healthful social contacts, musical entertainments, appreciation of the artistic, mirth, and wisely directed affection.

MARS: These thought-cells desire aggressive action. They may express through anger, harshness, irritation, quarrelsomeness, haste, undue expenditure of energy, lust, or destructiveness. Instead of these expressions, the habit-system should be cultivated of taking pleasure in building something. Initiative and courage may be used to repair a human body, to build a business, or to construct a machine.

JUPITER: These thought-cells desire joviality and abundance. They may express through extravagance, sportiveness, conceit, or undue optimism. Instead of these expressions, the habit-system should be cultivated of taking pleasure in benevolence, devotion, faith in a higher than human power, and in maintaining the attitude of good-will toward all.

SATURN: These thought-cells desire safety. They may express through greed, self-centeredness, worry, fear, sorrow, despondency, or envy. Instead, the habit-system should be cultivated of taking pleasure in order, system, organization, efficiency, persistence and the carrying of responsibility.

URANUS: These thought-cells desire originality. They may express through eccentricity of dress, of action, or of opinion, through abruptness, or through extreme views and the effort radically to change whatever may be the existing condition. Instead, the habit-system should be cultivated of taking pleasure in research and invention and in encouraging reformation that advances one step at a time.

NEPTUNE: These thought-cells desire the ideal. They may express through day-dreaming, through unsound schemes, through over sensitivity, through wishful thinking, or through vague longings. Instead, the habit-system should be cultivated of taking pleasure in using the imagination for some practical and constructive purpose. Almost anything can be dramatized in a manner that will increase its value.

PLUTO: These thought-cells desire cooperation or coercion. They may express through uniting with others in anti-social activities, through coercing others, through selfish use of psychic energies, or through inversive methods. Instead, the habit-system should be cultivated of taking pleasure in cooperating in activities that benefit society, and in developing true spirituality.

Forming New Habits

—As the habits of thought, the habits of feeling, and the habits of action determine what happens in our lives, let us now further consider how they may be changed in the direction desired. After which we will be in a better position effectively to adopt the plans indicated for securing a lucrative position.

The first thing, of course, is to decide, after due deliberation, the exact nature of the new habits to be formed. No attention is to be given bad habits. They are to be eradicated by the formation of new ones that automatically turn their energies into more constructive channels. Next, some method should be adopted to insure that the new habit will be remembered at the time it should function. It takes unusual effort to remember to do something that we are unaccustomed to do. At the time it is important we are very apt to forget that a new habit has been decided upon and proceed in the channel of the old habit already well established.

By the use of effort and repetition, the thought of the new habit may be linked up with any one of the numberless acts which we perform that require no especial effort to remember. When we leave the office or shop at the end of day, it requires no effort to remember to take our hat from the rack before going home. It may require considerable effort, however, to remember to go into an adjoining room and close the windows, or each evening to leave certain papers on the boss' desk, or to ring up and ask what shall be brought home for dinner. In fact, the more disagreeable the task and the farther removed from notice, the easier it is to forget it.

But if, when placing one's hat on the rack one resolutely determines to remember the disagreeable detail when the hat is removed, the moment the hat is picked up this other less familiar matter will be remembered. For the first few times considerable resolution and intensity of feeling should be experienced in determining, as the hat is placed on the rack, that the detail will be remembered when the hat is removed. But after a few evenings on which the new habit to be formed is remembered when the hat is picked up, the two actions become so strongly welded, through the law of mental association, that thereafter every time the hat is removed from the rack the thought of the new habit pops into the mind.

Every individual has numerous habits that are already well formed, and on which he can count for some degree of regularity, to which he can tie new habits in such a way that they will be remembered. We all eat at certain intervals, we go to bed, we arise in the morning, we go to work, and perform various other routine acts, to any one of which by a little effort we can link up the memory of some other act to be done. In lesson No. 152 (See Serial Lesson Key) there is given an illustration of binding the remembrance to do something, by means of an affirmation, with the act of eating.

Certain attitudes of mind, and certain types of behavior, may be desirable only in the presence of certain persons. In such cases, then, after determining the habitual attitudes and behavior to be cultivated, the effort should be made to affiliate strongly the thought of the habit with these persons, so that the habit is always brought to mind when in their presence. In some such manner every habit to be formed should always, even at the expense of great pains, be so firmly related to older habits that it is always remembered at the time when it should function.

One New Habit At a Time

—Usually, when there is the desire to replace bad habits by better ones, the impulse is to make a thorough job of it, and carry the reform into all departments of life. Such an attitude is excellent. Thus you may, after reading this lesson, decide to adopt and build into your life as habits, the actions, thoughts and feelings here advocated as lending themselves to better employment. If such a resolution is made, or if a resolution covering any other series of habits is made, it is well to write out on paper, for your own reference, just what these new habits to be adopted are.

But it is decidedly unwise to try to cultivate them all at once. To do so violates one of the fundamental principles of psychology; the principle that the range of attention at any one time is very limited. The energies cannot be directed efficiently into numerous channels at the same time.

Even in learning to use a machine, the best way is to practice each separate operation by itself, taking up a new one only after the first is learned so thoroughly as to become established as a habit. When two or more operations learned separately become habitual, they may then be joined as a series; or when the first operation has become habitual, the second may be learned as an additional part of the first, and later the third added to this, until the whole complex process becomes practically automatic.

To establish any new thought, new feeling, or new action requires that the objective attention be directed to it persistently. This takes an unusual amount of energy and effort. Most of us do not have the energy at our command thus to establish more than one new habit at a time. Each repetition makes the use of voluntary attention and conscious effort less necessary, until after a time all we have to do is to think of the thing and it is accomplished, almost no effort or energy being necessary to initiate the process. It has become habitual.

It is all very well, therefore, to outline a series of new habits to be formed; but it is psychologically unsound to learn them all at once. They should be taken up one at a time and mastered in single combat. Not until one has been made obedient should the next be engaged. When two have been vanquished the third should be challenged, and so on, until the whole company of desirable habits is under full control. Do not battle with the whole regiment at once. Even taken one at a time they are full worthy of your metal.

Another well recognized psychological law that we may take advantage of in establishing new habits is that the ease with which an action is repeated depends upon the vividness of the previous performances and the amount of repetition. Much, therefore, depends upon making a strong start. Not only should the matter be thought about thoroughly when initiating the habit, but as many precautions as possible should be taken to insure that the action is not neglected. Tell your friends what you intend to do, so that your pride will reinforce your resolution when tempted to neglect the matter. Devise means to make the performance of the habit easy, and to make its non-performance both difficult and disagreeable.

Having given the habit a good strong start, while there is still enthusiasm about it take the opportunity to put it into practice. If the opportunity is not at hand, seek out the opportunity. Resolutions have

a way of evaporating in a short while. To guard against this, find some method by which the habit may be given exercise without delay, and see to it before the enthusiasm subsides that it is given much repetition.

Visualizing the Interview

—In lesson No. 156 (See Serial Lesson Key) the formation of habits has been compared with the making of trails through the deep snow of winter. Every time we pass over a new trail, and every time we repeat a new habit, the easier it becomes. But if the trail is new, and not well broken, there is always the temptation to take the old and easier way. In habit formation, in so far as possible, this should be guarded against.

Suppose you desire to cultivate the habit of selling your ability. In the past it has been the habit merely to ask for employment, and if you were not hired on asking to walk away. You have resolved, therefore, to proceed in a very different manner. You realize, however, that the old trail will be much easier to follow, and that unless well prepared, you will merely ask for employment, and if refused will walk away. Therefore, in preparation for breaking the new trail you rehearse over and over again the anticipated interview. You visualize, as accurately as possible, the man to whom you will address yourself and the environment where you will talk to him. Imagine yourself ushered into his presence and starting the conversation, perhaps something after this manner: “Mr. Jones, I do not wish to intrude on your time unnecessarily, but I feel it will be to your advantage as well as to my own for me to explain why I should be working for you.” Then, in imagination, proceed with the interview, explaining in detail to Mr. Jones just why you are particularly qualified to fill some position with his firm.

Such a carefully visualized rehearsal begins to break the trail for a new line of conduct, reinforces the determination to break this new trail instead of following the old one, and in addition, through picturing the result, adds a psychic power that lends its weight to a favorable issue.

Stubborn Habits

—Where the habit to be discontinued, through the substitution of a new one, is a particularly stubborn one, a change of environment often is beneficial. For instance, it is exceptionally hard to break the liquor habit while continuing to associate with drinking companions.

No doubt most people could get the equivalent of a college education by means of home study. But the environment of home study does not contain the factors that reinforce the student's determination to study, as does the college. Acquaintances have been informed that one is going to college, and to fail to make progress would seem a disgrace. At college one is a member of a large group, all bent on getting an education. By the members of this group, to study is considered the proper thing. One loses caste if he fails. In fact, pressure is brought from so many quarters to induce one to study, that it is commonly much easier to get one's lessons than to face the numerous disagreeable consequences of not getting them.

But with home study usually there is no such pressure in the direction of learning, but a multitude of distractions, so that it is only the unusual person who has determination enough to get a good education without attending school.

Will Power

—Will is directed desire, but the will only accomplishes results when expressed in action. If, therefore, a person has formed the habit of carrying out his resolutions, he is considered a person of strong will power. But when a person decides to 'do something, and then fails even to make a vigorous attempt, he is conceded to be a person of weak will. Will power, it will thus be seen, is always associated with certain habits of action. To be a person of strong will is to be one in whom the habit has been formed of carrying out one's decisions without fail.

When a resolution is made, and it is not carried out, it weakens the will. Due care, therefore, should be exercised, as previously mentioned, not to undertake too much. Furthermore, when a resolution is made, every exception allowed weakens both the will and the new habit. The person who quits smoking, but who thinks just one more cigarette doesn't count, quickly slips back into the old habit. The old trails through the snow are so easy to get into again. Therefore, in forming a new habit take particular pains that there are no "exceptions" in which the old habit to be displaced is allowed to function.

Correct Every Lapse

—Sometimes, in a careless moment, or under unusual pressure, or preoccupation, the old habit may slip by the guard. In such cases do not let the transgression go with little notice. In each and every such case, take time and effort to do the thing in the right way. If the old habit is an exaggeration, whenever one is conscious that something has been a bit exaggerated in the telling, see to it that the impression given is fully corrected, and that those to whom it is told are given an uncolored version. If the old habit is that of speaking sharply, see to it when you speak sharply to a person that you offer apologies, or express kindness, as soon as you realize what you have done. Let no exception to the new habit arise, in so far as possible; but if unwittingly the old habit does function, make as complete and as prompt a correction of it as circumstances will permit.

Persuasion is Superior to Force

—Right here is the place to mention another psychological law: When one forces one's self into a course of action it sets up conflicts between different sections of the mind. When, because we are stronger than another, we compel him to do something that he resists doing, we have alienated him. Instead of cooperating with us, he is rebellious, and whenever opportunity arises, will cause a disturbance. Likewise, whenever one section of our mind is bent on not doing something, but is overpowered by another section of the mind, and compelled to action, an antagonism is set up between these two sections of the mind that may be lasting and that may lead to serious consequences. There will be more said about these inner conflicts in subsequent lessons. Here it is enough merely to indicate how they arise, and that, like warfare in general, they lead to loss of efficiency, and to discords that attract destructive events.

Do not compel yourself to do something that you intensely dislike to do. Instead, learn to like to do it. And in dealing with other people the same principle holds.

The effect of the stringent prohibition laws that came into being during World War I well illustrates this psychological law. A majority of the people, by means of legislation, forced prohibition on a large and unwilling minority. Being bludgeoned into prohibition, this minority staged a surreptitious revolt against this law. As a consequence there was not only more drunkenness and liquor traffic but a crime wave of greater proportion, than the country had ever known.

So also, if you bludgeon your own mind, or a section of it, into the acceptance of some course of action, it not only revolts and tends to interfere whenever possible with carrying out this action, but the discord engendered spreads, and unpremeditated actions regarding other things, and annoying emotions, are the result.

About everything imaginable there are many points of interest. A little analysis will discover these interesting qualities, and interest is akin to attractiveness. Many things that are otherwise disagreeable may be made pleasant by imbuing them with an element of competition. Timing one's performance against that of another's, or against one's previous record. Comparing the perfection of the product with that of another, or with one's past performance. Undertaking to find a new and better way to do one's work. Reading up on everything connected with the matter. These are but a few of the ways by which interest may be made to breed attractiveness.

No matter how dry-as-dust a subject may be, if one becomes an expert in it there is a glow of satisfaction, a pleasant knowledge that one is its master. Thus one may utilize the Drive For Significance in learning to like some particular work. Let one think of the pleasure of being master of some performance, of conquering it, even though at first it appears most distasteful, and before long, if this attitude is held, the joy of mastery becomes greater than the original aversion.

Often it is possible to build up a bond of association between the disagreeable thing and some cherished ambition. Look at it not as a disagreeable duty, but as a step gladly taken, even though it is accompanied by suffering, because it leads to the desired goal. At other times the matter at hand may be linked, through the use of the imagination, with some joyful past experience. If, when undertaking the disagreeable task, one thinks of the pleasant experience, and feels the thrill of it, in time this pleasant emotion will become so associated with the task that there will be more joy felt whenever the task is thought of, or is accomplished, than aversion.

In lesson No. 156 (See Serial Lesson Key) it was mentioned as one of the three fundamentals of habit-formation *that one should always associate the desirable habit as strongly as possible with feelings of pleasure*. Only a few of numerous ways by which this may be accomplished have been mentioned. By following this plan no part of the mind is forced to accept the new habit. Instead, an appeal is made to pleasure, and as this appeal becomes successful all parts of the mentality not merely acquiesce in permitting the new habit, but unite in a desire for its continuance. Such a process, instead of breaking up the mental elements into warring factions, unites them in a common desire, and in cooperative effort. Instead of conflicts, harmonious integration is present, and these harmonies, in addition to reinforcing the new habit, have a power of attracting good fortune into the life.

This matter of avoiding conflicts is also very important in breaking a strongly entrenched undesirable habit. Such a habit is an acquired tendency to act in a certain way under certain circumstances.

Let us suppose, for instance, that a person is addicted to coffee drinking, but has found it detrimental, and desires to stop. Now, because of habit, whenever he has meals the desire for coffee is very strong. He may, of course, just stubbornly refuse to yield to the desire. But if he handles the matter in this way, and the desire is insistent, he may develop a feeling of irritation that lasts all day. Of course, if all the important

elements of his mind have accepted the desirability of avoiding coffee to such an extent that he no longer feels an urgent desire for it, the idea has become integrated with the other mental factors, and no conflict results. But if the desire continues, it may prove very annoying.

To avoid this conflict *a new outlet must be provided for the old habit*: That is, not only should a new habit be formed that will take the place of the old habit, but it should be of such a nature as to pacify rather than conflict with the old habit. The coffee drinker will escape such conflict if he for a time, until the desire has grown weak, uses some coffee substitute. The cigarette smoker will find it easier to break the habit if, when he desires a smoke, he takes a chew of chewing gum. The outlet of the habit is thus not completely and abruptly blocked, and its energy finds a way of expending itself without breaking through in disintegrating channels.

In this lesson, and the preceding ones, much has been said about habits. But when we stop to think that what a man is depends upon his habit-systems, and that he is a success or failure in any particular department of life, or in all of them, because of his habits, it seems difficult to over emphasize their importance. Furthermore, if we are to bring changes of consequence into our lives, it will be through changing some of our habits. The general trend of our fortunes will alter very little while our habits are the same. The lessons of this course tell how to attain various worth while ends, but these ends can only be attained through the cultivation of appropriate habits.

Employment

—When one works for another there are three distinct factors that need to be considered:

1. The workman and his desires. 2. The employer and his desires. 3. The work itself.

It should be the desire of the workman to secure such employment as will enable him to do most for himself and most for society, of which he forms a part. In lesson No. 151 (See Serial Lesson Key) we have already considered in some detail the factors that should govern the selection of a vocation. Briefly, these factors combine the natural abilities with the most harmonious influence in the life, as revealed by the birth chart.

One who is already of mature age, without a knowledge of astrology, can analyze his past performance in various lines and get a fair estimate of his abilities. And this is very important. But as indicated in the lesson mentioned, aside from ability, one may attract fortune or misfortune in a particular line, and this may be of even greater importance than ability. As this is written, for instance, the newspapers are full of the first great commercial air disaster of a trans-continental airplane. The T.A.T. air liner, on its regular run, encountered a storm and ran into the top of a mountain near Grant, New Mexico, killing the pilot and his seven passengers.

Because this same pilot had made successful trips over this same route, and because he was chosen to fill one of the most important positions open at this time to an air pilot, there is no doubt that he was an aviator of unusual ability. Yet in spite of this, it would have been better for him and for the seven passengers if he had never taken up flying. Some other pilot with much less ability, but with luck enough not to chance in the vicinity of this mountain when blinded by the storm would have come through safely.

Analyzing the Field

—It may be, and often so happens, that one is unable to get at once into the kind of work one would prefer. It is a good plan, therefore, carefully to analyze to what extent the abilities may make one fit for various other forms of work. Also, from the birth chart, one should decide what kind of fortune may be expected in each. In these lines, which because of necessity may be temporarily entered, not merely the amount of remuneration should be considered, but also the opportunity presented in each leading to the most preferred work.

One should not expect to get employment merely because one wants it, or because one wants this particular kind of work. Those who hire help do not do so merely as a favor to those who want work; they do it because they are convinced it is to their advantage.

If you are going to get work, the person who hires you must believe that you will prove of value to him. If he does not already believe this, before you get the position you will have to convince him of its truth.

The workman looks at a prospective job from the standpoint of what he will get out of it. The employer looks at the job from the standpoint of what the employer will derive from it. The common meeting ground is the work itself. This work when accomplished should not be merely satisfying to the employer, nor merely satisfying to the workman, but should result in the satisfaction of both. In so far as it falls short of this mark the position is a failure.

After you have thoroughly, and in detail, made an analysis of your qualifications for various sorts of work, the next step is to give just as thorough an analysis of the possible opportunities to utilize these abilities. The entire field of possibilities should be gone over and given a rating, and to make the matter clear it is well to write out on a sheet of paper the various possible positions in the order of their preference, placing the most desirable one opposite number 1, the next most desirable opposite number 2, and so on.

Marketing Service and Ability

—Employment, like salesmanship in other fields, is at different levels. And it should never be lost sight of that getting employment is an act of salesmanship, and governed by all the rules of salesmanship in other lines. It is the act of selling one's abilities and labor.

At its lowest level of salesmanship, the one desiring employment depends entirely upon the initiative of the prospective employer to hunt him up and secure his services. If the desire, want, or need of the employer is insistent enough, and the difficulty in procuring help great enough, he will put forth much effort, and may find and employ such a workman.

So also, if we have a great desire for an article of merchandise, we will probably go to the different stores and ask if they carry it. In such event, the merchant possessing it will make a sale even though the article is tucked away out of sight. But if another merchant has displayed the article, when we need it we will go to him rather than to the one who has kept it hidden, because we know the former can satisfy our desire, but are uncertain if the latter can. Likewise in marketing service and ability, unless by some means we inform prospective employers about our ability and willingness to work, if there are places where they know help can be hired they will not go to the trouble and search us out but, as is natural, will satisfy their need through the easiest channel.

Unfortunately for the person desiring work, it is usually so easy for the employer to find those who meet his requirements that few positions are filled without at least some effort on the part of the prospective employee.

A great deal of work is to be had, however, with very little salesmanship. That is, the employer has a well defined and well recognized idea that he should hire help, and a rather definite idea of the kind of persons that will satisfy this need. Under such circumstances, all the prospective employee has to do is to learn about the employer's need for help, and ask for the position.

For the better types of jobs, however, employers are apt to be more particular. The employer here considered has a definite program of work to be accomplished, but is in doubt as to the person best able to perform it. To obtain such a position, one should not only have the ability to fill it, but must in some manner be able to convince the employer not only that one can fill it, but can do so in a manner more satisfying than can any other probable or actual applicants for the place.

On a still more difficult level are those employers who do not know that they need help. Before they hire assistance they must in some manner be convinced that additional personnel will be to their advantage, and that the person making application can fill the position satisfactorily. Employers are not omniscient, nor do they always have time or ability to know all that should be done to make their

enterprise a success. Very frequently a careful analysis by another will reveal where an additional person can be employed with considerable profit to the concern. And where such a situation is observed the person making the discovery need not feel diffident, although he may need to use tact, about placing the idea before the prospective employer. In other words, for those who can see possibilities, there are opportunities to make jobs.

If you seek a job, whether the position is to be had at a low level of effort or at a high one, you should know as much as possible about just what the requirements are to satisfy the desires of the employer. Or if the prospective employer has no desires about the matter, you must build up those desires by pointing out advantages and then showing him how to gain them.

Planning the Interview

—Before selling the employer the idea that you will prove advantageous to him, in some manner you must gain an audience and attract his attention. Considerable ingenuity and tact may be necessary to get into the employer's presence without causing ill will. Sometimes a mutual friend, or one already employed, can be induced to give an introduction. This is advantageous, as it tends to show that others have confidence in you. You should not, of course, take too much of the time of a busy executive. But when it is considered that you are really endeavoring to render him a service, there need be no hesitancy about approaching him and using so much of his time as is necessary to sell him the idea that he should hire you.

Remembering that you are hired to satisfy a certain need, everything should be done to convey the idea that you can successfully fill the need. To begin with, personality is a very important thing in all human contacts. Try, therefore, to create a pleasant impression. Find out as much as possible about the employer. If he has some particular interest, either in regard to his work or a hobby, some brief inquiry about it is an excellent move to pave the way to the main issue. If he likes you, he will be much more apt to hire you than if his first impression is one of distaste.

But mere attractiveness is not enough. You must create the impression that you can successfully fill the place. If, therefore, you wish a job as a mechanic, dress the part and act the part. Do not dress like a dandy and expect to be hired to do heavy or dirty work. On the other hand, if seeking an office job, pay particular attention to the neatness of your appearance, because this will create an impression that you will be neat and orderly in your work.

When you approach the prospective employer, do so with confidence. Faith is the basis of all business relations. If you have confidence in yourself, this feeling of confidence will be imparted to the other person. Also, it acts as a suggestion to the other person that he will hire you. And it is your task to offer him as many suggestions and reasons as possible that he will be greatly benefitted if he takes you into his service.

If opportunity arises for you to do so, you should study the things he individually likes and dislikes in his help, and should suggest to him in some manner that you have the desirable traits. But if such an intimate knowledge of his peculiar bias is not to be obtained, at least there are some qualifications that appeal to nearly all employers, and each of these points should be brought up.

First of all, of course, is the ability to do the work. Then the matter of reliability and steadiness. Interest in the work, and team spirit should be stressed. And the ability to cooperate and get along well with others.

It is a good plan, either by consulting a directory or by other means, to get as large a list as possible of the places you would like to work, and for which you have qualifications. Write this list down in black and white, and make it a point to visit all of these places unless hired. Sometimes a well written letter, stating your qualifications and desire for the position, sent to a list of firms will bring a satisfactory reply from at least one. The same letter, of course, may be sent to the whole list. But a letter, as a rule, is less effective than a personal interview.

In all salesmanship it is recognized that if the regular sales talk fails, an added incentive introduced at the right time often makes the sale. Many a person badly needing work, when the employer hesitated, has volunteered to work a few days or a week without pay to demonstrate his work, or has volunteered to work, and for a time let the employer pay him what the latter thought he was worth, no salary being agreed upon. Also, as in any other sales work, do not take no for an answer as long as there is any chance of making the reply favorable. Persistence and determination have won many a conference that seemed hopeless.

Applying For the Job

—Plan the interview ahead of time. Know as much as possible about the work. Know as much as possible about the personal leanings of the employer. Visualize the interview over and over before it takes place. Undertake both by statements and suggestions to build up the desires of the person interviewed to hire you. Appeal to the things you know he likes, to the things that are to his advantage, to the gain you will bring him. And when you have made an appeal regarding a certain advantage to him, back it up with proof. Do not merely tell him you can do the work well, but tell him you have had definite experience with such work, or with other lines, that fits you for the position, and when possible give references. Do not merely tell him you are steady help, tell him how long you worked with some other firm.

Know beforehand just what you are going to say.

Hold his attention while you say it. Do not over state your case, as exaggeration causes loss of confidence. Have confidence you are going to be hired. And after you have, to the best of your ability built up his desire to employ you, do not fail at that point to ask him for the position. Tell him without quibbling that you believe he will benefit by hiring you, and that you want the place. Do not take no for an answer. If he hesitates, have in reserve and give him some additional reason or incentive. Get a definite answer while the force of your talk is still in his mind.

And when you get the position, see to it that you fulfill his expectations.

Occult Considerations

—The advisability of visualizing the interview in which employment is to be obtained has already been mentioned. It is also advantageous to visualize yourself working in the desired occupation, just as you would be working when hired. Hold the picture in the mind as steadily as possible and with the feeling of full confidence that you will thus be working at no distant date. Do not try to visualize at this time the steps necessary to obtain the employment. Picture the work and yourself employed at it as vividly as possible. Feel confident that this picture will come true. Feel as you would feel while doing the work. Make it as real in every way as possible. Affirm to yourself, “This Is My Work.”

The powers of the soul are very extensive, and such visualizing and suggesting directs its attention and energies toward bringing about the condition held thus before the mind. The soul has psychic senses which it employs to get information quite outside the range of any physical perception. And it uses, when properly directed to do so, and without the knowledge of the objective mind, numerous invisible energies for the attainment of its ends. Thus through visualization, it is possible to demonstrate employment.

Other invisible energies flowing from the planets also have a pronounced influence upon the times when it is easy and the times it is hard to get employment. The progressed aspect most favorable to employment is a harmonious aspect to the ruler of the birth chart tenth house. Next best is a harmonious aspect to the ruler of the sixth house. At the time any important position is secured there is always a progressed aspect to the ruler of the tenth and a progressed aspect to the ruler of the sixth.

Adding pleasant energy, through appropriate thoughts, to the thought-cells mapped by the tenth house, and to the thought-cells mapped by the sixth house, assists markedly in getting and holding a satisfactory job.

On a day when the Moon is shown in the ephemeris to be making good aspects to the Sun is in general a good day to ask for employment; but on a day when the Moon makes adverse aspects to the Sun, employers are less favorably inclined to hire help. That hour of the day ruled by the Sun, or the hour ruled by Jupiter, is a good time to ask for work; but when the best planet in the birth chart is known, the hour of day ruled by this planet is even better. These planetary hours are explained in lesson No. 92 (See Serial Lesson Key).

Chapter 8

Serial No. 158
Original Copyright 1944
Elbert Benjamine

Copyright
August 2002
Church of Light

How To Make Money

Chapter 8

How To Make Money



ONE way and another occult forces enter so importantly and so persistently into all considerations influencing the ability to make money that it seems advisable to consider some of them at the outset. They are really the first things that should be studied in every effort to make money. There are other considerations also, which we shall take up later, but our best course is first to take up the occult factors.

To begin with it should be recognized that ability and brains are a great asset in making money, but that they do not insure it. If brains and ability measured accurately the amount of money attracted, the managers of our great corporations, many of whom are not wealthy, would possess a large share of the money now owned by opulent stockholders. Some of the latter have inherited their wealth, some of them have acquired it through speculation, some through taking advantage of opportunities that came their way with no great effort on their part, and some through intelligence and effort.

It is true that Mr. Baker, Mr. Ford, Mr. Rockefeller and Mr. Mellon, accredited with being the four richest men in the world during the third decade of this century, were all outstanding in their intelligence and unusual ability. But by consulting a list of the approximately 35,000 millionaires (30,295 in 1927) in the U. S. it would be as easy to name a hundred with mediocre intelligence and ability. In Chicago alone in 1927 there were 152 women each worth a million or more. Only 43 of these at that time had husbands. There is no implication that women have less ability than men, but that fewer of them who are wealthy take an active part in the management of business. In 1927 there were seven persons in the U. S. with an income of over \$5,000,000 a year, and 207 who had an income of over \$1,000,000 a year. And not all of these were exceptionally bright by any manner of means.

Some of the most brilliant business men the country has known were completely wiped out by the financial crash which commenced in November, 1929. Others have been ruined by different unforeseeable disasters. A new invention sometimes makes obsolete a process upon which an entire business depends. A crop failure, a flood, or other results of natural causes may depress buying power in a certain section to an extent where its best merchants fail. The sudden outbreak of war, with inability to make anticipated shipments left many a man with merchandise on his hands for

which he had gone in debt and for which under the circumstances he could not pay. Likewise the sudden end of World War I, with its almost universal cancellation of orders, broke many a good business man.

On the other hand, how much business ability had the Cherokee Indians on whose lands in Oklahoma oil was discovered? Yet many of them were made millionaires. Or the man, known in every city, who with no thought for the future other than to have a home, bought property that because it chanced to lie in the path of municipal development, in a few years became immensely valuable. But why multiply instances? Everybody knows someone who in spite of himself, and with no special effort, has become wealthy.

The explanation of this lies in the extra-physical power of the thought-cells within man's astral body. These thought-cells have been built by experiences before human birth. These experiences, and experiences after human birth, have endowed them with energy and given them desires. They work from the inner plane with such energy as they can acquire to bring into the life the conditions and events, including abundance or poverty of money, that they desire.

This merely means that the thought-cells within man's finer body have a limited intelligence and exercise the same kind of power that man can use. In Lesson No. 151 (See Serial Lesson Key), I have mentioned the university proof of extra-sensory perception, including knowledge of the future. But side by side with the vast number of experiments on extra-sensory perception conducted at Duke University, other experiments on the influence of extra-physical power over physical objects have there been conducted. The first paper setting forth these numerous experiments, and the conclusions derived from them, appeared under the names of Louisa E. Rhine and J. B. Rhine in the March, 1943, issue of *The Journal of Parapsychology*. Quoting one paragraph from the introduction:

“Now, however, there are reasons for going ahead with the task of reporting the findings. There have been during the years since 1934, a long time for careful consideration of the results and for many repetitions of the experiments. The findings have been confirmed again and again by many careful experimenters working independently. It, therefore, appears reasonable to hope that altogether we have taken most of the risk of error out of the research before it is offered to a wider audience.”

The experiments as conducted were to determine if by mental power alone, Hand-Thrown and Mechanically-Released dice could be influenced in a predetermined way. The conclusion of the article starts with this sentence:

“At the end of the first PK report, we have to conclude that we know of no better explanation for the result of the tests in dice-throwing herein described than that of the PK hypothesis; i.e., that the subjects influenced the fall of the dice without the aid of any recognized physical contact with them.”

What these scientists now call the Psychokinetic Effect, or more briefly, the P.K. Effect, is identical with that which occult students term extra-physical power. The last paragraph of the report concludes:

“Mention was made of a long series (twenty-four at the time of writing) of similar reports in manuscript form to be published in due time in these pages offering the work of sixteen experimenters, not only confirming but extending the PK research along a number of lines. It is suggested that these will be important in any final decision on the question of the occurrence and nature of the PK effect.”

The power by which an individual can influence mechanically-released dice to turn desired numbers up, and the power by which the thought-cells within man's finer form can influence the events which come into his life, relate to energy fields. But that which is here of interest to us is not the explanation of how the effect is produced, but that they are produced, and that people born with powerful thought-cells harmonious to wealth attract wealth, and those born with thought-cells discordant to wealth repel wealth.

This information would be scant consolation to those whose thought-cells do not work for wealth if nothing could be done about it. But fortunately here, as almost everywhere, an undesirable condition can be remedied provided sufficient information is at hand. And in this case the information is available.

The Birth Chart is the Key

—The birth chart is the key to the situation; for it maps accurately the thought-cells within the astral body, indicating the power of each group, and whether and to what extent each exerts an attractive or a repellent force where wealth is concerned. Each planet in the chart corresponds to some natural source of wealth. That is, each group of thought-cells in the finer body mapped by the position of a planet in the chart, exerts extra-physical power toward some wealth-producing resource. In proportion as the group has energy it tends to attract this particular wealth-producing resource, or condition of the environment. But whether wealth results from contact with this resource or environment depends upon whether or not the thought-cells which attract it have harmonious or discordant desires. To the extent the thought-cell group is powerfully discordant will loss of wealth occur. But to the extent the thought-cell group is powerfully harmonious in its desires, wealth will be forthcoming. This is the law.

A consideration of this law might prove disheartening to one unfortunate in financial matters were it not that these thought-cells are not fixed and immutable in the harmony or discord of their desires. And furthermore, one who understands the law is not compelled to associate with types of environment and natural resources that correspond to discordant thought-cell groups within himself, but can intelligently select those that have, for him, the utmost in wealth-attracting facilities.

The first thing that should be thoroughly understood is that one cannot make money from those things that astrologically correspond to discordant groups of thought-cells within his astral body. A careful study of the birth chart will reveal which thought-cells were discordant at birth, and probably remain so unless a systematic effort has been made to change them. To make money from the things indicated by the astrological factors mapping these thought-cells would require that the desires of these thought-cells should be reconditioned. It is possible, within limits, to do this, but it usually is far more profitable to devote the energy among those things toward which from birth there have been powerful and harmonious thought-cell desires.

The greatest wealth-attracting resource and environment is indicated by the best planet in the chart of birth. The greatest wealth repelling resource and environment is indicated by the worst planet in the chart of birth. To make money, therefore, one should avoid, as much as possible, those things ruled by the worst planet in the birth chart, and one should associate as persistently as possible with the various things ruled by the best planet in the birth chart. This rule should be followed not merely in regard to the articles handled in the business or occupation, but also followed, as far as practical, in the selection of a location and minor associations; for localities, cities, colors, numbers and names—these latter due to the vibration of the thoughts radiated by those who see or think of them—have some influence.

Objects and people's thoughts, as well as one's own thoughts, radiate inner-plane energy of characteristic vibratory key. These radiations add their energy to, and stimulate into activity, the group of thought-cells of similar vibratory key in the astral body of anyone closely associated with them. This gives the group of thought-cells of similar astrological quality more power to work from the inner plane to bring the events it desires into the life, whether it desires riches or desires poverty.

The birth chart not only indicates the natural source of greatest wealth, but the department of life through which wealth most readily will come. This is indicated by the house the best planet is in, or at least by the most harmonious houses in the chart.

Some people, for instance, are fortunate in speculation, but others always lose when they take a hazard. Yet those who lose when they take a chance often succeed in all business undertakings of a conservative nature. Some are fortunate in real estate, and some always make the wrong purchases. Some make money through partnership, and others lose through the mistakes of the partner. It can only be known in which departments of life the thought-cells are harmonious enough to attract money, and in which departments of life they are so discordant that every move will bring financial loss, through an analysis of the birth chart. And it is much better if one is able to make this analysis for oneself.

At start, therefore, of any systematic effort to make money, one should learn how each environment and natural resource tends to affect the money-making thought-cells within the finer body. And one should learn through which departments of life, and to what extent, he repels money, and through which he attracts money. Charles M. Schwab, early in his career, lost money, a great deal of money, in Nevada copper mines. Yet in the manufacture of steel he became one of the most powerful financial figures in America. It is almost an axiom among business men that when a man takes up some line quite dissimilar to the one in which he made his money, he usually loses. Do not expect, therefore, to be able to make money in any line you fancy. Even the biggest money makers are unable to do this. But they have found, perhaps by bitter experience, in which lines they are fortunate and in which unfortunate. Instead of choosing at random, or without guidance, see to it, therefore, that the type of your efforts and your environment are such as attract, rather than repel, wealth.

Another thing which should be decided at start is whether it is better always to work for a salary, or whether, at the right time, it would be better to go into business for yourself. There are salaried positions to be had that yield enormous incomes. In fact, there are never men enough to fill the \$100,000 a year and better positions. That is, there are many such positions open to any man who is sufficiently capable. And, peculiar as it may seem, many a man who is capable of earning such a salary when steadied and kept in bounds by the board of directors of a corporation, goes on the rocks whenever he goes into business for himself. Some people, due to the activities of the thought-cells within their finer forms, do their best in business for themselves. But others, doing well while working for others, make a miserable failure of their own enterprises. This should be known in advance. It is revealed by a study of the birth chart. The astrological rules are given in Lesson No. 107 (See Serial Lesson Key).

Such analyses as have been suggested, if carefully and thoroughly carried out, prevent the energies and resources being diverted into channels from which there is little prospect of adequate compensation. They enable the energies to be focused in those lines which will yield the given individual the maximum financial returns for effort expended.

There may be, however, groups of thought-cells within the astral body that are so discordantly organized in association with all thoughts of money that even though money be made, one condition after another will arise to take it away. Again, the birth chart, mapping the planet afflicting money, reveals the thought-cells having discordant desires, and how they were formed. To counteract their influence, and thus put a stop to repeated financial loss, their desires must be changed. This is accomplished by reconditioning, especially by using proper thoughts as a mental antidote, as explained in detail in Course 9. These selected thoughts should be substituted for those which are the expression of the discordant thought-cells whenever thoughts about money enter the mind.

It may be found, instead of pronounced discords, that the birth chart or the life up to the present time reveals that the finer body contains no thought-cells relative to money of sufficient power to attract money. That is, there may be no gains and no losses of consequence.

When this is the case, in order to make money it is necessary to give the thought-cells mapped by the second house of the birth chart, and perhaps those mapped by certain planets, additional energy. In a very general way, if you cultivate the feeling of pleasure on every occasion when money is mentioned this has an attractive effect. But to have the feeling of discouragement, the feeling of loss, or any other disagreeable feeling, at the time money is thought about tends to repel wealth. It matters not whether such feeling is caused by actual loss or merely by anxiety over money matters. It tends to repel money. But all thoughts of money accompanied by feelings of joy and pleasure exert an attraction toward it.

The most powerful thought-cells in the finer body to influence money are those mapped by the planet ruling the second house of the birth chart. When this planet is known, every effort should be made to add to its harmony by associating thoughts, feelings and actions of pleasure that correspond to it with thoughts of money. Each planet rules a given type of thought, and the type of thoughts ruled by the planet governing the second house should be built up both in power and in harmony through appropriate thoughts, feelings and actions.

These money-attracting thought-cells may also be accentuated by appropriate things in the environment. Some care, however, must be used in this, as objects, unlike thoughts, are not harmonious or discordant in themselves, but merely add energy to thought-cells of similar vibratory rate in the astral body. Therefore, if the money thought-cells in the astral body are discordant, associating with objects corresponding in vibratory rate to them merely increases their power, without changing their desires, which may be to occasion loss. But if the money thought-cells, as shown in the birth chart by the ruler of the second house, are harmonious, associating with objects of similar vibratory rates will be beneficial because their power will be increased, and already they desire to work for wealth. Association with names, numbers, colors, gems, localities, people, and other things ruled by the planet governing the second house should be encouraged only when the ruler of the second house of the chart is a harmonious influence.

When it is not a harmonious influence, the planet making the best and strongest aspect to it, or otherwise having the most power in reference to money attraction, should be selected by a careful analysis of the positions in the birth chart. And when found, the associations should be, as much as practicable, with names, colors, numbers, objects, and situations ruled by this other money-favorable planet.

Significance of Progressed Aspects

—Time relations must not be neglected if one is to take full opportunity of all advantages to make money. During a period while the dominant progressed aspects are heavily discordant it is very difficult to make money. This is particularly true if the planet ruling the second house is a member of a discordant progressed aspect. But even if the ruler of the second house makes a weakly harmonious aspect, the discord of the heavier aspect may act as a Rallying Force to cause loss. During such a period, therefore, it is best to be conservative, on the lookout to prevent unnecessary expenditures, and on guard against avenues of possible loss. Expansion and new enterprises, in as far as practicable, should be postponed until the progressed aspects are more favorable. There is the tendency, throughout such a period, to the extent the discords affect the desires of the thought-cells, for the individual to attract enterprises and other environmental conditions that tend to lose rather than make money.

On the other hand, during a period when the dominant progressed aspects are powerfully harmonious, the desires of the thought-cells within the finer form are such that they work—using extra-physical power—to attract enterprises and environmental circumstances that have money-making qualities. And this is particularly true if, at the same time, there is even a weak harmonious progressed aspect to the ruler of the second house of the birth chart.

Another thing, as revealed by a statistical analysis of the progressed aspects in the charts of 100 people at the time they made money, and a statistical analysis of the progressed aspects in the charts of 100 people at the time they lost money, people only make or lose money in amounts which to them are significant during the periods when there is a progressed aspect to the ruler of the planet governing the second house. The complete analyses, and the conclusions to be drawn from them, are set forth in the book, *WHEN AND WHAT EVENTS WILL HAPPEN*.¹

To be most fortunate in money matters the progressed aspects should be employed as a barometer of the thought-cell activity and the thought-cell desires. Within the heavier astrological influences that last for a year or even a series of years, there are lesser influences that vary from month to month, such as the sub-major influences denoted by the major progressed aspects of the Moon. And there are still other influences varying from day to day and from week to week, indicated by minor progressed aspects and by transits. How much one can venture with safety at any particular time is revealed by these progressed aspects.

And when it is safe to launch a particular proposition is also thus indicated.

An enterprise ruled by Saturn, such as a real estate transaction, or a mining venture, will be backed by the most favorable thought-cell activity if it is launched while there is a good progressed aspect involving Saturn. A manufacturing enterprise, or a hazardous adventure, will have a better chance of succeeding if undertaken while there is a harmonious progressed aspect to Mars. And an effort to gain patronage, or something depending on good will and salesmanship, will prosper more if presented when there is a harmonious progressed aspect to the planet Jupiter.

Then again, in addition to the progressed aspects in the chart of the individual or individuals starting it, the success of an enterprise is markedly influenced by the time when it is started. The moment of starting a new venture is its moment of birth, and a chart erected for this moment indicates, by the planetary positions, much of its future. If a business is commenced when the progressed aspects in its owner's chart are discordant, merely choosing a propitious day for its birth will not insure its success. But choosing a propitious day for its opening will make its course more favorable than if, during the same general period, it is started on an inauspicious day. This subject of selecting the most propitious time for starting each specific venture is considered in detail in B. of L. Lesson No. 92 (See Serial Lesson Key).

It may seem that altogether too much space in this lesson has been given to astrological considerations.

There is no question that the observation of the principles shortly to be expounded, even with no knowledge of astrology, will enable the individual to make more money than otherwise he would do. But long years of observing the influence of astrological positions upon the financial condition of people convinces me there are no other factors having a bearing upon making money that are nearly so important. When the individual has analyzed the possibilities of his birth chart, and then intelligently watched the progressed aspects for opportunities, he has already advanced more than half way toward making money.

But as the study of the birth chart and progressed aspects merely gives the best possible map of the road to wealth, let us now take up the more important steps along this road.

Something Must Be Exchanged For Money

—At the first step we should realize that to have money something must be exchanged for it. Money is minted or printed by the government, and not by the individual. For this money to pass into your hands you must have something to trade for it. And more important still, this something for exchange must be so desirable that those who have money are willing to part with cash for it.

This statement is so simple that it might seem almost redundant, yet I find people every day violating its principles and at the same time wondering why they do not make money. They are willing to work, but the quality or type of work they do is such that nobody wants it. They till the soil and raise farm produce, but this produce is so common that the price does not justify their labor. They make an invention, or a new discovery, after perhaps years of research and effort; but it yields no income because nobody has a use for it. They manufacture something, and expect to become rich, but fail to realize this hope because there is no demand for this particular article. Such lack of success in money getting is directly traceable to the violation of the fundamental rule that to make money you must have something that people so desire that they are willing to exchange money for it.

Basic Principles

—No attempt here can be made to give more than a rough outline of basic financial considerations. Yet if you expect to make money you should understand the principles here outlined.

Aside from exploitation and speculation most money making relates to one of three subjects:

- I. Basic utilities: These are natural resources that have undergone little processing, such as crude oil, unfinished lumber, coal, iron and other metals, grain, cattle on the hoof, and other farm produce.
2. Form utilities: These are the product of labor applied to basic utilities. Thus gasoline is a form utility, a house is a form utility, as are bread, beefsteak and pumpkin pie.
3. Service: When the dentist pulls an aching tooth, a man delivers a lecture, a lawyer pleads a suit, or the grocerman delivers a pound of butter, a service has been performed. Service is as truly production as agriculture and manufacturing; for until serviced merchandise has no use to the consumer, and without other classes of service life sinks to the level of mere animality.

I am inclined to stress the opportunities of money making in certain services, particularly in the distribution of commodities. Distribution gives “form” utilities (merchandise) “time” utility and “place” utility. For example, a dozen eggs have no value to you while they are on a farm fifty miles distant. Upon discovering you have no eggs for breakfast, it would be unprofitable for you to travel to this farm and back in order that you might have eggs with your toast this morning. But you do not hesitate to call up the corner grocer and have him deliver the eggs. They reach you perhaps in ten minutes, before you have finished shaving, and in another five minutes are cooked and on the table. Because the grocer performed the service of having the eggs in the right “place” at the right “time” you are able to have eggs for breakfast as usual, and reach your office or shop at the customary time.

Distribution Service

—We cannot expect the grocerman to perform a service without getting paid for it. We cannot expect the man who furnishes the transportation—brings the eggs from the farmer to the grocer—not to be paid for his time and work. But there are at the present day undoubtedly very great opportunities for the person who can perform such services more economically.

It is not unusual, for instance, for the farmer to receive for his products not more than 25 per cent of the price paid by the consumer. Packing, shipping, storing, wastage, deterioration, handling by middlemen, and distributor's profits account for the other 75 per cent. Some authorities state that on an average half the selling price of all goods is accounted for by marketing expenses and profits. Certain staples, of course, are sold to the consumer at perhaps an advance of not more than 10 per cent of the sales price. But in general the advance is much greater. Another authority estimates that 37 cents of the consumer's dollar pays for the cost of production including the material it contains, 49 cents is devoted to services between the producer and the ultimate consumer, while 14 cents is the profit of those who handle the commodity.

To the consumer, and rightly, such a wide spread between the cost of producing an article and the price he must pay for it seems exorbitant. Yet this field of service in its various branches is at all times open to those who wish to make money. To anyone who can devise a method by which the cost of delivering a commodity from producer to consumer may be lowered there awaits a fortune. At present this attempt is being made through chain stores and branch banking. But the opportunities are not confined to great corporations; for whoever renders a service that is wanted by the public, at a lower cost than can his competitor, is a benefactor to others and is on the road to wealth.

Analyze Demand

—Turning now from the problem of distribution to those that are inherent in all money making, no matter whether the effort is that of service or of production, the first thing always to consider is demand. If you expect to practice some profession analyze the probable demand for such services at this "time" and in various "places." If you intend to raise a crop, ascertain first if there will be a ready market for it at a profitable price. Even if you only expect to hire out your ability as a laborer, make a canvass of the qualities you possess and of the people that have need for such qualities.

On the other hand, if you already have something, and there is no demand for it, your only hope of making money out of it is through building up the desire of other people to possess it. The Standard Oil Company was faced with such a problem. They had at one time plenty of kerosene but an insufficient market for it. Surveying the possibilities they thought of China with its population greater than that of any other

country. But the Chinese had no desire for kerosene. They had never felt the need for lamps. Therefore, to build up a demand for kerosene the Standard Oil Company furnished lamps to the Chinese free. After the receiver of such a gift became accustomed to its use he no longer was willing to do without its convenience, and as a consequence there was built up in China an immense sale of kerosene.

Illustrations of this same principle—as when the Fuller Brush salesman on each visit gives the housewife a vegetable brush—can be multiplied indefinitely. If, therefore, we consider the very first essential of making money to be the production or possession of something which other people desire, the second essential seems to be that if you have something that can be disposed of, to build up the desire for it in other people's minds. This, of course, is salesmanship.

Something For Nothing

—One of the greatest fallacies is the notion that something may often be had for nothing. Sometimes a natural resource may be discovered and exploited. Sometimes a combination of circumstances arises that gives great value to something that previously had little value. In the field of speculation, some people are able to gain money that others lose. The birth chart reveals the possibilities and the lack of them in such lines. And the progressed aspects of the planets indicate both the times when and the fields in which, such ventures will prove most successful. The horoscope is the best obtainable guide to both speculation and investment.

But most money is acquired in furnishing other people with the things they desire. And nowhere is there a greater demand for ingenuity and a greater lack of ideas.

It is rather an axiom that wealth is the product of labor. But unless that labor is directed by intelligence not much wealth is produced. With a machine one man can have an output the equivalent of that of one-hundred men working without machines. Few things are being done in the best possible way. They are being done in a particular way because that has been the customary way of doing them. For how long were watches worn on chains? Apparently everyone considered that the only possible way a watch could be carried is dangling at the end of a chain. But finally someone—shall we say an intellectual giant— had a brain storm and brought forth the astounding thought that it might be possible to wear a watch on the wrist. Hence wrist watches today. And a thousand more ideas of no greater complexity than that of the wrist watch are yet undiscovered because human minds are so steel-encased in precedent. In each of these ideas is the germ of great wealth.

Brains More Important Than Labor

—While the old formula that wealth is the product of labor in a sense is no doubt accurate, at the present day, it seems to me more relevant to the facts to state that money is the product of brains.

It is not that people who lack money do not have the brains, it is that they fail to use the brains they have. There is probably no occupation that men follow but that better methods of procedure can be devised in it. There is probably no mechanical or manual work being performed today but that it can be improved upon. And such improvement in quality, such cutting of time consumed, such elimination of waste, such additional services rendered may be capitalized and turned into money. But people find it so hard to think of things in new ways.

To overcome this difficulty the effort should be made from the start to learn all there is to know about the enterprise you are engaged in. Accumulate and classify every fact that may have a possible bearing upon the matter. Know the matter from the ground up.

Then start the rearrangement of these facts in as many different combinations as you can think of. Think of each process, and of all the possible ways it might be done, no matter how ludicrous some of these ways may seem.

You need not doubt that there are better ways of doing the work than the way you are now doing it, or better policies than those that you have adopted. And you can think of them, if you make up your mind to do so.

Let The Unconscious Solve Your Problems

—More important still, put your unconscious mind to work on the problem. It has a far wider field of information than the objective consciousness has, and immensely greater ability to bring the factors together to give the desired solution. First, of course, get a clear idea of just what you want. You want, let us say, to devise a method by which you can give the public better quality at the price previously charged for poorer quality. Or, perhaps, instead you desire to give the public the same quality at a lower price. Or you may decide the best thing is to find a method of reaching a wider public at the same price and quality. But whatever it is that needs solution at the time, formulate it clearly. Know what you want, and then build up abounding confidence that there is a solution, and that you can find it. Collect all the facts about the matter possible. Bring them together in as many combinations as possible. And then, after this confidently turn the whole matter over to the unconscious mind.

If this preliminary work has been well done, and due responsibility and due confidence is placed in the unconscious mind, new and valuable ideas about the situation will, at moments when you are thinking of almost nothing, or thinking of something entirely different, pop into your mind. Both affirmation and suggestions (Lessons No. 62 and No. 63 [See Serial Lesson Key]) properly applied will greatly aid in directing this activity of the unconscious mind, and thus assist in the production of the desired result.

In money-making the most fatal mistake is to lose sight of the other person's point of view. Your point of view—that you desire to make money—is of little concern to him. He will not do what you want him to do—provide you with money, for instance—just because you desire him to do so. He will only do this because, and when, he desires to do so. You can only expect to gain possession of his money through his desire for something. Furthermore, as previously pointed out, the other person is the only source from which you can obtain money. Consequently, if you are to have it, in some manner you must appeal to the desire of someone who has money.

This appeal may be made by means of some new article, or some new service. Conveniences and luxuries are being invented and profitably marketed every day. New forms of services are constantly being sold to the public. The method of thinking up these new ideas is briefly stated above. But first, last, and all the time, in such inventive activity, the want of the public must be considered. Either a need already present must be supplied, or some method devised by which a need that the public is yet unaware of may be built up.

Quality And Price

—In reference to the things that the public already knows it wants, the appeal of quality is universal. If people can get better quality in an article, or better quality in a service—a better doctor, a better lawyer, a better dentist, a better mechanic—for the same amount of money, their desire is appealed to and money changes hands. Or if the quality is much increased, and the price increased only moderately, there is an appeal to a rather wide class. Therefore, whatever line you are in, there is always, if you can but think of it, a way by which quality may be increased in a manner to arouse the desires of others.

Another universal appeal is that of price. Whether it is merchandising or service, the public desires to purchase at the lowest price. If, therefore, you can devise some method of supplying the same quality of service or merchandise at a lower price, this appeals to a fundamental want. Mass production has accomplished this in some lines, although the limit is nowhere reached. But in every line there is opportunity to lower prices through superior management, or through carefully thought out devices.

Money Making

—Briefly summarized then, the chief avenues of money making are through new or unique articles and services, through increasing the quality of merchandise and services already in demand without a commensurate increase in price, and through lowering the price but not lowering the quality of merchandise and services desired by the public.

But such action only makes money when people know about it. That is, you may have something new or unique, you may have devised a method by which better quality can be given at the same price, or the same quality can be given at a lower price, and at the same time leave an adequate margin of profit. Yet unless people are informed of these advantages no money will flow your way.

Thus it is that no matter what pursuit you engage in—as the money you acquire must come through other people even if you ship the gold to the mint—if you are to make money out of it there is an element of salesmanship to be considered.

If you are working for another, you must sell your ability to the boss. If you are working for yourself, you must sell to the public or some portion of it. In professional work, and in such selling as requires meeting the public personally, the personality factor is of extreme importance. People patronize those they like, and only an unusual inducement will cause them to deal with a person they dislike. Lessons No. 155 and No. 156 (See Serial Lesson Key) give instructions on becoming attractive and winning friends, both of which are extremely important in making money. But whatever you have to sell, see to it that people know about it. And right here another principle of psychology should be mentioned. It is called the principle of SUMMATION. Careful experiments in this have been conducted by Mandel Sherman and Irene Case Sherman. They found that a child who took no notice of a direction, for instance, could often be made to react to it by repeating the direction five or six times at short intervals. If the intervals between were too long, the child continued to take no notice. A stimulus, repeated at short intervals, has a cumulative effect.

This principle, together with the general susceptibility of people to suggestion, has long been put to practical use by advertisers. If you read on a billboard once that White Bar Soap cleanses everything, it passes without much effort. But if you read this day after day, it sinks into both the conscious and the unconscious mind. You do not stop to analyze why White Bar Soap is better, or even to prove it is better. But, when you need soap, because this suggestion has gained a foothold in the unconscious, and because of its familiarity it is the first soap thought about, you order White Bar.

In many lines it is unethical to use signboards or other commercial advertising. But as we all must sell something in order to make money, we can take steps, at least, to prevent those to whom we must sell from forgetting us. Professional men do this through lodges, through leading worthy civic enterprises, and through other social contacts. Unless the public knows about these men they cannot patronize them. If, therefore, they render a service of value to society, they are not only benefitting themselves, but also others, by getting themselves widely recognized.

As already suggested, money cannot be made without the exercise, in some degree, of salesmanship. Treatises on salesmanship embracing several volumes to a set are to be had, but the outline given below sets forth all the important steps. The larger works mentioned merely elaborate these steps and illustrate their application.

From the money-making standpoint—for salesmanship must be used in the attainment of nearly every ambition—let us look at it this way: You have something to sell, either service or merchandise. To sell it you must induce someone to purchase. Therefore you make a (1) survey and list every possible customer. To sell to any one of these possible customers he must be (2) approached. This contact may be made personally, through direct mail advertising, through newspaper and bill-board advertising, or other means. But mere contact produces no results. It does however afford opportunity for (3) gaining attention. You can sell nothing to a person whose attention is elsewhere. Furthermore, you must arouse his (4) interest and build up (5) desire. The more information you have about the customer the easier it is to know what will interest him, and how to stimulate his desires. Reason, suggestion, appeal to the senses, and various methods may be used for this purpose.

In addition to arousing desire you must also secure his (6) confidence. He must become convinced that you are not unwittingly or willfully misrepresenting. After confidence is established the next step is to bring about (7) decision to buy. This may be done often by showing how the merchandise or service will benefit him personally, that is, how it applies specifically to his needs, wants, or desires. Or it may be done by building a secondary desire, such as through some additional inducement, reason, or suggestion that has been held back to this moment. This is the psychological moment that the skilled salesman watches for. and takes advantage of to obtain (8) action. Action is the passage of money in connection with the sale, the signing on the dotted line, or whatever is necessary to complete the transaction.

It will thus be seen that the selling of something is the systematic building up, step by step, of an impulse that overflows in a definite action. Yet this does not conclude the transaction so far as money-making is concerned. If there are to be further sales to this customer, or to his acquaintances, the goods or services must give (9) satisfaction. The end toward which all successful salesmanship strives is the satisfaction of both seller and buyer.

Demonstrating Money

—The powers of the unconscious mind may be enlisted most effectively in attracting money. Do not visualize any particular person, but at a given time each day visualize clearly the situation through which you expect to get money. That is, picture a crowd of people at the counter of your store, a number of patrons in your office, or yourself working as you wish to be at a higher salary. Picture the situation, and also the passage of money resulting from the situation. Formulate the matter as an affirmation, and as you picture in your mind the money reaching you, repeat- the affirmation. Make the affirmation and the picture suit your circumstances. Thus if you are a merchant, picture many people buying at your counter, while you repeat: MANY CUSTOMERS ARE COMING TO MY STORE AND FREELY SPENDING MONEY.

Chapter 9

Serial No. 159
Original Copyright 1944
Elbert Benjamine

Copyright
August 2002
Church of Light

How To Achieve Honors

Chapter 9



How To Achieve Honors



THE driving force of modern industry is self-respect and the respect of others. The reproductive urge and the urge to seek food are fundamental; but modern man encounters no great barriers in the way of finding a mate and satisfying his hunger. In the matter of satisfying his self-esteem, however, the rising standards of living cause his family and his associates to expect increasingly greater results from his efforts.

Self-respect has come to be the most vital factor of human life. It resists attack and invasion more strongly than any other urge, even than the urge for life itself. One way to maintain and increase it is to gain the respect of others. Whether he realizes it or not, everyone desires at least to be worthy of honors.

When I say that the respect of others is a driving power in our economic relations I mean that Harry or John might loaf in the shop were it not that other workmen would consider him lazy and thus inferior. Sam Smith, the crack salesman, would be content to earn \$10,000 a year, except that his wife wants a new home and expensive clothes, so that she may feel socially equal to Mary Jones. So Sam steams up and increases his sales to an income of \$20,000. Likewise, the janitor's boy wants to go to college because his pal is going, and his father asks for a raise, or gets a new job at larger pay, so he can send him. People could live without these things, but they would not gain the same respect from others.

Back of this desire for the esteem of others is the ego ideal. That is, each individual as he develops from infancy comes to look upon himself in a certain way. Gradually he acquires standards of conduct. Because others seem to expect certain things of him, he comes to expect these things of himself. Or, on the other hand, because he fails to do what others expect of him, and receives their censure, he may look upon himself as a failure in certain ways.

Experiences modify his view of his own character. The suggestions of other people have an effect. In fact, all he thinks and does, as well as all that happens to him, have an influence. The result is that as he grows to maturity and his opinions stabilize he has pretty definite ideas of his own abilities, his own worth, and just about what he expects of himself under various circumstances.

This idea of himself which every person holds may, or may not, represent the real character. It may, or may not, rest upon ideals which are sound, and which are possible of realization.

The emotional elements that enter the life during infancy are powerful to warp these self-ideals. The experiences of youth also contribute emotional elements that may have drastic power. Not only the teachings of elders, but their example, give direction to these mental images that shape the conduct in after life. They are the conceptions by which the child attempts to adjust himself to the situation he confronts. Because of the limited experience and wisdom of the child, all too often some of these conceptions are based upon fallacy. When so founded they nevertheless persist, and influence the conduct profoundly even in adult life.

In learning how to achieve honors, therefore, our first task is to examine our standards of value. Growing from infancy to maturity we have all been faced with many situations which we were not fitted by experience adequately to understand. As a consequence, the importance we attach at the time to some of them was disproportionate. Perhaps at present we would view these situations differently, but the inexperience of childhood caused us to react to them with undue emotional emphasis. And having, in later life, forgotten all about the occurrence, we have never taken the pains to make an emotional readjustment to these experiences of childhood, and properly revalue them.

Human relations are so complex, and some of them so recently developed as seen from a biological standpoint, that there are a multitude of ways in which the emotional responses of a child may be given an unusual bias. Few there are of us, therefore, who grow to maturity without some emotional twist that under certain circumstances makes us seem queer or at least not perfectly poised. And some of these emotional biases are of such proportion as to make adequate adjustments to life as we now find it very difficult.

If we are to achieve honors we must render valuable service to society through the development of our personal prowess to a degree of superior efficiency. Unusual emotional reactions to, or unusual valuations of, the incidents arising from our work and our human contacts, are great and often insurmountable handicaps. Let us, therefore, examine how a few of the most common arise, and how readjustment may be made.

False Standards

—As a result of the example of our associates, their admonitions and suggestions, and our own experiences, from the earliest infancy we built up an opinion of just what we expect of ourselves under various circumstances. We have ideals, and these ideals should be high. They cannot be too high; for they are the goals toward which we work. Should we reach them they are no longer ideals, but facts.

But in addition to ideals we have standards. These standards are not merely ideals but are what we actually expect of ourselves in the way of more or less immediate performance. Such standards may be sound or they may be false. When they are the latter they give us no end of trouble.

Very frequently a person sets himself a standard that is to him impossible of attainment. Various types of neurotic diseases, for instance, arise from a conflict between the fundamental urges of sex and false standards of purity. The person has set himself a standard that does not permit even a thought of sexual expression. His biological heritage demands this expression. But he has so firmly established

his standard in his own mind that his objective consciousness is totally unaware of the existence of the to him objectionable desire. But though he is quite unaware of its existence because he represses it, it does not cease to exist. And like every energy not finding a legitimate outlet, it finds a substitute outlet, and manifests as one or more of a score of diseases which can only be relieved by acknowledgment of their source.

This particular type of false standard has become widely recognized through the Freudian literature. But it is only one of numerous types. Another of these was responsible for the death of a man of unusually fine character and a very dear friend. The case, as is customary, dates back to childhood. He was a child of well to do and highly respected parents in the Middle West. Financial success, next to an honorable life, was the family standard. He was brought up under the impression that great things were expected of him in a financial way. Before he was twenty he came into possession of some money, went to Chicago, and speculated on the Board of Trade. For a time he had remarkable success, then began to lose. Before he had lost all, he left Chicago and invested the remaining amount in a transitory business enterprise. In this he was amazingly successful. Still under twenty years of age he was considered by his friends a financial wizard.

He then went into real estate and other enterprises. No business was attractive to him unless it held opportunities for big gains. But instead of big gains he steadily lost. Year after year saw his funds dwindle.

He had ability to make a moderate salary working for others; but the image of himself created by his family in childhood, and intensified by his great temporary success, would not permit him to be anything but a grand financial success.

Yet the standard he had set for himself was beyond his reach. While he still had money enough to be considered fairly well to do, he began to deem himself a failure. He developed a chronic sigh. He worked persistently and struggled courageously to gain the fortune which he considered was his right in the world. Not until every possibility of making the fortune he had in mind seemed closed did he give up. When finally he realized there was no hope of realizing his standard he died. He died not of any physical ailment, but a martyr to an impossible standard of achievement.

A more commonly observed instance is that of a child whose parents and their associates believe and perpetuate the idea that he is just the smartest thing in the world. He is taught to believe that everything he says is of unusual importance and that in some manner he is superior to other children of his age. He grows up an egotist, but the time is finally at hand when he must face the stern realities of life. In open competition he tries to make his way in the world, but just does not seem to get ahead. He knows that he has more ability than others who receive the promotions, because has he not always been told that he is smarter than others? He feels therefore, that he is ill-treated, and that those over him do not appreciate his qualities, when as a matter of fact he is receiving just consideration. This fallacy as to his own worth, implanted in childhood, under these conditions gives rise to a mental conflict. He chafes at not receiving what he considers his just dues, or if the conflict becomes acute he suffers a mental breakdown.

Mental Breakdown

—A mental breakdown, as distinct from the rare organic diseases of the brain, is always caused by a conflict between mental factors. We see it exhibited in a mild form by the individual who has set standards (not ideals) for himself just above his reach. When he plays a game of golf, perhaps a good game, he expresses astonishment that he should play so poorly, and shows irritation or marked depression when he makes a bad shot. Or in the conduct of his business if he makes some minor error, he shows that he is quite upset about it. Such an individual, everywhere common, has established a standard of perfection for himself which is foreign to real experience. The conflict between his real self, his real performances, and these false standards are a cause of recurring emotional disturbances. These detract from his real efficiency in life.

Mental breakdown is not confined to the human family. Pavlov, in his experiments upon dogs, found that he could induce neurasthenia in them. First he would set problems for a dog that were not difficult, by the solution of which he could reach food. From time to time new problems, in the way of opening doors, etc., would be set, but still within the mental ability of the dog to learn and perform. Then, after the dog's confidence that he could reach the food by solving a problem was built up, Pavlov would present a problem so difficult that the dog could not solve it. Under these circumstances the dog would fret and worry day after day until he was in a state of nervous exhaustion. Finally he would begin to act strangely, to be irritable, to start at every sound, to bay at the moon, to refuse to touch food given him, and exhibit all the symptoms of a complete mental disarrangement.

No one should be content with performances less than his very best. Everyone should have an ideal above and beyond anything he has so far accomplished, toward which he should resolutely struggle. But one should always feel satisfied with one's best. Not to do so indicates that there has been unsound valuation of one's abilities. And any resulting emotional perturbation is uncalled for mental conflict that consumes energy and if extreme may lead to complete mental breakdown.

Pavlov, who won the Nobel prize in 1904, learned just how conflicts between mental factors within the human mind lead to neurasthenia, and may lead to insanity, through setting up parallel conflicts in the minds of dogs and observing the effect. The logical procedure suggested by his experiments was not taken until almost two generations later. It was reported by TIME magazine, issue of June 8, 1942. During the three years before this date, Jules H. Masserman of the University of Chicago, had made some 200 animals neurotic through developing in them, much as Pavlov had done, powerful mental conflicts. But he did not stop there. After thus developing mental derangement, Masserman restored these animals to normal life. This he did by reconciling the mental conflict which was responsible for the condition.

The harmonizing of the mental factors of one group was accomplished through reassurance and suggestion; of another group through developing pleasure and triumphing over the apparent peril, fear of which was one contending mental factor in the mental conflict; and of the third group by permitting them at leisure to examine the apparatus which had been used to build up the conflict and learn about it for themselves. With sufficient insight into the sequence of things—even as the conflicts within the minds of those who have set unreasonable standards for themselves are reconciled when they get sufficient insight into what they have done, and how it is impeding them—the conflicts disappeared and the animals became normal.

These experiments have a high value not only because they indicate both the cause and cure of much human mental derangement, including that derived from holding to unreasonable standards, but because that which is mapped by a discordant aspect in the birth chart has also been built by conflicts between mental factors. It has been built by the soul in lower forms of life before its birth as a human being.

A discordant aspect maps mental factors in the unconscious which are unreconciled. And these mental factors in conflict work from the inner plane to attract misfortune into the life. They are as blind to the individual's desires and welfare as were Pavlov's dogs when they became so crazy they would not touch food, or Masserman's cats some of which also refused to eat.

When these thought-cell groups within the unconscious mind are harmonized, and no longer frustrated by being opposed by other thought-cell groups, they cease to work to attract events into the life which are at variance with the desires of the individual. And to the extent this harmonizing process is successful will the difficulties mapped in the birth chart and by progressed aspects disappear, and more fortunate events take their place.

Events are the product of the action of thought-cell groups, or mental factors, working from the inner plane to realize their desires, and the resistance of the physical environment to the conditions they strive to bring about. Events of importance come into people's lives only when there are characteristic progressed aspects present; for only then do special thought-cell groups get enough additional energy to bring to pass the events they want. This energy of progressed aspects also

influences the nature of the thought-cell desires, making them more inclined toward events beneficial to the individual if the aspect is harmonious, and more inclined toward events inimical to the individual if the aspect is discordant.

Therefore, even as Masserman found three methods of reconciling the mental conflicts within his cats, so are there three methods through which aspects can be handled. One method is to give the thought-cells more harmonious energy with which to work, chiefly through utilizing planetary Rallying Forces. Another is to alter the composition of the thought-cells through Conversion or Mental Alchemy. In either of these methods, because the mental conflicts have been reconciled, the thought-cells desire and work for more fortunate events. The third method is to select a type of environment in which the thought-cells, whatever their desires, will not have sufficient power to bring to pass the disagreeable event otherwise indicated.

Egotism and Alibis

—The child who is brought up in the belief that he is just the smartest thing in the world, under certain circumstances, may never have the unsoundness of this evaluation forced on him by later contacts. As a consequence he continues through life as an egotistical ass. He always has a pronounced opinion about everything, whether he really knows anything about it or not. Once giving out his opinion he clings tenaciously to it. He is the person who never makes a mistake. The mistakes, according to his version, are always made by his associates. What he really needs is to revalue himself, and dissipate the unsound idea built up through his childhood associations.

Those of great knowledge realize that there is enormously much they do not know. They are quick to recognize when they have made an error in judgment and to acknowledge it. Those of sterling ability are the first to admit it when they have made a mistake. But the person who has built up an image of his own perfection may permit it to dominate him. This mental factor may be so strong that it cannot be displaced or influenced by reality. Whatever happens in actual life that is contradictory to this image is warped into conformity with it. He cannot admit, even to himself, that he has made a mistake. His unconscious always invents some fiction by which he escapes from admission of any imperfection. Such an attitude, often quite unconsciously maintained, is always a great obstacle to attaining honors. Other people are not slow to see through such fictions. The truly great man admits his mistakes and profits by them.

Conservatism and Radicalism

—Childhood experiences also result in two other pronounced types. We have ever with us the ultra-conservative and the radical. The ultra-conservative is like a horse which is too severely treated when broken. He has no spirit of his own. He has been taught in early years implicitly to obey his elders without asking the reason why. As he becomes older this unreasoning obedience is transferred to his church, to the traditions of his community, and to everything else that is old and established. The old time religion is good enough for him. The political party of his father is always sound in its platforms. He was taught in regard to all decisions that, “Father knows what is best.” He was never permitted to think for himself as a child, and he will never think for himself as long as he lives unless he is brought to analyze his condition. He will vote as the political boss (a father substitute) dictates, he will believe the Bible from cover to cover in spite of contradictory scientific evidence, and in business he will ever follow established methods and customs. He may attain honors through carrying out old and tried policies, but his influence on society is numbing; for he is a slave to custom and tradition.

At the opposite extreme we have the child who, after a period of coddling is treated in what he considers a very unjust manner. Such unreasonable treatment arouses a strong sense of injustice. This feeling—often due to a childish misunderstanding of his own position which his elders do not take the pains to straighten out—rankles within him until at last it flames into open rebellion. He rebels against father or mother, and is punished for it. This strengthens the emotional content of the image of himself as an unjustly treated individual. As he grows to maturity, because of the strength of this image that the world is against him and everything is all wrong, he comes to be recognized as an individual who, no matter what the topic of conversation, always takes a view in opposition to others.

Later still, out in the world, he fails to get on with people. His associates in work always give him the worst of it. Those who make money are to him grafters. Those who attain honors do so because they have pull. The church is all “bunk,” and the laws of the country are all wrong. Those who work for charity have ulterior motives. He- is not wanted anywhere, in truth, because he always stirs up trouble. He is an agitator and a radical not because he compares evidence and deliberates upon it, but because he is still expressing the emotional rebellion built into himself in childhood. If he is to attain any real honor in life he must now dissipate these conditions by recognizing the source of his chronic attitude.

The Precious Child

—One of the most common forms of emotional maladjustment arises from too much coddling. The child, because it is told so, or more potent still, because the actions of its parents give it the suggestion, comes to believe it is excessively precious. It is not permitted to do this and to do that because it might get hurt. It must be wrapped up carefully in cool weather to prevent it from taking cold. It must not get its feet wet, or be in a draught. Thus is built into it an over-estimation of its own value, and that to preserve such a wonderful creature the thought of safety first should be dominant.

Life and the attainment of honors are an adventure in which initiative and the willingness to undergo hardship and hazard for a worthy cause are essential to success. Nothing so surely defeats worthy aims as undue regard for consequence to self.

Such a coddled child, unless it revalues itself, is never willing to pay the price of success. It cannot bring itself to face the drudgery leading to accomplishment. It is deterred in its progress at every step by fear of consequences to itself. Fear of this and fear of that have so entered its life in early years that it lacks the courage to grasp opportunities as presented. It would like to appear before the world as a wonderful success—for so precious a being as it has always felt itself to be should be looked up to by others—but it shrinks from heavy responsibilities. It actually flees from reality, the reality that lack of courage and willingness to carry the burden is hampering its life. Instead—because the unconscious will never admit anything detrimental to its self respect—the individual invents a thousand and one fictions why he fails to make headway. But he will neither merit nor attain honor until he makes a proper mental adjustment.

If the child has been too much waited on a lack of self-esteem and independence may be carried into adult life. And of even greater detriment the coddling with its resultant self-importance may cause an incurable desire to be in the lime-light. The great things of life are accomplished through team work. The child who has not found opportunity to submerge self-interest while cooperating with other children for the common good, at maturity may find itself devoid of one of the greatest assets of life. Real honors come only to those who, when occasions arise, can submerge themselves for the good of a cause. They must always be willing for the other person, if he is better qualified, to fill the post of importance.

Others always perceive the selfishness of the person “who plays to the grandstand” rather than does good teamwork. They resent this attitude, and invariably try to hamper the progress of such an individual.

Inferiority Complex

—A very large variety of circumstances may occur in the early years of life to give rise to an inferiority complex. Some real or fancied physical defeat may give a sense of inadequacy. The realization that one's family is unable to provide one with things possessed by one's associates. Other circumstances are: Competition with older children, or with those of superior training, and consequent defeat followed by ridicule; standards of conduct set so high that it is impossible to reach them, and humiliation due to not living up to them; and almost any experience of early childhood accompanied by strong emotions of shame and inefficiency. These give rise to a feeling of inferiority that manifests as an apologetic attitude toward life, as diffidence, lack of self-confidence, hesitancy, and any one of a score of compensating mechanisms. If the inferiority complex arises from too much coddling he is afraid to try anything that appears difficult because he fears the result to himself. His unconscious has become so firmly convinced of his preciousness that it will not permit him to attempt anything that might bring discomfiture.

Or if, in childhood, he has been compared unfavorably with other children, or has had some experience in which he has felt deep humiliation, the sense of his own preciousness will not permit him to run the risk of repeating the humiliation. He is afraid to talk in public, and is uncomfortable when many people watch him work, because he is afraid he will not live up to the high standards he has set for himself. He might make some mistake before all these people, and the high estimation he has placed upon himself makes this thought unbearable.

Shyness

—The unconscious never relinquishes its self esteem. The conscious mind feels inferior, but the unconscious invents countless fictions, makes excuses, runs away from deciding tests, and in all ways attempts to bolster up the idea of superiority.

Early environment sometimes gives the child a greatly overestimated value of himself. In later contact with other children he is unsuccessful in getting them to take him at his own evaluation. They are inclined to ridicule his pretensions of superiority. To associate with them, and enter into their competitions, means a relinquishment of this idea of superiority. Instead of doing this, the unconscious retains the fictitious ideal of self-importance by withdrawing from others. The unconscious feeling of superiority gives rise to a conscious feeling of inferiority. Thus develops the child and finally the adult marked for shyness.

Over-Sensitiveness

—In a somewhat similar manner the child unduly impressed with its preciousness develops over-sensitiveness. He comes to believe himself of greater value than others, and meriting greater care. He is shielded from discord and harshness until he feels such shielding to be his due.

In his actual contact with life he comes in contact with that which is disagreeable. In proportion to the valuation he places on his own welfare, and the protection he has been accustomed to, will these contacts induce fear. Fear always mobilizes the body on a war footing, through causing secretions from the adrenal glands to enter the blood. As a consequence, the adult developing from such a child, or from a child that has had experiences giving rise to fears which through shame or other causes have been repressed, is continually on the defensive. His body is prepared at all times to resist invasion or injury. He is “high strung” and “sensitive” due to an unconscious anxiety. This may be relieved by realizing its cause and tracing it to its childhood source.

Boasting

—Boasting and stuttering are always due to a feeling of inferiority. By show and ostentation people unconsciously endeavor to impress others with an importance they do not feel for themselves. The unconscious compensates for the feeling of failure by play acting what it would like to be. Such inferiority may be felt by one who has actually accomplished much, as well as by one who has accomplished little, all depending on the standards. But when a person really feels he has accomplished something worth while it gives him a sense of satisfaction, and he is content to rest his case upon its actual merits.

Considerable pains have been taken to point out the origin of those traits of character which more frequently than others prevent people from attaining honors. Some, in spite of outstanding deficiencies, due to other unusual flares, have attained the esteem of nations. But for the most part these we look up to are simple in demeanor, straightforward, sincere of purpose, and without undue over-valuation of themselves.

Edison as a man would not have been so greatly loved in spite of his inventions if he had been egotistical or if he had been unduly diffident. Lindbergh captured the imagination of the world not merely because of his unprecedented flight, but because at that time he did not permit fame to turn his head. Lincoln lives in the hearts of the people as a simple man.

Summary of Emotional Reactions

—If you suffer from an inferiority complex, now you have learned its origin, get rid of it by revaluing yourself. Honors are bestowed by people, and people will not place confidence in a person who has no confidence in himself. The suggestion of incompetency that reaches them is too potent. On the other hand, people resent egotism, boastfulness, and too obvious self-superiority. They value themselves by comparison with others. If through mannerisms or dress they get the opinion you look down on them or feel them to be less intelligent, it attacks their self-esteem. This they resent more than anything. The farmers who were really responsible for the election of Lincoln resented the superior polish of Douglas. But Lincoln dressed plainly, always spoke to them as equals, and made them feel that he was one of them.

If you are over-sensitive, now you know the cause, take less thought of harshness and annoyances. Too tender a personality is not capable of carrying heavy loads. If you are a chronic kicker, iron that out also. If you are merely a “ditto” mark for the opinions of others, make a few decisions for yourself at once as a start in the right direction, even if these decisions prove erroneous. Cultivate self-reliance. Look upon life as an adventure where taking a few risks is a part of the game. Admit it when you make a mistake. Be willing to acknowledge ignorance when you do not know, and to seek the advice of others who do. Keep ideals always in advance of accomplishment, but beware of setting false standards for yourself. Carry responsibilities when they come your way. We learn to carry heavier loads by first shouldering light ones. Let others have credit for what they do, and they will be more willing to give you credit. Instead of “grandstand” playing enter to the fullest extent into whatever team-work is necessary to get best results. These are some of the things that help in the attainment of honors.

What Brings Honors

—Having thus summed up the more important personal traits leading to public esteem, let us now examine what actions result in the attainment of honors.

We must distinguish between the words “honor,” “fame” and “notoriety.” A notorious person is one who has publicity. The word is commonly used in an unfavorable sense. Thus we speak of a notorious criminal. Fame also implies wide publicity, but not necessarily of a nature favorable or unfavorable to the individual. Honor, however, is esteem due or paid to worth, and honors are the tokens of esteem and respect given by others. Fame may be attained by almost any act that is unique enough to catch the public fancy and give rise to wide discussion. But honors are paid only to those who in some measure render a service to society.

Just a few of the names we honor: Florence Nightingale, largely responsible for the relief of suffering in war time through the Red Cross. Jane Addams, relieving suffering of a different kind through settlement work. Harriet Beecher Stowe whose one supreme literary effort contributed so largely to freeing the slaves. Shakespeare, whose plays have given entertainment to millions, and whose writings have enriched the English language. Newton, whose discoveries made modern engineering possible. Kepler, who widened our universe by discovering some of its laws. Alexander Bell, through whom we have the telephone. Fulton, with his steamboat. Marconi and the radio. Pasteur and immunity from germs. Harvey, discovering the circulation of the blood and adding to our knowledge of physiology. George Bernard Shaw, dramatist and iconoclast, whose keen wit is ever directed against the artificialities. H. G. Wells, who contributes through his books to popular education. We might go on at great length calling to mind every line of constructive endeavor, and we would find that someone had attained honor in it, *and invariably that this was due to his contribution to human welfare.*

It will be seen, therefore, *that honors are not confined to any particular line of effort,* but may be attained through any constructive work. It is required, however, that some contribution shall be made to the welfare of men, and that others shall know of this contribution.

It has already been explained in lesson No. 151 (See Serial Lesson Key) how to find the field of effort where your endeavors will contribute most largely to the Cosmic Work. In this field! then, because it is where your greatest abilities lie, is where you will most readily be able to attain honors. It is the field in which your major efforts should be expended.

At the same time, advancement in whatever vocation you may be following should not be neglected. Such advancement, directly or indirectly, is nearly always dependent upon other people. If you are in business for yourself it depends upon those who patronize you, or upon those who work for you, or both. If you do not work for yourself, it depends upon the boss.

Pleasing the Boss

—Independence is a fine thing and boot-licking is demeaning. Yet it should injure no one's self-respect to try to please the boss. It is in his power to promote you or not. Whether he does so depends upon how he feels toward you. Whenever you spare him annoyance, lighten his burdens, and make him feel pleased with himself rather than irritable, you are working in the best interests of the firm, and toward promotion for yourself.

Every boss has peculiarities. He has his good days and his bad days. He over-reacts emotionally to certain situations. If you are observing you will learn these things. And you will not ask favors on those days when, for instance, his demeanor shows that he has just come from a domestic ruckus. Certain sore spots, although they may seem unreasonable, you will learn to avoid entirely. This is not being a sycophant; it is learning how to handle your job so that the boss will be better able to do his work.

Prepare to Fill a Better Position

—The only way you will ever get to the top is by shouldering responsibility. Whenever possible, therefore, relieve your superior of some duty. He will appreciate this, you will learn how to perform the duty, and when there is need for someone to perform this or some higher work you will be the first person thought of. Carry as much of your boss' responsibilities as he will let you and that you can handle. Advanced positions are filled from those who have a background of experience.

Each position and each line of endeavor have their own peculiar requirements. Make a thorough analysis of the qualities and habits needed to fill the job you now perform, and of the habits and qualities needed to fill the job in advance of the one you now hold.

A singer of my acquaintance some years ago undertook the added labor of learning twelve songs in the German language because some day she hoped to sing in the capitols of Europe and perhaps Berlin would be among them. Shortly after, a director wished to fill an important engagement in Berlin with an American singer. There were a number to choose from, but these asked for several months to learn the songs and he needed a singer in a hurry. My acquaintance, who had a dozen such songs ready for recital, thus got the chance of her lifetime, and went on from there to greater heights. She was prepared, by doing what seemed unnecessary work, for almost any engagement that might offer.

You cannot know too much about your work. Read everything you can get that has a remote bearing on it.

But the most important thing of all is your habit-systems. After making a careful survey of the habits that conduce to getting ahead, start in, one at a time, to cultivate them. The more important emotional reactions that hamper advancement, and how to readjust them, have already been mentioned. One of the habits you will need is that of determination of purpose. Get a clear idea of what you desire to accomplish and let nothing deter you from reaching this end. Such a course means the cultivation of will power. But in addition to such obvious traits there are numerous others that you will be able to think of, some that detract from and some that conduce to the attainment of success in your particular work.

Character

—The foundation for the attainment of honors is character. And character is the sum total of the habit-systems. In the development of character, and in the efforts to advance your work, in some manner cultivate strong desires to do the proper things. These desires will direct the imagination to the image of doing the thing, instead of to the image of not doing it. Thus will and imagination will pull together. When they pull in opposite directions imagination always wins. Dr. Coue formulated this nicely by stating that whenever there is a conflict between the imagination and the will, the power exerted by the imagination is as the square of the power exerted by the will. The stronger the will, the more energy drained into the mental image; for the imagination, in such conflict, is always victorious.

The character, built up to cope with such problems should be energetically engaged in such enterprises as will benefit others. In every community there is opportunity to perform a public service. In every group there is an opening to further the ends of the group. The successful fulfillment of one responsibility opens the way to the acceptance of another. Everywhere there are worth while things that need to be done if someone will but make the sacrifice to do them.

Yet doing something worth while does not confer honors unless people know about it.

Advertising

—Advertising one's accomplishments and virtues unduly is certainly bad taste and does not conduce to honors. On the other hand, undue reticence detracts from one's opportunities to render public services in the future. If one has ability, or if one has accomplished something, there are inoffensive ways by which others may be made aware of it. In other words, the attainment of honors requires in addition to other things, a certain amount of delicate salesmanship.

In such salesmanship, as in all others, the first thing is to attract the attention of the prospect. In this case the public, the boss, or the group of which you are a part. Ingenuity probably will need to be exercised in this so as to make the contact and hold the attention without alienating. In some way keep the boss, or group, or public, interested in your accomplishments. To do this study the individual or individuals by whom you wish to be noticed. Learn what they are interested in and link your work in some way to these interests.

They may not know what they need, but if they suspect that you are trying to dictate what is good for them they will resent it as an impertinence. It is often necessary to give what is good for them together with the things they already are desirous of having in order to get the former accepted. This is not disparaging the boss or the public; it is utilizing the same principle that you use in building into yourself new habit-systems.

The attention having been attracted and held, you must use it as an opportunity to build up the desire for the thing you are doing. Not only is it impossible to gain honors, but it is difficult to do much of anything for others unless by some means you can arouse their desires for the service you are performing. If you make yourself both agreeable and useful, the boss will desire your services. If you can convince the public that they are benefitted through your efforts, they will desire these services to continue.

Occult Considerations

—The first thing, in seeking honors, is to find in what field it is possible for you to attain them. Past performance is some gauge of where you can use ability to gain recognition; but nothing else is the equal in this respect to an analysis of the birth chart. This will indicate where your efforts may be directed so that the public will receive most benefit and you will receive most favorable notice.

The progressed aspects also afford the best map obtainable of what you may reasonably expect to accomplish at any given time. This does not mean that there are times when you should merely drift. It signifies that at some periods the efforts directed into certain channels would be quite futile to bring anything but misfortune, but that at the same time efforts directed in other ways would advance you somewhat toward your chosen goal.

Whatever your goal may be you need no special aspects by progression to enable you to work toward it. Every day of every year, for instance, may be utilized, in spite of astrological or other conditions, to build character. And honors rest largely upon character. But under some astrological influences you will be able to make strides in a given direction that would be quite impossible under other astrological influences.

The work leading to honors may be accomplished gradually, and under various astrological conditions; but the most favorable time for receiving the honors is when there is a favorable major progressed aspect to the ruler of the tenth house of the birth chart, and at the same time a progressed aspect to the Sun. Such a time may especially be utilized to bring to the notice of others what you have done or what you are capable of doing.

When the Sun is making afflictions by major progressed aspects it is unusually difficult to get proper recognition from superiors, and when there is no major progressed aspect to the ruler of the tenth house there is little likelihood of promotion.

The strongest thought-cells in your astral body for influencing honors are mapped by the ruler of the tenth house. Therefore you should cultivate those thoughts which most powerfully will give these thought-cells strong harmonious vibrations. If they are discordant, as shown by the birth chart, a mental antidote, as explained in Course 9, should be applied to change the discord into harmony. But in any case such thoughts should be cultivated in association with the things ruled by this planet that the vibrations of these honor-attracting thought-cells will be greatly and harmoniously increased.

The honor-attracting thought-cells within you may also be intensified by associating with objects having the same planetary ruler (Course 6). But such objects should not be chosen as associates unless the thought-cells are harmonious. If they are shown to be discordant, you should instead choose the locality, house number, telephone number, color, gem and signature that vibrates to the planet aspecting the ruler of the tenth house most favorably.

Demonstrating Honors

—You should have a clear idea of just what you wish to accomplish, or at least the next step or two ahead in its direction. To enlist the aid of the unconscious mind and its tremendous powers in this attainment, visualize frequently, and as clearly as you can, yourself as you would appear in the attainment of your ambition. Hold this image, feel confident it will be realized, and repeat: THIS I AM NOW ACCOMPLISHING.

Chapter 10

Serial No. 160
Original Copyright 1944
Elbert Benjamine

Copyright
August 2002
Church of Light

How To Be Successful In Marriage

Chapter 10

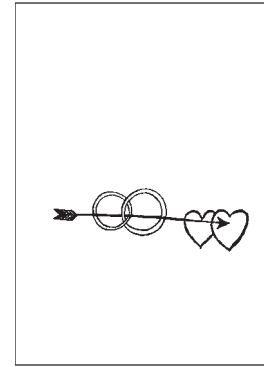

How To Be Successful In Marriage

SUCCESS in marriage includes finding a suitable mate. It embraces being attractive enough to this suitable mate that there is willingness to enter the state of matrimony. It implies the ability to continue to hold the love, respect and good will of the partner after marriage. And it signifies the partners are mutually beneficial, and that their association results in peace, harmony and happiness to both.

Each of these requisites to a successful marriage will be discussed in proper sequence, with a view to determine how they may be attained. Yet as marriage is the result of sexual impulse, we can hardly hope to make a success of marriage and at the same time remain in ignorance of the laws of sex. Marriage is a sexual relation, and to understand its significance we should know something about the natural development of sex and the love life.

Fortunately, late experimental psychology as well as the psycho-analytic schools have done a great deal to make this matter clear. They show that from infancy to late life there is a series of well defined steps in the development of the sexual attributes of the normal individual. An infant is fed at the breast. Then with a bottle, and somewhat later it is permitted to eat solid food with fork and spoon. At length it must go to school and observe discipline and time-schedules. Finally it is no more supported by its parents, but must break its nest habits and move out into the world to shift for itself. These are normal steps in the ability of the child to take care of itself. Likewise, psychologists show that there are quite as well defined steps in the development of the love nature.

Sometimes in the development of the child's ability to care for itself the change from one condition to another is made too suddenly, or under circumstances which cause deep emotional distress. A pampered child, for instance, may rebel or be badly frightened when for the first time it is compelled to be away from parents in school. It may be unprepared to associate congenially with other children. Or when grown up it may shrink from leaving the parental home. The responsibilities of life may look unduly formidable to it. As a result of these experiences it may develop emotional complexes that greatly hamper it. But unless it passes through these normal stages and finally becomes self-supporting and establishes a home of its own it remains at a

level somewhat short of adulthood. Likewise, largely due to the ignorance of parents regarding the normal steps in the sex development of a child and to their prevalent reluctance to mention anything about sex to it, children frequently have difficulty at the crisis of their sexual unfoldment. Getting a wrong conception of the matter they are unable properly to adjust themselves to one or more of the normal stages of development. Even though outwardly reconciled later to the new condition, the emotional stresses remain in the astral body as complexes.

Because these complexes were formed in relation to the sexual impulse, and marriage is a sexual relation, they tend to have a profound influence upon marriage. Not infrequently they cause a person to be unduly shy in the presence of the opposite sex, to be unduly critical of the marriage partner, to react emotionally to the marriage partner in a quite unreasonable way, and to have unreasonable feelings of attraction or repulsion toward certain types of the opposite sex. In fact, the emotional experiences of the child as it passes through the various stages of its sexual development very largely determine what kind of a mate it will be attracted to, its manner of courtship, and its emotional reactions to the mate after marriage.

A child is given toys to play with, but when it reaches maturity it discards toys for adult pursuits. Both the child and the adult are physically and mentally active, but this activity has been transferred from childish objects to adult objects. Should the adult be unable to discard his childish toys, but still retain them as the objects of his activities, we could say that his activities were “fixated” at the childish level, and that he had a “fixation” on the toys. So also, there is a natural development through various steps of attachment from infancy to late life. This is accomplished by the “transference” of the affections from the childish objects to those of advanced age. If, however, as sometimes happens, the individual cannot “transfer” his childish attachment we may say that he has a “fixation” on a certain person familiar to his childhood.

To a scientist who observes the early stages of the butterfly to be a crawling worm, who recognizes that during gestation the unborn child passes through stages of development analogous to fish, amphibian, and reptile, it would seem strange if man’s emotional nature did not pass through successive stages from something simple to something more beautiful and complex. Let us, therefore, briefly follow the natural steps in the affectional development of human life as set forth by leading psychologists.

Levels of Affectional Development

1. To begin with, and quite naturally, the infant's interests are entirely devoted to himself. He explores himself and finds considerable pleasure in contact with certain sensitive zones of his body. His love is centered on himself. This is called the period of "narcissism" after the fabled youth, Narcissus, who fell in love with his own reflection in the water. In abnormal cases there is a failure to transfer the affections to another and the individual remains largely at the "narcissus" emotional level throughout life.

Considerable interest in themselves from an affectional standpoint is commonly to be observed in small children, and should not be deemed unnatural. But if, due to an emotional conflict set up at this time, there is a partial "fixation" on self, so long as this "fixation" remains in the unconscious it will interfere seriously with a successful marriage. The individual with such a complex in his unconscious is unable to release his affectional interest in himself so that he can give himself wholeheartedly to the one he loves. Until he dissolves this complex by recognizing its source, he will have the feeling that something is lacking in his relations with his partner, and the partner also will sense something is amiss.

2. In the normal affectional development of the infant there is a gradual transfer of the love nature from self to the parents. Commonly, and quite naturally according to the psychologists, the mother becomes the chief object of the boy's affection and the father the chief object of the girl's affection. This is called the Oedipus period after the legend of Oedipus, who after guessing the riddle of the Sphinx became a king and married the reigning queen, who unknown to him was actually his mother.

3. In the normal order of things, usually preceding puberty, there is a still further transfer in which the parents no longer are the sole center of interest. The affections move on to a close comradeship and affection for some other person of the same sex. The boy becomes a hero worshiper of some older boy or man, or closely allies himself with a pal of his own age. The girl gets a "crush" on her lady teacher, or on some other girl, and embraces her and walks with her arm about her on every available occasion.

Disease is quite repugnant to the normal person, and arrested development is really a disease. If the brain remains that of an infant, or if a limb fails to develop, we look upon it as a great affliction. Arrested emotional development, likewise, is a disease. Youngsters just before and at the age of puberty are interested in others of their own sex. Hence their associations at this time of life should be carefully guarded lest they go emotionally astray.

Attraction toward members of the same sex is called homosexuality. Occasionally an individual becomes “fixated” at this level. This disease, so repugnant to the normal individual, is due to lack of transfer from a childish emotional object to one suitable for adult expression.

A disagreeable subject that I should feel reluctant to mention, were it not that boarding schools and other places where large numbers of children congregate on intimate terms favor their spread, is solitary habits. Authoritative investigation has shown in such places that they are more prevalent than commonly recognized. Nor should I mention such an unattractive subject at all except that it often has an important bearing on the success of marriage.

Passing over detail, the really great damage is psychological. Left without proper instructions by parents and teachers the youngster gets erroneous ideas. If normally minded, the boy or girl if not interfered with before long concludes of his own accord that his actions are unsound and ceases them. But more often than not he is discovered by some adult. This adult, instead of explaining that this is an incomplete and unsatisfactory expression of a sacred function, then throws a scare into him.

To begin with, since his infancy sex has been made of paramount importance and interest. His questions regarding it have not been fairly met. Always they have been avoided. He has been told he must do this, and he must not do that, but the reason why has remained a secret. Mystery and secrecy and the obvious avoidance of its discussion will cause anything to assume great importance and interest to the mind of a child. It must be fraught with great possibilities to be thus carefully guarded. And thus from early infancy, when first he is not permitted to exhibit his body freely, the suggestion is powerfully hammered into his unconscious mind that sex and all connected with it are amazing things. Is it any wonder, then, because the emotions are so constantly stimulated by its dramatic possibilities, that various complexes are formed in association with this subject.

The adult discovering the youth, and desiring to scare him into a sounder method of life, tells him that if he continues he will go insane. Or he tells him of other dire results that will befall. But the result is just the opposite of that expected by the adult. The emotional stress, more often than not, adds its energy to the habit and not to its cessation. As a consequence either the habit cannot be entirely broken or there are nocturnal disturbances. Reading quack advertisements may still further intensify the fear. As a result a great conflict is set up between two sections of the personality, between the inability always to act as decided upon, and the desire to act in a more sanitary manner.

It is this conflict that tends to wreck the nervous system of the unfortunate. He comes to look upon himself as an unworthy creature, as something to be shunned by others. His self-respect diminishes, and recurring acute remorse saps his vitality and extinguishes his ambition. And if, in addition, a little later in life he gets into the hands of some quack doctor who emphasizes the seriousness of his trouble, he is led to believe that he is an abnormal creature unfit for adult responsibilities. Such a belief seriously hampers the ability to make a proper marriage, and seriously handicaps the success of whatever marriage is formed.

4. In the normal development of the affectional nature, however, as the youth approaches maturity there is a very complete transfer of the love impulses to some eligible member of the opposite sex. This results in marriage.

This, according to fiction and the drama is the end. It is, to be sure, or should be, the end of adolescence, but it is merely the beginning of adult responsibilities. It certainly should not be the last step in the development of the love life.

5. In the normal expansion of the love nature there is no transfer from the husband or wife, but there is a widening of the affections markedly, a decided development in their inclusiveness that is quite significant; as much so as any of the four earlier periods. The love for the marriage partner should not grow less, nor should the relations change in any manner other than that the affections should overflow to embrace the children, which are now normally a part of the family. The marriage, which is the identification with another personality, is still further cemented by the love for and a keen interest in an object of mutual concern.

6. Children grow up, they marry and establish homes of their own. It is wise that children should do so without hindrance from parents. And at this time there is another affectional transference. If the marriage has been successful husband and wife are as devotedly in love with each other as at any time in the past. The transfer is from the children to a still wider interest. Not that the children are not still loved, but the love expands to embrace society at large. No longer confronted with the responsibility of rearing children both become interested in some project or work that is conducive to the welfare of others.

At this time of life, also, there are certain physiological changes. How these affect the physical relations depends entirely upon the temperament of the two. Such relations are not incompatible with age, neither are they necessary to the higher relation to be mentioned. I refer to regeneration. Nor is it even necessary or even wise to await this advanced period of life to attain regeneration. But, because the early novelty of married life is outgrown, because there are no more intimate discoveries to make, because the children are away from home, because the man bores his wife by talking about nothing but golf and business, and because the wife is yearly growing fatter, if the regenerate stage has not been reached by this time there is little to hold man and wife together. It is advisable to attain regeneration earlier, but if it is not attained now, the couple remain "fixated" at an affectional level below their possibilities.

This regeneration is not the same as continence although it is prohibited by excessive indulgence. It is the blending of the finer forces of man and wife accompanied by an exquisite magnetic exchange that strengthens the vitality and gives power to the ambition of both. In the early days of courtship the touch of a hand or the exchange of a kiss is sufficient to establish this ecstatic rapport. After marriage too often, this finer blend goes uncultivated, because of too exclusive attention to the physical aspects. This leaves no surplus of electromagnetic energy to be given the affectional vibratory rate for forming the perceptible magnetic union. Physical and regenerate union mutually exclude each other. And thus the biological urge being satisfied, there is little magnetic pull.

The final development of the love life, then, in so far as it normally expresses on earth, is the regenerate union of husband and wife who have expanded their love for each other and for children to embrace mankind as a whole, and who have a mutual interest in some work for the benefit of others. Such a keen mutual interest in something other than themselves is one of the strongest forces at all times to make marriage happy and successful.

7. In addition to the six stages of affectional development of normal life on earth, there is yet to be considered the spiritual union of soul-mates. There is no physical or astrological way that two people can be proved to be or not to be soul-mates. It is a theory that is supported by much analogy. The reports of the psychic senses can hardly be trusted in a matter where there is so strong an emotional bias. The value of the idea, therefore, is more philosophical than practical.

To illustrate my meaning more clearly, for a full forty years now I have observed both men and women who have decided to find their soul-mates. I have so far never known an individual who set out with this exclusive intention but who found a lot of trouble. Furthermore, when the so-called soul-mate was found by this diligent search, the union has almost never proved successful.

It is human nature to build up fictions of things as we would like them to be. It is so easy for a man or woman who is dissatisfied with the present mate to build up a fantasy that the longed for perfection is to be found in another. I have known it repeatedly to happen, however, that a person who was making a valiant effort to do something for humanity has been drawn into contact with and married another of similar aspirations. These marriages are often ideally happy, and I have no wish to disparage them. Perhaps they are soul-mates. At least they are ideally suited. But those entering them have not primarily been seeking a soul-mate; they have been seeking to do some worth while and unselfish work, and perhaps hoping the right mate would come along. My point is, that to concentrate on finding a soul-mate rather than upon being worthy of such happiness by accomplishing some unselfish work, does not, according to my observation, result satisfactorily.

Power of the Parental Image

—At any of the earlier stages of normal sexual development there may occur a total or partial “fixation.” Such arrested development is as fatal to a successful marriage as development that stops at the mental age of the twelve year old is fatal to success in a profession. Intelligence tests made during World War I indicate that an appreciable percentage of our population has never developed further mentally than the twelve year old normal child, and our psychologists have since collected data to show that about as large a percentage of other persons are still children in their emotional development. But this emotional development commonly may be brought up to normal by education. When the individual is made to recognize that he has stopped at a level of immaturity, or that he has a “fixation,” this knowledge brings about an effort toward emotional readjustment. The “fixation” is liberated, or the complexes are dissolved.

The most common “fixation,” and the only one I shall discuss—as the remedy for all is to be found in recognizing both their source and their effect upon the life—is the Oedipus complex.

The limited experience of the child provides it with no adequate standard of comparison. It comes to look upon the father or mother, therefore, as the embodiment of perfection. The child is unusually susceptible to suggestion, and this suggestion offered by early environment that the parent is the most perfect creature in the world sinks so deeply into the unconscious mind that frequently it is never eradicated. Even in later life the parent is given a certain sanctity.

Though in later life the conscious mind is aware of the imperfections of the parent, such as to be found in all mortals, still in the unconscious mind the hallowed image is still retained. The mother is the boy’s ideal of a woman, the father is the girl’s ideal of a man. These early images often exert the power of a compelling force in the selection of a mate. The energy of such an image, with all its emotional content, is stirred into activity by anything that even superficially suggests the beloved parent.

Even when the mother is a scold, any girl that looks a little like the mother will attract the young man. In fact, he is as apt to marry a girl with his mother’s faults as one with her virtues, and the quality about the girl suggesting the mother image may be so superficial that there is no other resemblance. Many a man falls desperately in love under such circumstances, quite unconscious of the reason, and then wonders later what there could have been about the girl to attract him. His real love was for the mother image which something about the girl stirred into motion.

Girls who have fathers that are drunkards are more apt to marry men who are drunkards for the same reason. Anything about a man that suggests to the unconscious mind the father sets into activity all the love that has been felt for the father. The love of father is transferred to this individual regardless of how worthy or unworthy he may be.

In these cases, which are not unusual, there has been a normal transference of affection from the parent to another and eligible object. There has not been a fixation. But the selection of a mate has been unduly influenced by the parental image.

In other instances, however, there is a more or less complete "fixation." The boy who has been unduly petted and fondled by the mother, and led to idealize her, becomes "fixated" on her as an exclusive love image. He looks in vain for a mate that is as perfect as this fictitious image of his mother. If the coddling has been carried too far he may even remain in the childish stage where responsibilities are concerned. He may never be able to break away from home, or even decide things without first consulting mother. More often he grows up in this respect, and shoulders his mother's responsibilities. He is her protector and comfort. He may even have desired to get married, but he cannot bring himself to leave mother. He is unable to make this normal emotional transfer from mother to mate.

The girl who is humored and caressed by her father has a similar experience. No other man is as good, or as brave, or as noble, as her father. It is more comfortable to mother him, and to be provided for by him than to take the hazard of matrimony. Or she may desire to marry, but be unable to leave the father, or to make the necessary emotional transfer.

Such complete "fixations" deter marriage. But more often than is commonly realized there are partial "fixations" that wreck marriages that are formed. The mother image is so strongly embedded in the unconscious of the man that immediately after marriage he compares his wife in appearance, in speech and in her work with his mother. Because the mother image is a fantasy of an ideal rather than an actual representation, the wife always suffers by comparison. "Bread like mother used to make" is a common expression of this unconscious mother image. Marriage cannot be happy where the mother image is so dominant in the unconscious of the husband. And if, in addition, the mother lives near, or is brought into the home to live, the condition becomes intolerable for the wife, who intuitively feels that the mother holds the place in her husband's affections that should belong to her.

The woman with such a partial "fixation" on the father in like manner compares the husband in all ways with the father. "Father always did it this way." "Father always provided us with..." "Father never spoke in that manner." Even when unuttered, the thoughts are there, and always unfavorable to the husband. The woman has not married a husband, she has married a father-substitute. And because the father image is merely associated with the husband, rather than the love transferred from the father to the husband, she often feels that the marriage relations are sinful. And if the father lives close by, or comes to live with them, there is no hope of a successful marriage.

Then again, women in the past have been brought up to look upon the marriage relation as something a little revolting though to be endured. They have been given the impression that for a woman to have desires is rather wicked. This early training causes an emotional inhibition due to the suggestion taking such firm root in the unconscious. There is a conflict and a consequent complex. One part of the unconscious is bent on expressing the biological need, and the other part looks with horror upon such expression. The result is that they are unable to give themselves completely. This engenders discontent upon their own part, and discontent upon the part of the marriage partner. Each feels in some manner that the other is at fault for the lack of harmony and complete expression.

In addition to these things, which proper knowledge of their cause would dissipate, men as well as women are often grossly ignorant of woman's natural reactions. They are unaware that men and women are parallel in their nervous and magnetic functions. This ignorance which prevents proper expression of the wife leads to the establishment of what the psychologists term an "incompletion complex." Such a complex is accompanied by a feeling of discontent and unhappiness, and is a grave menace to a successful marriage.

There also may be on the part of one or both other complexes, such as those explained in lesson No. 159 (See Serial Lesson Key), that have been formed through emotional conflicts early in life that are unrelated to the love life. But whatever the source of the complex, if as is usual it gives rise to a feeling of discontent—and chronic discontent is always the expression of a complex—it has a common and easily recognized way of expressing itself in the married life. The psychologists call it PROJECTION.

Projection

—As we have seen, affection may be transferred from one object to another. Likewise any condition within the unconscious, if its true nature is unknown or if there is a reluctance to face this true condition, may be transferred to the outside world. In those cases of persecution complexes where people imagine others are trying to injure them, and become so dangerous that they are locked up to prevent violence, we have the extreme example of projecting a fear within the unconscious to entirely innocent persons. A milder form of projection is the person who when a mistake is made in the office always is sure someone else is to blame.

Because of the emotional association and the close companionship between husband and wife, it is unusually common to find the wife projecting her inward discomforts to the husband, or the husband projecting his unconscious strife to the wife. The party doing the projecting believes and acts as if the other person were the cause of all the imaginary difficulties which are projections of what he feels within himself. Under such circumstances nothing the partner can do is right. No matter what the other one does, it is subject to fault-finding and criticism. The only remedy is for the person with the complex to realize the source of his discontent, and by facing the facts reconcile the clashing mental factors within himself.

At the time the children come into the world, as I have already indicated, the affections normally expand to embrace the children. Sometimes, however, the love nature of one or other of the parents is insufficiently elastic to enfold the newcomers and the partner also. Instead of expanding there is merely a transfer of affections from the mate to the children. The mate, who up to this time has been the sole object of affection, now feels an outsider. No longer is there the old responsiveness from the partner. Unless remedied, this condition frequently leads to separation. The cure is for both parents to realize that a normal development of the affectional life expands the love to embrace children without withdrawing it from the mate. In fact, the sight of the dear miniature copies of the mate should, and normally does, stimulate the love of the parents for each other.

A man or a woman who enters into business does not consider that after the papers are signed the business should run itself. Such an attitude would soon result in business failure. But many people fail to recognize that marriage is one of the most important ventures of life, and that it will no more run itself successfully than a business. To make a success of any worth while enterprise—marriage no less than any other—requires constant effort, careful planning, and vigilance to observe and strengthen weaknesses that may from time to time develop.

First of all, as in any partnership, both parties must be prepared to make sacrifices. Nor should these sacrifices all be made by one individual. Human associations, and marriage in particular, to be successful require a spirit of mutual give and take. Points where friction may develop should early be settled by some definite understanding. Some plan should be agreed upon, for instance, in regard to the use of money by the wife. What this plan is will vary with conditions, but she should not be placed in the humiliating position of a supplicant for funds, nor should the husband be placed in the position of one who is continually harassed for disbursements.

Early in the marriage, due to traits or emotional disturbances developed previously, either partner may exhibit characteristics that are intolerable. If they are handled with both firmness and kindness right at the start they are much easier managed than they are later on. If a condition arises which will ultimately result in loss of love, the sooner it is dealt with the better.

Selecting a Mate

—The best method of determining whether two persons are suited to marry is through a careful comparison of the birth charts. Something of what the birth chart reveals, however, may be determined by observation. Primarily marriage is a physical union. That this union may be satisfactory the magnetic temperament of the two should be sufficiently similar that there is a ready exchange of electromagnetic energy between them. This is not merely a feeling of attraction. It is the establishment of a rapport between them by which energy is exchanged. It is a condition that may be felt when in the other's presence closely as a blending of the finer forces. This blend and interchange of subtle energies give pleasure in being physically near to each

other, make the early marriage more satisfactory, and later make possible the transfer from the more adolescent phase of love to that of regeneration. If the electromagnetic forces are of too divergent types they will not fuse but will recoil each from the other. In astrologically determining the electromagnetic polarity the Ascendant, which is the ground wire over which the electrical energy reaches the outside world, is important, as are the planets in the first house, for these have access to the ground wire. Yet this energy which is commonly known as personal magnetism is not a simple force, but powerfully influenced by the quality of the signs occupied by Sun and Moon and the planets aspecting them; to which the vibratory rates of the Ascendant and planets in the first house are added.

Fiery signs and fiery planets do not blend with watery signs and watery planets, but if the Sun in one chart is a fiery sign and the Moon or Ascendant of another is in a fiery sign, the magnetisms may tend to fuse pleasantly. Such vibrations as are indicated by Aries united to Cancer, Capricorn united to Gemini, or Taurus united to Leo, however, unless there are other sympathetic points of contact, tend to jar upon each other.

Marriage is not merely a physical union, it is also a mental partnership. That this mental partnership shall be successful it is not necessary that both shall be equally brilliant, or both always interested in the same thing. But it is essential that both have some common mental interest Or real importance. Both may be interested in athletics, in travel, in literature, in art, in social uplift, in occultism. The more common interests the better, but at least there should be one important attraction which gives them a common and interesting ground for exchange of thought. Not only do people grow after marriage, but they should grow. Unfortunately one may grow in one direction and the other in a different way. If, therefore, they do not have a mutual intense interest they should select something for both to become interested in. It is even more essential in later life, when the passions seem less important and the early problems have been solved, that husband and wife should have something that both delight in to discuss and work for. It is mental compatibility that lends the finest flavor to domestic existence.

Marriage is also a spiritual relationship. While it is not essential that man and women have similar views and spiritual ideals, yet at least there should be tolerance and sympathetic understanding.

If one wishes to make what is considered spiritual advance, and the other opposes it as mere nonsense, the conditions are not present for proper harmony.

When to Marry

—I know of only one way in which to select a propitious time for courtship and marriage. That is by consulting the progressed aspects made in the chart of birth. While there must be a progressed aspect to the ruler of the seventh house or marriage will not take place, the dominant harmony or discord of the progressed aspects at the time largely determine how successful the particular marriage will be.

In the analysis of 100 charts of people divorced, as set forth in the book WHEN AND WHAT EVENTS WILL HAPPEN¹, it was found that at the time of their marriage 79% had discordant progressed aspects predominant, 52% had only discordant progressed aspects to the ruler of the seventh 44% had only discordant progressed aspects to the ruler of the opposite sex, and 28% had only discordant progressed aspects to Venus, the planet of affection. All of these, and 115 other charts analyzed in the same book at the time of marriage, had a progressed aspect to the ruler of the seventh house.

The analyses of the progressed aspects in the birth charts of these 215 people at the time of marriage emphasized the unwisdom of marrying at a time when the progressed aspects are dominantly discordant. While of the 100 marriages resulting in divorce 79 had discordant progressed aspects dominant, only 3 of them had harmonious progressed aspects dominant, and the remaining 18 had harmonious and discordant progressed aspects at the time rather evenly balanced. Thus unless the progressed aspects at the time are dominantly harmonious the marriage starts under a tremendous handicap.

Next in importance to the dominant progressed influence at the time is the harmony or discord of the progressed aspects to the ruler of the seventh. In 52 of the marriages resulting in divorce the only progressed aspects to the ruler of the seventh were discordant, in 17 they were harmonious only, and in the balance they were about evenly balanced. Thus marriage at a time when there are no harmonious aspects to the ruler of the seventh is rather hazardous.

The significant factor however is this: Quite a percentage of these people who divorced, later remarried when their progressed aspects were harmonious, and made a success of the later marriage.

While it is true that people fall in love at other times, they do not marry until there is a major progressed aspect to the ruler of the seventh house. Friendly progressed aspects of Venus, however, tend to make all affectional matters joyful and successful. Harmonious progressed aspects of the Moon in a man's chart, and harmonious progressed aspects of the Sun in a woman's chart, furthermore, tend to attract those of the opposite sex who are beneficial. And while any progressed aspect to the ruler of the seventh house may give the thought-cells mapped by this compartment of the finer form enough energy to attract marriage, if the marriage is to prove successful the dominant progressed aspect and at least one progressed aspect to the ruler of the seventh should be harmonious.

Just a word of caution here: An aspect to Uranus by progression excites the magnetic flow markedly and attracts others powerfully if the aspect is harmonious, and causes attraction to others powerfully even when discordant. An aspect to Neptune tends to idealize people in a way they are unable to live up to. Infatuations often take place under progressed aspects to either of these planets. The magnetic pull set up by Uranus then subsides as soon as the progressed planet is out of orb, and the imaginary qualities attributed to the person by Neptune give place to disillusionment as soon as its aspect is over. It is therefore unwise to marry when the chief influence by progression is an aspect either to Uranus or Neptune; for even if these are harmonious the attraction, which is unusually strong at the time, does not last.

Attracting a Mate

—Courtship is difficult when the ruler of the fifth house or the ruler of the seventh house is afflicted by progressed aspect, but when either of these planets receives good progressed aspects, when Venus makes favorable progressed aspects, and when the Moon in a man's chart, or the Sun in a woman's chart, makes harmonious progressed aspects, such matters move forward nicely.

Attracting a mate, as well as holding one after marriage, should not be left to chance. It is a matter of enough importance to warrant intelligent effort of the highest type. After you are convinced that a certain eligible person is suitable and desirable, the next thing to do is to gather as much information about the inclinations, tastes, and ambitions of this individual as possible. With this knowledge you are prepared for the attempt to win love, respect and devotion.

The one thing that should ever be remembered in this effort is that PLEASURE IS ATTRACTIVE AND PAIN IS REPELLENT. People are attracted to each other only because they find pleasure in each other's company. But all people do not find pleasure in the same things. Even a little strife and opposition is more pleasurable to some than entirely smooth sailing. The joys of making up may even at times compensate for a quarrel. One thing, however, is quite universal. No one wants what is too easy to get. The rare, the unusual, the difficult to procure excite desire for possession. Nor does the normal individual desire another who is a "door-mat."

Self respect engenders the respect of others, and this is an attractive quality, for people find pleasure in what they hold in high regard. Self confidence, also, is essential. In fact, what you are attempting to do, is to sell another on certain ideas in regard to yourself. Therefore, the cardinal rules of salesmanship, as stated in Lesson No. 158 (See Serial Lesson Key), all apply with equal force to courtship.

What the things are that give the most pleasure to any particular individual can only be learned through a study of that person's various biases. Those things that commonly are found to be attractive are set forth in Lessons No. 155 and 156 (See Serial Lesson Key). Being too good to a person without at the same time being firm, however, is often interpreted as being "easy" and lacking in character. The perusal of the lessons mentioned will suggest definite lines of conduct to follow. Above all, you

must keep the interest of the person to be won. It may be better even for a time to have some antagonism than to be out of mind; for antagonism at least has a chance of being converted into affection, but so long as you do not have the attention of the person there is no hope to win. To win and hold a mate you must keep him or her INTERESTED.

Demonstrating a Mate

—To formulate and hold in the mind the image of the ideal mate, endowing this image with the attributes you desire the mate to possess, and while holding this image to repeat “SOUL OF MY SOUL COME TO ME,” will certainly attract you to some person. Such procedure should be practiced with much caution, however, and without too much emphasis. In fact, it is better to formulate the image clearly, and hold a general de-sire that the ideal will someday be realized. Otherwise some person very likely will be attracted to you who in addition to some of the desired qualities may have others that are very disagreeable. Or one may be attracted who will bring much trouble and harassing situations.

Holding the Mate

—The one thing that separates more people than any other is monotony. Life is change and people demand that they shall keep interested. Sitting at the same table every day, discussing the same topics, laboring at the same employment, following a deep rutted routine, drives people to disgust with themselves and with their mates. They feel the need of the spice of adventure. So if you would hold your mate, find some way of being entertaining, and see to it that the monotony is broken at frequent intervals by something new or adventurous undertaken together. Follow all the rules of lesson No. 156 (See Serial Lesson Key) for holding a friend, and also those of lesson No. 155 (See Serial Lesson Key) for being attractive. To attract a mate you would not shuffle about unshaven, in shirt sleeves, and with hair uncombed, nor would you lounge around with hair wrapped about curling pins, dressed in a tousled kimono.

People who marry commonly are magnetically attractive to each other and have some mental interests in common. Images of the other are built up in the mind about pleasant impressions. Nor is there any fundamental reason why they should not continue to love. Once these pleasant images in the unconscious are replaced with those built around painful impressions, though, and it is very difficult to reconstruct the attractive ones.

Both jealousy, and worry because the other is becoming indifferent, are powerful mental treatments directed toward the other that tend to force him away. Jealousy is a mental force that strikes the finer body of the loved one with a violent repelling force. Fear of losing the loved one is a slow canker reaching the finer body of the other as a discord that eats away such affection as is present. Confidence that the love can be held is a mental treatment of powerful attractive force; and this, together with such actions as conduce to pleasure—particularly to interest—are powerful forces to revive and hold the other's affections.

People who wish to retain or revive their affection for each other may do so by the very simple expedient of thinking of the other as frequently as possible in association with circumstances in the present or past that are pleasurable, and avoiding painful experiences and painful thoughts while thinking of the other. This, of course, implies that the other cooperate to give pleasure and avoid pain.

Occult Considerations

—As the fortune in marriage depends primarily upon the harmony or discord of the thought-cells mapped by the seventh house, to a degree upon the harmony or discord mapped by the planet Venus, and to some extent upon the harmony or discord mapped by the planet representing the opposite sex, there is opportunity to make marriage more fortunate by giving these three sets of thought-cells more happy desires.

The thought-cells mapped by the seventh house may be given more harmonious desires by thinking pleasantly as often as possible of marriage, by using thoughts characteristic of the planet ruling the seventh house, or those which are the mental antidote (Course 9) of the planet ruling the seventh house.

If the ruler of the seventh house is afflicted, associating with objects ruled by it will increase the power of its thought-cells to attract discord where marriage is concerned. But close association with names, numbers, colors, gems and locations ruled by the planet which is most favorable to seventh house matters are influences that contribute both to the winning and the holding of the mate. They help somewhat to make marriage successful.

Chapter 11

Serial No. 161
Original Copyright 1944
Elbert Benjamine

Copyright
August 2002
Church of Light

How To Have A Pleasant Home

Chapter 11

How to Have A Pleasant Home



HOME embraces animate objects and those inanimate. It is a location, permanent or transitory, fitted with certain conveniences and occupied by certain persons. The location has a bearing upon it as a pleasant place to reside. This is worthy of some consideration. Securing the place and its inanimate accessories also is important and should receive attention. But while not neglecting these features, because the pleasure derived from a home so greatly depends upon the people in it, much of this lesson will be devoted to the successful handling of domestic associates.

As to choice of location, several things must be observed. The city or section of the country where a home must be made usually is decided by financial necessity. But within the radius of a reasonable proximity to business interests there usually is a wide variety of differently environed localities from which to choose. Some people, for instance, like to live in the lowlands. Others prefer the heights. Some must be by the water to be happy, and some delight only where there is plenty of wind and little moisture. Then again, there are those who are content only with plenty of close neighbors, while still others, out of working hours must be free from any sense of crowding. The not too close rumble of traffic, or the buzz and grind of machinery, is music to certain ears and rank discord to others.

This diversity of likes and dislikes is not mere passing fancy. It is grounded in the responsiveness of the astral body. Certain types of environment—depending upon the comparative height of the land, its closeness to water, its proximity to people following specific occupations, its accessibility to fresh winds, etc.—have a very definite vibration. This vibratory rate reaches and has an influence upon all the people living within the given locality. If it is a rate that corresponds in frequency to thought-cells discordantly organized within the astral body of a person, it adds its energy to the discord and assists in attracting disagreeable events and unhappiness. But if the environment corresponds in rate of vibration to thought-cells within the astral body that have been harmoniously organized, it increases the power of these harmonious thought-cells, thus attracting agreeable events and making for happiness.

Selecting the Home

—Selecting an environment for health consists of choosing one ruled by that influence in the birth chart most favorable to health. The preference of a location for business should be one ruled by the influence in the birth chart most favorable to business. Likewise, the choice of a locality for the home should be made upon a similar basis. It should be a situation ruled by the influence in the birth chart most harmonious to that which it is desired should prosper. This prosperity desired—unless it is a matter of real estate investment—is not so much that of the house as that of the person living in it. Therefore, the locality should be one ruled by the influence in the birth chart most favorable to the person. This influence is usually that of the sign occupied by the best planet in the chart.

After the locality has been selected, the next thing is to acquire, either through building or purchase, a suitable house and its furnishings. Individual tastes differ markedly as to the kind of house desired and the type of furnishings it should contain. Some people like dainty, artistic things. Others wish things that are more substantial. There is just one broad rule to follow. The temperament and leanings of those who are to live in the home should be considered and things should be arranged in reference to these tastes to give as much pleasure and comfort as possible.

If the man of the house, for instance, is engaged in work that soils his hands and clothes, he must not be made to feel he is an alien in the house because every room in it is so neat and exquisite that he will spoil something if he comes into it just as he comes from work. He should feel there is one room at least where he is welcome and can be comfortable just as he is, until he is rested enough to prepare himself for more delicate surroundings. Unless the home welcomes him as a place of comfort and satisfaction, he will come to dislike it, will come to dislike the work which causes him to feel uncomfortable in the home, and probably end by feeling dislike for those in the home who make him unwelcome unless he is immaculate.

Dirt of any kind is abhorrent. But many a mother has been such a slave to cleanliness and order that she has driven her husband and her children from her. A little mud on the carpet was more important than the happiness of her family. Everyone in the house felt constrained. It was recognized that freedom of action might get something disordered or a little soiled or in some way upset the precision with which the house was kept. And that this would precipitate a storm. But it seems to me that the function of the home is to conduce to the comfort and pleasure of its inmates.

Visualizing a Home

—With a home in mind such as would be compatible to those who are to occupy it, the next step is to visualize it clearly. That is, form a picture of it in the mind each day, if possible at a regular time. This image should stand out as clearly as possible, and be held consistently for a few minutes at least, and longer if feasible. The holding of this image before the mind should be accompanied by the feeling of assurance that it will be realized objectively. To still further impress the idea on the unconscious mind you may at the same time repeat THIS IS MY HOME WHICH IS BEING ATTRACTED TO ME.

The unconscious mind, with such an idea so constantly before it, utilizes many avenues for the accomplishment of the purpose that is closed to the objective mind. This does not mean that you may not have to work and make sacrifices for the home you vision. None of the means ordinarily employed to procure a home should be neglected. But it signifies that an image so impressed upon the unconscious mind has a power to divert both invisible and more material energies into its fulfillment. Such an image confidently held in the mind exerts a power toward realization.

But whether this ideal image has as yet been realized or not, you, as well as others, must live somewhere. Whether or not this somewhere arises to the dignity of being called a home, if others are closely associated with you, their influence more than any other probably contributes to making for the discomfort or for the pleasure you experience. It is the attitude and the actions of people that commonly make or mar a home. Therefore, the most important factor in establishing a pleasant home is to be able to direct into pleasant channels the actions and speech of those in it.

The Uncomfortable Home

—Again I must point out that a home is attractive in proportion to the amount of comfort and pleasure it affords. When young people, or their elders, spend too many evenings away from home the cause is easy to diagnose, although it may be a difficult matter to cure. It is because they find more pleasure somewhere else than they find in the home.

Homes that are full of wrangling and discord, that are uncomfortable from any cause, that are uninteresting and drab, drive husbands and wives as well as young people to seek relaxation elsewhere. If it is a stuffy place, or too noisy, or the chairs are too hard, it is far too much to expect of human nature for father to do much reading, for mother to feel contented, or for the children to remain at home except to eat and sleep. And an atmosphere of austerity will drive any bright youngster away.

People mostly forget in training their children, in training themselves, and in influencing others that pleasure is attractive and that pain is repellent.

Few things are more painful than monotony. A home with nothing to do but disagreeable work is not attractive. A home into which enjoyable companions can come is a different thing. But what a comparison there is between a home in which everyone must sit just so, and must speak precisely, and must do this and must not do that, and the night life of a jazz age. Sparkle and movement and excitement, other people of kindred age and taste, all bent on having a good time. Nothing to do at home but sit about and listen to someone grumble. Is it any wonder some of the youngsters are wild?

And the same thing may be said of sex. Every mention of it at home is met with rebuke. It is something mysterious, something to be shunned, and about which no information can be gained. But elsewhere than in the home it is given a different aspect. The schoolmates and the other youngsters that go on joy rides and drink gin are full of ideas about it. Many of these notions are incorrect, but at least they are fascinating. Sex, by the jazz crowd, is considered as nothing but a source of pleasure. It is made just as alluring as possible, and no mention is made of the pain arising from its abuse.

In the home any mention of sex gives rise to discomfort, but this discomfort is not associated with sex, but with those who administer the rebuke. The youngster feels unfairly treated when he can get no direct answer on a subject in which he has become vitally interested. This rebuff is associated with the person administering it. But when companions talk, it is of the pleasures. Not having full information he feels his elders, for some obstinate reason, have been swindling him out of these pleasures. Monotonous and dreary homes drive young people to spend their evenings elsewhere. And lack of complete information, by emphasizing the pleasures and suppressing the dangers of sex, is the surest application of psychological principles to make for youthful delinquency.

Pleasant Homes

—A home to be pleasant, and therefore attractive, must be provided not only with certain physical comforts and conveniences, but with interests. Movement and change are as necessary to human welfare as are food and shelter. Books and periodicals should not be lacking; perhaps occasional entertaining, perhaps some better music over the radio, but at least some diversion is an essential for a happy home.

Everyone in the home contributes to its interest or to its severity, to its harmony or its discord, and to its attractiveness or lack of it. Everyone in the home is a bundle of habits. These habits have all been acquired. Such habit systems, while some may have become quite stable, undergo greater or less modifications. The modifications can be made greater through the effort of the individual or the influence of his associates.

The home habit systems are not the same as the school habit systems, or the business habit systems, or the company habit systems. It is true, however, that a certain habit system may carry over into other departments of life. It may be so thoroughly established as a part of the character that it expresses in all environments and under all conditions. A man may have a habit system of straight-thinking, a habit system of unselfishness, a habit system of honesty, a habit system of initiative, or a habit system of kindness that persists in every environment. But quite commonly, in fact more commonly, a person is one type of individual in his public life and quite different at home.

In developing the habit systems of children and in correcting the habit systems of elders, ourselves included, a well defined method should always be followed. And if intelligence is exercised in its application the results will be very satisfying.

In principle it is very simple, although in its application it stresses the ingenuity and inventive ability to the breaking point. It consists in devising means by which in some manner PLEASURE may be associated with the desirable habit or trait of character.

The opposite principle of causing PAIN to be associated with the undesirable traits and actions seldom has a use, and must always be applied with circumspection. Its application may be considered as admitting lack of ingenuity to find and properly apply a PLEASURE ASSOCIATION. It is very difficult to administer pain without the pain being associated with the person responsible for its administration rather than with the trait or the action. And painful experiences and emotions build into the finer body of the individual discordant energies that in turn tend to attract misfortune.

There is probably no one in the common run of homes who at times does not exhibit characteristics that cause others unpleasantness. Some people have moods, some are unreasonably touchy upon certain subjects, some speak too abruptly, some nag, some act too boisterously, some tend to bickering, some to little selfish actions, some to outbursts of anger, some to emotional scenes and weeping. The individual who is poised and pleasant at all times, who on all occasions respects the feelings and rights of others, and who does not let the wear and tear of competitive life at times fray his nerves to a raw edge, is all too uncommon. Everyone associated with the home usually could contribute more to its success.

Yet whatever the little mannerisms, the little selfishness, the thoughtless actions, or the emotions by which the home is made less pleasant, we may be sure they arise from one of two sources: Either there has been some defect in the training and emotional development in the past, or a condition has arisen in the present that stimulates undesirable expressions. It may be something existing in the home, but more often it is an emotional disturbance within the unconscious which results from some problem not related to the home for which no adequate solution has been found.

Changing Objectionable Traits

—The very first thing to do, then, is to take a thorough inventory of the conduct of those in the home as affecting it as a pleasant place in which to live. In all situations where a number of people are closely associated it is necessary, of course, to make some allowance for temperament and to cultivate a spirit of cheerful give and take. But the emotional traits, or temperamental peculiarities, or the kind of actions of each individual in the home, including oneself, that contributes to unpleasantness can with a little observation and thought be tabulated. And another list of actions and traits that could contribute positively to the enjoyment of home life may as easily be prepared. Such lists give a definite objective toward which to work.

Next, because a great many annoying actions and a great many emotional disturbances have their seat in the unconscious, and the individual expressing them thinks he is so doing for reasons very different from the real ones, each of these disagreeable actions and traits should be analyzed to determine its real cause.

In previous lessons of this course I have pointed out the cause of boasting, the cause of never admitting a mistake, the cause of violent temper, the cause of hysteria, the cause of chronic apologizing, the cause of shyness, the cause of timidity, the cause of contrariness, and the cause of various other traits. These arise from emotional disturbances or maladjusted ideas developed in childhood. Unreasonable emotions and peculiar conduct always arise from conflicts within the personality. They are the result of ideas that have not become reconciled to each other. Such, as well as conditions arising in the present of a more objective nature, that cause disharmony in the home should be traced to their source.

It will be found that many annoying actions and emotional storms of one kind and another are merely ways by which the unconscious strives to have its own way. They are devices, unrecognized by the conscious mind as such, by which the unconscious mind strives to get what it wants. The child that kicks and squalls and makes such a nuisance of himself that he is finally permitted to do something that was forbidden, has developed a technique in his unconscious that may carry over into adult life as sulkiness, as tempestuous anger, or as other emotional states which he detests and strives in vain to conquer.

It may be the individual, at some period of the past, has got what he wanted or has received notice or sympathy through sulking or other emotional expression. The conscious mind may abhor the use of such methods to gain its ends. But the unconscious mind has had a different training. If it has found it can get what it wants through staging a dramatic scene, through raising a rumpus, through threatening

others, threatening to end the individual's life, or through tears and wailing, it will not hesitate to use such means in spite of the vigorous protest of the conscious mind. And next to getting what it wants the unconscious mind likes notice and sympathy. It joys in being the center of the stage. It fattens its feeling of importance on the attention it attracts from others.

To cure the unconscious of using such manifestly unfair means to gain its ends, whatever those ends may be, the others in the home should pay no attention to the individual during the emotional manifestation. Nothing quite so effectively impresses the unconscious mind that its efforts are misdirected as to have its antics ignored.

Furthermore, means should be devised by which the person who attempts to influence others by being disagreeable should always fail to gain his ends by it.

In this the inventive quality of the mind often must be exercised to its fullest powers to prevent the failure to attain the desired end becoming associated in the person's mind with the home or with the persons in the home. It must be handled in such a way that it is perfectly clear to the individual that neither persons nor the home is in any way responsible for the pain of frustrated desire, but that his desire was not realized because he used an unprofitable method of procedure.

Fully as important, and supplementing this, some method should be devised by which the person gains something pleasurable when he refrains from using disagreeable methods to gain his ends. It should be so obvious that he can have no doubt in his own mind that the pleasure came to him because of his good conduct. It may be only praise, or it may be something tangible; but it should not be neglected; for the unconscious mind is led by its pleasures.

The husband who bullies and the wife who nags are equally amenable to such handling. But whether the method be applied to a child or an adult, great care should be exercised that a spirit of antagonism is not aroused.

Indifference to unreasonable conduct is completely discouraging to the feeling of self-importance of the actor; but if carried out in too studied a manner it may be interpreted as active antagonism. The unconscious applying emotional technique to unfairly gain an advantage over another can find a satisfactory substitute outlet in a quarrel. It takes two to make a fight, it is said, so the indifference should not be carried to a point where the individual really is justified in feeling aggrieved. Much finesse is required in its application.

Cause of Emotional Outbursts

—In the unconscious of every person there have been built up certain very strong fundamental desires. These belong to ten distinct categories. Both before life in human form and since human birth the emotions and feelings which accompany all the individual's experiences add their energy to one of ten groups of thought-cells within the finer form. Each of these groups of thought-cells is mapped in the chart of birth by one of the ten planets, and each group is mapped as to the volume of its energy, the department of life with which chiefly associated, and as to its harmony or discord by the house position and aspects of the planet mapping it.

The more feeling or emotional energy the soul has experienced relative to the phases of life mapped by a planet, the more prominent that planet appears in the chart of birth, and the more energy the group of thought-cells have which it maps. The more energy the group has the more powerful are the desires of the thought-cells of the group.

Thus the more prominent the Sun is in the birth chart the more powerful are the desires for significance; the more prominent the Moon is in the birth chart the more powerful are the desires for home and offspring; the more prominent Mercury is in the birth chart the more powerful are the desires for intellectual activity; the more prominent Venus is in the birth chart the more powerful are the desires for affection, for companionship and for the beautiful; the more prominent Mars is in the birth chart the more powerful are the desires for sex and constructive or destructive activity; the more prominent Jupiter is in the birth chart the more powerful are the desires for joviality and good will; the more prominent Saturn is in the birth chart the more powerful are the desires for safety; the more prominent Uranus is in the birth chart the more powerful are the desires for originality; the more prominent Neptune is in the birth chart the more powerful are the desires for the ideal; and the more prominent Pluto is in the birth chart the more powerful are the desires for cooperation or coercion.

Thus the birth chart indicates both the power and certain general trends of the desires within the unconscious before these have been given still more energy and special trends through experiences following birth into human form. Experiences after human birth may facilitate a more harmonious or facilitate a more discordant expression of the desire energy stored in any of the ten groups of thought-cells. And through thus facilitating repeated expressions of these desires, they may condition the individual to release the desire energy rather violently with little external stimulation.

A desire, when stimulated may express itself chiefly in action; in moving physically to attain the realization of the desire. But if it is stimulated without finding any other outlet for the energy thus released by the thought-cells, the thought-cell energy is imparted to the electromagnetism of the nervous system and expresses as an emotion.

Any of the ten groups of thought-cells may release its desire energy either in physical action or in an emotion. Emotions, which are violent disturbances of the nerve currents, are valuable to many animals to enable them to meet emergency situations. For instance, the call for conflict stimulates anger, and the realization of inability to handle a situation stimulates fear. Not all emotions are valuable, however. Thus sorrow is stimulated by the realization of a loss. More beneficial in human life, belief that a fond desire will be realized stimulates hope; the realization of a fond hope stimulates joy; and the thought or presence of a love object stimulates passion or love.

Emotions properly utilized to turn the energies into constructive activities are a great boon; but when they dominate the individual they are tyrants that thwart his aims and give great annoyance to others. As explained in lesson No. 157 (See Serial Lesson Key), the desire energies of each of the ten groups of thought-cells should be given adequate opportunity for expression—for they cannot successfully be repressed—in some beneficial activity. Thus to train them, however, requires that the individual should recondition his own habit-systems. This is a difficult task for anyone; and, human nature being what it is, it is unlikely those in the home can be induced to make such an effort.

We can, however, by understanding what causes others to give way to emotional outbursts, do much to prevent such disagreeable occurrences. About the surest way to cause such an outburst in another is abruptly and suddenly to block some desire. The energy of the desire, not having time to find a substitute outlet, flows over the dam of self-restraint as emotion. The more freely and strongly the desire is flowing—that is, moving toward realization with no prospect of disappointment—and the more abruptly it is blocked, the greater the emotional storm. It makes no difference if the obstacle comes from without or from within, when a strong desire is suddenly thwarted, the flood of emotional energy engendered presses for an outlet with tremendous force.

Some immediate desire, that to others seems trivial, under certain circumstances may when frustrated cause disproportionate emotional expression. When dammed up it flows back upon itself to a point where it connects up with the whole group of fundamental desires with which it is related. This association of it in the unconscious with the more fundamental desires stimulates them into activity. In reality, the emotional outburst is not the energy of this one rather unimportant desire; but the combined energy of a whole group of deep seated allied desires which have been called upon to furnish reinforcements.

When either children or adults manifest disproportionately violent emotions when things do not happen as they wish, we may be sure that fundamental desires or conflicts deep in the unconscious have been tapped. The real condition should then be sought out and relieved by a recognition of its source and by providing a suitable and constructive channel for the outlet of this outlaw energy.

Among other things, a progressed aspect to a given planet indicates that the thought-cell group mapped by this planet in the birth chart is receiving much more energy than it normally does. Because it thus has more energy its desires are correspondingly more insistent.

The events which come into an individual's life under a progressed aspect may be chiefly due to his actions, or they may be due to the work of his thought-cells on the inner plane exercising extra-physical power. But in addition to events attracted which seem not to have been influenced in any way by the individual's behavior, every progressed aspect influences his thinking. And if the progressed aspect is discordant, or is to a particularly discordant planet in the chart of birth, the feelings and desires of that planetary type are both increased and apt to be similarly discordant. Thus an individual during a period while the dominant progressed aspects are harmonious may be much more pleasant to have in the home than during another period when the dominant progressed aspects in his chart are highly discordant.

But aside from progressed aspects, frequent stimulation of the same impulse or wish without providing it with an outlet is like flecking the flesh in the same spot with a lash. The first blow or two may only sting, but as it is continued the place becomes raw. Each additional impact of the whip increases the inflammation until at last it is unendurably sensitive.

Take the desire for self-esteem, for instance. Father, perhaps, has hoped for a raise in salary. He feels it his due, but the raise has failed to arrive. Instead, lately he has been reprimanded on several occasions by his employer. He is doing his best, but seems to be making no progress. A new man has been placed with him to work in the same department, and the new man, although lacking in experience, refuses to take orders. Furthermore, some of his acquaintances in other departments, perceiving his difficulties, joke him about the new man, and that the new man will probably have his job before long. Thus, through various channels, his self-esteem becomes sensitized.

Under any similar circumstances, all the wife or child needs to do to raise a seemingly quite unreasonable storm is to mention something that father may construe as questioning his ability or success in life. Let the wife ask if he is always going to work for the present salary. Or suggest that she is ashamed to ride in the old car and that they should be able to afford a new one. Or mention that their neighbor seems such a smart man, he got a raise in pay just last week.

The emotional reaction that then occurs will seem absolutely incomprehensible to mother. What really happens is that a whole set of incidents thwarting his desire for advancement has been stimulating and blocking the fundamental desire for self-esteem. What mother says may be quite unimportant, but if it still further stimulates this desire stream without providing a constructive outlet, the energy will express in discordant channels.

Furthermore, if desires belonging to any fundamental group are repeatedly thwarted without their energy finding a substitute outlet, the individual becomes unduly sensitive to everything in any way related to the fundamental desire. He may be so “touchy” about certain things that no one dares mention them in his presence. Where such a condition exists the proper thing is to trace these baffled desires to their source and then work for a proper readjustment of the mental life by which their energy may be released in some productive endeavor.

Whatever the disagreeable trait by which a member of the home causes others unpleasantness, after its real underlying cause has been ascertained, the individual himself should if possible be led diplomatically to recognize the source of these actions. Even if the actions are not of a deep-seated emotional nature, but merely the result of selfishness, indifference, carelessness, and a disregard of the feelings and rights of others, it is well that he should understand this. And without exciting antagonism, and without causing him to feel unjustly treated, he should be made to realize by all other members of the family that such conduct results in no gain to himself. As a third and final factor, he should be given the opportunity to learn through experience that when he refrains from such actions his life is more pleasant. And the more immediately the pleasure follows, and the more directly it appeals to the senses, the more effective it is apt to be.

Government of the Home

—The home is a miniature state. As such it has its financial problems, its problems of government, and its problems of production. All the members have certain duties and obligations, and if these clearly are defined so that each member knows just what work he is expected to do, just what is expected of him in regard to earning or spending money, and just what conduct in regard to others is expected of him, it prevents much misunderstanding.

States are governed in a variety of ways, as are homes. There are absolute monarchies, dictatorships, republics, democracies, and communistic associations. Monarchies and dictatorships, while very effective economically for a time under a wise ruler, psychologically are unsound, and do not lead to the happiness and proper development of those ruled. They attack two of the groups of fundamental desires, the desire for self-esteem, and the desire to express individuality. The ruler may have the power to force submission in action, but smoldering revolt will burn in the breasts

of his subjects and flame into open rebellion whenever his power begins to wane. When in the home everyone must without question take orders from one individual, regardless of the soundness of his decisions, it makes for blocked desires, repressions, and discords.

Where there are children, or where some have greater ability and experience than others, the communistic method cannot be recommended in the home. But for happiness either in state or home a member must not have his individuality crushed out by the arbitrary authority of another. Yet in many homes we have just such an exercise of power.

Either father or mother often becomes the sole dictator of family life without regard to any special ability to direct its destiny successfully. More often it is because in earlier life the technique has been learned by which others are dominated. The family submits to being bossed, because it is less painful than the disturbance that results when the dictator is defied or even reasoned with.

But we may be sure of this, no one likes to be ordered about. The husband or the wife may give in and say nothing rather than have a row, even when there is certain knowledge that the policy advocated by the other is not the best. Yet underneath, in the unconscious, there rankles the sense of injustice.

People—husbands, wives, children, employees, citizens—have opinions and like to have some say about running their own affairs. To refuse to hear their side of the story, to fail to give consideration to their plans, to ignore their views as of little consequence, is a direct attack on their self-esteem. Down in the unconscious there is sure to be engendered resentment. This is cumulative. Every additional instance in which the individual viewpoint is ignored means stimulating the desire for self-esteem and at the same time blocking its expression.

By and by the citizens of a country that does not permit them to work intelligently for what they believe to be better conditions rise up in revolt and overthrow the arbitrary authority. The employees, likewise, who are not permitted to take their grievances to someone with the power to remedy them, and who are given no hearing in regard to bettering their condition, after a time go on strike. Wives put up with husbands who are less competent than themselves yet who brook no suggestions from the wives; and husbands put up with wives who direct their mutual policies though quite incompetent to do so, often for many years. But in time the discord of wounded self-esteem and the accumulated feeling of injustice brings an end to affection and leads to separation. And children to whom no explanation that they can comprehend is given, but from whom implicit obedience is demanded, remain under parental authority only until they can get away from it. Even while at home they are in a state of inward rebellion.

The extent to which any member of the family should exercise governing authority should depend upon his ability to direct it successfully. One member is often very competent in financial matters, but not so competent as another in managing the home, or in training the children. Such abilities should be carefully analyzed in the light of past experience and the birth chart, and authority exercised in a given field only by the one most competent.

Yet to have a pleasant home, this authority should not be used arbitrarily. The individual exercising authority in any walk of life should bear in mind that the sudden and arbitrary blocking of desire stirs up emotional discord. Instead of such blocking, if the desire may not be realized, the person should be brought to see why it should not be realized. He should be given consideration, and as much information as possible. He should be made to feel that the one in authority is kindly disposed toward him, and led to a comprehension that will cause him to direct his desires into more acceptable channels. Such methods are applicable by governments dealing with citizens, by capitalists and labor unions in dealing with each other, and by parents dealing with children. And as often as possible, when the desire is not such as can find expression, some pleasant substitute should be suggested to absorb its energies.

It is not expected, of course, that all members of a family will view life from the same angle. It would be strange if there were not differences of opinion on many matters. And for harmony and the success of the family it is not necessary that all should be won over to a single view.

People of different temperaments and people of different experiences draw different conclusions from the same set of facts. Because of this it is now considered sound business practice for the executive head of a business to have associated with him another able man of opposite temperament. If the executive is optimistic and expansive, he needs as his associate someone who is conservative and careful. If the executive is rather pessimistic, he needs for associate some person of lighter moods and more confidence in the bright future. So in the home also, we may expect to find different temperaments and that they may be made to contribute, each in its particular way, to the success of the family life.

But that such divergencies may not cause discord, each must learn to respect the views of the others. The attempt to control the opinions of others through conflict, mental or physical, fails alike in the state and in the home. Tolerance of opposing views and tolerance of actions that are not approved of so long as these are harmless, make for the contentment of all.

When a reprimand becomes necessary, it should be applied with diplomacy. This is equally true in the home, in the office and in the factory. A reprimand made publicly or before others attacks the self-esteem. Self-esteem seldom permits the unconscious to acknowledge a moral wrong before a number of other people. To do so makes the unconscious feel too inferior. Therefore, instead of admitting the fault it builds up numerous frictions to excuse itself and to transfer the blame elsewhere. Even if there

is force at hand to compel the admission of moral wrong publicly, the unconscious is in a state of rebellion against the admission. If such force is not at hand the energies launch an open attack to justify the action, and if it is at hand a campaign of justification follows secretly.

Instead of delivering the reprimand in a manner that stirs up antagonism, and perhaps spoils its whole object, it should be administered or implied privately. And while no room for doubt should be left as to the consequences should the error be repeated, it is a good policy whenever possible to leave a loophole by which the individual can save his face. If he can manage to retain his self-esteem, his efforts have the opportunity of endeavoring to correct the fault. But if the self-esteem is injured the energies are so concerned with antagonism toward the one associated with the humiliation that little or none may be directed toward preventing a recurrence of the condition.

Because everyone in the home contributes to its pleasure and its sorrow, the effort should be made to regulate the conduct of each member in such a way as to contribute as much of interest and harmony as possible. This effort is directed toward influencing the conduct of others. It cannot successfully be done by scolding, by demanding, or by threatening. People cannot be driven into harmonious cooperative activity. They are led by their desires, and the secret of influencing conduct anywhere is the wise selection and presentation of desirable thoughts, opportunities, and things.

Due to their different vibratory rates certain people always get on each other's nerves. Where this is noticeable between members of a family, or between members of society, it is always best not to make such individuals associate closely. The radiations from the finer body of one person may be actively destructive to the finer body of another. It is a great misfortune when such people must come too intimately in contact. Usually it may be devised so that even when living in the same home they are not compelled to be too much in each other's physical presence.

Then again, other people who are not ordinarily discordant to each other may have differences of opinion, or may have misunderstandings, or one may inadvertently or otherwise hurt the feelings of the other.

When two people have a grievance against each other, in the home or out of it, because the thought of the other comes so strongly before the attention due to the emotional associations, and because action is in the direction of attention, they are apt to be drawn into each other's presence. Even though objectively unaware of it, the unconscious mind directs their steps where the emotional discord will have opportunity to express itself. Even though both have resolutely determined to treat each other pleasantly, because there is discord in the unconscious associated with the other, almost automatically, and perhaps to the surprise of both, their contact develops into an unpleasant exchange.

Under such conditions, until sufficient time has elapsed for the emotions to subside and the thought of hurt or resentment to give place to a more coldly analytical frame of mind, it is better for such people resolutely to avoid contact, and particularly to avoid any reference to the cause of contention.

After sufficient lapse of time, if they approach the matter with a determination to adjust the difficulty, or if another wisely undertakes to bring about such an adjustment, it can usually be accomplished.

In the case of the home it should be approached from the standpoint of the good of the home as well as the good of the individual. In the case of the state, the good of society should take precedence. Both, or all, the contending individuals should be made to see the value of their cooperation to the larger group. They should be shown that contention is not beneficial to themselves, and ruinous to the home or country. It is not that either should feel compelled to give in to the other, or take action that will cause a permanent feeling of dissatisfaction. Instead, a course should be searched out that will enable the individuals to compose their differences, not by defeating each other, but by some plan not repellent to either that has the larger advantage of benefitting a greater group.

Nest Habits

—We have now discussed the more important causes of unpleasantness in the home, and I trust have indicated how these various annoying features may be removed. It would seem with monotony routed, with disagreeable emotional factors corrected, with unpleasant actions eliminated, with contentions harmoniously composed and in their places numerous pleasures, that nothing more might be expected of a home.

But especially where children are involved there must be cultivated a willingness at the proper time to leave this safe haven. The wife, too often, is so relieved of the responsibility of financial management that when left a widow she is quite unprepared to take care of what she may inherit. And the children face a still more serious situation.

If home is nothing but pleasure, if it shields them without cultivating a sense of responsibility, they are unprepared for the normal step of adult life, the shoving out into the world and establishing a home of their own. A fixation may develop where the home is concerned. So-called nest-habits may become so strong that they dread to marry, hesitate to leave the comforts to which they have become accustomed for the uncertainty of a different environment.

Children should not be held at home after maturity. Too inseparable an attachment for parents should be discouraged. Too great dependence of children on parents or of parents on children hampers the proper development of individuality. Individuality and self reliance are among the most valuable qualities that life can develop. One of the purposes of normal life is frustrated when children and parents fail at the proper time to lead independent lives. Children should be trained, therefore, to feel that it is a

glorious thing to fulfill this important purpose of life to establish a home of their own; and in this home through the avoidance of painful experiences and the cultivation of those enjoyable, to make of it another pleasant home.

Chapter 12

Serial No. 162
Original Copyright 1944
Elbert Benjamine

Copyright
August 2002
Church of Light

How To Be Happy

Chapter 12

How To Be Happy



HAT which gives rise to happiness depends upon the conditioning of the individual; for it is an emotion of a particular kind which is not called into expression universally by any given set of events. Due to different conditioning by experience, the same set of objective conditions arising in the lives of two people may make one discontented and the other happy. The emotional reactions of an individual are largely acquired through his experience with environment.

A thousand dollars in the bank to a man who previously has been poverty stricken may make him feel wealthy, while the same amount to one who has had millions may give the feeling of poverty. Yet there are fundamental desires common to human life which, given special trends by experience, nevertheless cry out for satisfaction. Their adequate realization is a source of joy, and establishes that harmonious emotional state which we commonly call happiness.

In the problem of happiness, therefore, we have two sets of factors. We have those desires which like hunger and the urge for self preservation are a part of our biological inheritance, and others, sometimes equally as strong, like the urge for religion, which are the outgrowth of environment. These fundamental yearnings are so thoroughly interwoven within the structure of the unconscious mind that even though the person is unaware of them consciously, unless they find expression they produce those inharmonious stresses in the astral body that give the feeling of discontent.

The second set of factors relates to the manner in which experience influences the emotional reactions to the various circumstances of life. It was indicated in lesson No. 155 (See Serial Lesson Key) that the child is born with no definite emotional reactions toward different objects, and it was shown that through associating certain experiences with it a child can be made to fear any object, or to become angry at sight of it, or to feel great joy in its presence. Objects in themselves are not the cause of the emotions they arouse by their presence. The emotions are aroused by the thoughts stimulated by the objects, and these are given their quality through mentally associating the objects with experiences in the past.

Sometimes these two sets of factors are brought into conflict. The experiences of life may be such as to cause a feeling of abhorrence toward some situation. Yet there may be a fundamental urge that can only find satisfaction in some such situation. The classical example, given so wide publicity through Freudian literature, is that of the sex impulses. Puritanical teachings, or some early unfortunate emotional experience, may make the conscious mind revolt at the thought of sex. Yet, because it is a fundamental urge, unless it finds expression in some associate channel, its striving for satisfaction is a source of chronic disquiet.

The emotion of unhappiness arises from a conflict of mental factors. If this conflict becomes too severe it causes a mental breakdown, commonly called nervous prostration.

Mental factors may fail to adjust themselves harmoniously to each other for a wide variety of causes. Their clashes with one another upset the harmony of the astral body and give rise to the feeling of dissatisfaction. The only way by which the emotional harmony may then be restored is not by crushing the resistance of the revolting mental factors, but by providing a plan by which they can be induced to spend their energies in a manner harmonious to the other mental factors. Even when the impact of physical environment is extremely harsh, if all the mental factors work together harmoniously, this inward harmony is recognized as happiness.

Reconciling the Desires of Thought-Cells Within the Unconscious

—Because of discordant conditioning, certain groups of thought-cells not only work from the inner plane to attract into the life unfortunate events, but if they have been associated with powerful fundamental desires they may, when stimulated by some environmental condition, so dominate the individual that he moves at their behest in spite of warnings by reason to do the opposite. He may feel within himself two strong but conflicting impulses; one to act as intelligence suggests, and the other to act according to the dictates of feeling. And the feeling that thus wells up from within, which may become powerful enough entirely to dominate the thinking and actions of the individual, has its source in the release of energy from some group of thought-cells.

In olden times there was neither knowledge of thought-cells within the finer form nor of physical cells within the material body. But there was knowledge that within the finer form of man were intelligences which had desires, and that the desires of these intelligences attracted fortune or misfortune into the life, and often strove to dominate his actions. Until rather recently they, together with certain other intelligences, were referred to as sub-mundane atoms of life, or by some such similar name. Coming down from very ancient times is a mantram of seven paragraphs¹ which is given to all Church of Light members. In paragraph 5 and paragraph 6 is the statement of the effort through which each Church of Light member strives to make

progress; the effort properly to recondition the thought-cells, or sub-mundane atoms of life, within his finer form so that they will cooperate with one another in assisting him to live the kind of life he has decided is best.

“5. I am progressing rapidly toward the subjugation of matter and the complete lordship over all submundane atoms of life, which exist only by my permission, as peaceful and obedient servants within the lower animal realms of my dominion.

“6. They exist by virtue of their functions in the work of creation which I am now assisting, but they are, and ever must be, subservient to the higher realms of Spirit to which I by right belong.”

That energies or intelligences of the inner plane do commonly dominate material conditions can be verified by anyone who has given careful study to the events which come into human lives coincident with progressed aspects, and the events that affect even inanimate objects, such as ships that go to sea, in response to planetary vibrations. The thought here is not that matter should be subjugated by inner-plane forces and intelligences—as this is the common state of affairs—but that the individual should so develop and harmonize the groups of thought-cells within himself that he attracts into his life the kind of conditions and events he desires, and thus subjugates material conditions to his will.

The mantram further points out, not merely the function of the thought-cells within his own soul, and that they should be obedient to the individual’s desires—and they can be made thus obedient only by proper reconditioning—but that they are and ever must be subservient to the higher realm of spirit to which the individual belongs. It states who is boss, and it also states why the individual should be boss rather than be dominated by some group of thought-cells.

The mantram includes several other important matters also, but as two of the total of seven statements relate to these sub-mundane atoms of life, it will be seen that the ancient masters placed great importance on their control. In fact, the only way in which the individual can direct his life, rather than have it controlled by other forces and intelligences within or without himself, is to induce the thought-cells and thought-cell groups to work for the ends he has decided to reach. And if that end, among others, is happiness, they must be induced to work together harmoniously.

This does not imply that the physical environment should be ignored. It means, instead, that all the desires, all the events of life, and every circumstance of the physical environment need to be understood in their true relation to the life. When this proper relation to the individual is discerned, steps may be taken by which each contributes in some manner to the harmony of the astral body, and therefore to the harmony of the mind, and thus advance the happiness.

Whatever else the ascetic who denies the normal demands of the body may or may not attain, he does not attain what we customarily term happiness. He may gain certain powers that give him some satisfaction, or he may take pride in his triumph over natural tendencies, but there is not complete inward harmony. Desires that have been crushed by the weight of an opposing will are not peaceful subjects, nor are they dead. They persist as revolutionary minorities, always on the alert to overthrow, even temporarily, the control exercised over them. They spread their discontent to associate factions and cause these also at times to rise without warning against the central authority.

Self-indulgence, of course, is not the road to happiness. It is but one of two unhappy extremes.

In over forty years devoted to occult studies, twenty-nine of which up to date has been spent in Los Angeles teaching astrological and occult classes every week, I have been brought in contact with an unusually large number of those following various methods of asceticism. Out of all these individuals, who in some way mortify the body in the attempt to gain spirituality, including those from India and other far off lands, I have yet to see one whom I consider emotionally well balanced. Some, to be sure, who travel about teaching ascetic methods, are not so strict in their own lives. But those who are—and there are hermits and little groups here and there in various parts of the Southwest—I have found to be much more easily upset in their emotions than ordinary people. They become vastly excited over rather inconsequential events. They develop acute fears which are out of all proportion to dangers that may threaten. And they fly into uncontrolled rage with very little provocation. They are well meaning, but the insubordinates in their mental realm take advantage of every opportunity to create a discordant emotional disturbance. From what I know of their lives I cannot believe they are happier than others.

Still another type believes the world is very sinful, and that the way to spirituality is to live apart from it. The monasteries that are so prevalent in the Orient today, and those that once played so important a part in the history of Christianity, are an outgrowth of this conception.

Modern psychologists have taken the pains very thoroughly to dig to the bottom of this idea. It is in truth but another method of fleeing from reality. The human mind when it finds conditions that are hard to face, even as a soldier who meets a doughty foe, feels inclined to run away. The child in bed at night hears a noise, is afraid to look in that direction because it fears seeing something awful, so hides its head under the covers. An adult meets some conditions that seem too awful to face, so he turns his mind away from external conditions. He refuses to recognize reality because it has become too difficult. If he persistently does this he is called insane.

Taking refuge in an isolated life, or one otherwise sheltered from the harshness of worldly contact, is just another way of fleeing from reality. Such flight, because it prevents the expression of some of the fundamental urges, is not a safe road to happiness.

There is still another and more common way by which people flee from reality. It is through unwittingly substituting fiction for fact. The unconscious is unwilling to admit the imperfection of the individual and instead of facing the fact that certain difficulties arise from his own error, he holds to the conviction all his troubles are due to the mistakes and unjust antagonisms of others. Fearing he may lose the love of one very dear to him, he magnifies little actions, places undue significance on chance meetings, and implies designs to others that have never entered their heads. This path of jealousy departs from fact and substitutes a condition that exists only in the jealous person's mind.

Haughty seclusiveness, snobbery, whining, bitterness and boasting are all methods by which people attempt to maintain self-esteem by substituting a fictitious state of affairs for reality. Likewise, self pity, self-excuse, and all forms of conceit are means that serve the same mendacious ends.

Nothing that can happen in life should make of us cowards. Our responsibility ceases when we have done the best we can under the circumstances; but we should not be afraid to face facts and conditions. These may be disagreeable, but let us look them straight in the eye. When they are recognized for what they are, this alone deprives them of most of their power to stimulate conflict between mental factors. This willingness and ability to face whatever facts life holds is one of the longest steps toward happiness that most persons can take.

Among these facts it should be recognized that the body is endowed to perform certain functions. It should be perceived that in the normal course of human life there are definite responsibilities to be shouldered. And it should be admitted that advancement from level to level in knowledge and spirituality throughout life is to be desired.

The strongest of all fundamental desires, as I have indicated in previous lessons, is the urge for self-esteem. It belongs to the **Power** Urges ruled in astrology by the **Sun**. The conscious mind often accepts the idea of inferiority, but the unconscious resists and never does fully accept it. Even in those religions which teach the necessity of killing out all thought of self, the followers take pride in their excessive humbleness, and are filled with self-esteem because they are less selfish than others.

The desire for significance is insistent and will not be blocked. It will find normal expression, or failing this manifest surreptitiously in some inharmonious method of compensation. It finds a normal outlet in courageously accepting all the responsibilities of life.

To side-step these responsibilities engenders a conscious feeling of inferiority that compels the unconscious to invent some fiction to escape admitting inadequacy.

Each individual owes it to himself and to society to make as much as possible of his life. The development of his various powers will be a source of satisfaction to him. Their use not only to benefit himself but to benefit others will gratify his feelings of importance. In fact, whether others recognize one's worth or not, there is nothing that so fully conduces to proper self-esteem as the accomplishment of something which conduces to the welfare and happiness of others.

But one should not approach these responsibilities, or whatever in the way of accomplishment that is decided upon to induce an honest feeling of self-esteem, as a duty. However laudable an act may be, if it is forced or otherwise associated with disagreeable feelings, it does not enter into harmonious relations with other mental factors. Instead, it exercises a discordant influence. The endeavors, therefore, that are undertaken to promote happiness, including those that conduce to self-esteem, should have as many pleasant associations as possible. They should be looked upon with deep satisfaction.

Another fundamental desire of human life of great insistence is the urge for adventure. Life in all its forms has had a constant struggle to adapt itself to continuously changing conditions. From the first protoplasm to exist on earth to the finest trained human brain, survival has depended upon successful adaptation to new environments. The desire for new experiences, therefore, has behind it the pressure of inheritance of over a million generations. It should not be denied.

Routine engenders a feeling of mediocrity, and this fails to bring happiness. But change, if there is an element of uncertainty about it, or if it brings the individual into contact with new conditions, gives rise to a feeling of self-expansiveness. In a manner the individuality has extended itself, and feels the thrill of a larger existence.

This love of adventure, of new and somewhat exciting experiences, is one of the **Aggressive** urges ruled in astrology by the planet **Mars**. It is one of the group of desires that finds expression in overcoming difficulties, in strife, and in destruction and construction. Full and beneficial expression of the other tendencies of this group can be had through efforts directed into any constructive enterprise. This feeling of overcoming difficulties, of triumphing over opposition, and of building something—whether a house, a business, or a piece of literature—is a source of great satisfaction. And emotional satisfaction is happiness.

But the love of adventure part of these urges is not satisfied merely with constructive activity. It calls for new conditions to be encountered, and the swift emotional responses aroused by them. This finds full expression in various forms of recreation. The playing of games gives it full satisfaction with some. Going to the movies and vicariously enjoying the perils, the loves, and the triumphs of the screen stars is a common avenue for its expression. Or it may be had through sympathy for the chief actors in works of fiction, or through travel, or through listening to the encounters of opposing athletic teams or individuals as described over the radio. It matters little which method is employed, the important thing is to in some manner get a little taste of adventure now and then. Break up the monotony. Experience a little excitement,

get a thrill out of something new and unusual, something beautiful, or something grand. Do not root and grow in one spot. Do something, harmless but unusual, now and then, just for the fun of the thing. Enjoy doing it. It brings emotional satisfaction, and this is happiness.

Quite as far back in our biological ancestry as the urge to resist invasion and the urge for change there developed the desire for security. All beings seek and desire security, even though at the same time there is the desire for adventure. Men desire security from sickness, from accidental injury and death, from poverty now and from want in old age. They desire security for themselves and for their families and loved ones. Uncertainty of employment, financial losses, ill-health, the threat of separation from loved ones, and fears of every kind, disturb the desire for security, produce worry, and result in unhappiness.

These **Safety** urges, ruled in astrology by the planet **Saturn**, cause as much unhappiness in life as all the other desires combined. It is not that people commonly do not express the urge for security, but that all too often they express it in a discordant way.

Just how to go about it to attain this security, so ardently desired by all, has been set forth in the lessons on how to keep young, how to be attractive, how to have friends, how to get employment, how to make money, how to achieve honors, how to be successful in marriage, and how to have a pleasant home. Little more, therefore, need be said on the method to be employed in obtaining security. Nor need it be urged especially, seeing that most people spend much of their energy in seeking security in one way or another, that happiness demands that this desire for safety shall find ample expression. Of course, some people are reckless, and squander their health, their money, and their energies in riotous living. But few nowadays believe that these people are happy. Instead of emphasizing the necessity of expressing the urges for security, the great necessity is for people to learn to express it only in harmonious ways.

The happiest people in the worlds according to my observation, are those who are eagerly trying to do something. There is certainly such a thing as too much work and too little play; but plenty of work of some kind is a necessity to keep the ordinary person from becoming discontented. Neither the idle rich nor the idle poor are happy. To be idle, not to be striving for something, is against the habits built into the unconscious by all our animal and human ancestors. Life too long has been compelled to strive for something in order to survive to be able to cease such struggle now without cloying the appetite for life itself. Eagerness to accomplish something, and active effort to accomplish it are powerful accessories to happiness.

Yet whether this work is prompted by a desire for security, a desire for honor, or a desire to contribute something to the welfare and happiness of others, if it is to confer happiness the attention must hold to the desired goal, to the striven-for end, to the exclusion of the thought of its opposite.

Unfortunately for happiness, we are all too often brought face to face with conditions that threaten to deprive us of some security. It may be actual loss or actual danger or merely threatened loss, threatened injury or threatened disappointment. But whether there is actual deprivation, or merely a possibility of it, the image of it in our mind is painful. Painful images, from whatever source arising, conduces to unhappiness.

We should not, of course, refuse to admit a condition when it is present. But if it is a condition that causes anxiety, fear, depression or other painful mental states it is better not to view or consider it further than is necessary to formulate a proper course of action. Movement is in the direction of the image held in the mind, and if the image of a painful state of affairs is held before the attention, there is a movement of both the physical energies and those of the unconscious mind toward its fulfillment. Furthermore, such discordant feelings build discordant thought-cells into the astral body, and these in turn work from the inner plane to attract still more misfortune. No one can afford to harbor fears, worries, or other unpleasant thoughts.

Instead of thinking about these various lacks, or about the possibility of insecurity of any kind, the mind should think so energetically about the things that can be done and that should be done to provide for security that no part of the attention can wander to the thought of its lack. If at times the disagreeable thoughts are very persistent, it may be necessary to displace them, as explained in lesson No. 152 (See Serial Lesson Key), with the thoughts of the most pleasant experience in the life. But under ordinary circumstances, even if for a time things seem to be going badly, the thoughts may be trained to focus on accomplishment, rather than on lack of anything or danger of its loss. This gives a free and harmonious expression to the fundamental desire for security, and thus adds to the feeling of well being and happiness.

The four most insistent urges in human life, and those therefore that must require some adequate expression are the desire for self-esteem, the desire for adventure, the desire for security and the desire for response. Such is the classification of our most eminent psychologists.

The desire for response embraces the **Social** urges, in astrology ruled by the planet **Venus**. It has to do with friendship, with love, and with marriage and reproduction. There is so much literature on the subject of psychoanalysis easily accessible that most people are now aware that the repression of the sexual nature always brings difficulty into the life and results in unhappiness.

But because of this we cannot advise all people to marry. There are some people who always attract great discord when closely associated with the opposite sex. The chart of birth may indicate that the nuptial relations will result in tragedy, or that some great misfortune will follow entering into such close relations. Or it may be that it indicates that the loved one cannot be obtained. Or various obstacles may make marriage inadvisable.

The sexual attribute, however, need not express itself in any one particular channel. That its promptings are there should not be denied. Yet recognizing the source of unrest in itself tends to release the repression, and from that it is but a step to finding some other and more acceptable outlet. Even in marriage there is often a lack of full expression for this fundamental and insistent impulse. Lesson No. 160 (See Serial Lesson Key) goes more into the detail of this. I do not here mean the development of the feeling of incompleteness, but that adequate expression of this urge makes it necessary to love someone or something more than you love yourself.

When something, some cause, some work, some individual is found that you can love more than you love yourself, it is possible to sublimate the sexual energies to a higher plane of activity. They then find adequate expression in this non-physical type of love. There are no repressions but instead a satisfying expression of the desire for response through this substitute channel. Many of the noblest tasks in the world have been accomplished by those who have thus sublimated their love, and they have found happiness in these tasks.

Of somewhat less frequent power in human life, in addition to the four groups of urges mentioned, there are six others. In some people they exert all the forces, or sometimes more, of those considered. But in other people they are not insistent urges. They, therefore, are less universal in application.

The **Domestic** urges, ruled in astrology by the **Moon**, belong to these. They are the desire for a home, the desire for children, the desire to care for and look after the welfare of someone or some creature less competent than oneself. A popular writer has classified both men and women into three types as regards their domestic desires. One cares more for the mate as a lover than for business or children. One cares more for business and not a great deal for either mate or children. The third type cares primarily for home and children, and business and a mate are important only as contributing to these. Thus we have the sweetheart type, the bachelor type, and the home loving type.

Some people, as their birth charts plainly indicate, are quite unfitted for various reasons to raise children. Others have no particular leaning in this direction, and it would be unwise to force family life upon them. Yet the domestic urges are strong enough in every individual that he never attains as much happiness as he might if he does not find opportunity for their expression. Down in his unconscious, inherited from many generations of animals that took joy in protecting and rearing their young, there is a desire that may be so deeply buried as to cause no discomfort. Yet if it finds expression through looking after the welfare of some other weaker human being, or even some animal, it gives a profound feeling of satisfaction. To those who are adapted to it, few things bring as much lasting emotional satisfaction and therefore happiness as the rearing of a family.

Another quite universal desire among human beings commonly expresses in the worship of some being or power superior to man. This desire, along with that to find a satisfactory philosophy of life, and the desire to benefit one's fellow man, belongs to the **Religious** urges, ruled in astrology by the planet **Jupiter**.

These urges have no set form, but express according to environment, temperament and education. One person finds ample satisfaction for his religious urges in going to church every Sunday and observing a strict code of conduct in all the affairs of his life. Another expresses the same group of urges quite as completely by reverently watching the sunset, admiring the flowers, the birds and the trees, and seeing the handiwork of the Great Architect in the snow-capped mountain and the white water of a glorious waterfall. Even the atheist and the agnostic very frequently find the religious urges insistent. They express them, however, not in worship of a supreme power, and not in perceiving in the beauty and grandeur any influence beyond the material, but in acts of philanthropy.

When the religious urges are strong, some opportunity of expressing them should be provided. How they express must be determined by the intellectual and spiritual level of the persons. Yet it may be said with considerable definiteness that nearly everyone has a strong desire to find some satisfactory philosophy of life. He yearns to know why he is here, where he came from, what he should do about it, and whither, if anywhere, he sojourns after the dissolution of the physical. When he finds a solution to these perplexities that to him seems adequate—whether or not it be adequate to another—he experiences a deep emotional satisfaction. It is a satisfaction that contributes to happiness.

Throughout the ages man has been compelled to escape his enemies and to find food and shelter, to use intelligence. Because reason is a faculty so recently developed in evolution, real thinking is the hardest work done by man. Even though this be true, in most people there is a craving to know the why and how of things. It is exercise of such curiosity that has led man to outdistance other animal life.

Such desires belong to the **Intellectual** urges, in astrology ruled by the planet **Mercury**. I do not say that a man cannot be happy without giving considerable exercise to his intelligence; but I do feel sure that the acquiring of knowledge is an added source of satisfaction. It is a satisfaction of less emotional volume, no doubt, than that obtained through the realization of more fundamental desires. But it is on a plane where the pleasure derived is more exquisite and enduring. It therefore adds quality as well as quantity to the happiness.

Something about human nature also demands the individual in some particular to be different from others. The herd instinct is strong; but even so, each one likes to be distinct from his fellows. There is a desire for originality. It may express in the wearing of a dress that is not just the same as others are wearing, or in having something new and unique about the latest car. It is the desire for a distinct individuality. It resents too complete standardization, is ever on the alert for new and better ways of doing things, for new and better ideas, and for short cuts to improvement.

Such desires belong to the **Individualistic** urges, ruled in astrology by **Uranus**. They are not very insistent in the lives of most people. But when they do find expression they give a satisfaction that adds to the happiness.

Two more groups of urges remain to be considered. One is the **Utopian** urges, a group in astrology ruled by **Neptune**. It embraces those various yearnings for ideal conditions. It causes the individual to seek beyond the physical for satisfaction. It gives rise to the urge for spiritual things, and makes one feel that life is only worth while if spiritual advancement is being made.

These utopian urges are the most insistent of all desires in the lives of certain people, while they have almost no power in the lives of others. If the desire is there, no greater sense of satisfaction can be had than that arising from the assurance that one is making real spiritual progress. To those that sense the value of living the life of the spirit, no greater satisfaction can come, and consequently no greater contribution to happiness, than that arising from earnest spiritual endeavor.

The other group embraces the **Universal Welfare** urges, in astrology ruled by **Pluto**. These also find their greatest satisfaction in spirituality. But instead of being content merely to attain high levels of consciousness in which there is awareness of union with the all-pervading presence of Deity, this group must express through aggressive activity in which there is cooperation with others to attain a mutually beneficial end.

Cooperation with others in group activity may provide adequate satisfaction for the universal welfare urges. But more refined and enjoyable satisfaction is gained when the cooperative effort is to benefit a large number of people. And its greatest satisfaction comes when the individual tunes in on the all pervading presence of Deity sufficiently to recognize that he has a specific work to do in the cosmic scheme, and then devotes his life to this task, cooperating with others in the realization of the Deific Plan and thus contributing his utmost to universal welfare. His highest satisfaction comes not merely in dreaming of spirituality, and not merely in feeling spiritual levels tuned in on, but in aggressive spiritual activity.

Supreme Happiness

—Supreme happiness requires that all the various groups of desires find satisfactory expression. The person in whose life any one of the ten urges finds no outlet may be reasonably happy, but he has not attained to all the happiness possible to him.

On the other hand, and this must not be overlooked, the mere expression of the different desires may lead neither to satisfaction nor happiness. For happiness to result the stronger desires must find satisfaction, and this satisfaction is not derived from mere expression, but from harmonious expression.

Even a fundamental desire is better repressed than given too discordant an outlet. And because certain groups of desires may be discordantly organized in the astral body, it may be exceedingly difficult to express them without attracting into the life misfortunes that contribute even more to unhappiness. I know of only one way by which such conditions may be determined. It is by a scrutiny of the birth chart.

If the Safety urges, as shown by the aspects to Saturn in the birth chart, are too discordant, many of the efforts in life to provide security will attract discordant conditions. This does not mean that all thoughts of security should be abandoned, or that security may not be obtained. But it signifies that the efforts in the direction of security must be selected with unusual care, and with reference to the birth chart, so that they may be directed into special channels that are not so discordant. The Safety urges should find expression; but if the birth chart shows afflictions in this respect, the expression is better narrowed to small but harmonious channels.

So also with the desire for self-esteem. If the Sun is severely afflicted in the birth chart, the more usual methods of gaining self-esteem through contact with powerful persons will bring much discord, and therefore unhappiness, into the life. A careful survey, however, will reveal certain things that can be done that will not attract such discord, or even if it does, it will compensate in satisfaction for the discord. Thus the attempt to gain self-esteem will not result, as it otherwise might, in a failure that would give rise to discontent. At least, through such careful consideration a plan may be mapped by which the power urges may find maximum satisfaction and thus lend themselves to happiness.

Then again, if the planet Mars in the birth chart is severely aspected, considerable circumspection must be used in the expression of the desire for adventure. Unless such expression is conducted wisely, accidents, strife, and even tragedies may accompany such expression and the result be the reverse of happiness. Yet a study of the birth chart will indicate where the desire may find harmonious outlet, and furthermore the periods of life when certain efforts may be undertaken in reasonable safety, and at the same time show the periods when they are unduly dangerous.

The same considerations may well be applied not merely to the desire for response and the domestic urges, but to all the strong and insistent desires of life. Some people should never marry and some should never attempt to have children, because of the misfortune sure to follow such steps. Yet these individuals need not repress their desires for response and for parenthood. There are substitute channels that can be found into which these desires can be diverted that will permit satisfactory expression, and that will not attract disaster into the life. The greatest happiness

requires adequate expression of the fundamental and insistent desires that reside within the unconscious mind. But to secure that happiness the channels of expression should be chosen that do not attract undue misfortune. The birth chart reveals these channels.

We have so much discussed the necessity of expressing the fundamental desires that it may appear that one should have his mind on himself much of the time. But nothing could be further from the truth. Distrustfulness, timidity, shyness, inability to make love, hate, vacillation, jealousy, sulkiness, contemptuousness, moroseness, etc., and many other unhappy attitudes of mind are common only to people who think a great deal about themselves.

There Must Be Interest Outside of Self

—Happiness can only be obtained by going out from oneself. There must be some outside interest; for the self-centered mind is never happy. It is usually too much thinking about oneself and the effect of everything upon oneself, that prevents the expression of the insistent urges. The individual who is not self centered is not bashful, and while he may not make love well, yet he finds no difficulty in making love. He is not unduly concerned over his welfare, and so has no hesitation about making changes and experiencing some adventure. He does not fear want, and therefore gets pleasure from expressing the desire for security through working consistently and joyfully to that end. He neither places himself on a pedestal, nor considers himself a weakling; and therefore, from doing the best he knows how under all circumstances he derives satisfaction for the desire for self-esteem.

Only those who learn how to go out from themselves are happy. When an individual is too interested in other people's welfare to think about fancied slights, or about aches and pains, he has learned something about happiness. If he can smile, even when things seem rather difficult for himself, just to cheer someone else up, he has taken another step in the direction of a happy life. Happiness to this extent is contagious, that when we give happiness to others, it in some similar measure returns to us.

To make the picture somewhat clearer, the happy person takes little pride in accumulations; but much pride in his achievements—which may include the use of accumulations—that have advanced in some manner the interests of mankind. He is not a slave to duty; but earnestly endeavors to accomplish something in life because he enjoys contributing to the world's welfare. Instead of making of life a dull grind, he enters into whatever he puts his hand to as one more glorious adventure.

And whatever he is doing he thinks about pleasantly and whole-heartedly. He does not wish he were somewhere else, or doing something else, while he is compelled to do the thing at hand. Such divisions of interest and desire split the mental factors up into jarring factions. But if the interest is kept on the thing that is being done, no such discords develop.

Sometimes, to be sure, there are desires that tend to pull in different directions at the same time. Such a condition creates acute mental unrest. Yet with care and application a solution can always be found by which the conflicting desires are reconciled. If the advantages of each are thoroughly considered, and the disadvantages, and then the whole carefully inspected from the viewpoint of the greatest good to the personality in the long run, a plan can always be developed that will not be opposed by either set of desires. That is, such elements of both as are not compatible with the ultimate welfare of the individual, when they are fully recognized as such by the unconscious, will be eliminated. The factors of both that do contribute to the ultimate welfare of the individual, by the very fact of being so recognized, will enter into cooperative effort. In this manner all conflicting desires can be integrated into a harmonious stream of effort, the expression of which will be realized as happiness.

Still another consideration in the expression of life's energies is that quality is even more important than volume. These various desires that we have been discussing may be expressed on different planes. They may find expression on a level little above gross animality. On the other hand, they may be expressed through channels of utmost refinement. The more refined the channel of expression the greater the joy experienced, and the more intense the happiness.

This refinement of mind and body by which greater enjoyment and satisfaction are experienced is progress in the direction of true spirituality. True spirituality also includes the use of the various powers and possibilities not merely for the benefit of self, but for the benefit of society as a whole. Yet, as we have seen, self-centeredness makes for a contracted life which so limits the freedom of expression that it leads to discontent. You, I am sure, have never known a really selfish person who was not discontented and therefore unhappy. On the other hand, I am equally confident, you have never known a truly happy person who was not intensely interested in someone or something outside himself. Yet refinement and the endeavor to benefit others constitute true spirituality. The most happy people in the world are spiritual people.

This mention of the word spirituality is all too apt to present a vision of various "don'ts." But this is a very erroneous impression. Spirituality is not a matter of not doing things, but a matter of doing something that elevates the individual and benefits, at least in some small measure, mankind.

Some Oriental philosophy, to be sure, insists on the "don'ts." The orthodox church also insists on the "don'ts." But from the view of practical occultism both are wrong.

Acts that debase the mind, make gross the body and coarsen the feelings certainly are anything but spiritual. Acts that injure others or tend to degrade mankind are not spiritual. But why give so much attention to these things, when we know that action is always in the direction of the mental image? These tendencies as a rule are inherited from our animal ancestry. Some of them, about which demagogues rave, are not very important one way or another. And those that are important will have far less power if they are not so much noticed. What they need is not antagonism, but a carefully

thought out plan by which desires developed in animals lower than man can be diverted into socially acceptable channels. Give their energies constructive expression and there will be no need to fight them.

Instead of being taught that being spiritual consists of being dull and foregoing most of the pleasures of life, or that it consists of being a slave to duty, it should be taught that spirituality is the method of life that yields the highest pleasure and the maximum of enjoyment.

Happiness does not come spontaneously. It is something to be acquired through proper habit formation; and like tennis or golf it may be acquired by almost anyone who is willing to make the effort to undergo consistent training.

The individual who has found the line of endeavor in which he can render greatest service to humanity, who has learned how to find pleasure in all that he does, who makes effort to refine his body, intellect and feelings, and who has taken the pains to find harmonious channels of expression for all his insistent desires, is one of the happiest people in the world.

The greatest happiness possible to any individual results from the cultivation of habit systems that have the furtherance of these four aims as their object.

Book 15

Copyright
August 2002
Church of Light

Weather Predicting

Chapter 1

Serial No. 190
Original Copyright 1949
Elbert Benjamin

Copyright
August 2002
Church of Light

Astrological Weather Predicting

Chapter 1

Astrological Weather Predicting



WEATHER predicting according to the Hermetic System here set forth is exclusively astrological. Variations in solar radiation as affecting the temperature and consequent weather changes are not considered, nor are sun-spot periods which undoubtedly have much influence upon the weather, nor volcanic eruptions which shut heat from the earth by extensive blankets of dust. The electromagnetic and physical conditions which influence the weather are ignored, and instead the attention is directed exclusively to the manner in which the inner-plane weather tends to change the physical weather from its normal trend during the season at any place selected.

The inner-plane weather mapped by astrological positions has an influence on all earthly things and enterprises. In *Evolution of Life*, Section 1 of Course 12, it is pointed out how the inner-plane weather influenced both inorganic and organic evolution. Even though they are not aware it is influencing them, Church of Light research has proved that inanimate objects and other life-forms as well as man are powerfully influenced by the inner-plane weather. It is pointed out in lesson No. 127 that a machine built at one time will not last as long as a machine built at a more favorable time. Many farmers have learned that crops planted at a time when the outer-plane weather seems favorable do not do so well as when planted when the inner-plane weather is favorable. Our research has proved that animals respond to progressed aspects in the same manner as do men, due allowance being made for the evolutionary level of the animal. As one illustration, in lesson No. 127, the precise birth chart and the picture of a dog, together with the progressed aspects coincident with fourteen different events in his life are given.

If, as demonstrated, the inner-plane weather profoundly influences all other things on earth it would indeed be strange if it did not also profoundly influence the outer-plane weather. That it does do so has been verified by a great many Church of Light and other students who have tested out the system of astrological weather predicting here set forth since its principles were published sixteen years ago.

There are seven different branches of astrology, the facts about which so far verified being set forth in seven different Brotherhood of Light courses. There is no implication that we know all there is to know about any branch of astrology. And The Church of Light maintains an active Astrological Research Department which works hard to acquire new and important information about astrology. But relative to each of the seven branches we believe, in addition to considerable detail, we are in possession of knowledge of its fundamental principles.

In a broad sense all seven branches of astrology operate on the same general principle, the principle that the inner-plane weather mapped by astrological positions has a profound influence on what happens here below. But in the detail of how knowledge may be gained of just what inner-plane weather is being brought to bear on physical conditions or life-forms there is some variation.

Astrological Signatures

—This branch of astrology is based upon painstaking observation of the parallels which exist between the heavenly positions and worldly affairs. It is the application of this branch of astrology which indicates the relation between astrological factors and spiritual ideas, and the relation between astrological factors and religious or other periodical observances on earth, such as are explained in Course VII, Spiritual Astrology. And it is its function to determine the kind of a chart and the type of progressed aspects used in natal astrology, horary astrology, mundane astrology, stellar diagnosis and weather predicting. Astrological signatures determines the relation between astrological positions and mental and physical conditions and the chart and progressions to use to gain the desired information.

Natal Astrology

—This branch of astrology deals with the character of people, groups of people under a single governing authority, enterprises, life-forms other than man, and other things which have a definite moment of birth. And with the manner they are apt to react to inner-plane weather subsequent to birth.

The principle involved is that a person or other thing is born only at the time when the astrological weather is similar to its inner-plane organization. It is not born at other times because the pressure of the inner-plane weather is too strongly opposed then to its birth. But when the inner-plane weather is similar to its inner-plane organization this pressure opposing birth is no longer present, and a pressure favoring birth is present.

This inner-plane organization may represent any variety of evolutionary levels from that of bacteria, protozoa, a fruit fly, or a mammal, to a man of genius. But whatever the evolutionary level, the astrological chart at birth maps the relations of the various inner-plane factors with much consistency.

After birth, the life-form is influenced by subsequent inner-plane weather. And the astrological factors mapping the energies of the inner-plane weather brought to bear upon the inner-plane organization of the individual are those of major progressions, minor progressions and transit progressions. From observing how people customarily react to inner-plane weather mapped by certain progressed aspects, much can be foretold as to the thoughts, behavior and the events that will enter the individual's life unless, aware of these progressed aspects, he takes precautionary actions to change what otherwise would happen.

Horary Astrology

—Enterprises may be mental as well as physical. Thoughts are inner-plane energies, and may be inner-plane organizations. When some question undergoes formulation in the mind, a mental offspring is in process of gestation. And when the question becomes clear and is expressed verbally or in writing the mental offspring at that moment has its birth. A birth chart erected for the place and the precise moment where the question is given birth will reveal as much about its possibilities, and what will transpire relative to it in the future, as the birth chart of an individual will reveal his possibilities and what is likely to transpire to him in the future.

Furthermore, our Research Department has found, through checking a vast number of charts thus erected relative to which events have later transpired, that major, minor and transit progressions work as effectively, and in the same way, with horary charts as they do with natal charts.

If the chart as a whole indicates that the question asked about will not take place, no progressed aspect will cause it to happen. But if the chart as a whole indicates the question asked about will take place, the time it will take place is indicated by a progressed aspect which at that time must be within the one effective degree of orb. If the event—or a series of them relative to the question—is a major event, there must at the time it happens be a major progressed aspect involving a planet characteristic of the event and a major progressed aspect involving the ruler of the house which rules the department of life relating to the event. If the event is a minor one, a minor progressed aspect involving a planet characteristic of the event and a minor progressed aspect involving the ruler of the house which governs the department of life relating to the event may be sufficient, although customarily there is a major progressed aspect also indicating it. And if the event is an inconsequential one, a transit progressed aspect involving a planet characteristic of the event and a transit progressed aspect involving the ruler of the house which governs the department of life relating to the event may be sufficient, although customarily there is also either a major or a minor progressed aspect also indicating it.

Furthermore, in horary charts, for a major event to happen, the major progressed aspect must be reinforced by a minor progressed aspect and released by a transit progressed aspect, and for a minor event to happen, the minor progressed aspect must be released by a transit progressed aspect precisely as in natal astrology. The astrological factors indicating what will happen and when, relative to a mental birth are closely similar to those indicating what will happen and when, to that which is physically born.

Stellar Diagnosis

This is a specialized section of natal astrology. The birth chart constants and the —progressed constants for 160 different diseases are given in Course XVI, Stellar Healing. The birth chart constants indicate toward what diseases the individual is predisposed. The progressed constants indicate those periods of the life when, due to the progressed aspects that will be present, there will be likelihood that a disease toward which there is a predisposition will develop. The indicated disease will not develop unless the progressed aspects are present which are the constants of the disease.

These constants not only indicate that precautionary actions should be taken against certain diseases, and that special precautionary actions should be taken during those periods when the progressed constants make it possible for a disease toward which there is a predisposition to develop, but they also indicate the nature of the precautionary actions that should be taken.

Mundane Astrology

—This is the science of the influence of the heavenly bodies as they affect the world, nations, cities, communities and other groups of people. Any organization of individuals functioning under a common governing authority constitutes an entity. As such it attracts to itself fortunate and unfortunate events in a manner quite similar to that in which like events are attracted into the life of man. Both have birth charts which if known correctly map their characters; and both are influenced by picking up, radio fashion, inner-plane vibrations through changes in their finer structures which are mapped by progressed aspects.

When the birth chart of a nation, city or other group is known, the influence of the inner-plane weather on it, and its probable response to the inner-plane weather in thought, behavior and the events which come into its life, are handled in the manner charts and progressed aspects are handled in natal astrology, horary astrology and stellar diagnosis.

But supplementing such knowledge, and giving quite a clear picture of the inner-plane weather affecting such groups, are cycle charts erected for the headquarters of the group, or the capital of the nation, at the precise moment a planet moves from south to north declination, or in the case of the Moon, at the moment of its conjunction with the Sun, using the Local Mean Time at the indicated place.

This is the birth chart of the cycle of the planet involved, and indicates the fortune of affairs under the rulership of, or influenced by, the particular planet. Such cycle charts used in Mundane astrology also are progressed. But the only planet thus progressed is the planet for which the cycle chart was erected. This planet is progressed only by its transit movement as shown in the ephemeris for that calendar period. The aspects this planet makes with the positions of the planets in its cycle birth chart indicate when each event indicated by the cycle birth chart will happen.

Spiritual Astrology

—Birth charts are not erected in spiritual astrology. Spiritual astrology relates to the pressure of astrological influences as affecting the moral conceptions of groups of people, and the pressure exerted by astrological energies to make ceremonies and customs conform to inner-plane weather mapped by astrological positions. In Course VII, *Spiritual Astrology*, the spiritual conception and the traditional story illustrating it, are given for each of the 48 ancient constellations. And in the reference book, *Star Lore of All Ages*, the astrological significance of 30 different holidays is given. These holidays are observed only at the particular time of year when the astrological positions correspond to the significance of the holiday. If the attempt is made to hold them at some other time of year, either the holiday reverts to its original day, or its observance soon ceases.

As an example of this, during the period when Franklin Delano Roosevelt was president of the United States for the third time, influential business men presented the idea to him that the two holidays, Thanksgiving and Christmas, were too close together. They held, and most business men concurred, that there would be more sales if Thanksgiving were held earlier in the autumn, so that people could recoup financially from the spending at this holiday before the time to spend Christmas money. It was a period when increasing business was a main objective of the government, and Roosevelt announced that henceforth Thanksgiving would be held earlier. And for a year or two he made the presidential announcement of the day on which Thanksgiving was to be celebrated earlier in the month of November.

But even though Thanksgiving is established each year by presidential announcement, and the President proclaimed the day on which it was to be held several weeks earlier, the attempt to hold the festival on an inappropriate astrological day—for the Sun was then in Scorpio instead of the Jupiter thanksgiving sign Sagittarius—failed. In some states two Thanksgivings were held, one on the day proclaimed by the President, and one on the accustomed day which was thus designated by the Governor of the state. In other states people were indifferent to a

Thanksgiving which they felt somehow was not right. To be normal, as explained in *Astrological Lore of All Ages*, Thanksgiving must take place during the time the Sun is in the Sagittarius decanate of the sign of religion, Sagittarius, the decanate the key-word of which is Devotion. Prayer is an essential part of the Thanksgiving ceremony, as is Jupiter abundance. Therefore, in spite of the merchants, supported by the President of the U.S., the people drifted back to the appropriate astrological day.

Weather Predicting

—To determine the influence of the inner-plane weather on the outer-plane weather there is no birth chart of weather as a whole that can be ascertained, for the weather has been in existence as long as there has been a planet earth. However, there are definite periods during which the weather normally functions. The three significant factors of the weather are the temperature, the air movement, and the precipitation of moisture. Therefore, what we need is the birth chart of each period affecting the temperature, the birth chart of each period affecting the movement of the air, and the birth chart of each period affecting the precipitation of moisture. And as in natal astrology, horary astrology, mundane astrology and stellar diagnosis, we also need to know the method of progressions which indicate when the weather changes indicated by each of these weather charts will take place, and the nature of the indicated change at that particular time.

Temperature Charts

—Because the weather is so variable and unstable we should not expect the birth charts of weather periods to be of long duration. We cannot consider that a given weather period has a long span of life compared to the life of man, or even compared with political, financial and such affairs as are considered in mundane astrology. The life of a weather period is of comparatively short duration.

In determining the life-span of weather periods, as so often happens, tradition came to our rescue. From most ancient times, as symbolized by the four different suits of the tarot, the weather has been divided into four different seasons. We have spring, summer, autumn and winter; each long recognized as a separate, distinct, and well defined weather period. And the checking done by a great many students in various parts of the world in the 16 years since the charts here presented were published has well verified that each of these quadrants of the year is the natural life span of a major weather period.

Our first step in weather predicting, therefore, consists in erecting a weather birth chart for the moment the Sun enters each of the movable signs at the place where the weather is to be considered. To make the erection of such charts both easy and accurate *The American Ephemeris and Nautical Almanac* issued annually by the Government Printing Office a year in advance, under the heading, Phenomena, gives the Greenwich Civil Time when the Sun enters Aries, Cancer, Libra and Capricorn. And in the back of other ephemerides issued annually this data is given as Greenwich A.M. or P.M. time.

If the place where the weather is to be considered is west of Greenwich, subtract the number of hours, minutes and seconds the place is west of Greenwich from the Greenwich time to find the Local Mean Time at that place. If the place is east of Greenwich add the number of hours, minutes and seconds the place is east of Greenwich to the Greenwich time to find the Local Mean Time at that place. The number of hours, minutes and seconds a place is from Greenwich may be found by multiplying the distance in °s of longitude by 4 and calling the product minutes of time, and multiplying the remaining 's of longitude by 4 and calling the product seconds of time, then converting into hours, minutes and seconds of time. Thus adding or subtracting the difference in time to or from the Greenwich time to get the Local Mean Time must be done for all weather charts after the Greenwich time has been ascertained; for all weather charts must be erected for the Local Mean Time of the place for which the weather is to be ascertained.

I think, either from astrologers or physicists, there would arise no dispute over the statement that the Sun is the heavenly body which chiefly influences the temperature on the face of the earth. I suppose, also, it would quite as readily be admitted that variations in temperature are the most important cause of weather changes. Wind, for instance, chiefly results because of the difference in temperature between adjacent regions which causes warm air to rise and cold air to flow in to take its place. That is, differences in atmospheric pressure, and the air movements consequently, arise chiefly from variations in temperature.

Temperature also determines in great degree the amount of moisture the air can absorb, and whether or not moisture held in the air will be precipitated. Warm air can hold much moisture before the saturation point is reached. When the saturation point is reached, however, any lowering of the temperature will cause precipitation, because cold air cannot hold so much moisture.

These are very elementary principles relating to weather variations. But a more technical discussion would not be appropriate to our purpose, which is to afford a decidedly popular, and so far as possible non-technical, method of astrological weather forecasting. Consequently, I shall avoid references to areas of high barometric pressure and areas of low barometric pressure. These highs and lows do influence wind currents and the precipitation of rain and snow and the formation of storms. But they are chiefly due to temperature changes.

After all, what the ordinary individual wishes to know about the weather is not whether the barometer shows him to be in a high or low pressure area. He wants to know if the weather is going to be cool, warm, hot, or cold; he wants to know if it is going to be windy or calm, stormy or pleasant; he wants to know if it is going to be cloudy, if the sun will shine, or if it will rain. That is, his chief concern is in temperature, in air movement, and in moisture precipitation. These things he wants to know in advance, because extreme weather conditions of any kind may cause him financial loss, discomfort, or even loss of life, if he is unwarned of their approach and consequently unable to take proper precautionary actions to meet them.

The Sun, chief ruler of temperature, changes polarity four times a year in its influence on the weather. When it enters the sign Aries at the commencement of spring the hours of daylight become longer than the hours of darkness. From this time on until the Sun enters the sign Cancer, the days continue to get longer; but so soon as the Sun crosses the solstice into Cancer at the commencement of summer the days start to shorten. Then when the Sun crosses the equinox into Libra at the commencement of autumn the nights become longer than the days, again changing polarity as it did when it entered Aries and Cancer. The nights continue to get longer until the Sun moves into Capricorn at the winter solstice and again changes polarity. From that time on until it once more reaches Aries the days get longer until when it enters Aries nights and days are once more of equal duration.

The most significant weather charts we call temperature charts. They have to do with the commencement of each new season of the year by the Sun moving into a movable sign. A temperature chart is erected for the moment the Sun enters Aries, Cancer, Libra or Capricorn, as the case may be, using the Local Mean Time of the place where the weather is to be thus foreshown. The temperature chart for the Sun's entry into Aries lasts until the Sun enters Cancer three months later. The temperature chart for the Sun's entry into Cancer lasts until the Sun moves into Libra. The temperature chart for the Sun's entry into Libra lasts until the Sun moves into Capricorn. And the temperature chart for the Sun's entry into Capricorn lasts until the Sun moves into Aries. Thus we have a distinct temperature chart for each of the four seasons; spring, summer, autumn and winter.

Air Movement Charts

—Yet temperature is not the only thing of importance in connection with the weather. Next in importance are air movements; because the air movements, largely resulting from temperature changes, are so influential in causing precipitation of moisture. Our next interest, therefore, is with air movement charts.

I suppose no astrologer would dispute that the planet Mercury rules the winds. Mercury is pictured as traveling with wings on his feet, and he is as changeable as thought itself. And because, like the wind, he is so changeable, more readily than any other planet taking on the condition of that with which he is temporarily associated, it requires no vast change in his environment to cause him to start a new and distinct period of endeavor. That is, a rather slight change in his environment is enough to give him a distinctly different trend than he had before.

The change of influence a planet has when it moves from one sign into another is not a marked change of polarity such as takes place at the commencement of its cyclic journey when it moves from south to north declination; nor is it so pronounced as the change of polarity experienced by the Sun at the commencement of each of the four seasons of the year. Yet much observation and checking indicates that it is quite enough to cause the volatile and fickle Mercury to take on new and distinctive characteristics in its influence on movements of the air.

Every planet has a different resonance in each of the different signs; and the air is so susceptible of being influenced by slight changes, and Mercury so readily changes to the quality of the sign into which it moves, that this entering a new sign of the zodiac is sufficient change of polarity to warrant the erection of a new air movement chart.

Both the air movement charts and the moisture charts are subsidiary to the temperature chart of the Sun during the same period. But a new air movement chart is erected whenever Mercury, either by direct motion or by retrograde motion, enters a new zodiacal sign. Unfortunately the ordinary ephemeris does not give the exact time when Mercury enters each zodiacal sign. The time, therefore, must in each instance be calculated. How to make the calculation is given in lesson No. 193, Astrological Air Movement Charts.

The air movement chart erected for the moment Mercury enters a new sign of the zodiac at the place for which it is desired to forecast air movements is not of regular duration; for it lasts only until Mercury enters some other zodiacal sign. It may last merely a matter of eighteen days, for instance, or on another occasion it may last more than sixty days, depending on how quickly Mercury moves through the sign it enters. In other words, it is as variable as the winds of heaven. Its influence always terminates, however, when Mercury leaves the sign which it entered at the time the chart was erected.

Moisture Charts

—We still have to consider the element of moisture. And I feel confident that any astrologer will agree with me that the Moon rules moisture. It is the traditional ruler of liquids of all kinds. Yet because the precipitation of moisture, such as fog, rain, snow and hail is so dependent upon temperature changes, the moisture charts must always be considered subsidiary and subservient to the temperature chart operative at the same time.

Moisture charts, as indicated, are dependent upon the changes in polarity of the Moon. And because weather is so variable a condition, it is not merely the cyclic chart commencing at New Moon which has its outer-plane weather parallels, but also the charts erected for the other phases of the Moon. Just as tradition points to their being four seasons of the year, each denoting a distinct weather period, so tradition also points out that there are four distinctive periods of the lunar month. Calendars, almanacs, and other astronomical guides at the present day, as throughout the past, take pains to note the days on which the Moon enters each of its quarters.

Even as the Sun, the major weather influence, in its movement around the zodiac sets off four distinctive periods, so also the Moon in its movement around the zodiac sets off four distinctive periods. The New Moon starts the first period, which lasts until the Moon makes the square aspect to the Sun; and this period, because it is one-fourth of the travel of the Moon from one conjunction with the Sun to the next conjunction with the Sun is traditionally called the First Quarter. The second period lasts from the first quarter, which ends when the Moon is square the Sun, to Full Moon, when the Moon makes the opposition to the Sun. This opposition ends the Second Quarter. The third period lasts from Full Moon, when the Moon is opposition Sun, until the Moon once again makes the square aspect to the Sun. The Third Quarter ends when this square aspect is made. The fourth period, commencing when the Third Quarter ends, lasts until the Moon once more makes the conjunction of the Sun, which marks New Moon. From New Moon, when the Moon is conjunction the Sun, until Full Moon, when the Moon is opposition the Sun, the Moon increases in light. From Full Moon, when the Moon is opposition the Sun, until New Moon, when the Moon is conjunction the Sun, the Moon is decreasing in light. The fourth period ending at New Moon completes the circle.

For moisture charts we erect a chart for the exact moment of Local Mean Time at the place where it is desired to forecast the weather that the Moon makes the conjunction with the Sun, that the Moon makes the first square aspect to the Sun, that the Moon makes the opposition to the Sun, and that the Moon makes the last square aspect to the Sun. We thus, following this plan, have a new moisture chart for each seven day period.

Fortunately for ease and accuracy in calculating these moisture charts, The American Ephemeris and Nautical Almanac issued annually by the Government Printing Office a year in advance, under the heading, Phases of the Moon, gives the Greenwich Civil Time for New Moon, for the first square which it calls First Quarter, for Full Moon, and for the last square, which it calls Last Quarter. And most ephemerides which are published annually have an aspectarian in the back which gives, along with the time of other aspects, the time when the Moon makes the conjunction with the Sun, the first square aspect with the Sun, the opposition with the Sun, and the last square with the Sun. As the time given is for Greenwich, the Local Mean Time at the place for which it is desired to forecast the weather must be

ascertained by subtracting or adding the difference in time, as explained when considering temperature charts. The chart must be erected by using the Local Mean Time so found, and the latitude of the place for which it is desired the weather should be foreknown.

**The Degree on the
Ascendant of a Weather
Chart is of Paramount
Importance**

—We have now indicated the three types of charts used in weather predicting: a temperature chart based on the position of the Sun, an air movement chart based on the position of Mercury, and a moisture chart based on the position of the Moon. In any of these charts the sign position of the planets, and the aspects made between planets, are identical the world over. Each chart, though erected for a different station in the world, is erected for the same moment of Greenwich time. The sign positions of the planets, and the aspects between the planets for the commencement of any particular weather period are the same throughout the world, and have an influence on the weather, not merely in some one spot, but all over the world. They are world weather influences.

But the chart erected at a given spot on the earth's surface gives its own house positions of the planets and its own rising sign degree. Either a difference in geographical longitude or in geographical latitude will give a variation in house positions and in the degree upon the Ascendant. It is the house positions of the planets that must be given consideration in judging the type of weather that will follow during the weather chart's period in a given locality.

Such weather charts as we have been considering, erected for the same Greenwich time, each governs the general weather for the locality where erected, over a definite period of time. The three charts, in combination with each other, and subject to the normal conditions at that time of year in the given locality for which erected, give an astrological picture of the weather conditions that may be expected during the indicated period.

But even as in a human birth chart something more is needed than a map of the general trend of the character, aptitudes and fortune, so also in weather charts something more is needed than maps of the general weather conditions during the week, during the month more or less, and during the three month season. Even as in natal astrology, to time the events shown as probable by the birth chart it is necessary to calculate and judge progressed aspects, so also in weather predicting, to determine when indicated weather changes will occur we must have recourse to progressed aspects.

Unlike natal astrology in which major progressed aspects are most significant, and unlike mundane cycles in which the transit progression of only the planet for which the chart was erected is found significant, in weather predicting the transit progressed aspects—as shown by the positions of the planets in the ephemeris on the calendar date under consideration—of all the planets are significant. Their aspects formed in the sky have significance over world weather conditions in general; but it has been found that for a given locality only the aspects of the planets to the Ascendant of a weather chart is indicative of a weather change.

The transit progressed aspects to the Ascendant, which to be effective must be within the customary one degree of perfect, of the chart are only of local significance and serve as pointers indicating the time when weather changes affecting the specific locality will take place. These aspects to the Ascendant cannot cause weather conditions not indicated by the chart; no more than in natal astrology a progressed aspect can indicate an event which the birth chart does not indicate as probable. But they do indicate when such changes as are shown by the chart will transpire.

The correct reading of these transit progressed aspects to the Ascendant is the most difficult factor with which we have to deal in weather predicting, because of the tendency to attribute an influence to an aspect made to the Ascendant which the weather birth chart as a whole does not substantiate. Their correct reading requires both experience and much refinement of judgment.

In all three types of weather charts the method employed is the same. It consists of considering the °s and 's on the Ascendant of the chart as the polarizing point for atmospheric conditions for the given locality. Every aspect formed, therefore, by the movements of the planets as shown daily in the ephemeris, not neglecting parallel aspects, to the degree on the Ascendant, indicates some weather variation. The kind of variation depends upon whether the aspect is to the Ascendant of the temperature chart, to the Ascendant of the air movement chart, or to the Ascendant of the moisture chart, upon the nature of the planet making the aspect, and upon the general weather indications of the chart as a whole.

If it is the temperature chart which is being considered, it is to be considered the most important chart of all, not merely in regard to temperature, but also in regard to indicating the general conditions of the weather for the three month period that it covers; because temperature is so important in influencing both rain and wind. Thus the chart erected for the time the Sun enters each movable sign is to be taken as the general indicator of what may be expected during the season. But when such wind, and such rain as is indicated will occur is not to be determined from the temperature chart, but solely from the air movement chart and the moisture chart respectively.

The time, however, when temperature changes will occur is to be ascertained solely from the temperature chart. Inspection of the ephemeris will indicate the daily positions of the planets, and reveal those days when any planet makes an aspect to the ° and ' on the Ascendant of the temperature chart. Every such aspect indicates some variation of temperature, having an influence over the period during which the aspect is within the customary effective one degree of perfect.

The heavier aspects, such as conjunction, opposition, parallel, square and trine, indicate more pronounced temperature fluctuations than do sextiles, semi-squares, sesqui-squares, inconjunctions and semi-sextiles. Because they move so slowly and the influence is effective during the time the aspect is within the effective one degree of perfect, the aspects of Pluto, Neptune, Uranus, Saturn and Jupiter indicate longer periods of influence, in which the drop or rise on the exact day the aspect is perfect may not be so pronounced. The Sun and Mars in their aspects to the Ascendant are more precise in influence, and have stronger effects than Venus and Mercury. The aspects made to the Ascendant by the Moon last so short a time that, except when made in the moisture charts, their influence is not pronounced.

The air movement chart determines the wind during the period it covers, subject, of course, to the chart of the season. An air movement chart showing much wind may not indicate wind storms, but only that it will be a windy time in comparison with the balance of the season. And the time when wind may be expected is determined by the aspects, as they are made, of the planets to the Ascendant of the air movement chart.

A moisture chart lasts only a little over seven days. It indicates how much precipitation there will be during the seven days covered, in comparison with other seven day periods during the season. When such moisture as is indicated will fall is shown by the aspects of the planets, as revealed by their positions in the ephemeris for the current year, to the Ascendant of the moisture chart. Even though the aspects formed by the Moon last but a few hours, because the Moon rules these moisture charts, even those days when the Moon makes heavy aspects to the Ascendant of a moisture chart may be important.

Seasonal and Geographical Considerations

—On the average, in natal astrology, in horary astrology, in stellar diagnosis, and in mundane astrology, it is found that the outer-plane environment and the inner-plane environment have about an equal amount of influence over conditions and what happens. And this principle is equally valid in weather predicting. Inner-plane weather has a profound influence over outer-plane weather. But the resistance of a particular environment to inner-plane weather of a certain kind must always be taken into consideration. That is a difficult factor successfully to handle in astrological weather predicting.

Each locality on the earth, due to many variable factors, has its own particular weather conditions which vary with the seasons of the year. Just as in the other mentioned branches of astrology, we have a norm that always must be considered. Variations of the inner-plane weather mapped by astrology do not during the ordinary life time of man radically change the weather of a certain area. It only indicates variations from the normal weather at a certain place during a certain period. Therefore, before an individual can successfully predict what the weather will be during a given period at a certain place, he must become familiar with the normal weather conditions at that place during that time of year. With this information, the aspects made to the Ascendants of the weather charts will indicate when the variations from this normal, as shown by the weather charts, will take place.

In the Death Valley region of the United States, for instance, the average precipitation is but a few inches, and these few inches commonly fall during the winter. The exception to this is that during the hotter period of the year a cloudburst may occur in the neighboring mountains and a vast amount of water, precipitated in a small area, may rush down some canyon carrying boulders, sand and gravel out upon the valley floor.

In addition to this lack of moisture, during the summer there frequently are periods when for days hot, dust laden winds blow violently along this baked depression in the surface of the earth.

It will be seen, therefore, that the astrological conditions which would indicate wet weather in Death Valley, even in winter, would be unusually pronounced, but that the astrological conditions indicating violent winds in summer would be exceedingly slight. It requires very wet aspects forming to the degree on the Ascendant of the moisture chart to give rain, even in winter; and no matter how wet the chart, or how wet the planet making an exact and powerful aspect to the degree on the Ascendant, it would be hazardous to predict wet weather on the floor of the valley in summer.

But in the same state of California, in Humboldt County on the coast, a day in winter when it does not rain is a decided rarity. It is normal for it to rain nearly every day in winter. A wet moisture chart, and aspects from wet planets to the degree on the Ascendant, would indicate not merely rain in this region, but more rain than usual.

No matter what the weather charts, nor how the Ascendants were aspected, you should not expect a tornado in California. And even in the northern part of the U. S. it would be unwise to predict, no matter at the weather charts might show, there would be a tornado in January.

Before there can be success in using astrological methods in weather predicting there must be thorough familiarity with the weather conditions that normally occur in the particular region. And it must be taken into account what kind of weather may be expected in this region normally at the particular time of year for which the weather charts are erected.

Having made himself thoroughly familiar with the normal weather, the student of astrological weather predicting will be in a position to judge, and with practice quite precisely, how the weather in the vicinity will be affected by unusual conditions shown in the weather charts.

Certain signs are dry and other signs are wet. Certain planets are dry, and certain planets are wet. When wet influences occur in the season temperature chart or the moisture chart in those positions that have an influence over the weather, he may know that weather which is wetter than the normal for the season is at hand.

Certain signs and certain planets are hot, and other signs and other planets are cold. When hot planets and hot signs are in the positions in the temperature chart for the season that affect the weather, he knows it is going to be a season hotter than normal.

Certain signs and certain planets are windy, and other signs and other planets are calm. When in the temperature chart and the air movement chart the windy signs and planets are in those positions affecting the weather in his vicinity, he knows that a windy period is at hand.

Certain planets are violent, and certain aspects are violent. And when there are violent planets making violent aspects to each other in the sky there is always violent weather on the earth, of a nature corresponding to the planets and their aspects. And if such violent planets occur prominently in the weather charts erected for a certain vicinity, he knows that violent weather there may be expected.

If the chief afflicting planet is Saturn, it may be a freeze, a flood, a blizzard, or a drought; but it will be destructive. If Uranus is the chief afflicting planet, electrical disturbances, or at least some sudden violence may be expected. If Neptune is the chief afflicting planet, the weather will be quite out of the ordinary. Thus each planet has its own significance where weather is concerned. And if a storm is indicated, it will break when there is a characteristic aspect to the Ascendant of the weather chart.

Chapter 2

Serial No. 191
Original Copyright 1949
Elbert Benjamine

Copyright
August 2002
Church of Light

Reading Astrological Weather Charts

Chapter 2

Reading Astrological Weather Charts



ow to predict the weather correctly by means of astrology depends upon the ability of the predictor rightly to discern the parallels between the inner-plane weather and the outer-plane weather. The condition of the inner-plane weather, and therefore the condition of the outer-plane weather, is influenced in general by the signs occupied by the planets and the aspects made between them, and by the houses occupied by the planets in some particular area. Every movement of a planet into a new sign, every aspect made between planets, and every marked change of motion made by a planet, produces a corresponding effect upon the weather of the earth.

When planets occupy signs which are harmonious to themselves, such as when they are in their exaltation or in their home sign—the sign they rule—and make favorable aspects with each other, the earth in general experiences advantageous weather. But when planets occupy signs which are discordant to themselves, such as when in their fall or detriment—the sign opposite the one they rule—we may be sure that the weather will respond and be unseasonable. Furthermore, whenever the planets in the sky make oppositions, squares, T-squares and grand squares (crosses) which are fairly close to perfect, this inner-plane violence is quite certain to manifest also in weather on the earth.

Where this violence, or high or low temperature, or wind or calm, or dryness or wetness will occur on the earth, as indicated by the positions of the planets in the sky, is determined by the house positions of the planets in the three weather charts. The date when the peculiarities of the weather indicated by the positions of the planets in the sky and their house positions will manifest most pronouncedly is indicated by the date on which an outstanding transit progressed aspect is made to the degree on the Ascendant of the weather chart.

The Temperature Chart indicates not merely the temperature for the three month season it covers, but the general tendency of both wind and moisture also. But it does not indicate the dates on which there will be marked changes in wind velocity or moisture precipitation. Yet on or near the date when some planet makes a perfect aspect to its Ascendant, the temperature will change within the limits indicated by the chart as a whole according to the character of the planet making the aspect and the nature of the aspect.

Limited by the wind shown for the Temperature Chart of the season, the Air Movement Chart indicates the general trend of air movement during the period Mercury is in the sign entered. It does not indicate changes in either temperature or moisture precipitation. But when some planet makes a perfect aspect to its Ascendant, the air movement will change within the limits indicated by the chart as a whole according to the character of the planet making the aspect and the nature of the aspect.

Limited by the moisture shown by the Temperature Chart of the season, the Moisture Chart indicates the general trend of rainfall during the following month. It does not indicate changes in either temperature or air movement. But when some planet makes a perfect aspect to its Ascendant, there will or will not be rain at that date within the limits indicated by the chart as a whole according to the character of the planet making the aspect and the nature of the aspect.

Even as in natal astrology, horary astrology, mundane astrology and stellar diagnosis, an aspect which is within one degree of perfect at the time the chart was erected is considered as having the power of a progressed aspect. And as in a weather chart the sensitive point is the Ascendant, an aspect at the time the chart was erected within one degree of perfect to the Ascendant is a powerful progressed aspect tending to concentrate the weather indicated by the planetary aspects in the sky and their house positions at the place where the chart was erected. Such a progressed aspect to the Ascendant at the time any weather chart is erected tends to give unusual activity to the weather at that place.

This does not of necessity indicate a storm. But it does indicate that the temperature changes, the wind, or the precipitation of moisture—according to whether it is a Temperature Chart, an Air Movement Chart, or a Moisture Chart—at that place during the period covered, will be more pronounced than otherwise, and especially during the time the progressed aspect is within the one degree of effective orb. If the chart as a whole indicates advantageous weather, the temperature change, wind or rain thus indicated during the period will be favorable. But if the chart is violent, and the aspect to the Ascendant, whether harmonious or discordant, connects up through tying in to it by aspect with some opposition, square, T-square or grand square, it tends to make more certain that the violent weather indicated by the chart will manifest in full fury at that place; provided, of course, that violence is shown in the houses influencing the weather in that locality.

Any aspect in the sky which is within the one effective degree of perfect has the force of a progressed aspect. But where this force will manifest depends upon house positions. If violence is indicated in the general area, a planet making an aspect within one degree of perfect to the Ascendant at the time the chart is erected acts as an aerial. And even if this aspect is a sextile or a trine, if the other aspects are violent and powerful, it may act as a means by which the Rallying Forces of the heavy discordant aspects reach the Ascendant and manifest the violence in that region. Rallying Forces are not confined in their activity to natal astrology and stellar diagnosis. They are equally effective in horary astrology, mundane astrology and weather predicting. Therefore, it must not be assumed that merely because the progressed aspect to the Ascendant on a given date is harmonious, when the chart as a whole shows violence, that the weather will be fine.

We may be sure that violent aspects between planets in the sky will be coincident with violent weather on the earth, and that the violence will be characteristic of the planets involved in the aspect, but of a type that occurs in the given locality. Whatever the aspect, it will not manifest as a hurricane in the Rocky Mountains, but possibly as a cloudburst and flood, because hurricanes do not happen there. Nor will it be a tornado in California, but some form of destructive weather such as at times there occurs.

The heavier planets, by their aspect with each other, are more productive of such violent weather because their aspects, due to slow motion, are more enduring. Jupiter, however, because it is the planet of fine, warm, sunshiny weather, is less potent in this respect, even when afflicted by other planets. Each of the planets, of course, has typical weather characteristic of it, and influences the weather in this direction.

Judging Weather Charts

—The fourth house of any weather chart or mundane chart is the house having chief rule over the weather. Experience, however, shows that while the fourth house is the most important single factor in weather judging, that there are also three other factors of importance. And experience shows just about how much relative importance to place upon each of these four factors.

THE FOURTH HOUSE: We find that $\frac{1}{2}$ of the total weather influence of any one of the three types of weather charts should be judged from the fourth house. In this, the most important factor is any planet which is actually in the fourth. The sign it is in and the aspects it makes are first to be considered. Then, as second in importance, comes the sign on the cusp of the fourth. And finally, the planet ruling the sign on the cusp of the fourth, the sign it is in and the aspects it makes, should be considered.

THE FIRST HOUSE: We find that $\frac{1}{4}$ of the total weather influence of any one of the three types of weather charts should be judged from the first house. Any planet in the first house and the aspects it makes are most important. Then, as second in importance, the sign on the cusp of the first should be considered. And finally, the planet ruling the sign on the cusp of the first, the sign it is in and the aspects it makes, should be considered.

THE PLANET FOR WHICH THE CHART IS ERECTED: We find that $\frac{1}{8}$ of the total weather influence of any one of the three types of weather charts should be judged from the planet for which the chart is erected. In a Temperature Chart the sign in which the planet ruling the sign the Sun is in should be given consideration. Thus if the Sun has just entered Aries, the sign Mars is in influences the weather. In an Air Movement Chart the sign in which the planet ruling the sign Mercury is in should be given consideration. Thus if Mercury has just entered Libra, the sign that Venus is in indicates this influence over the wind. In a Moisture Chart the sign in which the planet ruling the sign the Moon is in should be given consideration. Thus if the Moon is in Capricorn in a Moisture Chart, the sign Saturn is in is the most important factor in so far as this $\frac{1}{8}$ influence on the weather is concerned.

PLANETS IN ANGLES: As the final consideration of the four factors, we find that $\frac{1}{8}$ of the total influence of any one of the three types of weather charts should be judged by the planets in angular houses. If in a Temperature Chart they are predominantly hot in nature, it tends toward hot weather. If in an Air Movement Chart the planets in angles are mostly windy, this influences toward wind. If in a Moisture Chart the planets in angles are wet, rain may be expected in so far as this $\frac{1}{8}$ influence is concerned.

Cloudy Weather

—When, in reading the Temperature Chart and the Moisture Chart in the manner above indicated it is found that the damp and wet planets and signs, and particularly the dour Capricorn and the morose Saturn, have considerable influence—even when not enough to bring actual rain—we may look for dark, cloudy and gloomy weather. Moon, Saturn and Venus tend to considerable wetness and clouds. Pluto and Neptune, while less wet, also are able to obscure the Sun. In a wet chart Pluto, unless violently afflicted, in which case he brings disastrous storms, tends to drizzle, and Neptune tends toward fog. In general, then, these five planets tend toward dark days.

Mercury tends to blow clouds away. Uranus, if prominent enough, may bring gusts of wind and thundershowers, but does not tend to permanent cloudiness. The Sun, Mars and Jupiter tend toward clear, bright weather, unless they are so heavily afflicted as to influence a violent storm. Their storm influence, however, is of temporary duration, and is followed by clear weather. So, in general, it may be considered that there are five planets which tend to give a fairly bright sky.

Storms

—Storms, as a rule, coincide with marked temperature changes, with wind, and with precipitation of moisture. Therefore, when *all three* weather charts show violence at a particular place, the storm signals are apparent. But it is hazardous to try to predict storms from only one of the three charts. Instead, *all three* should be considered, and when much violence is shown, a departure should be made from the general rule, and even wind indications in the Moisture Chart and rain indications in the Air Movement Chart should be weighed, together with indications of electrical disturbances. That is, before predicting a heavy storm, it should be shown in *all three* weather charts for the time when it is expected.

Influence of Planets and Signs on the Weather

—As the effectiveness of the planets and signs in indicating weather depends upon their individual characteristics, it is essential that their characteristics in relation to the weather be thoroughly understood. Each planet and each sign has a definite influence upon the temperature, upon the movement of air, and upon moisture. No other factors than a knowledge of the normal weather in the area, the three types of weather charts, and the customary influence of the planets, signs and aspects are necessary in astrological weather forecasting. SUN: In relation to temperature the Sun gives warmth. Its location in the fourth, and to a less degree in any angle, commonly is an influence toward warmer weather. However, if much afflicted in winter, its strong adverse aspect to the degree on the Ascendant may, if from Capricorn or Aquarius, inaugurate a cold spell. But, except under unusual circumstances, it tends toward both sunshine and warmth.

Where the wind is concerned, except when it has discordant aspects from violent planets, its influence is toward calm, still weather. But in a storm chart showing great violence, if it is a member of a violent combination, it adds to the violence to be expected. That is, if it were conjunction Mercury in the fourth, and opposition Uranus and square Mars, it would signify terrific winds. This is because of the energy it possesses which is added to the whole combination. And, because of this power and energy, when it moves to a perfect aspect to the Ascendant of the Air Movement Chart it is potent to bring whatever wind the chart shows. Otherwise its influence is toward calm weather.

The SUN is distinctly a dry planet. That is, its influence is to bring dry weather and prevent rain. Because of its energy, however, when it enters into a rain configuration, especially when violently aspected, it produces lightning. In this respect it is only less powerful than Uranus. When it moves forward to a perfect aspect to the degree on the Ascendant of the Moisture Chart, because of its energy it tends to precipitate whatever rain is shown in the chart. But, of itself, it is a dry planet.

MOON: In relation to temperature the Moon is cool. It does not produce the excessive cold that Saturn and Uranus does, but temperatures that are chilly and at the same time not severe enough to injure plant life. When it moves forward to a perfect aspect to the degree on the Ascendant of the Temperature Chart the influence is to produce temperature variations such as the chart as a whole indicates, rather than to give cold weather.

Where wind is concerned, the Moon tends to give breezes, rather than either still weather or high winds. When it makes perfect aspects to the degree on the Ascendant of the Air Movement Chart it tends to stir up some air movement, but how much must be judged from the chart as a whole.

Where rain is concerned the Moon is the wettest of all the planets. When it moves forward to perfect aspects to the degree on the Ascendant of the Moisture Chart there is a tendency to bring out whatever moisture the chart holds. The Moon, either by position or by aspect, never favors dryness.

MERCURY: In relation to temperature, because moving air tends to coolness, Mercury's influence is cold. And this influence is consistent, in spite of the fact that it ordinarily takes on the influence of such planets as it closely aspects. In a hot chart, when it moves to a perfect aspect to the Ascendant of the Temperature Chart it may inaugurate a hot spell, but this is because the chart is more powerful than the influence of Mercury. Its influence, while not toward the extreme cold of Saturn and Uranus, is always cooling.

It is the chief ruler over winds, and its position in the fourth, or to a degree in any angle, influences toward wind. And when it moves forward to any aspect to the Ascendant of the Air Movement Chart, whatever wind the chart holds is let loose. It brings much more wind when measured by duration than does Uranus; but the sudden squalls which Uranus indicates may have, for a short time, a much higher velocity.

Mercury tends toward dry weather, and its appearance in the fourth or in other angles tends to prevent rain, except when it is part of a combination which indicates storm. When the charts are wet and violent, Mercury adds the wind element to the storm without moderating in any degree the amount of rainfall.

VENUS: In relation to temperature Venus has a moderating influence. If the previous weather was hot, she tends to cool it; if the previous weather was cold, she tends to warm things up. When she moves forward to a perfect aspect to the Ascendant of the Temperature Chart she commonly thus moderates the weather, unless the aspect is a violent one. Commonly she indicates mild and pleasant temperatures.

Her influence on the wind is similar. She encourages mild movements of the atmosphere, but disparages wild movements and storms. When she moves forward to a perfect aspect to the Ascendant of the Air Movement Chart she tends to stir up

some wind; but only such as the chart indicates. That is, the stimulation of the sensitive Ascendant merely loosens such wind as the chart holds.

In regard to rain, next to the Moon she is consistently the wettest planet. Saturn may give floods or drought. But Venus consistently gives beneficial rains. Of course, in charts otherwise indicating storm, she indicates the rain accompaniment; but of herself she does not cause storms. Her influence is to give those rains which in the Middle West are so essential in producing crops.

MARS: Mars is the hot planet, and tends more toward hot weather than any other. When he is in the fourth, or to a less extent in any angle, he commonly brings warm weather. However, if he is a member of violent and destructive combinations in the Temperature Chart, there is likely to be extremes in which hot days are followed by a sudden falling off to unusually low temperatures. When so afflicted in winter, for instance, if Mars moves forward to an aspect to the degree on the Ascendant of the Temperature Chart, instead of warm weather it may inaugurate the very opposite, and the temperature fall to a degree which causes great distress. But normally Mars indicates warmth.

In relation to wind, Mars indicates some movement. He is not a windy planet, but conduces to action. And when he takes part in a wind, by moving forward to a perfect aspect to the degree on the Ascendant of the Air Movement Chart, or as a member of a storm combination in the weather chart, he tends to cause destruction by violence.

Just as you can always consider that the Moon has a wet influence, so you can always consider that Mars has a dry influence. He may, in a Moisture Chart, release rain by coming to the perfect aspect of the degree on the Ascendant, but thus he merely releases conditions that are there in spite of his protest.

JUPITER: In relation to temperature, Jupiter is warm. He is not so hot as Mars, and not quite as heating as the Sun. His is a genial warmth, and this warming influence is consistent, whether due to his position in the fourth, or to his aspects to the degree on the Ascendant of the Temperature Chart.

Where wind is concerned he conduces to pleasant breezes, and it is only when configured with malefic planets which strongly afflict him that he takes part in storm weather. He is not a still planet like the Sun and Neptune, but he is not violent. Because his influence is so powerful, when he is in aspect to the degree on the Ascendant of an Air Movement Chart he tends to cause winds, and may release the windy elements of the chart by such aspect. But his own influence is toward balmy breezes.

Where moisture is concerned, Jupiter tends to dryness. He is neither so dry as Mars nor the Sun, but he tends to drive away gloomy clouds, and to bring fine, clear, warm weather of the kind that makes being out of doors agreeable. Even in a rather wet Moisture Chart, where some rain is shown, if Jupiter is in the fourth, or otherwise unusually prominent, those days on which rain is not shown during the period will be pleasant and cheery. But under such a Moisture Chart if, instead of Jupiter, Saturn is dominant, the days on which it does not rain will be gloomy and disagreeable.

SATURN: Saturn is the storm planet. Where temperature is concerned his influence is toward cold. He is the planet which brings disastrous freezes. However, in summer, if other indications point to a drought and extreme heat, his influence when prominent will not then reduce the temperature, but will increase the extreme heat to a destructive point. In winter, his aspects to the degree on the Ascendant of the Temperature Chart may be looked for to cause a drop in temperature. And in summer also, his influence by aspect to the degree on the Ascendant means lower temperatures, of the kind which delay planting of crops, or which prevent crops growing. But in a period of extreme heat, instead of lowering the temperature, his aspect to the degree on the Ascendant causes the heat to become even more excessive and unendurable. He has a similar extreme influence on the wind. He is a still planet, tending normally toward cold, damp weather without breezes. But in a chart showing storm, or showing excessive wind, his prominence in it tends to cause the winds to reach destructive violence. In such a storm chart his aspect to the degree on the Ascendant of the Air Movement Chart releases the wind shown in the chart with unusual violence. More than any other planet, he signifies storm and destruction.

Floods are usually due to the prominence of Saturn in the weather charts. He is a wet planet. The blizzards in winter in which cold and driving snow do so much damage are directly under his influence. But in a real drought period, do not look for him by position in the Moisture Chart, or by aspect to the degree on its Ascendant, to relieve the dryness. Under such conditions he adds to the grief by making it still more dry. So, while normally wet, it is best to consider him the planet most favoring destructive and disagreeable weather, whatever kind the charts as a whole and the season indicate. Because of his chilling influence, hailstorms are chiefly under his dominion.

URANUS: In his effect upon temperature Uranus is rather consistently cold. But his influence is even more toward sudden temperature changes, from hot to cold and then from cold to hot. In winter or summer he tends to sudden drops of temperature. But as soon as such a drop has become effective under his influence, the temperature is apt to swing back just as abruptly to normal. In the heat of summer he may bring a thundershower which cools the atmosphere. But the heat returns as soon as the shower is over.

He is decidedly a windy planet. But unlike the steady winds of Mercury, he tends to sudden gusts and squalls, which for the time are quite violent. The wind may not blow many days during the period he influences, but during certain short intervals it may reach destructive violence. In fact, where wind storms are concerned he is a violent and destructive influence.

Uranus is a dry planet, in his general influence tending to dry weather. He is also the planet of lightning, and thus, while not favoring steady rain, he does favor thunderstorms in which squalls of wind and electrical displays join with temporary down-pours of rain. In an otherwise wet chart he brings lightning and wind with the rain. When there is also a Saturn influence he contributes to the condition which causes hailstorms, and he is the chief influence in cloudbursts. These sudden and violent downpours in which lightning is a prominent feature are typical of his nature.

NEPTUNE: Neptune is the peculiar planet in its effect upon the weather. Freak weather of all kinds come under its influence. With Mars, Jupiter and Neptune in Virgo, the sign of grain, in the summer of 1933 there was a drought in the Middle West which destroyed much grain. But on the West Coast it brought in fog from the ocean all summer long, so that it was as exceptionally cool here as it was hot in the interior. His influence over temperature ordinarily is cool but in an afflicted chart he tends to produce some kind of unusual weather which may, or may not, be cool.

He is also a still planet. Normally he tends to murky conditions. But in a chart that otherwise shows storm conditions he has a violent influence which adds to the storm's fury. When the Air Movement Chart otherwise shows violent winds, for instance, he seems to delight in sandstorms and dust storms in which visibility is clouded. In the occasional rains in which little fish or little frogs or mud comes down with the water, he always plays an active part. And in tornado and hurricane charts, his presence in the fourth, or his heavy aspect to the Ascendant, not only increases the violence of the storm, but brings unusual phenomena.

I have already mentioned how rains of unusual nature are influenced by him. Normally, however, he does not favor rain, but tends to mists and fogs. Hazes and smoky conditions and all such impediments to visibility are chiefly due to his influence. In a wet chart his influence tends to increase the amount of rain, and in a storm chart it increases both the amount of water and the violence of the storm. He, more than any other planet, brings about peculiar weather conditions.

PLUTO: In his influence upon temperature Pluto is cool. In this respect his influence is about that of the Moon and Neptune rather than the extreme cold brought by Saturn and Uranus. Pluto, however, is decidedly a violent planet, and his prominence in a weather chart, or his aspect to the degree on the Ascendant, tends to bring extreme conditions. But, unless the chart as a whole shows much heat, his influence tends uniformly to cold. Only in a drought chart, or a chart otherwise showing violent heat, does his influence add to the destructiveness of the heat rather than tend to cool weather.

In his influence on the air he tends to produce wind; and when he is prominent and violently aspected in the Air Movement Chart, he brings winds of a violent and destructive nature. He is not quite so sudden and abrupt as Uranus, but his destructive influence under severe affliction is even more far-reaching and enduring. But when he is well aspected, instead of producing violent winds and disagreeable weather, he brings invigorating cool breezes that are decidedly beneficial.

In his influence on rain he is a moist planet. His typical influence is not to bring fog, like Neptune, nor heavy rain like the Moon, but just a steady drizzle. These light, steady rains, when he is well aspected, are beneficial to crops. Afflicted, and with Saturn prominent in winter, they may become sleet. But when Pluto is heavily afflicted in a storm chart, such as receiving the square of Uranus, he is next to Saturn in his ability to produce storms of death and destruction. He is decidedly a violent planet, and lends this violence to the added fury of such charts as indicate cloudbursts, tornadoes and hurricanes.

ARIES: The sign Aries in its influence on temperature is hot. Scorpio, the other Mars sign, gives extreme weather conditions which usually are hot but which may tend to extreme cold. Scorpio has the rulership of the planet Pluto, which may account for this. The other hot sign is Leo. These two signs, in so far as the Temperature Chart and temperature influences are concerned are the signs of high temperatures.

Because Mars and Aries are both so restless and active we need not be surprised that this movable sign gives some wind. We may consider it only fairly windy, however, in comparison with Gemini, Virgo, Libra and Capricorn, which are more windy, and in comparison with those signs which are calm.

Of all the zodiacal signs Aries and Leo are the most dry. When, however, Aries is prominent in a chart that shows much rain, as when the Moon is in the fourth or the first in Aries, it brings violence along with the rain. But when it is prominent in a dry chart in summer it brings dry, hot winds which tend to desiccate the vegetation and scorch the leaves of growing crops.

TAURUS: In its influence upon temperature Taurus, like its ruling planet Venus, has a moderating influence. If the preceding weather has been unusually cold, the influence of Taurus is to warm things up. But if the preceding weather has been extremely hot, the influence of Taurus is to bring cooler temperatures. Its general influence is toward those temperatures which are best for growing crops, during the times crops are in the field, and toward those temperatures which favor domestic stock at other times of the year. It may thus be said to be, more than any other sign, the farmer's friend.

Taurus is a fixed sign, the most fixed of all the signs. And this stabilizing influence marks its effect in an Air Movement Chart. More than any other sign Taurus tends to calm weather in which not a breath of air stirs. Therefore, in so far as this sign is dominant in an Air Movement Chart, it tends to prevent winds. Just as its opposite sign, Scorpio, tends to produce extreme weather conditions, so Taurus tends to produce moderate weather and a still atmosphere.

In conformity to the fact that the Moon, wettest of all planets, has its exaltation there, Taurus tends toward wet weather. But this wet weather is not of the nature indicated by Capricorn, for instance, in which cold rains delay the planting and growing of crops. The typically Taurus weather gives what the farmer calls growing rains. They are not floods, but of generous quantity that benefit crops. Steady rain for a day or two, just enough falling that it has time to soak into the ground, and does not run off so quickly as the more copious downpours of Cancer.

GEMINI: Gemini is a cold and drafty sign. Its influence in the Temperature Chart may be considered as favoring cold weather. However, it may also be considered to favor rapid changes and variable temperatures. It does not give extreme cold as do Capricorn and Aquarius, but tends to real cold rather than the cool weather of Pisces. But in addition to the cold, when it has influence, look for fluctuations in temperature.

No other sign is as windy as Gemini, although Virgo makes a close approximation to it. Libra is windy, but not as windy as Gemini and Virgo. In so far as this sign has influence in the season Temperature Chart and Air Movement chart you may expect lively winds without surcease. And in weather charts which indicate storm, it shows that wind will be an accompaniment.

Gemini is bone dry, even though cold. It does not favor rain, and even tends to blow fog and mist away. Even the clouds in the sky are driven from view by its winds of variable power. Only when the rest of a weather chart shows rain does it play any part with precipitation. Then it indicates that it will be a driving rain, or rain which is part of a wind storm.

CANCER: Cancer is also a cold sign, but not drafty. Nor is the cold so intense as that given by Capricorn and Aquarius. It is colder than Pisces, however, and the coldness frequently is accompanied by rain in summer and snow in winter. In so far as it has influence on the Temperature Chart it tends to give low temperatures.

Although Cancer is ruled by the Moon, which tends to restlessness and breezes, its influence is toward quietness. It is the only one of the movable signs having such an influence, as Aries gives some wind, Libra is windy, and Capricorn gives wind and storm. The stillness is not so pronounced as that of Taurus and Leo, but enough so that it can be considered as a sign tending toward calm weather.

Of all the signs, Cancer is the wettest, although Scorpio, because of its extreme tendencies may, at times, give more violence to the downpours. Cancer, in its effect upon the Moisture Chart, and to the extent its influence becomes dominant, tends to steady and voluminous rains. It does not bring the cloudbursts, nor the sudden squalls; neither does it bring drizzles, nor just a few rainy hours. When it has power, it brings the kind of weather when it rains and rains some more, the water coming down in full force for days at a time.

LEO: Leo is a decidedly hot sign. Dry and hot. Under its temperature influence often not a breath of air stirs. The rays of the Sun bear down with a heavy hand, and the land swelters. Even in winter time, in so far as this sign has dominance of the Temperature Chart, warm weather may be expected; those bright, sunshiny days that tend to melt the snow and drive the snow clouds from the sky.

Next to Taurus it is the stillest sign of all. In so far as it has power to do so it stifles wind. Thus it is a fine influence in winter, warming the atmosphere and quieting the breezes. But in spring it may, when it is the dominant influence in the Temperature Chart, bring such fine warm days that the buds and blossoms of fruit may open prematurely, and the sap start running; to be followed, under some cold aspect to the Ascendant of the Temperature Chart, by a freeze which destroys the crop for that year.

And it is dry, along with Aries tending to parch the earth. Uniformly, its prominence in a moisture chart tends to delay rain and to prevent cloudy weather. Bright, clear, sunshiny days are typical of its influence. Yet it does have an influence when associated with storms. Next to Aquarius it is the most electrical sign. When, consequently, there is a storm and the planets indicating it are in Leo, or the wet conditions are so pronounced as to bring rain in spite of Leo's prominence in the chart, lightning and other violence may be expected.

VIRGO: Virgo, while not as cold as Capricorn and Aquarius, is nevertheless a cold sign. And the winds it causes are cold winds. In so far as it has influence over the temperature, either in winter or summer, it tends to cold, dry, windy weather. Blustery weather is typical.

Its influence on the Air Movement Chart is uniformly in the direction of wind. These winds are variable, both as to force and direction; but not so changeable as those of Gemini; for under Gemini it may blow a gale from one direction, and in an hour change around and blow a gale from exactly the opposite direction. Cutting winds, such as penetrate clothing and chill one to the bone, are quite characteristic.

It is also uniformly dry. It tends to discourage wind and fog; but when the wet influences are strong enough to override this tendency, it adds wind to the storm.

LIBRA: Libra cannot be classified as cold, in the same sense that Capricorn and Aquarius, or even Virgo and Cancer, are cold. It is more correct to say that its influence is cool; a milder influence than those mentioned, but in the direction of lower temperatures rather than heat.

That it is an airy sign, and a movable sign, is fully born out by its influence in producing wind. It does not just produce breezes, but those stronger air currents which are commonly called wind. In this respect it is not so pronounced in its influences as Gemini and Virgo, but nevertheless it contributes markedly to the wind tendencies in any chart in which it is unusually prominent. Even though it is a Venus sign, it contributes to, rather than detracts from, the wind tendency of a storm chart,

and may be one element in a tornado or hurricane. When the chart is not otherwise violent, the wind it brings is cool and refreshing, and not cutting and disagreeable like Virgo wind.

On moisture it has a drying influence. Uniformly, in the Moisture Chart its influence should be read, in so far as it is dominant, as favoring dry weather. It tends to drive the clouds from the sky and to give bright sunny days which, except for considerable wind, are enjoyable and favorable for outdoor work.

SCORPIO: Of this sign it may be said that it, more than any other, tends to extremes. Possibly this may be due to the rulership of the sign by Pluto, which is a planet of extremes, being exceedingly constructive or excessively destructive. In so far as Scorpio has dominion in a weather chart, there is either pronounced cold or extreme heat. Its influence seems never to be toward moderate temperature.

In regard to its influence over the Air Movement Chart, however, its dominance, if the chart as a whole shows violence, is always to increase the violence shown. If the chart shows wind, Scorpio inclines the wind to be destructive in force. If the chart does not show wind, but heat, it gives still, sultry days, in which the humidity and oppressiveness carrying into the night, making sleep difficult or impossible. Its power is often felt in storm charts which give rise to winds which reach the proportions of tornadoes and hurricanes.

Scorpio is a wet sign, but not one which will break a drought. In weather charts which otherwise indicate dry weather, a dominant Scorpio merely makes the lack of rain continue and the dryness more extreme. But in a rain chart, or a storm chart showing rain, its influence is toward extreme precipitation. Thus it frequently is a noticeable influence in the cloudbursts of our western mountains and in the terrific downpours that sometimes accompany the more violent storms of the East and Middle-West.

SAGITTARIUS: Sagittarius, in its influence over temperature, is not hot like Aries and Leo, but is decidedly warm. In so far as it is a prominent factor in the Temperature Chart the weather to be expected is bright, clear, sunny and warm. It favors neither clouds nor fog, but tends to make visibility exceptionally good.

The wind it brings is of moderate force and has an invigorating quality. Although giving some air movement, it neither favors nor discourages storm winds to any appreciable extent.

It is a dry sign, and tends to dissipate clouds and prevent rain. To sum its general and consistent influence up, it tends to fine, pleasant weather, such as favors outdoor work and outdoor sports.

CAPRICORN: This is the sign of storms, of extreme cold, and of destructive floods and droughts.

Its influence commonly is toward low temperatures, and in winter to temperatures so low as to be destructive of life. But in a period of excessive summer heat, do not look for Capricorn to moderate it. Instead, it will make the heat even more disagreeable.

It is the sign which, more than any other, brings blizzards. It increases the wind force when dominant in an Air Movement Chart. When the temperature drops to below zero, and the wind rises to a gale, driving sleet and snow before it, is typical Capricorn weather. And, at any time of year, when storm is indicated of any kind in a chart, such influence as it has is toward increasing the destructiveness.

It is the detriment of the Moon, and is not only a wet sign, but tends toward floods and destructive snowstorms and hailstorms. In a drought period, however, it cannot be counted on to bring rain. It just tends to increase the drought. And in so far as it is dominant it brings disagreeable conditions, such as dark, damp, cold days, and cold drenching rains when rains are not needed. Unseasonable weather of all kinds come under its rule.

AQUARIUS: Next to Capricorn this is the coldest sign, and a drop of temperature may consistently be expected under its influence. Dry, crisp, cold weather, such as often occurs in February is typical of its influence. Only when other influences are violent does it participate in storm, but when such conditions exist, it tends to increase the fury of a blizzard.

Although it is a fixed sign, it tends to some movement of the air. Moderate breezes are characteristic of it, except when the chart is a violent one otherwise in which case, as mentioned, it makes for excessive cold and driving wind that drifts the snow in blinding clouds.

It consistently favors dry weather; but when the other parts of the Moisture Chart and Temperature Chart indicate rain, it adds to them the electrical element. Of all the signs, it tends most to give lightning. Whenever, therefore, in a chart for a region where lightning occurs, this sign is prominent in a rain chart, look for electrical pyrotechnics.

PISCES: Pisces is not so pronounced in its influence as to be called cold, but is rather cool. Its influence in the Temperature Chart is consistently toward somewhat lower temperatures, but not of an extreme nature. As might be gleaned from the fact that it is the exaltation of Venus, its influence in general is not violent, but mild.

Where the Air Movement Chart is concerned, it tends toward calm weather. In this respect it is not so powerful as Taurus and Leo but, nevertheless, it tends to moderate whatever windy influences are present.

It is consistently a wet sign, but not given to the downpours that Cancer occasions, nor to the floods and disagreeable storms indicated by Capricorn. In a chart which shows storms, if prominent, it merely indicates that much rain will accompany the violence shown. But when free from extreme influences, it causes those rains which are seasonable and of marked benefit to the crops.

In all its weather influences, next to Taurus, Pisces is most moderate, and produces conditions favorable to crops and to livestock. It also, therefore, like Taurus, only in a less degree, is the farmer's friend. But do not plan a picnic when its influence is dominant; for the rain it brings is sufficient to discourage outdoor pleasures.

Chapter 3

Serial No. 192
Original Copyright 1949
Elbert Benjamine

Copyright
August 2002
Church of Light

Astrological Temperature Charts

Chapter 3

Astrological Temperature Charts



Because, as already indicated, temperature is the most important influence both in air movements and in the precipitation of moisture, not only the temperature, but much about wind and moisture in their general effect on the season can be learned from the Temperature Chart. But the days during the season when such wind and moisture, as shown by the season Temperature Chart, will be present, are to be determined from the Air Movement Chart and the Moisture Chart, respectively.

In its timing of weather conditions, however, the Temperature Chart is to be used exclusively to indicate changes in temperature. Temperature Charts are erected for the place where the weather is to be ascertained, at the exact moment the Sun enters Aries, enters Cancer, enters Libra, and enters Capricorn.

The chart for the time the Sun enters Aries indicates the temperature, and its changes, until the Sun enters Cancer. The chart for the time the Sun enters Cancer indicates the temperature, and its changes, until the Sun enters Libra. The chart for the time the Sun enters Libra indicates the temperature, and its changes, until the Sun enters Capricorn. The chart erected for the time the Sun enters Capricorn indicates the temperature, and its changes, until the Sun once more enters Aries.

Thus do the four charts cover the temperature for the year. And it is the aspects made by the planets as they move through the zodiac and change declination, as shown by their positions on the given calendar date in the ephemeris, to the degree on the Ascendant of these Temperature Charts that indicate the time and amount of temperature changes.

In the various ephemerides issued annually is a table which shows the “Time when the Sun and Moon enter the Zodiacal Signs.” If the time there given is m, it means before noon; it is given as af, it means afternoon. The time thus designated is Greenwich Mean Time. Therefore, from this time as given in the ephemeris, the Local Mean Time of the same moment must be calculated for the place where the weather chart is to be erected.

Thus the ephemeris shows that in 1929 the Sun entered Aries on March 20, at 2:35 a.m. Now if the Temperature Chart were to be sought for this date in Chicago, the corresponding Local Mean Time at Chicago must be found. Chicago is 87:39W. This is equivalent to 5h 50m 36s in time. Subtracting 5h 50m 36s from 2h 35 a.m. on March 20, gives the Local Mean Time at Chicago for which the chart should be erected as March 19, 1929, 8h 44m 24s p.m.

If the chart were to be erected for New York weather, because New York is 74 degrees West Longitude, we must subtract 4h 56m from 2:35 a.m. This gives the proper time for erecting the chart at New York as March 19, 1929, 9h 39m p.m. LMT.

In 1931 the ephemeris shows that the Sun entered the sign Cancer on June 22, 9:28 a.m. As this is Greenwich Mean Time, if we wished to erect a Temperature Chart for Washington, D. C., we would subtract 5h 8m from this time, because Washington is 77 degrees West Longitude. This gives us the Local Mean Time for erecting the chart at Washington as June 22, 1931, 4:20 a.m.

The ephemeris for 1933 shows that the Sun entered Libra, giving the chart for the autumn temperature, September 22, at 12:01 p.m. Now if this Temperature Chart were desired for Denver, Colorado, as Denver has West Longitude 104:59, we subtract 6h 59m 56s from 12h 01, which gives the Local Mean Time at Denver as September 22, 1933, at 5h 1m 4s a.m.

The ephemeris for 1933 shows that the Sun entered Capricorn, giving the chart for the winter temperature, December 22, at 6:58 a.m. If this Temperature Chart were desired for Los Angeles, as Los Angeles is 118:15 West Longitude, we subtract 7h 53m from 6h 58m, which gives the Local Mean Time at Los Angeles as December 21, 11:05 p.m.

As the time given in the ephemeris for each weather chart is Greenwich Mean Time, in each instance the positions of the planets must be calculated for this EGMT. But in each case the degrees of signs on the house cusps must be calculated, as illustrated, from the EQUIVALENT LOCAL MEAN TIME.

In judging all weather charts the general rule should be followed of considering $\frac{1}{2}$ of the total influences as indicated by the fourth house, $\frac{1}{4}$ of the total influences as indicated by the first house, $\frac{1}{8}$ of the total influences as indicated by the planet for which the chart is erected, and $\frac{1}{8}$ of the total influences as indicated by planets in angles. But in addition to this, the weather forecaster must make himself familiar with the normal weather in the particular area for the season covered by the weather chart.

This can be done by consulting reports made by the Weather Bureau. At the time the weather chart studies presented in this course on Weather Predicting were made, the U. S. Department of Agriculture, Weather Bureau, printed a Weather Map daily, except Sundays and holidays, for each section of the country, and these were given careful study over many years. This weather map, among other things, gives the precipitation for the last 24 hours, wind velocity at a certain hour in the morning (this

feature was discontinued July 7, 1933), the temperature at 8:00 a.m., 75th meridian time, and the amount of temperature change in the last 24 hours; for some 92 different weather stations throughout the United States.

Also published by the Weather Bureau of each section was a monthly publication called Climatological Data which, among other things, indicated the monthly normal temperature and precipitation and the departure from normal for the month, of each year since 1897. From it could be determined for the section covered how much more than normal, or how much less than normal, was the temperature and precipitation of moisture, for the given month. The date, and amount, of the maximum wind velocity for the important stations in the section were also given.

With the necessity for great precision in close range weather forecasts due to the dependence of aviation on probable weather, and the daily weather forecasts given over the radio, changes are taking place in the manner the Weather Bureau handles weather data. Therefore, those who take up the study of Weather Predicting should get in touch with the Weather Station in their area and ascertain the nature of the records available for study.

After 16 years in which students in many areas have experimented with the method of weather forecasting here presented, I have not found it necessary to make any change in the system or the data. However, in 1933, in natal astrology, in horary astrology, in mundane astrology, and in stellar diagnosis, as well as in weather predicting, it was customary to ignore parallel aspects made to the Ascendant. Since that time statistical research has shown that in all these charts parallel aspects to the Ascendant have significance. Parallel aspects to the Ascendant commonly last over quite a period of time, and influence the weather over this period, which in the case of the slower moving planets may last for weeks, and even for months. Therefore, while in these lessons parallel aspects to the Ascendant are seldom mentioned, in weather predicting as now better understood they should be given due consideration.

For the purpose of indicating how the Temperature Charts should be used, I will refer to the Temperature Charts for Los Angeles which were part of the original weather predicting studies. But it should be understood that such Temperature Charts can be erected and quite as effectively used at any other place.

In the use of the data furnished by the Weather Bureau over the periods covered in these lessons it should be understood that the change of temperature recorded is that computed for the preceding 24 hours, as read at a certain time each morning. Also, that a planet has an influence over the temperature during the time it is within the one effective degree of orb to the and ‘ on the Ascendant.

Winter Season 1931-1932

The Sun entered Capricorn December 22, 1931, at 11:37 a.m. LMT., Los Angeles. Chart No. 165, erected for this time, is given in lesson No. 190.

Gemini, a cold sign, is on the cusp of the fourth, and Mercury, its ruler is in the warm sign Sagittarius. This accounts for ½ of the influence of the chart.

Cold Uranus is in the first house. Pisces, on the cusp of the first, is cool, and Neptune, its ruler, is in cold Virgo. This accounts for ¼ of the influence of the chart.

Saturn, ruling the sign occupied by the Sun, is in cold Capricorn. This accounts for 1/8 of the influence of the chart.

Sun and Mars in an angle are hot, but are offset by cold Mercury and cold Uranus also in angles. This accounts for 1/8 of the influence of the chart.

With the cold tendencies so pronounced, cold for the season was to be expected, and here is the Weather Bureau's report: "The monthly mean temperature for the State was considerably below normal. Since State records began, in 1897, there has been but one January with a lower mean temperature, that of 1916, and one with the same record. Both day and night temperatures were subnormal at nearly all stations."

The report for February continues: "The monthly mean temperature for the State was well below normal, with deficiency most marked in the northeastern counties."

It will be noted that March 20 brings in a new Temperature Chart, and that the one now being considered shows indications only up to that date. Climatological Data for March reads: "Relatively cool weather prevailed during the first week and from the 20th to the 22nd, while during the remainder of the month daily mean temperatures were well above normal." The temperature for the month was 1.7 degrees warmer than normal.

But now let us observe just when the more marked fluctuations in temperature occurred covered by this chart No. 165. The best way to learn what to expect, and when to expect it, seems to be to observe the exact day on which each aspect from any planet forms to the and ' on the Ascendant. In this case we must consider, by consulting the ephemeris, when each aspect to 21 Pisces 23 occurs, making due allowance for the fact that the ephemeris gives the positions 8 hours later than the Standard Time at Los Angeles.

Conjunctions, oppositions, squares and trines, of course, are most important; but even the weaker aspects may also be noted. The daily Weather Map shows just what actually occurred on the day of the aspect in regard to temperature change unless the day was Sunday or a holiday. In these instances, the best we can do is to observe what took place on the adjacent days.

Sunday, December 27, 1931, Mercury is 21 Sagittarius, and thus square the Ascendant. Mercury tends to coolness, and Saturday, December 26, the temperature dropped 5 degrees.

December 31, Venus was 6 Aquarius, and thus semi-square Asc. Venus has a moderating influence, and the temperature went up 1 degree.

The influence of Jupiter, because it remains within the one effective degree of orb so long, lasts some time. January 4 Jupiter lacked only a few minutes of inconjunct Asc., and on that date the temperature went up 1 degree, and then 4 degrees more on the 5th.

This upward trend, however, given by Jupiter, was checked for a day or two by cold Mercury turning direct and making the square of the Asc. on the 5th.

Jan. 12, the Sun made the sextile to the Asc., and Venus made the semi-sextile to the Asc. Too much in the way of heat should not be expected from planets in cold signs, and Venus was in Aquarius and the Sun in Capricorn. Jan. 11, the temperature went up 8 degrees, fell 3 degrees on the 12th, and fell 14 degrees more on the 13th after both planets moved beyond aspect to the Asc.

Jan. 26, Mars made the semi-square to the Asc., and on Jan. 27 the Sun made the semi-square to the Asc. Under the heating influence of these two planets the temperature went up 4 degrees on the 26th and another degree on the 27th.

Jan. 30, Mercury came to the sextile of the Asc., lowering the temperature 3 degrees on the 29th, and raising it 1 degree on the 30th above what it was on the 29th.

Feb. 5, Venus came to the conjunction of the Asc. Venus is a moderate influence, and on Feb. 4 the temperature went up 8 degrees, another 7 degrees on the 5th, and 2 more degrees on the 6th. The conjunction is a powerful aspect.

Feb. 9, Mercury, a cooling influence, came semi-square Asc., resulting the following day in a temperature recording 5 degrees lower.

Feb. 11, the Sun, a warm planet, but in the cold sign Aquarius, came semi-square Asc., resulting the following day in a temperature rise of only 1 degree.

Feb. 14, Mars, the hot planet, came semi-sextile the Asc., from the cold sign Aquarius, resulting in a temperature rise of 4 degrees on the 13th, there being no record for the 14th, as it was Sunday.

Feb. 18, Mercury made the semi-sextile to the Asc., showing a rise of 5 degrees on the 18th and a fall of 4 degrees on the 19th.

March 1, Venus came semi-sextile the Asc. from Aries, with a temperature rise of 1 degree.

March 5, Mercury came conjunction Asc. There was a fall of 6 degrees on the 4th, and a rise of 2 degrees from this position on the 5th and on Monday the 7th, the next recorded day, there was a lowering of 3 degrees the movement as a whole showing lowered temperature.

March 12, the Sun came conjunction the Asc. Pisces is a cool sign, and the chart as a whole shows coolness. The general tendency of this conjunction was not to warm, as the Sun's influence commonly is, but to lower. March 11 there was a rise of 1 degree, a fall of 2 degrees on the 12th, and on Monday, March 14, a further fall of 9 degrees. This was undoubtedly due to cold Mercury being parallel the Asc.

This fall in temperature, however, was checked on March 15 by the semi-square of Venus to the Asc.

This covers the aspects of the planets to the Ascendant, and also the pronounced temperature changes, during the winter season. The lesser temperature changes are to be found from the aspects made by the Moon to the Ascendant.

Spring Season, 1932

The Sun entered Aries March 20, 1932, at 12:01 p.m. LMT., Los Angeles. Chart No. 166, erected for this time, is given in lesson No. 190.

Virgo, a cold sign, is on the cusp of the fourth, and Mercury, its ruler, is in the hot sign Aries, but 4 conjunction cold Uranus and square cool Pluto. This accounts for $\frac{1}{2}$ of the influence of the chart.

Cool Pluto is in the first, and cold Cancer on the Asc. The Moon, ruler of the Asc., is in the cold sign Virgo. This accounts for $\frac{1}{4}$ of the influence of the chart.

Mars, ruling the sign occupied by the Sun, is in cool Pisces trine cool Pluto. This accounts for $\frac{1}{8}$ of the influence of the chart.

Of the five planets in angles, only the Sun is warm, while Mercury, Uranus and Saturn are cold, and Pluto is cool. This accounts for $\frac{1}{8}$ of the influence of the chart.

We may conclude, therefore, that Mercury in Aries would give some warm periods, but that the general tendency would be toward cool weather. Climatological Data records that both April and May were cooler than normal, but that June was slightly above normal.

The Asc. of the chart is 13 Cancer 38. Venus commonly betokens mildness of temperature, and on March 21 Venus came sextile the Asc. from Taurus. While the temperature on the 21st was 2 degrees lower, yet before the aspect left its 1 degree orb it started up, and on the 22nd was 8 degrees higher.

The next aspect to the Asc. was on the 3rd of April which, as might have been expected from the Sun in the fiery sign Aries making the square to the Asc., started a rise in temperature that lasted several days. Venus on the same days was semi-square the Asc. The 3rd was Sunday, but the reading on the 2nd showed 2 degrees warmer, and on the 4th up another degree, and on the 5th still another degree higher.

The Moon, which I here use in the absence of heavier aspects, in Taurus, made the sextile of the Asc. on the 8th, bringing a temperature rise on the 7th and 9th. Within 24 hours of the Moon's conjunction with the Asc. the temperature fell on the 14th.

Otherwise the temperature remained quite constant until the day of the next heavy aspect. Mars, itself, tends to heat; but at the same time Mars was square the Asc. on April 21, Mercury was moving slowly well within orb of square the Asc. There was a fall of 9 degrees on the day mentioned, but the temperature started up again while Mars was still within orb of square Asc.

May 4, the Sun came sextile the Asc., and slow-moving Jupiter made the perfect sextile with the Asc., starting a rise in temperature, commencing with 2 degrees up on the 5th, above what it registered on the 4th, and continuing upward for over a week.

Until May 19 the temperature changes were solely under the aspects from the Moon, but on that date the Sun came semi-square the Asc. This registered both as a rise and fall, up 3 degrees on the 18th, down 2 degrees on the 19th, and up 1 degree on the 20th.

Mercury, which commonly indicates a temperature drop, came sextile the Asc. on May 25, with temperature 7 degrees lower.

Then on May 28 Venus, which usually indicates milder weather, came conjunction the Asc., resulting in a rise of 2 degrees.

May 30, Mars came sextile the Asc., marked by a dropping off of 1 degree on the 31st, but with a sharp rise of 4 degrees on June 1, while the aspect was still within the one effective degree of perfect.

The semi-square of Mercury to the Asc. on the 2nd of June was offset by the warmth of the Sun semi-sextile Asc. on June 4. The two influences, one warm and the other cold, produced no change.

Then on June 9 Mercury came semi-sextile the Asc., with its customary influence, a falling off of the temperature during the following day of 3 degrees.

Venus had by this time turned retrograde, and by June 16th it had backed up to a conjunction with the Asc. with a rise of 4 degrees in temperature.

As the final aspect of the season, other than those of the Moon, so far as temperature was concerned, on June 20 Mars came to the sextile of the Asc., and on that day the temperature showed a rise of .4 degrees.

Summer Season, 1932

—The Sun entered Cancer June 21, 1932, at 7:30 a.m. LMT., Los Angeles. Chart No. 167, erected for this time, is given on page 43.

Libra, a cool sign, is on the cusp of the fourth, and Venus, its ruler, is in cold Cancer conjunction cold Mercury. This accounts for $\frac{1}{2}$ of the influence of the chart.

Jupiter, a warm planet, is in the first. Hot Leo is on the cusp of the first, but its ruler, the Sun, is in cold Cancer. This accounts for $\frac{1}{4}$ of the influence of the chart.

The Moon, ruling the sign occupied by the Sun, is in cold Aquarius, conjunction cold Saturn. This accounts for $\frac{1}{8}$ of the influence of the chart.

Of the three planets in angles, Jupiter is warm, but Saturn is cold and the Moon is cool. This accounts for $\frac{1}{8}$ of the influence of the chart.

Thus the reading for the whole season indicates more than usual cool weather, with some nice warm Jupiter periods. Climatological Data records that July and August, as well as latter June, were well below normal temperature, but that September was well above, there being much warm, sunshiny weather that month.

The Temperature Chart shows 3 Leo 32 on the Ascendant.

The first aspect, other than from the Moon, to the Ascendant occurred June 22 when Saturn came opposition the Asc., lowering the temperature on the 21st 3 degrees, on the 22nd 1 degree, and on the 23rd 1 degree more.

This downward trend, given by the slow moving Saturn, was checked on June 24 by the Sun coming semi-sextile to the Asc., giving an upward trend to the temperature of 3 degrees.

This influence of Saturn continued for some time, but Mars, the hot planet, came sextile the Asc. on June 27. It took a day to overcome the persistent influence of Saturn, but between the 28th and 29th the temperature rose 2 degrees.

July 4, Mercury came conjunction the Asc., but as this was a holiday there is no record, and the following day showed no change.

The square of the Moon to the Asc. on July 12 brought a drop of 4 degrees, but otherwise the temperature remained quite steady until Mars came semi-square the Asc. on July 18, with a rise of 3 degrees.

The conjunction of the Sun with the Asc. on July 26 brought a rise of only 1 degree in temperature; the parallel of Saturn to the Asc. throughout July tending to offset the influence of the Sun.

August 5, Venus came semi-sextile the Asc., with a rise in temperature of only 1 degree.

The weak aspect of Mars semi-sextile the Asc. from the cold sign Cancer on August 10 brought no recorded change.

The Moon square the Asc. on August 14, which was Sunday, was followed by a drop of only 1 degree recorded the following day, the temperature running about the same until the Moon made the trine to the Asc. from Aries, a hot sign, on August 19, with a rise of 5 degrees on the 18th and 1 degree on the 19th.

The next aspect, other than from the Moon, occurred August 26. It was Sun semi-sextile Asc., with a rise of 3 degrees.

Aug. 28, Jupiter also came semi-sextile the Asc. This was Sunday, but the record shows a fluctuation of 3 degrees down on August 29, and 2 degrees up on August 30.

Sunday, September 11, the Sun came semi-square the Asc. from cold Virgo, with a rise of 2 degrees recorded on Saturday the 10th. There is little heat in the sign Virgo, however, and by Monday, Sept. 12, the temperature was down 4 degrees; possibly due to the moderating influence of the planet Venus, which on that day came

conjunction the Asc. The tendency of Venus when the weather is cold is to make it warmer, and when the weather is hot to make it cooler.

Autumn Season, 1932

—The Sun entered Libra September 22, 1932, at 10:23 p.m. LMT., Los Angeles. Chart No. 168, erected for this time is given on page 45.

Four planets are in the fourth house. Jupiter and the Sun are warm, Neptune is cool, and Mercury is cold. Virgo, the sign on the cusp of the fourth is cold. Mercury, ruler of the sign on the cusp of the fourth, is in the cold sign Virgo. This accounts for ½ of the influence of the chart.

Moon in the first house is cool, and Gemini on the cusp of the first is cold. Mercury, the ruler of the sign on the Asc. is in cold Virgo. This accounts for ¼ of the influence of the chart.

Venus, ruling the sign occupied by the Sun, is in hot Leo. This accounts for 1/8 of the influence of the chart.

Of the five planets in angles, Sun and Jupiter are warm, but Moon and Neptune are cool, and Mercury is cold. This accounts for 1/8 of the influence of the chart. Furthermore, Mercury being in progressed aspect to the Asc. increases the tendency of the chart to indicate cold weather.

The indication are that under the influence of Sun and Jupiter in the fourth there would be some nice warm weather, but that much more of the weather would be cold.

Climatological Data reports that the temperature and sunshine were sub-normal during October, and that the daily range of temperature was large. November is reported to have been unusually warm, with more than average sunshine. But December was marked by a severe cold spell that prevailed from the 8th to the 14th, being so severe as to damage the citrus crop. December was decidedly a cold month.

As this chart has 25 Gemini 02 on the Ascendant, we must look to those days when the planets make aspect to this degree for the more marked temperature changes. And because the Moon is so close to the Ascendant of the chart, its aspects assume more than usual importance throughout the season. The Moon being so powerful in the chart, its aspects to the Ascendant gain unaccustomed power to indicate changes in temperature.

The first aspect, other than that of the Moon, was made immediately after the time for which the chart was erected. Mercury square Asc. was within the one effective degree of orb at the time the chart was erected, and brought a lowering of the temperature by 2 degrees on that day, Sept. 22.

The next aspect was the sextile of Venus to the Asc. on Oct. 3, accompanied by a drop of 1 degree on that day, and a raise of 1 degree on Oct. 4.

Then, on Oct. 11, Mercury came trine the Asc. with a rise of 6 degrees of temperature on the 11th, and a drop of 7 degrees on Oct. 12.

Oct. 18, the Sun came trine the Asc. with a rise of 3 degrees in temperature.

Oct. 20, Mercury came semi-square the Asc., with a rise of 6 degrees on Oct. 20, and a drop of 4 degrees on Oct. 21.

Sunday, Oct. 30, Mercury came to the inconjunct of the Asc., with a drop of 4 degrees of temperature recorded on Oct. 31.

Nov. 2, the Sun came sesqui-square the Asc., with a rise in temperature of 4 degrees.

Nov. 4, Mars came sextile the Asc., accompanied by a rise of 1 degree, followed by a drop the next day, and considerable increase a few days later.

Nov. 17, the Sun came to the inconjunct aspect with the Asc., with a rise of 5 degrees of temperature on the 17th, and a rise of 4 degrees more on the 18th.

The next aspect is Venus sesqui-square Asc. on Dec. 5, the day the Moon also made the square of the Asc. from Pisces. A drop of 4 degrees was registered for this day, and cold weather continued for a week, especially on those dates the Moon made aspects to the Asc.

The cold spell was broken as the Sun approached the opposition to the Asc. from Sagittarius. The aspect was complete Dec. 16, with a rise of 3 degrees on the 15th, and a rise of 1 degree on the 16th, followed by a still further rise of 4 degrees on the 17th. Venus is also inconjunct the Asc. on the 16th, and thus helped break the severe cold spell. No other aspects, except those of the Moon, influenced the Ascendant during this season.

Winter Season, 1932-1933.

—The Sun entered Capricorn December 21, 1932, 5:21 p.m. LMT., Los Angeles. Chart No. 169, erected for this time, is given on page 47.

There are two planets in the fourth. Jupiter, being close to the cusp of the fourth, has the major influence, and it is warm. But the Moon in the same house is cool. Virgo, on the cusp of the fourth is cold, but Mercury, its ruler, is in the warm sign Sagittarius. This accounts for $\frac{1}{2}$ of the influence of the chart.

Pluto in the first is cool, and Cancer on the cusp of the first is cold. The Moon, ruler of the first, is in the cool sign Libra. This accounts for $\frac{1}{4}$ of the influence of the chart.

Saturn, ruling the sign occupied by the Sun, is in cold Aquarius. This accounts for $\frac{1}{8}$ of the influence of the chart.

Of the four planets in angles, Jupiter is warm, Pluto and the Moon are cool, and Uranus is cold. This accounts for $\frac{1}{8}$ of the influence of the chart.

We conclude, therefore, that under the influence of Jupiter, and Mercury in Sagittarius, there will be many sunshiny, fine days during the season, and that while Jupiter will prevent extremes of low temperature, that the season as a whole will be a cold one.

This Climatological Data bears out in its report: “The mean temperature for January, as for the preceding month, was unusually low, but unlike December there was no severely cold weather, lower minimum temperatures having been recorded in January in 13 of the last 37 years.”

“February was a month with deficient rainfall, an abundance of sunshine, and sub-normal temperature.”

“The cold of January continued into the first decade of February. During the rainy period of the second decade the temperature rose to nearly normal.” . . . “Sub-normal temperature retarded the growth of range grasses and truck.”

Other than aspects of the Moon, the first aspect that occurred in the winter temperature chart was Venus inconjunct the Asc. on Dec. 26. There is no weather map for the 26th, but as might be expected from the moderating influence of Venus, Dec. 27 shows a rise of 2 degrees.

The next aspect was Sun opposition Asc. on Dec. 28. This was from the cold sign Capricorn, and the temperature went down 1 degree, instead of up. So heavy an affliction of the Ascendant by the Sun at this time of year cannot be counted on to moderate the weather.

Including All the Aspects Affecting Temperature.

—Thus far, because the heavier planets have a more enduring influence over the temperature, remaining within orb of the aspect they make to the Ascendant at least for more than one day, and perhaps for weeks or longer, I have neglected the influence of the Moon. Except by parallel, no aspect of the Moon to the Ascendant remains within the one effective degree of orb longer than about four hours. In natal astrology and stellar diagnosis, we call the progressed aspects made by major progressed Moon Sub-Major Aspects, because they are more powerful than minor progressed aspects, but weaker in their power to bring events into the life than the major progressed aspects of the other planets. Not only in natal astrology and stellar diagnosis, but also in mundane astrology, horary astrology and weather predicting we have found through extensive observation that the influence of progressed Moon, other things being equal, is 1/7 of that of other progressed planets.

Even though the influence of the aspects of the Moon to the Asc. is so temporary, nevertheless, for a complete study, on which to base predictions as to temperature changes, we must consider the normal temperature for the place at the particular season, the influence of the seasonal Temperature Chart as tending to cause a departure from this normal; and every aspect that forms to the degree on the Ascendant as having an influence, and marking the time of this influence, the aspects of the Moon included.

Consequently, that I may illustrate the minor details, as well as the heavier influences, let us use chart No. 169, page 47, which has 6 Cancer 54 on the Asc., giving the Ascendant 23 S 16 declination, and commencing Jan. 1, 1933, consider all the aspects in their detailed influence, Just as we would were we to undertake to make a day to day weather forecast.

As there was no weather report on Jan. 1st or Jan. 2nd, the first aspect to consider is Moon square Asc. from the hot sign Aries on Jan. 3rd, with a rise of temperature of 2 degrees between the 3rd and 4th.

Jan. 5, Mercury was parallel Asc., but the Moon was sextile Asc. from its exaltation in Taurus, with a rise in temperature of 8 degrees.

Jan. 7, the Moon was semi-square the Asc. from Taurus, with a rise of 5 degrees.

Jan. 8, the Moon was parallel and semi-sextile the Asc., but there was no weather chart for that day.

Jan. 10, the Moon was conjunction the Asc., and as would have been expected, the temperature dropped; it dropped 9 degrees.

Jan. 13, the Moon was parallel and semi-sextile the Asc. from the hot sign Leo, and the temperature went up 2 degrees, even though Mercury came to the opposition of the Asc.

Jan. 14, the Moon was semi-square the Asc. from the hot sign Leo, and the temperature went up another 3 degrees.

Jan. 15, the Moon went into the cold sign Virgo and made the sextile to the Asc. As this was Sunday there was no record, but on Jan. 16 the temperature went down 7 degrees.

Jan. 17, the Moon came square the Asc. from the cool sign Libra, lowering the temperature 2 degrees.

Jan. 19, Venus came to the opposition of the Asc., with its customary moderating influence, at the same time the Moon came trine the Asc. from Scorpio. Scorpio tends to extremes, never to moderation; often giving hot, sultry weather. On this day the temperature went up 7 degrees.

Jan. 20, the Moon came sesqui-square the Asc. from the extreme sign Scorpio, and back went the temperature, falling off 7 degrees.

Jan. 21, the Moon made the weak aspect, inconjunct Asc. from the warm sign Sagittarius, and the parallel aspect to the Asc., and the temperature went up 1 degree.

Jan. 24, Saturn made the semi-sextile to the Asc. and the Moon made the opposition to the Asc. from the cold sign Capricorn, and the temperature fell off 4 degrees.

Jan. 26, the Sun and Moon both made the inconjunct aspect to the Asc., and the temperature went up nearly 1 degree. The Sun is warm, and the less powerful Moon is cool, but the aspect was from cold Aquarius.

Jan. 27, the Moon came sesqui-square the Asc., with a further rise of 4 degrees.

Jan. 28, the Moon went into cool Pisces and made the trine to the Asc., with a lowering of 6 degrees in temperature.

Jan. 30, the Moon went into the hot sign Aries, making the square to the Asc., and the temperature went up 3 degrees.

Jan. 31, Mercury came inconjunct the Asc., and as should have been expected, the temperature dropped 2 degrees.

Feb. 1, the Moon made the sextile to the Asc., a moderate aspect, from the moderate sign Taurus, and the temperature went up 1 degree. Weak influences indicate weak changes in temperature.

Feb. 3, the Moon was again parallel the Asc., and also made the semi-square to the Asc. from Taurus, and the temperature went up another 3 degrees.

Government curtailment of the budget (this was a financial depression year) for Weather Maps caused these maps to be missing from my files from Feb. 3 to Feb. 17, 1933. So we will omit the aspects for which we have no coincidental records.

Feb. 17, Mercury was trine the Asc. from Pisces, and the temperature went down 3 degrees.

Feb. 18, the Moon in Sagittarius made the inconjunct to the Asc., with a rise of 5 degrees between the 18th and 19th.

Feb. 20, the Moon made the opposition to the Asc., but no weather record was issued between the 18th and 21st the reading being higher on the 21st than on the 18th.

Feb. 22, the Moon was parallel and inconjunct the Asc. from the cold sign Aquarius, and on Feb. 23 it was sesqui-square the Asc., and the temperature fell off 9 degrees during those two days.

Feb. 24, Venus was sesqui-square the Asc., and the Moon was trine the Asc., and on the 25th the Sun was trine the Asc. These aspects coincided with a rise of 8 degrees in temperature.

Feb. 26, the Moon was square the Asc. from hot Aries. As this was Sunday there was no record, but the temperature is shown rising on Feb. 25.

March 1, 1933, the Moon was sextile the Asc. from Taurus and there was a drop of 2 degrees.

March 2, the Moon was parallel the Asc. and semi-square the Asc., and the temperature fell off another 2 degrees.

March 3, the Moon was semi-sextile the Asc. from usually cold Gemini, yet the temperature went up 1 degree.

March 6, the Moon was conjunction the Asc., with a falling off of temperature 2 degrees between the 6th and the 7th.

March 8, the Moon was semi-sextile the Asc. from the hot sign Leo, but it was also parallel the Asc., and instead of going up, the temperature went down 2 degrees.

March 9, Mercury came within the one effective degree of orb of square the Asc., and the temperature, as usual under the influence of Mercury, fell off. It lowered 5 degrees. It remained within the one effective degree of orb for 9 days, moving to 7 Aries 27 on March 13, then turning retrograde, and moving out of orb of square Asc. on March 18.

March 10, the Moon was semi-square the Asc. from hot Leo, and in spite of Mercury's influence the temperature went up 2 degrees.

March 11, the Moon came sextile the Asc. from cold Virgo, indicating a downward fluctuation of temperature, but no records are available until March 13.

March 12, Mars made the sextile of the Asc., but as the aspect came from cold Virgo, this forced the temperature up only 1 degree on the 13th, as the 12th being Sunday there was no record.

March 13, in addition to Mars yet being sextile Asc. from cold Virgo, the Moon made the square of the Asc. from cool Libra. But as the square of Mercury was yet operative, as well as the cooling influence of the Moon, Mars was able to raise the temperature only 1 degree.

March 15, the Moon came to the trine to the Asc. from Scorpio and the temperature went up 2 degrees.

March 16, the Moon made the parallel with the Asc., but this coincided with almost no change in temperature..

March 17, the Moon made the inconjunct aspect with the Asc. from the hot sign Aries, but this seems to have been neutralized by Mercury still within the one effective degree of orb to the square of the Asc., and almost no temperature change took place.

March 19, the Moon made the opposition to the Asc. from the cold sign Capricorn. There was no record, for this was Sunday, but Mercury had now moved beyond the 1 degree of orb to square of Asc., and on Monday, March 20, the record shows the temperature 2 degrees warmer.

However, in considering this slight increase of temperature we must also make due allowance for the new temperature chart, which started the spring season at Los Angeles in 1933, on March 20, at 5:50 p.m. LMT.

The new chart, coming in on the 20th, had Sagittarius on the cusp of the fourth, and this, together with its other indications would have some influence on the temperature for March 20.

Above I have indicated by Weather Bureau records the influence of the aspects of the various planets to the Ascendants of the Temperature Charts, giving each temperature change in connection with the aspects of each planet other than the Moon for a period of some 15 months, and including the aspects made by the Moon to the Asc. for about three months.

It is good practice to study the temperature charts here given, and the influence of the aspects made to the Ascendant coincident with temperature changes, with an ephemeris at hand to check the aspects mentioned.

While this is good practice, and affords a preliminary foundation for further work, nothing can enable you to become efficient in predicting temperature changes, wind, and moisture precipitation in your own locality except through acquiring Weather Bureau records covering each season in your own area and becoming familiar with the normal weather to be expected, then erecting the weather charts for your vicinity and checking the temperature, air movements and precipitation from day to day, against these charts and the aspects made to the Ascendant of each as shown by the positions of the planets in the ephemeris. Such personal observations, if persisted in, will enable any intelligent person to do what most people consider marvelous things in weather predicting.

Such checking of the weather is now facilitated by the radio. The radio stations commonly not only give a forecast of the weather for 24 hours ahead or more, as issued by the Weather Bureau, but usually they report on the maximum and minimum temperature that was actually present during each day. And most newspapers have a paragraph or two indicating what the weather has been each day.

Chapter 4

Serial No. 193
Original Copyright 1949
Elbert Benjamine

Copyright
August 2002
Church of Light

Astrological Air Movement Charts

**Finding the Time of Day a Transit
Progressed Planet Ununiform in Motion
Reaches a Given Position.**

First find the increment or decrement of the planet during the 24 hours within which the time of its position is to be found. The increment or decrement found by taking the difference in the planet's daily motion on two consecutive days is that of the planet's average travel. And this average travel is its precise travel midway between the two noons of each day. Starting at midnight with the average increment or decrement, the acceleration or deceleration increases as the planet is distant from midnight. The travel of the planet at noon, therefore is this average travel between the two noons plus $\frac{1}{2}$ the daily increment or minus $\frac{1}{2}$ the daily decrement. With the noon travel ascertained, by proportion or by logarithms find the increment or decrement at the midway point between the planet's position at noon and the given position. Add the increment thus found, or subtract the decrement thus found, to or from the daily motion of the planet. Then use this as the average gain (a) and solve the problem in the ordinary way.

By logarithms, subtract log. (a) thus found from log. (b), the distance the planet must move to reach the required position. The result is the log. of (d), the EGMT Interval required to move (b) the distance. Use this EGMT Interval to calculate the positions of all the planets. From this interval, find the Greenwich time of day. From this time of day find the Local Mean Time at the place where the chart is to be erected, and calculate the house cusps of the chart from this LMT.

Chapter 4

Astrological Air Movement Charts

In judging the prevalence and velocity of the wind for any period, not only must the Air Movement Chart be considered, but also the Temperature Chart for the season. If the Temperature Chart does not indicate wind for the season, it takes an Air Movement Chart showing much activity to give even a moderate amount of wind. Each of the Air Movement Charts indicates how much, relative to the Temperature Chart for the season, will be present during the period it governs. And it shows exclusively, without reference to any other chart, on what dates such wind movements as take place will happen.

And, of course, before any intelligent predictions can be made as to wind from an Air Movement Chart, there must be a thorough knowledge as to just how much wind commonly may be expected at the given season. The chart is not absolute; it merely indicates the variations from the normal air movements, and when they will occur.

The Air Movement Charts are erected, at the place where it is desired to determine the air movements, for the exact moment the planet Mercury, either by direct motion or by retrograde motion, enters each sign. The chart so erected governs the wind for the period until Mercury, either by direct or by retrograde motion, enters another sign.

The stay of Mercury in a sign is variable. It may be only sixteen days, or it may be over two months. Like the wind, Mercury's movements are changeable. But however short or however long Mercury stays in a sign, that period is governed by the Air Movement Chart.

Unfortunately for ease in erecting Air Movement Charts, most ephemerides do not give the time of day when Mercury enters each sign. Before 1941 none of them did, but commencing that year the American Astrology Ephemeris has annually been giving this data precisely for Eastern Standard Time. As this is 5 hours west of the GMT may be found by adding 5 hours to the time thus given, and the Local Mean Time may be found by adding the time difference the place is east of the 75th meridian, or subtracting the time difference the place is west of the 75th meridian. If the American Astrology Ephemeris is used, in calculating both the positions of the planets and the Sidereal Time for which the chart is erected, the interval is 12h greater than when using a noon ephemeris, for its positions are calculated for 0h, the commencement of the civil day, which is the midnight preceding noon on that day.

But if the year is earlier than 1941, or an American Astrology Ephemeris is not at hand, the time Mercury enters each sign must be calculated. The rule for finding the time it thus enters a sign is given on page 54, and is illustrated by examples in considering the charts to be studied in this lesson.

For wind during the period covered by each Air Movement Chart, no other charts should be consulted as to the time when the winds will occur. Winds are indicated by the aspects made by the planets, in their movement through the zodiac and by change in declination, to the degree on the Ascendant of the Air Movement Chart covering the period. Mild aspects from mild planets do not stir up heavy winds, but only mild air movements. The more violent the planet and the more violent the aspect the more violent will be the wind indicated, always, of course, subject to what the chart indicates, and to the indications of the season Temperature Chart.

There is only one way to become sufficiently familiar with Air Movement Charts as indicating winds at any particular place that reliable predictions can be made. That is actually to observe each aspect as it forms to the Ascendant and the air movement coincident with it. This should be done from day to day over considerable time.

Weather Station reports, such as now in many regions are given over the radio, will assist in this. But I have found that with no wind blowing at 6:00 A.M., at the time the wind movement is recorded in the Weather Maps used in these studies, that it may be blowing a gale by 11:00 A.M., and quite subsided by sundown. Repeatedly, days on which the Weather Map has thus recorded almost no air movement at the time the observation was recorded for its use, I have observed much of the day to be gusty, or even extremely windy.

What the average individual wants, is to know, not how much wind is blowing before breakfast, but whether it will blow enough at any time during the day to inconvenience him in some anticipated under-taking. I mention this not in criticism of the Weather Map, which served its own purpose, but to indicate that in checking what the wind was on a given day its use is very restricted. Also, that the proper approach to understanding how to predict wind movements is carefully to watch the aspects of the planets to the Ascendant of the Air Movement Charts, and to record, in terms applicable to human undertakings, just what the wind did on such days.

Thus it may be recorded that there was a strong wind from the northwest all day, that it was quiet in the morning but gusty in the afternoon, that it was blowing a gale during the night, but quieted down by 10:00 A.M., that there was a warm zephyr, or whatever the conditions were. These notes, together with the aspects to the Ascendant which coincided with the recorded air movements, will form a sound basis for predictions in the kind of terms that the ordinary person understands and can use in his everyday planning.

To illustrate the method used, however, I will have recourse again to the Weather Maps issued by the U. S. Department of Agriculture, Weather Bureau. These maps up to July 7, 1932, as issued in California, give the velocity of the wind at certain stations at 6:00 A.M., Pacific Standard Time. After July 7, due to economy imposed upon the Weather Bureau, the velocity was not given. Some information, however, can be gleaned from the Climatological Data for each month, and we can use it as far as it goes.

Air Movement Chart December 19, 1931

—The ephemeris shows that between midnight Dec. 19 and midnight Dec. 20, 1931, Mercury backed into Sagittarius. At midnight Dec. 19 (daily motion between Dec. 19 and Dec. 20) Mercury is moving $1^{\circ} 20'$. At midnight Dec. 20 (daily motion between Dec. 20 and Dec. 21) Mercury is moving $1^{\circ} 22'$. The increment during 24 hours is the difference, which is $2'$.

The increment at noon on Dec. 20 is $\frac{1}{2}$ of this, or $1'$. Between Dec. 19 noon and Dec. 20 noon Mercury moves $1^{\circ} 20'$. Adding the $1'$ gives the travel on Dec. 20 at noon as $1^{\circ} 21'$. At noon Dec. 20 Mercury is past the aspect (b) $14'$. Between Dec. 19 noon and Dec. 20 noon as Mercury moves $80'$, to find the increment $\frac{1}{2}$ way from noon we take $\frac{7}{80}$ of the daily increment of $2'$, which is $0'$. We thus use the noon travel of Mercury, which is (a) $1^{\circ} 21'$.

Subtracting log. (a) 1.2499 from log. (b) 2.0122 gives .7623, which is the log. of (d) 4h 09m. Subtracting this from noon gives the Greenwich time as Dec. 20, 7:51 A.M. Subtracting 7h 53m (difference in time at Los Angeles) from this gives the time for erecting the chart as December 19, 1931, 11:58 P.M. LMT., Los Angeles. Chart No. 170, erected for this data, is given in lesson No. 191.

Los Angeles and its suburbs extend from the ocean to the mountains, and the Weather Bureau makes a separate wind velocity report from each edge of the region. One daily report is from Los Angeles Harbor, on the ocean, and the other is at the observatory on Mt. Wilson, about a mile in elevation, and plainly visible from Los Angeles. Roughly, the two stations thus reporting are about 40 miles apart, Los Angeles Harbor being visible from Mt. Wilson when the weather is clear.

While the wind in the metropolitan area of Los Angeles will almost always be of less velocity than the average of the two observation points, the average of the wind velocity at these two points is probably the best index we could have of the average over the Los Angeles area, it being understood that these observations do not cover the entire day, but are for 6:00 A.M. Pacific Standard Time. Therefore, in indicating the effect of the wind, not for the whole day, but as it is recorded at 6:00 A.M., I shall consider all the aspects formed to the Ascendant, and give the wind velocity as reported on that day at both observation points.

This Air Movement Chart indicates the wind, modified by seasonal Temperature Chart No. 165, given in lesson No. 190, from Dec. 19, 1931, until Jan. 14, 1932.

This Air Movement Chart No. 170 has windy Mercury, active Mars, stormy Saturn and moderating Venus in the fourth. Breezy Sagittarius is on the cusp of the fourth, and its ruler, Jupiter, is in the calm sign Leo. This accounts for $\frac{1}{2}$ of the influence of the chart.

Windy Virgo is on the cusp of the first, and Mercury, its ruler, is in the windy sign Capricorn. This accounts for $\frac{1}{4}$ of the influence of the chart.

Jupiter, ruling the sign Mercury is backing into, is in calm Leo. This accounts for $\frac{1}{8}$ of the influence of the chart.

Of the planets in angles, Pluto, Uranus, Mercury, Mars and Saturn tend toward wind, while only Venus tends toward calm. This accounts for $\frac{1}{8}$ of the influence of the chart.

While there would be some calm days, the indications are that there would be more wind than normal. This was borne out by Climatological Data.

In considering the aspects of the planets to the Ascendant of an Air Movement Chart it should be borne in mind that, as a rule, violent aspects, such as oppositions and squares, signify more wind than do harmonious aspects, such as trines and sextiles.

The Ascendant is occupied by 27 Virgo 52, which gives its declination as 00 S 50.

Dec. 20, the Sun made the square to the Asc., but as it was Sunday there was no record.

Dec. 21, the Moon came to the trine of the Asc., with wind registering 10 miles at the Harbor and only 5 miles at Mt. Wilson.

Dec. 22, Mercury made the square to the Asc., but this aspect, possibly due to trine of Moon to Asc., brought only 5 miles at the Harbor and 4 miles velocity on Mt. Wilson.

Dec. 24, the Moon came square the Asc. from the windy sign Gemini, and the wind rose in velocity to 8 miles an hour at the Harbor and to 20 miles an hour on Mt. Wilson.

Dec. 26, the Moon made the sextile to the Asc., and the wind at 6:00 A.M. was 8 miles an hour at the Harbor and 15 miles an hour on Mt. Wilson.

Dec. 27, was Sunday, with no record.

Dec. 28, the Moon was semi-sextile the Asc. from the calm sign Leo, resulting in wind velocity of 6 miles an hour at the Harbor and 15 miles an hour on Mt. Wilson.

Dec. 30, the Moon made the conjunction with the Asc., with a wind of only 5 miles an hour both at the Harbor and on Mt. Wilson. This day the Moon was also parallel the Asc.

Jan. 2, 1932, when the Moon came to the semi-sextile of the Asc. from the windy sign Libra, the wind velocity at both the Harbor and Mt. Wilson went up to 10 miles an hour at 6:00 A.M.

Jan. 2, Venus from the moderate sign Aquarius made the sesqui-square of the Asc., and the wind registered only 3 miles at the Harbor, but was up to 45 miles an hour on Mt. Wilson. The sesqui-square is not a harmonious aspect.

Jan. 6, the Moon was square the Asc. from the fairly active sign Sagittarius, and the wind at the Harbor registered 8 miles an hour and on Mt. Wilson only 4 miles an hour.

Jan. 9, the Moon made the sesqui-square of the Asc., and the wind registered only 3 miles an hour at both stations.

Jan. 11, the inconjunct of the Moon from Aquarius, a sign usually giving moderate movement, increased the velocity to 10 miles at the Harbor and to 12 miles on Mt. Wilson.

Jan. 12, showed little wind at 6 A.M., but that day windy Mercury made the square of the Asc., and on the 13th the Moon made the opposition of the Asc. from the windy sign Capricorn, resulting in a wind velocity of 18 miles an hour at the Harbor, but only 8 miles an hour on Mt. Wilson.

Jan. 14, Mars came to the trine of the Asc., and the wind continued with some velocity, registering 10 miles at the Harbor and 13 miles on Mt. Wilson.

Air Movement Chart, January 14, 1932

—The ephemeris shows that Mercury goes into Capricorn between midnight Dec. 13 and midnight Dec. 14. At midnight Dec. 13 (daily motion between Dec. 13 and Dec. 14) Mercury is moving $1^{\circ} 08'$. At midnight Dec. 14 (daily motion between Dec. 14 and Dec. 15) Mercury is moving $1^{\circ} 11'$. The increment during 24 hours is the difference, or $3'$.

The increment at noon on Jan. 14 is $\frac{1}{2}$ of $3'$, or $1\frac{1}{2}'$. Adding the $1\frac{1}{2}'$ to the motion at midnight Dec. 13, gives the travel on Jan. 14 at noon as $1^{\circ} 9\frac{1}{2}'$. At noon Jan. 14 to reach the aspect Mercury must move (b) $2'$. Between Jan. 14 and Jan. 15 Mercury moves $1^{\circ} 11'$, or $71'$. To find the increment $\frac{1}{2}$ way from noon to the position $2'$ past noon we take $1/71$ of the daily increment of $3'$, or $0'$. As the increment is a little more than that at noon, we use the noon travel, but the larger even $4'$ instead of the smaller. This gives the travel (a) as $1^{\circ} 10'$.

Subtracting log. (a) 1.3 133 from log. (b) 2.8573 gives 1.5440, which is the log. of (d) 41m. Adding this to Greenwich noon gives the EGMT as Jan. 14, 12:41 p.m. Subtracting the time difference from Los Angeles—7h 53m—gives the time for erecting the chart at Los Angeles as Jan. 14, 1932, 4:48 A.M. LMT. Chart No. 171, erected for this data, is given in lesson No. 191.

Windy Uranus and breezy Moon are in the fourth house. Breezy Aries is on the cusp of the fourth, and its ruler, Mars, is in windy Capricorn. This accounts for $\frac{1}{2}$ of the influence of the chart.

Windy Mercury is in the first house. Breezy Sagittarius is on the cusp of the first, and its ruler, Jupiter, is in the calm sign Leo. This accounts for $\frac{1}{4}$ of the influence of the chart.

Saturn, ruler of the sign occupied by Mercury, is in windy Capricorn. This accounts for $\frac{1}{8}$ of the influence of the chart.

Of the planets in angles, Pluto and Uranus are windy and the Moon is breezy. This accounts for $\frac{1}{8}$ of the influence of the chart.

We must conclude from the above that the period covered by this chart will be windy. Climatological Data bears this out, recording two storms; one from the 12th to the 15th, and the other from the 30th to the 31st. The first of these storms started under chart No. 170 when, as mentioned, first Mercury came square to its Asc., and then Mars came trine to its Asc., but carried on under chart No. 171, here considered.

“High winds occurred during the two stormy periods.” “On the 29th several stations in the mountain sections reported a blizzard.” Mercury in Capricorn on that day was both parallel the Asc. and semi-sextile the Asc. Capricorn favors blizzards.

On January 22 Jupiter backed to the one effective degree of orb of trine Asc., and remained within orb until the new Air Movement Chart came in on Feb. 4. Strong aspects to the Asc. from slow moving planets, as will be indicated in lesson No. 196, favor storms.

Jan. 15, the Moon came trine the Asc. from the fairly windy sign Aries, and the velocity registered at the Harbor was 24 miles, and on Mt. Wilson it was 10 miles an hour.

Jan. 16, the Moon moved into the still sign Taurus, and made the sesqui-square to the Asc. The wind moderated some, showing only 6 miles at the Harbor and 10 miles on Mt. Wilson.

Jan. 17, the Moon was inconjunct the Asc., but as it was Sunday there is no record.

Jan. 20, after being quite mild for a day or two, when Mercury came parallel the Asc., and the Moon made the opposition to the Asc. from the windy sign Gemini, the velocity jumped to 16 miles at the Harbor and 30 miles on Mt. Wilson.

Jan. 23, again after having a low velocity for a day or two, under the influence of active Mars semi-square the Asc., and Jupiter trine Asc., the velocity again went up; this time to 20 miles at the Harbor and 35 miles on Mt. Wilson. The Moon on the same day was inconjunct the Asc.

Jan. 25, the Sun, a still planet, made the semi-square to the Asc. from breezy Aquarius. The velocity at the Harbor was 6 miles, and on Mt. Wilson only 5 miles an hour.

Jan. 27, the Moon came to the square of the Asc. from windy Virgo, and the velocity increased somewhat, registering 8 miles an hour at the Harbor and 5 miles on Mt. Wilson.

Jan. 28, windy Mercury came semi-sextile the Asc., Jupiter was in perfect trine with the Asc., and the Moon was sextile the Asc. The wind increased to 12 miles an hour at the Harbor, and to 40 miles an hour on Mt. Wilson.

Jan. 30, with Mercury closely parallel the Asc. since the 27th, and the Jupiter aspect still close, the velocity at the Harbor was 8 miles an hour, and on Mt. Wilson 10 miles an hour.

Feb. 2, the Moon came conjunction the Asc., in the rather active sign Sagittarius, and the wind jumped to 16 miles at the Harbor. There was no record for that day on Mt. Wilson.

Feb. 3, Venus in Pisces, a rather still sign, came to the rather violent aspect, square the Asc. The result was 12 miles recorded at the Harbor, and 5 miles on Mt. Wilson. Had the aspect been from a more active sign, even though Venus is not a violent planet, but rather mild, the wind, no doubt, would have been higher.

Air Movement Chart, February 4, 1932

—The ephemeris shows that between midnight Feb. 4 and midnight Feb. 5 Mercury moves into Aquarius. At midnight Feb. 4 (daily motion between Feb. 4 and Feb. 5) Mercury moves $1^{\circ} 33'$. At midnight Feb. 5 (daily motion between Feb. 5 and Feb. 6) Mercury moves $1^{\circ} 34'$. The increment during 24 hours is the difference, which is $1'$.

The increment at noon on Feb. 5 is $\frac{1}{2}$ of this, or $\frac{1}{2}'$. The travel between noon Feb. 4 and noon Feb. 5 is $1^{\circ} 33'$. Adding the $\frac{1}{2}'$ to this gives the travel on Feb. 5 at noon as $1^{\circ} 33 \frac{1}{2}'$. At noon Feb. 5 Mercury is (b) $37'$ past the required position. Between Feb. 4 and Feb. 5 Mercury moves $93'$. To find the increment $\frac{1}{2}$ way from noon we take $19/93$ of the daily increment of $1'$, which is $0'$. As the travel is slightly less than the $1^{\circ} 33 \frac{1}{2}'$ at noon on Feb. 5, we use (a) $1^{\circ} 33'$ as its travel.

Subtracting log. (a) 1.1899 from log. (b) 1.5902 gives .4012, which is the log. of (d) 9h 33m. Subtracting the 9h 33m from noon gives the Greenwich time as Feb. 5, 2:27 A.M. From this subtract 7h 53m, the time difference of Los Angeles, and it gives the time for which the chart should be erected as Feb. 4, 1932, 6:34 P.M. LMT, Los Angeles. Chart No. 172, erected for this data, is given in lesson No. 191.

Scorpio, on the cusp of the fourth does not indicate wind unless the chart as a whole does. Its ruler, Mars, is in breezy Aquarius, and its co-ruler, Pluto, is in the quiet sign Cancer. This accounts for $\frac{1}{2}$ of the influence of the chart.

Calm Neptune is in the first house. Calm Leo is on the cusp of the first, and the Sun, its ruler, is in breezy Aquarius. This accounts for $\frac{1}{4}$ of the influence of the chart.

Uranus, ruler of the sign occupied by Mercury, is in windy Aries. This accounts for 1/8 of the influence of the chart.

Of the planets in angles, both Neptune and Venus are calm. This accounts for 1/8 of the influence of the chart.

We conclude from the above that while there may be a few blustery days, indicated by Uranus in Aries, the period as a whole will have little wind. This is borne out by the report in Climatological Data.

The chart has 28 Leo 41 on the Ascendant, which gives the declination of the Asc. as 11 N 56. The strongest indication of wind in the chart is Saturn within the one effective degree of orb of inconjunct the Asc. As this aspect came closer, even though an inconjunct, there was hail and sleet and some wind, registering highest two days before the aspect was perfect. Saturn is the storm planet.

Feb. 7, the Moon came parallel and opposition the Asc., but there is no record for that day as it was Sunday. The following day, Feb. 8, there was 10 miles an hour at the Harbor, but no record for Mt. Wilson.

Feb. 9, the Moon came inconjunct the Asc., and Saturn was within the 1 degree of effective orb of inconjunct the Asc. The wind registered 20 miles an hour at the Harbor and 10 miles an hour on Mt. Wilson.

Feb. 10, the Moon was sesqui-square the Asc., and Saturn closer to perfect inconjunct the Asc. The wind registered 12 miles an hour at the Harbor and 14 miles on Mt. Wilson.

Feb. 11, Saturn made the perfect inconjunct to the Asc., and Venus made the inconjunct to the Asc. The wind registered 8 miles at the Harbor and 15 miles on Mt. Wilson.

Feb. 12, the Moon came trine the Asc., and the wind went down to 5 miles an hour both at the Harbor and on Mt. Wilson.

Feb. 14, the Moon made the square of Asc., but as this was Sunday there was no record. The Moon was in Taurus, and on the 15th the wind registered only 8 miles at the Harbor and 4 miles on Mt. Wilson.

Feb. 17, the Moon made the sextile to the Asc., with a wind velocity of 8 miles at the Harbor, and 4 miles on Mt. Wilson.

Feb. 18, the Sun made the opposition to the Asc., and the velocity at the Harbor jumped to 12 miles an hour, but was still only 4 miles an hour on Mt. Wilson.

Feb. 19, the Moon came to the semi-sextile of the Asc., and kept the wind, with the help of the Sun opposition Asc. still in orb, 10 miles an hour at the Harbor, and raised it to 20 miles on Mt. Wilson.

Feb. 21 was Sunday, and the 22 was on a holiday, so there are no records for these two days.

Air Movement Chart, February 22, 1932

—The ephemeris shows that Mercury goes into Pisces between midnight Feb. 22, and midnight Feb. 23, 1932. At midnight Feb. 22 (daily motion between Feb. 22 and Feb. 23) Mercury is moving $1^{\circ} 48'$. At midnight Feb. 23 (daily motion between Feb. 23 and Feb. 24) Mercury is moving $1^{\circ} 50'$. The increment during the 24 hours is the difference, which is $2'$.

The increment at noon on Feb. 23 is $\frac{1}{2}$ of this, or $1'$. Adding the $1'$ to the travel of Mercury at midnight of Feb. 22, gives its travel at noon of Feb. 23 as $1^{\circ} 49'$. Between Feb. 22 and Feb. 23 Mercury moves $1^{\circ} 08'$. At noon Mercury is (b) $51'$ past the required position. We want the increment for $\frac{1}{2}$ this distance, or $\frac{26}{108}$ of the daily increment of $2'$, which gives $0'$. Thus we use the noon motion of Mercury on Feb. 23, which as above found is (a) $1^{\circ} 49'$.

Subtracting log. (a) 1.1209 from log. (b) 1.4508, gives .3299, which is the log. of (d) 11h 14m. Subtracting 11h 14m from noon gives the Greenwich time as Feb. 23, 12:46 A.M. From this subtracting the Los Angeles time difference of 7h 53m, gives the time at Los Angeles as Feb. 22, 1932, 4:53 P.M. LMT. Chart No. 173, erected for this data, is given on page 65.

Scorpio, ruler of the cusp of the fourth, gives little wind unless the chart as a whole indicates it. One of its rulers, Mars, is in breezy Aquarius, and the other, Pluto, is in calm Cancer. This accounts for $\frac{1}{2}$ of the influence of the chart.

Breezy Moon and quiet Neptune are in the first. Quiet Leo is on the cusp of the first, and its ruler, the Sun, is in calm Pisces. This accounts for $\frac{1}{4}$ of the influence of the chart.

Neptune, ruler of the sign occupied by Mercury, is in windy Virgo. This accounts for $\frac{1}{8}$ of the influence of the chart.

Of the 5 planets in angles, Sun and Neptune are calm, Mars and the Moon are breezy, and Mercury is windy. This accounts for $\frac{1}{8}$ of the influence of the chart.

The indications for the duration of this chart are that there will be some windy days, but that the wind will not be violent, and that days of moderate wind movement will be more common.

The Ascendant is occupied by 22 Leo 01, with a declination of 14 N 11.

Feb. 23, the Moon made the semi-sextile to the Asc. from windy Virgo. Only 2 miles per hour was registered at the Harbor, but the velocity was 20 miles an hour on Mt. Wilson.

Feb. 24, the Moon was semi-square the Asc. from windy Libra, and the wind was blowing 12 miles an hour at the Harbor and 5 miles an hour on Mt. Wilson.

Feb. 25, the Moon was sextile the Asc. from windy Libra, and the wind was blowing 11 miles an hour at the Harbor and 10 miles an hour on Mt. Wilson.

Feb. 27, the Moon came square the Asc. from the sometimes violent sign Scorpio, and the wind at the Harbor registered 16 miles an hour, and on Mt. Wilson 5 miles an hour.

Feb. 29, the Moon came trine the Asc. from the fairly windy sign Sagittarius, and the wind registered at the Harbor 10 miles an hour, and on Mt. Wilson 8 miles an hour.

March 1, the Moon was sesqui-square the Asc., with only 5 miles registered at the Harbor, and no wind on Mt. Wilson. Venus was also trine the Asc., but its influence is generally to moderate.

March 4, the Moon came opposition the Asc., and the wind at the Harbor registered 4 miles and on Mt. Wilson 14 miles an hour.

March 5, Mercury made the inconjunct to the Asc., with only 3 miles an hour at the Harbor, but 12 miles an hour on Mt. Wilson.

March 7, the Moon was inconjunct the Asc. from the calm sign Pisces, and the wind at the Harbor was 6 miles an hour, and on Mt. Wilson 5 miles an hour.

March 8, the Moon was sesqui-square the Asc., and the wind at the Harbor registered 6 miles an hour, and on Mt. Wilson 5 miles an hour.

Air Movement Chart, March 9, 1932

—The ephemeris shows that Mercury goes into Aries between midnight March 9 and midnight March 10, 1932. At midnight March 8 (daily motion between March 8 and March 9) Mercury is moving $1^{\circ} 55'$. At midnight March 9 (daily motion between March 9 and March 10) Mercury is moving $1^{\circ} 54'$. The decrement during 24 hours is the difference, which is $1'$.

The decrement on March 9 at noon is $\frac{1}{2}$ of this or $\frac{1}{2}'$. Adding the $\frac{1}{2}'$ to the travel of Mercury at midnight of March 9, gives the travel at noon of March 9 as $1^{\circ} 54\frac{1}{2}'$. Between noon March 9 and noon March 10 Mercury moves $1^{\circ} 14'$. At noon on March 9 Mercury needs to move (b) $39'$ to reach the required position. We want the decrement for $\frac{1}{2}$ this distance, or $\frac{20}{114}$ of the daily decrement of $1'$, which gives $0'$. We thus use the nearest even $'$ to the noon travel, which, as the position is reached after noon, is nearer (a) $1^{\circ} 54'$.

Subtracting log. (a) 1.1015 from log. (b) 1.5673 gives .4658, which is the log. Of (d) 8h 13m. Adding the 8h 13m to noon gives the Greenwich time as 8:13 P.M. From this subtracting the 7h 53m time difference of Los Angeles, gives the time at Los Angeles as March 9, 1932, 12:20 P.M. LMT. Chart No. 174, erected for this data, is given on page 67.

Windy Virgo is on the cusp of the fourth, and its ruler, Mercury, is in windy Aries. This accounts for $\frac{1}{2}$ of the influence of the chart.

Windy Pluto is in the first house, with breezy Cancer on the cusp of the first. Its ruler, the Moon, is in windy Aries. This accounts for $\frac{1}{4}$ of the influence of the chart.

Mars, ruler of the sign occupied by Mercury, is in calm Pieces. This accounts for $\frac{1}{8}$ of the influence of the chart.

Of the planets in angles, Pluto, Mercury and Uranus are windy, and the Moon is breezy. This accounts for $\frac{1}{8}$ of the influence of the chart.

The indications are that while during the period there will be many fairly calm days, the windy influences are pronounced enough that quite high winds may be expected at times. This is borne out by Climatological Data, which records several days of high wind in April.

The Ascendant is occupied by 8 Cancer 21, with a declination of 23 N 11.

March 11, the Moon made the sextile to the Asc. from Taurus, a mild aspect and a mild sign, and the wind at the Harbor recorded 6 miles an hour, and on Mt. Wilson 8 miles an hour.

March 12, the Moon was semi-square the Asc. from Taurus, and parallel the Asc. The wind at the Harbor registered 5 miles an hour, and at Mt. Wilson 8 miles an hour.

March 13, when the Moon made the semi-sextile to the Asc. was Sunday and there is no record.

March 14, Mercury made the square to the Asc., and the wind recorded at 6:00 A.M. on the 15th was 10 miles an hour at the Harbor and 4 miles an hour at Mt. Wilson.

March 16, Venus came sextile the Asc. from Taurus, and the Moon came conjunction the Asc. While the wind at the Harbor was only 3 miles an hour, on Mt. Wilson it was 35 miles an hour.

March 17, as a result of the two previous aspects, the wind at the Harbor was still 3 miles an hour, but had eased off on Mt. Wilson to 20 miles an hour.

March 18, the Moon was parallel Asc., but was also semi-sextile Asc. from the calm sign Leo, and the wind on Mt. Wilson dropped to 4 miles an hour, and was only 4 miles an hour at the Harbor.

March 19, the Moon was semi-square the Asc. from the still sign Leo, and the wind was only 2 miles an hour at the Harbor and 5 miles an hour on Mt. Wilson.

In considering the probable influence of the Air Movement Charts in producing wind during the three months following March 20, 1932, the Temperature Chart governing the season should also be scanned to perceive if the season as a whole will be windy. This chart, No. 166, is given in lesson No. 190.

It has windy Virgo on the fourth, and its ruler, Mercury, in windy Aries. Windy Pluto is in the first. Calm Cancer is on the cusp of the first, but its ruler, the Moon, is in windy Virgo. Mars, ruling the sign occupied by Mercury, is in calm Pisces. Of the four planets in angles, Sun is calm, but Pluto, Mercury and Uranus are windy. Thus for the season as a whole, considerable wind might be expected.

March 20, when the Moon made the sextile of the Asc., was Sunday, and there is no record; but on the following day this aspect from windy Virgo resulted in a record of only 4 miles an hour at the Harbor, but 25 miles an hour on Mt. Wilson.

March 22, when the Moon came square the Asc. from the windy sign Libra, the wind at the Harbor was 5 miles an hour, but on Mt. Wilson it had increased to 35 miles an hour.

The wind moderated on March 23, but March 24 the Moon came trine the Asc. from the extreme sign Scorpio, and while it registered only 3 miles an hour at the Harbor, it rose to 15 miles an hour on Mt. Wilson.

March 25, the Moon was parallel the Asc., and on March 26 it was inconjunct the Asc., resulting in a recording on the 26th at the Harbor of 4 miles an hour, and 25 miles an hour on Mt. Wilson.

March 29, the Sun came square the Asc. and the Moon opposition the Asc., and the wind registered 4 miles an hour at the Harbor and 10 miles an hour on Mt. Wilson.

March 31, the Moon made the inconjunct and the parallel to the Asc., and the velocity at the Harbor was only 4 miles an hour, and on Mt. Wilson only 3 miles an hour.

April 1, the Moon made the weak aspect, sesqui-square the Asc., and the wind at the Harbor continued at 4 miles an hour, and on Mt. Wilson at 3 miles an hour.

April 2, the Moon made the trine to the Asc. from the calm sign Pisces, and the wind at the Harbor registered 4 miles an hour, and on Mt. Wilson 6 miles an hour.

April 5, Venus came parallel Asc., and the Moon made the square to the Asc., and the wind at the Harbor registered 4 miles an hour, but on Mt. Wilson rose to 10 miles an hour.

April 7, the Moon came sextile the Asc., and the wind registered at the Harbor 8 miles an hour and on Mt. Wilson 5 miles an hour.

April 8, the Moon in Taurus made the semi-square the Asc., and as this is a slightly violent aspect, the wind gained somewhat, registering 8 miles an hour at the Harbor, and 20 miles an hour on Mt. Wilson.

April 10, the Moon came semi-sextile the Asc., but as it was Sunday there is no record.

April 12, the Moon was semi-sextile the Asc., and there was very little wind.

April 13, Venus was semi-sextile the Asc., and this brought the wind up to 6 miles an hour at the Harbor and to 10 miles an hour on Mt. Wilson.

April 14, Mars came square the Asc., and the Moon was parallel the Asc. While at 6:00 A.M. the wind at the Harbor registered only 7 miles an hour and at Mt. Wilson only 6 miles an hour, by the following morning, with Moon semi-sextile Asc., it had increased to 8 miles an hour at the Harbor and to 10 miles an hour on Mt. Wilson.

April 17, the Moon came sextile the Asc. from windy Virgo, but it was Sunday and there is no record. The following day, April 18, however, the wind registered 5 miles an hour at the Harbor and 10 miles an hour on Mt. Wilson.

April 19, the Moon came square the Asc. from windy Libra, and the velocity recorded at the Harbor was 12 miles an hour, and on Mt. Wilson 7 miles an hour.

April 21, the Moon was trine Asc. from the extreme sign Scorpio, and the velocity increased at the Harbor to 12 miles an hour, and on Mt. Wilson to 13 miles an hour.

April 22, the Moon made the parallel and the sesqui-square to the Asc., and the velocity was 6 miles an hour at the Harbor and 10 miles an hour on Mt. Wilson.

April 23, the Moon made the inconjunct to the Asc., and there was no wind at the Harbor, and only 5 miles an hour on Mt. Wilson.

April 25, the Moon made the opposition to the Asc. from windy Capricorn, and the wind rose to 10 miles an hour both at the Harbor and on Mt. Wilson.

April 27, the Moon made the parallel and the in-conjunct aspect from the breezy sign Aquarius, and the wind at the Harbor registered 8 miles an hour, while only 5 miles an hour was registered at Mt. Wilson.

April 28, the Sun, still in the calm sign Taurus, made the sextile to the Asc., and the Moon made the sesqui-square to the Asc. There was wind at only 2 miles velocity at the Harbor, but on Mt. Wilson it went up to 20 miles an hour.

April 29, the Moon came to the trine of the Asc. from calm Pisces, and the wind dropped off to 3 miles an hour both at the Harbor and on Mt. Wilson.

May 2, the Moon made the square of the Asc. from windy Aries and the velocity increased to 8 miles an hour at the Harbor, but remained at 3 miles an hour on Mt. Wilson.

May 4, the Moon came sextile the Asc., and the wind remained at 3 miles an hour on Mt. Wilson, and remained at 8 miles an hour at the Harbor.

May 6, under Moon parallel and semi-square the Asc., the wind increased to 7 miles an hour at the Harbor, and to 20 miles an hour on Mt. Wilson.

May 7, the Moon came semi-sextile the Asc. from the windy sign Gemini, and this increased the velocity at the Harbor to 8 miles an hour, but on Mt. Wilson the velocity dropped to 3 miles an hour.

May 9, the Moon came conjunction the Asc., a powerful aspect, and the velocity went up to 12 miles an hour at the Harbor and to 13 miles an hour on Mt. Wilson.

May 10, the Moon conjunction Asc. on the 9th took place after the 6:00 A.M. recording, and influenced the wind on the 10th also. The record at the Harbor was 10 miles an hour, and on Mt. Wilson 17 miles an hour.

May 12, the Moon moved into calm Leo, and made the weak semi-sextile aspect to the Asc., and the wind went down to only 2 miles an hour at the Harbor, but retained its 10 mile an hour velocity on Mt. Wilson.

May 14, the Moon came sextile the Asc. from windy Virgo, and the velocity at the Harbor was 8 miles an hour, and on Mt. Wilson was 6 miles an hour.

Air Movement Chart, May 15, 1932

—The ephemeris shows that Mercury goes into Taurus between midnight May 15 and midnight May 16, 1932. At midnight May 14 (daily motion between May 14 and May 15) Mercury is moving $1^{\circ} 16'$. At midnight May 15 (daily motion between May 15 and May 16) Mercury is moving $1^{\circ} 19'$. The increment is the difference, which is $3'$.

The increment on May 15 at noon is $\frac{1}{2}$ of this or $1\frac{1}{2}'$. Adding this to the travel at midnight May 14, gives the travel at noon on May 15 as $1^{\circ} 17\frac{1}{2}'$. Between May 15 and May 16 Mercury moves $79'$. At noon May 15 Mercury lacks (b) $35'$ of the required position. We want the increment $\frac{1}{2}$ way from noon to this position, or $18/79$ of the daily increment of $3'$, which is a little less than $1'$. To the noon travel of $1^{\circ} 17\frac{1}{2}'$ we add a little less than $1'$ and it gives us the nearest ' as (a) $1^{\circ} 18'$.

Subtracting log. (a) 1.2663 from log. (b) 1.6143 gives .3480, which is the log. of 10h 46m. Adding 10h 46m to noon gives the Greenwich time as 10:46 P.M. From this subtracting the 7h 53m difference in time for Los Angeles gives the time at Los Angeles as May 15, 1932, 2:53 P.M. LMT. Chart No. 175 erected for this data is given in lesson No. 194.

Windy Capricorn is on the cusp of the fourth. Its ruler, Saturn, is in the breezy sign Aquarius, square windy Mercury. This accounts for $\frac{1}{2}$ the influence of the chart.

Windy Libra is on the cusp of the first house, and its ruler, Venus, is in quiet Cancer. This accounts for $\frac{1}{4}$ the influence of the chart.

Venus, ruler of the sign occupied by Mercury, is in quiet Cancer. This accounts for $\frac{1}{8}$ of the influence of the chart.

Of the planets in angles, Venus moderates, but Pluto, Mars, Uranus and Saturn are windy. This accounts for $\frac{1}{8}$ of the influence of the chart.

The indications of the chart are that there would be calm days, followed by other days in which there would be rather high winds. Climatological Data confirms these indications.

The Asc. is occupied by 5 Libra 39, with a declination of 2 S 15.

May 16, the Moon came conjunction and parallel the Asc., but the wind registered at the Harbor was only 6 miles an hour, and on Mt. Wilson 3 miles an hour.

May 18, the Moon came semi-sextile the Asc. from Scorpio, and the wind velocity at the Harbor was 6 miles an hour, and on Mt. Wilson was 6 miles an hour.

May 20, the Moon made the mild aspect, sextile Asc., and the velocity at both the Harbor and on Mt. Wilson was only 4 miles an hour.

May 22, the Moon made the square of the Asc. from windy Capricorn. As it was Sunday there is no record. But the following day it registered 8 miles an hour at the Harbor and 25 miles an hour on Mt. Wilson.

May 24, the Moon made the trine to the Asc., a harmonious aspect, and the wind fell to 3 miles an hour at the Harbor and to 5 miles an hour on Mt. Wilson.

May 25, the Moon was sesqui-square the Asc., and before the day was out the Sun was trine the Asc. The wind rose to 9 miles an hour at the Harbor, and to 20 miles an hour on Mt. Wilson.

May 27, the Moon came inconjunct the Asc. from the calm sign Pisces, and the wind dropped to 4 miles an hour at the Harbor and to 10 miles an hour on Mt. Wilson.

May 29, the Moon was opposition the Asc. from windy Aries, but as it was Sunday there was no record.

June 1, the Moon was inconjunct the Asc. from the calm sign Taurus, and the wind dropped to only 3 miles an hour both at the Harbor and on Mt. Wilson.

June 3, the Moon came trine the Asc., and the wind was 5 miles an hour at the Harbor and 3 miles an hour on Mt. Wilson.

June 6, windy Mercury came trine the Asc., and the Moon came square the Asc., and the wind rose on Mt. Wilson to 25 miles an hour, but remained at 3 miles an hour at the Harbor.

June 8, the Moon came sextile the Asc. and Mars made the sesqui-square to the Asc. The velocity at the Harbor was 8 miles an hour, and on Mt. Wilson was 5 miles an hour.

June 9, the Moon came semi-square the Asc. from calm Leo, and the wind registered only 4 miles an hour at the Harbor, and only 5 miles an hour on Mt. Wilson.

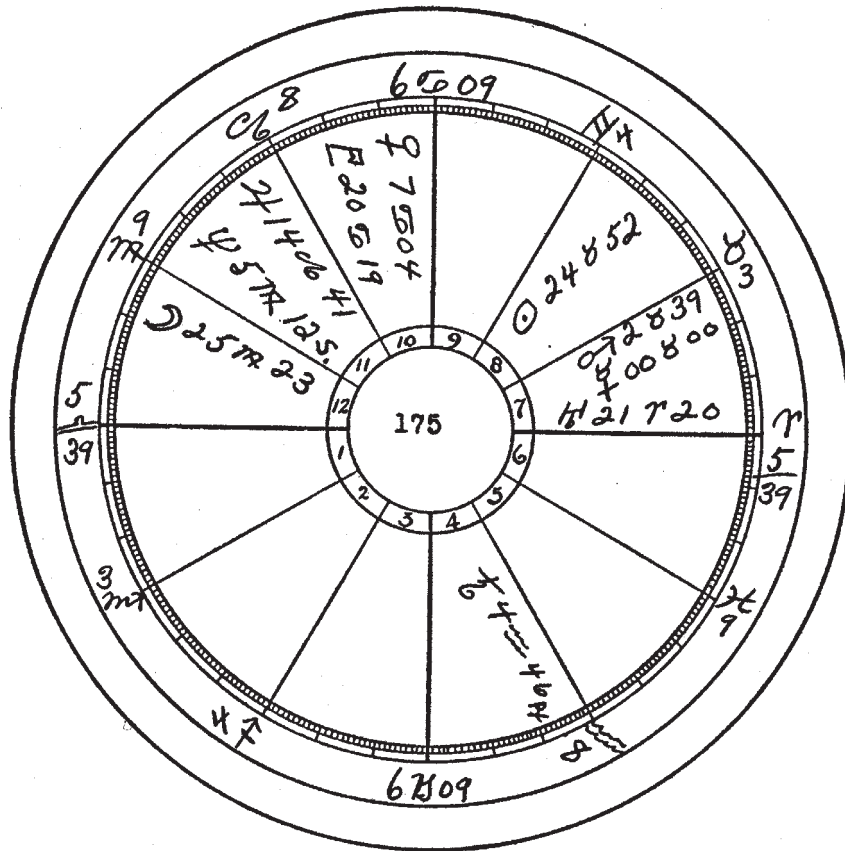

Air Movement Chart

May 15, 1932, 2:53 p.m. LMT. 118:15W. 34N.

Windy Capricorn is on the cusp of the fourth, and its ruler,

Saturn, is in breezy Aquarius, square windy Mercury.

Windy Libra is on the cusp of the first, and its ruler, Venus, is in calm Cancer.

Venus, ruler of the sign occupied by Mercury, is in calm Cancer.

Of the planets in angles, Venus moderates, but Pluto, Mars, Uranus and Saturn are windy.

Chapter 5

Serial No. 194
Original Copyright 1949
Elbert Benjamine

Copyright
August 2002
Church of Light

Astrological Moisture Charts

Moisture Chart Planets

	☉	☽	☿	♀	♁	♂	♃	♅	♁	♁	♁	♁	♁	♁	♁
176.	09♁27	07♁27	20♁07	07♁45	16♁49	28♁50r	23♁46	15♁28	07♁52r	21♁22r					
177.	16♁29	16♁29	23♁26	16♁19	22♁11	21♁16r	24♁35	15♁31	07♁47r	21♁05r					
178.	24♁32	24♁32	01♁36	26♁04	28♁20	20♁29r	25♁31	15♁38	07♁39r	21♁03r					
179.	02♁22	02♁22	11♁36	05♁32	04♁22	19♁36r	26♁25	15♁48	07♁29r	20♁55r					
180.	09♁19	09♁19	21♁37	13♁54	09♁44	18♁44r	27♁14	15♁59	07♁20r	20♁35r					
181.	16♁37	16♁37	02♁22	22♁39	15♁25	17♁47r	28♁05	15♁13	07♁09r	20♁27r					
182.	24♁52	24♁52	15♁36	02♁29	21♁49	16♁42r	29♁00	16♁31	06♁56r	20♁25r					
183.	02♁15	02♁15	28♁19	11♁14	27♁37	15♁47r	29♁48	16♁51	06♁43r	20♁18r					
184.	08♁57	08♁57	10♁36	19♁07	02♁53	14♁59r	00♁29	17♁09	06♁33r	20♁13r					
185.	29♁47	29♁47	24♁25	14♁28	01♁20	09♁14	28♁12	22♁15r	08♁33	23♁12					
186.	06♁51	06♁51	07♁30	22♁15	05♁39	10♁44	28♁07	21♁59r	08♁49	23♁16					
187.	13♁02	13♁02	18♁20	29♁12	09♁19	12♁00	28♁08	21♁44r	09♁01	23♁23					
188.	20♁55	20♁55	04♁30	19♁48	12♁30	22♁13	02♁02	19♁33r	10♁11r	23♁00r					
189.	28♁46	28♁46	07♁17	29♁24	15♁04	22♁44	02♁49	19♁28r	10♁10r	22♁55r					
190.	21♁13	21♁13	05♁01	26♁50	19♁46	23♁15r	05♁17	19♁32	09♁56r	22♁33					
191.	28♁45	28♁45	16♁13	06♁06	20♁16	23♁03r	06♁10	19♁39	09♁48r	22♁19r					
192.	05♁33	05♁33	26♁49	14♁27	20♁08r	22♁46r	06♁58	19♁47	09♁40r	22♁07r					
195.	13♁02	13♁02	24♁59r	08♁18	01♁21r	15♁19r	14♁09	22♁46	07♁55r	21♁15r					
Air Movement Chart Preceding Akron Disaster															
194.	04♁48	02♁01	00♁00	27♁55	02♁46r	16♁15r	13♁25	22♁17	08♁07r	21♁17r					

Chapter 5

Astrological Moisture Charts



For determining the amount of rain that will fall during a season, the Temperature Chart for that season must be consulted. But within the season, such rain as does fall will come down during those weeks that show the most wetness in the Moisture Charts. And within the week which shows rain will fall, the precipitation will be most pronounced on those days when planets make

Moisture Chart House Cusps						
No.	X	XI	XII	I	II	III
176.	♄02	♅08	♆14	16♁46	♄08	♁02
177.	♃09	♄12	♅21	27♆30	♁19	♄12
178.	♁07	♃06	♄13	25♅30	♆21	♁14
179.	♁02	♁27	♄19	11♃40	♁20	♃29
180.	♁02	♁04	♁01	23♁10	♄23	♃27
181.	♄01	♄24	♃16	14♁59	♃28	♅04
182.	♃27	♁23	♃28	11♅57	♆11	♁04
183.	♆07	♁09	♄10	08♁36	♁04	♁04
184.	♁08	♃07	♄14	26♅59	♆23	♁15
185.	♄17	♃09	♁04	08♃33	♄21	♅23
186.	♃01	♄04	♅13	20♆37	♁13	♄05
187.	♁21	♁18	♄10	02♃11	♁08	♃17
188.	♃29	♅04	♆11	14♁01	♄05	♄29
189.	♃06	♃29	♁29	09♄31	♅16	♆13
190.	♃29	♁26	♄02	15♅40	♆14	♁07
191.	♁04	♄06	♁06	03♁08	♁01	♄01
192.	♃26	♅02	♆09	12♁04	♄03	♄28
195.	♁28	♁23	♄14	04♃20	♁14	♃25
Air Movement House Cusps Akron Disaster						
194.	♅02	♆07	♁10	10♄08	♁03	♁00

heavy aspects to the Ascending degree. And as the Moon rules moisture, the heavy aspects made by the Moon to the degree on the Ascendant of the Moisture Charts in particular are indicative of precipitation.

But no matter how wet the Moisture Chart is, unless the Temperature Chart for the season within which it is erected also indicates precipitation, none will be present. Furthermore, the normal amount of precipitation in the given area at the particular time of year for which the Moisture Chart is erected also always must be taken into consideration. Both the Temperature Chart for the season, and the particular Moisture Chart under consideration, only indicate variations from the normal for that season at that definite place. The amount of rainfall, or snowfall, indicated by both charts is not absolute; but the days on which such rainfall or snowfall as does occur, are indicated exclusively by the Moisture Chart without reference to any other chart. They will be the days on which transit progressed planets, as shown by their positions in the ephemeris on the given calendar days, make aspects to the degree on the Ascendant of the Moisture Chart.

Fortunately for ease in calculating these Moisture Charts the various ephemerides issued annually give the time when the Moon makes the conjunction with the Sun, the first square to the Sun, the opposition to the Sun, and the last square to the Sun. The time given for each of these four aspects of the Moon to the Sun is the time for which Moisture Charts are erected. The chart erected for each of these aspects is the Moisture Chart covering the next seven days until the next Moisture Chart takes over the influence. Starting with the New Moon when the Moon is conjunction the Sun, moving the eye down the aspectarian, 7 days will bring it to the first square, and so on. But in most ephemerides, the time given for all aspects is Greenwich Mean Time. This is the time for which the positions of all the planets are calculated; for when an aspect between planets is complete, the positions of the planets in the zodiac are the same the world over.

But their house position differs with both longitude and latitude. Therefore, the Local Mean Time at the place for which the weather is to be forecasted must be ascertained by subtracting the time difference if the place is West of Greenwich, and adding the time difference if the place is East of Greenwich. The time difference is ascertained by multiplying each ° by 4 and calling it minutes, and each ' by 4 and calling it seconds, and then reducing to hours, minutes and seconds.

In the ephemeris for 1932 the aspectarian records that on Jan. 1, the Moon makes the square of the Sun at 1:23 a.m. To erect the Moisture Chart for this last quarter of the Moon it became necessary to subtract the Los Angeles time difference of 7h 53m from the mentioned Greenwich Time. Subtracting 7h 53m 00s from 1932y 1mo 1 d 1:23 a.m. gives the Local Mean Time at Los Angeles for which to erect the chart as 1931y 12m 31d 5:30 p.m. Therefore the sidereal time and house positions are calculated for Dec. 31, 1931, 5:30 p.m., and the planets are calculated as usual for Jan. 1, 1932, 1:23 a.m. EGMT.

Had the place for erecting the Moisture Chart been Denver, Colorado, where the time difference is 6h 59m 56s, the Local Mean Time would have been Dec. 31, 1931, 6h 23m 04s p.m. Had the place for erecting the chart been Des Moines, Iowa, with a time difference of 6h 14m 32s, the Local Mean Time would have been Dec. 31, 1931, 7h 8m 28s p.m. Had the place for erecting the chart been Cleveland, Ohio, with a time difference of 5h 26m 52s, the Local Mean Time would have been Dec. 31, 1931, 7h 56m 08s p.m. In each instance the house cusps used would be for the latitude of the place. Using the precise Sidereal Time ascertained from the Local Mean Time and the Sidereal Time given on that day in the ephemeris, and the Table of Houses for the nearest latitude to the place, and making the proper corrections, in each Moisture Chart the precise sign, °, and ' on the Ascendant should be ascertained; for it is the aspects to this position that determine when there will be precipitation.

In handling the relation between the aspects and the moisture precipitation records, for the purpose of indicating the relation between them, and how, therefore, to forecast rain, it will be necessary to proceed in a slightly different manner than we did when handling the Temperature Charts and the Air Movement Charts. On any day of the year, what ever the aspect to the Temperature Chart Ascendant, or without any aspect to it, there is always some temperature that may be recorded. And more often than not, regardless of the aspects to the Ascendant of the Air Movement Chart, there is some air movement to be recorded. But in most places there are more days in the year when no rain falls than days when precipitation may be recorded; and in many localities, such as Los Angeles, there are sections of the year when it is customary for months to pass without a drop of rain.

Thus if we are to consider every aspect that forms to the Asc. in such a semiarid region, most of them would coincide with no rainfall. Therefore, in following the records of the Weather Map, we shall here consider only those dates on which at least a trace of moisture fell, and observe the aspect made to the Ascendant on that day.

As there are so many Moisture Charts to consider, only their elements are given. These may be found for each Moisture Chart on pages 76 and 77, and may be copied off onto a blank chart for study. This should be supplemented by erecting Moisture Charts in the region where you live, and noting the influence of aspects to the Ascendant on the precipitation of moisture in that area.

Unlike the temperature record and the wind record, the precipitation record, resulting from moisture measurement at 5:00 a.m. Pacific Standard Time (8:00 a.m. Eastern Standard Time), records the total amount of rain which has fallen during the preceding 24 hours. It may, or may not, be raining at the time the measurement is made. Therefore, any aspect during the 24 hours preceding the record coincides with the recorded precipitation, rather than the aspects forming on the day the measurement is made unless the aspect was within the one effective degree of orb before the time the measurement was made.

It will be my practice, consequently, to state the day on which the aspect was perfect; and then follow this with the rainfall reading following the influence of the aspect. This reading usually will be the one recorded on the day following the one on which the aspect was perfect, on the assumption that the indicated rain did not start until the aspect was complete, although it may have started at any time while the aspect was within its one effective degree of orb.

However, we must bear in mind under a wet Moisture Chart, if the chart is wet enough, that a very slight aspect may start precipitation, and that the rain may continue unabated throughout the entire 7 days covered by the chart, and if the season is a wet one, and the next Moisture Chart is also wet, it may continue through the whole 7 days influenced by it also. For instance, in the Puget Sound region, in winter, it takes a very dry Moisture Chart to prevent it raining most of the week it influences.

The Moon is the one really wet planet of them all. And although it moves so rapidly, and by progression has only 1/7 the power of the other planets by similar progression, its aspects to the Ascendant are of prime importance in predicting the days, and the time of day, when rain may be expected. The heavier aspects, especially from watery signs, are more indicative of rain.

The conjunction and opposition of the Moon to the Ascendant of the Moisture Chart are most powerful to precipitate moisture, and the parallel, if at the same time some zodiacal aspect is operative, is next most powerful. Then come the square and the trine, followed in power by the sextile. The semi-square and sesqui-square are not quite so powerful as the sextile, and the inconjunct and semi-sextile are the weakest of all the aspects in power to bring rain.

Season Chart No. 165

—As we will start our examples relative to precipitation with January 1, 1932, our first step is to see what the winter season as a whole indicates. This information we gain from consulting Temperature Chart No. 165, erected for Dec. 22, 1931, at Los Angeles. This chart is given on page 38. A Temperature chart indicates not merely the temperature and when it will change due to aspects of the planets to the degree on the Ascendant, but in a general way also the amount of wind and the amount of moisture precipitation during the following three months.

This chart has dry Gemini on the cusp of the fourth, and its ruler, Mercury, in dry Sagittarius. This accounts for 1/2 of the influence of the chart.

Dry Uranus is in the first house, but the cusp of the first is occupied by wet Pisces. Neptune, ruling the cusp of the first, is in dry Virgo. This accounts for 1/4 of the influence of the chart.

Saturn, ruling the sign the Sun is in, is in stormy Capricorn. This accounts for 1/8 of the influence of the chart.

Of the planets in angles, all 4, Mercury, Sun, Mars and Uranus, are dry. This accounts for 1/8 of the influence of the chart.

We are warranted in concluding, therefore, that the season as a whole would be very dry; and this is borne out by the report in Climatological Data.

Moisture Chart No. 176

—This chart, erected for the last quarter of the Moon, Dec. 31, 1931, 5:50 p.m. LMT., Los Angeles, governs the first 7 days of 1932 in reference to precipitation, subject to the dry influence of season chart No. 165.

Dry Libra is on the cusp of the fourth, and its ruler, Venus, is in dry Aquarius. This accounts for 1/2 of the influence of the chart.

Moist Pluto is in the first house, and wet Cancer is on the cusp of the first. Its ruler, the Moon, is in dry Libra. This accounts for 1/4 of the influence of the chart.

The ruler of the sign Libra, occupied by the Moon, is Venus in the dry sign Aquarius. This accounts for 1/8 of the influence of the chart.

Of the planets in angles, Venus and Saturn are wet, and Pluto is damp, while Mars is dry. This accounts for 1/8 of the influence of the chart.

We conclude, therefore, that due to the wet planets in angles there will be a little rain, but that most of the week will be dry. Jan. 1, the Moon made the square to the Asc., and this was followed by .29 inches of rain during the next 24 hours. There was no other rain in Los Angeles during the week.

Moisture Chart No. 177

—This chart, erected for the New Moon on Jan. 7, 1932, 3:36 p.m. LMT., Los Angeles, also shows very little rain for the following week.

Dry Virgo is on the cusp of the fourth, and its ruler, Mercury, is in dry Sagittarius. This accounts for 1/2 of the influence of the chart.

Dry Gemini is on the cusp of the first, and its ruler, Mercury, is in dry Sagittarius. This accounts for 1/4 of the influence of the chart.

Saturn, the ruler of the sign the Moon is in, is in wet Capricorn. This accounts for 1/8 of the influence of the chart.

Of the planets in angles, both the Sun and Mars are dry. This accounts for 1/8 of the influence of the chart.

We conclude from these indications that the week following this New Moon will be even dryer than the preceding week, but that there will be some moisture.

On Jan. 12, when Mercury came opposition the Asc., there was a precipitation of .15 inches, and the following day, when the Moon made the square to the Asc., there was a precipitation of .04 inches.

Moisture Chart No. 178

—This chart, erected for the first quarter of the Moon, Jan. 15, 1932, 1:52 p.m. LMT., Los Angeles, is wet enough to cause considerable precipitation if the season chart showed wetness.

Dry Jupiter is in the fourth. Dry Leo is on the cusp of the fourth, and its ruler, the Sun, is in wet Capricorn. This accounts for $\frac{1}{2}$ of the influence of the chart.

Wet Taurus is on the cusp of the first, and its ruler, Venus, is in dry Aquarius. This accounts for $\frac{1}{4}$ of the influence of the chart.

Mars, ruling the sign occupied by the Moon, is in wet Capricorn. This accounts for $\frac{1}{8}$ of the influence of the chart.

Of the two planets in angles, Jupiter is dry and Venus is wet. This accounts for $\frac{1}{8}$ of the influence of the chart.

At the time of erection of the chart, the Sun was already $2'$ within, and applying to the trine of the Asc., and the only rain that fell was under this aspect, .01 inches being recorded on Jan. 15, and .44 inches the following morning. Saturn was also trine the Asc. during the duration of the chart.

Moisture Chart No. 179

—This chart, erected for Full Moon, January 23, 1932, 5:51 a.m. LMT., Los Angeles, if the season had been normal would have indicated considerable precipitation.

Wet Taurus is on the cusp of the fourth, and its ruler, Venus, is in wet Pisces. This accounts for $\frac{1}{2}$ of the influence of the chart.

Of the three planets in the first, Saturn is wet, but both Mars and the Sun are dry. Mercury, almost in precise conjunction with the Asc., is also dry. Saturn, ruler of the Asc., is in the wet sign Capricorn. This accounts for $\frac{1}{4}$ of the influence of the chart.

The Sun, ruling the sign occupied by the Moon, is in dry Aquarius. This accounts for $\frac{1}{8}$ of the influence of the chart.

Of the planets in angles, Moon, Saturn and Pluto favor rain; but Mars, Jupiter and the Sun are dry. This accounts for $\frac{1}{8}$ of the influence of the chart.

In this dry season the only rain that fell during the week was .01 of an inch, which fell Jan. 27 while Venus was within the effective 1 degree of sextile Asc.

Moisture Chart No. 180

—This chart, erected for the second square of Moon to the Sun Jan. 30, 1932, 1:42 a.m. LMT., Los Angeles, is a much different chart than the four already considered.

Wet Venus is in the fourth house. Wet Pisces is on the cusp of the fourth, but its ruler, Neptune, is in dry Virgo. This accounts for $\frac{1}{2}$ of the influence of the chart.

The wet sign Scorpio is on the cusp of the first, its ruler, Mars, is in the dry sign Aquarius, and its co-ruler, Pluto, is in the wet sign Cancer. This accounts for $\frac{1}{4}$ of the influence of the chart.

Mars, the ruler of the sign occupied by the Moon, is in the dry sign Aquarius. This accounts for $\frac{1}{8}$ of the influence of the chart.

The two planets in angles, Venus and Neptune, both tend toward moisture. This accounts for $\frac{1}{8}$ of the influence of the chart.

From such a chart as this, dominated by a normal Temperature Chart, quite heavy rains might be expected. Within 24 hours after the commencement of the influence of the chart Mercury came to the sextile of Asc., and at 5:00 a.m. of Jan. 30, as the chart came in there was a trace of rain recorded; and the next day, with Mercury making the sextile Asc., there was no record, as the day was Sunday. But during the day following the perfect aspect the record shows that 1.95 inches of rain fell.

Feb. 2, with Mars parallel Asc., and Moon semi sextile Asc., .53 inches were recorded.

Feb. 3, with Moon semi-square the Asc., the precipitation fell off to .02 inches.

The only other moisture recorded during the week was a trace which fell on the 5th, following the sextile of Moon to Asc.

Moisture Chart No. 181

—This chart, erected for New Moon on Feb. 6, 6:53 a.m. LMT., Los Angeles, is still a different type of influence. While otherwise dryer, Mars being within progressed conjunction the Asc., and Uranus being within progressed sextile to the Asc., give the chart unusual activity, and indicate almost as much precipitation as was indicated in Chart No. 180.

Dry Gemini is on the cusp of the fourth, and its ruler, Mercury, is in dry Aquarius. This accounts for $\frac{1}{2}$ of the influence of the chart.

Dry Mars and dry Sun are in the first, but the wet Moon is also there. Uranus, the ruler of the first, is in dry Aries. This accounts for $\frac{1}{4}$ of the influence of the chart.

Uranus, ruling the sign occupied by the Moon, is in dry Aries. This accounts for $\frac{1}{8}$ of the influence of the chart.

Of the six planets in angles, Sun, Mars and Jupiter are dry, while Moon, Venus and Neptune tend toward moisture. This accounts for 1/8 of the influence of the chart.

However, as previously indicated, the Asc. is given unusual activity by progressed aspects of Mars and Uranus to it. Heavy aspects to the Asc. of any weather chart, especially if within the one degree of effective progressed orb, tend toward storms. This is such a chart.

On the day the chart commenced, under the influence of the two progressed aspects to the Asc. a trace of rain was recorded.

Feb. 6, Mars came to the perfect conjunction the Asc., but as it was Sunday there is no record.

Feb. 8, Mars had moved beyond the conjunction with the Asc. but was parallel the Asc., and the record shows .64 inches of rain, and on the 9th, under this parallel aspect, there was 1.52 inches.

Feb. 10, when the parallel aspect was perfect, and the Moon came semi-square the Asc., .40 inches of rain was recorded.

Feb. 13, the Moon came parallel and square the Asc., and a trace of moisture shows on the records.

Moisture Chart No. 182

—This chart erected for the first square of the Moon on Feb. 14, 1932, 10:21 a.m. LMT., Los Angeles, also indicates some rain, but not because of heavy aspects to the Asc.

Dry Jupiter is in the fourth house, but wet Cancer is on its cusp, and its ruler, the Moon, is in wet Taurus. This accounts for 1/2 of the influence of the chart.

The wet Moon is in the first, and wet Taurus on the cusp of the first, while its ruler, Venus, is in dry Aries. This accounts for y~ of the influence of the chart.

Venus, ruling the sign occupied by the Moon, is in dry Aries. This accounts for 1/4 of the influence of the chart.

Of the planets in angles, Mars, Mercury and Jupiter are dry, while Saturn and the Moon are wet. This accounts for 1/8 of the influence of the chart.

As the Moon was in the first house and Mars was parallel the Asc., .32 inches of moisture fell during the hours following the erection of the chart.

Feb. 16, following the semi-sextile of the Moon to the Asc., .51 inches were recorded.

Feb. 17, the Moon made the semi-square to the Asc. and slightly more moisture, .74 inches, fell. The semi-square is both a little more powerful, and a little more violent than the semi-sextile.

Feb. 18, only a trace was recorded, but as the Moon made the sextile to the Asc. from the wet sign Cancer, this aspect recorded .23 inches on the 19th, during the hours following the aspect.

This completed the moisture precipitation for the week.

Moisture Chart No. 183

—This chart, erected for the opposition of the Moon to the Sun on Feb. 21, 1932, 6:15 p.m. LMT., Los Angeles, indicates dry weather.

Dry Sagittarius is on the fourth, and its ruler, Jupiter, is in dry Leo. This accounts for $\frac{1}{2}$ of the influence of the chart.

Dry Virgo is on the cusp of the first, and Mercury, its ruler, is in dry Aquarius. This accounts for $\frac{1}{4}$ of the influence of the chart.

Mercury, ruling the sign occupied by the Moon, is in dry Aquarius. This accounts for $\frac{1}{8}$ of the influence of the chart.

No planets in angles accounts for $\frac{1}{8}$ of the influence of the chart.

As might have been expected, no rain fell during the week following the date on which this chart started its influence.

Moisture Chart No. 184

—This chart was erected for the last quarter of the Moon, Feb. 28, 1932, 10:14 a.m. LMT., Los Angeles. It also is a quite dry chart.

Dry Jupiter is in the fourth, and dry Leo on its cusp. The ruler of the cusp of the fourth, the Sun, is in the wet sign Pisces. This accounts for $\frac{1}{2}$ of the influence of the chart.

Wet Taurus is on the cusp of the first, and Venus, its ruler, is in dry Aries. This accounts for $\frac{1}{4}$ of the influence of the chart.

Jupiter, the ruler of the sign occupied by the Moon, is in dry Leo. This accounts for $\frac{1}{8}$ of the influence of the chart.

Of the four planets in angles, Neptune is foggy, the Moon is wet, and Jupiter and Mars are both dry. This accounts for $\frac{1}{8}$ of the influence of the chart.

No rain fell during this week. The dry influence of the Temperature Chart had become so pronounced that no more rain fell during the season.

Because the summer half of the year in Los Angeles has so few rainy days, and 1932 was a dryer year than usual, to proceed with example charts that show at least a little precipitation, we will skip both the spring season and the summer season, and continue our examples starting with the autumn, first considering the Temperature Chart for this season.

Season Chart No. 168

—This chart, which is given on page 45, was erected for September 22, 1932, 10:23 p.m. LMT., Los Angeles.

Of the four planets in the fourth, Sun, Mercury and Jupiter are dry, and Neptune is moist. Dry Virgo is on the cusp of the fourth, and Mercury, its ruler, is in the dry sign Virgo. This accounts for $\frac{1}{2}$ of the influence of the chart.

The wet Moon is in the first, but dry Gemini is on the cusp of the first, and its ruler, Mercury, is in dry Virgo. This accounts for $\frac{1}{4}$ of the influence of the chart.

Venus, ruling the sign the Sun occupies, is in dry Leo. This accounts for $\frac{1}{8}$ of the influence of the chart.

Of the five planets in angles, Moon is wet, Neptune is damp, and the Sun, Mercury and Jupiter are dry.

On the whole, while the Moon's influence indicates some rain for the season, the chart is pronouncedly dry. And Climatological Data records that the precipitation for each of the three months it covered was decidedly subnormal.

Moisture Chart No. 185

—This chart was erected for the last quarter of the Moon, Sept. 22, 4:53 p.m. LMT., Los Angeles.

The wet Moon is in the fourth. Dry Gemini is on the cusp of the fourth, and its ruler, Mercury, is in dry Virgo. This accounts for $\frac{1}{2}$ of the influence of the chart.

Wet Pisces is on the cusp of the first, and its ruler, Neptune, is in dry Virgo. This accounts for $\frac{1}{4}$ of the influence of the chart.

Mercury, ruling the sign occupied by the Moon, is in dry Virgo. This accounts for $\frac{1}{8}$ of the influence of the chart.

Of the planets in angles, the Moon is wet, Neptune is moist, and Sun and Jupiter are dry.

However, Neptune is precisely opposition the Asc., and Jupiter is within the one effective degree of opposition the Asc. Such heavy aspects from slow moving planets tend to indicate storms.

Yet because it takes a wet season chart together with a real wet Moisture Chart to give rain in September in Los Angeles, none was experienced there. Rain in Los Angeles in September is unusual.

But the moisture indications, and also the storm indications shown by Jupiter and Neptune, within progressed opposition of the Asc. were fully borne out in the mountains surrounding Los Angeles. In Los Angeles the influence of the Neptune aspect only brought much fog.

Climatological Data for September, 1932, says of California: "Precipitation was decidedly deficient, except in the mountains of southern California, and in Inyo and Mono counties and portions of the desert region where it exceeded the normal. It nearly all occurred during the last week of the month."

Moisture Chart No. 186

—This chart was erected for the New Moon, Sept. 29, 1932, 9:37 p.m. LMT., Los Angeles. It is not particularly a wet chart, but is decidedly a storm chart.

Moist Neptune and dry Jupiter are in the fourth. Dry Virgo is on the cusp of the fourth, and its ruler, Mercury, is in dry Libra. This accounts for $\frac{1}{2}$ of the influence of the chart.

Dry Gemini is on the cusp of the first, and its ruler, Mercury, is in dry Libra. This accounts for $\frac{1}{4}$ of the influence of the chart.

Venus, ruler of the sign occupied by the Moon, is in dry Leo. This accounts for $\frac{1}{8}$ of the influence of the chart.

Of the planets in angles, Jupiter is dry and Neptune is moist. This accounts for $\frac{1}{8}$ of the influence of the chart.

When violent planets make heavy aspects, especially afflictions, there is a tendency toward destructive storms; and these storms, thus shown by the zodiacal aspects of the planets, tend to take place in those regions where the Ascendant is also severely afflicted in the weather charts.

In this chart there is a T-square formed by Saturn opposition Pluto, and Uranus making the square to both.

Uranus, one member of this T-square, is within $1^{\circ} 22'$ of perfect sextile to the Asc., violent Mars makes the progressed semi-square to the Asc. within $2'$ of perfect, and Neptune conjunction Jupiter in the fourth and in progressed semi-square aspect with Pluto, all tend toward violent weather. And because one of the violent influences—Mars—is in progressed aspect to the Asc., one might be sure that the violence would not long be delayed.

Under the aspect of Mars to the Asc., in Los Angeles .02 inches of rain was recorded on the day the chart commenced its influence, .10 inches fell on the next day, the 30th, and .02 on Oct. 1. All the rain that fell was precipitated while Mars was still semi-square the Asc.

For Los Angeles this was about what might have been expected with Neptune in the fourth, and so dry a chart. It was not much more than a heavy fog.

But about 100 miles north of Los Angeles, in practically the same Longitude, but the higher latitude bringing the Asc. to a position where Uranus was just within the one effective degree of sextile to it, there was a cloudburst. This was in the Tehachapi Mountains. And it was only there that the full violence of the chart was manifested.

Climatological Data records the storm briefly thus: "Excessive rains in the Tehachapi Mountains on the 30th flooded Agua Caliente and Tehachapi creeks, killing 15 persons and causing property losses estimated at over \$1,000,000, mostly public utilities. At Tehachapi the precipitation between 1:30 P.M. and 8:00 P.M. of the 30th was 4.38 inches."

Moisture Chart No. 187

—This chart was erected for the first square of the Moon, Oct. 6, 1932, 12:16 p.m. LMT. Los Angeles.

Dry Uranus is in the fourth, and dry Aries on the cusp of the fourth. Mars, the ruler of the cusp of the fourth, is in dry Leo. Thus this $\frac{1}{2}$ of the chart is completely dry.

Wet and stormy Saturn is in the first, and wet Capricorn is on the cusp of the first. Saturn, ruler of the cusp of the first is in wet Capricorn. In a normal season, in spite of the dry fourth, this $\frac{1}{4}$ of the chart being all wet would indicate some rain, especially as the wet Moon is also in the first.

Saturn, ruling the sign occupied by the Moon, is wet. This accounts for $\frac{1}{8}$ of the influence of the chart.

Of the planets in angles, Moon, Saturn and Pluto are wet, but Uranus is dry. This accounts for $\frac{1}{8}$ of the influence of the chart.

In a wet season, in spite of the complete dryness of the fourth house, we would have expected considerable rain. But as the season as a whole was so dry, only a little moisture could be looked for.

Here again the heavy afflictions among the planets indicated storm; but as none of the violent planets were closely in aspect with the Asc., and as there was no progressed aspect within the one effective degree of orb to the Asc., it was unlikely the indicated storm would occur within the area covered by this chart.

Oct. 9, Venus made the trine to the Asc., and before the next morning .06 inches of rain had fallen.

Because the season as a whole was so dry, there is no point in giving the charts of the weeks that followed up to the one for December 12.

Moisture Chart No. 188

—This chart was erected for the Full Moon of Dec. 12, 1932, 6:29 p.m. LMT., Los Angeles. Here again we find a chart showing violence, although in this one no zodiacal aspect is within the one effective degree of orb to the Asc., but both Pluto and the Sun are parallel the Asc. Both Pluto and Uranus are in angles, square to each other, and Saturn also in an angle opposition Pluto. The parallel of Pluto to the Asc. lasts through out the duration of the chart and connects up the violent influences with the region for which the chart was erected. Therefore it could logically be assumed that the stormy condition indicated by the afflictions in the sky would be felt in the region for which this chart was erected.

Dry Uranus is in the fourth. Dry Virgo is on the cusp of the fourth, and its ruler, Mercury, is in dry Sagittarius. This $\frac{1}{2}$ of the influence of the chart, except for the aspect of Uranus to moist Pluto, indicated dry weather.

Moist Pluto is in the first, opposition wet Saturn and square dry Uranus. Wet Cancer is on the cusp of the first, and the Moon, its ruler, is in dry Gemini. Here the $\frac{1}{4}$ influence of the chart is decidedly wet.

Mercury, the ruler of the sign occupied by the Moon, is in dry Sagittarius. This accounts for $\frac{1}{8}$ of the influence of the chart.

Of the planets in angles, Pluto is moist, Saturn is wet, and Uranus is dry. All three are violent. This accounts for $\frac{1}{8}$ of the influence of the chart.

Dec. 13, The Sun was parallel the Asc., and the record is .37 inches of rain.

Dec. 14, Mars came sextile the Asc., and there is recorded .09 inches of rain.

Dec. 15, Mars was still sextile the Asc., and there is recorded .03 inches of rain. And so far as Los Angeles itself was concerned that finished the storm and the precipitation for the week.

But in the mountains about 100 miles east of Los Angeles the violent conditions shown in the chart were manifest. The newspapers on the morning of December 13, 1932, carried these headlines:

“Snow, Rainstorm leaves Death Trail Over South land. 18-Foot Drifts Trap 200 at Big Bear; Rescued Later.” “3 Ammunition Barges Hurlled Against Pier Threaten Blast” This was south of Los Angeles at Los Angeles Harbor. Quoting further from the newspaper on the following day: “Six persons were killed, eleven perhaps fatally injured, and twenty others less seriously hurt in this section yesterday through traffic accidents, most of which were due to the weather.”

As the next moisture chart goes into the winter season, let us look at it for indications of rain during the winter months of 1933.

Season Chart No. 169

—This chart, which is given on page 47, was erected for December 22, 1932, 5:21 p.m. LMT., Los Angeles.

The wet Moon and dry Jupiter are in the fourth house. Dry Virgo is on the cusp of the fourth, and its ruler, Mercury, is in dry Sagittarius. This accounts for $\frac{1}{2}$ of the influence of the chart.

Moist Pluto is in the first house, and the wet sign Cancer on the cusp of the first. The Moon, ruler of the cusp of the first, is in the dry sign Libra. This accounts for $\frac{1}{4}$ of the influence of the chart.

Saturn, ruling the sign occupied by the Sun, is in dry Aquarius. This accounts for $\frac{1}{8}$ of the influence of the chart.

Of the four planets in angles, Pluto is moist and the Moon is wet, but Jupiter and Uranus are dry. This accounts for $\frac{1}{8}$ of the influence of the chart.

On the whole, the indications of the chart are that there would be as much, or more, than the average amount of rainfall for the season.

This was borne out by Climatological Data. But the peculiar thing about the weather was that almost the total rainfall for the season fell between the 15th and 31st of January. Therefore, let us consider the first Moisture Chart of the season, and then the three charts covering the period in which the precipitation was so heavy.

Moisture Chart No. 189

—This chart was erected for the last quarter of the Moon, December 20, 12:28 p.m. LMT., Los Angeles. It covers the first 5 days of the winter season, and thus during those days is subject to the winter season chart No. 169.

Moist Pluto is in the fourth house, and wet Cancer is on the cusp of the fourth. The Moon, ruler of the cusp of the fourth, is in dry Sagittarius. This accounts for $\frac{1}{2}$ of the influence of the chart.

Dry Uranus is in the first house, and dry Aries on the cusp of the first. Its ruler, Mars, is in dry Virgo. This $\frac{1}{4}$ of the influence of the chart is dry.

Mercury, ruling the sign occupied by the Moon, is in dry Sagittarius. This accounts for $\frac{1}{8}$ of the influence of the chart.

Of the two planets in angles, Uranus is dry and Pluto is moist. This accounts for $\frac{1}{8}$ of the influence of the chart.

Under such a chart, as the season promises rain, some moisture may be expected. However, such rain as did fall right in the Los Angeles area fell immediately following the start of the influence of the chart, and before the winter season commenced. It was only a trace, and was due to Neptune being within the one effective degree of orb of inconjunct the Asc.

Now let us skip the New Moon of December 27, 1932, and the first square of the Moon on January 3, 1933, as both of these Moisture Charts are exceedingly dry, and other than indicating dryness have no points of interest.

Moisture Chart No. 190

—This chart was erected for Full Moon January 11, 1933, 12:43 p.m. LMT., Los Angeles.

Wet Cancer is on the cusp of the fourth house, and its ruler, the Moon, is in dry Virgo. This accounts for $\frac{1}{2}$ of the influence of the chart.

Wet Taurus is on the cusp of the first house, and its ruler, Venus, is in dry Sagittarius. This accounts for $\frac{1}{4}$ of the influence of the chart.

The Moon, ruling the sign occupied by the Moon, is wet. This accounts for $\frac{1}{8}$ of the influence of the chart.

The only planet in an angle is wet Saturn. This accounts for $\frac{1}{8}$ of the influence of the chart.

Thus here we have quite a wet Moisture Chart.

Jan. 15, the Moon made the trine of the Asc., and the following morning the record was .08 inches of rain. This was the commencement of a rainstorm which lasted until Jan. 31.

Jan. 17, as Mercury moved up to trine Asc., the record showed 2.68 inches of rain.

Moisture Chart No. 191

—This chart was erected for the last quarter of the Moon, Jan. 18, 1933, 10:22 p.m. LMT., Los Angeles.

Sun and Mercury in the fourth house are dry, but Venus also in that house is wet. Capricorn, on the cusp of the fourth is wet, and its ruler, Saturn, is in dry Aquarius. This accounts for $\frac{1}{2}$ of the influence of the chart.

Wet Moon is in the first house, and the cusp of the first is occupied by dry Libra. Capricorn, occupied by Venus, ruling the cusp of the first, is wet. This accounts for $\frac{1}{4}$ of the influence of the chart.

Uranus, ruling the sign occupied by the Moon, is in dry Aries. This accounts for $\frac{1}{8}$ of the influence of the chart.

Of the planets in angles, the Moon and Venus are wet, and Uranus, Sun and Mercury are dry.

This accounts for 1/8 of the influence of the chart.

Jan. 19, the Moon made the semi-sextile of the Asc., and there was recorded .73 inches of rain.

Jan. 20, with the Moon semi-square the Asc. in this wet chart, the record was 2.31 inches of rain.

Jan. 21, under the milder aspect, Moon sextile Asc., the rainfall dropped off to .23 of an inch.

Curtailed of funds by the Government made records unavailable until Jan. 24.

Jan. 24, the Sun was trine Asc., almost out of orb of influence, and the record was .52 inches. But the newspapers indicate that on the two previous days while the Sun was trine the Asc. there was also considerable rain.

Moisture Chart No. 192

—This chart was erected for New Moon, January 25, 1933, 3:27 p.m. LMT., Los Angeles.

Dry Virgo is on the cusp of the fourth house, and its ruler, Mercury, is in wet Capricorn. This accounts for 1/2 of the influence of the chart.

Damp Pluto is in the first and wet Cancer on the cusp of the first. Moon, ruler of the cusp of the first is in dry Aquarius. This accounts for 1/4 of the influence of the chart.

Uranus, ruling the sign occupied by the Moon, is in dry Aries. This accounts for 1/8 of the influence of the chart.

Of the planets in angles, Pluto is damp and Venus is wet, while Uranus and Mercury are dry. This accounts for 1/8 of the influence of the chart.

Jan. 25, no rain fell.

Jan. 26, the Moon made the inconjunct with the Asc., and there was recorded 21 inches of rain.

Jan. 28, the Moon made the trine to the Asc. and there was .08 inches of rain.

Jan. 30, the Moon made the square of the Asc. and under this more violent aspect 1.48 inches of rain was recorded.

This finished the storm, and also practically all the rainfall for the three month season.

Moisture Chart 195

—This chart was erected for the first quarter of the Moon, April 3, 1933, 1:00 a.m., LMT., 74 W., 39:45N., off Barnegat Light, N.J.

Dry Aries is on the cusp of the fourth, and its ruler, Mars, is in dry Virgo conjunction Neptune. This accounts for $\frac{1}{2}$ of the influence of the chart.

Wet Capricorn is on the cusp of the first house, and its ruler, Saturn, is in dry Aquarius. This accounts for $\frac{1}{4}$ of the influence of the chart.

The Moon, ruler of the sign occupied by the Moon, is in wet Cancer. This accounts for $\frac{1}{8}$ of the influence of the chart.

Of the two planets in angles, Pluto is moist and the Moon is wet. This accounts for $\frac{1}{8}$ of the influence of the chart.

The significant thing about this chart is not the amount of precipitation, which would be about average for the season in New Jersey, but the conjunction of Sun with electrical and violent Uranus, and the square of both to violent Pluto and the Moon in an angle.

When storms are indicated, all three weather charts should be consulted both as to wind and moisture and other conditions. Mars, ruler of the cusp of the fourth is in windy Virgo, and windy Aries is on the cusp of the fourth. Stormy Capricorn is on the cusp of the first, and its ruler is in the electrical sign Aquarius.

On the date of the storm which tore the giant dirigible asunder with much loss of life, April 4, 1933, the Moon was parallel the Asc. More about this storm will be given in lesson No. 195.

Chapter 6

Serial No. 195
Original Copyright 1949
Elbert Benjamine

Copyright
August 2002
Church of Light

Unusual Weather

Unusual Weather Chart House Cusps

	Number	X	XI	XII	I	II	III
196.	ᄃ14	ᄅ07	ᄅ29	23ᄅ18	ᄅ05	ᄅ14	
197.	ᄃ21	ᄅ14	ᄅ06	01ᄅ24	ᄅ14	ᄅ22	
198.	ᄅ02	ᄃ01	ᄃ25	15ᄅ43	ᄅ19	ᄅ26	
199.	ᄅ16	ᄅ19	ᄅ19	13ᄅ15	ᄃ10	ᄅ11	
200.	ᄅ11	ᄅ18	ᄅ27	28ᄅ41	ᄅ18	ᄅ11	
201.	ᄅ06	ᄅ07	ᄃ02	21ᄃ57	ᄅ23	ᄅ29	
202.	ᄅ08	ᄅ15	ᄅ23	26ᄅ02	ᄅ16	ᄅ09	
203.	ᄅ18	ᄅ09	ᄅ02	07ᄅ08	ᄅ25	ᄅ25	
204.	ᄅ01	ᄅ08	ᄅ13	12 ᄅ 37	ᄅ03	ᄅ29	
205.	ᄅ27	ᄅ01	ᄅ00	23ᄅ10	ᄃ21	ᄅ23	
206.	ᄅ18	ᄅ25	ᄅ05	11ᄅ03	ᄅ00	ᄅ22	
207.	ᄅ22	ᄅ26	ᄅ25	18ᄅ48	ᄃ16	ᄅ18	
208.	ᄅ13	ᄅ16	ᄅ16	11ᄅ20	ᄃ08	ᄅ09	
209.	ᄅ02	ᄅ04	ᄅ15	24ᄅ01	ᄅ15	ᄅ07	
210.	ᄅ04	ᄅ10	ᄅ14	13ᄅ18	ᄅ05	ᄅ02	
211.	ᄅ11	ᄅ13	ᄅ14	10ᄅ05	ᄃ08	ᄅ08	
212.	ᄅ21	ᄅ25	ᄅ27	25ᄅ48	ᄅ20	ᄅ19	
213.	ᄅ29	ᄅ01	ᄅ01	25ᄅ53	ᄃ24	ᄅ26	
214.	ᄅ05	ᄅ08	ᄅ18	26ᄅ23	ᄅ17	ᄅ09	
215.	ᄅ19	ᄃ16	ᄅ07	28ᄅ24	ᄅ05	ᄅ15	
216.	ᄅ13	ᄅ19	ᄅ25	27ᄅ07	ᄅ18	ᄅ24	
217.	ᄅ11	ᄅ01	ᄅ23	24ᄅ14	ᄅ14	ᄅ17	
218.	ᄅ27	ᄅ01	ᄅ29	22ᄅ54	ᄃ20	ᄅ22	
219.	ᄅ23	ᄅ14	ᄅ08	17ᄅ13	ᄅ03	ᄅ02	

Unusual Weather Chart Planets

	☉	☽	☿	♀	♂	♃	♄	♅	♁	♂	♆	♁	♃	♄	♅
196.	00☉00	02☽26	08♁17	03♁30	14☽02	28♁54	09♁13	15♁01	01♁13	18☉37					
197.	25☉43	27♁15	00♁00	05♁08	03♁12	05☉01	07♁16r	15♁22	01♁58	19☉23					
198.	25☉36	25♁36	29☉42	04♁57	03♁06	04☉59	07♁17r	15♁22	01♁57	19☉23					
199.	00♁00	28♁18	04♁10r	21×55	03♁58r	16♁50r	12☉58r	22♁02	08♁14r	21☉19r					
200.	17♁18	23×38	00☉00	01☉04	15♁58	14♁32	16☉15r	26♁14	07♁31	21☉58r					
201.	23♁24	23×24	11☉58	07☉54	18♁54	15♁07	16☉06r	26♁28	07♁35	22☉14					
202.	00☉00	02☉32	24♁53	14☽44	01☽29	09♁17	28♁11r	22♁14r	08♁34	23☉12					
203.	10♁12	09♁01	00×00	00☉48	24☽26	17♁05	28♁54	20♁39r	09♁45	23☉24r					
204.	20×54	20☉54	04×30r	19♁49	12♁27	22♁13	02☉02	19♁34r	10♁11r	23☉00r					
205.	00♁00	28♁18	04♁10r	21×56	03♁58r	16♁50r	12☉58	22♁02	08♁14r	21☉19r					
206.	27♁09	02☉48	00♁00	26♁05	01♁02	14♁05r	15☉08	23♁34	07♁39r	21☉18					
207.	18☽48	18♁48	29♁16	23☽37	05♁02	13♁17r	16☉08	24♁49	07♁25r	21☉28					
208.	00♁00	28♁18	04♁10r	21×56	03♁58r	16♁50r	12☉58	22♁02	08♁14r	21☉19r					
209.	27♁08	05×40	00♁00	26♁08	01♁02	14♁05r	15☉08	23♁35	07♁39r	21☉58r					
210.	04☽02	04☽02	07♁13	04☽50	01♁47	13♁41r	15☉32	23♁59	07♁33r	21☉21					
211.	00♁00	28♁18	04♁10r	21×56	03♁58r	16♁50r	12☉58	22♁02	08♁14r	21☉19r					
212.	04♁48	02♁07	30×00	27×56	02♁56r	16♁15r	13☉25	22♁16	08♁08r	21☉18r					
213.	20♁14	20☉14	25×33	17♁22	00♁53r	14♁38r	14☉40	23♁10	07♁47r	21☉15					
214.	00☉00	07☉46	07♁44	08♁27	14☉47	09♁23	13☉23	17×33	16☽13	10☉29					
215.	09☽47	14♁29	00♁00	05♁36	10♁16	14♁39r	15☉02r	16×29	15☽23	09☉20					
216.	05☉46	05♁46	14♁19	15♁50	18☉42	09♁11r	13☉28r	17×33r	16☽23	10☉35					
217.	00☉00	02☽26	08♁28	03☽32	14☽02	28♁55	09♁14	15♁02	01♁15	18☉37					
218.	23♁00	03☉10	00♁00	24☉49	08☽40	27♁14	09♁46r	14♁50	01♁05	08☉36					
219.	10☉30	10☉30	26♁34	16☽32	21☽58	01☉26	08♁25r	15♁15	01♁30	18☉52					

Chapter 6

UNUSUAL WEATHER



Now that we have given some study to Temperature Charts and the dates on which temperature variations should occur, Air Movement Charts and the dates on which wind variations should occur, and Moisture Charts, and the dates on which precipitation should occur, we are prepared to consider charts indicating not just ordinary variations, but unusual variations from the normal trend of the weather. These include wind storms, electrical storms, fogs, sandstorms, tornadoes, hurricanes, blizzards, cloudbursts and other uncommon conditions of the weather.

In these studies, and those of more common weather conditions, we find that the outer-plane weather quite precisely mirrors the inner-plane weather during any particular period. But where this outer-plane weather will manifest pronouncedly depends upon the normal weather conditions of the areas of the world at that time of year, and the degree upon the Ascendants of the weather charts erected for given areas. We thus find that powerful aspects of any kind in the sky, and especially at those times when they are within the one effective degree of perfect that gives them the force of progressed aspects, always affect the weather in a corresponding manner on the earth. Invariably, discords in the sky bring disagreeable weather conditions on earth; and fine, harmonious aspects in the sky bring fine weather. However, even if the aspect is a trifle or sextile, if the planets are violent in their own nature, the weather also may be somewhat violent.

When there is a heavy affliction from the electrical planet Uranus to other slow-moving planets, we may be sure that the sudden violence of Uranus, and its electrical force, will play a part in the weather at that time. Saturn is the general storm planet. Its heavy afflictions from other planets invariably produce destructive weather conditions. These may vary from drought to flood and from hail or a sandstorm to a winter blizzard. Just how Saturn will act is not easy to determine; except that its weather tends, as Saturn is the planet of loss and disappointment, to destroy crops and property. It is not the most violent of the planets, but about one-half the afflictions and loss experienced by mankind are mapped by its influence. And this general observation of its influence in the other branches of astrology is applicable also to the amount of destructive weather indicated by it.

Neptune, when combined by destructive aspects with other heavy planets, gives weather of a rare type; fog, sandstorms, unusual objects falling with the rain, and the smog which now afflicts many present-day cities.

When violence is shown, if either Mars or Pluto is significant in the chart or by progressed aspect, the violence is increased.

Heavy afflictions in the sky always bring weather afflictions on the earth; but the destructive weather may be a flood in China rather than in the United States, or it may be a drought in India, the freezing of crops in Siberia, or a typhoon in Japan. An indicated hurricane may take place far to the south of the United States.

It is only when, by their house positions, the planets showing very heavy afflictions directly affect the given locality, as indicated by the weather charts erected at that place, that the indicated weather may be expected to have an influence at that place.

And where storms of extreme magnitude are indicated, or other unusual weather conditions, nearly always, at least in some measure, the Temperature Chart, the Air Movement Chart, and the Moisture Chart for the period are all three involved. Therefore, storms and unusual weather should not be forecast as to time except after a careful study of all three weather charts for the given period.

But when the Temperature Chart for the season shows violence at the particular place, and the Air Movement Chart shows violence at the particular place, and the Moisture Chart also shows violence at the particular place during the week. it covered, one may be sure that within the area covered by the charts there is going to be destructive weather that week. And a study of the aspects formed to the Ascendants of the charts often will enable the exact day of the storm to be predicted.

Now in order that we may, to best advantage, get some understanding of these violent aspects in the heavens which presignify storms and other unusual weather conditions, and how the planets are located by house position in the region where the unusual weather occurs, let us take events which are already on record, and analyze the weather charts which preceded them. The time for which these charts were erected is the Local Mean Time at the indicated place.

In this study, and in the prediction of unusual weather, *all three weather charts* must always come in for consideration. The Temperature Chart for the season, of course, indicates the weather for the season. But when the storm occurs, there must also be indications of it in the Air Movement Chart or the Moisture Chart, or both. More commonly the indications are shown in *all three charts*, and in all cases where unusual weather conditions are predicted all three charts should come in for careful consideration; for *all three* have a bearing on such weather.

To commence these studies, let us consider a quite local storm, just off the land at sea. It was, perhaps, no more violent, and was certainly less extensive, than numerous other storms in which there was no damage. This local storm is notorious, however,

because the U. S. dirigible, Akron, the world's mightiest airship at that time, had started on a short pleasure cruise, and was caught in the storm off Barnegat Light, New Jersey.

The giant airship was torn apart and fell into the sea, a total loss of 5,000,000 dollars. And of the 76 men aboard, only three survived. To complicate the disaster still further, the U. S. Navy blimp, J-3, sent next morning to the rescue, also was forced down by the storm, and two of her crew of seven were drowned, bringing the total dead to 75.

The Akron was caught in the twisting center of a thunderstorm area. The crash came April 4, 1933, "at 12:30 a.m., only a few hours after the start of a practice cruise from Lakehurst, New Jersey; a pleasure jaunt to Cape Cod to make compass adjustments."

Temperature Chart No. 193

—This chart was erected for March 20, 1933, 8:47 p.m., 74W. 39:45N. This Temperature Chart preceding the Akron disaster is given in lesson No. 190.

Stormy Saturn is in the fourth house. Electrical Aquarius is on the cusp of the fourth, and its ruler, Uranus, is in violent Aries. This accounts for $\frac{1}{2}$ of the influence of the chart.

Violent Scorpio is on the cusp of the Ascendant, and one ruler, Mars, is in windy Virgo, while the other ruler, Pluto, is in wet Cancer. This accounts for $\frac{1}{4}$ of the influence of the chart.

Mars, ruling the sign occupied by the Sun, is in windy Virgo. This accounts for $\frac{1}{8}$ of the influence of the chart.

Of the three planets in angles, all three—Saturn, Neptune and Mars—are violent. This accounts for $\frac{1}{8}$ of the influence of the chart.

Thus did the season for Barnegat indicate violent storms, and on April 4 violent Mars made the sextile aspect to the Ascendant.

Air Movement Chart No. 194

—This chart was erected for March 25, 1933, 4:46 p.m., 74W. 39:45N. Its elements are given in lesson No. 194.

Violent Scorpio is on the cusp of the fourth house, and one of its rulers, Pluto, is in breezy Cancer, while the other, Mars, is in windy Virgo. This accounts for $\frac{1}{2}$ of the influence of the chart.

Violent Mars is in the first house. Quiet Leo is on the cusp of the first, but its ruler, the Sun, is in violent Aries. This accounts for $\frac{1}{4}$ of the influence of the chart.

Mars; the ruler of the sign occupied by Mercury, is in windy Virgo. This accounts for $\frac{1}{8}$ of the influence of the chart.

Mars in an angle is violent. This accounts for 1/8 of the influence of the chart.

This chart certainly indicates much wind, and as Pluto is within the one effective degree of progressed square electrical Uranus, electrical disturbances are indicated. On April 4, Venus made the trine of the Ascendant, and windy Mercury came sesqui-square the Ascendant.

Moisture Chart No 195

—This chart was erected for April 3, 1933. 1:00 p.m., 74W. 39:45N. Its elements are given in lesson No. 194.

Dry but violent Aries is on the cusp of the fourth, and its ruler, Mars, is in dry but windy Virgo. This accounts for 1/2 of the influence of the chart.

Stormy Capricorn is on the cusp of the first, and its ruler, Saturn, is in electrical Aquarius. This accounts for 1/4 of the influence of the chart.

Cancer, the sign occupied by the Moon, is very wet. This accounts for 1/8 of the influence of the chart.

Of the planets in angles the Moon is wet, and because of its close square to electrical Uranus, Pluto is violent. This accounts for 1/8 of the influence of the chart.

On April 3 the Moon made the conjunction of Pluto in the seventh, and the square of Uranus, and then on April 4 it moved to the inconjunct of the Ascendant. This, together with the aspect of violent Mars to the Asc. of the Temperature Chart, and the aspect of Venus and windy Mercury to the Asc. of the Air Movement chart, released the weather indicated by electrical Uranus within progressed square of violent Pluto.

Usually even more local in extent, and more violent in both lightning and the downpour of rain, are cloudbursts. Already, in lesson No. 194, Moisture Chart No. 186, I have mentioned one example of a cloudburst which occurred about 100 miles north of Los Angeles. But another from a different locality is here warranted.

Temperature Chart No. 196

—This chart was erected for June 21, 1930, 8:47 p.m., Peña Blanca, New Mexico. Its elements are given on pages 94-95.

Violent Mars is in the fourth house. Calm Taurus is on the cusp of the fourth, and Venus, its ruler, is in calm Leo. This accounts for 1/2 of the influence of the chart.

Stormy Capricorn is on the cusp of the first house, and Saturn, its ruler, is in stormy Capricorn. Aquarius is intercepted in the first, and its ruler, Uranus, is in violent Aries. Saturn is square the Sun. Saturn is opposition Pluto, and violent Uranus makes a T-square with this opposition. This not only accounts for 1/4 of the influence of the chart, but shows there is much violence in the sky.

The Moon, ruling the sign occupied by the Sun, is wet. This accounts for 1/8 of the influence of the chart.

Of the planets in angles, Mars and Neptune tend to violence, while Venus tends to moderate the weather. This accounts for 1/8 of the influence of the chart.

Air Movement Chart No. 197

—This chart, the elements for which are given on pages 94-95 was erected for July 18, 1930, 7:30 p.m., Peña Blanca, New Mexico.

Violent Mars is in the fourth closely square violent Neptune and closely sextile windy Mercury. Calm Taurus is on the cusp of the fourth, but its ruler, Venus, is in windy Virgo, closely conjunction violent Neptune and closely square violent Mars. This accounts for 1/2 of the influence of the chart.

Electrical Aquarius is on the cusp of the first house, and its ruler, Uranus, is in violent Aries, square Pluto, square Sun, and square Saturn. This accounts for 1/4 of the influence of the chart.

The Sun, ruling the sign occupied by Mercury, is in breezy and wet Cancer, conjunction violent Pluto. This accounts for 1/8 of the influence of the chart.

Of the planets in angles, Mercury is windy, Venus is mild, and Mars and Neptune are violent. This accounts for 1/8 of the influence of the chart.

Moisture Chart No. 198

—This chart, the elements for which are given on pages 94-95, was erected July 18, 1930, 4:23 p.m., Peña Blanca, New Mexico.

The planet of lightning, Uranus, is in the fourth house, square violent Pluto. Violent Aries is on the cusp of the fourth, and its ruler, Mars, is in windy Gemini, closely square violent Neptune. This accounts for 1/2 of the influence of the chart.

The storm planet Saturn is in the first house, opposition Jupiter. Dry Sagittarius is on the cusp of the first, but its ruler, Jupiter, is in wet Cancer. This accounts for 1/4 of the influence of the chart.

Mars, ruling the sign occupied by the Moon, is in dry but windy Gemini, closely square Venus and closely square violent Neptune. This accounts for 1/8 of the influence of the chart.

Of the planets in angles, Saturn is stormy, the Moon is wet, Jupiter tends to fine weather, and Uranus tends to lightning and violence.

Of special significance in releasing the violent weather indicated, is progressed Uranus trine the Ascendant throughout the duration of the influence of the chart.

As a cloudburst lasts only a short time, perhaps less than an hour, and usually is confined to a region less than a mile square, where rain falls in torrents, the chart for the region is not necessarily wet; for most of the region covered by the chart may be dry. But a cloudburst always shows extreme violence. However, as the violence is due chiefly to water, we look chiefly to the Moisture Chart to time the date when it will occur.

This one at Peña Blanca, New Mexico occurred July 24, 1930, when Mars was parallel the Asc. of the Temperature Chart, Mercury was parallel the Asc. of the Air Movement Chart, and Uranus was trine and the Sun made the sesqui-square to the Asc. of the Moisture chart.

The cloudburst that resulted caused \$10,000 damage, demolishing 12 homes and covering the land on which people had raised crops with sand.

Of course, cloudbursts occur only in certain sections of the world, and a similar chart in another region would indicate violence of a different kind arising from the weather.

In direct contrast to such violent precipitations are droughts, such as the one experienced throughout the month of June, 1933, in the Midwest.

Temperature Chart No. 199

—This chart was erected for March 20, 1933, 7:16 p.m., Sioux Falls, South Dakota. Its elements are given on pages 94-95. It was erected for this place because this was the hardest hit of all the drought area, which extended over Kansas, Nebraska, Minnesota, Iowa, Illinois, Missouri, Oklahoma, and North and South Dakota. Not only was the wheat crop badly burned, but the corn crop also was severely damaged.

Both Saturn and the Moon in the fourth indicate rain, but Saturn tends to intensify any destructive condition of the weather, even droughts. Capricorn on the cusp of the fourth is stormy, but its ruler, Saturn, is in the dry sign Aquarius. This accounts for $\frac{1}{2}$ of the influence of the chart.

Dry Libra is on the cusp of the first, and its ruler, Venus, is in wet Pisces. This accounts for $\frac{1}{4}$ of the influence of the chart.

Mars, ruling the sign occupied by the Sun, is in dry Virgo. This accounts for $\frac{1}{8}$ of the influence of the chart.

Violent Pluto in the tenth house makes a progressed square to violent Uranus in the seventh house. Pluto is damp, but Uranus is dry. Moon and Saturn in the fourth tend to wetness, but Saturn was in progressed trine with the Asc. It is the storm planet, and in addition to the drought, there were many bad storms during the season. These angular planets account for $\frac{1}{8}$ of the influence of the chart.

Air Movement Chart No. 200

—This chart, the elements of which are given on pages 94-95, was erected for June 8, 1933, 7:34 a.m., Sioux Falls, South Dakota.

Dry Libra is on the cusp of the fourth, and its ruler is in wet Cancer. Libra is windy, and Cancer is breezy. This accounts for $\frac{1}{2}$ of the influence of the chart.

Wet and breezy Cancer is on the cusp of the first, and the Moon, its ruler, is in dry and breezy Sagittarius. This accounts for $\frac{1}{4}$ of the influence of the chart.

The Moon, ruler of the sign occupied by Mercury, is in dry and breezy Sagittarius. This accounts for $\frac{1}{8}$ of the influence of the chart.

Saturn in an angle, the seventh house, is in dry and breezy Aquarius. This accounts for $\frac{1}{8}$ of the influence of the chart.

Moisture Chart No. 201

—This chart, the elements of which are given on pages 94-95, was erected for June 14, 1933, 5:00 p.m., Sioux Falls, South Dakota. It does not, of course, represent the whole month of June, but only one week of it. This week, however, was the most severe period of the drought, and by the end of this week slight showers began to relieve the dryness in some sections.

The wet Moon is in the fourth house, opposition dry Mars and Jupiter in the tenth, and trine damp but extreme Pluto. Wet Pisces is on the cusp of the fourth, but its ruler, Neptune, is in dry Virgo, (the sign ruling grain). This accounts for $\frac{1}{2}$ of the influence of the chart.

Extreme Scorpio is on the cusp of the first house. One of its rulers, Mars, is in dry Virgo, while its other ruler, Pluto, is in wet Cancer. This accounts for $\frac{1}{4}$ of the influence of the chart.

Neptune, ruling the sign the Moon occupies, is in dry Virgo. This accounts for $\frac{1}{8}$ of the influence of the chart.

Of the planets in angles, Moon is wet, Neptune is moist, and Mars and Jupiter are both dry. This accounts for $\frac{1}{8}$ of the influence of the chart.

However, Pluto, which increases the extreme tendency of a chart, whatever that tendency is, is in progressed trine with the Asc., and is square Uranus. Dry Mars and Jupiter, as well as unusual Neptune are in the sign of grain, Virgo, opposition the Moon.

It would seem that progressed Pluto trine the Asc. in the Moisture chart, progressed Saturn trine the Asc. in the Temperature Chart, and progressed Jupiter semi-square Asc. in the Air Movement chart, enabled the heavy afflictions of the period to work out in terms of a drought which destroyed grain. Aspects within one degree of perfect to the Ascendant always have a powerful influence on the weather.

By way of still further contrast, instead of the heat and dryness of a drought, let us consider one of the cold spells, two or three of which usually occur each winter and cause death and much suffering.

The one here considered was not confined to any particular region of the United States. Instead, the newspaper headline for Dec. 12, 1932, reads: "52 Lives Lost as Cold Sweeps Entire Country." This was followed by the explanation: "Winter blazed a fresh trail across the country today. The temperature dropped to 3 degrees above zero in Chicago. The entire country, from coast to coast, suffered unusually severe climatic conditions. The bitter cold in Chicago followed a new fallen snow. Snow was falling over most of the Middle West, while rain and sleet were reported in the Eastern states to the Atlantic seaboard. Snow fell in Washington, Oregon, and Montana, with temperatures from zero to 15 below."

Temperature Chart No. 202

—This chart was erected for September 23, 1932, 0:24 a.m., Chicago, Ill. Its elements are given on pages 94-95.

Cool Libra is on the cusp of the fourth, but its ruler, Venus, is in hot Leo. This accounts for $\frac{1}{2}$ of the influence of the chart.

Hot Mars is in the first house, but cold Cancer is on the cusp of the first, and its ruler, the Moon, is in cold Cancer. Furthermore, while not making progressed aspects to the Asc., Pluto is conjunction the Asc., Saturn is opposition both Pluto and the Asc., and cold and extreme Uranus, from an angle is making a T-square to both of these oppositions. This accounts for $\frac{1}{4}$ of the influence of the chart, plus the influence of the indicated aspects.

Venus, ruling the sign occupied by the Sun, is in hot Leo. This accounts for $\frac{1}{8}$ of the influence of the chart.

Of the planets in angles, Mars is hot, Venus moderates, Uranus is cold, and Saturn is cold. This accounts for $\frac{1}{8}$ of the influence of the chart.

The significant thing about this chart is not that it indicates a cold season, but that the T-square from heavy planets, which include the Asc., indicate extreme weather at times which, as the T-square planets are cold, would tend to be cold.

Air Movement Chart No. 203

—This chart was erected for November 2, 1932, 2:20 p.m., Chicago, Ill. Its elements are given on pages 94-95.

Cold and windy Gemini is on the cusp of the fourth, and its ruler, Mercury, is in breezy and genial Sagittarius. This accounts for ½ of the influence of the chart.

Cold and windy Uranus is in the first house square cold Saturn and cool Pluto. Cool Pisces is on the cusp of the first house, and its ruler, Neptune, is in cold and windy Virgo. This accounts for ¼ of the influence of the chart.

Jupiter, ruling the sign occupied by Mercury, is in cold and windy Virgo. This accounts for 1/8 of the influence of the chart.

Of the planets in angles Neptune is cool, Jupiter is warm, and Uranus is cold and windy. This accounts for 1/8 of the influence of the chart.

The T-square involving Uranus in the first indicates some periods of extremely windy and cold weather.

Moisture Chart No. 204

—This chart, the elements of which are given on pages 94-95, was erected for December 12, 1932, 8:30 p.m., Chicago, Ill.

Venus in the fourth is wet, and Mercury in the fourth is cold and dry. Scorpio, on the cusp of the fourth, tends to extremes. One of its rulers, Mars, is in cold Virgo, and the other, Pluto, is in cool Cancer. Virgo is dry and Cancer is wet. This accounts for ½ of the influence of the chart.

Leo, on the cusp of the first is hot, but the sign occupied by its ruler, the Sun, is extreme Scorpio. This accounts for ¼ of the influence of the chart.

Mercury, ruling the sign occupied by the Moon, is in dry and genial Sagittarius. This accounts for 1/8 of the influence of the chart.

Moderate Venus and cold and windy Mercury are in an angle. This accounts for 1/8 of the influence of the chart.

Dec. 12, 1932, violent Mars made the semi-square of the Asc. of the Temperature Chart, made the parallel of the Asc. of the Air Movement Chart, and made the semi-sextile of the Asc. of the Moisture Chart. This released the extreme weather indicated by each chart.

Tornadoes and hurricanes receive special consideration in lesson No. 196. They are circular air movements. But there are also straight winds which have sufficient velocity to be highly destructive. Quoting from the newspaper: "Dayton, Ohio, May 9, 1933. A seventy mile an hour wind, accompanied by rain, hail and lightning, swept across southwestern Ohio today and caused damage estimated at \$1,000,000. Ten persons were injured here, none seriously.

"Hundreds of buildings were unroofed and power lines and trees blown down." Dayton received the brunt of the storm.

Temperature Chart No. 205

—This chart, the elements of which are given on pages 94-95, was erected for March 20, 1933, 8:06 p.m., Dayton, Ohio.

The Moon and the storm planet Saturn are in the fourth house. Capricorn is on the cusp of the fourth, and its ruler, Saturn, is in violent Aquarius. This accounts for $\frac{1}{2}$ of the influence of the chart.

Cold and windy Libra is on the cusp of the first, and its ruler, Venus, is in wet but calm Pisces. This accounts for $\frac{1}{4}$ of the influence of the chart.

Mars, ruling the sign occupied by the Sun, is in cold and windy Virgo. This accounts for $\frac{1}{8}$ of the influence of the chart.

Both the planets in angles, Moon and Saturn, are cold, and Saturn is stormy. This accounts for $\frac{1}{8}$ of the influence of the chart.

In addition to these factors, however, violent Neptune is in progressed semi-square to the windy Ascendant.

Air Movement Chart No. 206

—This chart, the elements of which are given on pages 94-95, was erected for April 17, 1933, 9:37 a.m., Dayton, Ohio.

Windy Virgo is on the cusp of the fourth, and its ruler, Mercury, is in violent Aries. This accounts for $\frac{1}{2}$ of the influence of the chart.

Violent Pluto is in the first house. Calm Cancer is on the cusp of the first, but the Moon, its ruler, is in violent Aquarius. This accounts for $\frac{1}{4}$ of the influence of the chart.

Mars, ruling the sign occupied by Mercury, is in windy Virgo. This accounts for $\frac{1}{8}$ of the influence of the chart.

Windy Mercury and violent and windy Uranus are in one angle, and violent Pluto in another angle is square Uranus. This accounts for $\frac{1}{8}$ of the influence of the chart. This is a violent and windy chart.

Moisture Chart No. 207

—This chart, the elements of which are given on pages 94-95, was erected for May 9, 1933, 4:27 p.m., Dayton, Ohio.

Stormy Saturn is in the fourth house. Stormy Capricorn is on the cusp of the fourth, and its ruler, Saturn is in violent Aquarius. This accounts for $\frac{1}{2}$ of the influence of the chart.

Windy Libra is on the cusp of the first, and its ruler, Venus, is in calm but wet Taurus. This accounts for $\frac{1}{4}$ of the influence of the chart.

Pluto, one ruler of the sign occupied by the Moon, is in wet Cancer, and the other ruler, Mars, is in the dry and windy sign Virgo. This accounts for $\frac{1}{8}$ of the influence of the chart.

Of the planets in angles, Saturn is stormy, Pluto is drastic, Mercury is windy, and Uranus is windy and violent. This accounts for $\frac{1}{8}$ of the influence of the chart.

Mercury is conjunction Uranus, and both are square Pluto.

May 9, when the storm broke, Venus was inconjunct the Asc. of the Temperature Chart, the Moon was parallel the Asc. of the Air Movement Chart, and the Sun was inconjunct the Asc. of the Moisture chart.

Next let us consider a freak storm. Quoting from the newspaper: "Kansas City, April 29: Freakish weather—a shower of mud in Kansas, snow in normally temperate places, severe dust and sand storms and high winds that made going hazardous for pedestrians—was served up in various parts of the West today.

"Rain falling through dust-laden atmosphere caused the mud shower at Dodge City, Kansas."

Temperature Chart No. 208

—This chart, the elements of which are given on pages 94-95, was erected for March 20, 1933, 7:03 p.m., Dodge City, Kansas.

Stormy Saturn and the wet Moon are in the fourth house. Stormy Capricorn is on the cusp of the fourth, and its ruler, Saturn, is in violent Aquarius. This accounts for $\frac{1}{2}$ of the influence of the chart.

Cold and windy Libra is on the cusp of the first, and its ruler, Venus, is in wet Pisces. This accounts for $\frac{1}{4}$ of the influence of the chart.

Mars, ruling the sign occupied by the Sun, is in cold and windy Virgo. This accounts for $\frac{1}{8}$ of the influence of the chart.

Of the planets in angles, Uranus is violent, Saturn is stormy, and the Moon is wet. This accounts for $\frac{1}{8}$ of the influence of the chart.

Air Movement Chart No. 209

—This chart, the elements of which are given on pages 94-95, was erected for April 17, 1933, 8:34 a.m., Dodge City, Kansas.

Pleasant Jupiter and violent Neptune are in the fourth. Windy Virgo is on the cusp of the fourth, and its ruler, Mercury, is in violent Aries. This accounts for $\frac{1}{2}$ of the influence of the chart.

Windy Gemini is on the cusp of the first, and its ruler, Mercury, is in violent Aries. This accounts for $\frac{1}{4}$ of the influence of the chart.

Mars, ruler of the sign occupied by Mercury, is in windy Virgo.

Moisture Chart No. 210

—This chart, the elements of which are given on pages 94-95, was erected for New Moon, April 24, 1933, at noon, Dodge City, Kansas.

Scorpio on the fourth is a dirty sign, and gives wetness. One ruler, Mars, is in dry Virgo, and the other ruler, Pluto, is in wet Cancer, square violent Uranus in the tenth house. The New Moon is in wet Taurus conjunction Venus. Progressed Jupiter is semi-sextile the Asc.

On April 29, 1933, the day of the mud storm, progressed Venus was inconjunct the Asc. of the Air Movement Chart, progressed Sun was semi-square the Asc. of the Air Movement Chart, and in addition to progressed Jupiter still being semi-sextile the Asc. of the Moisture chart, progressed

Mercury was trine the Asc. of the Moisture chart. At Dodge City the wind element, which is shown to be markedly violent and unusual, was not so prominent, but it manifest fully elsewhere.

“In Kansas City, several women were upset by the wind in the downtown district, one being carried 50 feet and receiving injuries that required hospital treatment. Sober citizens clung to lamp posts to retain their footing.”

As this mud storm was preceded by a sandstorm, let us now consider a sandstorm of such violence and length of duration that it occasioned not only inconvenience, but considerable damage.

The worst sandstorm in the history of Texas occurred April 13, 1933, in the Panhandle. The wind blew 40 to 50 miles an hour, making automobile traffic impossible. The sand buried fences, and the air was so thick with it that seeing more than a few feet was impossible. There were at intervals also gusts of rain, snow and sleet.

Temperature Chart No. 211

—This chart, the elements of which are given on pages 94-95, was erected for March 20, 1933, 6:55 p.m., Panhandle, Texas.

Moist Moon and stormy Saturn are in the fourth house. Again stormy Capricorn is on the cusp of the fourth, and its ruler, Saturn, is in violent Aquarius. This accounts for $\frac{1}{2}$ of the influence of the chart.

The Moon being opposition Pluto, and Uranus making a T-square to the opposition, increases the tendency to violence.

Windy Libra is on the cusp of the first, and its ruler, Venus, is in cool but wet Pisces. This accounts for $\frac{1}{4}$ of the influence of the chart.

The Moon, ruling the sign occupied by the Sun, is in stormy Capricorn. This accounts for $\frac{1}{8}$ of the influence of the chart.

Of the planets in angles, Pluto and Uranus tend to violence, Saturn tends to cold and storm, and the Moon to rain or snow. This accounts for $\frac{1}{8}$ of the influence of the chart.

It is an ugly looking season chart.

Air Movement Chart No. 212

—This chart, the elements of which are given on pages 94-95, was erected for March 25, 1933, 3:05 p.m., Panhandle, Texas.

The violent sign Scorpio is on the cusp of the fourth, and one of its rulers, Mars, is in dry and windy Virgo, while the other ruler, Pluto, is in wet Cancer. This accounts for $\frac{1}{2}$ of the influence of the chart.

Violent Mars, and the planet which gives fog or sandstorms, Neptune, are conjunction in the first house. The more pleasant Jupiter is also in the first house, but all three are in the windy sign Virgo. The Sun, ruling the cusp of the first, is in violent Aries. This accounts for $\frac{1}{4}$ of the influence of the chart.

Neptune, ruler of the sign occupied by Mercury, is in cold and windy Virgo. This accounts for $\frac{1}{8}$ of the influence of the chart.

Of the planets in angles, Jupiter is mild, but Mars and Neptune are violent. This accounts for $\frac{1}{8}$ of the influence of the chart.

Moisture Chart No. 213

—This chart, the elements of which are given on pages 94-95, was erected for Full Moon, April 10, 1933, 6:50 a.m., Panhandle, Texas.

Stormy Saturn is in the fourth house. Here again stormy Capricorn is on the cusp of the fourth, and its ruler, Saturn, is in the violent sign Aquarius. This accounts for $\frac{1}{2}$ of the influence of the chart.

Windy Libra is on the cusp of the first house, and its ruler, Venus, is in violent Aries. This accounts for $\frac{1}{4}$ of the influence of the chart.

Venus, ruling the sign occupied by the Moon, is in violent Aries. This accounts for $\frac{1}{8}$ of the influence of the chart.

The two planets in angles, Mars and Saturn, are both violent. This accounts for $\frac{1}{8}$ of the influence of the chart.

Sun is conjunction Uranus, and both are square Pluto.

April 13, when the sandstorm was at its peak— starting when Mercury came within the one degree of orb to the Air Movement Asc.—the Moon was sextile the Asc. of the Temperature Chart, Mercury was inconjunct the Asc. of the Air Movement Chart, and Mercury was inconjunct the Asc. of the Moisture Chart. When the Moon also made the semi-square of the Asc. of the Moisture Chart there was rain, snow and sleet.

Another kind of weather which occasionally causes considerable damage is hailstorms. Such a storm of wind and hail, in which the damage done by the hail was estimated at \$600,000, occurred June 29, 1923, at Dodge City, Kansas.

Temperature Chart No. 214

—This chart, the elements for which are given on pages 94-95, was erected for June 22, 1923, 4:23 a.m., Dodge City, Kansas.

Windy Virgo is on the cusp of the fourth house, and its ruler, Mercury, is in cold and windy Gemini. This accounts for $\frac{1}{2}$ of the influence of the chart.

Violent Mars and violent Pluto are conjunction with the Sun and with each other in the first house. Cold and windy Gemini is on the cusp of the first, and its ruler, Mercury, is in cold and windy Gemini. This accounts for $\frac{1}{4}$ of the influence of the chart.

Mercury, ruling the sign occupied by Mercury, is in cold and windy Gemini. This accounts for $\frac{1}{8}$ of the influence of the chart.

The three planets in the first house, the three in angles, are predominantly violent. This accounts for $\frac{1}{8}$ of the influence of the chart. But the fact that all three are also square Saturn, the planet of hail, should also be given consideration.

Air Movement Chart No. 215

—This chart, the elements of which are given on pages 94-95, was erected for April 30, 1923, 10:39 p.m., Dodge City, Kansas.

The Sun is in the fourth, but is opposition Moon and Jupiter and square Neptune, indicating violence. Violent Aries is on the cusp of the fourth, and its ruler, Mars, is in cold and windy Gemini. This accounts for $\frac{1}{2}$ of the influence of the chart.

Sagittarius is on the cusp of the first house, and its ruler, Jupiter, is in violent Scorpio. Capricorn, however, is intercepted in the first house, and its ruler, Saturn, is in windy Libra. This accounts for $\frac{1}{4}$ of the influence of the chart.

Mercury, ruler of the sign occupied by Mercury, is in cold and windy Gemini. This accounts for $\frac{1}{8}$ of the influence of the chart.

Pluto, Jupiter, Sun and Moon in the angles do not signify much wind for this $\frac{1}{8}$ influence of the chart.

However, the Sun in an angle is square violent Neptune.

Moisture Chart No. 216

—This chart, the elements of which are given on pages 94-95, was erected for June 29, 1923, 6:25 a.m., Dodge City, Kansas.

Saturn, the storm planet and the planet of hail, is right on the cusp of the fourth house. Jupiter is also in the fourth, indicating some very pleasant weather. Windy Libra is on the cusp of the fourth, and its ruler, Venus, is in cold and windy Gemini. This accounts for $\frac{1}{2}$ of the influence of the chart.

Unusual Neptune is in the first house. Wet Cancer is on the cusp of the first, and its ruler, the Moon, is in cold and stormy Capricorn. This accounts for $\frac{1}{4}$ of the influence of the chart.

Saturn, the ruler of the sign occupied by the Moon, is in cold, dry and windy Libra. This accounts for $\frac{1}{8}$ of the influence of the chart.

Of the planets in angles, Jupiter is warm and sunny, Neptune gives peculiar weather, and Saturn gives storms. This accounts for $\frac{1}{8}$ of the influence of the chart.

On June 29, 1923, the date of the hailstorm, violent Mars was square the Asc. of the Temperature Chart, the Sun was parallel the Asc. of the Air Movement Chart, and Uranus was square the Asc. of the Moisture Chart. These were all progressed aspects within the one effective degree of orb.

We need just one more type of weather fairly well to have covered unusual weather conditions, with the exception of tornadoes and hurricanes. So we will conclude this lesson with the three charts preceding an electrical storm. This electrical storm, on the evening of July 6, 1930, resulted in the destruction of a \$28,000 clubhouse at Clarence, N. Y.

Temperature Chart No. 117

—This chart, the elements of which are given on pages 94-95, was erected for June 21, 1930, 10:29 p.m., Clarence, N. Y.

Genial Jupiter and pleasant Sun are in the fourth house, but both are opposition Saturn, the planet of storms. Cold and windy Gemini is on the cusp of the fourth, and its ruler, Mercury, is in cold and windy Gemini. This accounts for $\frac{1}{2}$ of the influence of the chart.

Electrical Aquarius is on the cusp of the first, and its ruler, Uranus, is in violent Aries square violent Pluto. This accounts for $\frac{1}{4}$ of the influence of the chart.

The Moon, ruler of the sign occupied by the Sun, is in mild Taurus. This accounts for $\frac{1}{8}$ of the influence of the chart.

Of the planets in angles, Jupiter and Sun are pleasant, but Neptune is given to peculiar weather. This accounts for $\frac{1}{8}$ of the influence of the chart.

Air Movement Chart No. 218

This chart, the elements of which are given on pages 94-95, was erected for June —14, 1930, 2:29 p.m., Clarence, N. Y.

The Moon is in the fourth in the electrical sign Aquarius, and is square violent Mars. Stormy Capricorn is on the cusp of the fourth, and its ruler, Saturn, is in stormy Capricorn. This accounts for $\frac{1}{2}$ of the influence of the chart.

Windy Libra is on the cusp of the first, and its ruler, Venus, is in mild Cancer. This accounts for $\frac{1}{4}$ of the influence of the chart.

Mercury, ruling the sign occupied by Mercury, is in cold and windy Gemini. This accounts for $\frac{1}{8}$ of the influence of the chart.

Of the planets in angles, Moon tends to water and Mars to fire. Their square to each other tends to violence.

Moisture Chart No. 219

—This chart, the elements of which are given on pages 94-95, was erected for the first quarter of the Moon, July 2, 1930, 10:50 p.m., Clarence, N. Y.

Mercury and the Sun are in the fourth house, the Sun being opposition Saturn, square Uranus and conjunction Pluto. This is a very violent combination, and as Uranus is in an angle and involved, electricity would be featured in the storm indicated. Windy Gemini is on the cusp of the fourth, and its ruler, Mercury, is in windy Gemini.

Uranus, the planet of lightning, is in the first house, opposition Saturn, and square Sun, Moon and Pluto. Wet Pisces is on the cusp of the first, and its ruler, Neptune, is in dry Virgo.

Venus, ruling the sign occupied by the Moon, is in dry Leo. This accounts for 1/8 of the influence of the chart.

Of the planets in angles, Mercury is windy, Sun is dry, and Uranus is electrical.

July 6, when the lightning struck, progressed Mars was square the Asc. in the Temperature Chart, progressed Mars was inconjunct the Asc. of the Air Movement Chart, progressed electrical Uranus was parallel the Asc. of the Moisture Chart, and progressed Moon was trine the Asc. of the Moisture Chart.

Chapter 7

Serial No. 196
Original Copyright 1949
Elbert Benjamin

Copyright
August 2002
Church of Light

Tornadoes and Hurricanes

Tornado and Hurricane Chart Planets

	☉	☽	☿	♀	♂	♃	♄	♅	♆	♁	♃	♄	♅	♆	♁
244.	00☉00	01×09	14Ⅱ16	14☉53r	28±59	13♃06r	25±40r	21×30	18♁23	11☉34					
245.	21Ⅱ48	23±44	00Ⅱ00	17☉24r	25±39	14♃08r	25±49r	21×27	18♁09	11☉20					
246.	02☉17	02Ⅱ17	18Ⅱ48	13☉44r	29±48	12♃48r	25±38r	21×31	18♁26	11☉34					
247.	00Ⅱ00	04Ⅱ48	15×24r	28Ⅱ23	14Ⅱ53	14×43	07♃39r	29×25	24♁43r	13☉50r					
248.	14♁59	20☉18	00♁00	23Ⅱ14	11☉27	24×48	05♃49r	01Ⅱ52	24♁12	14☉06					
249.	17♁01	17♁01	04♁09	25Ⅱ43	12☉42	25×13	05♃41r	01Ⅱ57	24♁12r	14☉06					
250.	00±00	26♁48	23±05	27♁26	21±17	16Ⅱ10	24♃25	09Ⅱ46r	02Ⅱ11	19☉28					
251.	06Ⅱ21	08☉24	00±00	28☉43	05±22	14Ⅱ20	23♃54	10Ⅱ38r	01Ⅱ20	19☉04					
252.	02±29	02☉29	23±20r	00Ⅱ30	23±00	16Ⅱ16	24♃32	09Ⅱ40r	02Ⅱ16	19☉28					
253.	00☉00	17Ⅱ11	23☉02	16☉20	22Ⅱ14	15Ⅱ52	15±52r	26Ⅱ43	07Ⅱ42	22☉21					
254.	04☉57	19♁21	00♁00	22☉40	24Ⅱ49	16Ⅱ29	15±36r	26Ⅱ54	07Ⅱ49	22☉32					
255.	27♁42	27♁42	19♁40	29Ⅱ41	26±47	25Ⅱ51	11±54r	27Ⅱ16r	09Ⅱ29	23☉51					
256.	00☉00	17Ⅱ11	23☉02	16☉20	22Ⅱ13	15Ⅱ52	15±52r	26Ⅱ43	07Ⅱ42	22☉21					
257.	09Ⅱ17	13±23	00Ⅱ00	14±04	04Ⅱ32	28Ⅱ20	11±07r	27Ⅱ03r	09Ⅱ55	24☉11					
258.	11Ⅱ12	11×12	03Ⅱ50	16±25	05Ⅱ50	28Ⅱ44	10±59r	27Ⅱ00r	10Ⅱ00	24☉13					
259.	00☉00	12Ⅱ49	18☉45	22♁12	04Ⅱ53	27±06r	20Ⅱ13r	29×23	22♁39	13☉53					
260.	12Ⅱ29	27♁21	00Ⅱ00	22♁48	14♁45	19±37r	20Ⅱ54	28×04r	25♁12r	15☉38					
261.	21Ⅱ35	21♃35	17Ⅱ39	04Ⅱ19	18♁04	18±39r	21Ⅱ35	27×41r	25♁33	15☉41					
262.	00☉00	20♁48	11☉35r	27Ⅱ16	26Ⅱ36	03♁24	14♃45r	07Ⅱ13	26♁56	16☉15					
263.	12Ⅱ49	26♁12	00±00	00±52	16Ⅱ31	10♁22r	12♃49	06Ⅱ18r	29♁27	17☉58					
264.	14Ⅱ03	14Ⅱ03	01±39	02±27	17Ⅱ14	10♁20r	12♃51	06Ⅱ15r	29♁30	17☉58					
265.	00☉00	20♁46	11☉35r	27Ⅱ16	26Ⅱ36	03♁24	14♃45r	07Ⅱ13	26♁56	15☉31					
266.	12♁09	21×40	00♁00	21♁36	27♁12	09♁21	12♃37r	07Ⅱ11r	28♁16	17☉20					
267.	09♁06	09±06	24☉03	17♁41	25♁07	09♁05	12♃41r	07Ⅱ14r	28♁10	17☉15					

Tornado & Hurricane Chart House Cusps

No	X	XI	XII	I	II	III
244.	II23	III27	IV28	24V09	VI20	VII19
245.	VI22	VIII17	IX08	27X48	XX06	XI17
246.	VIII17	IX09	IX29	21V32	X07	VI18
247.	XX10	X09	VI17	01II02	II26	III17
248.	XX20	X21	III01	12II20	III05	III26
249.	VI08	III14	II20	22III42	IV13	V08
250.	III22	IV24	V24	21VI28	VII20	IX21
251.	X14	VI18	III24	27II47	III21	IV16
252.	XX13	X13	VI19	27III04	II23	III17
253.	IV29	VI01	VI28	19VII53	IX20	V324
254.	VIII10	IX04	IX26	18V33	XX29	IV09
255.	X08	VI12	III22	29II01	III20	IV12
256.	IV07	V010	VI09	05VII31	IX04	V05
257.	XX24	X25	III03	09II09	III04	III28
258.	XX19	X20	VI27	04II25	II29	III23
259.	IX18	V12	XX09	12X20	VI21	III23
260.	VIII01	VIII28	IX22	15V350	XX22	X29
261.	X08	VI11	III18	22II25	III16	IV10
262.	III12	IV12	V13	12VI32	VIII12	IX12
263.	VI01	VII02	VII29	23X52	V324	XX27
264.	V06	XX02	X02	07VI49	III12	II11
265.	II11	III13	IV14	12VII29	VI09	VIII10
266.	V018	VI19	VII15	07X17	V08	XX13
267.	III10	IV12	V13	09VI40	VII08	IX09

Tornado Chart Planets

	☉	☽	☿	♀	♂	♃	♄	♅	♁	♂	♆	♁	♃	♄	♅
220.	00°00'	28°18'	04°10'	21°X56	03°11P58r	16°11P48r	13°X10	23°00'	08°11P15r	21°19'17					
221.	27°08'	01°X57	00°00'	26°00'	01°11P02	14°11P05r	15°X08	23°00'	07°11P39r	21°19'18					
222.	04°02'	04°02'	07°13'	04°050	01°11P47	13°11P41r	15°X32	23°00'	07°11P33	21°19'23					
223.	00°00'	20°048	11°19'36r	27°116	26°00'36	03°02'23	14°X45r	07°00'	26°056	16°06'06					
224.	12°11P49	26°012	00°00'	00°053	16°11P32	10°02'22r	12°X49	06°00'18r	29°02'27	17°05'58					
225.	20°11P58	20°11P58	13°013	11°043	21°1115	10°00'06r	13°X08	05°00'59r	29°04'45	18°06'06					
226.	00°00'	23°11P33	15°18'20	29°1149	15°18'42	25°00'26	29°00'11r	17°00'07	04°02'1r	04°02'26r					
227.	25°X52	26°11P31	00°00'	08°X17	28°X52	00°02'24	24°05'8r	20°X05	02°05'3r	02°05'30r					
228.	17°X46	17°11P46	00°X26	05°X27	16°X03	04°02'22	23°05'6r	21°X16	02°02'25r	02°02'20					
229.	00°00'	08°049	25°037	03°003	22°011	22°X36r	15°02'1	12°X04r	02°02'11	03°02'14					
230.	26°034	03°049	00°00'	06°11P38	07°02	19°X38r	16°02'5	11°X45r	02°02'36	03°02'09r					
231.	13°11P50	13°11P50	25°02	28°11P14	15°02'24	18°X42r	16°02'6r	11°X51	02°02'40r	03°02'03r					
232.	00°00'	06°030	07°X17	06°030	04°00	10°050	00°18'13	08°00'56	29°02'12r	16°02'15r					
233.	13°037	01°X02	00°00'	07°034r	10°03	13°048	00°18'29	07°00'42	28°05'6r	16°02'13					
234.	19°030	19°030	11°014	05°043r	12°052	15°08	00°18'31r	08°00'03	28°05'0r	16°02'13					
235.	00°00'	15°X02	14°030	21°X19	28°08	18°18'47	13°11P41r	21°X58	20°02'13r	11°02'24					
236.	11°022	14°035	00°00'	05°035	05°11P32	20°18'14	13°11P07r	22°X36	20°02'01r	11°02'28					
237.	11°04	11°04	29°047	05°014	05°11P21	20°18'12	13°11P08	22°X36	20°02'01r	11°02'27					
238.	00°00'	09°11P16	16°018	10°11P09r	08°046	28°X18r	02°X55	01°02'29r	27°05'6	17°02'01					
239.	20°11P15	25°054	00°00'	14°11P59r	02°015	29°X38r	02°X15	01°02'52r	27°03'7	16°02'51					
240.	01°050	01°050	19°009	09°11P38	10°00	28°X02r	03°X03	01°02'5r	18°02'00	16°02'54					
241.	00°00'	28°18	04°010r	21°X56	03°11P58r	16°11P50r	12°X59	22°00'03	18°11P14	21°02'19r					
242.	27°09	02°X57	00°00'	01°05	01°11P02	14°11P05r	15°X08	23°00'34	07°11P39r	21°02'18					
243.	04°07	04°07	07°017	04°053	01°11P47	13°11P41r	15°X33	23°00'58	37°11P33r	21°02'23					

Tornado Chart House Cusps

	No	X	XI	XII	I	II	III
220.	☉21	♋24	♏24	19♌48	♍18	♎19	
221.	♁12	♈16	♏24	29♈42	☉22	♋14	
222.	♏14	♈18	☉20	00♋11	♏13	♌11	
223.	♈04	☉09	♋11	00♏23	♌02	♍01	
224.	♋18	♏20	♌17	09♍07	♎08	♏11	
225.	♏13	♎06	♁07	24♈38	♏29	♈22	
226.	♈07	☉12	♋13	10♏51	♌05	♍04	
227.	☉15	♋18	♏18	12♌30	♍09	♎11	
228.	♏23	♈28	♋01	29♋28	♏22	♌20	
229.	♎12	♁10	♈19	03♈23	♈27	☉19	
230.	♎04	♁02	♈09	24♏56	♈20	☉12	
231.	♈06	☉10	♋11	09♏27	♌04	♍04	
232.	♋03	♏06	♌05	28♌46	♍27	♎29	
233.	♈01	☉05	♋06	04♏18	♏29	♌28	
234.	♏26	☉30	☉02	00♏14	♏24	♌23	
235.	♋24	♏26	♌25	19♍50	♎19	♏21	
236.	♁07	♈10	♏17	21♈17	☉15	♋09	
237.	♍24	♎19	♏13	10♎52	♁20	♈25	
238.	♏19	♎14	♁17	03♏20	♈05	♈28	
239.	♏14	♎07	♁08	23♈48	♏28	♈22	
240.	♎08	♎30	♏22	22♎22	♈09	♏13	
241.	☉19	♋21	♏21	17♌32	♍16	♎17	
242.	♁09	♈13	♏22	26♈54	☉19	♋12	
243.	♏11	♈15	☉18	16♋46	♏11	♌09	

Chapter 7

Tornadoes And Hurricanes



hen all three weather charts show unusual violence at the place for which they are erected, and especially if at the time erected there is a progressed aspect to the Ascendant, we may be sure that storms or other destructive weather will occur in the region covered by the charts.

If the chief destruction is through extreme temperature, we look chiefly to the aspects made to the Ascendant of the Temperature Chart to show the day the event will take place. If the chief destructive force indicated is rain, hail, snow or flood, we look chiefly to the aspects made to the Ascendant of the Moisture Chart to indicate the day the destruction will take place. But if the destruction is to be caused by wind, we look most to the aspects made to the Ascendant of the Air Movement Chart to indicate the days of the storm. However, almost always there is a progressed aspect to the Ascendant of all three weather charts at the time of a destructive storm.

In lesson No. 195 we considered most of the other kinds of unusual weather, leaving the consideration of the most destructive types of storms, tornadoes and hurricanes, to be taken up in this lesson. Here, therefore, I shall present a brief analysis of ten tornadoes and six hurricanes. Each and every one, picked at random, show exceptional elements of violence and wind.

That we may have a clear and definite idea of what a hurricane is, and how it is distinguished from a tornado, I will quote from *The Realm of the Air*, by Charles Fitzhugh Talman:

“The name ‘West India Hurricane’ is applied to the violent whirling storms of cyclones that occur in the region of the West Indies and the adjacent waters to the west and east, namely the Gulf of Mexico, the Caribbean Sea and a tract of the Atlantic Ocean extending eastward nearly to the African coast. Storms having essentially the same characteristics occur in other tropical oceanic areas. In the Far East they are called ‘Typhoons’ or in the Philippines sometimes ‘Baguois.’ In the Indian Ocean they are known as ‘Cyclones,’ while the name ‘Hurricane’ prevails in the South Pacific.

“‘Tropical cyclone’ is a name that embraces all of them, but also applies to numerous mild disturbances of the tropical atmosphere that do not rank as tempests.

“The winds in these Storms blow around a center of low barometer with a velocity that often exceeds one-hundred miles an hour. The storm as a whole travels at a very moderate speed—say ten to fifteen miles an hour—and may even remain almost stationary for awhile. Hence it is the rotary and not the progressive movement of the storm that causes havoc.

“It may help the reader to crystallize his ideas concerning tropical cyclones if he bears in mind that these whirls of low latitudes are intermediate in size between two other types of revolving storms, namely, the huge ‘extra tropical’ cyclone of the temperate and polar zones, and the small tornadoes that are confined chiefly to continental interiors of the north temperate zone. The extra tropical cyclone has an average diameter of about fifteen-hundred miles, while a large specimen may, for example, cover the entire north half of the North Atlantic Ocean. The diameter of a tropical cyclone (hurricane) is sometimes less than fifty miles and seldom as great as three-hundred miles. The tornado is a mere dot on the map—from a few rods to half a mile or so in diameter.

“For concentrated fury and destructiveness no other wind on earth—except, perhaps, the blast in front of a great avalanche or landslide—rivals the tornado.

“A tropical hurricane is a vast whirlwind that sweeps for days together on sea and land and is capable of doing a greater aggregate of damage than the tornado on account of the much larger area embraced in its path. It leaves ruin in its wake, yet stout buildings withstand its assaults and well-found ships plow safely through it.

“The entire life history of the tornado is usually compassed within less than half an hour and the path of destruction is seldom more than a quarter of a mile wide and some score of miles long. At any one place along the path the whole thing is over in a minute. Within these narrow limits of space and time it does its deadly work with a thoroughness only rivaled by the deviltries of modern warfare.

“The tornado is borne along as a local episode in a wide-spread belt of squalls and thundershowers.”

Usually the first warning of a tornado is when someone sights the black funnel a few miles away on the horizon. But, not infrequently, the knowledge that a hurricane is approaching is known a day or two before its arrival, and people board up their windows, and perhaps go by train loads to higher ground where danger of the water of the sea piling in on them is less great.

A waterspout is merely a tornado-like funnel which, passing over water, sucks the water up. Waterspouts usually are much smaller than the larger tornadoes, and usually are much less destructive.

When the heavy planets in the sky make squares and oppositions we may be sure of destructive weather conditions on the earth. And when the planets forming these heavy discords in the localities where the weather charts are erected, if the localities are in a tornado region and it is the time of year when tornadoes are more common, we may expect tornadoes. But when the same afflictions occur in those regions

where tornadoes are rare, but where the destructive storms are hurricanes, we may expect hurricanes. And the same charts in the Great Basin region, where tornadoes and hurricanes do not occur, indicate cloudbursts, sandstorms, and destructive lightning.

The general principle to follow in judging such storms is that the more violent and destructive the inner-plane weather, as shown by the three weather charts, the more violent and destructive will be the storms on earth.

As tornadoes are more local affairs, and the most vicious of all storms in the limited area where they do strike, let us briefly analyze some typical cases; and then close with those larger storms, which due to their size, in the aggregate often create more havoc than any others. These are hurricanes.

Tornado, April 29-30, 1933

—A tornado on the indicated date struck near midnight in both Arkansas and Mississippi, sweeping a wide path of destruction. Six were killed and 50 injured, with a property damage of half a million dollars. The heaviest damage was reported at Yazoo City, Miss., for which the three following weather charts were erected.

Temperature Chart No. 220, the planets of which are given in lesson No. 195, and the houses of which are given on page 114, has stormy Saturn and the wet Moon in the fourth house, the Moon being opposition violent Pluto and square violent Uranus. Stormy Capricorn is on the cusp of the fourth, and its ruler, Saturn, is in violent Aquarius. This accounts for $\frac{1}{2}$ of the influence of the chart.

Windy Libra is on the cusp of the first, and Venus, its ruler, is in mild but wet Pisces. This accounts for $\frac{1}{4}$ of the influence of the chart.

Mars, ruling the sign occupied by the Sun, is in windy Virgo. This accounts for $\frac{1}{8}$ of the influence of the chart.

The calm Moon, windy and violent Uranus, and stormy Saturn are in angles. This accounts for $\frac{1}{8}$ of the influence of the chart.

Air Movement Chart No. 221, the planets of which are given in lesson No. 195, and the houses of which are given on page 114, has pleasant Jupiter in the fourth house. Windy Virgo is on the cusp of the fourth, and its ruler, Mercury, is in violent Aries. This accounts for $\frac{1}{2}$ of the influence of the chart.

Violent Pluto is in the first house, square both Sun and Uranus. Windy Gemini is on the cusp of the first, and its ruler, Mercury, is in violent Aries. This accounts for $\frac{1}{4}$ of the influence of the chart.

Mars, ruling the sign occupied by Mercury, is in windy Virgo. This accounts for $\frac{1}{8}$ of the influence of the chart.

Of the planets in angles, Jupiter is mild, but Pluto is violent. This accounts for $\frac{1}{8}$ of the influence of the chart.

Moisture Chart No. 222, the planets of which are given in lesson No. 195, and the houses of which are given on page 114, has the violent sign Scorpio on the cusp of the fourth, and one of its rulers, Mars, in windy Virgo, and the other of its rulers, Pluto, in mild Cancer. Pluto, however, is closely square violent Uranus. This accounts for $\frac{1}{2}$ of the influence of the chart.

Violent Mars and Neptune are in the first house. Calm Leo is on the cusp of the first, and its ruler, the Sun, is in wet Taurus. This accounts for $\frac{1}{4}$ of the influence of the chart.

Venus, ruling the sign occupied by the Moon, is in mild Taurus. This accounts for $\frac{1}{8}$ of the influence of the chart.

Both planets in angles, Mars and Neptune, are violent. This accounts for $\frac{1}{8}$ of the influence of the chart.

At the time of the tornado, progressed Jupiter was parallel the Asc. of the Temperature Chart, progressed Pluto was parallel the Asc. of the Air Movement Chart, and the Moon on the day of the tornado had made the conjunction of the Asc. of the Air Movement chart. All during the period covered by the Air Movement chart, up to a day and half before the tornado, Saturn, the storm planet had been within the one degree of effective orb of progressed sesqui-square the Asc. This added to the charts violence.

Tornado, September 14, 1928

—On this date there was a tornado at Rockford, Ill., at about 3:20 p.m. The tornado path was from 200 to 500 feet wide, and had a length of 25 miles. There were 14 deaths, about 100 injured, and property damage in Rockford alone was \$1,200,000.

Temperature Chart No. 223, the planets of which are given in lesson No. 195, and the houses of which are given on page 114, has the storm planet Saturn in the fourth. Breezy Sagittarius is on the cusp of the fourth, and its ruler, Jupiter, is in mild Taurus. This accounts for $\frac{1}{2}$ of the influence of the chart.

Windy Virgo is on the cusp of the first, and its ruler, Mercury, is in calm Cancer, but is conjunction violent Pluto, semi-square violent Neptune, and square windy and violent Uranus. This accounts for $\frac{1}{4}$ of the influence of the chart.

The Moon, ruling the sign occupied by the Sun, is in Leo conjunction violent Neptune. This accounts for $\frac{1}{8}$ of the influence of the chart.

Of the planets in angles, the Sun is calm but Saturn is stormy. This accounts for $\frac{1}{8}$ of the influence of the chart.

Air Movement Chart No. 224, the planets of which are given in lesson No. 195, and the houses of which are given on page 114, has violent Aquarius on the cusp of the fourth, and its ruler, Uranus, in violent Aries. This accounts for $\frac{1}{2}$ of the influence of the chart.

Violent Scorpio is on the cusp of the first, and one of its rulers, Mars, is in windy Gemini, and the other ruler, Pluto, is in calm Cancer. This accounts for $\frac{1}{4}$ of the influence of the chart.

Venus, ruling the sign occupied by Mercury, is in windy Libra. This accounts for $\frac{1}{8}$ of the influence of the chart.

Of the planets in angles, the Sun is quiet and the Moon is quiet, Jupiter is pleasant, but Neptune is violent. This accounts for $\frac{1}{8}$ of the influence of the chart, except that Jupiter is in progressed opposition the Asc. and thus stirring up discord.

Moisture Chart No. 225, the planets of which are given in lesson No. 195, and the houses of which are given on page 114, has violent Pluto in the fourth house. Wet Cancer is on the cusp of the fourth, and its ruler, the Moon, is in windy Virgo making a progressed square to Mars. This accounts for $\frac{1}{2}$ of the influence of the chart.

Pleasant Jupiter is in the first house, but violent Aries is on the cusp of the first and Mars, its ruler, in windy Gemini makes a progressed square with the Moon. This accounts for $\frac{1}{4}$ of the influence of the chart.

Mercury, ruling the sign occupied by the Moon, is in windy Libra. This accounts for $\frac{1}{8}$ of the influence of the chart.

Of the planets in angles Jupiter is mild but Pluto is violent. This accounts for $\frac{1}{8}$ of the influence of the chart.

September 14, 1928, when the tornado struck, progressed Neptune was conjunction the Asc. of the Temperature Chart, progressed Jupiter was opposition the Asc. of the Air Movement Chart, and the progressed Moon was inconjunct the Asc. of the Moisture Chart.

Tornado, March 11, 1917

—This is the date on which there occurred the first well defined tornado in Cincinnati, Ohio, of which there is a record. Three people were killed, 32 injured, and 90 houses partly wrecked, with a damage of \$250,000.

Temperature Chart No. 226, the planets of which are given in lesson No. 195, and the houses of which are given on page 114, has the Sun in the fourth house opposition violent Pluto. Sagittarius is on the cusp of the fourth, and its ruler, Jupiter, is in violent Aries. This accounts for $\frac{1}{2}$ of the influence of the chart.

Windy Virgo is on the cusp of the first, and its ruler, Mercury, is in stormy Capricorn in progressed conjunctions with violent Mars. This accounts for $\frac{1}{4}$ of the influence of the chart.

Saturn, ruling the sign occupied by the Sun, is in mild Cancer, but conjunction violent Neptune. This accounts for $\frac{1}{8}$ of the influence of the chart.

Of the planets in angles, the Sun is calm and Pluto is violent. This accounts for 1/8 of the influence of the chart.

Air Movement Chart No. 227, the planets of which are given in lesson No. 195, and the houses of which are given on page 114, has windy Mercury and mild Venus in the fourth house. Stormy Capricorn is on the cusp of the fourth, and its ruler, Saturn, is in mild Cancer. This accounts for 1/2 of the influence of the chart.

Windy Libra is on the cusp of the first, and its ruler, Venus, is conjunction windy Mercury in violent Aquarius. This accounts for 1/4 of the influence of the chart.

Uranus, ruler of the sign occupied by Mercury, is conjunction the Sun in violent Aquarius. This accounts for 1/8 of the influence of the chart.

Of the planets in angles, Venus and Jupiter are mild, Saturn is stormy, Mercury is windy, and Neptune is violent. This accounts for 1/8 of the influence of the chart.

Moisture Chart No. 228, the planets of which are given in lesson No. 195, and the houses of which are given on page 114, has violent Scorpio on the cusp of the fourth with one of its rulers, Mars, in wet Pisces, and the other of its rulers, Pluto, in wet Cancer in progressed semi-sextile with violent Neptune. This accounts for 1/2 of the influence of the chart.

Wet Moon in the first house is in close opposition to violent Mars. Calm Leo is on the cusp of the first, and its ruler, the Sun, is in wet Pisces in close conjunction with violent Mars. This accounts for 1/4 of the influence of the chart.

March 11, 1917, when the tornado struck, progressed Moon was semi-square the Asc. of the Temperature Chart, progressed violent Mars was parallel the Asc. of the Air Movement chart, and progressed windy Mercury was parallel the Asc. of the Moisture chart.

Tornado, November 10, 1915

—This is the date when a tornado struck Great Bend, Kansas at 7:07 p.m., killing 11 persons and destroying \$1,000,000 worth of property.

Temperature Chart No. 229, the planets of which are given in lesson No. 195, and the houses of which are given on page 114, has calm Leo on the cusp of the fourth, with its ruler, the Sun, conjunction Venus, and both sextile Neptune and square Pluto.

Windy Gemini is on the Asc., and progressed Venus is trine the Asc., progressed Pluto is semi-square the Asc., and progressed Venus is square Pluto. This is a violent combination.

Air Movement Chart No. 230, the planets of which are given in lesson No. 195, and the houses of which are given on page 114, has violent Mars in the fourth opposition violent Uranus.

Mild Taurus is on the cusp of the first, but its ruler, Venus, in violent Scorpio, is in progressed square with violent Mars.

The only two planets in angles are Mars and Uranus, both violent. This is an extremely violent chart.

Moisture Chart No. 231, the planets of which are given in lesson No. 195, and the houses of which are given on page 114, has Sagittarius on the cusp of the fourth, and Jupiter in an angle, indicating some fine weather during the 7 days it rules. The cusp of the first, however, is windy Virgo, and its ruler, Mercury, in windy Libra, is in progressed semi-square to the Asc. This indicates plenty of wind.

At the time of the tornado on Nov. 10, progressed Neptune was sextile the Asc. of the Temperature Chart, progressed Neptune was parallel the Asc. of the Air Movement chart, and progressed Mercury was parallel the Asc. of the Moisture Chart.

Tornado Day, April 10, 1929

—It is called tornado day in Arkansas because on that date there were eight tornadoes in the northeast part of that state during the afternoon and early part of the night. The first storm hit three miles west of Calico Rock, about 3:00 p.m. The last storm, about 8:30 p.m., made a path from Calico Rock eastward 100 miles. 56 persons met death, 213 were injured, and property damage was reported as \$795,000.

Temperature Chart No. 232, the planets of which are given in lesson No. 195, and the houses of which are given on page 114, shows violent Aquarius on the fourth, and its ruler, Uranus, conjunction Sun, in progressed conjunction with Venus, and both in progressed trine with the Moon. This shows much action from windy and violent Uranus.

Air Movement Chart No. 233, the planets of which are given in lesson No. 195, and the houses of which are given on page 114, shows the storm planet Saturn in the fourth house in progressed square with windy Mercury. This indicates storm in no uncertain terms.

Moisture Chart No. 234, the planets of which are given in lesson No. 195, and the houses of which are given on page 114, has violent Scorpio on the cusp of the fourth, and Mars, one ruler, in wet Cancer in conjunction with the other ruler, violent Pluto, and square windy Mercury and windy and violent Uranus.

Windy Virgo is on the cusp of the first, and its ruler, Mercury, is conjunction violent Uranus, while stormy Saturn makes a progressed trine to the Asc. This also indicates storm in no uncertain terms.

On April 10, when the storms struck, progressed Neptune was sextile the Asc. of the Temperature Chart, progressed Sun was sesqui-square the Asc. of the Air Movement Chart, and both progressed Moon and progressed Neptune were parallel the Asc. of the Moisture Chart.

Tornado, April 5, 1925.

—On this date there was a tornado and hail storm near Miami, Florida, in which 5 persons died, 35 were injured, and property damage reached \$200,000. Preceding the tornado the ground was covered with hail.

Temperature Chart No. 235, the planets of which are given in lesson No. 195, and the houses of which are given on page 114, shows the wet planet Venus in progressed conjunction with eccentric Uranus in the fourth house. Violent Aquarius is on the cusp of the fourth.

Violent Scorpio is on the cusp of the first, and one of its rulers, Mars, is in the seventh house semi-square the other ruler, Pluto, and semi-square windy Mercury.

Air Movement Chart No. 236, the planets for which are given in lesson No. 195, and the houses for which are given on page 114, has windy Virgo on the cusp of the fourth and windy Gemini on the cusp of the first. The Moon is conjunction violent Pluto in the first, and Uranus in an angle is closely square the Asc. Much wind is indicated.

Moisture Chart No. 237, the planets for which are given in lesson No. 195, and the houses for which are given on page 114, has violent Mars in the fourth house and violent Aquarius on the cusp of the first. The most significant thing about this chart is the progressed inconjunct of Moon and sextile of Sun to the Asc., and the progressed in-conjunct of Pluto to the Asc., connecting the degree on the Asc. with the violent progressed square of Sun to Pluto and conjunction of Moon with Pluto.

April 5, when the tornado struck, progressed Neptune was square the Asc. and progressed Jupiter was sextile the Asc. of the Temperature chart, progressed Jupiter was semi-sextile the Asc. of the Air Movement chart, and progressed Pluto was inconjunct the Asc. of the Moisture chart.

Tornado, September 29, 1927

—On this date there was a severe tornado at and near St. Louis, Mo., in which 79 lives were lost, and property damage was \$25,000,000.

Temperature Chart No. 238, the planets for which are given in lesson No. 195, and the houses for which are given on page 114, has stormy Capricorn on the cusp of the fourth, and its ruler, Saturn, in an angle. Somewhere during the season there would be violence, due to the T-square made by Mars to the close opposition of Sun and Uranus, and as stormy Saturn aspects Sun and Uranus closely, and connect them up with the Asc. by making a progressed inconjunct to it, it was likely to be this region.

Air Movement Chart No. 239, the planets for which are given in lesson 195, and the houses for which are given on page 114, has violent Pluto in the fourth and stormy Capricorn on the cusp of the fourth, with Saturn, its ruler, in progressed sextile to Mars and in progressed trine to Uranus, Mars and Uranus being in progressed

opposition. Mercury, the wind planet, is closely conjunction Mars and closely opposition Uranus. Violent Aries is on the Asc., and Mars, its ruler, involved in the indicated aspects. This is a very violent chart.

Moisture Chart No. 240, the planets for which are given in lesson No. 195, and the houses for which are given on page 114, has windy Gemini on the cusp of the fourth, and violent Aquarius on the cusp of the first, with its ruler, violent Uranus, making the progressed opposition to Sun and Moon. This also is a very violent chart.

September 29, when the tornado struck, progressed Saturn was inconjunct the Asc. in the Temperature chart, progressed Mercury was opposition the Asc. of the Air Movement Chart, and progressed Moon was both parallel and square the Asc. of the Moisture Chart.

Tornado, May 1, 1933

—On this date a tornado struck Mindon, Louisiana, 68 were killed, 55 of them in Mindon, and 50 were injured.

Temperature Chart No. 241, the planets for which are given in lesson No. 195, and the houses for which are given on page 114, has stormy Saturn in the fourth, and stormy Capricorn on the cusp of the fourth. Wet Moon is also in the fourth in opposition to violent Pluto in the tenth, and Pluto makes the progressed square with violent Uranus in the seventh. This is a destructive combination.

Air Movement Chart No. 242, the planets for which are given in lesson No. 195, and the houses of which are given on page 114, shows pleasant

Jupiter in the fourth, but windy Virgo on the cusp of the fourth. Windy Gemini is on the cusp of the first, and its ruler, Mercury, is in an angle. The ominous thing about the chart, however, is Sun conjunction Uranus, and both square Pluto, and this violent aspect connected with the Asc. by progressed Sun sextile Asc.

Moisture Chart No. 243, the planets for which are given in lesson No. 195, and the houses of which are given on page 114, shows violent Scorpio on the cusp of the fourth, and one of its rulers, Mars, conjunction violent Neptune, and the other ruler, Pluto, closely square Uranus. This Mars conjunction Neptune occurs in the first house.

At the time the tornado struck, on May 1, progressed Mars was semi-square the Asc. in the Temperature Chart, progressed Pluto was parallel the Asc. of the Air Movement Chart, and progressed Mercury was trine the Asc. of the Moisture Chart.

Tornado, June 28, 1924

—On this date, at Lorain, Ohio, there occurred a tornado which cost the lives of nearly 100 people, and created property damage of about \$12,000,000.

Temperature Chart No. 244, the elements of which are given on pages 112-113, shows breezy Sagittarius on the cusp of the fourth, and its ruler, Jupiter, closely opposition windy Mercury, and in progressed semi-square with violent Mars. Windy Virgo is on the cusp of the first, and its ruler, Mercury, as indicated, closely opposition Jupiter. But the most ominous thing about the chart is progressed stormy Saturn semi-sextile the Asc.

Air Movement Chart No. 245, the elements of which are given on pages 112-113, has violent Aries on the cusp of the fourth, and its ruler, Mars, in progressed conjunction with stormy Saturn. Sagittarius is on the cusp of the first, but stormy Capricorn is intercepted in the first, and its ruler, Saturn, is in progressed conjunction with violent Mars. Progressed Sun is also square violent and windy Uranus.

Moisture Chart No. 246, the elements of which are given on pages 112-113, has Taurus on the cusp of the fourth, with its ruler, Venus, in close conjunction with violent Pluto, and making the progressed inconjunct with Jupiter. Stormy Capricorn is on the cusp of the first, but the most ominous thing about the chart is progressed Uranus sextile the Asc.

At the time the tornado struck, June 28, progressed Moon was trine the Asc. of the Temperature Chart, progressed Mercury was opposition the Asc. of the Air Movement Chart, and progressed Uranus was sextile the Asc. of the Moisture Chart.

Tornado, May 6, 1927

—The tornado on this date demolished the town of Poplar Bluffs, Mo., killing 80, injuring 300, and doing property damage amounting to \$2,100,000.

Temperature Chart No. 247, the elements of which are given on pages 112-113, shows violent Neptune in the fourth house. Violent Mars is in the first house making progressed square to windy Mercury and Jupiter. Windy Gemini is on the cusp of the first, and its ruler, Mercury, is in progressed conjunction with Jupiter and progressed square with Mars. Mars, ruling the sign occupied by the Sun, is in windy Gemini, making the progressed aspects indicated, and also progressed square with violent Pluto. This is, therefore, a very violent chart.

Air Movement Chart No. 248, the elements of which are given on pages 112-113, also has Neptune, planet of peculiar weather, in the fourth, and Neptune is making the progressed sextile to Venus and the progressed inconjunct to Jupiter. Windy Gemini is on the cusp of the first. The ruler of the sign occupied by Mercury, Venus, is in windy Gemini in the first house. This is a mild position, but there is an ominous position, progressed Mars semi-sextile the Asc.

Moisture Chart No. 249, the elements of which are given on pages 112-113, has windy Libra on the cusp of the fourth, and its ruler, Venus, in windy Gemini in progressed square to Jupiter. Wet Cancer is on the cusp of the first, and its ruler, the Moon, is in Leo, conjunction peculiar Neptune. Only windy Mercury is in an angle.

At the time the tornado struck, May 6, progressed Uranus was sextile the Asc. of the Temperature Chart, progressed Mars was semi-sextile the Asc. of the Air Movement Chart, and progressed Venus was semi-sextile the Asc. of the Moisture Chart.

These ten destructive tornadoes, picked at random, all show great violence in all three weather charts. And, as is practically always the case, at the time of the destructive storm, there was, with the exception of one chart, a progressed aspect within the one effective degree of perfect to the Ascendant of each of the three weather charts. I believe, therefore, they show in sufficient detail to form a solid foundation for further research on the part of the student, the inner-plane conditions which precede, and which are present at the time of tornadoes. Therefore, to complete these studies, let us make a similar brief analysis of those less common, but sometimes even more destructive storms known as hurricanes.

Tropical Hurricane, September 28-30, 1929

—This hurricane in southern and western Florida did damage to the extent of \$678,000 to fruit, trucks, highways, telephones, small boats, buildings, power plants, etc.

Temperature Chart No. 250, the elements of which are given on pages 112-113, shows stormy Capricorn on the cusp of the fourth, and its ruler, Saturn, in Sagittarius, opposition Jupiter. Windy Libra is on the cusp of the first, and windy Mercury is in the first house, closely conjunction Mars and the Asc. The really ominous thing about the chart is violent Mars in progressed aspect with the Ascendant. Mars and Mercury are in close square with violent Pluto.

Air Movement Chart No. 251, the elements of which are given on pages 112-113, shows windy Mercury conjunction violent Mars in the fourth house, with Mars square the Moon. Windy Virgo is on the cusp of the fourth, and its ruler, Mercury, is in violent Aries. Violent Pluto is in the first house. Windy Gemini is on the cusp of the first house, and as indicated, its ruler, Mercury, is heavily afflicted. Furthermore, tending to release the indicated violence in the area for which the chart was erected, progressed Venus is semi-sextile the Asc.

Moisture Chart No. 252, the elements of which are given on pages 112-113, shows peculiar Neptune conjunction Venus in the fourth house and making the progressed sextile to Moon and progressed semi-sextile to Sun. The Sun is opposition Uranus, and the Moon makes a T-square with this opposition. Thus this chart also shows violence.

At the time of the hurricane, September 28-30, progressed Mercury was conjunction the Asc. of the Temperature Chart, progressed Moon was parallel the Asc. of the Air Movement Chart, and progressed Moon was square the Asc. of the Moisture Chart.

Hurricane, August 24, 1933

This hurricane with most destruction at Norfolk, Va., brought the highest tide on—record, with water pouring through the streets of the city, and a property damage of millions.

Temperature Chart No. 253, the elements of which are given on pages 112-113, shows the violent sign Aquarius on the cusp of the fourth, and its ruler, Uranus, in violent Aries square both violent Pluto and the wind planet Mercury. Violent Scorpio is on the cusp of the first, and one of its rulers, Mars, is in windy Virgo, and the other ruler, Pluto, is conjunction windy Mercury, and in progressed sextile with violent Mars.

Air Movement Chart No. 254, the elements of which are given on pages 112-113, has Taurus on the cusp of the fourth, and its ruler, Venus, in an angle in progressed conjunction with violent Pluto. Both are square violent and windy Uranus. Stormy Capricorn is on the cusp of the first, and its ruler, stormy Saturn, is in the first house in violent Aquarius opposition to the Moon. In addition to Venus, Moon, Saturn and Pluto, windy Mercury also is in an angle. This is a storm chart.

Moisture Chart No. 255, the elements of which are given on pages 112-113, has wet Venus and peculiar Neptune in the fourth house. Windy Virgo is on the cusp of the fourth, and its ruler, Mercury, is in opposition to stormy Saturn, and in progressed inconjunct with peculiar Neptune. Windy Gemini is on the cusp of the first, and its ruler, Mercury, has the violent aspects already indicated. But the most significant thing about the chart is the progressed square of Venus to the Asc.

On the day of the hurricane, Aug. 24, progressed Saturn was parallel the Asc. of the Temperature Chart, progressed Pluto was parallel the Asc. of the Air Movement Chart, and progressed Mercury was square the Asc. of the Moisture Chart.

Hurricane, September 5, 1933

—On this date a hurricane swept southeast Texas, and at Harlingen, Texas, 53 were killed, thousands were hurt and the town was shattered and ruined. Other towns also were flooded, and the property loss ran into millions.

Temperature Chart No. 256, erected for Harlingen, the elements of which are given on pages 112-113, has the storm planet Saturn in the fourth house. Violent Aquarius is on the cusp of the fourth, and its ruler, Uranus, is in violent Aries square violent Pluto and windy Mercury. Mercury, the wind planet, is in progressed conjunction with violent Pluto. Violent Scorpio is on the cusp of the first, and one of its rulers, Mars, is in progressed sextile with windy Mercury from the windy sign Virgo, and also in progressed sextile with the other ruler, Pluto. This is an ominous combination, although it needs a progressed aspect to the Asc. to release it.

Air Movement Chart No. 257, erected for Harlingen, the elements of which are given on pages 112-113, has Sun, windy Mercury, and peculiar Neptune in the fourth house, progressed Sun being conjunction Neptune. As Leo is on the cusp of the fourth, and the Sun is its ruler, this is a significant aspect. But the really ominous thing about the chart is that progressed Sun and Neptune are also square the Asc. This makes the chart indicate very dangerous weather.

Moisture Chart No. 258, erected for Harlingen, the elements of which are given on pages 112-113, also has Sun conjunction peculiar Neptune in the fourth house, Leo again on the cusp of the fourth, and both its ruler, Sun, and Neptune, opposition the Moon. Windy Gemini is on the cusp of the first house, and its ruler, Mercury, is in the windy sign, Virgo. Neptune, the ruler of the sign occupied by the Moon, is in windy Virgo conjunction windy Mercury, conjunction Sun and opposition Moon.

On Sept. 5, the day of the hurricane, progressed Mars was conjunction the Asc. of the Temperature Chart, progressed Neptune was square the Asc. of the Air Movement Chart, and progressed Mercury was square the Asc. of the Moisture Chart.

Hurricane, September 18, 1926

—This hurricane arrived at Miami, Florida, at 3:00 a.m., on this date causing great damage.

Temperature Chart No. 259, the elements of which are given on pages 112-113, has the Sun in the fourth house conjunction Pluto and square violent Mars. Windy Gemini is on the cusp of the fourth, and its ruler, Mercury, is in Cancer conjunction violent Pluto. This accounts for $\frac{1}{2}$ of the influence of the chart.

Violent Mars is in the first house conjunction windy and violent Uranus and square the Sun. Pisces is on the cusp of the first, and its ruler, Neptune, is in Leo in progressed square with Venus. This accounts for $\frac{1}{4}$ of the influence of the chart.

The Moon, ruling the sign occupied by the Sun, is in violent Scorpio conjunction stormy Saturn. This accounts for $\frac{1}{8}$ of the influence of the chart.

Of the planets in angles, Sun is calm, but Mars and Uranus are violent. This accounts for $\frac{1}{8}$ of the influence of the chart. However, the Moon in progressed trine with the Asc. helps release the energy of the chart.

Air Movement Chart No. 260, the elements of which are given on pages 112-113, has violent Mars in the fourth house. Taurus is on the cusp of the fourth, and its ruler, Venus, is in Leo closely opposition Jupiter and closely square Saturn. This accounts for $\frac{1}{2}$ of the influence of the chart.

Jupiter is in the first house square Saturn and opposition Venus. Stormy Capricorn is on the cusp of the first, and its ruler, Saturn is square Venus, opposition Mars, and square Jupiter. This accounts for $\frac{1}{4}$ of the influence of the chart.

Mercury, ruling the sign occupied by Mercury, is in windy Virgo making the progressed semi-square to violent Pluto. This accounts for 1/8 of the influence of the chart.

Of the planets in angles, Jupiter is mild, Saturn is stormy, and Mars is violent. This accounts for 1/8 of the influence of the chart.

The most ominous thing about the chart, however, is progressed Pluto opposition the Asc.

Moisture Chart No. 161, the elements of which are given on pages 112-113, has Sun in the fourth house in progressed sextile with stormy Saturn. Windy Virgo is on the cusp of the fourth, and its ruler, Mercury, is in windy Virgo conjunction the Sun and in the fourth. This accounts for 1/2 of the influence of the chart.

The ominous thing about the chart is that progressed Sun is square the Asc., and progressed Mars is inconjunct the Asc.

At the time the hurricane reached Miami, on Sept. 18, progressed Moon was semi-sextile the Asc. of the Temperature Chart, progressed Pluto was opposition the Asc. of the Air Movement Chart, and progressed Saturn was inconjunct the Asc. of the Moisture Chart.

Probably the Greatest Hurricane Ever Recorded.

—This hurricane formed near Cape Verde Islands, and raged from September 10 to September 20, 1928, causing great loss of life and destruction of property.

Temperature Chart No. 262, the elements of which are given on pages 112-113, shows stormy Capricorn on the cusp of the fourth, and its ruler, Saturn, in Sagittarius inconjunct violent Pluto. Windy Libra is on the cusp of the first, and its ruler, Venus, is sextile peculiar Neptune. The most ominous thing about the chart is progressed Mercury, planet of wind, square the Asc.

Air Movement Chart No. 263, the elements of which are given on pages 112-113, shows violent and windy Uranus in the fourth in opposition to windy Mercury. Venus, the ruler of the sign occupied by Mercury, is in windy Libra in opposition to violent Uranus. Pluto and Uranus, both violent, are the only two planets in angles. This chart, in spite of Sagittarius being on the cusp of the first, shows much violence and wind.

Moisture Chart No. 264, the elements of which are given on pages 112-113, shows Pluto in the fourth house in progressed semi-sextile with violent Mars. Cancer is on the cusp of the fourth, and its ruler, the Moon, is in windy Gemini in close conjunction with violent Mars and square violent Pluto. Violent Aries is on the cusp of the first, and its ruler, Mars, as already indicated, is progressed sextile to Pluto, and is conjunction the Moon and square the Sun. This also is a very violent chart.

At the time the hurricane commenced, Sept. 10, progressed Saturn was sextile the Asc. of the Temperature Chart, progressed Moon and progressed Mars were parallel the Asc. of the Air Movement Chart, and progressed Mercury was opposition the Asc. of the Moisture Chart.

Hurricane, August 7-13, 1928

—This hurricane ranged for a week all the way from Florida to New Jersey, unroofing scores of buildings, wrecking others, killing a few people, and damaging the citrus crop. The three charts are erected for Jacksonville, Florida.

Temperature Chart No. 265, the elements of which are given on pages 112-113, has the storm planet Saturn in the fourth in progressed inconjunct with violent Pluto. Windy Virgo is on the cusp of the first, and its ruler, Mercury, is square Uranus and conjunction Pluto, both violent planets. The Moon, ruler of the sign occupied by the Sun, is in Leo conjunction peculiar Neptune.

Air Movement Chart No. 266, the elements of which are given on pages 112-113, has windy and violent Uranus in the fourth. Pisces is on the cusp of the fourth, and its ruler, Neptune, is in Leo closely square violent Mars. The storm planet Saturn is in the first house making a progressed trine with the Sun. The Sun, ruler of the sign occupied by Mercury, is in Leo thus in progressed aspect to Saturn. The most ominous feature of the chart is that progressed and violent Uranus releases the force of the chart by making a progressed trine to the Asc.

Moisture Chart No. 267, the elements of which are given on pages 112-113, has the storm sign Capricorn on the cusp of the fourth and its ruler, Saturn, in Sagittarius. The most ominous feature of the chart is the Moon in the fourth making a progressed trine to the Asc., and the Sun in the tenth making a progressed sextile to the Asc.

Windy Libra is on the cusp of the first, and its ruler, Venus, is in Leo making a progressed semi-sextile to Pluto. Uranus, ruling the sign occupied by the Moon, is in violent Aries in opposition to the Asc. The planets in angles are Sun, windy Mercury, wet Moon and violent Pluto. In addition to the progressed aspects of Sun and Moon to the Asc., progressed Jupiter is square both Sun and Moon and at the same time inconjunct the Asc. Thus there are three progressed aspects to the Asc. releasing the force of the chart.

On the date the hurricane reached Jacksonville, August 7, progressed Saturn was square the Asc. of the Temperature Chart, progressed Uranus was trine the Asc. of the Air Movement Chart, and progressed Jupiter was inconjunct the Asc. of the Moisture Chart.

Book 16

Copyright
August 2002
Church of Light

Stellar Healing

Chapter 1

Serial No. 197
Original Copyright 1947
Elbert Benjamine

Copyright
August 2002
Church of Light

Stellar Anatomy

VARIATION OF HOUSE POWER

House	Weaker Cusp	Stronger Cusp	Vari- ation
6	6.50	7.00	.50
5	7.00	7.50	.50
3	7.50	8.00	.50
2	8.00	8.50	.50
12	8.60	9.30	.70
9	9.30	10.00	.70
8	10.00	10.90	.90
11	10.90	11.90	1.00
4	12.00	14.00	2.00
7	12.50	14.50	2.00
10	13.00	15.00	2.00
<i>House power of M.C. or Asc.:</i>			15.00

MINUTES EXPRESSED AS DECIMALS OF A DEGREE

<i>M.</i>	<i>Dec.</i>	<i>M.</i>	<i>Dec.</i>	<i>M.</i>	<i>Dec.</i>	<i>M.</i>	<i>Dec.</i>
1	.02	16	.27	31	.52	46	.77
2	.03	17	.28	32	.53	47	.78
3	.05	18	.30	33	.55	48	.80
4	.07	19	.32	34	.57	49	.82
5	.08	20	.33	35	.58	50	.83
6	.10	21	.35	36	.60	51	.85
7	.12	22	.37	37	.62	52	.87
8	.13	23	.38	38	.63	53	.88
9	.15	24	.40	39	.65	54	.90
10	.17	25	.42	40	.67	55	.92
11	.18	26	.43	41	.68	56	.93
12	.20	27	.45	42	.70	57	.95
13	.22	28	.47	43	.72	58	.97
14	.23	29	.48	44	.73	59	.98
15	.25	30	.50	45	.75	60	1.00

Symbol of Aspect	Name of Aspect	Number of Apart	Succeeding Houses Planets Orbs	Succeeding Houses Planets Orbs	Succeeding Houses Planets Orbs	Succeeding Houses Planets Orbs	Succeeding Houses Planets Orbs
♌	Conjunction	0	10	13	12	15	8
♍	Semi-sextile	30	2	3	3	4	1
♎	Sextile	60	6	7	7	8	5
♏	Square	90	8	10	10	12	6
♐	Trine	120	8	10	10	12	6
♑	Inconjunction	150	2	3	3	4	1
♒	Semi-square	45	4	5	5	6	3
♓	Sesquialter square	135	4	5	5	6	3
♈	Opposition	180	10	13	12	15	8
♉	Parallel		1	1	1	1	1

M.C. and Asc. have the same orb as planets in angles.

Chapter 1

Stellar Anatomy

ONE who practices Stellar Healing should possess a much more detailed knowledge of the stellar, or astral body than is necessary for the successful practice of natal astrology. Such detailed information of the composition of the finer body is as important to the stellar healer as is detailed knowledge of physical anatomy to the surgeon. Astral means, pertaining to the stars; therefore it is quite fitting that the science of the parts and structures of the astral body should be called stellar anatomy.

It has been fully explained in Courses 5 and 9 that just as the atoms of the physical body are composed of neutrons, positrons and electrons in various relations, so the chief elements of the astral body are made up of the Drive for Significance, reproductive desires and nutritive desires. The reproductive desire is the positive expression of the Drive for Significance even as the positron is the positive factor of an atom, while the nutritive desire is the negative expression of the Drive for Significance—which may be compared to the neutron—even as the electron is the negative factor of an atom. Neutrons, positrons, electrons, drives for significance, reproductive desires, and nutritive desires are all energy fields. The energy fields represented by the drives for significance, reproductive desires and nutritive desires have been derived from and formed by states of consciousness.

Even as neutrons, positrons and electrons combine to form all the various chemical elements of the physical world, so do drives for significance, reproductive desires and nutritive desires combine to form the substance of the astral body. As you are aware, the physical body of man contains other things, such as the uncombined mineral salts, air, water and substances like the nails and hair which are secreted by protoplasm, but the chief substance of the material body is protoplasm. So also, while man's astral body contains other things, it is chiefly composed of psychoplasm formed by states of consciousness.

The astral body, which can live independent of the physical, is composed of stellar substance which through the action of states of consciousness has been converted into psychoplasm. And just as the protoplasm of the physical body is organized into living cells so the psychoplasm of the astral body is organized into living, intelligent stellar cells. These stellar cells, derived from states of consciousness, are like

physical cells in that they represent definite compounds and are capable of limited intelligent work.

The cells of protoplasm which are the chief ingredient of the physical body are differently arranged and compounded into the various tissues of the physical form. According to their functions different tissues, thus chiefly composed of protoplasmic cells, have different structures. And the stellar cells of psychoplasm which are the chief ingredient of the astral body are also differently arranged and compounded into the various structures of the stellar form. These structures of the astral body are arranged in the astral body in twelve different zones. These zones are mapped in the birth-chart by the twelve zodiacal signs. Aries maps the head zone, Taurus the throat and neck zone, Gemini the arms and hands zone, etc.

The Twelve Compartments of the Astral Body

—But in addition to these twelve zones there are also twelve different compartments within the astral body. Each of these twelve compartments has an affinity for the thoughts, feelings and impulses relating to certain phases of the life, and much less affinity for the thoughts, feelings and impulses relating to other phases of the life.

Calcium foods when taken into the physical body are not utilized in building muscle, but in building bone and giving tone to the nerves by correcting the excess of other mineral salts in the blood stream. Iron goes at once to the red blood corpuscles; and the fuels to the tissues where needed. That is, some physical foods have an affinity for one department of the physical anatomy and other foods have an affinity for other departments.

Thoughts, feelings and impulses are the foods of the astral body, and each type of mental food has an affinity for some one of the twelve compartments of the stellar makeup. Thoughts and feelings which revolve around the personality, immediately they are assimilated, move into section one of the astral body. Thoughts and feelings about money move into compartment two. Thoughts and feelings about brethren, studies and travels quickly congregate together in the third well defined region of the astral form, and so on.

Due to variation in human personality and character, these compartments of the astral body in which the stellar cells are retained are not related to the astral bodies of all people alike. In fact, although the order of sequence is always the same, otherwise there is the greatest difference. For instance, the stellar organization relating to money may, in one person's astral form be in the neck, may in another person's astral form be in the stomach, may in another person's astral form be in the knees, and in still another person's astral form may be in the feet.

Each Planet Maps a Receiving Set

—Each planet in the birth-chart maps an organization of thought-cells which has much power, and each of these dynamic stellar organizations within the astral body is a receiving station for the energy of the planet which maps its position in the birth-chart. That is, where Mars is located by sign and degree in the birth-chart is a receiving and transmitting set dialed to the astral frequencies radiated by the planet Mars. Where Saturn is located by sign and degree in the birth-chart is a radio receiving and transmitting set tuned to the frequencies radiated by the planet Saturn. And because they are thus tuned to these planetary vibratory rates they also pick up thought vibrations and character vibrations of a similar frequency; for the vibrations radiated by objects and by thoughts are essentially of the same kind as those radiated by the planets.

What I mean by the location of a planet by sign and degree is that if Mars is in the sign Leo in the birth-chart the receiving and transmitting set for Mars vibrations is located in the heart of the stellar body. If Saturn is in the sign Aquarius in the birth-chart, the receiving and transmitting set for Saturn vibrations is located in the ankles of the stellar body. The stellar organization wherever a planet is located in the birth-chart is intensely alive and responsive to the vibratory rates of the particular planet, forming a natural radio set for reception and transmission.

And right here is one of the most important things that a stellar healer should understand: Every dynamic thought-center mapped in the birth-chart by a planet has an antenna, either short or long, for this reception and transmission of the vibratory rates of the planet. If the planet has no aspect, the antenna may be considered merely a short loop aerial, incapable of picking up planetary energy as readily as it would if it were a good long aerial.

But when one planet makes an aspect to another planet this builds an aerial stretching through the astral body between the two—or if a conjunction or parallel, around the two—which readily picks up certain vibratory rates and transmits them to both terminals. That is, the energy picked up by this line within the astral body travels to the dynamic structure at either end of the line. These dynamic stellar structures are composed of organizations of stellar cells. Such cells have an intelligence of their own derived from the thought processes which brought them into existence. And the energy thus added gives them power to do work from the inner plane characteristic of the planet mapping them and the department of life as indicated by their house position.

The stellar aerials that thus feed the dynamic structures directly through extending between dynamic structure and dynamic structure, and feed the common thought-cells mapped by the same house, or by the house the cusp of which is ruled by the planet mapping the dynamic structure, are strong or weak as indicated by whether or not the aspect between the two planets is more or less perfect. The more

nearly perfect the aspect, the stronger the receptive qualities of the aerial. But if the orb is too far from the perfect aspect the aerial becomes so nebulous as to give no aid to reception, and we say the planets are not within aspect of each other.

These stellar aerials, stretching through the astral body much as nerves run through the physical body, not only act as instruments to pick up wave-lengths broadcast from the planets to the earth, but also, because they run from definite terminals in definite ways, they determine whether the reception is clear and harmonious, or accompanied by inharmony and static.

If one end of the stellar aerial is attached to the Mars terminal in the astral body, this insures that it will pick up Mars energy. That is, any astral energy of the frequencies indicated by Mars, whether harmonious or discordant, and whether from the planet Mars, from some object ruled by Mars, or from some person's aggressive thoughts, that reaches this aerial, is picked up by it.

Such an aerial, however, is always attached at the other end to the dynamic thought structure which forms the terminal for another planet. Not only so, but it crosses a portion of the astral body between the two terminals, in a definite way which, as mapped in the birth-chart is called an aspect. Due to the length of the aerial and other factors, whatever energy is received over it is given a definite characteristic quality. Of the ten aspects, three are neutral in so far as harmony or discord is concerned, three give the energy received a harmonious trend, and four channel it as discord. But other than their influence over harmony and discord each of the ten aspects gives the energy received a trend which is best expressed by its key-word. These are given in lesson No. 47 (CS. 2, *Astrological Signatures*).

An Aerial Can Pick Up Two Different Tones

—As one end of the stellar aerial mapped by an aspect in the birth-chart terminates in one planet's dynamic structure, and the other end terminates in another planet's dynamic structure, any aerial is capable of picking up two different tones of energy. That is, it customarily picks up the vibratory energy of either of the planets which map the ends of the aspect in the birth-chart.

And because these dynamic stellar structures, or thought-centers, within the astral body which are mapped by the two planets are located in the particular compartment of the astral body which influences a certain department of life, whatever energy is picked up by the stellar aerial flows into these two compartments through the two types of dynamic stellar structures marking the terminals of the aerials.

Furthermore, the energy present in one compartment thus has ready access to, and can, and does, influence the thought-cells in the compartment at the other end of the aerial. How the two departments of life thus influence each other is indicated by the planets mapping the influencing terminals and the harmony or discord of the aspect.

The influence of the aerial and the thought-cells of the dynamic structures reached by it is not confined, however, to the compartments reached by the terminals of the aspect. All the 12 compartments of the astral body are filled with less active common thought-cells. The common thought-cells within any compartment are influenced and made active by any dynamic stellar structure in it through the principle of resonance. The activity of the dynamic stellar structure mapped by a planet, through the principle of resonance, influences also the activity of the common thought-cells of each sign it rules. Through this resonance the common thought-cells of a compartment not containing the dynamic structure, but having a sign ruled by the same planet on its house cusp, receives approximately one-half as much energy from an aspect as is received by the compartment containing the dynamic structure.

The Stellar Ground Wire

—In addition to planetary aerials, the clairvoyant discerns a heavy line running across the astral body in the region marking the sign and degree on the Ascendant of the birth-chart. When the birth-hour is not known, if this line can be seen, the proper Ascendant can be determined. The ascending degree may also have aerials stretching to the planetary terminals, as may the degree on the M.C. But the Ascendant is unique in that it acts as the grounding wire. That is, it is where the person connects, and exchanges energy through the electromagnetic body and its forces, with his immediate environment.

The degree on the Midheaven, however, has almost an opposite function. Such astral energies as find their way to this point are amplified and radiated to the world at large. It is a broadcasting station for the whole astral organism, and the nearer a dynamic structure, as mapped by a planet in the birth-chart, is to this point, the more freely its energies are broadcast.

Astral energy to reach the local environment flows along the ground wire with the electromagnetic forces. The astral body is grounded, and connected with its immediate physical environment, through the electromagnetic radiations of the physical body. This ground-wire influence of the personality, therefore, reaches only so far as the electromagnetic emanations flow.

The Stellar Amplifier

—But the wider influence of the individual is not so determined. It depends upon the amount and quality of the astral energy radiated. Each aerial in the astral body not only picks up, but also radiates, astral energy. And some of this astral energy is brought to a focus in the region of the astral body mapped by the apex of the birth-chart. Clairvoyantly the M.C. is marked through the astral body by a sharp blue line. And all such astral energy, whatever its character may be, which reaches the line, is widely broadcast. The sharp blue line mapped by the degree on the M.C. acts as an amplifier.

Because the various aerials, mapped by the aspects in the birth-chart, remain throughout life, except when changed by individual initiative in the application of the principles of Mental Alchemy, they are called permanent aerials. But in addition to these permanent aerials, or stellar wires across the astral body, which thus persist, there are others which form temporarily.

Events Take Place Only When There Are Temporary Aerials

—The planets as they move forward by progression through the signs of the zodiac form points of stimulation. Their energies fall upon the zone of the astral body governed by the sign they are passing through. Thus, regardless of aspect or aerial, they impart a certain amount of energy—about one-half of their birth-chart power if the movement is by major progression—to the thought-cells of the zone, and thus give the thoughts, feelings and impulses of the compartment indicated more than their normal activity. And this is true whether the planet moves through the sign by major progression, by minor progression, or by transit; although the amount of energy thus imparted by major progression is 27.3 times as much as by minor progression, and $365 \frac{1}{4}$ times as much as by transit. Major progressed Moon carries about $\frac{1}{7}$ the power of the other planets when similarly making aspects, that is, it imparts about $\frac{1}{14}$ of its birth-chart power to the zone or compartment through which it moves.

When such a progressing planet makes an aspect, either to the place of a planet in the birth-chart, or to the major progressed position of another planet, there is formed within the astral body a line of stellar substance connecting these two points. That is, the progressed aspects map temporary aerials that form and dissolve within the stellar form.

They are temporary, but while they last they pick up and transmit the energy of the two planets making the aspect to the compartments within the astral body. Energy is thus temporarily added in much volume, and in harmony or discord characteristic of the aspect, to the stellar cells influencing the indicated department of life. In our extensive statistical studies we have found that when Mars or the Sun is involved, and at the same time there are other heavy progressed aspects which act as Rallying Forces, the indicated event may occur when the progressed aspect is as much as a degree and a half from perfect. But as a general rule, the effective orb within which the event indicated by a progressed aspect takes place is one degree from the perfect aspect.

Before it reaches one degree from perfect, the line across the astral body usually has not become dense enough to act as an effective aerial. But at one degree from perfect it is dense enough to pick up about one-half the peak load of the aspect, gradually increasing in power until the peak is reached when the aspect becomes perfect, then decreasing gradually in power until at one degree beyond perfect it picks up only about one-half the peak load, past which point it usually has dissolved so far that it is no longer an effective receiver.

Each individual, according to the thought-composition of his stellar cells, and the permanent aerials connecting terminals in the dynamic structures of the various compartments of his astral body, has a normal relation to each department of life. That is, the average financial fortune, the average honor, the average health, etc., for each individual is different, depending upon the activity and harmony or discord of the stellar structure in the compartment of his astral body related to the particular department of life.

Temporary stellar aerials that last over many years, and when a major progressing planet moves into an adjoining house of the birth-chart, have an influence on the thought-cells and consequently the life. But the conditions influenced by them last so many years that they come to be considered normal conditions for the individual.

But starting with such a normal state of affairs for the individual, statistics compiled from the analysis of many thousands of events in which the birth-chart has been erected and the major progressed positions of the planets placed around the outside of the chart for the date of the event—2,000 such events thus analyzed in the book *WHEN AND WHAT EVENTS WILL HAPPEN*, and 700 more in the book *BODY DISEASE AND ITS STELLAR TREATMENT*—show that variations of consequence from this normal never occur except when there is a major progressed aspect involving the planet characteristic of the type of event and ruling the house of the chart governing the department of life affected.

Events of consequence only take place during those periods when, due to the formation of major progressed aspects, the thought-cells that know how to work from the inner plane to bring the particular type of event to pass, gain enough additional energy that they can exert far more than normal extraphysical power on the individual's thoughts, on his behavior, and on his physical environment.

It is Advantageous to Know How Much Power is Indicated

—There are two methods which are sometimes employed in determining the amount of the ordinary utility service bills. One is the flat-rate method. The other is the metered method. In the flat-rate method the householder is charged a fixed rate per month for the water he uses, a fixed rate per month for the gas he uses, a fixed rate per month for the electricity he uses, and a fixed rate per month for his telephone service. While the flat-rate method is still largely employed for the home telephone, the

metered method, in which payment is proportional to the number of calls made, is now finding favor for business phones. But it is now customary to install a water meter which measures the amount of water used in the home, and to charge for the precise amount of water used. It is now customary to use a gas meter which measures the amount of gas used in the home, and to charge for the precise amount of gas used. And it is now customary to employ an electrical meter and to charge for the precise amount of electricity used.

There was a time when such meters for the home were unavailable. The flat-rate method of charging for utility services was then the custom. In astrology, the flat-rate method of estimating the power of a given planet, a given aspect, a given sign or a given house in a birth-chart has almost universally been used, because hitherto there has been no precise method of measuring such power. The flat-rate method in astrology is the method of inspection. And it has the advantage of being adapted to mass-production; that is, to analyzing a large number of charts without much labor.

But there are various other instances in the practice of astrology in which it is desirable to know not merely that an aspect is powerful, but HOW MUCH power is represented by the given aspect in a chart. This may show, for example, how much the activities of one house will affect the activities of another house, or how much the things ruled by one of the planets will influence the things ruled by the other planet.

There are still more instances in which it is valuable to know HOW MUCH the total power of a planet is. The aptitude of the individual to develop abilities of a certain type is indicated by the prominence of a given planet. The more POWER the thought-cells mapped by this planet have the easier it is to develop abilities of this type, and the more ability of this type can be developed. As shown by statistical analysis in the book, HOW TO SELECT A VOCATION, aptitude for a given vocation depends upon the prominence of one or more specific planet. The more POWER these vocational constants have, the more aptitude the individual has for the vocation. Events, such as accidents, and conditions, such as length of life, are more common and more pronounced in the lives of people who have certain planets prominent. The more POWER these planets have which are the birth-chart constants of the event or condition, the more likely the event or condition is to be present in the life.

As shown by statistical analysis in the book, BODY DISEASE AND ITS STELLAR TREATMENT the prominence of certain planets in the birth-chart indicates a predisposition toward a given type of disease. And the more POWER these birth-chart constants of the given disease have, the greater the predisposition toward developing that particular disease.

It is also highly valuable to know HOW MUCH power is possessed by certain houses of the chart. The activity of a given department of life is indicated by the POWER of the house governing that activity. As shown by statistical analysis in the book, HOW TO SELECT A VOCATION, an individual, regardless of his ability, is not apt to become a doctor who has an inactive sixth house or an inactive twelfth house; nor, regardless of dramatic talent, is he apt to become a movie actor if he has an inactive first house or an inactive fifth house. Nor is he apt to take frequent long journeys if he has an inactive ninth house. The more POWER a house has, the more important the things of the department of life ruled by this house tend to be in the life.

Not only is it valuable to know at times, HOW MUCH POWER is possessed by a given aspect, HOW MUCH POWER a planet in the birth-chart possesses, and HOW MUCH POWER a certain house of the chart has, but there are also times when it is desirable to know HOW MUCH POWER is possessed by a given sign.

Types of physical environment, many objects, certain names, certain numbers, and certain gems have definite rulership by zodiacal signs. The AMOUNT of influence over the life of associating closely with something, or living in an environment, ruled by a certain zodiacal sign is dependent upon the POWER of that sign in the birth-chart and progressed chart.

The zones of the body afflicted by disease are indicated by the zodiacal signs. Not merely the discord, but also the POWER of a given sign in the birth-chart and progressed chart, have an influence on which part of the body is most apt to be attacked by disease.

Those practicing other sciences are not content to guess from inspecting the machinery or the result of some force how much power is involved. To deal more precisely with non-physical electromagnetic force science established standard units and gave names to them by which it measured this Boundary-Line force and its attributes. Luminous intensity is thus measured and expressed by the unit known as Candle Power. The unit of electric current is the Ampere, the unit of the potential of the current is the Volt, and the unit of the resistance to the current is the Ohm.

Not only was it necessary for science to establish such standard units, but it was necessary to devise mathematical methods for determining the number of each unit of the Boundary-Line force present under a variety of circumstances. And to facilitate such calculations the ampere and the volt were given values so that the product of the current measured in amperes by the electromotive force measured in volts at any instant equals the unit of power, which is called a Watt. 1,000 watts (one kilowatt) is approximately equivalent to 1.34 horsepower.

The ordinary domestic lighting system carries 110 volts. The three transmission lines from Boulder Dam to Los Angeles each carries 275,000 volts.

No doubt with practice an individual could learn to estimate fairly well the comparative luminosity of two electric light bulbs by inspection; but in purchasing such light bulbs for use in the home, or for special purposes, it is a great convenience,

and reduces error, to find each bulb marked with the number of watts of electricity it uses. When one purchases a 100-W. bulb he is confident the light will not be strong enough to blow a fuse, but will be strong enough for a reading lamp.

As the attainment of unusual precision requires painstaking work, it does not lend itself to mass-production methods. Because of the amount of work involved in gaining precision, in our statistical work relative to birth-charts and progressed aspects, in which 100 charts covering each condition analyzed are used, we employ the mass-production method of inspection. And for broad purposes such inspection and mental estimation of the power of a given position or aspect in the birth-chart or in the progressed chart commonly are sufficient. But there are many other instances, such as when it is difficult to diagnose the disease afflicting a patient, and especially relative to one's own chart on which one is warranted in doing much work, in which it is highly advantageous to gain greater precision than can be had through such inspection.

When the amount of work involved is mentioned there is no implication that it is either very heavy or difficult. For one familiar with the method—which consists merely of the addition, subtraction, multiplication and division of small numbers containing two-place decimals—it takes about 5 hours' work to calculate and tabulate not merely the power in astrodynes of each and every aspect, planet, sign and house in a chart which has already been erected, but to calculate and tabulate also the harmony expressed as harmodynes or the discord expressed as discordynes of each and every aspect, planet, sign and house of the chart. Anyone is justified in putting in 5 hours' extra work to get such precision on a chart of importance. But when handling hundreds of charts statistically, 5 extra hours on each chart is far more than can be spared of the at present limited time of The Church of Light Astrological Research Department.

Even as was necessary to gain precision in dealing with electromagnetic force science had to establish standard units and mathematical methods, so also to deal more precisely with astrological force we have had to establish standard units and give them names for the measurement of astrological power, the harmony of the astrological power, and the discord of the astrological power; and have had to, devise mathematical methods of computing them.

Dyna, used as a prefix, means power. Dyne is a standard unit of force in physics. Astrodyne, as the unit of astrological power, was first used by Lawrence W. Dunsmoor in the January, 1939, issue of the *Rising Star*. Harmodyne, as the unit of astrological harmony, and discordyne as the unit of astrological discord, were first used in 1946 by Elbert Benjamine and W. M. A. Drake. Elbert Benjamine and W. M. A. Drake worked out the mathematical method of computing the number of astrodynes, harmodynes and discordynes represented by each birth-chart aspect, planet, sign and house, and by each progressed aspect, planet, sign and house and combination, during the year 1946. They explained and illustrated the method in great detail in the *Rising Star*, commencing with the May issue, 1946.

In this course on Stellar Healing space does not permit illustrating the method in so great detail. But as the professional healer should have in his possession a tool to give him precision in diagnosis, the method will be explained in these lessons, and illustrated in sufficient detail to enable it to be thoroughly understood and applied.

In considering the power of a planet there are three things to be considered: (1) houses; (2) aspects; (3) the unmodified power of the planet. In reference to (2) and (3) the B. of L. Table of Aspects and their Orbs given on page 3, which during more than a quarter of a century has been found reliable, is used as the basis of computation. For the power given by each of the twelve houses, the table of house power given on page 2 has been carefully worked out.

It may be that some have become rusty in the use of decimal fractions. As astrodynes, harmodynies and discordynies are computed to two-decimal places, the ability to handle decimal fractions in such work becomes imperative. Those who have forgotten should be reminded that a smaller whole number may be divided by a larger whole number by using a decimal point to the right of the smaller number and adding as many ciphers as necessary. In such division, or in the division of one decimal by another, the division, after ciphers are added to the right of the decimal point when necessary, is carried out without regard to the position of the decimal points in exactly the same manner as for a whole number. But after the division has taken place the position of the decimal point in the quotient is determined thus:

“Rule: Subtract the number of places to the right of the decimal point in the divisor from the number in the dividend. The remainder is the number of figures to the right of the decimal point in the quotient.”

In multiplying numbers one or both of which contain decimals, multiply exactly as if they were whole numbers, without regard to the position of the decimal point. The position of the decimal point in the product is determined thus:

“Rule: The number of figures to the right of the decimal point in the product of the two decimal numbers equals the sum of the number of figures to the right of the decimal points in the multiplicand and multiplier.”

As addition and subtraction of U.S. currency employs decimals to two places, no remainders will be needed on these operations.

The house position of a planet contributes one factor of its power. The cusp of each house is its strongest point, and the cusp of the next following house is its weakest point. The variation due to the planet's distance from the weaker cusp is added to the power of the weaker cusp, or the variation due to the planet's distance from the stronger cusp is subtracted from the power of the stronger cusp. This gives the power of the planet due solely to its house position.

Power Variation Due to Distance

Planet is From a Cusp

—Rule: To find the variation due to the distance a planet is from a house cusp, multiply the number of degrees the planet is from the house cusp by the variation for the house as a whole and divide the product by the number of degrees in the house, carrying to two decimal places.

Every aspect which a planet makes contributes to its power. As to the amount of orb to allow in using the Table of Aspects and their Orbs given on page 3, I quote from B. of L. lesson No. 87: “When one planet is in a powerful house and another is in one feeble, or when the orb of one planet is different than that of the other, it is safe practice to use the orb of the powerful house or planet.”

Mercury the Exception

—Mercury has no wider orb than have the other planets, but for reasons to be explained later and verified by much observation, Mercury when it is within orb has more power than the other planets. Therefore in calculating the power of Mercury when it is within orb of an aspect, it is handled as if it had the orb of Sun or Moon.

Other than Mercury, the power of a planet due to an aspect in the zodiac is the number of degrees the planet is from the orb limit of the aspect, plus a decimal representing the remaining minutes the planet is from the orb limit of the aspect.

Power Represented by Minutes

Planet is From Orb Limit

—Rule: Divide the number of minutes by 60 and carry to two decimal places.

Power Represented by Minutes

Planet is From Parallel Orb Limit

—Rule: Multiply the number of minutes by the number which represents the perfect parallel and divide the product by 60, carrying to two decimal places.

The perfect parallel has the same power as have the same planets when making the perfect conjunction in the more powerful of the houses occupied by one of the two planets. Mercury is given the same power when involved in a parallel as would be given Sun or Moon in the same house making the same parallel aspect.

For our example chart, we will use that of John Edwards, March 19, 1920, 0:40 A.M., C.S.T., 89W. 40:43N. The chart is illustrated on page 4.

I believe as the total power of each planet is given in lesson No. 198, and a grill showing the power of each aspect is given in lesson No. 199, against which the student can check his own calculations, that it will be sufficient illustration of the method of computing the power of each aspect and the total power of each planet if we here set forth the calculations for Moon and Mercury only. Because Mercury in this chart is in a cadent house, and the Sun or Moon in a cadent house has no wider orb than a planet in a more powerful house, Mercury has no advantage in this chart over the other planets. But to show the manner of handling Mercury when in other houses, I will indicate in parentheses what its power would have been if it had been in an angle.

The Moon is in the third house, $11^{\circ}18'$ from the cusp of the third. The Table of House Power (page 2) gives a value of 8.00 to the stronger cusp and a variation of .50 between the cusp of the third and fourth. The house contains 36 degrees. Multiplying 11.30 by .50 gives 5.65. Dividing 5.65 by 36 gives .16 as the variation for the $11^{\circ}18'$. Subtracting .16 from 8.00 gives the power of the Moon due to Position alone as 7.84 astrodynes.

- The Moon makes no aspect with the Sun.
- The Moon makes no aspect with Mercury.
- The Moon makes no aspect with Venus.

The trine orb of the Moon in cadent houses, as given in the Table of Aspects and their Orbs (page 3) is 8° . The Moon is $4^{\circ}30'$ from perfect trine Mars. Subtracting $4^{\circ}30'$ from $8^{\circ}00'$ gives $3^{\circ}30'$ as the distance the aspect is from its outer limit. 30 divided by 60 gives .50 as the power of the $30'$. Adding this to 3 gives the power of the aspect as 3.50 astrodynes.

The Moon makes no aspect with Jupiter.

The opposition orb of the Moon in cadent houses is 11° . The Moon is $6^{\circ}45'$ from perfect opposition to Saturn. Subtracting $6^{\circ}45'$ from $11^{\circ}00'$ gives $4^{\circ}15'$ as the distance the aspect is from its outer limit. 15 divided by 60 gives .25 as the power of the $15'$. Adding this to 4 gives the power of the aspect as 4.25 astrodynes.

The conjunction orb of the Moon in cadent houses is 11° . The Moon is $10^{\circ}18'$ from perfect conjunction Uranus. Subtracting $10^{\circ}18'$ from $11^{\circ}00'$ gives $42'$ as the distance the aspect is from its outer limit. Dividing 42 by 60 gives the power of the aspect as .70 astrodynes.

- The Moon makes no aspect with Neptune.

The trine orb of planets in an angle is 10° . The Moon is $7^{\circ}50'$ from perfect trine Pluto. Subtracting $7^{\circ}50'$ from $10^{\circ}00'$ gives $2^{\circ}10'$ as the distance the aspect is from its outer limit. Dividing the 10 by 60 gives .17 as the power of the $10'$. Adding this to the 2 gives the power of the aspect as 2.17 astrodynes.

The Moon is $59'$ from perfect parallel M.C. As the parallel has the same power as the conjunction, and the M.C. is an angle, the power of the perfect parallel is 12. Subtracting $59'$ from $60'$ gives $1'$ as the distance the aspect is from its outer limit.

Multiplying 1 by 12 gives 12. Dividing 12 by 60 gives the power of the aspect as .20 astrodynes.

The square orb of planets in an angle is 10° . The Moon is $3^\circ 50'$ from perfect square Asc. Subtracting $3^\circ 50'$ from $10^\circ 00'$ gives $6^\circ 10'$ as the distance the aspect is from its outer limit. Dividing the 10 by 60 gives .17 as the power of the $10'$. Adding this to the 6 gives the power of the aspect as 6.17 astrodynes.

Now let us add the numbers we have obtained for the house position and each aspect made by the Moon. 7.84 plus 3.50 plus 4.25 plus .70 plus 2.17 plus .20 plus 6.17 gives the total power of the Moon as 24.83 astrodynes.

Mercury is in the third houses $7^\circ 50'$ from the cusp of the fourth. The table of House Power (page 2) gives a value of 7.50 to the weaker cusp and a variation of .50 between the cusp of the third and fourth. The house contains 36 degrees. Multiplying 7.83 by .50 gives 3.92. Dividing 3.92 by 36 gives .11 as the variation for the $7^\circ 50'$. Adding .11 to 7.50 gives the power of Mercury due to Position alone as 7.61 astrodynes.

The conjunction orb for the Sun in cadent houses is 11. Mercury is $1^\circ 58'$ from perfect conjunction Sun. As Sun is involved, and thus the wider orb used, Mercury is given no additional advantage. Subtracting $1^\circ 58'$ from $11^\circ 00'$ gives $9^\circ 02'$ as the distance the aspect is from its outer limit. 2 divided by 60 gives .03 as the power of the $2'$. Adding this to the 9 gives the power of the aspect as 9.03 astrodynes.

- Mercury makes no aspect with the Moon.

The semi-sextile orb of planets in succedent houses is 2° . Mercury is $26'$ from perfect semi-sextile Venus. As the Sun in a cadent house (where Mercury is) also has an orb of 2° , Mercury gains no advantage. Subtracting $26'$ from $2^\circ 00'$ gives $1^\circ 34'$ as the distance the aspect is from its outer limit. 34 divided by 60 gives .57 as the power of the 34. Adding this to the 1 gives the power of the aspect as 1.57 astrodynes. (Had Mercury made the same aspect from an angle the power would have been 3.57 astrodynes.)

- Mercury makes no aspect with Mars, Jupiter, Saturn, Uranus or Neptune.

The square orb for planets in angles is 10° . Mercury is $5^\circ 18'$ from perfect square Pluto. Subtracting $5^\circ 18'$ from $10^\circ 00'$ gives $4^\circ 42'$ as the distance the aspect is from its outer limit. 42 divided by 60 gives .70 as the power of the $42'$. Adding this to the 4 gives the power of the aspect as 4.70 astrodynes. (Had Mercury made the same aspect from an angle the power would have been 6.70 astrodynes.)

The opposition orb of planets in angles is 12° . Mercury is $7^\circ 50'$ from perfect opposition M.C. Subtracting $7^\circ 50'$ from $12^\circ 00'$ gives $4^\circ 10'$ as the distance the aspect is from its outer limit. 10 divided by 60 gives .17 as the power of the $10'$. Adding this to the 4 gives the power of the aspect as 4.17 astrodynes. (Had Mercury made the same opposition from the fourth house the power would have been 7.17 astrodynes.)

Mercury is 3' from perfect parallel M.C. As the parallel has the same power as the conjunction, and the M.C. is an angle, the power of the perfect parallel is 12. (Had Mercury been in the fourth house it would have been 15.) Subtracting 3' from 60' gives 57' as the distance the aspect is from its outer limit. Multiplying 57 by 12 gives 684. Dividing 684 by 60 gives the power of the aspect as 11.40 astrodynes.

Now let us add the numbers we have obtained for the house position and each aspect made by Mercury.

7.61 plus 9.03 plus 1.57 plus 4.70 plus 4.17 plus 11.40 gives the total power of Mercury as 38.48 astrodynes.

Chapter 2

Serial No. 198
Original Copyright 1947
Elbert Benjamine

Copyright
August 2002
Church of Light

The Basis of Stellar Diagnosis

INSTRUCTIONS FOR FINDING MUTUAL RECEPTION

See table on Facing Page

When the planet in Column 1 is in one of the signs below it, and the planet in Column 2 in the space directly to the right of this sign is in one of the signs above it in Column 2, the indicated planets are in Mutual Reception.

And when the planet in Column 3 is in one of the signs below it, and the planet in Column 4 in the space directly to the right of this sign is in one of the signs above it in Column 4, the indicated planets are in Mutual Reception.

EXAMPLE:

To determine if a Mutual Reception forms when the Sun is in Cancer and the Moon is in Aries. Find Sun (top Column 1), go down to Cancer, now look to planet in Column 2 in space which is directly to the right.

Find Moon: check signs at top of Column 2. As Aries appears there, the two planets are in Mutual Reception.

MUTUAL RECEPTION

Column 1			Column 2			Column 3			Column 4		
	☉		♁		♄		♀		♁	♃	♅
☽		♅		♃		♄	♁	♄		♁	
♂	♁	♄		♅		♃	☽	♃		♄	
♄	♁	♄		♀		♁	♁	♁		♁	
♃	♁	♄		♁		♁		♂		♃	
♃	♁	♄		♄		♃		♁		♁	
♁		♂		♃			♁			♁	
♃		♁		♁		♃	☽	♃		♄	
♄		♁		♁		♁	♁	♁		♁	
	♃		☽		♅	♁		♂	♄	♁	♄
♂	♁	♄		♀		♃		♁		♄	
♁	♃	♅		♀		♁	♁	♁		♄	
♄	♁	♄		♁			♄		♃	☽	♃
♃	♁	♄		♄		♁	♁	♁		♁	
♁		♂		♃		♃		♁		♁	
♃		♁		♁		♁	♁	♁		♁	
♄		♁		♁			♃		♁	♁	♁
	♀		♂	♁	♄	♁		♂		♃	
♁	♃	♅		♀		♃		♁		♁	
♄	♁	♄		♁		♁	♁	♁		♄	
♃	♁	♄		♄			♃		♁	☽	♂
♁	♃	♅		♁		♃		♁		♁	
♃	♁	♄		♄		♁	♁	♁		♁	
♁		♂		♃			♁		♃		♁
♃		♁		♁		♁	♁	♁		♁	
♄		♁		♁			♃			♁	

See page 34 for instructions. For Table of Essential Dignities, see Course VIII, p 45.

See Page 20 for instructions on how to use this Table.

**TABLE OF SIGN POWER AND
HOUSE POWER IN THE CHART OF
JOHN EDWARDS**

Aries	65.19
Taurus	34.20
Gemini	19.24
Cancer.	73.74
Leo	82.45
Virgo	60.42
Libra	74.15
Scorpio	110.78
Sagittarius	44.63
Capricorn	20.59
Aquarius	9.84
Pisces	138.43
First House	44.63
Second House	64.63
Third House	142.71
Fourth House	26.71
Fifth House	17.10
Sixth House	17.10
Seventh House	80.56
Eighth House	94.88
Ninth House	60.42
Tenth House	74.15
Eleventh House	82.09
Twelfth House	28.68

**TABLE OF PLANETARY POWER IN THE
CHART OF JOHN EDWARDS**

Astrodynes		Astrodynes	
Sun	21.60	Saturn	41.18
Moon	24.83	Uranus	37.54
Mercury	38.48	Neptune	35.86
Venus	34.20	Pluto	61.32
Mars	53.41	M.C	57.05
Jupiter	41.19	Asc	24.03

Chapter 2

The Basis of Stellar Diagnosis

BECAUSE the astral body of man is composed of psychoplasm, organized into stellar-cells and stellar structures, which determine the condition of the cells and tissues of the physical body, a map of these stellar cells and structures, such as the birth-chart and progressed planetary positions afford, provides an unusually reliable method of diagnosis.

In so far as health, or well being in any department of life is concerned, disease is synonymous with discord and health is synonymous with harmony. Where harmony manifests there is ease, and therefore lack of disease. Ease, however, is neither synonymous with power or activity. Consequently, in determining the condition of the stellar-cells and stellar structures within any compartment of the astral body, we must consider the amount of their activity as well as whether or not they are composed of harmonious or discordant mental compounds.

In Matters of Physical Health All Twelve Zones Must Be Considered

—Unlike most departments of life, the mental factors of which, organized as stellar-cells and stellar structures, are confined chiefly to a single one of the twelve compartments within the astral body, no section of the whole astral body should be entirely neglected when considering physical health.

Certain compartments, to be sure, and certain centers of energy—dynamic stellar structures—are more important where physical health is concerned. But the astral body interpenetrates the physical body so completely, and its stellar-cells and stellar structures are so closely associated with the physical cells and physical tissues of the zones, as indicated by the zodiacal signs where mapped in the birth-chart, that every stellar cell and every stellar structure has some influence over the corresponding cell and tissue of the physical body.

In stellar diagnosis, therefore, as applied to the health of the physical body, all twelve zones, as mapped by the signs, should be scanned with the object in view of determining the power of the energy there located (preferably calculated in

astrodynes), and whether and to what extent that energy is harmonious or discordant (preferably calculated as so many harmodynes or discordynes).

Such zones of the astral body—head, lungs, heart, stomach, etc.—as map receiving set terminals, called also dynamic stellar structures, as shown by planets there located, require special consideration in matters of health, because even when the common thought-cells of the zone have little power, the thought-cells mapped by the terminals may be discordant enough to attract disease to that region.

No impossibility is involved in the changing of the type of stellar structure occupying any compartment of the astral body. Its psychoplasm and its cells have been built by states of consciousness that have a definite composition. And this composition can be altered by adding to them states of consciousness of an appropriate kind.

The birth-chart does not of necessity map the kind of stellar-cells and stellar structures within the astral body of an individual at any later period of life. It only maps, and very accurately, the mental composition of the astral body in great detail at the moment of birth. It shows what kind of stellar-cells and what kind of stellar organization occupied each compartment of the astral body at the time the individual was born.

But because the basic factors of character change so slowly, those stellar-cells and stellar structures that are weakest at birth usually remain so throughout life. In fact, they do remain weakest throughout life unless some unusual effort is made to give them a different composition. And very few people are sufficiently versed either in mental alchemy or in stellar healing to work intelligently to bring about such desirable changes.

Birth-Chart and Progressed Constants Should Be Determined Statistically

—As a general rule, then, from which the exceptions are so few as revealed by statistical study of thousands of birthcharts that they need no consideration in ordinary practice, the birth-chart correctly maps both the strong and healthy and the weak and defective stellar structures within the astral body. And the defective structures, discordantly compounded of mental factors, each according to its particular location and nature, represent a corresponding lack of balance or vigor in the physical tissues of the body where located.

Discordantly compounded stellar structures map those regions in the physical body which are particularly susceptible to disease.

From the birth-chart, therefore, can be determined, and quite reliably, the particular kind of disease to which any individual is predisposed.

Such determination is not a matter of theory but, when proper methods are followed, rests upon carefully collected and compiled statistics.

I am not in the least in favor of drawing conclusions from inference as to what astrological conditions in the birth-chart coincide with a tendency to some particular disease. Instead, I believe that the birth-charts of people who have actually suffered from a given disease should be collected. The more birth-charts covering the particular disease the better. But in our own research department we never consider that the report is fully finished until at least 100 birth-charts of persons suffering from the disease have been analyzed.

With such a list of birth-charts at hand, a comparative study invariably reveals certain astrological factors common to all of them. These factors stand out in such prominence that they afford a certain guide to the detection, from the birth-chart, whether or not there is a tendency to the disease in question.

When any birth-chart does not show these astrological factors, we may be sure that person will not have this particular disease. In any birth-chart which does show these astrological factors, we may be sure, even though the disease has not developed as yet, that there is a weakness which, were it given proper opportunity, would permit the expression of the disease.

It is also demonstrated by the collected statistics that the time when the disease develops coincides, according to the particular disease under consideration, with major progressed aspects to definite planets. Consequently, for the purpose of research work in establishing the astrological constants for any given disease, data are only valuable when the time of the person's birth, as well as the date, place and sex are known; and only when the date, at least approximately, when the illness became manifest also is known.

Thus the astrological basis of Stellar Diagnosis is that of statistically compiled reports, each report being confined to determining the birth-chart constants and the major progressed constants of the single specific disease or other condition. Conditions other than body diseases are mentioned because the predisposition to any type of condition or event can be diagnosed in the same manner. And the afflictions of any department of life are as amenable to stellar healing as are those of body diseases. In the reference book, WHEN AND WHAT EVENTS WILL HAPPEN, statistics based on 100 charts for each event indicate the progressed constants for 20 different events, and under the heading, Precautionary Actions, is given for each the type of thought energy which should be used as a mental antidote. This same type of energy is that which should be employed by the stellar healer to overcome the indicated difficulty, but in addition to applying the mental antidote he should also employ planetary energy of this type.

The stellar healer should have at hand reference volumes containing classified reports giving the statistical analysis of, and the birth-chart and progressed constants for, all the various diseases and ills of human life. The compilation of such volumes is a tremendous task. In the last 20 years we have mailed several hundred thousand blank forms soliciting the astrological information needed for this work. While the response to these appeals for astrological data has been quite liberal, there are so

many diseases that should be considered that of the body diseases thus far we have been able to get the full 100 data only for operations, typhoid fever, cancer, pneumonia, tuberculosis, appendicitis and infantile paralysis. The full reports on these seven diseases and on length of life, together with an explanation of endocrine reactions to planets and thoughts and some other material are embraced in the reference book, BODY DISEASE AND ITS STELLAR TREATMENT¹.

The Church of Light Astrological Research Department expects eventually to make statistical studies of each significant condition of life—such as the relation between two birth-charts that point to harmony in marriage to make statistical studies of vocations not embraced in the 30 analyzed in the reference book, HOW TO SELECT A VOCATION¹, to make statistical studies of events not embraced in the 20 analyzed in the reference book WHEN AND WHAT EVENTS WILL HAPPEN¹, and to make statistical studies on each significant disease not embraced in the reference book, BODY DISEASE AND ITS STELLAR TREATMENT¹. These studies will each be made on 100 charts, and the material handled in the manner it is presented in the above-mentioned reference books.

While as yet not able to publish a final report on more than the seven mentioned diseases, we do have enough data on hand covering some 160 different health difficulties that I feel justified in giving the preliminary findings relative to their birth-chart and progressed constants. Our preliminary reports on the seven diseases on which we now have the 100 data were correct in all the birth-chart and progressed constants listed. But when we had the 100 to analyze we found that in addition to the constants we had found with a limited number of charts, in each case there were additional constants not clearly revealed when only a few charts were at hand for analysis. I believe, therefore, that the constants given in this work for each disease will be found reliable, but that in most instances there will be additional constants discovered when we are able to analyze the charts of 100 persons who have suffered from the disease.

As professional healers will know the condition both by its technical name and its common name, and as this work will be read by many unfamiliar with the technical designation of diseases, the health difficulties will be here listed alphabetically under the general designation by which they are commonly recognized by the lay public.

The Electromagnetic Body Is Composed of Two Types of Energy

—The life of the body is electromagnetic. The positive, electrical energies are ruled by the Sun. On their power and harmony depend the vitality and the recuperative ability.

The negative, magnetic energies which nourish the constitution, and are essential in maintaining health, are ruled by the Moon. It is the interaction of the solar electrical energy with the lunar magnetic energy that provides the nerve currents and gives that which we call life to the physical body.

Vitality, recuperative power, and length of life, as shown by the analysis of 150 persons' charts who lived beyond 70 years, considered in BODY DISEASE AND ITS STELLAR TREATMENT, are dependent upon the power and harmony of the Sun in the chart of birth.

While the Moon governs the constitutional magnetism, it is only one factor, although the most important one, in gauging the strength or weakness of the constitution, and therefore whether or not the individual is readily attacked by disease. As indicated in the statistics relative to the individuals who lived more than 70 years, a powerful and harmonious Moon contributes markedly to length of life. It indicates ability of the constitution to resist disease.

The Moon, however, is only one factor in gauging the strength of the constitution. Every planet in the chart maps the state of activity of the most energetic thought-cells in its particular region of the astral body, maps where the most active group of this type is located, and by its harmony or discord (the number of harmodynes or discordynes) indicates the strength of the desires of the thought-cells there located for health or disease. Even the Sun, in addition to mapping the stellar-cells on whose activities and desires the vitality and recuperative power depends, also by its power and harmony or discord indicates the condition of the physical tissues in that region of the physical body and to what extent (as shown by the number of harmodynes or discordynes) the Sun stellar-cells work to attract health or the diseases characteristic of the Sun.

In determining the ability of the constitution to resist disease, therefore, the power and harmony or discord of every planet and sign must be taken into consideration.

Ability to survive does not depend solely on the strength and harmony of the vitality, or solely on the strength and harmony of the constitution. However weak and discordant the constitution, the individual, in spite of recurrent and serious illness, will recover and live to a good age if the Sun is powerful and harmonious enough. And however weak the vitality, the individual will have little illness while he does live if his constitution is powerful and harmonious, although he may not live to any great age.

The individual dies when, coincident with heavy discordant major progressed aspects, the constitution becomes too weak to enable the vital recuperative power of the Sun to counteract that weakness and discord. Maintaining life depends upon the relative power and harmony or discord of these two factors.

Next in importance to the dynamic thought structure which acts as the terminal for the reception of the vital force, mapped by the Sun, and the terminal for the reception of the magnetic force, mapped by the Moon, is the terminal mapped by Mercury. Mercury is truly the messenger. The electromagnetic energies which flow over the nerves are furnished by the Sun and Moon; but the vibratory rate to which these currents are tuned is determined chiefly by the thoughts and feelings of which the individual is objectively conscious. The thoughts and the nerve currents are ruled by Mercury.

Following Mercury in importance, in so far as health is concerned, is the Ascendant and the first house. Not only are the electromagnetic energies of the body grounded by the heavy line mapped by the Ascendant, but the thoughts relative to the physical body and personality gravitate to the first house astral compartment.

And the sixth house also is important because it maps the compartment of the astral body to which move the thoughts about illness.

The significance of the first house and the sixth house where illness is concerned will readily be recognized when it is realized that the statistical analysis of hundreds of charts progressed to the time of an illness shows that a serious illness of any kind practically never occurs except during those periods when there is a major progressed aspect to a ruler of the first and at the same time a major progressed aspect to a ruler of the sixth.

Rallying Forces Dominate Through Feeling

—But this does not signify that the discord chiefly responsible for the manifestation of the disease at the time was mapped by the aspect either to the ruler of the first or to the ruler of the sixth. On the contrary, the discord which enabled the disease to manifest frequently was not mapped by the sixth house or the first house. It commonly had its origin in some other compartments of the astral body.

But in order that the discordant energies, stirring pernicious thought compounds into activity and creating conflict among the thought-cells and tearing down thought structures, should be able to influence the physical health, some temporary stellar aerial had to give them access to both the compartment of the astral body governing the physical body and the compartment of the astral body governing illness.

These temporary stellar aeriels, mapped by progressed aspects to the ruler of the first or the Ascendant and the ruler of the sixth, may have been either harmonious or discordant. They may, or may not, have indicated the chief factor of discord at the time. But the statistics show that more frequently than not there was no aspect between the heavy progressed affliction at the time and either of these two compartments, or houses.

What really happened in most of these cases was that heavy discordant aspects formed which were not directly associated with either the first house or the sixth house. More frequently than not the Sun or Moon was involved in these powerfully discordant aspects. Thus the vitality or the magnetic nutriment was affected. But whether Sun or Moon was, or was not involved, in every case a discordant temporary stellar aerial was present, as indicated by a major progressed aspect, which picked up and radiated the energy of the planets corresponding to its terminals, in volume and in distressing discord.

This discordant planetary energy reaching the stellar-cells at the terminals of the aerials, stimulated these into destructive activity. And because of their power, these tended to communicate their discord to the nerve currents at these points.

If the individual permitted himself to be strongly influenced in his feelings by the astral discords of these compartments thus stimulated by discordant planetary energies, the dial of his consciousness—not a thought process but a feeling process—to the extent he thus permitted it, was thus turned so as to tune in on these discordant astral energies.

As he permitted himself to feel discord, his nervous system, through the electrical energies flowing over it, picked up planetary energies of this type and gave them free access to any stellar aerials that were present.

Electromagnetic energy is the only avenue by which astral energies can influence physical substance, and it is thus the natural conductor of planetary energies. But to be a conductor for any particular type of astral energy, it must have a corresponding vibratory rate. That is, it must be tuned in on the astral energy it transmits.

When the individual feels intensely, this feeling, if he occupies a physical body, is the recognition by his consciousness of electromagnetic vibrations of a particular type. Whatever he feels, to the extent it constitutes a dominant feeling, his electromagnetic body and nerve currents are tuned in on. And, which is a most important factor in stellar healing, he can, and does, tune in on any vibratory quality the feeling of which he can induce in himself. Through his thoughts he induces feeling. His feeling tunes him in on planetary vibrations of the type corresponding to this feeling. That is why Mercury, which rules cerebral activity and the nerves, has so much power over what conditions enter his life.

When the individual is tuned in on a particular planetary vibration, his nerve currents not only pick up this type of vibration from the astral energies reaching him from the planets, from character vibrations of objects, and from the thoughts of similar rate radiated by others, but these nerve currents also act as natural conductors for the astral energy of corresponding vibratory rate picked up by a temporary stellar aerial.

Thus if a powerful temporary stellar aerial is formed, as mapped by a powerful progressed aspect, and its vibrations are permitted to dominate the feelings, the nerve currents readily conduct its energy wherever they reach. And as they reach other temporary stellar aerials that are present at the same time, they enable the astral energy from the dominant temporary aerial to span the gap and travel over this other temporary aerial to its terminal. This weaker temporary aerial thus is not permitted to pick up its own type of energy unimpeded. Instead, under such circumstances, its own energy is dominated by these energies of another kind, which are called Rallying Forces.

Permanent aerials always have a pronounced influence upon the condition which develops. But a physical disease only develops, except when present from birth, when there is a major progressed aspect of some kind to both a ruler of the first house

and to a ruler of the sixth house. These temporary aeriads are necessary to carry the rallying forces present into those compartments having to do with health and disease.

Stellar Diagnosis

—The importance of the event any group of thought-cells is able to bring into the life depends upon their power. This applies to the diseases they attract as well as to other events. Even when little discord is present, the over-activity of a group of stellar-cells may throw the endocrine secretions and other functions out of balance and encourage disease. Thus a powerful Saturn trine Moon gives a predisposition toward ear trouble; but the difficulty is apt to be much less severe than when Saturn is square Moon. A powerful Mars trine or sextile Moon gives a predisposition toward eye difficulty; but the difficulty is apt to be much less severe than when Mars is opposition Moon.

The predisposition toward specific disease can only be ascertained from statistically determined birthchart and progressed constants of these diseases. These constants are found to relate to the power of certain planets, in certain instances relate to aspects between certain planets, and often depend upon these planets being highly discordant. While the signs usually indicate the zones afflicted by the disease, otherwise they are seldom significant as constants. Each planet, however, as will be indicated in a subsequent lesson, rules certain glands and organs of the body, and when unduly active or highly discordant tends toward diseases of its own special type.

The general rule is that the most discordant planet (the one having the most discordynes) in the chart indicates the predisposition which is most likely to develop into its characteristic disease and, other things being equal, the most discordant sign (the one having the most discordynes) in the chart represents the region most likely to be affected by disease. The second most discordant planet represents the next most likely predisposition to disease, and the next most discordant sign represents the next most likely region to be affected by disease, and so on.

While calculating its astrodynes is the most precise way of judging a planet's power, the flat-rate method used in finding the birth-chart constants considers that when a planet receives very powerful aspects, especially if a heavy aspect is not more than one degree from perfect, it must be considered powerful irrespective of not being in an angle or aspecting Sun, Moon or Mercury. But such power constitutes an exception to the general rule that only such planets in a birth-chart as are in an angle, or which aspect Sun, Moon or Mercury with a reasonable degree of closeness, are to be considered powerful.

In addition to the heavy discords indicating the predisposition toward specific types of disease, in considering the general tendency toward health difficulties these five factors also should receive special attention in this order of importance:

1. The Sun as ruling the vitality.
2. The Moon as ruling the magnetic constitution.
3. Mercury as ruling the objective thoughts.
4. The Ascendant and First House as representing the physical body.
5. The Sixth House as representing the zone of least resistance.

At the time some disease does develop, not only are there major progressed aspects to a ruler of the first and a ruler of the sixth, but also to the planets which constitute the progressed constants of the disease. Thus from the progressed constants can be determined which one of the birth-chart predispositions has been given the additional planetary energy to enable it to attract its type of disease.

In such stellar diagnosis physical symptoms and the contribution to the disease made by physical environment should also be given due weight; for thought-cell activity can develop certain diseases only when specific physical agents are present. Events, including illness, take place when the resistance of the environment to the specific event is not too great to be overcome by the extra-physical power of the thought-cells which are working to bring this event to pass.

Calculating the Power of Signs and Houses

—After the total power of each planet, the M.C. and Asc. have been calculated in a chart, it is a very simple matter from the number of astrodynes so found also to calculate the power of each sign and house in the chart.

The Power of a Birth-Chart Sign

—Rule: Unless it is an intercepted sign, or occupies more than one house, the unoccupied power of a sign is one-half the power of its ruler. The unoccupied power of an intercepted sign is one-fourth the power of its ruler. When a sign occupies the cusp of more than one house, its unoccupied power is ascertained by allowing one-half the power of its ruler for each house cusp it occupies. The total power of a sign is ascertained by adding its unoccupied power to the total power of each planet—including M.C. or Asc.—in the sign.

The Power of a Birth-Chart House

—**Rule:** To the unoccupied power of the sign on the cusp of the house, add the unoccupied power of any intercepted sign in the house and the total power of all planets—including M.C. or Asc.—in the house.

Double Rulership Signs

—Scorpio is ruled by both Pluto and Mars. Aquarius is ruled by both Uranus and Saturn. Pisces is ruled by both Neptune and Jupiter.

Rule: When a sign has two rulers, add the total power of both rulers and divide the sum by 2. The result will then be the power (in reality the average power of the two rulers) of the ruler of the sign.

It is a great saving in work to calculate the power of each sign and house of a chart at the same time. We will now apply the rules in this manner to the chart of John Edwards, which is given on page 4 of lesson No. 197. The power of each planet in his chart, calculated according to the rules given in lesson No. 197, is given in a table on page 34 of this lesson.

Sagittarius is on the Asc. Jupiter, its ruler, has 41.19 astrodynes. Dividing 41.19 by 2 gives the power of the unoccupied sign as 20.60 astrodynes. The Asc. has 24.03 astrodynes. 20.60 plus 24.03 gives the power of Sagittarius as 44.63 astrodynes. As there is no planet in the first house, the power of the first house is also 44.63 astrodynes.

Capricorn is on the cusp of the second house. Saturn, its ruler, has 41.18 astrodynes. Dividing 41.18 by 2 gives the power of Capricorn as 20.59 astrodynes.

Aquarius, having 2 rulers, is intercepted in the second house. Saturn, one ruler, has 41.18 astrodynes. Uranus, the other ruler, has 37.54 astrodynes. 41.18 plus 37.54 gives 78.72. 78.72 divided by 8 (one-fourth the average power as the sign is intercepted) gives the power of Aquarius as 9.84 astrodynes.

Venus, in the second house, has 34.20 astrodynes. 20.59 (Capricorn) plus 9.84 (Aquarius) plus 34.20 gives the power of the second house as 64.63 astrodynes.

Pisces, on the cusp of the third house, has 2 rulers. Neptune, one ruler, has 35.86 astrodynes. Jupiter, the other ruler, has 41.19 astrodynes. 35.86 plus 41.19 gives 77.05. Dividing 77.05 by 4 (one-half the average power) gives the unoccupied power of Pisces as 19.26 astrodynes.

Pisces holds 4 planets: Venus with 34.20 astrodynes, Uranus, with 37.54 astrodynes, Moon with 24.83 astrodynes, and Sun with 21.60 astrodynes. 19.26 (unoccupied Pisces) plus 34.20 plus 37.54 plus 25.83 plus 21.60 gives the power of Pisces as 138.43 astrodynes.

The third house holds 4 planets: Uranus with 37.54 astrodynes, Moon with 24.83 astrodynes, Sun with 21.60 astrodynes, and Mercury with 38.48 astrodynes. 19.26 (unoccupied Pisces) plus 37.54 plus 25.83 plus 21.60 plus 38.48 gives the power of the third house as 142.71 astrodynes.

Aries is on the cusp of the fourth house. Mars, its ruler, has 53.41 astrodynes. Dividing 53.41 by 2 gives the unoccupied power of Aries as 26.71 astrodynes. As no planet is in the fourth the power of the fourth house is also 26.71 astrodynes.

Mercury, in Aries, has 38.48 astrodynes. 26.71 (unoccupied Aries) plus 38.48 gives the power of Aries as 65.19 astrodynes.

Taurus is on the cusp of the fifth house and also on the cusp of the sixth house. Venus, its ruler, has 34.20 astrodynes. Dividing 34.20 by 2 gives the power of the fifth house as 17.10 astrodynes, and the power of the sixth house also as 17.10 astrodynes.

As Taurus occupies 2 house cusps, it has double the power of one of these unoccupied houses, or the full power of Venus. The power of Taurus is thus 34.20 astrodynes.

Gemini is on the cusp of the seventh house. Mercury, its ruler, has 38.48 astrodynes. Dividing 38.48 by 2 gives the power of Gemini as 19.24 astrodynes.

Pluto, in the seventh house, has 61.32 astrodynes. 19.24 (Gemini) plus 61.32 gives the power of the seventh house as 80.56 astrodynes.

Cancer is on the cusp of the eighth house. The Moon, its ruler, has 24.83 astrodynes. Dividing 24.83 by 2 gives the power of unoccupied Cancer as 12.42 astrodynes. Pluto, in Cancer, has 60.32 astrodynes. 12.42 (unoccupied Cancer) plus 61.32 gives the power of Cancer as 73.74 astrodynes.

Leo is intercepted in the eighth house. The Sun, its ruler, has 21.60 astrodynes. Dividing 21.60 by 4 (because intercepted) gives the unoccupied power of Leo as 5.40 astrodynes. Leo holds 2 planets, Jupiter with 41.19 astrodynes, and Neptune with 35.86 astrodynes. 5.40 (unoccupied Leo) plus 41.19 plus 35.86 gives the power of Leo as 82.45 astrodynes.

12.42 (unoccupied Cancer) plus 82.46 (intercepted Leo and the planets it holds) gives the power of the eighth house as 94.88 astrodynes.

Virgo is on the cusp of the ninth house. Mercury, its ruler? has 38.48 astrodynes. Dividing 38.48 by 2 gives the unoccupied power of Virgo as 19.24 astrodynes. Saturn, in Virgo, has 41.18 astrodynes. 19.24 (unoccupied Virgo) plus 41.18 gives the power of Virgo as 60.42 astrodynes. As Saturn is the only planet in the ninth, the power of the ninth house is also 60.42 astrodynes.

Libra is on the cusp of the tenth house. Venus, its ruler, has 34.20 astrodynes. Dividing 34.20 by 2 gives the unoccupied power of Libra as 17.10 astrodynes. The M.C., in Libra, has 57.05 astrodynes. 17.10 (unoccupied Libra) plus 57.05 gives the power of Libra as 74.15 astrodynes. As there is no planet in the tenth, this gives the power of the tenth house also as 74.15 astrodynes.

The cusp of the eleventh house and the cusp of the twelfth house are both occupied by Scorpio. Scorpio has two rulers. Mars, one ruler, has 53.41 astrodynes. Pluto, the other ruler, has 61.32 astrodynes. 53.41 plus 61.32 gives 114.73 Dividing 114.73 by

4 (one-half the average power) gives the unoccupied power of Scorpio on each house cusp as 28.68 astrodynes. As there is no planet in the twelfth house, the power of the twelfth house is thus 28.68 astrodynes.

Mars, in the eleventh house, has 53.41 astrodynes. 28.68 (Scorpio on its cusp) plus 53.41 gives the power of the eleventh house as 82.09 astrodynes.

Dividing 114.73 by 2 (to get the average power of Mars and Pluto) gives the unoccupied power of Scorpio (occupying 2 house cusps) as 57.37 astrodynes. Mars, in Scorpio, has 53.41 astrodynes. 57.37 (unoccupied Scorpio) plus 53.41 gives the power of Scorpio as 110.78 astrodynes.

Harmodynes and Discordynes

—From what has already been said in relation to the most discordant planet in the chart indicating the type of disease toward which an individual is most predisposed, and the further observation that in general the tendency for the disease so indicated to develop is proportional to the amount of discord added to its birthchart constants by progressed aspects, it will be recognized that in stellar diagnosis it is important to have as precise a method as possible for measuring both birth-chart and progressed discord.

Including illness, the events and conditions of life are commonly appraised from two different points of view; their importance and their benefit or detriment. Their importance in the life is indicated by the power in the birth-chart or progressed chart, or both, of the aspect, planet, sign or house relating to them. Their fortune or misfortune, on the other hand, is indicated by the harmony or discord in the birth-chart or progressed chart, or both, of the aspect, planet, sign or house relating to them.

And even as there are various instances in which, to ascertain the probable importance of an indicated event or condition, it is better to use the more precise method of measurement by determining the number of astrodynes involved, rather than to employ the flat-rate method of inspection, so also in determining the fortune or misfortune of an indicated event or condition, there are many instances in which it is better to discard the flat-rate method of inspection and employ the more precise method of ascertaining the number of harmodynes or discordynes involved.

Inspection will indicate that a given aspect in a chart is harmonious or discordant. But as such harmony or discord indicates that the activities of the house or houses ruled by one of the planets will influence for good or ill the activities of the house or houses ruled by the other planet, it often is desirable to ascertain just HOW MUCH benefit or detriment is indicated by the aspect. For this purpose it is advantageous to learn how many harmodynes or how many discordynes are represented by the aspect.

There are still more instances in which it is valuable to know HOW MUCH harmony or discord a planet in the chart has. Ability is not the only factor in gaining success. As pointed out in the analysis of the thirty different vocations included in the reference book, HOW TO SELECT A VOCATION¹, the harmony or discord of the planets ruling the things with which the individual must associate in his business seem equally important. This luck factor can be gauged far more precisely when the number of harmodynes or discordynes carried by each planet in the chart of birth are known than they can by the flat-rate method of inspection.

As revealed by statistical analysis in the reference book, WHEN AND WHAT EVENTS WILL HAPPEN¹, certain events—such as acquiring money, getting employment, and benefiting through friends, as well as length of life (analyzed in the reference book, BODY DISEASE AND ITS STELLAR TREATMENT¹)—occur more advantageously in the lives of those who have the planets ruling given houses harmonious and more often when there is a harmonious progressed aspect to such a planet; and certain other events—such as accidents, loss of money, loss of employment, divorce and death of offspring—occur more often in the lives of those who have the planets ruling certain houses discordant, and more often at those times when such a planet receives a discordant progressed aspect. And, as these events largely depend upon the amount of harmony or discord shown by the significant planet, it is highly advantageous to know not merely that the planet is harmonious or discordant but how many harmodynes or discordynes the planet carries.

Statistical analysis of thousands of charts also shows that the most significant factor in disease is discord. The unusual power of some planet may indicate some predisposition toward its type of disease; but the predisposition increases in direct ratio to the discord of the planet. It is advantageous, therefore, to know just how many discordynes such a planet carries.

How much the things—including names, numbers, gems, home location, etc.—with which closely associated influence the life of an individual is determined by the power of the signs ruling them in his chart. But how much they influence him to his benefit is indicated by the number of harmodynes of these signs in his birth-chart and progressed chart. And how much they influence him to his detriment is indicated by the number of discordynes of these signs in his birth-chart and progressed chart. It is well, therefore, to have as precise a measure as possible of such harmony or discord.

How active a given department of life is may be gauged by its power. But whether that department of life will be fortunate or unfortunate must be gauged by its harmony or discord. How harmonious, or how discordant, indicates whether an individual should follow a business which requires the activity of the given house, whether he should cultivate such activities, or whether he should shun them. And it is better to use the precise method of ascertaining the number of harmodynes or discordynes of the house than to rely on the flat-rate method of inspection.

The zones of the body affected by disease are indicated by the zodiacal signs. Power has some influence, but as a general rule the more discordant the sign in the chart of

birth the more apt it is to be the region attacked by disease. In stellar diagnosis we select the heaviest afflictions as indicating the types of disease toward which there is a predisposition—the one having the most discordynes indicating the type of disease toward which there is most predisposition—and the sign having the most discordynes as the region, other things being equal, most likely to be attacked. In stellar diagnosis, therefore, it is especially desirable to use a more precise method of gauging both birth-chart and progressed harmony and discord than the flat-rate method of inspection.

There are three things which may influence a planet's harmony or discord: 1.) Signs. 2.) The nature of the planets making the aspect. 3.) The nature of the aspect between two planets.

1.) The essential dignity of a planet contributes to its harmony or discord. On page 36 of this lesson will be found a table of essential dignities. On page 20 will be found a table of essential dignity values.

2.) Saturn is the major malefic and Jupiter is the major benefic. When Saturn is involved in an aspect, one-half its power is made discordant by its nature alone. When Jupiter is involved in an aspect, one-half its power is made harmonious by its nature alone.

When Mars is involved in an aspect, one-fourth its power is made discordant by its nature alone. When Venus is involved in an aspect, one-fourth its power is made harmonious by its nature alone.

This influence of the malefics and benefics applies to the three neutral aspects—conjunction, inconjunct and parallel—as well as to the three harmonious and four discordant aspects.

3.) The three harmonious aspects are: trine, sextile, semi-sextile. The power of the three harmonious aspects expressed as astrodynes is equivalent to the same number of harmodynes, written with a plus sign before the number expressing the power.

The four discordant aspects are: opposition, square, sesqui-square, semi-square. The power of each of the four discordant aspects expressed as astrodynes is equivalent to the same number of discordynes, written with a minus sign before the number expressing the power.

The three neutral aspects are: conjunction, inconjunct, parallel. The M.C., Asc., Pluto, Neptune, Uranus, Sun, Moon and Mercury are considered neutral when their essential nature is uninfluenced by harmonious or discordant aspect. Unless Saturn, Jupiter, Mars or Venus is involved in the aspect, the neutral aspects increase the power of the planet, but do not influence its harmony or discord. Power which is neither harmonious nor discordant is considered neutral. It increases the amount of work the thought-cells possessing it can do, adding to the importance of the events or conditions attracted, but adding nothing to, and subtracting nothing from, the fortune or misfortune of that which is attracted.

Rule: To ascertain the number of harmodynes or discordynes expressed by a planet, add together the harmodynes expressed by each aspect the planet makes, the MR (mutual reception) and its plus dignity. Add together the discordynes expressed by each aspect the planet makes, and its minus dignity. Then add the two sums algebraically—subtracting the smaller number from the greater. The remainder with a plus before it will be the net total harmodynes of the planet, or with a minus before it will be the net total discordynes of the planet.

When calculating the power of the planets in the chart it is convenient for the work which follows to make a grill showing the power of each aspect made by a planet, and placing before the number of astrodynes thus indicated the symbol of the aspect. Such a POWER GRILL for the chart of John Edwards will be found on page 67 of lesson No. 199.

Then in calculating the harmony of each planet in the chart it is well to make another somewhat similar grill in which each aspect expressing harmodynes or discordynes is noted under its planetary heading followed by the number of harmodynes or discordynes; these indicated by a plus or a minus before the number expressing them. There should be also a column showing the harmodynes or discordynes of each planet due to dignity, a column for the total harmodynes of each planet, a column for the total discordynes of each planet, and a final column in which the net total harmodynes or discordynes of each planet are listed. Neutral aspects between neutral planets are ignored in such calculations and are not listed in the Harmony Grill. Such a HARMONY GRILL for the chart of John Edwards will be found on page 40 of this book.

Chapter 3

Serial No. 199
Original Copyright 1947
Elbert Benjamine

Copyright
August 2002
Church of Light

The Principles of Stellar Healing

TABLE OF ESSENTIAL DIGNITY VALUES

Mutual Reception (MR)	5 harmodynes
Degree of Exaltation	4 harmodynes
Degree of Fall	4 discordynes
Exaltation	3 harmodynes
Fall	3 discordynes
Home	2 harmodynes
Detriment	2 discordynes
Harmony	1 harmodyne
Inharmony	1 discordyne

	☉	☽	♀	♂	♄	♃	♅	♁	♂	♁	M.C.	ASC.	HOUSE POSITION	TOTAL POWER
☉			♂ 9.03							♁ 2.73	♂ 2.20		7.64	21.60
☽				Δ 3.50		♂ 4.25	♁ 0.70			Δ 2.17	♁ 0.20	♁ 6.17	7.84	24.83
♀			♂ 1.57							♁ 4.70	♁ 4.17		7.61	38.48
♂				♁ 7.83		♂ 4.05	♁ 7.60			Δ 5.13			8.02	34.20
♄					♁ 7.52	♂ 3.75	Δ 2.20	♁ 7.98	Δ 6.67	♂ 2.20			11.76	53.41
♃					♂ 0.23			♁ 9.50	♂ 0.15	♂ 6.68	Δ 1.18		10.53	41.19
♅						♁ 7.07	♁ 4.45			♂ 5.92	♂ 1.55		9.91	41.18
♁										Δ 7.53			7.99	37.54
♂											♂ 6.18	Δ 1.68	10.52	35.86
♁											♁ 7.47		13.45	61.32
M.C.													15.00	57.05
ASC.													15.00	24.03
													TOTAL	470.69

Chapter 3

The Principles of Stellar Healing

FROM what has been said relative to stellar anatomy and stellar diagnosis it should be apparent that, whether or not their practitioners recognize it, the success of all non-physical methods of treatment—including Metaphysical healing, New Thought healing, Christian Truth healing, Mental healing, Divine healing and Yoga healing—depends upon altering the composition, the activity or the organization of the thought-cells within the astral form. As the thought-cell organization of the finer forms constitutes the soul, which is identical with that which the material scientists call the unconscious mind or the subconscious mind, that which is attempted by each of these methods is soul healing. Each and every one of these processes by which the soul is beneficially changed, therefore, can properly be termed a method of THOUGHT-CELL TREATMENT.

The general principle involved in the mentioned methods of soul healing is to bring about thought-cell and thought structure changes by prayer, affirmation, suggestion, or other means of directing thoughts to the accomplishment of the healing process. In stellar healing also, thoughts are directed to the healing of the soul. But it embraces three valuable factors not employed in other methods of healing by non-physical means.

1. Before healing is attempted, stellar diagnosis is employed to determine exactly which thought-cells and thought-cell structures are chiefly responsible for the physical disease. While a general health treatment- commonly also is employed, in addition thoughts and other energies selected are then directed to the specific groups of thought-cells needing to be altered to bring about the healing.
2. The thoughts and other energies thus utilized are not general in nature, but are carefully selected to provide antidotes or a type of energy specifically adapted best to change the discord of the inharmonious thought-cells and thought structures needing treatment into the harmonious state which will bring health.
3. As planetary energies of specific progressed aspects always contribute discord or intensity, or both, to the thought-cell activity before these have the power and discord necessary to attract disease, other planetary energies selected specifically to give these same thought-cells harmonious activity—even as a harmonious progressed aspect would do—are employed by the stellar healer to reinforce the thoughts he uses in the soul healing process.

Even as the physical cells and organs of the material body have intelligence and know how to perform definite functions, so also the stellar-cells and stellar structures within the soul are intelligent, perform functions, and have desires which are not under the direct supervision of objective consciousness. Their intelligence is limited, but they know how to perform certain types of work, and how to exercise extra-physical power to bring about the physical events they desire. This extra-physical power by which the stellar-cells attract not only health or disease, but influence also all other events that enter the life, is the same as that now recognized in our universities as the Psychokinetic Effect.

We are justified, I believe, in considering man's physical body, his inner-plane form as mapped by his birth-chart, and his thoughts as different parts of himself. He exists in, and is influenced by, two different environments. The physical world, including the people and objects he contacts and the food he eats, embraces the outer world environment. Astrological energies, other people's thoughts, the astral radiations of objects both of the outer and the inner plane, and the influence of the spirits of the dead and the denizens of the astral world constitute the inner world environment.

And in so far as a great amount of research conducted by the three research departments of The Church of Light has been able to reveal, the inner world environment on an average has just about as much influence over the individual and what happens to him as does the outer world environment. The people and the conditions he meets in the outer world environment stimulate certain thoughts and emotions, and the astrological and other energies he contacts in the inner world also stimulate certain thoughts and emotions. These thoughts and emotions, regardless of the source of their stimulation, influence the desires of his thought-cells and thus powerfully affect the events that come into his life.

His thought-cells bring events into his life such as they desire (including disease or health) through influencing his behavior, and through bringing extra-physical pressure to bear upon his physical organism and his physical environment. From our studies of the manner in which progressed aspects coincide with characteristic events, we are warranted in concluding that on an average the events which come into the individual's life are about equally due to his physical behavior and to the pressure which, unknown to him, his thought-cells, working from the inner plane, bring to bear upon his environment.

Knowledge of how both environments affect man, and of the intelligence, nature and power of the stellar-cells leads the stellar healer to four important conclusions:

1. Not only the diseases of the physical body, but all the ills which beset human life can be successfully treated by the methods of stellar healing.
2. In such treatment, if it is to prove successful, the desires of the thought-cells must be so changed that they will desire, and therefore work for, the things which the individual also desires.

3. The thought-cells desiring the things which the individual also desires, must possess or be given enough energy that their extra-physical power is sufficient to bring whatever change in the physical body or the physical environment is necessary to complete the healing.

4. The greater the facilities afforded the thought-cells by the physical environment, the less extra-physical power they will need to complete the healing.

Chapter four of the reference book, *PROGRESSED ASPECTS OF STANDARD ASTROLOGY*¹, is devoted to explaining and illustrating the fact that what takes place in the individual's life at any given time is the product of the facilities of physical environment and the pressure brought to bear upon the physical environment by the stellar-cells. The greater the resistance offered by physical environment to the events and conditions the thought-cells desire, the more power the thought-cells must have to be able to bring these events and conditions into the individual's life. The stellar-cells desiring—because their own discords make them feel so miserable—destruction of the physical body or some part of it, need have only the additional energy afforded by a weak progressed aspect to cause the body to be attacked by disease if facilities for the disease are sufficiently present in the environment. Lack of vitamins in the food, over-abundance of proteins or starch in the food, mineral-poor foods, contact with virulent bacteria or viruses, and exposure to wet and cold, lower the resistance of the environment to the pressure of the disease-seeking stellar-cells.

On the other hand, even the most powerful discordant progressed aspect may be unable to give the disease-seeking stellar-cells enough activity to overcome the resistance offered them by the physical body if the foods are employed as *PRECAUTIONARY ACTIONS* which are recommended for the particular progressed planetary affliction in the five B. of L. lessons on *STELLAR DIETETICS*: Nos. 153, 222, 223, 224 and 225.

Yet in spite of any possible diet, and in spite of any probable facilities for health afforded by the most favorable physical environment, if the individual reinforces the disease-seeking stellar-cells by powerful discordant thoughts during the time they receive energy from either a weak or a powerful progressed aspect, they may gain activity enough that they can overcome such resistance, and the individual will become ill. Health or disease, or other material condition, is not dependent exclusively upon thought-cell activity as influenced by thinking and planetary energies, nor is it dependent exclusively upon physical behavior and physical environment. It is dependent upon the reaction between thought-cell activity and physical conditions. Physical remedies, therefore, if properly selected and applied, may play an important part in the healing process. Let those who teach otherwise go without food and water for a few weeks, or without air for as little as ten minutes.

The Use of Astrological Energies in Healing

—Not only is the power and harmony or discord of each type of thought-cell activity within the finer form mapped by the planets in the chart of birth, but a progressed aspect to a planetary terminal in the birth-chart or progressed chart adds energy to and increases the activity of, the thought-cells mapped by the terminals involved in the progressed aspect. The commencement of any disease not present at birth always coincides with one or more progressed aspect which is characteristic, and provides the progressed constants of, the disease. Other and usually more harmonious progressed aspects give thought-cell activity which works to attract health.

Some 3,300 years ago our good brother, Akhenaten of Egypt—as explained in detail in chapter one of the reference book, *ASTROLOGICAL LORE OF ALL AGES*—developed a method by which a stellar healer could deliver to the selected group of thought-cells of a patient, harmonious planetary energy of the type desired and in a manner which would produce the same change and activity of the thought-cells as would be induced by a harmonious progressed aspect from the planet.

He had found that the inner plane and the outer plane can influence each other only through Boundary-Line electromagnetic energy, and that the electromagnetic energy of the body is a natural conductor of planetary and other inner-plane energies which at the time are tuned to a corresponding frequency. And he had found that it is possible to tune the nerve currents, which we now know to be electromagnetic, to the decave of electromagnetic vibration corresponding to the astral vibration of any selected planetary energy, and thus direct the planetary energy along with the electromagnetic energy of corresponding vibration, through the hands to the zone of the body to be healed.

Organic electromagnetic energy, in the West commonly called animal magnetism, and in the East commonly called prana, is the natural conductor of astral energy. As water is a ready conductor of electricity, so the electromagnetic nerve currents are ready conductors of astral vibrations, with this difference, that the electromagnetic currents moving over the nerves pick up and most readily conduct astral energies which, although perhaps of a higher decave, have a similar vibratory rate.

It is because the thought-cells mapped by Sun, Moon and Mercury have such ready access to, and so powerfully influence, the electromagnetic form and the nerve currents that these three planets are so significant in the birth-chart, and their thought-cells have more power than those mapped by some other planet similarly placed and having the same aspects. The Sun thought-cells rule and are in constant contact with the electrical energies of the body. The Moon thought-cells rule and are in constant contact with the magnetic energies of the body. The Mercury thought-cells rule and are in constant contact with the cerebral thoughts and the electromagnetic currents that move over the nervous system.

Because electromagnetic energy must be present to permit the thought-cells to reproduce their condition and to realize their desires in the physical cells and functions, and because electromagnetic energy in ample volume must be present if the physical cells and organs are to be healthy and strong, it is good practice for the stellar healer to give a general electromagnetic health treatment as a prelude to the specific treatment in which selected planetary energies are delivered to the thought-cells corresponding to the afflicted zones or organs.

After this general treatment designed to give vitality and health to the body as a whole, in which thoughts of perfect health are carried to the consciousness of the physical cells and organs by the electromagnetic energies delivered to them, the stellar healer gives the more special treatment in which the thoughts selected for this purpose are delivered to the thought-cell groups chiefly responsible for the disease along with the planetary energy most adapted to change their composition, organization and desires in the direction of health. To do this, through mood control he tunes his feelings, and thus the electromagnetic energies flowing over his nerves and from his fingers, to the vibratory rate of the planetary energy which he thus seeks to deliver to the thought-cells of his patient. Then he either places his hands over the zone where the planet is located which is the chief source of the difficulty, or better still, he places one hand over the zone and the other on the opposite side of the limb or body, so that the selected planetary energy will travel along the electromagnetic circuit thus established.

In addition to this direct method of reaching the thought-cells with the selected thought and planetary energy, the spine also should be treated by placing the hands close together along either side of the backbone where the nerves branch off which reach the zone or organ to be treated.

As chapter three of the reference book *BODY DISEASE AND ITS STELLAR TREATMENT*² considers in detail the endocrine reactions to planets and thoughts, and as the function of each endocrine gland and its planetary rulership and relation to diet are also set forth in the five lessons on *STELLAR DIETETICS*², endocrine secretions will merely be mentioned here in connection with the planetary energies to which each reacts. But both for diagnosis and treatment purposes the zones of the body ruled by each sign and the structure or organ ruled by each planet will here be recorded:

Sign Rulerships

ARIES rules the head and face, the upper jaw, and the cerebrum, or upper hemisphere of the brain.

TAURUS rules the neck, the ears, palate, tonsils, cerebellum, or lower lobes of the brain, the occipital region, larynx, pharynx, and vocal cords.

GEMINI rules the shoulders, arms, hands, bronchi and the lungs.

CANCER rules the lower part of the lungs, the breasts, the diaphragm and the stomach.

LEO rules the spine and back, and the heart.

VIRGO rules the abdominal and umbilical region, the duodenum and the intestines.

LIBRA rules the lumbar region, the kidneys, the ovaries, the seed, and the internal generative organs in general.

SCORPIO rules the sinus or pelvis of the kidneys, the ureters and bladder, the sigmoid flexure, rectum, prostate gland, uterus and external generative organs in general. The nose also seems to respond somewhat to the activities of Scorpio.

SAGITTARIUS rules the hips and thighs and the sciatic nerve.

CAPRICORN rules the region of the knees.

AQUARIUS rules the legs below the knees, and the ankles.

PISCES rules the feet and toes.

Planetary Rulerships

SUN rules the vitality, influences the spleen where the vital electric energy is stored, and the heart which pumps the blood to the various parts of the body. It rules the spine and has a decided influence upon the action of two front pituitary hormones and the thyroid gland.

MOON rules the constitutional magnetism, influences the medulla oblongata and base of the brain where magnetic energy is stored, rules the fluidic and lymphatic system of the body, and has considerable influence over the eyes. It also has a decided influence upon the action of the back pituitary gland, the thymus gland, and the hormones of the alimentary tract.

MERCURY rules the brain and nervous system and has a determining effect upon the frequency of the electromagnetic vibrations of the body. It rules the nerve currents, the mouth and tongue, and also has a decided influence upon the action of the parathyroid glands and one hormone of the front pituitary gland.

VENUS rules the venous blood and the veins, skin and hair. It also has a decided influence upon the action of the thyroid gland and the gonad glands.

MARS rules the muscular system and the red corpuscles of the blood. It also has a decided influence upon the gonad glands and upon the secretion of both adrenalin and cortin by the adrenal glands.

As these are the chief chemicals with which the body fights toxic conditions and invasion by bacteria, an afflicted Mars predisposes to fevers, blood poison, abscesses, and various types of infection. The infection occurs because the body does not have at hand the chemicals with which it otherwise would oust the invaders.

Wounds, abrasions, cuts, tears, surgical operations, and hot, dry feverish complaints are typical of Mars afflictions. It tends to violence, and to acute and painful diseases.

JUPITER rules the arterial system of the body, the liver, and the fats and glycogen stored as fuel. It also has a decided influence upon the manufacture and secretion of insulin by the pancreas gland.

SATURN rules the bones and ligaments, the teeth, and the mineral salts of the body. It also has a decided influence upon the action of the adrenal glands in the manufacture and secretion of adrenalin, a decided influence over the spleen, and a decided influence over one hormone of the front pituitary gland.

As the spleen is the storage battery of the vital electric energy, an affliction to Saturn tends to a condition of the spleen in which it is unable to get and hold reserve energy. Saturn also tends to produce poverty in other essential things, such as lack of the proper elements in the food, lack of assimilative ability and, through inadequate adrenalin, lack of ability to draw on the emergency fuel supply.

Saturn is negative and subtle in its influence. It tends to the accumulation of toxins in the blood, and to various chronic and wasting diseases which persist because of lack of vigor and energy to remove their cause. Atrophy, tuberculosis, arthritis, and cancer are types of afflictions which are characteristic of Saturn.

URANUS, as the octave of Mercury, has considerable influence over the sensitiveness of the nervous system and the nerve currents which flow over it. Its action is to increase the potential and vibratory rate of the electrical energies generated by the nerves, encouraging high tension such as precedes cerebral hemorrhage or appendicitis. It also has a pronounced influence over the action of the parathyroid glands, and influences one hormone of the front pituitary gland.

NEPTUNE has very much the same influence over the action of the parathyroid glands that Mercury and Uranus do in giving sensitivity to the nervous system, and it influences the hormone of the pineal gland.

Its most pronounced influence on disease is through the negative condition it induces through the action of the pineal hormone to suppress and counteract the action of cortin. The excessive negative condition thus induced tends to the accumulation of toxins. Neptune is also the poisoner. And because it reduces the action of the typical Mars gland, so the poisons cannot be eliminated from the body, it favors the formation of pus, and moist wasting diseases. It tends to perversions, to the use of narcotics and opiates, and as closely associated with the astral plane, is responsible for certain maladies caused by astral entities, which when severe enough become obsessions.

PLUTO, while having the drastic quality and sometimes the forcefulness of the watery sign Scorpio, which it rules, in most respects may be considered as a higher octave expression of the Moon. It influences the hormone of the pineal gland, one hormone of the front pituitary—the one related to co-operative effort—the cortin hormone of the adrenal cortex, and secretions of the parathyroid glands. When its thought-cell activity increases the pineal secretion, rather than cortin, we have much the same negative condition and susceptibility to toxic poisons as are brought about by the influence of Neptune. Pluto also tends to a sensitiveness to people's thoughts and to the vibratory rates from the astral plane. Through its affinity with the eighth house rulership of Scorpio, it enables those on the inner plane of life to impress their thoughts in a recognizable form on the individual. These may be beneficial or they may be coercive and tend to irresponsible mediumship or obsession.

Where to Give Treatments Through the Nerves Leading From the Spine

—It is, of course, quite beyond the scope of these lessons to teach physical anatomy. There are, however, 31 pairs of spinal nerves, which take their origin in the spinal cord and make their exit from the vertebra.

When some portion of the body is diseased or not functioning as it should, quite commonly there is a sensitiveness, or cold area, where the nerves leading to this portion of the body enter the vertebra. And the chiropractic school of therapy, basing its treatment on adjustments of the vertebra, gives us a very clear picture of just where these nerves lead. And because the stellar healer, not to give adjustments but to administer planetary energy, needs this information, what follows is taken from Encyclopedia of Medical Astrology, by H. L. Cornell, M.D.:

The spinal column is made up of seven Cervical Vertebrae, twelve Dorsal Vertebrae, and five Lumbar Vertebrae. The Sacrum is classed as No. 25, and the Coccyx as No. 26. The count is made from the skull downward.

First Cervical—Atlas: The tissues and organs affected by the nerve supply passing through this vertebra are the brain, scalp, atlas, optic tract as far as the commissure, the cranial bones, the upper ear, ossicles, and the upper forehead.

Second Cervical—Axis: The nerves passing through this vertebra supply the brain, ears, a part of the face, and the back of the neck.

The third, fourth and fifth cervicals are called the Middle Cervical Place.

Third Cervical: The nerves which pass through the third cervical supply the retina, cheeks, nasal passages, and the face.

Fourth Cervical: Nerves passing through this vertebra pass to the eyes, cornea, retina, mouth, gums, teeth, bones and tissues of the face, the jaw, eustachian tubes, the outer ear, the posterior nares, nasopharynx, and the hyoid bone.

Fifth Cervical: The nerves which pass through this vertebra go to the face, nose, eyes, lower jaw and teeth, the hyoid bone, and to the lateral and posterior muscles of the neck.

The sixth and seventh cervicals are known as the Lower Cervical Place.

Sixth Cervical: Nerves passing through this vertebra supply the larynx, vocal cords and surrounding tissues, the thyroid gland, palate, posterior part of the mouth, tonsils, upper part of shoulders, anterior parts of the arms, lower parts of neck, sterno-mastoid region, and upper parts of the bronchi.

Seventh Cervical: The nerves passing through this vertebra go to the trachea (windpipe), radius, upper part of arms, muscles on back of neck, and to the deltoid muscles of the shoulders.

The seventh cervical and the first dorsal are called the Arm Place.

First Dorsal: The nerves which pass through this vertebra supply the muscles of the arms, the humerus, ulna, bones of the hands, the clavicle, scapula and shoulders, the first pair of ribs, the manubrium and the upper bronchi.

The second and third dorsals taken together are called the Heart Place.

Second Dorsal: Nerves passing through this vertebra supply the heart, its vessels and covering, the pericardium, the aorta, the bronchi, the second pair of ribs, hands, and muscles of the lower arms.

The third and fourth dorsals together are called the Lung Place.

Third Dorsal: Nerves passing through this vertebra supply the chest, breast, nipples, lower sternum, the third pair of ribs, lower heart, lungs and pleura.

Fourth Dorsal: The nerves passing through this vertebra have a wide field of activity, going to the lower lungs, fourth pair of ribs, the liver, gallbladder and bile duct.

The fourth and fifth dorsals are known as the Liver Place.

Fifth Dorsal: This dorsal is also called the Center Place. It is the general heart center, and the nerves passing through it supply the fifth pair of ribs.

The sixth, seventh and eighth dorsals are grouped as the Stomach Place.

Sixth Dorsal: The nerves passing through this vertebra reach the sixth pair of ribs and about the same region as given under the seventh dorsal vertebra.

Seventh Dorsal: The nerves passing through this vertebra reach the stomach, esophagus, mucus membrane of mouth and stomach, tonsils, uvula, pharynx, palate, seventh pair of ribs, omentum, eyeballs, pupils, iris and cornea of the eyes.

Eighth Dorsal: The nerve supply through this vertebra passes to the lower part of the stomach, the pylorus, duodenum, upper spleen, pancreas, diaphragm and eighth pair of ribs.

Ninth Dorsal: It is known as the Spleen Place, and the nerve supply passing through this vertebra goes to the spleen, omentum, duodenum, and the ninth pair of ribs.

Then tenth, eleventh and twelfth dorsals are called the Kidney Place.

Tenth Dorsal: The nerve supply passing through this vertebra goes to the upper kidneys, the suprarenal capsules, to the eyelids and to the tenth pair of ribs.

Eleventh Dorsal: The nerve supply passing through this vertebra goes to practically the same region as that through the tenth dorsal, and to the eleventh pair of ribs.

Twelfth Dorsal: The nerve supply passing through this vertebra goes to the lower portion of the kidneys, the ureters, the end of the spine, the twelfth pair of ribs, and rules the serous circulation.

The first and second lumbar are known as the Upper Private Place.

First Lumbar: The nerve supply through this vertebra passes to the ureters, loins, peritoneum and the upper small intestines.

The second and third lumbar are known as the Private Place.

Second Lumbar: The nerve supply passing through this vertebra goes to the small intestines, vermiform appendix, ovaries, cecum, peritoneum, and to the muscles of the legs.

Third Lumbar: The nerve supply passing through this vertebra goes to the abdominal muscles, lower small intestines, cecum, colon, appendix, hepatic and splenic flexures, ovaries, broad ligaments, bladder, testicles, sexual organs, anterior muscles of the thigh, and to the knees.

The fourth and fifth lumbar are known as the Lower Private Place.

Fourth Lumbar: The nerve supply passing through this vertebra goes to the womb, vagina, bladder, prostate gland, large intestines, colon, rectum, pelvis, hip bone, buttocks, femur, posterior thighs, tibia, fibula and the feet.

Fifth Lumbar: The nerve supply passing through this vertebra goes to the uterus, rectum and buttocks.

Sacrum: The nerve supply passing through the foramen of the sacrum goes to the womb, buttocks, posterior part of the thigh, and to the anus and rectum.

Calculating the Harmony or Discord of a Planet

—Now, following the rules given in lesson No. 198, let us calculate the harmony or discord of some of the planets in the John Edwards chart given on page 4 of this book (lesson No. 197). In these calculations reference should be made to the Table of Essential Dignity Values given on page 38 and the Power Grill given on page 39, of this lesson. This Power Grill shows the power of each aspect made by each planet calculated according to the rules given in lesson No. 197.

The Sun is in mutual reception with Jupiter which gives it 5 harmodynes, and is in mutual reception with Neptune, which gives it another 5 harmodynes. The Sun thus has 10.00 harmodynes. Sun conjunction Mercury is neutral. Sun square Pluto has 2.73 astrodynes, which gives the aspect 2.73 discordynes. Sun opposition M.C. has 2.20 astrodynes, which gives the aspect 2.20 discordynes. 2.73 plus 2.20 gives the Sun 4.93 discordynes. 10.00 (harmodynes) minus 4.93 (discordynes) gives the Sun a net total of 5.07 harmodynes.

The Moon is in its harmony, which gives it 1 harmodyne. Moon trine Mars has 3.50 astrodynes. Dividing 3.50 by 4 gives .88. 3.50 minus .88 gives the aspect 2.62 harmodynes. 1 plus 2.62 plus 2.17 gives the Moon 5.79 harmodynes. Moon opposition Saturn has 4.25 astrodynes. Dividing 4.25 by 2 gives 2.13. 4.25 plus 2.13 gives the aspect 6.38 discordynes. Moon square Asc. has 6.17 discordynes, which gives the aspect 6.17 discordynes. 6.38 plus 6.17 gives the Moon 12.55 discordynes. 12.55 (discordynes) minus 5.79 (harmodynes) gives the Moon a net total of 6.76 discordynes.

Mercury conjunction Sun is neutral. Mercury semi-sextile Venus has 1.57 harmodynes. Dividing 1.57 by 4 gives .39. 1.57 plus .39 gives the aspect 1.96 harmodynes. Mercury thus has 1.96 harmodynes. Mercury square Pluto has 4.70 astrodynes, which gives the aspect 4.70 discordynes. Mercury parallel M.C. is neutral. Mercury opposition M.C. has 4.17 astrodynes, which gives the aspect 4.17 discordynes. 4.70 plus 4.17 gives Mercury 8.87 discordynes. 8.87 (discordynes) minus 1.96 (harmodynes) gives Mercury a net total of 6.91 discordynes.

Venus is in its exaltation, which gives it 3 harmodynes. As previously calculated, its semi-sextile with Mercury has 1.96 harmodynes. Its parallel with Mars is neutral, as the one-fourth harmodynes due to Venus is canceled by the one-fourth discordynes due to Mars. Venus conjunction Uranus has 7.60 astrodynes. Dividing 7.60 by 4 gives the aspect 1.90 harmodynes. Venus trine Pluto has 5.13 astrodynes. Dividing 5.13 by 4 gives 1.28. 5.13 plus 1.28 gives the aspect 6.41 harmodynes. 3.00 plus 1.96 plus 1.90 plus 6.41 gives Venus 13.27 harmodynes. Venus opposition Saturn has 4.05 astrodynes. As one-half is added for Saturn discordynes, and one-fourth is subtracted for Venus harmodynes, the difference is one-fourth in discordynes. 4.05 divided by 4 gives 1.01. 4.05 plus 1.01 gives the aspect 5.06 discordynes. Thus

Venus has 5.06 discordynes. 13.27 (harmodynes) minus 5.06 (discordynes) gives Venus a net total of 8.21 harmodynes.

Mars is at home, which gives it 2 harmodynes. As previously calculated, its trine with the Moon has 2.62 harmodynes. Mars sextile Saturn has 3.75 astrodynes. Subtracting one-half for Saturn and one-fourth for Mars leaves only one-fourth as harmodynes. 3.75 divided by 4 gives the aspect $.94$ harmodynes. Mars trine Uranus has 2.20 astrodynes. Dividing 2.20 by 4 gives $.55$. 2.20 minus $.55$ gives the aspect 1.65 harmodynes. Mars trine Pluto has 6.67 astrodynes. Dividing 6.67 by 4 gives 1.67 . 6.67 minus 1.67 gives the aspect 5.00 harmodynes. Mars semi-sextile M.C. has 2.20 astrodynes. 2.20 divided by 4 gives $.55$. 2.20 minus $.55$ gives the aspect 1.65 harmodynes. 2.00 plus 2.62 plus $.94$ plus 1.65 plus 5.00 plus 1.65 gives Mars 13.86 harmodynes. Mars square Jupiter has 7.52 astrodynes. One-half subtracted for Jupiter and one fourth added for Mars is equivalent to one-fourth subtracted. 7.52 divided by 4 gives 1.88 . 7.52 minus 1.88 gives the aspect 5.64 discordynes. Mars square Neptune has 7.98 astrodynes. 7.98 divided by 4 gives 2.00 . 7.98 plus 2.00 gives the aspect 9.98 discordynes. 5.64 plus 9.98 gives Mars 15.62 discordynes. 15.62 (discordynes) minus 13.86 (harmodynes) gives Mars a net total of 1.76 discordynes.

Jupiter is in mutual reception with the Sun which gives it 5.00 harmodynes, and in mutual reception with Pluto which gives it another 5.00 harmodynes. Jupiter semi-sextile Saturn has $.23$ astrodynes. As the one-half added for Jupiter is subtracted for Saturn, this gives the aspect $.23$ harmodynes. Jupiter conjunction Neptune has 9.50 astrodynes. Dividing 9.50 by 2 gives the aspect 4.75 harmodynes. Jupiter parallel Pluto has 5.40 astrodynes. Dividing 5.40 by 2 gives the aspect 2.70 harmodynes. Jupiter semi-sextile Pluto has $.15$ astrodynes. Dividing $.15$ by 2 gives $.08$. $.15$ plus $.08$ gives the aspect $.23$ harmodynes. Jupiter sextile M.C. has 6.68 astrodynes. Dividing 6.68 by 2 gives 3.34 . 6.68 plus 3.34 gives the aspect 10.02 harmodynes. Jupiter trine Asc. has 1.18 astrodynes. Dividing 1.18 by 2 gives $.59$. 1.18 plus $.59$ gives the aspect 1.77 harmodynes. 5 plus 5 plus $.23$ plus 4.75 plus 2.70 plus $.23$ plus 10.02 plus 1.77 gives Jupiter 29.70 harmodynes. As previously calculated, Jupiter square Mars has 5.64 discordynes. Thus Jupiter has 5.64 discordynes. 29.70 (harmodynes) minus 5.64 (discordynes) gives Jupiter a net total of 24.06 harmodynes.

Saturn is in its harmony, which gives it 1 harmodyne. As previously calculated, Saturn sextile Mars has $.94$ harmodynes. As previously calculated Saturn semi-sextile Jupiter has $.23$ harmodynes. Saturn sextile Pluto has 5.92 astrodynes. 5.92 divided by 2 gives the aspect 2.96 harmodynes. Saturn semi-sextile M.C. has 1.55 astrodynes. 1.55 divided by 2 gives the aspect $.78$ harmodynes. 1.00 plus $.94$ plus $.23$ plus 2.96 plus $.78$ gives Saturn 5.91 harmodynes. As previously calculated, Saturn opposition Moon has 6.38 discordynes. As previously calculated, Saturn opposition Venus has 5.06 discordynes. Saturn parallel Uranus has 7.07 astrodynes.

7.07 divided by 2 gives the aspect 3.54 discordynes. Saturn opposition Uranus has 4.45 astrodynes. 4.45 divided by 2 gives 2.23. 4.45 plus 2.23 gives the aspect 6.68 discordynes. 6.38 plus 5.06 plus 3.54 plus 6.68 gives Saturn 21.66 discordynes. 21.66 (discordynes) minus 5.91 (harmodynes) gives Saturn a net total of 15.75 discordynes.

As the other aspects in the John Edwards chart have the same number of harmodynes or discordynes as they have astrodynes, a comparison of the Power Grill on page 39 with the Harmony Grill on page 40 will show how the harmony or discord of each of the others planets is obtained.

Calculating the Harmony or Discord of Each Sign and House

—The calculation of the harmony or discord of a sign in the birth-chart, or the harmony or discord of a given house, is a very simple matter once the net total harmony or discord of each planet has been computed in harmodynes or discordynes.

The Harmony or Discord of a Birth-Chart Sign

—**Rule:** Unless it is an intercepted sign, or occupies more than one house, the unoccupied harmony or discord of a sign is one-half the net harmony or net discord of its ruler. The unoccupied harmony or discord of an intercepted sign is one-fourth the net harmony or net discord of its ruler. When a sign occupies the cusp of more than one house, its unoccupied harmony or discord is ascertained by allowing one-half the harmony or discord of its ruler for each house cusp it occupies. The total harmony or discord of a sign is ascertained by algebraically adding its unoccupied harmony or discord to the harmony or discord of each planet—including M.C. or Asc.—in the sign.

The Harmony or Discord of a Birth-Chart House. —**Rule:** To the unoccupied harmony or discord of the sign on the cusp as influencing one house, algebraically add the unoccupied harmony or discord of any intercepted sign in the house and the net total harmony or discord of each planet—including M.C. or Asc.—in the house.

Double Rulership Signs

—Scorpio is ruled by both Pluto and Mars. Aquarius is ruled by both Uranus and Saturn. Pisces is ruled by both Neptune and Jupiter.

Rule: When a sign has two rulers, algebraically add the net total harmony or discord of both rulers and divide by 2. The result will be the harmony or discord (in reality the average harmony or discord of the two rulers) of the ruler of the sign.

As finding the harmony or discord of each sign and house is based upon the net harmony or discord of the planets, let us refer to the Planetary Harmony Grill on page 40 of this lesson to ascertain the total net harmony or net discord of each planet and proceed to calculate the harmony or discord of the signs and houses in the John Edwards chart. In so doing we will find it a great saving of work to calculate the harmony or discord of signs and houses at the same time.

Sagittarius is on the Asc. Jupiter, its ruler has 24.06 harmodynes. Dividing 24.06 by 2 gives unoccupied Sagittarius 12.03 harmodynes. The Asc. has 2.72 discordynes. 12.03 minus 2.72 gives Sagittarius 9.31 harmodynes. As no other planet is in the first house, the first house also has 9.31 harmodynes.

Saturn has 15.75 discordynes. Dividing 15.75 by 2 gives unoccupied Capricorn 7.88 discordynes. As no planet is in the sign, Capricorn has 7.88 discordynes.

Aquarius has 2 rulers. Saturn, one ruler, has 15.75 discordynes. Uranus, the other ruler, has .86 harmodynes. 15.75 minus .86 gives 14.89. 14.89 divided by 8 (one-fourth of average as Aquarius is intercepted) gives unoccupied Aquarius 1.86 discordynes. As no planet is in the sign, Aquarius has 1.86 discordynes.

Venus in the second house has 8.21 harmodynes. 7.88 (Capricorn) plus 1.86 (Aquarius) gives 9.74 discordynes. 9.74 minus 8.21 (Venus) gives the second house 1.53 discordynes.

Pisces has 2 rulers. Jupiter, one ruler, has 24.06 harmodynes. Neptune, the other ruler, has 7.63 harmodynes. 24.06 plus 7.63 gives 31.69. 31.69 divided by 4 (one-half average) gives unoccupied Pisces 7.92 harmodynes. Four planets are in Pisces. Venus has 8.21 harmodynes. Sun has 5.07 harmodynes. Uranus has .86 harmodynes. 7.92 (unoccupied Pisces) plus 8.21 plus 5.07 plus .86 gives 22.06 harmodynes. Moon has 6.76 discordynes. 22.06 minus 6.76 gives Pisces 15.30 harmodynes.

The third house has 4 planets. 7.92 (unoccupied Pisces) plus .86 (Uranus) plus 5.07 (Sun) gives 13.85 harmodynes. 6.76 (Moon) plus 6.91 (Mercury) gives 13.67 discordynes. 13.85 minus 13.67 gives the third house .18 harmodynes.

Mars has 1.76 discordynes. 1.76 divided by 2 gives unoccupied Aries .88 discordynes. As no planet is in the house, and Aries is on its cusp, this gives the fourth house .88 discordynes.

Mercury, in Aries, has 6.91 discordynes. 6.91 plus .88 (unoccupied Aries) gives Aries 7.79 discordynes.

Venus has 8.21 harmodynes. As Taurus holds no planet, but occupies 2 house cusps, it has the full value of Venus. It has 8.21 harmodynes.

The fifth and sixth houses hold no planets. Dividing 8.21 (Venus) by 2 gives the fifth house 4.11 harmodynes, and the sixth house also 4.11 harmodynes.

Mercury has 6.91 discordynes. Dividing 6.91 by 2 gives Gemini 3.46 discordynes.

Pluto, in the seventh, has 17.10 harmodynes. $17.10 - 3.46$ (Gemini) gives the seventh house 13.64 harmodynes.

The Moon has 6.76 discordynes. Dividing 6.76 by 2 gives unoccupied Cancer 3.38 discordynes. 17.10 (Pluto in Cancer) minus 3.38 gives Cancer 13.72 harmodynes.

The Sun has 5.07 harmodynes. Dividing 1.07 by 4 (as Leo is intercepted) gives unoccupied Leo 1.27 harmodynes. Jupiter and Neptune are in Leo. 1.27 (unoccupied Leo) plus 24.06 (Jupiter) plus 7.63 (Neptune) gives Leo 32.96 harmodynes.

32.96 (Leo) minus 3.38 (unoccupied Cancer, as Cancer is on its cusp) gives the eighth house 29.58 harmodynes.

Mercury has 6.91 discordynes. Dividing 6.91 by 2 gives unoccupied Virgo 3.46 discordynes. Saturn, in Virgo, has 15.75 discordynes. 3.46 (unoccupied Virgo) plus 15.75 (Saturn) gives Virgo 19.21 discordynes. As Virgo is on its cusp and Saturn the only planet in the house, this gives the ninth house also 19.21 discordynes.

Venus has 8.21 harmodynes. Dividing 8.21 by 2 gives unoccupied Libra 4.11 harmodynes. M.C. in Libra has 4.79 harmodynes. 4.11 (unoccupied Libra) plus 4.79 (M.C.) gives Libra 8.90 harmodynes. As Libra is on its cusp, and there is no other planet in the house, this gives the tenth house also 8.90 harmodynes.

Scorpio has 2 rulers. Mars, one ruler, has 1.76 discordynes. Pluto, the other ruler, has 17.10 harmodynes. $17.10 - 1.76$ gives 15.34 harmodynes. Dividing 15.34 by 4 (one-half average) gives unoccupied Scorpio 3.84 harmodynes for each house cusp it occupies. As no planet is in the twelfth, this gives the twelfth house 3.84 harmodynes.

Mars in the eleventh has 1.76 discordynes. 3.84 (Scorpio on its cusp) minus 1.76 (Mars) gives the eleventh house 2.08 harmodynes.

3.84 plus 3.84 (Scorpio on 2 house cusps) gives unoccupied Scorpio 7.68 harmodynes. $7.68 - 1.76$ (Mars in Scorpio) gives Scorpio 5.92 harmodynes.

Chapter 4

Serial No. 200
Original Copyright 1947
Elbert Benjamine

Copyright
August 2002
Church of Light

The Technique of Stellar Healing

**TABLE OF SIGN HARMONY AND HOUSE HARMONY
IN THE CHART OF
JOHN EDWARDS**

Aries	7.79 discordynes
Taurus	8.21 harmodynes
Gemini	3.46 discordynes
Cancer	13.72 harmodynes
Leo	32.96 harmodynes
Virgo	19.21 discordynes
Libra	8.90 harmodynes
Scorpio	5.92 harmodynes
Sagittarius	9.31 harmodynes
Capricorn	7.88 discordynes
Aquarius	1.86 discordynes
Pisces	15.30 harmodynes
First House	9.31 harmodynes
Second House	1.53 discordynes
Third House	0.18 harmodynes
Fourth House	0.88 discordynes
Fifth House	4.11 harmodynes
Sixth House	4.11 harmodynes
Seventh House	13.64 harmodynes
Eighth House	29.58 harmodynes
Ninth House	19.21 discordynes
Tenth House	8.90 harmodynes
Eleventh House	2.08 harmodynes
Twelfth House	3.84 harmodynes

SIGNS	♏	♍	♌	♋	♊	♑
NATAL POWER	65.19 ☉ 10.80	34.20	19.24	73.74 ♁ 30.66	82.45 ♃ 20.60 ♄ 17.93	60.42 ♆ 20.59
TOTAL POWER June 9, 1941	75.99	34.20	19.24	104.40	120.98	81.01
NATAL HARMONY	-7.79 ☉ +2.54 ☉ +2.00*	+8.21	-3.46	+13.72 ♁ +8.55	+32.96 ♃ +12.03 ♄ +3.82	-19.21 ♆ -7.88 ♆ +0.50*
TOTAL HARMONY June 9, 1941	-3.25	+8.21	-3.46	+22.27	+48.81	-26.59

NORMAL MAJOR PROGRESSED HOROSCOPE JOHN EDWARDS, JUNE 9, 1941

SIGNS	♌	♍	♎	♏	♐	♑
NATAL POWER	74.15 MC 28.53	110.78 ♁ 26.71	44.63 ♂ 1.77	20.59 ♁ 12.02	9.84	138.43 ♁ 18.77 ♂ 17.10 ♁ 19.24
TOTAL POWER June 9, 1941	102.68	137.49	46.40	32.61	9.84	193.54
NATAL HARMONY	+8.90 MC +2.40	+5.92 ♁ -0.88 ♁ +1.00*	+9.31 ♂ -0.48	-7.88 ♁ -1.36	-1.86	+15.30 ♁ +0.43 ♂ +4.11 ♁ +1.50* ♁ -3.46 ♁ -1.00*
TOTAL HARMONY June 9, 1941	+11.30	+6.04	+8.83	-9.24	-1.86	+16.88

* Essentially dignified.

Normal Major Progressed Horoscope for Signs
John Edwards, June 9, 1941

HOUSES	1	2	3	4	5	6
NATAL POWER	44.63 Asc 12.02 D 1.77	64.63	142.71 H 18.77 17.10 19.24	26.71 C 10.80	17.10	17.10
TOTAL POWER June 9, 1941	58.42	64.63	197.82	37.51	17.10	17.10
NATAL HARMONY	+9.31 Asc -1.36 D -0.48	-1.53	+0.18 H +0.43 +4.11 +1.50* -3.46 -1.00*	-0.88 C +2.54 D +2.00*	+4.11	+4.11
TOTAL HARMONY June 9, 1941	+7.47	-1.53	+1.76	+3.66	+4.11	+4.11

NORMAL MAJOR PROGRESSED HOROSCOPE JOHN EDWARDS, JUNE 9, 1941

HOUSES	7	8	9	10	11	12
NATAL POWER	80.56 R 30.66	94.88 7 20.60 ♀ 17.93	60.42 7 20.59	74.15 MC 28.53 ♄ 26.71	82.09	28.68
TOTAL POWER June 9, 1941	111.22	133.41	81.01	129.39	82.09	28.68
NATAL HARMONY	+13.64 R +8.55	+29.58 7 +12.03 ♀ +3.82	-19.21 ♄ -7.88 7 +0.50*	+8.90 MC +2.40 ♄ -0.88 ♄ +1.00*	+2.08	+3.84
TOTAL HARMONY June 9, 1941	+22.19	+45.43	-26.59	+11.42	+2.08	+3.84

* Essentially dignified.

Normal Major Progressed Horoscope for Houses
John Edwards, June 9, 1941

Chapter 4

The Technique of Stellar Healing

STELLAR healing was practiced not only in ancient Egypt, but it was practiced by Jesus and the disciples, and by those who follow their methods even to this day, as Healing by Laying On Of Hands.

It is true that Jesus, and those who as healers followed in his footsteps, emphasized faith. That is, as stellar healers always should do, they combined mental healing with the use of planetary energies which were permitted to flow through their bodies to the astral form of the patient. This psychological factor, which is important in healing by any method, was repeatedly emphasized by Jesus, as when he said to the sick woman who touched the hem of his garment: “Thy faith hath made thee whole.”

But, as Mark relates this episode, 5:27-32— “When she had heard of Jesus, came in the press behind, and touched his garment. For she said, If I may touch but his clothes, I shall be whole. And straightway the fountain of her blood was dried up; and she felt in her body that she was healed of that plague. And Jesus, immediately knowing in himself that virtue had gone out of him, turned about him in the press, and said, Who touched my clothes? And his disciples said unto him, Thou seest the multitude thronging thee and sayest thou, Who touched me? And he looked round about to see her that had done this thing.”

If the woman had been cured solely by her own mental attitude it would not have been reported that virtue went out of Jesus to her in the healing process. This virtue was an actual healing energy which passed through the body of the healer to the body of the one healed.

There are those at this day who are natural healers, and others who develop the ability, through whom these energies from the planets flow in large volume. And it is unnecessary for such a healer to touch his patient in order to communicate this planetary energy to him. It is even quite possible to send it to a patient at a distance by establishing the proper rapport between patient and healer.

But commonly it is easier to communicate the healing planetary energies to the patient through the hands, by holding the hands close to, or actually in contact with, the part to be healed. And we find from the Biblical account that Jesus, with all his natural healing ability, found it expedient at times actually to place the fingers in

contact with the part to be healed. Math. 9:28-30—"And when he was come into the house, the blind men came to him: and Jesus saith unto them, Believe ye that I am able to do this? They said unto him, Yea, Lord. Then touched he their eyes, saying, According to your faith be it unto you. And their eyes were opened "

This method of healing was not confined to Jesus, nor to his day. It was the common method practiced by initiates of various countries at that time, and Jesus instructed his twelve disciples in the art and in turn the method was entrusted to those who followed in their footsteps. Because the healing energies are more easily imparted to the patient through the healer's fingers, Christians who use it commonly refer to it as Healing by Laying On Of Hands.

Luke 9:1-2—"Then he called his twelve disciples together, and gave them power and authority over all devils, and to cure diseases. And he sent them to preach the kingdom of God, and to heal the sick."

Healing by Laying On Of Hands Distinguishes True Christians

—If we are to believe the Bible, the two things which Jesus commanded his followers to do, and emphasized in a manner to indicate they were of equal importance, were to, "Preach the Gospel and to heal the sick." And historians record that healing was a common practice among all believers in Christianity for several hundred years after the crucifixion. Iransus, in 110 A.D., for instance, chronicles: "Man healed the sick by laying their hands on them."

At this time, or at any other, I present no brief favoring Christianity. But I am pointing out to those who follow this religion that its founder placed equal emphasis on preaching and healing by laying on of hands. It is to be presumed that a leader who knew he was departing from the earth would embody in his last command to those who were to carry on his work, that which he considered most important. And the last command Jesus gave indicated how those who were true Christians might be known from those who were merely pretenders to Christianity: "These signs shall follow them that believe: In my name... they shall lay hands on the sick, and they shall recover."

Therefore did the disciples and those who followed after them actually heal the sick. Religion and healing went hand in hand in those times, and should go hand in hand at this day. Some of the orthodox faiths are beginning to recognize this, and to incorporate healing into their services.

After all, it is the function of religion not merely to teach people how best to live, but also to help them live in the manner which contributes most to universal welfare. And because an individual cannot contribute his utmost to society when ill, religion is called upon to do all it can to help him regain his health.

Yet it was not necessary for the disciples who cured by laying on of hands to know that some of the energy that passed through their bodies and out their hands was electromagnetic, and that some of it was derived from the astral radiations of the planets. For them to benefit by sunshine it was not necessary for them to know the nature of light—for at present our scientists do not know whether it is a wave, or corpuscular, or both—or that it reached them across a space of 93,000,000 miles, traveling at the rate of about 180,300 miles a second. They had learned by experience how to get warm in the sunshine, how to permit its rays to come into their houses through open doors and windows. And they had been taught the technique of tuning in on the energy radiated by the planets and permitting it to pass through their bodies as a healing current.

Even Akhenaten of Egypt, who taught and practiced this healing technique more than 1,300 years before the twelve disciples were born, probably had no notion of tuning in on the energy he desired to use. How such energies are picked up by the nervous system acting as a radio receiving set, is knowledge made possible only since the discovery of radio. But both Akhenaten and the twelve disciples, through actual practice, had learned how healing energies from some source outside of themselves were induced to flow through their bodies and into the bodies of others to produce healing.

Because Akhenaten was an Egyptian initiate he understood astrology; a subject about which the disciples, who were illiterate, probably knew nothing. While, therefore, Akhenaten probably knew nothing of radio terminology, he was able to perceive that the energy thus used came primarily from the sun, and was transmitted to the earth by the planets as definite qualities of energy.

Instead, therefore, of proceeding along more general lines, such as no doubt the disciples of Jesus followed, Akhenaten was able to discern the inner factors of the disease from the horoscope of the patient. And with this knowledge he was in a position to administer the healing energy which more specifically was adapted to the cure of the disease.

The technique which he developed, as indicated by the pictures he has left us, included the use of color, music and thought to enable the stellar healer to tune in on the particular planetary energy he desired to use. Having tuned in on the vibratory rate desired, the healer directed this energy through his finger tips to the part or organ to be healed.

In reality, healing through laying on of hands, whether so recognized by the healer or not, utilizes, in varying proportions, three different and distinct types of energy.

1. The electromagnetic energy of the healer which passes from his hands to the patient.
2. The astral vibrations of a planet or planets, which the healer is tuned in on, and which pass from his hands with the electromagnetic energy to the thought-cells of the patient.
3. The thoughts and mental images in the healer's mind, which direct the electromagnetic energy and the planetary energy to the accomplishment of the specific healing job to be done.

**To Accomplish Much,
Electromagnetic Energy Must Be
Guided by Astral Energy**

—While it is electromagnetic energy which more directly brings about changes in man's physical body, the changes brought to pass are determined by the astral energies which guide them in their task. Other than being the energy of physical life, electromagnetic energy of itself accomplishes little. It is plastic and takes direction and does such work as the astral energies associated with it direct. If imparted through the hands to a patient with the thought of benefiting him, it gives him vitality and strength. But it also can be directed to destroy, or to bring about changes in the tissues. In so far as it can communicate its motions to physical substance it tends to reproduce in matter whatever form or condition is present in the astral substance with which it is associated.

All the physical phenomena described in lessons No. 44 and No. 45 (Course I) were produced through an abundance of electromagnetism guided in its work by thought (astral) energies. And a highly endowed stellar healer can guide electromagnetic energies to bring about beneficial changes in the human body which are no less amazing.

But however great a change may be imparted to the physical body by means of electromagnetic energy, unless the thought-cell structure also is permanently changed, this thought-cell structure, through such electromagnetic energy as later it is able to command, tends to cause the physical structure to resume its previous condition. Materializations, as produced by mediums, are not permanent because the thought structure molding them is only temporarily strong enough to overcome the desire of the thought-cells of the medium to use the substance and energy to sustain the medium's physical body. A spirit photograph, on the other hand, once made through a temporary thought-form, has no later thought energy associated with it, as a living organism has, to change it back into a reproduction of a more permanent thought structure.

Because the physical structure can only be changed through the action of electromagnetic energy, it is essential that there be present sufficient electromagnetic energy to bring about the desired change. Furthermore, as it is the life of the body, this energy needs to be present in ample amounts. No matter how perfect the physique otherwise, if the electromagnetic energy becomes too depleted, life departs.

That is, so far as the physical body is concerned, it is the vital fluid. And because it is the vital fluid, when it is present abundantly in a certain organ, the tendency is for this organ to be vigorous and able to throw off disease.

Stellar healing, mesmerism, and laying on of hands imparts electromagnetism; and this additional vital force applied to the diseased organ increases its vigor and power and enables it to eliminate disease.

As this electromagnetism normally passes from the hands of a healer, the energies flowing from the right hand of a right-handed person are electric and tend to concentrate the nerve currents of the patient's body in the region of the healer's hand; and the energies flowing from the left hand are magnetic and tend to diffuse the nerve currents of the patient's body in the region of the healer's hand. Commonly, if the healer is left-handed the reverse is true.

The nerve currents of the body are electromagnetic and influence the flow of blood. Blood tends to flow more abundantly to any region where there is nerve stimulation and thus concentration of nervous energy. Consequently, adding the electric energy of the right hand to a part tends to give it not merely a healing energy, but also an additional blood supply. And this may be what the tissue needs.

On the other hand, if the condition to be cured is due to congestion, it needs to be relaxed. Already the nerve currents flow too freely to the part, and the unusual blood supply tends to increase the inflammation, perhaps robbing other parts of the body. When such a condition exists, instead of the positive electric energy, what is needed is the soothing, relaxing, pacifying magnetic energy from the left hand. That is, what the tissues or organs need is not more vitality but more of the healing feminine energy of the magnetic constitution.

In using electromagnetic energies, when the healer wishes to cause a boil to come to a head, or the poisons of the body to be collected in a certain spot, he places his right hand directly over the inflamed part and his left hand as nearly directly opposite as possible. Whenever there is any inflammation which tends to produce pus, the right hand directly over it causes a drawing sensation. Also, when there is an old sore which needs a new blood supply, the right hand is placed over the sore, and the left hand opposite.

But when the healer wishes to diffuse the poison, and scatter it, he places his left hand over the inflamed part, and the right hand on the opposite side of the body or limb. The magnetism from the left hand is of opposite polarity, tending to soothe rather than stimulate, relaxing the part, and scattering the poison along with the blood, from the spot. If the liver is afflicted, for instance, the healer's right hand over the liver and left hand on the back, opposite, may cause pain to be felt. But if the hands are reversed, with the left hand over the liver and the right hand on the back opposite, the pain ceases. Often a diseased part which is made worse through the electromagnetism from one hand is healed by the electromagnetism from the other hand. That is, according to the special need of the part to be healed, both positive electricity and negative magnetism have healing virtue.

Stellar healing, however, is much more than giving treatments with human electromagnetism, and it is much more than giving mental treatments. Thoughts or mental images are selected, after stellar diagnosis has been made, such as are

specifically needed to change the thought-cell structure and the desires of the thought-cells in the manner required for health. These thoughts or images are delivered to the consciousness of the physical cells and organs and to the thought-cells to be changed through the electromagnetism applied by the healer.

But in addition—and this distinguishes stellar healing from all other methods and gives it a power and value they do not possess—the thoughts and images are powerfully reinforced to accomplish their task by a properly selected planetary energy which the healer tunes in on and delivers to the consciousness of the physical cells and to the thought-cells needing treatment through the electromagnetism which he applies to the region to be healed. The planetary energy thus delivered not only assists the healer in giving the thought-cells the desires he seeks they should have, but it supplies them with the energy needed to exercise the necessary extra-physical power to bring about whatever change in the physical body or the physical environment is needed to complete the healing.

Tuning In On Proper Planetary Energy

— The electromagnetic currents passing over the nervous system are the natural conductors of planetary energies. They pick up, and readily transmit, planetary or other astral energies which have a similar vibratory frequency. It is feeling, mood and emotion that tune the electromagnetic energies of the nervous system. Thus to be a successful stellar healer the individual must be proficient in the use of induced emotion. He must be able to engender in himself the emotion, or state of feeling, which for the time being causes him to pick up and radiate not his normal personal magnetism, but a personal magnetism charged and colored by the astral energy of any particular planet of his choice.

In this application of induced emotion, during the time he is giving the stellar treatment he ceases to be his normal self, and through his mood he feels only the constructive energies of a single planet. Placing himself in this state of feeling, in which other states of feeling are not present, his nervous system, through the electromagnetic energies flowing over it, picks up these astral planetary energies. And because he has practiced at such times to permit the electromagnetic energies to flow abundantly from his hands, the particular planetary energies thus intercepted flow also readily with the conducting electromagnetism from his fingers to the patient.

Not everyone can become a stellar healer. Some have too little electromagnetic energy for their own needs, or recharge so slowly that giving treatments would lead to their own depletion. But even of those through whom electromagnetic energy flows abundantly, and who have vitality enough that they quickly recover from the loss occasioned in treating, some are so stolid in their nervous makeup that, even though good magnetic healers, they never can become stellar healers.

A stellar healer must be able, not merely to control his thoughts during the time of treatment, but must be able to induce in himself, for the time being, the emotion he desires. As an actor, to be successful, must be able to feel the part of the character he plays, so the stellar healer must be able to induce in himself the feeling of the planetary energy he wishes to use. And he must induce this feeling in himself as a pleasant and harmonious experience.

The energy of any planet can be given either a constructive or a destructive trend. When the feelings are pleasant and agreeable at the time it flows through the nervous system its energies are harmonious and constructive. But if the mood changes to worry, despondency, anger, or other unpleasant feeling while the treatment is being given, destructive energies are added to the patient's astral form. Hence the healer must be able to determine his emotions during the time of treatment.

To tune in on the vibratory rates of a particular planet, the emotion or state of feeling characteristic of that planet in its constructive aspect should be induced and established as completely as possible. It should permeate the whole body so thoroughly that no other type of thought, feeling or emotion is experienced.

Color and Music as Healing Helps

—One of the best aids in this endeavor is, through the imagination, completely to saturate the body, and send through the hands to the patient, the color ruled by the planet. In fact, the planetary energy used in treatment, when viewed from the astral plane, has this color in vivid intensity. Consequently, such visualization is a correct conception of what actually takes place.

When difficulty is experienced in changing to the emotion of the planetary energy desired, sounding the chord a few times of the musical key ruled by the planet often will aid in tuning the mind and nervous system in on the planet's energies.

In these days of the radio and phonograph it is not too difficult to have martial music when treating with Mars energy; slow, measured, solemn music when the cold blue ray of Saturn is used; music of pomp and ceremony when the vital orange of the Sun is employed; hymns for Jupiter; love themes for Venus; soothing, sleepy-time melodies for the Moon; and volatile, changeable dance rhythms for Mercury.

It is a most difficult thing to explain to another how to induce and hold a particular emotion. It would be difficult to explain to an actor how to feel joy, how to feel sorrow, how to feel righteous indignation, or how to feel consuming wrath. The attitude itself, through the muscular associations, helps to induce the mood. But not all who assume an attitude can feel what it implies, otherwise there would be more good actors.

The problem, therefore, of the best technique to induce the desired feeling in full measure must largely be left to the individual to solve for himself. This much, however, can be said with definiteness: Whenever the individual feels strongly aggressive and energetic, at that time he is actually tuned in on Mars planetary

energies. Whenever he feels coldly methodical and calculating, at that time his nervous system is actually picking up Saturn planetary energies in some volume. But during the time he does not feel the energy of Mars, or the energy of Saturn, or the energy of any particular planet, he is not tuned in on, nor transmitting in volume, the astral energies of the planet which influences this emotion.

While, therefore, it must be left to the individual, through practice and experiment, to discover the technique which is best suited to his own particular temperament and previous conditioning in inducing the desired emotion, he need not remain in doubt, once a feeling is fully established, that he is tuned in on the planet characteristic of this feeling, and capable of transmitting its energies in volume.

The Color Must Flow to Be Effective

—According to personal experience in the past, which have set up associations in his mind, he may find that thinking about some event is a ready way to tune the mind in on a particular emotion, or state of feeling. But aside from these personal helps in tuning in on the required vibratory rate, the use of color is universally applicable. That is, when treating with the energy of a planet, visualize the color as flowing from the hands, along with the electromagnetism, to the place being treated. And in using this method the color must not be permitted to remain stationary, but must actively flow to the patient, and to the part to be healed.

Animal magnetism is electromagnetic energy. It flows over the nerves as nerve currents and determines the blood supply of the various parts. The more concentrated the electromagnetic energy at a certain point in the body the greater the supply of blood received at that place. Conversely, if a blood supply is induced in a certain part, electromagnetic energy flows there more abundantly.

This is important; for the stellar healer depends upon the electromagnetic energies flowing from his fingers to conduct the planetary energies he is tuned in on. But electromagnetic energies will not flow from cold fingers; this coldness indicating they have a poor blood supply. Therefore, before treating, the hands should be rubbed together, or the arms flung about vigorously, until the hands are not only warm, but pulsating with the blood thus forced into them.

And a still further consideration is that electromagnetic energy does not flow well from dry fingers. If the fingers are dry, even if warm and full of blood, it indicates that the electromagnetic energy is not flowing from them in the proper abundance for treatment. When they are warm, and slightly moist with perspiration, they are in the best condition for giving stellar healing treatments. When dry, therefore, there should be a basin of warm water handy, in which, from time to time, the fingers should be dipped, just often enough to keep them suitably moist.

Although the electromagnetic energy from the right hand is of the vital quality ruled by the Sun, and the electromagnetic energy from the left hand is of the nutritive quality ruled by the Moon, when they thus flow from the hands in giving stellar treatments, both these energies become permeated with, and in some measure take on the characteristics of, the planetary energy being used.

When, therefore, the energy of some particular planet is being imparted in proper volume to the patient along with electromagnetic energy, the hands and fingers commonly vibrate to these energies. This vibration felt in the hands is distinctive for each planet. And the stellar healer comes to recognize, through this vibratory sensation in the hands, which planetary energy is flowing through them, and whether or not it is passing to the patient in proper volume.

Warning

—Tuning in on planetary energies is, of course, tuning in on the high-velocity astral world. Through a similar process, therefore, one can tune in on the minds of people and other entities occupying the astral plane. But this is not the object sought in stellar healing, and any attempt at control of the healer by an invisible entity should always be resisted.

If control is not permitted when learning this technique, the healer soon forms the habit of tuning in exclusively on the selected planetary energy, without interference from any astral intelligence. But if he once permits control from some such entity, it requires more effort to prevent tuning in on the entity again.

Those who have not sufficient control to be able to tune in on planetary energies without undue interference from astral intelligences should not attempt stellar healing, and, as explained in lesson No. 64, they should cultivate directed thinking.

SUN vibrations: Musical accompaniment, D.

The electromagnetic energies flowing from the positive hand normally are under the dominion of the Sun. They have a special vital healing power even when uncharged with astral planetary energies. But to give them still greater vital power, and the astral energy to impart life to the astral form, they should be charged with solar vibrations.

The feeling to be induced is that of dominant vital power. The healer should saturate himself with orange color, and cause it to flow through his hands to the patient as a strong, warm, life-giving current of invigorating quality. While thus tuned in on the solar radiations, this astral energy will flow adequately through both hands, not being confined to the positive.

MOON vibrations: Musical accompaniment, F.

The electromagnetic energies flowing from the negative hand normally are under the domination of the Moon. They have a nutritive, magnetic healing influence even when uncharged with astral planetary energies. But to give them still greater power to sooth and nourish, they should be charged with lunar vibrations.

The feeling to be induced is that felt by a mother for the babe in her arms, It is an enfolding, caressing, gentle and sustaining vibration, rounded and strictly feminine. While thus tuned in on the lunar radiations this astral energy will flow as a clear green color through both hands, not being confined to the negative.

MERCURY vibrations: Musical accompaniment, B—B D#-F#-B.

These astral vibrations are active and restless, moving chiefly in straight lines. They have no warmth, but great power of penetration.

They are the vibratory rates commonly picked up when the healer's mind is actively engaged with some problem requiring concentrated thought. Consequently, to tune in on these rates, instead of feeling emotion, the thoughts should be concentrated on the healing task at hand, and these astral energies directed, with the electromagnetic energies flowing from the fingers, as a violet stream, into the patient.

VENUS vibrations: Musical accompaniment, E— E-G #-B-E.

This is the love vibration, into which none of the passion of Mars should be injected. It is best felt as a deep and abiding affection, quite apart from the ordinary connotation of sex. As felt flowing from the fingers the energy is mildly warm and enfolding, distinct alike from the genial warmth of Jupiter and the intense power of the Sun.

Care must always be used when treating a person of opposite sex with this vibratory rate that it does not stimulate a personal affection which would prove embarrassing. But as a kindly yellow light. mellow and gently warm, passing to the region under treatment, it can be kept sufficiently impersonal to avoid such complications and at the same time do its work as the natural antidote for Saturn. And because so many diseased conditions are of the Saturn type, the use of the planetary energies of Venus are frequently required.

MARS vibrations: Musical accompaniment, C— C-E-G-C.

These astral vibratory rates when seen clairvoyantly are red. To tune in on them the whole organism should be given the feeling of abundant and positive aggressive energy.

As applied to treatment, the best color is scarlet. It is a vibration which is highly stimulating, and care should be used that no disagreeable or antagonistic feelings are present during its application. As they pass from the fingers these energies give the sensation of pulsating, glowing heat.

JUPITER vibrations: Musical accompaniment, A—A-C#-E-A.

These astral vibratory rates can be tuned in on through prayer and through the feeling of devotion to assisting the realization of God's Great Plan. When passing through the fingers these vibrations give the feeling of generous warmth and gratitude.

The blue is warmed by red, and the energies are correctly visualized as a rich purple.

SATURN vibrations: Musical accompaniment, G—G-B-D-G.

The state of feeling to be induced in tuning in on the planetary energies of Saturn is that of cold, unbending justice, in which warmth is displaced by an intense steel-blue vibration.

The heavy vibratory rates of Saturn—those that feel like lead—should carefully be avoided. Instead, the energy streaming from the finger tips should be accompanied by a cold sensation which, although unyielding and strict, is not unpleasant. If any unpleasantness is felt the treatment should be discontinued, as such indicates that destructive energies are being delivered to the patient.

URANUS, NEPTUNE and **PLUTO** vibrations: The vibrations of Uranus have a penetrating and disruptive quality, those of Neptune when not elusive are ecstatic and may lead to cosmic consciousness, and those of Pluto on its constructive side cooperate in the work revealed in cosmic consciousness and may lead to divine consciousness.

Calculating the Power and Harmony of the Normal Progressed Horoscope

—The normal relative amount of activity of the various departments of life during a given period may be gauged by the normal power of the houses of the major progressed horoscope during that period.

Irrespective of the normal power of a house, or its normal harmony or discord, its affairs will move along this normal course with no marked variation until a progressed aspect forms which adds accessory energy to the thought-cells mapped by the house. The energy of a progressed aspect not merely increases the energy available to the thought-cells, but it stimulates them to use whatever energy is available.

A man may do very little more work when he is in top health and at the apex of his physical strength than during another period when he is in poor health and rather weak. The strength is there when he is in top health, but he may fail to exert himself. But if he does exert himself while in top health, he can accomplish much more than if he exerts himself while in poor health and weak. A progressed aspect not only gives the thought-cells more energy, but it causes them to exert themselves. They strive to accomplish something characteristic of their desires.

As, other things being equal, such as conditioning and the facilities of environment, the thought-cells having the most power and receiving the most power from the progressed aspect are those most likely to bring about the event stimulated by the progressed aspect, it is highly valuable to know exactly the amount of normal power of each house of the major progressed horoscope during a given period, the normal harmony or discord of each house of the major progressed horoscope during the given period, and both the amount of power and the amount of harmony or discord added to each house influenced by a given progressed aspect.

A progressed aspect adds energy not merely to one house of the normal major progressed horoscope, but to several of them. While other things may affect the department of life which will be influenced by the event brought to pass by the progressed aspect, a better appraisal of the department of life that will be affected can be had if the number of astrodynes possessed by each house of the normal major progressed horoscope is known, and if the number of astrodynes added to each of the houses influenced also is known.

And if the number of harmodynes and discordynes possessed by each house of the normal major progressed horoscope is known, and the number of harmodynes or discordynes added to each of the houses influenced by the progressed aspect is known, a much better appraisal can be made of the probable fortune or misfortune of the event which the aspect influences.

Knowledge of the number of astrodynes and harmodynes or discordynes possessed by each house aside from progressed aspects, and the number of astrodynes and harmodynes or discordynes added to each house by progressed aspects during a given period, enables the individual to gauge much more precisely the Precautionary Actions which should be taken to make the most of opportunities offered during the period, and to avoid difficulties that otherwise might be encountered during the period. And affording as precise a guide as possible to the Proper Precautionary Actions that should be taken is the chief value of astrological knowledge.

A planet merely moving through a sign or house of the birth-chart by Transit, by Minor Progression, or by Major Progression, brings about a structural change in the astral body which enables it to receive energy, of the nature indicated by the progressed planet, in that region. The energy release shown by a progressed planet forms a temporary stellar dynamic structure within the astral body. This acts as a radio receiving terminal for picking up and transmitting to that compartment of the astral body the energies of the vibratory rate of the planet. Observation of the increase in activity of the department of life mapped by the house into which a major progressed planet moves, and the corresponding decrease in the activities of the department of life mapped by the house from which the same major progressed planet has moved, leads to the conclusion that, wherever it moves by major progression, a planet carries with it about one-half its birth-chart power. The progressed Moon, while calculated by the major time-velocity ratio, is considered a sub-major influence having $1/7$ the power of a major progressed planet, and thus carrying with it by major progression $1/14$ of its birth-chart power.

The time-velocity ratio of minor progressions and transits also clearly indicates their relative power, as verified by much careful observation. That is— other than their distinctive power of stepping up through aspect major progressed aspects involving the same planet, to be explained later—a minor progressed planet has $1/27.3$ the power of a major progressed planet, and a minor progressed aspect has $1/27.3$ the power of the same major progressed aspect.

A transiting planet has $1/365.25$ the power of a major progressed planet, and a transit aspect has $1/365.25$ the power of the same major progressed aspect. This does not signify that either minor progressed positions or transit positions should be ignored: for they may afford just the required accessory energy—the proverbial straw that broke the camel’s back—to enable the thought-cells to bring into the life an event of importance indicated by a major progressed aspect.

To ascertain the total unascpected progressed power of a sign or house at a given time, not only must the power of any major progressed planet in it be included, but also the power of any minor progressed planet in it and the power of any transiting planet in it. A minor progressed planet carries with it $1/54.6$ of its birth-chart power, and a transiting planet carries with it $1/730.50$ of its birth-chart power.

Except when it is desired to get the total power of a sign or house for some limited period, the major progressed horoscope may be considered roughly as the normal. With the exception of the Moon, the major progressed planets usually not only remain many years in each house and sign; but they carry with them much power. Even the major progressed Moon has enough power that its approximately two-and-a-half years in each sign and house produce noticeable effects. But on the whole, the major progressed planets remain so long in each sign and house that, except when they move from one house into another, the conditions attracted by the thought-cell activity they support comes to be considered normal for that department of life. New developments of consequence occur only when there is a major progressed aspect which adds still more energy in unusual volume to the thought-cells of the house.

A planet merely moving through a sign or house of the birth-chart by Major Progression, by Minor Progression or by Transit not only adds energy to the sign or house through which it thus moves, but the energy thus added is harmonious if the planet is harmonious at birth, and the energy thus added is discordant if the planet was discordant at birth.

Wherever a planet moves by major progression it carries with it about one-half its birth-chart harmony or discord. The progressed Moon carries with it by major progression $1/14$ of its birth-chart harmony or discord. A minor progressing planet carries with it $1/54.6$ of its birth-chart harmony or discord. A transiting planet carries with it $1/730.50$ of its birth-chart harmony or discord.

In addition, when the planet thus progressing is in a sign which has essential dignity or essential debility it gains harmony or discord. By major progression it gains one-half the harmodynes or discordynes indicated in the Table of Essential Dignity Values (page 38, lesson No. 199). The major progressed Moon gains $1/14$ of the harmodynes or discordynes indicated in the table. Minor progressed planets gain $1/54.6$ of the harmodynes or discordynes indicated in the table. And transiting planets gain $1/730.50$ of the harmodynes or discordynes indicated in the table.

Progressing planets gain by mutual reception (MR) only when the two planets in mutual reception form a progressed aspect. When this occurs, each planet involved

in the major progressed aspect gains 2.50 harmodynes, each planet involved in a sub-major progressed aspect gains .36 harmodynes, each planet involved in a minor progressed aspect gains .09 harmodynes, and each planet involved in a transit aspect gains .01 harmodynes.

Now let us calculate the power and the harmony and discord of John Edward's normal major progressed horoscope for the year 1941. The Limiting Date is June 9, 1920, and the Major Progression Date for 1941 is April 9, 1920. The positions of the planets at noon in the ephemeris on April 9, 1920, therefore, are their major progressed positions for calendar date June 9, 1941. The Moon moves from Sagittarius into Capricorn by major progression on September 15, 1941, after that date adding its progressed power and discord to Capricorn rather than Sagittarius; but the house it occupies does not change during the year.

John Edward's birth-chart is given on page 4 of lesson No. 197. The birth-chart power of each planet, as previously calculated, is given on page 39 of lesson No. 199. The birth-chart harmony or discord of each planet, as previously calculated, is given on page 40 of lesson No. 199. The birth-chart power of each birth-chart sign and house, as previously calculated, is given on page 22 of lesson No. 198. The birth-chart harmony or discord of each sign and house, as previously calculated, is given on page 56 of this lesson.

The ephemeris on April 9, 1920, shows the Moon in Sagittarius. Its birth-chart power is 24.83 astrodynes. Dividing 24.83 by 14 gives 1.77 astrodynes. Its birth-chart discord is 6.76 discordynes. Dividing 6.76 by 14 gives .48 discordynes. 44.63 astrodynes (birth-chart Sagittarius) plus 1.85 gives the normal major progressed power of Sagittarius as 46.48 astrodynes. 9.31 harmodynes (birth-chart Sagittarius) minus .48 discordynes gives the normal major progressed harmony of Sagittarius as 8.83 harmodynes.

In addition to progressed Moon, progressed Asc. is in the first house. Its birth-chart power is 24.03 astrodynes, and its birth-chart discord is 2.72 discordynes. Dividing 24.03 by 2 gives 12.02 astrodynes. Dividing 2.72 by 2 gives 1.36 discordynes. 44.63 astrodynes (birth-chart first house) plus 1.85 plus 12.02 gives the normal major progressed power of the first house as 58.50 astrodynes. .48 plus 1.36 gives 1.84 discordynes. 9.31 harmodynes (birthchart first house) minus 1.84 gives the normal major progressed harmony of the first house as 7.47 harmodynes.

Progressed Asc. is in Capricorn. We have already found its progressed power as 12.02 astrodynes and its progressed discord as 1.36 discordynes. 20.59 astrodynes (birth-chart Capricorn) plus 12.02 gives the normal major progressed power of Capricorn as 32.61 astrodynes. 7.88 discordynes (birth-chart Capricorn) plus 1.36 gives the normal major progressed discord of Capricorn as 9.24 discordynes.

Aquarius has no progressed planet in it and therefore retains its birth-chart power of 9.84 astrodynes and its birth-chart discord of 1.86 discordynes. And as no progressed planet is in the second house, it retains its birth-chart power of 64.63 astrodynes, and its birth-chart discord of 1.53 discordynes.

Progressed Uranus, Venus and Mercury are in Pisces. Birth-chart Uranus has 37.54 astrodynes and .86 harmodynes. Dividing each by 2 gives 18.77 astrodynes and .43 harmodynes. Birth-chart Venus has 34.20 astrodynes, and 8.21 harmodynes. Dividing each by 2 gives 17.10 astrodynes and 4.11 harmodynes. It also gains 0.50 harmodynes for being in its exaltation. Birth-chart Mercury has 38.48 astrodynes and 6.91 discordynes. Dividing each by 2 gives 19.24 astrodynes and 3.46 discordynes. It also gains 1 discordyne for being in its detriment. 138.43 (birthchart Pisces) plus 18.77 plus 17.10 plus 19.24 gives the normal major progressed power of Pisces as 193.54 astrodynes. 15.30 (birth-chart Pisces) plus .43 plus 4.11 plus 1.50 gives 21.34 harmodynes. 3.46 plus 1 gives 4.46 discordynes. 21.34 minus 4.46 gives the normal major progressed harmony of Pisces as 16.88 harmodynes.

Progressed Sun is in Aries. Birth-chart Sun has 21.60 astrodynes, and 5.07 harmodynes. Dividing each by 2 gives 10.80 astrodynes and 2.54 harmodynes. In addition, the Sun gains 2.00 harmodynes for being in its degree of exaltation. It thus has a total of 4.54 harmodynes. 65.19 (birth-chart Aries) plus 10.80 gives the normal major progressed power of Aries as 77.99 astrodynes. 7.79 discordynes (birth-chart Aries) minus 4.54 harmodynes gives the normal major progressed discord of Aries as 3.25 discordynes.

Details of other signs and houses will be found on pages 57 and 58.

Chapter 5

Serial No. 201
Original Copyright 1947
Elbert Benjamine

Copyright
August 2002
Church of Light

Stellar Healing in Practice

John Edwards'
Major Progressed
Planets 3/19/'41

Aspects in orb involving the
Second House March 19, 1941.

		Aspect	Power	H.or D.
Sun	19°07	Sun	∠ Uranus r	4.72 -4.72
Moon	24°12	Sun	∠ Uranus p	8.50 -8.50
Mercury	23°22	Mars	ρ Venus r	16.87 0.00
Venus	26°34	Mars	* Saturn p	13.80 +3.45
Mars	5°40R	Mars	ρ Saturn r	21.05 -15.79
Jupiter	8°20	Mars	ρ Saturn p	27.43 -20.57
Saturn	5°28R	Mars	Δ Uranus p	12.13 +9.10
Uranus	4°12	Mars	ρ Uranus r	22.03 -5.51
Neptune	8°14R	Mars	ρ Uranus p	17.21 -4.30
Pluto	5°44	Saturn	ρ Venus r	11.63 -2.91
M.C.	28°55	Saturn	ρ Uranus r	12.59 -6.56
Asc.	4°27	Saturn	ρ Uranus p	10.23 -5.12
		Saturn	* Pluto r	16.30 +8.15
Sun	7N59	Saturn	* Pluto p	15.55 +7.78
Moon	19N59	Uranus	ρ Saturn r	13.77 -6.89
Mercury	3S44	Uranus	* Asc. p	9.43 +9.43
Venus	2S44	M. C.	ρ Saturn r	26.77 -13.39
Mars	11S25	M.C.	ρ Saturn p	25.54 -12.77
Jupiter	19N06	M.C.	ρ Uranus r	27.43 0.00
Saturn	11N21	M.C.	ρ Uranus p	22.23 0.00
Uranus	10S39			
Neptune	18N04			
Pluto	19N37			
M.C.	11S05			
Asc.	23S22			

TABLE OF PROGRESSED ASPECT PERCENTAGES

	Name of Aspect	Angular Houses Value of Planets ☉ ♃ ♀	Angular Houses Value of Planets ☉ ♃ ♀	Succedent Houses Value of Planets ☉ ♃ ♀	Succedent Houses Value of Planets ☉ ♃ ♀	Cadent Houses Value of Planets ☉ ♃ ♀	Cadent Houses Value of Planets ☉ ♃ ♀
☉ ☽	Conjunction Parallel Opposition	.75	.60	.65	.50	.55	.40
☽ ☽	Trine Square	.60	.50	.50	.40	.40	.30
☽ ☽	Sextile	.40	.35	.35	.30	.30	.25
☽ ☽	Semi-square Sesqui-square	.30	.25	.25	.20	.20	.15
☽ ☽	Semi-sextile Inconjunct	.20	.15	.15	.10	.10	.05



Chapter 5

Stellar Healing in Practice

THE highest function of the healing art is not to cure the sick, but to keep people well. We need those who can cure disease. But even more we need those who can keep disease from manifesting. The more enlightened we become the more the healer's duty and his fame will rest on keeping his clients in health. Instead of bragging about his cures, he will feel ashamed when his clients fall ill. He will base his claims to skill upon the fact that among those employing him there has not been an illness, nor a day's work lost on account of poor health, during a certain number of years.

Stellar diagnosis will aid this type of healer as nothing else will. For it not only indicates, from the birth-chart, the predisposition toward diseases or difficulties of a particular type, but it also indicates, by the progressed aspects, the precise periods during which these predispositions are apt to develop into disease or difficulty.

Whatever type of healing is employed, it is a decided advantage to know that during certain months and years, as revealed by progressed aspects, there is little danger of the natural weakness developing into disease. It is an advantage to know that an individual is quite immune from certain diseases, and will remain so throughout life. And it gives the healer a powerful advantage to know just when those periods are in the life—what weeks, months or years—during which there is danger from some particular type of disease. It enables Precautionary Actions to be taken to prevent the disease or other difficulty from developing.

But whether the difficulty is already present, or as yet only threatening, a study of the birth-chart and progressed aspects should reveal the thought-cell groups which, because of the discord they feel, are working to bring the disease or other difficulty into the life. To do this they influence the thoughts, the behavior and the environment. The more favorable these become to the maintenance of the disease the less power they must possess to cause it to develop or continue. And if the already ill patient continues to think the same thoughts, eat the same foods, follow the same habits, and subject himself to the same environmental conditions, he is unlikely to retain his health even if the stellar healer is able to bring him temporary relief.

In stellar healing there are five distinct steps. The first of these is stellar diagnosis. Then comes selecting the healing thoughts, educating the patient, the general health treatment, and finally the specific stellar treatment.

2. Selecting the Healing Thoughts

—As the inner-plane seat of the difficulty, whatever the difficulty may be, is a group or groups of thought-cells which because of their discord have desires for conditions which are detrimental to the patient, the primary effort should be directed toward changing their desires so that they will work for health, or for whatever it is that the patient seeks.

The desires of thought-cells can be changed in the direction sought through conversion, through the application of mental antidotes, or through applying to them properly selected planetary or other astral energies. The method of conversion and selection and application of mental antidotes is explained in detail in Course IX, Mental Alchemy.

It is the function of stellar diagnosis to reveal the chief thought-cell groups the desires of which must be changed if the patient is to recover or maintain good health. After the healer has decided which type of thought-cells are chiefly responsible for the disease or other difficulty, he selects their mental antidote. He instructs the patient in the constructive use of thoughts of this type, he employs constructive thoughts of this type in giving the specific stellar treatment, and he tunes in on, and delivers to the thought-cells of the patient during the specific stellar treatment, planetary energies of this type.

In applying either thoughts or planetary energies, only those constructive should be employed, and they should always be delivered with a feeling of pleasure.

SUN thoughts and planetary energies are employed to give positiveness and vitality to thought-cells of other planetary types.

MOON thoughts and planetary energies are employed to change the desires of discordant Mars thought-cells.

MERCURY thoughts and planetary energies are employed to change the desires of discordant Jupiter thought-cells.

VENUS thoughts and planetary energies are employed to change the desires of discordant Saturn thought-cells.

MARS thoughts and planetary energies are employed to change the desires of discordant Moon thought-cells and discordant Pluto thought-cells.

JUPITER thoughts and planetary energies are employed to change the desires of discordant Mercury thought-cells and discordant Uranus thought-cells.

SATURN thoughts and planetary energies are employed to change the desires of discordant Venus thought-cells and discordant Neptune thought-cells.

URANUS thoughts and planetary energies may be employed to change the desires of discordant Jupiter thought-cells. To tune in on these planetary energies the feeling to be induced is that of intense potentiality devoted to discovery and originality. It is the mood of inspiration.

NEPTUNE thoughts and planetary energies may be employed to change the desires of discordant Saturn thought-cells. To tune in on these planetary energies the feeling to be induced is that of sensitivity and keen awareness to inner-plane presences. It is the mood of extra-sensory perception.

PLUTO thoughts and planetary energies may be employed to change the desires of discordant Mars thought-cells. To tune in on these planetary energies the feeling to be induced is that of high potentiality conscious and functioning on the inner plane. It is the mood of conscious and directed inner-plane soul activity.

In addition to thoughts of the mental antidote type, delivered during the specific treatment, the healer, during the general treatment gives oral and mental suggestions to the patient, and talks mentally to organs or tissues which are not functioning properly, while holding in his mind the image of the patient in perfect health.

3. Educating the Patient

—The thought-cell discord which manifests as disease also tends to express itself through discordant thinking of the same planetary type. This type of thinking may take a wide variety of forms. If there are hindrances in objective consciousness to the recognition of the true desires back of it, it may express through not easily recognized substitute channels. And one task of the healer is to get the confidence of his patient sufficiently that he will talk about himself freely and reveal these habitual thought trends. When the trends that express the inner discord are discovered, the healer should instruct the patient, not only that he should, whenever these thoughts start to enter his mind, substitute pleasant thoughts of the antidote type, but how to train himself thus to substitute the antidote thoughts for those that were previously habitual.

In addition to discovering the thoughts of the patient which express the birth-chart constant and progressed constant of the disease, the healer should take particular pains to discover if the patient has discordant thoughts about his personality or his health or about work or illness. Discordant thoughts about personality and health move at once into compartment one of the astral body and directly affect the health. Discordant thoughts about work or illness move at once into compartment six of the astral body and directly influence illness.

For such discordant thoughts the patient should be instructed to substitute pleasant thoughts about his body and personality, and pleasant thoughts about his work. He should be shown not only that he should change his attitude toward these matters, but how to do it. To enable him to give such instructions, the healer should be thoroughly familiar with B. of L. Courses III, V, IX and XIV.

The reconditioning of the patient's thought-cells, when successful, will cause them to desire, and work for, the things which the patient also desires. But for whatever they work—health or disease — that which they can accomplish depends upon the relation of their power to the resistance offered by environment. If facilities for health are present in the environment, the health-seeking thought-cells need little power to attract health. If facilities for disease are not present in the environment it may be difficult for the most powerful discordant thought-cells to develop disease.

The patient, therefore, should be instructed relative to hygienic measures, including the foods he should eat, as revealed by the planetary affliction mapping his difficulty as shown by stellar diagnosis.

What these foods are is explained in the five lessons on Stellar Dietetics—Nos. 153, 222, 223, 224 and 225.

4. The General Health Treatment

—Physical cells and physical organs have a certain amount of intelligence. They know how to do certain things. And if their consciousness can be reached and impressed by the healer they will strive to do as he instructs.

Their consciousness, as well as the unconscious mind of the patient, resides on the astral plane. They can be reached and impressed through the organic electromagnetic energy of the healer acting as the conductor of his thoughts.

The healer should be thoroughly familiar with the power and use of suggestion, as explained in B. of L. Course V; and so express himself to his patient in words and actions that the patient will receive the suggestion that he will be healed. And throughout both the general treatment and the specific treatment he should hold in his mind the image of his patient in perfect health. Not only objectively, but also with his inner-plane self, he should desire and be determined that the patient shall and must gain the health thus imaged.

When he knows that it will be beneficial for some group of physical cells or some organ to behave in a different manner, he can make passes over the region with his hands, saturating it with the electromagnetic energy flowing from his fingers, and speak to it mentally, not violently, but firmly, and tell it just what he wants it to do. The electromagnetic energy will convey his commands to the group or organ, and if he has inward (astral) confidence his orders will be carried out it will quickly respond.

If the liver is sluggish, he can thus talk to it and tell it to become more active. If the heart is too active, he can talk to it firmly and ask it to slow down. He can tell the stomach to take more care in its handling of foods. He can talk to the nerves and brain and tell them to relax so the patient can get proper sleep. But before giving such commands he should be sure the action he asks will actually assist in restoring health.

If, at any time during either the general or the specific treatment the electromagnetic energy does not flow abundantly from the healer's hands into the patient, the healer should rub them briskly together, clench and unclench them rapidly, shake his hands vigorously, or adopt other means to cause a greater circulation of blood in his hands and the electromagnetic energy to flow more freely.

Stellar treatments may be given while the patient is reclining by placing one hand under and the other hand over the part to be treated. And when the spine needs special attention this is the best position, as when the patient lies face downward the hands can be moved down the spine, one hand on either side of the vertebral column. Then when it is desired to direct the energies into the front part of the body, the patient can be turned on his back. Whether the patient sits or lies, his spine should be kept fairly straight and free from bends and strains that might hamper the passage of electromagnetic energy. Thin clothing, not of silk, is desirable, such as a cotton hospital gown. In the general treatment planetary energies are tuned in on, and then temporarily, only at station two, which is a place of storage for lunar constitutional electromagnetic energy, and station seven, which is a place of storage for solar vital electromagnetic energy. These energies are stored in these regions even as reserve fuel is stored in the liver, and reserve calcium is stored in the bones, to be drawn upon when most needed.

FIRST STATION: Standing at the right side of his patient, the healer places his right hand close to, or on the patient's forehead, and his left hand on the back of his head, holding him in the image of perfect health while charging his brain with the electromagnetic energies which flow from each hand to the other. This should continue for about one minute.

SECOND (MOON) STATION: The hands should be moved downward so that the right hand is just in front of, or touching, the larynx, and the left hand on the back of the neck close up against the base of the brain. Holding the consciousness of perfect health as the objective sought, the healer should tune in on, and thoroughly saturate the neck and base of the brain with the clear green planetary energy of the Moon and the soothing relaxing lunar electromagnetism. This should continue for about two minutes.

THIRD STATION: The hands should be moved so that the right hand is on the upper chest and the left hand on the back directly opposite. Still holding the knowledge that the patient will be healed, this section of the body is charged with electromagnetic energy for about a minute.

FOURTH STATION: The hands should be moved so that the right hand is on the lower chest and the left hand on the back directly opposite. Continuing the mental conception of health, this region should be charged with electromagnetic energy for about a minute.

FIFTH (MERCURY) STATION: The right hand should be placed on the region of the solar plexus and the left hand on the back directly opposite. The healer, while charging this region, should concentrate on whatever corrections to the patient's

habits of thought seem most desirable. He should formulate these in words and mentally speak to the patient, telling him the type of thoughts he wishes him to cultivate. This thought-corrective treatment should last about two minutes.

SIXTH STATION: The right hand should be placed over the navel and the left hand lower down on the back in the region of the sacral plexus. For about one minute this region should be charged with electromagnetic energy while the healer holds the conviction of perfect health.

SEVENTH (SUN) STATION: The right hand should be placed on the patient's left side over the spleen, which lies just under the heart, and the left hand on the back immediately opposite. The healer should then tune in on the orange planetary energies of the Sun, and while holding the thought of abundant vitality, thoroughly charge the spleen both with the planetary energies and the vital electromagnetism of the Sun. This should continue for about two minutes.

SPECIFIC STELLAR TREATMENT: Next comes the specific treatment to be discussed in lesson No. 202. Assuming the whole treatment to last half an hour, this permits 15 minutes to be devoted to the specific treatment.

EIGHTH STATION: After the specific treatment has been completed, the healer again places his hands on the fifth (Mercury) station, the solar plexus, and repeats the treatment there as he gave it the first time, for about one minute.

NINTH STATION: He then goes to the second (Moon) station at the back of the neck and base of the brain, and gives a final recharging with the clear green astral energies and the lunar electromagnetic energies for about a minute.

TENTH STATION: As the last place of treatment he again goes to seventh (Sun) station, with his right hand over the spleen and the left hand at the back opposite, and for about three minutes pours the orange astral energy, and the vital electromagnetic energy into it. When the spleen is thus recharged with vitality, as the final act of the treatment he makes a little circular movement of his right hand above the spleen, sealing it with his thoughts so that the vitality will be retained for use.

To Find the Peak Power of a Progressed Aspect

—The power of the additional energy which is added to the normal power of the progressed horoscope by a given progressed aspect depends upon the average birth-chart power of the two planets involved in the aspect and the power of the aspect formed.

The peak power of each of the ten major progressed aspects is obtained by multiplying the average birth-chart power of the two planets involved in the aspect by the decimal fraction given in the TABLE OF PROGRESSED ASPECT PERCENTAGES (page 75). The decimal fraction (percentage of birth-chart power) shown in this table is obtained by multiplying the number of degrees given in the Table of Aspects and Their Orbs (page 3, lesson No. 197) by .05; giving the parallel the same power as the conjunction in that table, and giving Mercury the same power as if it were Sun or Moon in the same house.

In using this Table of Progressed Aspect Percentages, the decimal fraction (percentage) indicated for the most powerful house occupied by either a progressed planet or a birth-chart planet involved in the aspect should be employed.

The power of a major progressed aspect of the Moon is obtained by calculating it as if it were a major progressed aspect from one of the other planets and dividing the result by 7.

The power of a minor progressed aspect is obtained by calculating it as if it were a major progressed aspect and dividing the result by 27.3.

The power of a transit aspect is obtained by calculating it as if it were a major progressed aspect and dividing by 365.25.

When Mars or the Sun is involved, and at the same time there are other heavy progressed aspects which act as Rallying Forces, the event indicated by the progressed aspect occasionally takes place while the progressed aspect is as much as a degree and a half from perfect¹. This, however, forms an exception to the general rule that the effective orb within which the event indicated by a progressed aspect takes place is one degree from the perfect aspect. But at one degree from perfect, the aspect commonly is powerful enough to pick up about one-half the peak load of the aspect, gradually increasing in power until the peak is reached, then gradually decreasing in power until at one degree beyond perfect it picks up only about one-half the peak load. Beyond this one degree from perfect the aspect usually is ineffective. These findings are derived from statistical studies of progressed aspects in the charts of thousands of people at the time some significant event came into their lives.

When a major progressed planet makes an aspect to its birth-chart place there are only two terminals affected by the aspect. But as in the progressed horoscope each planet involved in the aspect has its birth-chart position and in addition its progressed position, except when a major progressed planet makes an aspect to its birth-chart place every major progressed aspect has four terminals.

Minor progressed aspects, and transit aspects, are made only to one or more of the terminals mapped by a birth-chart planet's position or mapped by its major

1 Research shows that one degree is always valid.

progressed position. A minor progressed aspect or a transit aspect, therefore, must have not less than three terminals.

Whatever the power and harmony or discord of a progressed aspect—major, minor or transit—this full power and full harmony or discord is received by each of the two terminals actually forming the aspect, and is consequently added to the sign and house occupied by these two terminals.

Each of the other terminals, and consequently the sign and house it occupies, receives, through the principle of resonance, one-half the power and one-half the harmony or discord of the progressed aspect, and this therefore is added to the sign and house occupied by such terminal.

And in addition to signs and houses actually occupied by one or more of the terminals, through the principle of resonance each sign ruled by each of the planets involved in the progressed aspect, and consequently the house the cusp of which it occupies, receives one-half the power and one-half the harmony or discord of the progressed aspect. If the sign is intercepted it receives one-fourth the power and one-fourth the harmony or discord of the progressed aspect.

To Find the Peak Harmony or Discord of a Progressed Aspect

—In computing the harmony or discord of a progressed aspect the same three factors are considered as are employed in computing the birth-chart harmony or discord of an aspect.

1. With the exception of Mutual Reception (MR) the essential dignity of the planets involved in the progressed aspect is taken care of in calculating the normal harmony or discord of the major progressed horoscope. In the progressed horoscope, Mutual Reception is only considered during the time the planets in mutual reception are within orb of a progressed aspect. A major progressed aspect between planets which at the time the aspect is within orb are in mutual reception gains 2.50 harmodynes.

2. When Saturn is involved in a progressed aspect, one-half its power is made discordant by its nature alone. When Jupiter is involved in a progressed aspect, one-half its power is made harmonious by its nature alone.

When Mars is involved in a progressed aspect, one-fourth its power is made discordant by its nature alone. When Venus is involved in a progressed aspect, one-fourth its power is made harmonious by its nature alone.

3. Except when modified by Saturn, Jupiter, Mars or Venus as indicated, the astrodynes of the discordant progressed aspects indicate the number of discordynes, and the astrodynes of the harmonious progressed aspects indicate the number of harmodynes.

The three neutral progressed aspects—conjunction, inconjunct and parallel—while contributing power, do not contribute to harmony or discord except when Jupiter, Saturn, Venus or Mars is involved. When one of these four planets is involved in a neutral progressed aspect, one-half or one-fourth of the power of the progressed aspect is made harmonious or discordant according to the rule given above.

Now let us calculate the peak power and the peak harmony or discord of some of the major progressed aspects in the chart of John Edwards which are within orb during the year 1941. His chart is given on page 4 of lesson No. 197. The birth-chart power of each planet is given in the grill on page 40 of lesson No. 199, and the birth-chart harmony or discord is given in the grill on page 39 of lesson No. 199, and the positions as given in the ephemeris on April 9, 1920, are their major progressed positions for calendar date June 9, 1941.

Progressed Saturn is sextile birth-chart Pluto perfect June 9, 1937. As birth-chart Pluto is in an angle the decimal is .35. The average power of Saturn and Pluto is 51.25. Multiplying 51.25 by .35 gives the peak power of the aspect as 17.94 astrodynes. As Saturn is involved we divide 17.94 by 2, which gives the peak harmony of the aspect as 8.97 harmodynes.

This progressed aspect adds 13.46 astrodynes (one-half of 17.94 for Saturn ruling its cusp, and one-fourth of 17.94 for Saturn ruling the intercepted sign) to the major progressed normal of 64.63 astrodynes of the second house; and 6.73 harmodynes (one-half of 8.97 for Saturn ruling its cusp, and one-fourth of 8.97 for Saturn ruling the intercepted sign) to the major progressed normal of 1.53 discordynes of the second house.

It adds 26.91 astrodynes (17.94 for birth-chart Pluto in the house, and one-half of 17.94 for progressed Pluto in the house) to the major progressed normal of 111.22 astrodynes of the seventh house; and it adds 13.46 harmodynes (8.97 for birth-chart Pluto in the house, and one-half of 8.97 for progressed Pluto in the house) to the major progressed normal of 22.19 harmodynes of the seventh house.

It adds 26.91 astrodynes (17.94 for progressed Saturn in the house, and one-half of 17.94 for birth-chart Saturn in the house) to the major progressed normal of 81.01 astrodynes of the ninth house; and it adds 13.46 harmodynes (8.97 for progressed Saturn in the house, and one-half of 8.97 for birth-chart Saturn in the house) to the major progressed normal of 26.59 discordynes of the ninth house.

It adds 8.97 astrodynes (one-half of 17.94) to the major progressed normal of 82.09 astrodynes of the eleventh house; and 4.49 harmodynes (one-half of 8.97) to the major progressed normal of 2.08 harmodynes of the eleventh house; the cusp of which Pluto rules.

It adds 8.97 astrodynes (one-half of 17.94) to the major progressed normal of 28.68 astrodynes of the twelfth house; and it adds 4.49 harmodynes (one-half of 8.97) to the major progressed normal of 3.84 harmodynes of the twelfth house; the cusp of which Pluto rules..

Progressed M.C. is parallel birth-chart Saturn September 4, 1940. As progressed M.C. is in the tenth house, the decimal is .60. The average power of M.C. and Saturn is 49.12. Multiplying 49.12 by .60 gives the peak power of the aspect as 29.47 astrodynes. Dividing 29.47 by 2 (because Saturn is involved) gives the peak discord of the aspect as 14.74 discordynes.

Progressed Asc. is sextile progressed Uranus October 2, 1940. As progressed Asc. is in the first house, the decimal is .35. The average power of Asc. and Uranus is 30.79. Multiplying 30.79 by .35 gives the peak power of the aspect as 10.78 astrodynes. The harmony of the aspect is 10.78 harmodynes.

Progressed Mars is sextile progressed Saturn November 27, 1939. As progressed Mars is in an angle the decimal is .35. The average power of Mars and Saturn is 47.30. Multiplying 47.30 by .35 gives the peak power of the aspect as 16.56 astrodynes. Dividing 16.56 by 4 (one-half off for Saturn, and one-fourth off for Mars) gives the peak harmony of the aspect as 4.14 harmodynes.

Progressed Sun is semi-square progressed Uranus April 24, 1940. As progressed Sun is in an angle the decimal is .30. The average power of Sun and Uranus is 29.57. Multiplying 29.57 by .30 gives the peak power of the aspect as 8.87 astrodynes. The discord of the aspect is 8.87 discordynes.

Progressed Mars is parallel progressed Saturn January 15, 1942. As progressed Mars is in an angle the decimal is .60. The average power of Mars and Saturn is 47.30. Multiplying 47.30 by .60 gives the peak power of the aspect as 28.38 astrodynes. Three-fourths of 28.38 (one-half for Saturn and one-fourth for Mars) gives the peak discord of the aspect as 21.28 discordynes.

Progressed Mars is trine progressed Uranus October 20, 1943. As progressed Mars is in an angle the decimal is .50. The average power of Mars and Uranus is 45.48 astrodynes. Multiplying 45.48 by .50 gives the peak power of the aspect as 22.74 astrodynes. Dividing 22.74 by 4 (Mars involved) gives 5.69. 22.74 minus 5.69 gives the peak harmony of the aspect as 17.05 harmodynes.

This progressed aspect adds 5.69 astrodynes (one-fourth of 22.74 as Aquarius is intercepted) to the major progressed normal of 64.63 astrodynes of the second house, for Uranus ruling Aquarius in it; and 4.26 harmodynes (one-fourth of 17.05) for Uranus ruling the intercepted sign in it.

It adds 34.11 astrodynes (22.74 for progressed Uranus plus 11.37 for birth-chart Uranus) to the major progressed normal of 197.82 astrodynes of the third house; and it adds 25.58 harmodynes (17.05 for progressed Uranus plus 8.53 for birth-chart Uranus) to the major progressed normal of 1.76 harmodynes of the third house; occupied by progressed and birth-chart Uranus.

It adds 11.37 astrodynes (one-half of 22.74) to the major progressed normal of 37.51 astrodynes of the fourth house; and it adds 8.53 harmodynes (one-half of 17.05) to the major progressed normal of 3.66 harmodynes of the fourth house; the cusp of which Mars rules.

It adds 22.74 astrodynes to the major progressed normal of 129.39 astrodynes of the tenth house; and it adds 17.05 harmodynes to the major progressed normal of 11.42 harmodynes of the tenth; house; occupied by progressed Mars.

It adds 22.74 astrodynes (11.37 for birth-chart Mars in the house, and 11.37 for Mars ruling its cusp) to the major progressed normal of 82.09 astrodynes of the eleventh house; and 17.05 harmodynes (8.53 for Mars in the house, and 8.53 for Mars ruling its cusp) to the major progressed normal 2.08 harmodynes of the eleventh house; occupied by birth-chart Mars, and Mars ruling its cusp.

It adds 11.37 astrodynes to the major progressed normal of 28.68 astrodynes of the twelfth house, and adds 8.53 harmodynes to the major progressed normal of 3.84 harmodynes of the twelfth house; the cusp of which Mars rules.

Progressed Moon is square progressed Mercury February 23, 1941. As the Moon is in an angle the decimal is .60. The average power of Moon and Mercury is 31.66 astrodynes. 31.66 multiplied by .60 gives 19.00. Dividing 19.00 by 7 (because it is an aspect from the Moon) gives the peak power of the aspect as 2.71 astrodynes. This gives the peak discord of the aspect as 2.71 discordynes.

This aspect adds 2.71 astrodynes to the major progressed normal of 58.42 astrodynes of the first house; and 2.71 discordynes to the major progressed normal of 7.47 harmodynes of the first house; occupied by progressed Moon.

It adds 5.43 astrodynes (2.71 for progressed Mercury, 1.36 for birth-chart Mercury, and 1.36 for birth-chart Moon) to the major progressed normal of 197.82 astrodynes of the third house; and 5.43 discordynes to the major progressed normal of 1.76 harmodynes of the third house; occupied by progressed Mercury, birth-chart Mercury, and birth-chart Moon.

It adds 1.36 astrodynes (one-half of 2.71) to the major progressed normal of 111.22 astrodynes of the seventh house; and 1.36 discordynes (one-half of 2.71) to the major progressed normal of 22.19 harmodynes of the seventh house; the cusp of which Mercury rules.

It adds 1.36 astrodynes (one-half of 2.71) to the major progressed normal of 133.41 astrodynes of the eighth house; and 1.36 discordynes to the major progressed normal of 45.43 discordynes of the eighth house: the cusp of which the Moon rules.

It adds 1.36 astrodynes to the major progressed normal of 81.01 astrodynes of the ninth house; and 1.36 discordynes to the major-progressed normal of 26.59 discordynes of the ninth house; the cusp of which Mercury rules.

Progressed Moon is square progressed Venus June 9, 1941. As progressed Moon is in an angle the decimal is .60. The average power of Moon and Venus is 29.52. Multiplying 29.52 by .60 gives 17.71. Dividing 17.71 by 7 (Moon aspect) gives the peak power of the aspect as 2.53 astrodynes. Dividing 2.53 by 4 (because Venus is involved) gives .63. 2.57 minus .63 gives the peak discord of the aspect as 1.94 discordynes.

Progressed Moon is parallel birthchart Pluto November 5, 1941. As progressed Moon is in an angle the decimal is .75. The average power of Moon and Pluto is 43.08. Multiplying 43.08 by .75 gives 32.31. Dividing 32.31 by 7 (Moon) gives the peak power of the aspect as 4.61 astrodynes. Relative to harmony the aspect is neutral.

To Find the Total Influence of a Progressed Aspect

—The peak power of a progressed aspect is a fair gauge of the importance of the main event or events attracted by it relative to the normal conditions in the same department of life, and the peak harmony or discord of a progressed aspect is a fair gauge of the fortune or misfortune of the main event or events attracted by it relative to the normal conditions in the same department of life. But the total effect of a progressed aspect on the life must take into consideration not only the peak power and the peak harmony or discord, but also the period of time during which the aspect exerts power and harmony or discord.

If the planet or planets forming the progressed aspect do not vary in their rate of motion while the aspect is within one degree of perfect, the average daily power in astrodynes of a progressed aspect may be ascertained by multiplying its peak power by .75. This average daily power multiplied by the number of days, months or years the aspect is within one degree of perfect, gives the number of astrodyne-days, astrodyne-months, or astrodyne-years representing the total effect of its power on the life.

If the planet or planets forming the progressed aspect do not vary in their rate of motion while the aspect is within one degree of perfect, the average daily harmony or discord in harmodynes or discordynes of a progressed aspect may be ascertained by multiplying its peak harmony or discord by .75. This average daily harmony or discord multiplied by the number of days, months or years the aspect is within one degree of perfect, gives the number of harmodyne-years or discordyne-years representing the total effect of its harmony or discord on the life.

An individual under a long-time progressed aspect to the ruler of the sixth house, having a moderate peak in discordynes, may never be bedfast a single day, but suffer ill health for years. Another individual, or the same individual at a different period in his life, may have a short-time progressed aspect to the ruler of the sixth house, having a high peak in discordynes, under which he is desperately ill in the hospital for a week or ten days, yet the whole illness last no more than a month. This short illness may stand out in his memory as a most serious event; but the long-time ill health, which he may overlook in trying to remember important events, may have detracted many times as much from his efficiency, and from his happiness.

In John Edwards chart major progressed Sun in 1941 is moving 59' per year. As in the meantime Uranus moves 3', the Sun travels 2 degrees 4' while it is within one degree of semi-square progressed Uranus. That is, it moves 6' more than its travel in 2 years. Using logarithms we find it takes 1 month, 7 days to travel this 6'. The aspect is thus within orb 2 years, 1 month, 7 days.

We have already found the peak power of the aspect to be 8.87 astrodynes and the peak discord 8.87 discordynes. Multiplying 8.87 by .75 gives the average power of the aspect as 6.64 astrodynes, and the average discord of the aspect as 6.64 discordynes.

Multiplying 6.64 by 2 gives 13.28 astrodyne years. Multiplying 6.64 by 1 gives 6.64 astrodyne months. Multiplying .28 (years) by 12 (months in a year) gives 3.36 astrodyne months. 6.64 plus 3.36 gives 10.00 astrodyne months. Multiplying 6.64 by 7 gives 46.48 astrodyne days, or 1 astrodyne month, 16.48 astrodyne days. 1 (month) plus 10 (months) gives 11 months. The total power of the aspect is thus 13 astrodyne years, 11 astrodyne months, 16.48 astrodyne days. And as the discordynes are the same number as the astrodynes the total discord of the aspect is 13 discordyne years, 11 discordyne months, 16.48 discordyne days.

In John Edwards, chart progressed Moon is moving 12° 51' per year and progressed Venus is moving 1° 14' per year. The gain of Moon on Venus is 11° 37' per year. Working by logarithms shows that it takes the Moon 2 months, 2 days to gain 2 degrees on Venus. Thus progressed Moon square progressed Venus, perfect June 9, 1941, remains within orb 2 months, 2 days.

We have already found the peak power of the aspect as 2.53 astrodynes, and the peak discord of the aspect as 1.94 discordynes. Multiplying the 2.53 by .75 gives the average power of the aspect as 1.90 astrodynes. Multiplying 1.94 by .75 gives the average discord of the aspect as 1.46 discordynes.

Multiplying the 1.90 by 2 gives 3.80 astrodyne months. Multiplying 1.90 by 2 gives 3.80 astrodyne days. Multiplying .80 (months) by 30 gives 24.00 astrodyne days. 24.00 plus 3.80 gives 27.80 astrodyne days. The total power of the aspect is thus 3 astrodyne months, 27.80 astrodyne days.

Multiplying 1.46 by 2 gives 2.92 discordyne months. Multiplying 1.46 by 2 gives 2.92 discordyne days. Multiplying .92 (months) by 30 gives 27.60 astrodyne days. 27.60 plus 2.92 gives 30.52 astrodyne days. The total discord of the aspect is 2 discordyne months, 30.52 discordyne days.

To Find the Power of a Progressed Aspect on a Given Date

—Rule: Multiply one-half the peak power of the aspect by the number of minutes the aspect is from perfect and divide the product by 60. This gives the variation in power due to the number of minutes the aspect is from perfect. Subtract the number so found

from the peak power. The number so found is the power of the aspect in astrodynes on the given date.

To find how far from perfect a major progressed aspect is on a given date, convert the calendar interval from the Limiting Date in the calendar year into EGMT Interval by multiplying the months by 2 and calling the product hours, and multiplying the days by 4 and calling the product minutes. Then on the Major Progression Date in the ephemeris representing the calendar year, calculate the sign and degree and minute of the progressed planet, or planets, for the EGMT Interval just as they are calculated in erecting a birth-chart. This will show the major progressed position, or positions, on the given date. The difference between the degree and minute thus shown, and the degree and minute of the perfect aspect, is the distance the aspect is from perfect.

To Find the Harmony or Discord of a Progressed Aspect on a Given Date

—**Rule:** After the power of the aspect on the given date has been found, use this power—not including its stepped up power due to the reinforcement effect of a minor progressed aspect on that date—as if it were the peak power of the aspect.

Let us assume that on his 21st birthday John Edwards was expecting, if some transaction worked out as he wished, to make a very large sum of money, and it was desired to know the power and harmony of all influences on that date affecting the second house. The second house is selected for this example work because there are an extraordinary number of progressed aspects influencing it on that date, and because the house holds both an intercepted sign and a planet at birth.

The Major Progression Date for 1941 for the John Edwards chart is ephemeris date April 9, 1920. As the Limiting Date in the calendar year is June 9, we subtract March 19 from June 9 and get 2 months, 20 days. Multiplying 2 by 2 gives 4 hours. Multiplying 20 by 4 gives 80 minutes. Total 5 hours, 20 minutes. The major progressed positions of all the planets on March 19, 1941, can be found by using a minus EGMT Interval of 5 hours, 20 minutes, on April 9, 1920. Their positions as thus found are given on page 130. Comparing these positions with one another, and with the birth-chart positions, will reveal all planets within one degree of perfect aspect, and how many minutes each aspect is from perfect.

To include all major progressed influences affecting the second house, in addition to the power and harmony of the major progressed normal of 64.62 astrodynes and 1.53 discordynes (see lesson No. 200), the power and harmony or discord of all major progressed aspects within orb (including the parallels, which because such long-time aspects become a normal for the period) involving Saturn, Uranus and Venus must be computed. Thus, to make the second house major progressed picture complete, although only the short-time high-peak aspects may be expected to indicate events deviating from the normal for the period, the power and harmony of 21 different major progressed aspects must be computed.

Sun semi-square birth-chart Uranus. We previously found the peak power of this aspect as 8.87 astrodynes. It is 56' from perfect. Dividing 8.87 by 2 gives 4.44. Multiplying 4.44 by 56 gives 248.64. Dividing 248.64 by 60 gives 4.15. 8.87 minus 4.15 gives the power of the aspect on March 19, 1941, as 4.72 astrodynes. The discord is 4.72 discordynes.

Progressed Mars sextile progressed Saturn. We previously found the peak power of this aspect as 16.56 astrodynes. It is 20' from perfect. Dividing 16.56 by 2 gives 8.28. Multiplying 8.28 by 20 gives 165.60. Dividing 165.60 by 60 gives 2.76. 16.56 minus 2.76 gives the power of the aspect on March 19, 1941, as 13.80 astrodynes. Subtracting one-half of this for Saturn, and one-fourth for Mars, gives the harmony as 3.45 harmodynes.

Progressed Saturn sextile birth-chart Pluto. We previously found the peak power of this aspect as 17.94 astrodynes. It is 11' from perfect. Dividing 17.94 by 2 gives 8.97. Multiplying 8.97 by 11 gives 98.67. Dividing 98.67 by 60 gives 1.64. 17.94 minus 1.64 gives the power of the aspect on March 19, 1941, as 16.30 astrodynes. Dividing 16.30 by 2 (because Saturn is involved) gives the harmony as 8.15 harmodynes

Progressed M.C. parallel birth-chart Saturn. We previously found the peak power of this aspect as 29.47 astrodynes. It is 11' from perfect. Dividing 29.47 by 2 gives 14.74. Multiplying 14.74 by 11 gives 162.14. 162.14 divided by 60 gives 2.70. 29.47 minus 2.70 gives the power of the aspect on March 19, 1941, as 26.77 astrodynes. 26.77 divided by 2 (because Saturn is involved) gives the discord as 13.39 discordynes. The power and harmony of all 21 major progressed aspects affecting the second house on March 19, 1941 are given on page 74.

Chapter 6

Serial No. 202
Original Copyright 1947
Elbert Benjamine

Copyright
August 2002
Church of Light

Diagnosis and Treatment

JOHN EDWARDS PROG. 3/19/'41
 MINOR PROG. TRANSIT

Sun	19 5 52	28 7 30
Moon	13 7 29	20 7 34
Mercury	14 m 07	1 7 40
Venus	21 7 25	20 7 38
Mars	15 7 12	20 7 20
Jupiter	3 5 50	14 8 40
Saturn	0 4 44	11 8 55
Uranus	6 7 09R	23 8 08
Neptune	15 8 37	26 7 16R
Pluto	10 8 02	2 8 10R
M.C.	29 9 40	8 8 18
Asc.	10 8 53	17 7 25
Sun	7S 46	0S 36
Moon	3S 43	17S 55
Mercury	19S 09	11S 10
Venus	4N 41	5S 02
Mars	7N 01	22S 36
Jupiter	0S 30	15N 26
Saturn	1N 37	13N 23
Uranus	10S 00	18N 20
Neptune	16N 15	2N 41
Pluto	19N 52	23N 52
M.C.	11N 21	3S 18
Asc.	17N 31	22S 51

JOHN EDWARDS, PRO. to 3/19/'41

INDEPENDENT MINOR PROG. ASPECTS

	Peak	Power	Har.	Disc
⊙ L 5 P	.35	.24		.36
⊙ □ HP	.32	.22		.22
D P OP	.09	.04	.01	
2 X THP	.07	.04	.02	
2 X HP	.07	.06	.03	
1 X OP	.14	.07		.02
1 X 2P	.58	.41		.62
1 X 3P	.58	.38		.57
1 X 5P	.58	.32		.16
1 X HP	.55	.37		
MC.P OP	1.00	.61	.15	
MCP 5P	1.08	.84		.42
MCP 5P	1.08	1.08		.54
MCP HP	1.04	.87		
MCP HP	1.04	.66		
W.A. 2P	.21	.13		.10
TRANSIT				
⊙ σ OP	.06	.03	.01	
⊙ P OP	.06	.03	.01	
⊙ P 5P	.07	.06		.03
⊙ P 5P	.07	.06		.03
⊙ P HP	.07	.06		
⊙ P HP	.07	.05		
⊙ P 5P	.03	.03		.06
⊙ L OP	.02	.02		.02
⊙ P OP	.04	.03		.02
⊙ P OP	.04	.04	.01	
⊙ P OP	.04	.04	.01	
⊙ P OP	.07	.05	.01	

JOHN EDWARDS, MARCH 19, 1941

MINOR REINFORCEMENTS											
MAJOR	① Δ Hr	② Δ Hr	③ Δ Hr	④ Δ Hr	⑤ Δ Hr	⑥ Δ Hr	⑦ Δ Hr	⑧ Δ Hr	⑨ Δ Hr	⑩ Δ Hr	⑪ Δ Hr
	4.72	2.21	3.05	2.72	1.20	3.38	.48	.16	.10	2.37	.93
	8.50	4.04	5.48	4.89	2.17	1.68	1.72	.15	.35	1.21	2.13
	16.87	.34	1.65	6.16	1.11	9.78					
	13.80	7.99	2.86	1.96	1.52	3.63	3.21	8.27			
	21.05	12.20	2.18	5.96	4.63	9.78	2.77	6.31			
	27.43	15.90	5.69	3.89	3.02	6.38	7.22	18.45			
	12.13	7.04	2.46	.21	.50	3.27	3.04	4.73			
	22.03	12.66	2.21	.73	.45	2.95	10.92	4.26			
	17.21	9.76	3.41	.29	.69	4.55	4.21	6.56			
	11.63	2.38	.23	1.12	1.62	3.02	1.26	4.19	2.67	6.88	.75
	12.59	2.73	1.33	.45	.27	1.86	3.45	1.44	1.77	3.05	7.87
	11.63	2.12	2.07	.17	.41	1.45	2.69	1.12	2.76	2.38	6.14
	16.30	3.42	2.31	4.29	1.80	3.79	9.78	8.39	4.07	6.11	3.23
	15.55	3.23	2.21	4.09	1.71	3.62	9.33	4.00	7.75	2.92	6.16
	13.77	1.43	3.90	1.81	3.03	6.40	4.13	2.78	.23	.56	3.72
	9.43	1.74	.15	.35	2.33	2.16	3.36	3.26			
	26.77	2.78	7.58	3.53	5.89	12.45	8.03	.76	.83	10.17	13.92
	25.54	5.30	3.67	6.73	2.81	5.94	15.32	.71	.79	9.70	13.28
	27.43	2.78	.92	.56	3.70	13.72	5.35	.77	.85	10.42	14.27
	22.23	4.50	.38	.90	6.00	5.56	8.67	.62	.69	8.45	11.56

JOHN EDWARDS' REENFORCED MAJOR PROGRESSED ASPECTS MARCH 19, 1941

① Δ Hr	② Δ Hr	③ Δ Hr	④ Δ Hr	⑤ Δ Hr	⑥ Δ Hr	⑦ Δ Hr	⑧ Δ Hr	⑨ Δ Hr	⑩ Δ Hr	⑪ Δ Hr
19.63	-4.73	36.92	-8.50	35.91	0.00	43.24	+3.45	64.88	-15.78	84.98
33.38	+9.10	56.21	-5.46	46.68	-4.21	35.75	-2.87	45.93	-6.56	38.09
76.08	+8.15	72.70	+7.78	50.57	-6.89	22.78	+8.62	92.71	-13.39	89.79
80.77	0.00	69.56	0.00							

Chapter 6

Diagnosis and Treatment

FROM the emphasis placed on environmental facilities to assist or hinder the thought-cells in bringing the physical events they desire to pass it will be apparent that, while these lessons present what we believe to be the most effective of all non-physical methods of treatment, there is no intent to disparage supplementing stellar healing with physical methods.

It is quite certain there are cases in which the use of chemicals is imperative. Surgery, at times, must be resorted to if the life is to be saved. Home remedies of a wide variety are known to be effective in certain complaints, and good nursing, more frequently than not, is a great help. Osteopathic, chiropractic, massage, electric, physiotherapy and other types of treatment often yield excellent results.

Each method may provide the facilities that enable the health-seeking thought-cells to restore health, or that place obstacles too great to be surmounted in the path of the disease-seeking thought-cells. But to insure that the health will not again be impaired when the environment is once more less favorable, or when the disease-seeking thought-cells are afforded more power through a progressed aspect, the desires of the thought-cells responsible for the disease must be changed. Furthermore, those using any healing method can attain greater success if they will precede treatment with stellar diagnosis.

But it should be pointed out that a diploma from a medical college does not make a doctor in the sense that its possessor then is able to cure disease. Neither does a certificate from The Church of Light that he has passed the examination on stellar healing make of its possessor a stellar healer. The award merely shows, in either case, that the individual has mastered certain studies. It requires the development of a technique by one who is naturally fitted for it to make a stellar healer. Those who are not real stellar healers cannot become so by the possession of a piece of paper; and those who are can be known by the regained health of their patients.

Only accredited colleges, capitalized for a large sum of money and teaching the subjects authorized by legally recognized academic standards can bestow academic degrees. The Brotherhood of Light lessons were written, and the information they contain is being taught, because these facts essential to the welfare of mankind cannot be learned in universities. They cover subjects which as yet are not

recognized by academic authorities. Thus all should understand that passing examinations, such as are required to be initiated into the various degrees of The Religion of the Stars, carries no legal privilege whatever, nor does it warrant the use of letters of any kind after the individual's name.

This explanation is made to make it clear to anyone who passes examinations on this course that NO LEGAL PRIVILEGE either to diagnose or heal is granted thereby. Each state has its own laws regulating the practice of the healing art. In some states it is forbidden for any, except those passing the requirements of a State Board of Examiners, to prescribe so much as a glass of water, or to give any opinions as to the nature of an illness, or even to place the hands on a person for healing purposes. So long as such laws exist no church or school can defy them.

The privilege to practice either stellar diagnosis or stellar healing cannot be granted by The Church of Light, but must be obtained by compliance with the state laws which govern drugless healing. Those who have natural ability as healers and wish to practice stellar healing should make themselves familiar with the drugless healing laws of the state in which they expect to practice, and should get a license under those laws to practice some form of healing.

The Use of Passes

—When the needs of the patient require it, passes may be made a supplementary part of the General Treatment. Passes over the patient not merely facilitate the Row of electromagnetic energy from the healer's fingers, thus charging the patient more thoroughly with it, but they are of particular value in directing the trend of the nerve currents, and consequently the blood supply of the body. The electromagnetic currents, and the blood supply, tend to follow the direction of the passes.

Such passes are made over the patient's body lengthwise, either from the head down, or from the feet up. While making them the hands are moved within a few inches from actual contact with the body. Passes may also be made over local areas to redistribute nerve currents and blood supply. When a local area is thus treated, however, it is somewhat more effective to use gentle strokings with the fingers, as the actual physical contact facilitates the electromagnetic energy reaching the patient.

To soothe, draw the blood from the head, and relax the patient, the passes should be from the head toward the feet. As the nerve currents and blood are withdrawn from the brain, its activities subside, the patient becomes drowsy, and if these downward passes are continued, he will fall asleep. Such passes should be slow and gentle; and if there is special need for the patient to rest, talking to him in a soothing monotone will assist putting him to sleep.

When the patient has been in such pain that he has been unable to sleep, or his nerves are such that sleep flies from him, instead of the morphine used by the medical school, the stellar healer uses soothing downward passes accompanied by low monotone talking, in which the patient is told, from time to time, that he is drowsy, that he is going to sleep, and that the sleep will be restful and refreshing.

That is, just as the healer mentally tells certain cells and organs what they are to do, when treating them, so when he wishes the patient to get a refreshing sleep, he tells the patient, either mentally or in the vocal manner indicated, that he is to relax, sleep, and refresh himself.

If, however, instead of being too high-strung and nervous to sleep, the patient is drowsy and mentally inactive, the passes should be made up toward the head. Such passes are stimulating, and instead of being made slowly and soothingly, they should be completed in rather rapid vigorous movements. The effect is to cause the nerve currents and blood supply to flow strongly to the brain. This stimulates brain activity, overcomes drowsiness, and routes lethargy.

Whether or not passes are used, the redistribution of the blood supply due to the electromagnetic energies imparted to him may cause the patient to feel decidedly dizzy immediately after treatment. Both the added electromagnetic energy to give new life, and the changed circulation to cause the blood to flow where most needed, in such cases, are just what is needed. But the patient, feeling dizzy, may be alarmed. Where such dizziness is felt the cause should be explained, and a place provided where the patient can rest for an hour after treatment before moving about much. Such a rest enables the circulation to become properly adjusted and permits the dizziness to disappear.

For the same reason, that the circulation both of the electromagnetic energies and the blood are disturbed, it is often better for the patient to refrain from eating for an hour after the treatment. If the stomach is filled immediately after the treatment, blood and energy elsewhere diverted to healing purposes may not be sufficient in the region of the digestive tract to enable the food to be properly handled. But after an hour no such disturbance of the normal functions is apt to remain.

The First Step Toward Healing

—The first thing to be done is to erect the birth-chart of the patient and calculate the progressed aspects for the time he became ill. The progressed aspects will indicate the particular birth-chart predisposition which has been given enough additional energy to enable it to attract its type of disease.

A familiarity with the birth-chart and progressed constants of the 160 diseases given in this course, together with the physical symptoms, should enable the healer to determine both the nature of the disease and the thought-cells whose unusual activities, due to one or more progressed aspect, are the chief inner-plane cause.

An important objective in stellar diagnosis is to determine the thought-cell group whose discord is thus chiefly responsible for attracting the disease. As each planet when discordant tends to manifest in diseases which are characteristic of it, as indicated by their organ and function rulership given in lesson No. 199, and more specifically in the constants of the 160 diseases considered in this course, this commonly is not difficult to do.

The Specific Stellar Treatment

—The specific stellar treatment commonly embraces three objectives in the following order of importance:

1. THE DESIRES OF THE THOUGHT-CELLS CHIEFLY RESPONSIBLE FOR THE DISEASE MUST BE FAVORABLY CHANGED. To do this, planetary energies selected for their ability so to change these thought-cells that they will desire and work for health are tuned in on and delivered to the zone of the body occupied by the birth-chart planet or progressed planet mapping the responsible thought-cells. As indicated by the constants involved, sometimes more than one dynamic structure needs treatment. The zone is indicated by the zodiacal sign in which the planet mapping the discordant thought-cells is found. To change their desires, in general the planetary antidotes given in lesson 201 are employed; but more specific instructions, in which other planetary energies are used to supplement these in treating some diseases, are given in the lessons to follow.

Whether the treatment is for the purpose of healing the body, healing defects in the character, correcting domestic discords, improving the finances, gaining merited honor, or healing breaches in friendship, the major portion of the specific stellar treatment should be devoted to changing the desires of the dynamic thought-cells chiefly responsible for the difficulty through delivering to the zone where the planet actually mapping them is located the proper planetary energy charged with the definite thought that they will change their desires and work for that which the healer demands.

Through the principle of resonance, if these dynamic thought-cells change their desires, the common thought-cells mapped by the signs the same planet rules will similarly change their desires. And if the zone of the physical body, or the department of life, has been affected adversely by these dynamic thought-cells radiating energy as a Rallying Force, this Rallying Force will be altered when their desires are changed.

2. THE DESIRES OF THE THOUGHT-CELLS OF THE ZONE WHERE THE DISEASE MANIFESTS MUST BE FAVORABLY CHANGED. Commonly when the disease manifests in some particular area, the planet mapping the thought-cells chiefly responsible for the disease also rules the sign covering the zone where the disease manifests. By treating the zone where the responsible planet

is located, through the principle of resonance the desires of these common thought-cells also are favorably changed. But even so, when the disease manifests in some special region—such as the head, heart, stomach, bowels or feet—it is well to give this zone about half as long a stellar treatment as is given to the dynamic thought-cells elsewhere located.

If, as is sometimes the case, an afflicted planet in this zone contributes to the disease, as indicated by its constants, the thought-cells mapped by this planet should receive treatment. But if a planet in the sign does not contribute to the disease, or if no planet is in the sign—people may have headache with no birth-chart or progressed planet in Aries, may have diphtheria with no birth-chart or progressed planet in Taurus, may have stomach trouble with no birthchart or progressed planet in Cancer—the planetary antidote for the planet ruling the sign should be applied directly to the common thought-cells at the zone head, neck, stomach, etc.—where the body ‘disease is present.

3. THE DESIRES OF THE THOUGHT-CELLS OF THE HOUSE CONSTANTS OF THE DIFFICULTY SHOULD BE GIVEN HARMONIOUS STRENGTH. In addition to the thought-cells chiefly responsible for the difficulty, and those where a body disease manifests, there are always certain house constants. We find, for instance, that in all cases of body illness there is a progressed aspect to the ruler of the first house and a progressed aspect to the ruler of the sixth house. In marriage difficulties there is always a progressed aspect to the ruler of the seventh house. In employment difficulties there is always a progressed aspect to the ruler of the tenth house and a progressed aspect to the ruler of the sixth house. In money loss there is always a progressed aspect to the ruler of the second house.

Whatever the nature of the difficulty the treatment is to correct, the zone, or zones, of the astral body covered by the house constant, or constants, should receive brief specific stellar treatment. The treatment should be applied to the zone, or zones, which are the constant, or constants.

Other things being equal, a birth-chart planet in a house has twice the power to influence it as a progressed planet in the same house or the planet ruling its cusp. But if at birth the progressed planet or the planet ruling the house cusp had more than twice as many astrodynes as the birth-chart planet in the house, it would have more power to influence the house than the birth-chart planet in it. In selecting the planetary and thought energy with which to treat a house constant, therefore, the one should be selected which will most benefit the thought-cells mapped by the house.

For a fifteen minute specific stellar treatment about eight minutes can be given to treating the dynamic stellar structures chiefly responsible for the disease, about four minutes may be devoted to treating the zone where the disease manifests, if it manifests in some particular area, and about three minutes may be devoted to treating the zone or zones which are the house constant, or constants, of the difficulty. These are mapped by the signs on the first and sixth houses if it is a body disease.

After tuning in on the planetary energy selected, as explained in lesson No. 200, there are three methods of reaching the thought-cells of a selected zone with the planetary energy reinforced by thought, the third being merely a combination of the other two. The direct method is to place the hands over the zone where the thought-cells are located the desires of which are to be changed, or better still to place one hand over the zone and the other hand on the opposite side of the limb or body. The indirect method is to place the hands close together along either side of the backbone where the nerves branch off which reach the zone being treated. Where these spinal nerves are located is given in lesson No. 199. The combination method, which is probably the most effective way of reaching the compartment in the astral body where the discord is located, is to place one hand directly on the zone of the physical body where the discord is located, and to place the other hand on the back where the nerve leaves the spine which leads to the zone, and to send the planetary energy over the electromagnetic current thus established.

The healer tuned in on the selected planetary energy, and having in mind the determination that the patient shall have perfect health, should mentally command the thought-cells being treated to become harmonious and to desire and work for the health of the patient. He should saturate the zone being treated with the astral color of the planetary energy being used. As indicated in Lesson No. 200, the color must flow, along with his electromagnetism, to the thought-cells, delivering to them both the selected planetary energy and the commands of the healer.

After the specific stellar treatment has been given, it is well to finish with the three final stations of the general health treatment (lesson No. 201).

Calculating the Independent Power and Harmony or Discord of Minor Progressed Aspects and Transit Aspects

—The independent power and harmony or discord of a minor progressed aspect may be calculated exactly as if it were the power and harmony or discord of a major progressed aspect, except that the results so obtained should then be divided by 27.3. The peak power of 16 such independent minor progressed aspects in the John Edwards chart is given in the table on page 163.

The power and harmony or discord of a transit aspect may be calculated exactly as if it were the power and harmony or discord of a major progressed aspect, except that the results so obtained should then be divided by 365.25. The peak power of 11 such transit aspects in the John Edwards chart is given in the table on page 163.

Calculating the Independent Power and Harmony or Discord of a Minor Progressed Aspect or a Transit Aspect on a Given Date

—First find the peak power of the aspect. Then find how many minutes the aspect is from perfect. Multiply one-half the peak power of the aspect by the number of minutes the aspect is from perfect and divide the product by 60. This gives the variation in power due to the number of minutes the aspect is from perfect. Subtract the number so found from the peak power. The resulting number is the power of the aspect in astrodynes on the given date. Use this power, the nature of the aspect and the nature of the planets making the aspect to determine the harmony or discord exactly as if it were a major progressed aspect, except that if at the time the planets are in mutual reception instead of adding 2.50 harmodynes, only .09 harmodynes should be added for a minor progressed aspect, and only .01 harmodyne should be added for a transit aspect.

The difference between the degree and minute occupied by the planet as shown on the given date in the ephemeris and the degree and minute of the perfect aspect, is the distance a transit aspect is from perfect. The ephemeris positions of the planets on March 19, 1941, are given in the table on page 162.

To find how far from perfect a minor progressed aspect is on a given date, if the Lunar Constant is minus, add it to the number of the month and day of the given date, but if the Lunar Constant is plus, subtract it from the number of the month and day of the given date. The result will be the sign and degree occupied by the minor progressed Moon on the given date.

In the ephemeris find the Minor Progression Date representing the birthday in the calendar year in which the given date occurs. Then move ahead in the ephemeris if the date is after the birthday, and back in the ephemeris if the date is before the birthday, to the ephemeris day on which the minor progressed Moon is shown in the sign and degree found for the given date. By proportion or logarithms calculate the degree and minute occupied by the planet when the minor progressed Moon is in the sign and degree it occupies on the given date. The difference between the degree and minute thus found and the degree and minute of the perfect aspect is the distance the aspect is from perfect.

In the John Edwards chart to find the minor progressed positions on March 19, 1941, we first multiply 27.3 by 21 (years after birth) which gives us 573.3 days after birth. Dividing 573.3 by 365 gives us 1 year, with 208.3 days over. Dividing 208.3 by 30 gives 6 months, with 28.3 days over. To March 19, 1920, add 1 year, 6 months, 28.3 days and it gives the approximate Minor Progression Date as October 17, 1921. On this date the Moon is in Aries; but as on the Minor Progression Date the Moon must be in the same degree and minute as at birth, we move back to October 13 where the Moon is 10 Pisces 32. Using logarithms to calculate the interval, we find on October

13, 1921, the Moon reaches 13 Pisces 29, where it was at birth, in a plus EGMT Interval of 5h. 52m. We therefore calculate the positions of the other planets also for the EGMT Interval of 5h. 52m.

The birth-chart positions of the planets in the John Edwards chart are given on page 3 of lesson No. 197. The major progressed positions of the planets on March 19, 1941, are given on page 130 of lesson No. 201. The minor progressed positions of the planets on March 19, 1941, are given on page 162 of this lesson. By comparing these positions with the birth-chart and major progressed positions it will be found that minor progressed Sun is 36' distant from the perfect semi-square of major progressed Saturn. The peak power of the aspect is .35. One-half of .35 is .18. Multiplying .18 by 36 (distance) gives 6.48. Dividing 6.48 by 60 gives .11. .35 (peak) minus .11 gives the independent power of the aspect on March 19, 1941, as .24 astrodynes. Dividing .24 by 2 (Saturn) gives .12. .24 plus .12 gives the discord of the aspect on the mentioned date as .36 discordynes.

Minor progressed Moon is 59' from perfect parallel major progressed Venus. As a progressed aspect from the Moon is one-seventh the power of the same aspect between other planets, the peak power of the aspect is .09. One-half of .09 is .05. Multiplying .05 by 59 gives 2.95. Dividing 2.95 by 60 gives .05. .09 (peak) minus .05 gives the independent power of the aspect on March 19, 1941, as .04 astrodynes. Dividing .04 by 4 (Venus) gives the harmony of the aspect at this time as .01 harmodyne.

Minor progressed Uranus lacks 39' of the perfect parallel with major progressed Uranus. The peak power of the aspect is .55. One-half of .55 is .28. Multiplying .28 by 39 gives 10.92. 10.92 divided by 60 gives .18. .55 minus .18 gives the independent power of the aspect on March 19, 1941, as .37 astrodynes. Relative to harmony it is neutral.

The independent power and harmony or discord of each of the 16 minor progressed aspects within orb of an aspect to Venus, Saturn or Uranus on March 19, 1941, in the John Edwards Chart are given on page 163.

The transit positions of the planets on March 19, 1941, are given on page 162 of this lesson. By comparing these positions with the birth-chart and major progressed positions in the John Edwards chart it will be found that transiting Mercury lacks 53' of perfect conjunction with birth-chart Venus. The peak power of the aspect is .06. One-half of .06 is .03. Multiplying .03 by 53 gives 1.59. Dividing 1.59 by 60 gives .03. .06 (peak) minus .03 gives the power of the aspect on March 19, 1941, as .03 astrodynes. Dividing .03 by 4 (Venus) gives the harmony of the aspect as .01 harmodyne.

Mars lacks 8' of the perfect sesqui-square of progressed Saturn. The peak power of the aspect is .03. One-half of .03 is .02. Multiplying .02 by 8 gives .16. .16 divided by 60 gives less than .01 to be subtracted from the peak power. Therefore the independent power of the aspect on March 19, 1941, is .03 astrodynes. One-half (Saturn) of .03 is .02. One-fourth (Mars) of .03 is .01. .03 plus .02 plus .01 gives the discord of the aspect as .06 discordynes.

M.C lacks 34' of the perfect parallel with progressed Venus. The peak power is .07. One-half of .07 is .04. Multiplying .04 by 34 gives 1.36. Dividing 1.36 by 60 gives .02 to be subtracted from the peak power. Therefore the independent power of the aspect on March 19, 1941, is .05 astrodynes. Dividing .05 by 4 (Venus) gives the harmony of the aspect as .01 harmodynes.

The independent power and harmony or discord of each of the 11 transit aspects within orb of an aspect to Venus, Saturn or Uranus on March 19, 1941, in the John Edwards chart is given on page 163.

Calculating the Reinforcement Power of a Minor Progressed Aspect

—Observation shows that a minor progressed aspect has two distinct types of influence. Its independent power and harmony or discord tends to attract conditions or an event of minor importance consistent with this power and harmony or discord. But in addition to this independent power and harmony or discord, if the minor progressed aspect is to any one of the four terminals (if it has four terminals) of a major progressed aspect, it also markedly steps up the power of the major progressed aspect. So far as effects are concerned, it seems to operate on the major progressed power as an automobile induction coil does in stepping up the battery current to sufficient voltage to afford the sparks necessary for ignition. And for a major progressed aspect to gain enough power to attract a major event it would seem that it is as necessary for it to be thus reinforced by a minor progressed aspect to one of its four terminals, as it is for an automobile to have its battery current stepped up by an induction coil to get satisfactory ignition.

So far as our statistical studies have one, this reinforcement effect seems to have no influence whatever on the harmony or discord of the major progressed aspect. Nor, so far as we have yet been able to ascertain, is this stepping up influence present when a minor progressed planet which is the same as one of the four customary major progressed planetary terminals, makes an aspect to a birth-chart or major progressed planet which is not one of the four customary major progressed planetary terminals. But when a minor progressed planet makes an aspect to one of the four planetary terminals of a major progressed aspect, this stepping up effect is always present.

Usually during the period in which a major progressed aspect is less than one degree from perfect there are several shorter periods in which a minor progressed aspect forms to one of the four terminals affected by the major progressed aspect. Each of

these minor progressed aspects will then usually coincide with a minor event of the power and harmony or discord characteristic of the independent influence of the minor progressed aspect. But also, as a rule, whatever major event takes place will coincide in time with one of these periods in which one of the four terminals affected by the major progressed aspect also receives an aspect by minor progression.

The sub-major progressed aspects of the Moon, while adding accessory energy, do not have this stepping up effect. Every progressed aspect—major, minor or transit—involving one of the two planets of the major progressed aspect, adds accessory energy to the signs and houses ruled by these two planets. But as a rule a major event takes place only when there is a major progressed aspect involving a planet ruling the house, which at the time is reinforced by a minor progressed aspect to one of the four terminals affected by the major progressed aspect.

What seems to take place is that a minor progressed aspect to one of the four terminals affected by a major progressed aspect, without influencing the harmony or discord of the major progressed aspect, steps up whatever power the major progressed aspect has at that time by the same percentage a similar major-progressed aspect steps up the birth-chart power of the planets involved.

During the time a major progressed planet is within orb of aspect, there usually are several short periods when the minor reinforcement effect produces lower or higher peaks. Some of these peaks have less power than the peak influence of the major progressed aspect; but if not far removed from the culmination of the major progressed aspect power, a single minor progressed aspect—or even at the edge of orb of the major progressed aspect, several minor progressed aspects—involving one of the major progressed aspect terminals, may generate a power that towers far above the peak indicated by the major progressed aspect alone.

Of course, as the actual event or events produced by the influence of the major progressed aspect is dependent not merely upon the activity of the thought-cells involved, but also upon the facility of the environment, such major event, or events, as does transpire often takes place at a time other than when the highest peak is present. But, apparently with an occasional exception, it does take place on one of the peaks of power influenced by the reinforcement effect of a minor progressed aspect. This much has a sound basis of extensive observation. But, admittedly, there is a great deal to learn about this reinforcement effect and the effect of accessory progressed aspects in general, as well as the details of how Rallying Forces operate. Such knowledge must be ascertained through statistical research. And when it is ascertained, not only will prediction be made more precise, but Control of Life will be greatly facilitated.

To ascertain the reinforcement effect of a minor progressed aspect, the power of the given major progressed aspect must be calculated for the date on which it is desired to know how many astrodynes are present. This may be the date on which the reinforcing minor-progressed aspect is perfect, or on some other date during the time it is within one degree of perfect.

Calculating the Peak Reinforcement Power of a Minor Progressed Aspect

—**RULE:** Find the power of the major progressed aspect on that date. Then proceed exactly as if the minor progressed aspect were a major progressed aspect and this power were the average birth-chart power of the planets involved in the aspect. If one of the minor progressed terminals is identical with one of the two terminals of the major progressed aspect, the number of astrodynes thus found is the number due to the reinforcement effect of the minor progressed aspect. If neither of the minor progressed terminals is identical with one of the two terminals of the major progressed aspect, the number of astrodynes thus found divided by 2 is the number due to the reinforcement effect of the minor progressed aspect. The peak power on the day the minor progressed aspect is perfect is obtained by adding this reinforcement power to the power of the unreinforced major progressed aspect on that date.

In the John Edwards chart minor progressed Sun makes the perfect opposition of the major progressed Sun on March 10, 1941, thus reinforcing each major progressed aspect in which at the time the Sun is involved. Using the method explained in lesson No. 201 we find the power of major progressed Sun semi-square birth-chart Uranus on March 10 to be 4.87 astrodynes. As Sun is in angle the decimal is .75. Multiplying 4.87 by .75 gives 3.65. 4.87 plus 3.65 (reinforcement) gives the peak as 8.52 astrodynes.

Minor progressed Uranus makes the perfect opposition to birth-chart Saturn July 2, 1940, thus reinforcing each major progressed aspect in which Saturn is involved. On July 2, 1940, the power of major progressed Mars sextile progressed Saturn is 13.10 astrodynes. As minor Uranus and birth-chart Saturn are in cadent houses the decimal is .40. Multiplying 13.10 by .40 gives 5.24. Dividing 5.24 by 2 (as the minor is to an indirect terminal) gives 2.62. 13.10 plus 2.62 gives the peak as 15.72 astrodynes.

Minor progressed M.C. makes the perfect parallel to progressed Saturn March 19, 1941, thus reinforcing each major progressed aspect in which Saturn is involved. On March 19, 1941, the power of major progressed Saturn sextile birth-chart Pluto is 16.30 astrodynes. As minor M.C. is in an angle the decimal is .60. Multiplying 16.30 by .60 gives 9.78. 16.30 plus 9.78 gives the peak as 26.08 astrodynes.

On the same date the power of major progressed Mars parallel birth-chart Saturn is 21.05. Multiplying 21.05 by .60 gives 12.63. Dividing 12.63 by 2 (as the minor is to an indirect terminal) gives 6.32. 21.05 plus 6.32 gives the peak as 27.37 astrodynes.

Minor progressed Sun makes the perfect sesqui-square with major progressed Uranus on March 11, 1941. On March 11, 1941, the power of major progressed Mars trine progressed Uranus was 12.13 astrodynes. As minor progressed Sun is in an

angle the decimal is .30. Multiplying 12.13 by .30 gives 3.64. 12.13 plus 3.64 gives the peak as 15.77 astrodynes.

Calculating the Reinforcement Power of a Minor Progressed Aspect on a Given Date

—**RULE:** Calculate the reinforcement power of the minor progressed aspect as if it were perfect on that day. Then, as if it were a major progressed aspect, multiply one-half the power so found by the number of minutes the minor progressed aspect is from perfect and divide the product by 60. Subtract the number so found from the number that would represent the minor progressed aspect peak if perfect on that day. The number so found is the reinforcement power of the aspect in astrodynes on the given date. The peak power on this date is obtained by adding this reinforcement power to the power of the unreinforced major progressed aspect on this date.

The major progressed power of each of the 21 major progressed aspects on March 19, 1941, involving Saturn, Uranus or Venus and thus influencing the second house in the John Edwards chart is given on page 130 of lesson No. 201. Let us see how some of these are reinforced on the same date by minor progressed aspects.

Major progressed Sun semi-square birth-chart Uranus on this date has 4.72 astrodynes. Consulting the birth-chart, and the minor progressed positions on page 162, shows that minor progressed Sun is 45' from perfect opposition major progressed Sun. As progressed Sun is in an angle the decimal is .75. Multiplying 4.72 (power of major aspect) by .75 gives the reinforcement peak as 3.54 astrodynes. Dividing 3.54 by 2 gives 1.77. Multiplying 1.77 by 45 (distance from perfect) gives 79.65. Dividing 79.65 by 60 gives 1.33. 3.54 minus 1.33 gives the power of the minor progressed aspect to reinforce major progressed Sun semi-square birth-chart Uranus on March 19, 1941, as 2.21 astrodynes. Minor progressed Jupiter on this date is 9' from parallel birth-chart Sun. As Sun and Jupiter are in cadent houses the decimal is .55. Multiplying 4.72 (power of major aspect) by .55 gives the reinforcement peak as 2.60 astrodynes. Dividing 2.60 by 2 gives 1.30. Multiplying 1.30 by 9 (distance from perfect) gives 11.70. Dividing 11.70 by 60 gives .20. 2.60 minus .20 gives 2.40. But as birth-chart Sun is an indirect terminal (major aspect is from progressed Sun) we divide 2.40 by 2. This gives the power of the minor progressed aspect to reinforce major progressed Sun semi-square birth-chart Uranus on March 19, 1941, as 1.20 astrodynes.

On March 19, 1941, major progressed Saturn sextile birth-chart Pluto has 16.30 astrodynes. On the same date minor progressed Sun is 36' from perfect semi-square progressed Saturn. As minor progressed Sun is in an angle the decimal is .30. Multiplying 16.30 by .30 gives the reinforcement peak as 4.89 astrodynes. Dividing 4.89 by 2 gives 2.45. Multiplying 2.45 by 36 (distance from perfect) gives 88.20. Dividing 88.20 by 60 gives 1.47. 4.89 minus 1.47 gives the power of the minor progressed aspect to reinforce major progressed Saturn sextile birth-chart Pluto on March 19, 1941, as 3.42 astrodynes.

On March 19, 1941 major progressed Saturn trine progressed Asc. has 9.24 astrodynes. On the same date minor progressed Uranus is 35' from perfect opposition birth-chart Saturn. As these planets are in cadent houses the decimal is .40. Multiplying 9.24 by .40 gives the reinforcement peak as 3.70. Dividing 3.70 by 2 gives 1.85. Multiplying 1.85 by 35 (distance from perfect) gives 64.75. Dividing 64.75 by 60 gives 1.08. Subtracting 1.08 from 3.70 gives 2.62. As birth-chart Saturn is an indirect terminal we divide 2.62 by 2. This gives the power of the minor progressed aspect to reinforce major progressed Saturn trine progressed Asc. on March- 19, 1941, as 1.31 astrodynes.

On March 19,1941, minor progressed Jupiter is 46' from perfect square progressed Asc. As progressed Asc. is in an angle the decimal is .50. Multiplying 9.24 by 50 gives the reinforcement peak as 4.62 astrodynes. Dividing 4.62 by 2 gives 2.31. Multiplying 2.31 by 46 (distance from perfect) gives 106.26. 106.26 divided by 60 gives 1.77. 2.85 minus 1.77 gives the power of the minor progressed aspect to reinforce major progressed Saturn trine progressed Asc. on March 19, 1941, as 2.85 astrodynes.

The total power of a major progressed aspect is the sum of the power of the unreinforced aspect and the power of all the reinforcing minor progressed aspects affecting it on that date. The power of each major progressed aspect and the power of each reinforcing minor progressed aspect, involving Saturn, Uranus and Venus, and their total reinforced power on March 19, 1941, **is given on page 164.**

Calculating the Total Power and Harmony of a Sign or House on a Given Date

—**RULE:** One-half the total power and harmony of a planet due to progressed aspects is added to the sign and house the cusp of which each of the aspecting planets rules. One-fourth if it is an intercepted sign. The total power and harmony of a planet due to progressed aspects is added to the sign and house actually occupied by its terminal directly involved in the aspect, and one-half the total power and harmony is added to the sign and house occupied by its terminal not directly involved in the aspect. The sum of the powers thus indicated added to the normal progressed power of the sign or house gives its total power. And the sum of the harmonies thus

indicated added to the progressed normal harmony of the sign or house gives its total harmony.

On page 164 is given the reinforced power of each of the 11 major progressed aspects in the John Edwards chart involving Saturn on March 19, 1941. Their sum is 695.72 astrodynes. **On page 163** the power of each of the 6 independent minor progressed aspects and the 3 transit aspects to Saturn are given. The sum of the 6 minors is 3.27 astrodynes. The sum of the 3 transit aspects is .15 astrodynes. The total sum is 699.14 astrodynes. Dividing 699.14 by 2 gives 349.57. Page 99 of lesson No. 200 shows the normal major progressed power of Capricorn as 32.61. 349.57 plus 32.61 gives the total power of Capricorn on March 19, 1941, as 382.18 astrodynes.

On page 130 of lesson No. 201 the harmony of each of these 11 major progressed aspects is given. Their net sum is 64.62 discordynes. On page 163 of this lesson the harmony of each of the 6 independent minor progressed aspects and the harmony of each of the 3 transit aspects are given. The sum of the 6 minor aspects is 2.67 discordynes. The sum of the 3 transit aspects is .12 discordynes. The total sum is 67.41 discordynes. Dividing 67.41 by 2 gives 33.71 discordynes. Page 99 of lesson No. 200 shows the normal progressed harmony of Capricorn as 9.24 discordynes. 33.71 plus 9.24 gives the total harmony of Capricorn on March 19, 1941, as 42.95 discordynes.

On page 164 is given the reinforced power of each of the 11 major progressed aspects involving Uranus. Their sum is 500.52 astrodynes. **On page 163** the power of each of the 6 independent minor progressed aspects and the 2 transit aspects involving Uranus are given. The sum of the 6 minor progressed aspects is 2.22 astrodynes. The sum of the 2 transit aspects is 11 astrodynes. The total sum is 502.85 astrodynes. Dividing 502.85 by 4 (Aquarius is intercepted) gives 125.71 astrodynes. Dividing 699.14 (total power of Saturn, co-ruler of Aquarius) by 4 gives 174.79 astrodynes. Page 99 of lesson No. 200 shows the normal progressed power of Aquarius as 9.84 astrodynes. 125.71 plus 174.79 plus 9.84 gives the total power of Aquarius on March 19, 1941, as 310.34 astrodynes.

On page 130 of lesson No. 201 the harmony of each of these 11 major progressed aspects is given. Their net sum is 23.07 discordynes. **On page 163** of this lesson the harmony of each of the 6 independent minor progressed aspects and the harmony of each of the 2 transit aspects are given. The sum of the 6 minor progressed aspects is .17 discordynes. The sum of the 2 transit aspects is neutral. The total sum is 23.24 discordynes. Dividing 23.24 by 4 gives 5.81 discordynes. Dividing 67.41 (total discord of Saturn) by 4 gives 16.85, discordynes. **Page 99** of lesson No. 200 shows the normal progressed harmony of Aquarius as 1.86 discordynes. 5.81 plus 16.85 plus 1.86 gives the total harmony of Aquarius on March 19, 1941, as 24.52 discordynes.

On page 164 is given the reinforced power of the 2 major progressed aspects to birth-chart Venus. Their sum is 71.66 astrodynes. **On page 163** is given the power of each of the 2 independent minor progressed aspects and each of the 2 transit aspects to birth-chart Venus. The sum of the 2 minor progressed aspects is .68 astrodynes. The sum of the 2 transit aspects is .06 astrodynes. The total sum is 72.4,0 astrodynes.

On page 130 of lesson 201 the harmony of each of the 2 major progressed aspects is given. Their net sum is 2.91 discordynes. **On page 163** of this lesson the harmony of each of the 2 independent minor progressed aspects and the harmony of each of the transit aspects is given. The sum of the 2 minor progressed aspects is .13 harmodynes. The sum of the 2 transit aspects is .02 harmodynes. The total sum is 2.76 discordynes.

There are no major progressed aspects involving progressed Venus. **On page 163** is given the power of each of the 2 independent minor progressed aspects and each of the 4 transit aspects. The sum of the 2 minor progressed aspects is .17 astrodynes. The sum of the 4 transit aspects is .14 astrodynes. The total sum is 31 astrodynes.

On page 163 is given the harmony of each of the 2 independent minor progressed aspects and the harmony of each of the 4 transit aspects to progressed Venus. The sum of the two minor progressed aspects is .09 discordynes. The sum of the 4 transit aspects is .02 discordyne. The total sum is .11 discordynes.

Page 100 of lesson No. 200 gives the normal progressed power of the second house as 64.63 astrodynes. 64.63 plus 349.57 (one-half Saturn) plus 174.79 (one-fourth Saturn) plus 125.71 (one-fourth Uranus) plus 72.40 (birth-chart Venus) plus .16 (one-half progressed Venus) gives the total power of the second house on March 19, 1941. as 787.26 astrodynes.

Page 100 of lesson No. 200 gives the normal progressed harmony of the second house as 1.53 discordynes. 1.93 plus 33.71 (one-half Saturn) plus 16.85 (one-fourth Saturn) plus 5.81 (one-fourth Uranus) plus 2.76 (birth-chart Venus) plus .06 (one-half progressed Venus) gives the total harmony of the second house on March 19, 1941, as 60.72 discordynes.

Chapter 7

Serial No. 203
Original Copyright 1947
Elbert Benjamine

Copyright
August 2002
Church of Light

Abdominal Troubles — Bleeding

BIRTH CHART PLANETS

	J	S	V	M	U	H	P
244	01 II 35	05 IX 41	04 II 10	17 IX 09	08 IX 53	10 II 56	19 IX 06 RI 12 IX 48 10 II 05
245	07 III 33	07 VII 04	10 III 54	RI 06 X 30	05 IX 15	08 X 40	19 IX 02 27 18 IX 53 01 II 32 RI 05 II 22 R
246	22 X 56	04 X 02	11 X 26	27 VII 06 RI 25	17 11 19 IX 12	29 II 20 RI 09 IX 04	29 IX 59 RI 01 IX 20 R
7127	22 X 37	20 X 22	09 X 46	12 II 37	07 II 40	21 VII 42 RI 14 IX 14	06 IX 53 29 IX 11 21 X 09
7128	11 VII 00	27 IX 44	02 VII 37	17 X 44	27 IX 39	04 IX 23	14 IX 39 27 IX 57 06 II 03 RI 07 II 15 R
247	27 IX 14	24 IX 17	18 IX 19	RI 00 IX 31	27 IX 14	14 IX 21	17 IX 10 21 IX 31 17 IX 41 RI 25 II 16 R
248	22 VII 38	15 X 59	10 X 36	23 X 53	23 X 57	29 IX 51	17 IX 12 05 IX 55 24 IX 12 RI 19 X 39 R
7132	02 IX 22	08 IX 29	24 IX 36	17 X 06	05 X 28	14 IX 21 RI 10 II 52	06 IX 56 RI 24 IX 51 29 II 35
249	29 VII 67	28 IX 14	24 VII 44	14 IX 19	13 IX 13	12 VII 35	14 IX 32 24 II 03 RI 03 IX 28 RI 10 X 55 R
250	25 X 46	13 X 02	16 II 21	03 X 22 RI 04	II 38	07 IX 33 RI 14 IX 19	18 IX 32 RI 01 II 46 05 II 08
252	15 X 17	07 IX 18	16 X 33	21 II 44	08 IX 22	04 IX 08	02 VII 59 RI 18 VII 00 RI 14 II 24 11 II 31
253	22 VII 43	22 IX 05	16 IX 31	14 IX 06	22 IX 09	15 X 47 RI 25 IX 41	29 X 15 RI 21 IX 14 RI 06 X 14 R
254	19 IX 10	25 IX 39	07 IX 04	09 IX 32	04 VII 44	19 IX 48	03 VII 18 RI 26 IX 30 02 II 03 RI 05 II 10 R
255	12 X 56	16 IX 04	00 IX 14	RI 00 IX 05	24 IX 58	24 IX 23 RI 26 IX 03	05 II 28 RI 24 X 21 06 X 50 R
256	01 IX 56	25 X 01	16 IX 24	04 IX 55	20 IX 35	07 IX 24	23 IX 25 RI 08 IX 45 14 IX 545 24 II 44 R
247 RI 27 IX 14	24 IX 17	12 IX 19	RI 00 IX 31	27 IX 14	14 IX 21	17 IX 10	21 IX 31 17 IX 41 RI 25 II 16 R
257	28 IX 44	04 IX 31	28 IX 59	10 IX 03	03 X 51	22 IX 20	12 IX 10 RI 00 IX 43 RI 08 II 30 RI 07 II 47
258	23 IX 08	00 IX 54	05 VII 08	22 VII 21	06 IX 31	17 VII 59	23 IX 07 RI 7 IX 47 RI 17 IX 10 26 II 31

Referenced Example Birth-Chart Data

No. of House Cusp	BIRTH CHART HOUSE CUUPS		I	II	III
	X	XII			
244	25 27	0 01	29 35	7 23	2 22
245	12 40	7 07	26 07	7 27	3 05
246	28 47	7 14	12 03	7 25	8 02
7127	25 08	8 09	20 26	5 11	0 01
7128	27 39	7 29	23 01	7 21	7 23
247	11 04	0 15	13 15	5 08	7 08
248	12 30	7 25	17 55	7 01	9 12
7132	00 25	5 12	10 27	7 03	7 28
249	19 08	7 02	24 55	7 10	9 21
250	24 20	8 07	20 04	5 10	0 01
252	01 33	5 20	02 56	8 13	11 0
253	19 37	7 22	11 39	7 11	7 14
254	17 34	5 18	02 21	7 05	5 11
255	15 00	7 11	21 13	7 28	7 10
256	27 41	8 04	17 59	0 07	7 00
247A	11 04	5 14	13 15	5 08	7 08
257	25 36	0 29	21 25	7 19	7 21
258	11 52	7 03	07 59	5 20	9 12

Referenced Example Birth-Chart Data

PROGRESSED PLANETS

	☉	☽	♂	♀	♁	♂	♃	♅	♁	♄	♆	♁	♁	♁	♁	♁	♁	♁	♁	♁	♁	
244	19 II 48	22 VII 15	11 I 03	08 I 18	20 IX 07	15 II 20	18 I 30	11 VII 54	R13 I 30	10 II 17	13 II 40	15 VII 20										
245	26 VII 37	25 I 09	07 III 15	29 I 48	19 I 34	12 I 45	20 I 13	19 I 53	01 II 01	R05 II 22	R01 I 44	10 I 01										
246	00 I 51	21 I 32	23 I 24	27 III 32	01 I 01	20 III 40	28 II 41	R09 I 26	29 I 48	01 I 51	R06 I 42	22 I 54										
7127	22 II 14	11 II 50	12 I 35	20 I 07	28 II 39	22 VII 47	14 I 08	02 00 00	00 00	09 21	50 24	45 15										
7128	23 III 06	00 I 17	23 III 08	19 I 37	R06 I 35	05 I 54	15 I 37	28 I 41	05 II 44	07 II 04	09 I 46	02 I 56										
247	04 I 50	07 I 05	06 I 05	27 R00 I 45	R01 I 30	14 I 31	17 I 35	21 I 57	12 I 59	R25 II 09	18 II 10	19 I 56										
248	05 I 36	21 III 59	16 I 30	15 I 27	17 I 16	01 I 19	R21 I 33	05 I 23	34 R18 I 58	R25 I 28	21 I 25											
7132	18 I 33	26 I 18	14 I 21	03 II 05	17 I 38	12 I 11	R12 I 53	06 I 53	16 R25 I 28	00 I 16	36 24	43 18										
249	10 I 05	24 I 20	28 I 14	R28 I 56	01 I 54	24 I 53	18 I 54	R21 II 25	R03 I 54	10 I 18	R29 I 16	20 I 14										
250	07 I 17	12 I 55	24 I 16	22 I 11	04 I 14	02 I 52	R17 I 66	17 I 52	R03 II 19	05 II 08	05 I 51	24 I 02										
252	15 II 22	02 I 16	09 I 02	27 I 39	27 I 22	10 I 26	01 I 09	R16 I 48	R15 II 32	11 II 16	01 I 38	23 I 17										
253	04 I 52	04 I 45	09 I 14	12 I 52	06 I 20	07 I 54	R25 I 26	57 I 19	R45 I 05	50 I 48	04 I 53	01 I 31										
254	03 I 07	04 I 48	06 I 24	03 I 54	26 I 44	27 I 41	00 I 18	R26 I 30	01 II 48	04 I 53	01 I 31	07 I 45										
255	03 I 47	19 I 58	17 I 00	02 I 20	25 I 51	18 I 28	R24 I 07	R03 I 54	R25 I 02	06 I 30	R05 I 51	16 I 02										
256	20 I 40	00 I 40	13 I 37	28 I 40	00 I 56	10 I 21	22 I 09	I 02 14	I 53 24	I 53 24	II 39	I 16 01										
247A	13 I 42	23 I 58	27 I 31	R28 I 06	I 34 14	I 31	R18 I 01	I 28 17	I 53 16	R25 II 00	R27 II 32	27 I 46										
257	04 I 52	10 I 02	15 I 56	R25 I 33	27 I 45	29 I 57	09 I 48	R10 I 02	R08 II 54	09 II 00	01 I 44	19 I 15										
258	14 I 34	27 II 28	09 I 26	19 I 05	05 I 51	R32 I 53	22 I 18	R17 I 16	R08 I 47	26 I 41	R03 I 18	04 I 29										

Referenced Example Birth-Chart Data

Chapter 7

Abdominal Troubles—Bleeding

TO make the instructions on stellar dynamics complete, in lesson No. 202 it was explained how to find the reinforcement power of minor progressed aspects on any date while they were within orb, and how to calculate the total power and harmony or discord of any sign or house on any date. Such calculations, however, are more academic than practical. Seldom will there be a valuable use for them.

Life is a complex pattern, in which the major interlacing threads are indicated by the major progressed aspects. The independent minor progressed aspects indicate very much smaller threads crisscrossing the pattern. The reinforcing effects of the minor progressed aspects are like beads along the major interlacing threads. To change the comparison, usually they are minor events leading to, climaxing, or resulting from. the main event indicated by the major progressed aspect they reinforce. They mark the stages in the evolution, and the subsequent progeny of an event.

Except through their influence as Rallying Forces, commonly each major progressed aspect stimulates the thought-cells affected to work for a different and characteristic condition or event. The condition or event may add to the difficulty or favor indicated by other progressed aspects affecting the same house, but commonly it is another phase of the matter, or a further development of conditions and events past or present. Thus while the total power of a house on a given date may indicate the total activity of the thought-cells concerned with this department of life, it is unlikely this total activity relates to one event. Usually it indicates thought-cells working for a variety of events, the effort toward each expending the energy and the harmony or discord of one of the progressed aspects which at the time are within orb.

What is commonly needed, therefore, for stellar diagnosis relative to any department of life, including health, and as a guide to the precautionary actions that should be taken, is the birth-chart power and harmony or discord of each of the planets, the peak relative harmony or discord of each of the significant major progressed aspects, and when, during the time the major progressed aspect is within orb, there are peaks of power due to the reinforcement effect of minor progressed aspects.

The birth-chart power and harmony or discord of the planets indicate the predispositions.

The reinforced peaks of power of a major progressed aspect afford a fair estimate of the energy of the thought-cells at those times to exert more than normal pressure characteristic of the planets involved on the thoughts, behavior and environment.

The harmony or discord which exerts pressure on the thoughts, behavior and environment cannot be estimated by the harmony or discord of the progressed aspect alone. The thought-cells influenced by the progressed aspect have their birth-chart harmony or discord. This may be considered their lifetime normal. An independent minor progressed aspect may coincide with a minor disagreeable or favorable event deviating from the normal; but its relative effect on the period in which it occurs is but a slight deviation from the normal harmony or discord; a deviation to be measured by the relative harmony or discord of the minor progressed aspect to the normal harmony or discord of the planets involved.

The harmony or discord of a major progressed aspect between two planets is also a deviation from the normal harmony or discord of the thought-cells. The harmony or discord added to the thought-cells by a progressed aspect alters their birth-chart harmony or discord only by the number of harmodynes or discordynes added to their birth-chart harmodynes or discordynes.

If, as frequently happens, the major progressed aspect is between two planets one of which at birth had many harmodynes and the other at birth had many discordynes, the average benefit or detriment of the events influenced by the aspect may very closely be indicated by the average harmony or discord of the aspect, yet at the same time some of the events or conditions may markedly benefit the departments of life ruled by the harmonious birth-chart planet and some of the events, or the same events, may markedly be a detriment or loss to the departments of life ruled by the discordant birth-chart planet. For instance, the death of a loved one may mean a grave personal loss, but may also bring a financial inheritance of much value. Or a harmonious marriage may bring the estrangement of friends who oppose it.

In diagnosis and in determining *precautionary actions* it is desirable to know not merely the peak harmony or discord of the significant major progressed aspect, but to what extent the harmony or discord the thought-cells had at birth is modified at the time the aspect reaches its maximum power.

Calculating the Relative Harmony Due to a Major Progressed Aspect

—As explained in lesson No. 201, except when a major progressed planet makes an aspect to its birth-chart place every major progressed aspect has four terminals. Lesson No. 199 explains how to calculate the birth-chart harmony or discord of a planet. The normal progressed harmony of a planet is the number of harmodynes or discordynes it carries with it wherever it moves after birth apart from those acquired

through progressed aspects. On page 70 of lesson No. 200 is explained that a major progressing planet carries with it one-half its birth-chart harmony or discord plus one-half the harmony or discord given it by the essential dignity of the sign it occupies by progression. Major progressed Moon thus carries not one-half, but one-fourteenth.

Disregarding progressed essential dignity and how many house cusps, and therefore how many departments of life, may be influenced by each of the four terminals, the approximate average relative harmony of a major progressed aspect may be found in this manner:

RULE: To $1\frac{1}{2}$ times the algebraic sum of the birth-chart harmony of the two planets, algebraically add 3 times the peak harmony of the progressed aspect and divide the sum thus obtained by 4. If the progressed aspect is made by the Moon, to the algebraic sum of the birth-chart harmony of the two planets, algebraically add $\frac{1}{2}$ the harmony of the non-lunar birth-chart planet, plus $\frac{1}{14}$ the birth-chart harmony of the Moon. To this sum algebraically add 3 times the peak harmony of the progressed aspect of the Moon and divide the sum thus obtained by 4. The result so obtained will be the approximate average relative harmony of each of the four terminals.

If the aspect is from a major progressed planet to its birth-chart place, the algebraic sum of $\frac{3}{4}$ its birth-chart harmony and the harmony of the progressed aspect gives the approximate average relative harmony of each of the two terminals. If the aspect is from major progressed Moon to its birth-chart place, the algebraic sum of $\frac{15}{28}$ its birth-chart harmony and the harmony of the progressed aspect gives the approximate average relative harmony of each of the two terminals.

The approximate average relative harmony of each terminal influenced by a major progressed aspect will give a good general idea of the average amount of help or hindrance to be expected from it. But to estimate how much help or hindrance may be expected from each of the terminals separately, the following rule will serve all practical purposes.

RULE: To find the relative harmony or discord of each terminal, algebraically add the number of harmodynes or discordynes of the progressed aspect at that time to the normal number of harmodynes or discordynes of each terminal directly involved in the aspect, and one-half the number of harmodynes or discordynes of the progressed aspect at that time to the normal number of harmodynes or discordynes of each terminal not directly involved in the aspect.

On page 39 of lesson No. 199 is given the harmony of each birth-chart terminal in the John Edwards chart. And on page 58 of lesson No. 200 is given the normal harmony of each major progressed terminal in the chart during the years near and including 1941. And in lesson No. 201 the peak power and the peak harmony of the major progressed aspects now to be considered are calculated.

Progressed Saturn sextile birth-chart Pluto has a peak harmony of 8.97 harmodynes. 15.75 discordynes (birth-chart Saturn) plus 4.49 harmodynes (one-half 8.97 as it is

an indirect terminal) gives the relative harmony of the birth-chart Saturn terminal as 11.26 discordynes. 7.38 discordynes (progressed Saturn) plus 8.97 harmodynes (direct terminal) gives the relative harmony of the progressed Saturn terminal as 1.59 harmodynes. 17.10 harmodynes (birth-chart Pluto) plus 8.97 harmodynes (direct terminal) gives the birth-chart Pluto terminal the relative harmony of 26.07 harmodynes. 8.55 harmodynes (progressed Pluto) plus 4.49 harmodynes (one-half 8.97 as it is an indirect terminal) gives the relative harmony of the progressed Pluto terminal as 13.04 harmodynes.

15.75 discordynes (birth-chart Saturn) plus 17.10 harmodynes (birth-chart Pluto) gives 1.35 harmodynes. 1.35 plus .68 (one-half of 1.35) gives 2.03 harmodynes. Multiplying 8.97 (peak harmony) by 3 gives 26.91 harmodynes. 26.91 plus 2.03 gives 28.94. Dividing 28.94 by 4 gives the approximate average relative harmony of the aspect as 7.24 harmodynes.

Progressed Sun semi-square progressed Uranus has a peak harmony of 8.87 discordynes. .86 harmodynes (birth-chart Uranus) plus 4.44 discordynes (one-half 8.87 as it is an indirect terminal) gives the relative harmony of the birth-chart Uranus terminal as 3.58 discordynes. .43 harmodynes (progressed Uranus) plus 8.87 discordynes gives the relative harmony of the progressed Uranus terminal as 8.44 discordynes. 5.07 harmodynes (birth-chart Sun) plus 4.44 discordynes (one-half 8.87 as it is an indirect terminal) gives the relative harmony of the birth-chart Sun terminal as .63 harmodynes. 4.54 harmodynes (progressed Sun) plus 8.87 discordynes gives the relative harmony of the progressed Sun terminal as 4.33 discordynes.

5.07 harmodynes (birth-chart Sun) plus .86 harmodynes gives 5.93. 5.93 plus 2.97 (one-half of 5.93) gives 8.90 harmodynes. Multiplying 8.87 (peak harmony) by 3 gives 26.61 discordynes. 8.90 harmodynes plus 26.61 discordynes gives 17.71 discordynes. Dividing 17.71 by 4 gives the approximate relative harmony of the aspect as 4.43 discordynes.

Progressed Moon square progressed Venus has a peak harmony of 1.94 discordynes 8.21 harmodynes (birth-chart Venus) plus .97 discordynes (one-half 1.93 as it is an indirect terminal) gives the relative harmony of the birth-chart Venus terminal as 7.24 harmodynes. 5.61 harmodynes (progressed Venus) plus 1.93 discordynes gives the relative harmony of the progressed Venus terminal as 3.68 harmodynes. 6.76 discordynes (birth-chart Moon) plus .97 discordynes (one-half 1.93 as it is an indirect terminal) gives the relative harmony of the birth-chart Moon terminal as 7.73 discordynes. .48 discordynes (progressed Moon) plus 1.93 discordynes gives the harmony of the progressed Moon terminal as 2.41 discordynes.

8.21 harmodynes (birth-chart Venus) plus 6.76 discordynes (birth-chart Moon) plus 4.12 harmodynes (one-half birth-chart Venus) plus .48 discordynes (one-fourteenth birth-chart Moon) gives 5.09 harmodynes. Multiplying 1.93 by 3 gives 5.79 discordynes. 5.79 discordynes plus 5.09 harmodynes gives .70 discordynes. Dividing .70 by 4 gives the approximate relative harmony of the aspect as .18 discordynes.

Precautionary Actions and Self Treatment

—The birth-chart and progressed constants of the 160 diseases (now expanded from the original 120) which now follow in alphabetical order, and the brief instruction for the stellar treatment of each, will be found valuable alike to the professional healer and the layman. Before the disease develops, as well as when it is present, the individual can apply to himself all the five steps embraced in stellar healing:

1. The layman who is capable of erecting and progressing his own chart, as an increasing number now are, will know from the astrological constants toward what diseases he has a predisposition, when they are most apt to develop, and what precautionary actions he should take.
2. The birth-chart and progressed constants thus shown will indicate, as given in lesson No. 201, the healing thoughts he should apply to himself. The type of thoughts which he should thus chiefly employ are those ruled by the same planet as the energy which is advocated in the specific stellar treatment of the disease.
3. By studying B. of L. Courses 3, 5, 9 and 14 he will know how, and in what direction, to change his attitude and his thinking advantageously. And the birth-chart and progressed constants of the disease will also indicate, as given in lessons No. 153, 222, 223, 224 and 225, his special food requirements.
4. He can talk to such of his organs or functions as are not doing their work properly, and give them suggestions that will encourage them to healthy activity.
5. He can apply the indicated planetary energy to the region needing such special stellar treatment by tuning in on it, as explained in lesson No. 200, and directing it to the proper zone by, holding the region steadfastly before his attention.

ABDOMINAL TROUBLES

Birth-chart constants: In nine cases out of ten an afflicted planet actually in the zone where the disease manifests, and in the other one case out of ten the planet ruling the zone, but elsewhere located, severely afflicted. Cancer rules the stomach, Virgo rules the duodenum and intestines, Libra rules the upper kidneys, the ovaries and internal generative organs, and Scorpio rules the bladder, sigmoid flexure, prostate gland, uterus and external generative organs.

Progressed constants: Depend upon the nature of the disease, but when a planet in the zone receives an adverse aspect is the most common factor. When there is an operation performed there is always a progressed aspect involving Mars. The organs and regions ruled by Libra and Scorpio are so closely associated in their functions that an affliction from one commonly affects the other.

Stellar Treatment: Should be applied to the zone where the disease manifests and to the zones occupied by the birth-chart and progressed planets mapping it. The planetary energy used varies according to the nature of the disease and its constants.

Example: Chart 244. Female, May 22, 1894, 11 :59 a.m. 97W. 36N. Venus (internal sex organs) opposition Saturn in Libra. May, 1913, as progressed, with Venus sextile Mars r, Mercury trine Uranus p in Scorpio, Sun trine Saturn r, and Sun square Mars p, had three serious major operations on the abdominal cavity.

ABSCESS

Birth-chart constants: Prominent and usually afflicted Neptune or Pluto, and a prominent and usually afflicted Mars. Afflictions to either Neptune or Pluto depress the production of cortin, the strongest chemical with which the body fights toxins and infection. Afflictions to Mars tend to exhaust both adrenaline and cortin.

Progressed constants: Progressed aspects, usually afflictions, involving both Mars and Neptune, or involving both Mars and Pluto. The low output of cortin hormone results in the incomplete metabolism of protein foods, with an accumulation of toxins. The Mars influence tends to inflammation and to attract infection.

Stellar Treatment: Harmonious Sun energies should be applied to the zone occupied by Neptune or Pluto, whichever seems most responsible, with a view to overcoming the negativeness. The planetary antidote may also be used. Where Mars is located in the chart, and where the abscess is located in the body, should receive the soothing, clear green planetary energy of the Moon.

Example: Chart 245. Female, Oct. 30, 1888, 8:00 a.m. 70:15W. 44:40N. Neptune and Pluto opposition Venus and Jupiter and square Moon. Mars sextile Sun and Mercury and trine Moon. 1907, as progressed, M.C. trine Neptune r, Venus inconjunct Neptune p, Uranus sesqui-square Pluto p, Mars square Uranus p and sesqui-square Pluto p. An abscess formed under one of her arms (left), where Neptune and Pluto are located.

ACCIDENT

Birth-chart constants: Mars, Saturn, Uranus or Pluto prominent in the order of importance given. The detailed analysis of 100 charts progressed to the time of an accident is given in the reference book, WHEN AND WHAT EVENTS WILL HAPPEN²

Progressed constants: For accidents involving violence, including burns, falls, bruises, broken bones, wounds and drowning, there is always a progressed aspect within one-and-a-half degree of perfect³ involving the planet Mars. A progressed affliction to Saturn, Uranus or Pluto, in addition to the progressed aspect involving Mars, increases the hazard. In asphyxiation and poisoning the Mars influence may be lacking, but in such instances there is always, even in poisoning by snakebite or spider bite, a progressed aspect involving Neptune.

Stellar Treatment: For prevention, the zones occupied by birth-chart and progressed Mars should be given Moon planetary energy, and the planetary antidote should be applied to Saturn, Uranus or Pluto if it is heavily afflicted at birth or by progression. After the accident, similar treatment may be used.

Example: Chart 246. Male, Dec. 15, 1914, 10:05 a.m. 118:15W. 34N. Mars conjunction Sun and opposition Saturn and Pluto. On Sept. 20, 1922, as progressed, with Mercury semi-square Uranus r, Sun conjunction Mars p, and Sun opposition Pluto p, backed into a tub of boiling water. He died shortly as the result of the burns.

ACIDOSIS

Birth-chart constants: Either a very prominent Jupiter or a very prominent Saturn, or both, usually afflicted.

Progressed constants: Almost any progressed aspect which affects the health adversely through surfeit, through faulty elimination, through food deficiency, or which through worry, anger or constant irritation depletes the adrenaline supply, will increase this condition. But particularly any aspect to the planet which by its prominence and birth-chart aspects maps the predisposition to the difficulty. The Saturn type results from the lack of something. The lack of mineral salts with which to neutralize the lactic acid and the acid toxins gives rise to this deficiency type of acidosis. The Jupiter type results from too much of something. The eating of too rich foods and too much fat tends to load the blood stream with more than can be burned, and the diacetic and other fatty acids liberated in the blood stream give rise to the repletion type of acidosis.

2 Out of print, see }{\plain \ifl Astrology: 30 Years Research} {\plain \fl .

3 Research shows that one degree is always valid.

Stellar Treatment: First of all a proper diet should be insisted upon. If the condition is mapped by Jupiter, the planetary energy of Mercury should be applied directly to the zone of the body mapped by Jupiter in the birth-chart. If the condition is due to Saturn, the planetary energy of Venus should be applied directly to the zone of the body mapped by Saturn in the birth-chart. Often both planetary antidotes need thus to be applied.

Example: Chart 7127. Female, May 13, 1874, 6:25 a.m. 120:30W. 41:30N. Saturn square Mercury and opposition Uranus. Jupiter angular and trine Sun. Spring, 1905, as progressed, with Sun square Jupiter p, and Mars sesqui-square Saturn p, had severe acidosis.

ACNE

Birth-chart constants: Venus afflicted; usually heavily afflicted.

Progressed constants: A progressed aspect involving Venus or Mars, usually both. Gonad (Mars Venus) glandular disturbance also affects the glands of the skin (Venus), and when there is also a progressed aspect involving Mars, the eruption—which may or may not have a blackhead centre—is attacked by microbes. If Venus is not too heavily afflicted the acne subsides after the period of adolescent gland adjustment.

Stellar Treatment: Rigorous diet in which cane sugar sweets and rich foods are absent. Harmonious Saturn planetary energy applied to the zone occupied by Venus. Also harmonious Moon energy applied to the zone occupied by Mars.

Example: Chart 7128. Male, Nov. 3, 1890, 5:00 a.m. 87:5SW. 43:02N. Venus square Saturn, semi-square Mercury, semi-square Jupiter. Fall, 1902, as progressed, with Venus semi-square Jupiter r, Mars conjunction Jupiter p, trine Neptune r, trine Pluto p, developed acne. In later life suffered from overweight (Moon and Jupiter angular) and face gets quite red and perspires easily (Mars opposition Moon and square Uranus).

ADENOIDS

(Same constants and treatment for nasal polypus.)

Birth-chart constants: Affliction in Libra or Scorpio, or their ruler severely afflicted, especially if at the same time there is an affliction in Aries.

Progressed constants: Progressed aspect involving Venus or Mars, usually an affliction. Scorpio rules the nose and the lower kidneys. Venus rules the upper kidneys and also the pharyngeal tonsil, the enlargement of which constitutes adenoids. These nasal difficulties arise from kidney disturbances which prevent the proper filtering and handling of the urine.

Stellar Treatment: The planetary antidote energy of the affliction in Libra or Scorpio or its afflicted ruler should be applied to the kidney region, and its planetary antidote should be applied to the region occupied by the responsible progressed Venus or Mars. To stop the swelling or growth, the kidneys must be strengthened.

Example: Chart 247. Male, Jan. 17, 1910, 9:00 p.m. 122:10W. 37:30N. Jupiter in Libra opposition Saturn and Moon in Aries, Mars in Aries conjunction Moon and Saturn and square Uranus and the Sun. By July, 1917, as progressed, with Venus sextile Mars p, the adenoids had become so severe that both adenoids and tonsils (Venus) were removed.

ADHESIONS

Birth-chart constants: A prominent and usually afflicted Saturn, especially when afflicting the organ operated upon.

Progressed constants: A powerful progressed aspect involving Saturn, usually an affliction.

In the healing process following an operation, scar tissue forms which, when it constricts, binds, or unduly unites, is called an adhesion. To free the adhered tissues, the first operation may be followed by a second, and this may be followed by a third or more operation.

Stellar Treatment: Venus planetary energies should be applied to the place of Saturn in the birthchart, and to the place in the body where the adhesion occurs. To break down the adhesion the masseur manipulates violently, and the surgeon cuts through them with a knife. Venus energies afford the proper precautionary treatment; but in addition to these, after the adhesion starts to form, Mars planetary energies may be applied to the adhering tissues to help break them down.

Example: Chart 248. Female, Nov. 14, 1872, 11 :00 a.m. 74W. 40:43 N. Saturn conjunction Asc., square Neptune, sextile Sun, trine Moon and trine Mars. March, 1915, as progressed, there was an operation for fibroid tumor and ovarian trouble. Progressed Mars had just reached the square of Saturn r, and the operation was immediately followed by unusually severe adhesions.

ALCOHOLISM

Birth-chart constants: Prominent and usually heavily afflicted Mars. An aspect of Mars to the Moon increases the predisposition, especially if it is an affliction. Those who become habitual drunkards usually also have a prominent and usually afflicted Neptune.

Progressed constants: A progressed aspect, usually an affliction, involving Mars; and commonly also a progressed aspect involving Neptune.

Stellar Treatment: The patient should be kept where unable to obtain alcoholic drink of any kind for some weeks, during which time the healer should, by means of suggestion, education, and applying the proper thoughts charged with planetary energy, try to harmonize the inner conflict from which the patient is trying to escape through getting drunk. This inner discord, from which the patient temporarily escapes through inebriation, may or may not be closely associated with the Mars thought-cells. This conflict within the unconscious mind must be located and its contending factions reconciled. Until the nerves become stable, the patient should take Vitamin B-1 in large amounts.

Example: Chart 7132. Female, June 24, 1913, 7:45 a.m. 75:14W. 43:06N. Mars conjunction M.C., sextile Sun, sextile Moon, square Uranus; Mercury conjunction Neptune. June, 1930, as progressed, with Mars semi-square Sun r and sextile Sun p, Neptune semi-square Saturn r, Asc. semi-sextile Neptune r, took to drink and still drinks heavily (1947).

AMNESIA

Birth-chart constants: Prominent, and usually afflicted, Mercury and Moon.

Progressed constants: Afflictions to Mercury or the Moon at the same time there are heavy afflictions to Neptune or Pluto.

Stellar Treatment: Mercury or Moon, whichever is afflicted by progressed aspect should receive the planetary energy of its antidote. And in particular, the place of the progressed afflicted Neptune or Pluto should receive the orange planetary energy of the Sun to build up positive resistance to invading vibrations.

Usually loss of memory is coincident with toxic poisoning or some other serious bodily disturbance which should also receive treatment according to its nature.

Example: Chart 249. Male, Nov. 22, 1863, 11:02 a.m. 93:30W. 41:15N. Mercury conjunction M.C. and Mars, inconjunct Uranus. Moon square Asc. Nov. 1, 1932, as progressed, with Mercury square Moon r, Sun square Pluto r, there was a temporary loss of memory. Again on Oct. 10, 1933, while the same progressed aspects were in force, there was another temporary loss of memory.

ANEMIA

Constants for pernicious anemia the same except more heavily afflicted.

Birth-chart constants: Neptune and Saturn prominent, and usually severely afflicted. Mars also afflicted.

Progressed constants: An aspect involving Mars, and usually one also involving Saturn or Neptune, at the same time there is a heavy progressed affliction. Jupiter is usually, but not always, involved.

Stellar Treatment: Anemia is oxygen starvation due to too little of the red hemoglobin in the red blood corpuscles, or too few red blood corpuscles. In addition to the proper foods to build red blood corpuscles, as explained in lesson No. 225, there must be sufficient of the adrenalin hormones for handling the essential proteins. As both Saturn and Neptune depress the manufacture of these secretions, Sun planetary energy should be applied to the zones occupied by these planets to overcome their negative action. The Sun planetary energy will also aid the thyroid in energy production. The afflicted Mars zone should be harmonized and strengthened through the application of Moon planetary energy. Proper diet and harmonious positive thinking are essential.

Example: Chart 250. Male, May 16, 1889, 6:00 a.m. 87:50W. 42N. Saturn in harmonious aspect with Mercury and the Moon, and thus prominent. Neptune conjunction Sun, Mars and Pluto. Mars heavily afflicted through conjunction Neptune and Pluto and opposition Moon. Suffered pernicious anemia, and on Oct. 6, 1932, as progressed, with Mars sextile Venus r and semi-sextile Neptune p, and Saturn sextile Uranus p, had a severe attack and was taken to a hospital for a blood transfusion. The heavy affliction at the time was Sun opposition Jupiter r.

APPENDICITIS

A complete report based on 100 charts of those who have suffered from this disease is given in the reference book, BODY DISEASE AND ITS STELLAR TREATMENT.⁴

Birth-chart constants: Uranus and Mars both prominent, and usually afflicted.

Progressed constants: Progressed aspect involving Uranus and progressed aspect involving Mars at the same time there is a heavy progressed affliction. This is a typical Uranus disease, and high nervous tension commonly precedes an attack. Overwork, prolonged irritation, or any condition which exhausts the adrenalin supply and thus decreases the ability of the system to resist infection also contributes to it.

Stellar Treatment: Diet and thought treatment should have for their object the restoration of normal activity to the parathyroid glands. Jupiter planetary energy should be applied to the zone mapped by Uranus. Moon planetary energy should be applied to the zone mapped by Mars, and to the appendix to reduce the inflammation.

Example: Chart 252. Male, May 6, 1895, 3:00 a.m. 18E. 41N. Uranus opposition Sun and Mercury, Mars angular and square Moon. August 23, 1926, as progressed, with Venus conjunction Mars p, Mercury conjunction Mars r, operation for appendicitis performed too late, as poison had already spread through system, and he died. Progressed Sun is less than a degree and a half from inconjunct Uranus p, and its conjunction with Neptune and sesqui-square Saturn p, acted as rallying forces.

4 Out of print, see } {\plain \f1 Astrology: 30 Years Research} {\plain \f1 .

ARTERIOSCLEROSIS

Birth-chart constants: Jupiter and the upper-octave planets prominent, and usually afflicted.

Progressed constants: A progressed aspect, usually an affliction, involving one or more of the three upper-octave planets, Uranus, Neptune or Pluto.

Stellar Treatment: Two of the conditions which commonly contribute to hardening of the arteries are the repletion (Jupiter) type of acidosis, and insufficient parathyrin properly to handle calcium. The diet, therefore, should avoid rich food and use care with sugar and fats, and should be rich in calcium, vitamin B-1, and vitamin D. Mercury planetary energy should be applied to the zone occupied by Jupiter, and the planetary energy of its antidote should be applied to the zone occupied by the responsible thought-cells mapped by the upper-octave planet.

Example: Chart 253. Male, September 15, 1857, 9:50 a.m. 84:30W. 39N. Jupiter square M.C.. Moon and Mars; Pluto opposition Asc., Neptune opposition Sun, Uranus sesqui-square Mercury.

March 8, 1930, as progressed, with Jupiter sesqui-square Sun r, Sun inconjunct Pluto p, Mars inconjunct Pluto r, and Mars semi-square Mars r and Moon r as rallying forces, died of hardening of the arteries.

ARTHRITIS

Birth-chart constants: Saturn and Uranus prominent, usually severely afflicted.

Progressed constants: An aspect, usually an affliction, involving Saturn.

Stellar Treatment: Saturn, through depressing the functions, and depriving the system of essential vitamins and minerals, causes certain elements in the blood stream, which normally enter into harmless compounds but are unable to do so while chemical imbalance lasts, to crystallize out and become deposited where they do damage. High tension, induced by Uranus, depletes the parathyrin, which must be present to handle calcium and keep the blood stream in chemical balance. Calcium, vitamin B-1 and vitamin D are needed to assist the parathyroid glands, and variety of mineral salts, vitamins and proteins to overcome the deficiency present. Venus planetary energy should be applied to the zone occupied by Saturn, and Jupiter planetary energy to the zone occupied by Uranus.

Example: Chart 254. Male, Jan. 9, 1890, 4:00 a.m. 90:20W. 39:45N. Saturn sesqui-square Sun, square Asc. Uranus square Sun, sextile Moon. In 1931, under Sun opposition Saturn p, developed arthritis. May 15, 1933, as progressed, with Sun and Venus both opposition Saturn r, became pronouncedly worse due to unwise diet.

ASTHMA

Birth-chart constants: Mercury afflicted, and one or more of the upper-octave planets (Uranus, Neptune, Pluto) prominent and afflicted. Either afflictions in Gemini, or Mercury receiving heavy aspects.

Progressed constants: An aspect involving Mercury or a planet in Gemini.

Stellar Treatment: As asthma is a nervous disease, the diet should be such as to enable the parathyroid glands to function better. In particular it should contain abundant calcium, vitamin B-1, and vitamin D. The nervous tension of the individual should be reduced through the application of Jupiter thinking and the application of Jupiter planetary energy to the zone occupied by Mercury; also to the zone occupied by Uranus if this planet is involved. If Neptune or Pluto is involved, the planetary energy of its antidote should be applied to the zone it occupies, to the end of decreasing the nervous tension and sensitiveness.

Example: Chart 255. Male, Dec. 5, 1859, 8:00 a.m. 79W. 42:50N. Mercury square Neptune, Pluto sesqui-square Asc., Sun opposition Uranus in Gemini. December, 1909, as progressed, with Sun trine Uranus p in Gemini, Mercury square Moon r, and the rallying force Mars square Saturn r, developed asthma from which he did not recover for seven years.

ATROPHY

Birth-chart constants: Saturn prominent and afflicted.

Progressed constants: Heavy afflictions to Saturn, or less severe aspects to Saturn at the same time there are heavy adverse rallying forces.

Stellar Treatment: This starving, or wasting away, of the tissues arises from any one of several diseases of the Saturn type. Therefore, the disease which it accompanies must receive appropriate treatment. Either the proper vitamins and minerals are lacking in the diet, or the system, when they are present, is unable properly to assimilate them. If, for instance, through mineral deposits resulting from chemical imbalance, the blood supply does not reach the tissue, it will atrophy. As the blood supply tends to follow the nerve currents, Sun electromagnetic energy applied to the part affected is beneficial. Sun planetary energy should be applied as directly as possible to the atrophying tissue. The other planetary energy to be used, in addition to those to correct the specific disease responsible for the atrophy, is that of Venus applied both to the zone occupied by Saturn, and to the tissues most affected.

Example: Chart 254. Male, Jan. 9, 1890, 4:00 a.m. 90:20W. 39:45N.

Saturn elevated, sesqui-square Sun and Jupiter, square Neptune and Pluto. May 15, 1933, as progressed, with Sun and Venus opposition Saturn r, his lower limbs

commenced rapidly to waste away as a result of arthritis which he had had for two years.

AUTOINTOXICATION

Birth-chart constants: Saturn and Mars prominent and usually afflicted, and either Neptune or Pluto also prominent and usually afflicted.

Progressed constants: An aspect, usually an affliction, involving Mars.

Stellar Treatment: The body depends on adrenalin, ruled by Mars and Saturn, and cortin, ruled by Mars and Pluto, to conduct chemical warfare on bacteria and to neutralize toxins. Afflictions involving Saturn or Mars tend to deplete the supply of adrenalin. Afflictions involving Mars tend to deplete the supply of cortin. Afflictions involving Neptune or Pluto tend to suppress the manufacture of cortin. With the system saturated with toxins, when a progressed aspect involving Mars forms, focal infection develops. The diet, therefore, and the treatment, should be to encourage the manufacture of adrenalin and cortin. The zone occupied by Mars should be given Moon planetary energy. Venus planetary energy should be applied to the zone occupied by Saturn, and the energy which is its planetary antidote should be applied to the zone occupied by Neptune or Pluto.

Example: Chart 256. Female, Sept. 25, 1907, 11:20 p.m. 71W. 42N. Saturn opposition Sun and square Pluto, Mars opposition Asc. and Neptune. Nov. 24, 1926, as progressed, with Sun square Mars r, and Asc. opposition Mars p, autointoxication became so severe that the mind (M.C. opposition Mercury r) began to fail.

BED WETTING

Birth-chart constants: Heavy affliction in Libra, or less commonly in Scorpio; or a prominent and afflicted Uranus.

Progressed constants: Progressed aspect involving planet in Libra or Scorpio, or affliction involving Uranus.

Stellar Treatment: There may be, as indicated by the planet in Libra or Scorpio, a condition of the kidneys and bladder which makes retention of the urine impossible. The planetary energy of its antidote should be applied to the zone where this planet is located. On the other hand, as indicated by a prominent and afflicted Uranus, the condition may arise through lack of nerve control. Diet should have abundant calcium, vitamin B-1 and vitamin D. Jupiter planetary energy should be applied to the zone occupied by Uranus. This condition in children often arises from a mental condition. In such cases whipping the child increases the difficulty, as fear decreases nervous control. Psychoanalysis, and the application of suggestion during treatment at the fifth station should be used instead. A calm, confident state of mind, free from rebellion against real or imaginary injustice favors improvement.

Example: Chart 247. Male, Jan. 17, 1910, 9:00 p.m. 122:10W. 37:30N. Jupiter in Libra square Neptune, square Uranus, and opposition Moon and Saturn. Progressed Neptune was parallel Uranus r throughout life. When small he was repeatedly whipped for bed wetting.

BILIOUSNESS

Birth-chart constants: Jupiter prominent and afflicted, or heavy afflictions involving the Moon or an afflicted planet in Cancer.

Progressed constants: Progressed aspect, usually an affliction, involving Jupiter, Saturn, or the Moon.

Stellar Treatment: So-called bilious attacks are due to taking into the stomach more food than it can handle, or kinds of food it cannot handle. To a person who customarily overloads his stomach, even a slight aspect of progressed Moon to Saturn may bring on a bilious attack. Saturn depresses the vitality and thus the stomach has insufficient energy to do its work. Jupiter overloads the stomach and gives it more work than it can do. The stomach should be given a rest, and when eating is resumed the diet should be carefully selected, and meals should be spaced sufficiently to complete digestion. Both Venus and Sun planetary energy should be applied to the zone occupied by Saturn, if its thought-cells are the cause of the difficulty. If the Moon thought-cells are chiefly responsible, the zone it occupies should receive Mars planetary energy. If Jupiter thought-cells are the chief offenders, Mercury planetary energy should be applied to the zone it occupies.

Example: Chart 247A. Male, Jan. 17, 1910, 9:00 p.m. 122:10W. 37:20N. Jupiter opposition Saturn, both square Uranus, Moon conjunction Mars and square Sun. During the whole time Sun was trine Jupiter suffered from bilious attacks. Especially severe early April, 1926, as progressed, with Sun trine Jupiter r, Saturn square Neptune r, Mercury square Mars r, and Moon inconjunct Moon r.

BLADDER TROUBLE

Birth-chart constants: Affliction in Scorpio, or less frequently a severe affliction involving Mars or Pluto.

Progressed constants: An aspect to the afflicted planet in Scorpio, or a heavy affliction involving Mars or Pluto.

Stellar Treatment: The zones occupied by the planetary constants of the responsible disease should receive the planetary energy of their antidotes. The energy of its planetary antidote should be applied to the zone occupied by the afflicted planet in Scorpio. If Mars or Pluto is involved, as is usually the case, Moon planetary energies should be applied to the zone occupied by this planet, and to the region of Scorpio. Both the planetary energy of the Moon, and the soothing

electromagnetic energy of the Moon, applied directly to the region over the bladder are highly beneficial in all bladder difficulties.

Example: Chart 257. Female, Feb. 16, 1893, 10:12 p.m. 77:40W. 42:40N. Uranus in Scorpio opposition Mars, Pluto square Moon. April 15, 1929, as progressed, with Venus sesqui-square Uranus r in Scorpio, Pluto semi-square Jupiter r, and Mars square Sun r, had an infected throat accompanied by severe trouble with the bladder.

BLEEDING

Birth-chart constants: A prominent and afflicted Saturn and a prominent and afflicted Neptune.

Progressed constants: An aspect involving Mars, and commonly also an aspect involving Saturn or Neptune.

Stellar Treatment: The ability of the blood to coagulate is largely determined by the amount of adrenalin present in the blood stream. Vitamin K also promotes the clotting of blood and helps prevent profuse bleeding. In those who are chronic bleeders, suffering from hemophilia, which is usually hereditary, there is a tendency to profuse and uncontrollable hemorrhage, even from the slightest wounds.

When excessive bleeding takes place, either from these chronic bleeders, or in the case of a person who normally does not thus bleed, the progressed influence will be found to be an aspect involving Mars. This is commonly true in excessive menstruation as well as in bleeding caused by injury. Afflictions to either Mars or Saturn tend to deplete the adrenaline supply. The diet, thought-treatment, and planetary energy applied, therefore, should have for their end the strengthening of the adrenal glands. Vitamin K should be included in the diet to assist coagulation.

The zones in which Saturn and Neptune are located should receive the planetary energy of their antidote, and also Sun planetary energy to give the thought-cells greater vigor and stability. The zone occupied by Mars should be treated with Moon planetary energy.

Example: Chart 258. Male, Aug. 16, 1909, 5:30 p.m. 7:30E. 50N. Saturn square Uranus and Neptune, Neptune opposition Uranus. He is a chronic bleeder. Blood does not clot even from a slight cut. October, 1931, as progressed, with Saturn inconjunct Sun r, Venus square Neptune p, and Mars inconjunct Mercury r, he had a tooth pulled, and it required two blood transfusions to save his life.

Chapter 8

Serial No. 204
Original Copyright 1947
Elbert Benjamine

Copyright
August 2002
Church of Light

Blindness — Coronary Thrombosis

BIRTH CHART PLANETS

259	☉	29°03'30"	25°15'50"	♂	18°20'28"	♂	14°23'01"	♂	12°27'37"	♂	05°52'24"	♂	01°11'14"	♂	25°18'36"	♂	02°11'57"
260		27°00'46"	17°55'59"	♂	06°00'04"	♂	17°26'32"	♂	14°00'20"	♂	01°03'37"	♂	27°15'07"	♂	19°53'15"	♂	26°11'58"
262		17°27'42"	06°00'51"	♂	13°00'24"	♂	03°20'52"	♂	21°17'55"	♂	02°00'51"	♂	08°11'08"	♂	39°24'41"	♂	06°11'49"
263		26°19'37"	02°27'50"	♂	02°19'38"	♂	25°20'52"	♂	25°20'12"	♂	16°26'27"	♂	00°06'05"	♂	06°11'29"	♂	06°11'55"
264		08°00'08"	27°19'10"	♂	04°02'16"	♂	03°27'23"	♂	03°19'33"	♂	14°27'54"	♂	23°18'13"	♂	18°19'17"	♂	26°11'15"
265		26°17'09"	06°00'11"	♂	10°00'46"	♂	19°00'42"	♂	27°11'21"	♂	26°13'11"	♂	53°11'47"	♂	57°16'18"	♂	07°11'32"
261		18°18'28"	19°00'26"	♂	23°00'01"	♂	02°18'59"	♂	19°55'02"	♂	13°16'22"	♂	61°03'00"	♂	21°05'28"	♂	27°11'32"
266		29°11'04"	20°00'00"	♂	06°55'12"	♂	05°11'34"	♂	02°27'31"	♂	00°23'19"	♂	44°05'07"	♂	05°12'41"	♂	46°15'11"
6091		28°05'14"	22°00'47"	♂	18°00'40"	♂	06°27'27"	♂	01°11'21"	♂	04°00'24"	♂	05°17'29"	♂	58°23'11"	♂	15°11'03"
267		00°19'58"	00°17'32"	♂	13°17'38"	♂	22°19'52"	♂	03°19'32"	♂	05°16'14"	♂	00°17'37"	♂	11°51'19"	♂	18°11'48"
6051		26°20'06"	17°55'11"	♂	13°00'12"	♂	23°00'43"	♂	14°27'45"	♂	10°00'43"	♂	23°19'24"	♂	20°17'00"	♂	03°51'41"
268		08°18'53"	24°19'22"	♂	25°18'28"	♂	22°16'54"	♂	28°19'37"	♂	27°18'39"	♂	11°18'52"	♂	20°19'02"	♂	17°18'10"
269		26°00'11"	24°27'59"	♂	08°20'51"	♂	05°19'27"	♂	23°00'45"	♂	07°00'05"	♂	08°25'18"	♂	17°11'50"	♂	12°23'18"
270		19°19'49"	23°26'04"	♂	00°14'43"	♂	12°19'03"	♂	16°00'26"	♂	25°19'26"	♂	16°15'59"	♂	13°35'33"	♂	17°18'08"
271		06°00'37"	26°19'41"	♂	18°00'14"	♂	02°00'54"	♂	13°00'39"	♂	24°00'22"	♂	00°00'66"	♂	24°19'00"	♂	01°52'26"
272		15°18'06"	16°16'17"	♂	18°19'46"	♂	05°11'26"	♂	05°11'30"	♂	10°11'50"	♂	12°26'58"	♂	08°16'16"	♂	14°18'11"
7207		07°19'35"	25°25'52"	♂	09°19'36"	♂	09°26'24"	♂	21°11'47"	♂	28°16'34"	♂	17°19'19"	♂	05°22'10"	♂	30°25°16'
7208		12°00'24"	17°19'01"	♂	28°27'00"	♂	28°06'11"	♂	26°00'32"	♂	15°17'06"	♂	02°26'26"	♂	18°13'22"	♂	55°13°52'
273		09°19'09"	11°00'12"	♂	20°00'47"	♂	12°00'27"	♂	19°00'34"	♂	29°00'07"	♂	18°00'18"	♂	06°15'11"	♂	10°11'56"
7209		14°00'24"	23°19'49"	♂	20°00'18"	♂	02°28'29"	♂	08°00'43"	♂	23°00'52"	♂	52°00'17"	♂	12°29°16'	♂	55°29°01'
2013		11°00'06"	18°00'31"	♂	25°25'23"	♂	08°00'53"	♂	13°19'37"	♂	25°27'53"	♂	20°11'26"	♂	19°11'35"	♂	03°11'11"
274		11°00'06"	04°00'29"	♂	18°00'27"	♂	11°11'08"	♂	28°00'52"	♂	16°11'24"	♂	24°11'47"	♂	58°09°19'	♂	33°19°53'
7196		28°00'32"	18°11'19"	♂	04°00'58"	♂	11°19'49"	♂	16°19'18"	♂	25°00'34"	♂	14°00'59"	♂	20°04°11'	♂	05°11'49"

Referenced Example Birth-Chart Data

No. of House Cusp	BIRTH CHART HOUSE CUSPS			
	I	XI	XII	III
259	10II43	53I2	06I2	11IX04
260	12IX32	IX18	II07	14527
262	07507	0610	IX11	06508
263	21521	0224	IX24	18506
264	05IX27	IX26	IX18	17547
265	28IX12	IX20	IX17	26IX40
261	04IX02	IX07	IX20	29II37
266	06II18	53I0	06I2	09IX54
6091	23IX14	IX15	IX06	00553
267	27II46	0601	IX01	27IX55
6051	29504	IX03	5301	24525
268	17IX27	5311	IX14	01IX21
269	13II25	5317	06I8	15IX44
270	27IX05	IX03	II13	16553
271	03IX37	IX29	IX24	23559
272	15IX52	IX21	II03	09IX42
7207	04II52	5309	06I2	08IX60
7208	13IX12	5307	IX06	23IX51
273	09514	IX07	IX29	19IX56
7209	21IX31	IX13	5307	13IX40
2013	24047	IX27	5324	15IX60
274	22528	IX17	IX08	27IX35
7196	22IX03	IX13	IX03	26IX50

Referenced Example Birth-Chart Data

PROCESSED PLANETS

	♈	♉	♊	♋	♌	♍	♎	♏	♐	♑	♒	♓	MC	Asc.
259	02 27 40	14 52 03	09 27 59	05 27 41	02 27 12	18 27 52	07 53 55	03 27 59	25 27 28	02 27 58	26 27 58	25 27 58	26 27 58	08 52
260	12 27 56	29 27 25	23 27 34	06 27 14	23 27 08	14 27 52	20 27 58	26 27 58	18 27 58	25 27 58	26 27 58	25 27 58	27 27 42	26 27 56
262	24 27 05	06 27 38	06 27 16	08 27 01	15 27 49	02 27 55	13 27 00	26 27 03	06 27 26	06 27 26	06 27 26	06 27 26	13 27 30	06 27 30
263	09 27 17	09 27 03	16 27 48	11 27 13	03 27 01	19 27 01	29 27 47	06 27 06	06 27 06	06 27 06	06 27 06	06 27 06	28 27 47	28 27 47
264	10 27 33	03 27 42	09 27 30	03 27 26	04 27 13	15 27 22	23 27 14	18 27 13	18 27 13	18 27 13	18 27 13	18 27 13	07 27 52	28 27 56
265	13 27 25	08 27 08	18 27 52	17 27 45	14 27 38	22 27 20	20 27 08	36 27 17	15 27 15	13 27 28	29 27 15	29 27 15	08 27 52	08 27 52
261	03 27 48	27 27 11	11 27 24	22 27 29	28 27 17	11 27 53	17 27 54	54 27 54	03 27 54	03 27 54	03 27 54	03 27 54	19 27 22	12 27 08
266	14 27 09	29 27 06	05 27 44	24 27 46	11 27 36	00 27 26	18 27 39	04 27 33	15 27 13	15 27 13	15 27 13	15 27 13	21 27 23	22 27 37
6091	04 27 23	15 27 17	28 27 31	13 27 55	05 27 45	05 27 40	05 27 47	29 27 55	23 27 48	15 27 15	15 27 15	15 27 15	08 27 45	08 27 45
207	05 27 27	18 27 20	22 27 46	11 27 10	22 27 54	16 27 48	05 27 24	09 27 53	02 27 53	02 27 53	02 27 53	02 27 53	13 27 15	19 27 47
6051	28 27 01	16 27 49	02 27 50	03 27 22	00 27 25	16 27 04	26 27 33	21 27 53	02 27 53	02 27 53	02 27 53	02 27 53	14 27 37	06 27 04
268	06 27 03	25 27 03	14 27 28	26 27 28	11 27 47	11 27 29	24 27 25	15 27 15	21 27 38	18 27 23	14 27 37	14 27 37	06 27 04	06 27 04
269	00 27 48	20 27 05	14 27 25	14 27 12	16 27 51	09 27 09	12 27 29	20 27 55	17 27 07	17 27 07	17 27 07	17 27 07	15 27 04	15 27 04
270	19 27 20	20 27 21	08 27 02	27 27 56	08 27 44	09 27 42	13 27 15	25 27 56	19 27 08	17 27 10	10 27 56	10 27 56	02 27 08	02 27 08
271	02 27 09	01 27 45	06 27 07	22 27 21	16 27 54	00 27 24	03 27 51	25 27 02	01 27 02	01 27 02	01 27 02	01 27 02	29 27 09	28 27 47
272	20 27 11	05 27 56	25 27 20	11 27 52	09 27 04	12 27 00	13 27 31	08 27 10	08 27 22	21 27 23	20 27 67	20 27 67	13 27 26	13 27 26
7207	03 27 17	07 27 46	06 27 33	11 27 29	06 27 36	04 27 44	20 27 36	05 27 00	11 27 26	26 27 13	00 27 34	00 27 34	00 27 29	00 27 29
7208	16 27 54	18 27 48	05 27 42	03 27 15	27 27 27	15 27 50	02 27 58	18 27 28	27 27 02	13 27 30	17 27 42	17 27 42	01 27 40	01 27 40
273	11 27 26	15 27 46	24 27 42	15 27 17	21 27 19	29 27 09	18 27 24	03 27 15	37 27 10	11 27 31	11 27 31	11 27 31	21 27 56	21 27 56
2013	20 27 23	20 27 53	08 27 19	26 27 55	18 27 30	03 27 47	25 27 13	20 27 41	02 27 48	11 27 06	06 27 04	06 27 04	17 27 09	17 27 09
274	12 27 46	26 27 05	16 27 35	13 27 12	00 27 01	16 27 24	12 27 51	05 27 09	15 27 02	19 27 31	24 27 08	24 27 08	28 27 13	28 27 13
7196	17 27 33	00 27 41	02 27 20	06 27 45	21 27 22	06 27 52	11 27 22	12 27 29	54 27 04	06 27 15	11 27 04	11 27 04	21 27 37	21 27 37

Chapter 8

Blindness — Coronary Thrombosis

FOR their research work during the first half of 1947, Elbert Benjamine and W. M. A. Drake decided to find out how often a major event, whatever it may be, takes place on one of the peaks of power due to the reinforcement effect of a minor progressed aspect. They therefore calculated the minor progressed aspects for the date of the event or the development of the disease to ascertain, out of 200 charts and events and diseases, in how many instances ALL the major progressed constants were reinforced by a minor progressed aspect heavier than from the Moon at the time the event took place or the disease developed.

The details of this analysis were published in C. of L. Astrological Report No. 59 in the September, 1947, number of *The Church of Light Quarterly*.¹ The following rule there published has been further verified by checking on a great many additional charts:

RULE: Each major progressed constant of an event or disease is always reinforced by a minor progressed aspect heavier than from the Moon to one of its four terminals at the time the event occurs or the disease develops.

The Trigger Effect of Transit Aspects

—On August 2, 1947, at the Fifteenth International Church of Light Convention, Lenora Conwell presented a study of 25 charts with major progressions, minor progressions, and transits around the outside for the precise day and time of day an event took place. As this study clearly indicated transit aspects play a part in timing events, Elbert Benjamine and W. M. A. Drake for their next research work calculated the transit aspects in 200 charts for which the precise day of the event was known. The details of their findings, finished November 11, 1947, were published in C. of L. Astrological Report No. 60, in the December, 1947, number of *The Rising Star*,² and include the following:

¹ Out of print. See }{\plain \i\fl Astrology: 30 Years Research}{\plain \fl .

RULE: Each reinforced major progressed constant of an event or disease is always released by a transit aspect heavier than from the Moon to one of its four terminals at the time the event occurs or the disease develops. And an independent minor progressed aspect is always released by a transit aspect to one of the birth-chart or major progressed terminals influenced by the minor progressed aspect at the time the event takes place.

If a match is lighted in a room filled with cooking gas, neither the power of the explosion nor the destruction resulting therefrom is commensurate with the limited energy of the match. The power was there, and the flame of the match merely released it. The power which projects a bullet from a gun does not lie in the trigger nor in the finger which presses it. The power is in the powder. That power is released when the trigger is pressed. Until the trigger is pressed the power is not released. And we now have adequate statistical data indicating that transit aspects have very little power in themselves; but that they exert a trigger effect which tends to release the power of reinforced major progressed aspects, and also the power of independent minor progressed aspects.

One day of major progression time is equivalent to one year of calendar time. As the day of major progression time is measured by the interval between two successive transits of the Sun over the meridian, major progressed aspects are timed by the apparent movement of the Sun.

One astrological month of minor progression time is equivalent to one year of calendar time. As the astrological month of minor progression time is measured by the interval between two successive transits of the Moon over its birth-chart place, minor progressed aspects are chiefly timed by the movement of the Moon.

One year of transit time is equivalent to one year of calendar time. As the year of transit time is measured by the interval between two successive transits of the earth over the same sign, degree and minute of the zodiac, transit aspects are chiefly timed by the movement of the earth.

Symbolically, the Sun is the father and the Moon is the mother, "Male and female created he them." In higher forms of life it requires the union of male and female to conceive offspring. The Hermetic Axiom, "As it is above, so it is below," is thus verified still further by the finding that both Sun measured progressed aspects and Moon measured progressed aspects influencing ALL its progressed constants must join in the production of a major event.

In addition to gestation, however, before the event is born the energy must be released. It must become manifest on the earth. As in human birth after gestation has been completed there must be the pains of labor or their equivalent before the child is released to take its own first independent breath, so in the delivery of any major event, after gestation due to major progressed aspect and minor reinforcement progressed aspect, before the event is released in the physical world there must also be a transit aspect to the significant birth-chart or major progressed terminal.

Astrologers will at once recognize the great importance of these two rules. It will enable them to eliminate the possibility of a given event or the commencement of a given disease, even during those periods while the major progressed constants are within orb, except during those limited periods when ALL these major progressed constants are reinforced by minor progressed aspects and also released by transit aspects.

It will enable them more precisely to time indicated events; for the event will occur on one of the peaks of power indicated when ALL the major progressed constants are reinforced by minor progressed aspects and at the same time receiving transit aspects.

It will greatly aid in rectifying charts; because the chart when correct will have not only a major progressed aspect to the ruler of the house mapping the department of life affected by the event, and the other major progressed constants of the event—often involving the rulers of several houses—at the time the event occurs, but as an additional check, the major progressed aspect indicating the event in each case, if the chart is correct, must be reinforced by a minor progressed aspect and released by a transit aspect. If the ruler of the house mapping the department of life affected by the major progressed aspect, and each of the other major progressed constants, are not reinforced by a minor progressed aspect and released by a transit aspect at the time of the event, the house positions of the chart are in error.

There are still other important applications of this rule, but undoubtedly its greatest usefulness is in the selection of the best time to do things. Commonly, minor progressed aspects and transit aspects last only short periods. Therefore, during the time a major progressed aspect is within orb of influence, it usually IS possible to select several short periods during which no minor progressed aspect to any of its four terminals reinforces it. If one were compelled to do something hazardous, such as take a dangerous trip, during the time there was a major progressed affliction involving Mars, if one selected a time when this major progressed aspect was not reinforced by a minor progressed aspect, the danger would be reduced, if not to nil, at least to a minimum. Thus far we have found no accidents unless a major progressed aspect involving Mars was reinforced by one or more minor progressed aspect and released by a transit aspect.

On the other hand, if one wished to do something at a time when it was essential to get all the benefit possible from a harmonious major progressed aspect, one could select a time when, in addition to a transit aspect, several minor progressed aspects were

reinforcing the major progressed aspect. Often it is possible to find a short period during which the reinforcements give the major progressed aspect several times its normal peak power. The power to bring the desired event to pass during such a short period would consequently be several times as much as when no reinforcement was present.

BLINDNESS

See also cataract.

Birth-chart constants: Moon severely afflicted by Mars. If Mars is prominent and afflicted, a severely afflicted Moon may cause trouble with the eyes. Even a powerful harmonious aspect, such as a trine, between Moon and Mars may give eye difficulties of less severity if the Moon is otherwise severely afflicted. Mars and the Moon are the factors in crossed eyes. In cataract, Neptune also is involved.

Progressed constants: A Mars aspect with severe rallying forces.

Stellar Treatment: The thought-cells mapped by the Moon should be strengthened and harmonized through applying to them Sun planetary energy. The thought-treatment should be such as to bring the Moon energies and Mars energies into more harmonious relations. The eyes themselves should be soothed with lunar electromagnetic energy. The zone occupied by Mars should be given Moon planetary energy, and the zone occupied by the discordant rallying force should receive the energy of its planetary antidote.

Example: Chart 259. Male, Aug. 22, 1885, 7:00 a.m. 81:50W. 24:30N. Moon opposition Mars, and Mars semi-square Sun. August, 1914, as progressed, with Mars semi-square Mercury r, sextile Uranus p, sextile Pluto r; Venus semi-square Mercury r and Jupiter p; and Sun p Uranus p; he was vaccinated. The poison injected into his blood stream at that time affected his eyes, and by December, 1916 with Mars still semi-square Mercury r and Jupiter p he was totally blind. As the pain continued, on May 12, 1931, under Sun square Mars r, he had both eyes removed.

BLOOD POISON

Birth-chart constants: Mars and Neptune or Pluto heavily afflicted.

Progressed constants: A progressed aspect involving Mars and a progressed aspect involving Neptune or Pluto, at the same time there are heavy rallying force afflictions.

Stellar Treatment: The system largely depends upon the secretion of adrenalin and cortin to combat toxins and infection. Under afflictions of Neptune or Pluto the manufacture of these hormones is depressed. The Mars influence is toward over expenditure of these two hormones. With these two chemicals exhausted, toxins remain unneutralized in the blood stream, and infection, attracted by Mars, easily gains a foothold. The zones occupied by Neptune or Pluto should receive Sun

planetary energy to overcome their negative tendencies, the Mars zone should receive Moon planetary energy, and special effort should be made by the individual to remain mentally free from anger, excitement, fear, or other emotion, and from strain of any kind, as these release and use up the adrenalin and cortin supply. An even mind and a diet rich in alkali-forming elements are advisable. Cuts or scratches should receive immediate antiseptic treatment.

Example: Chart 260. Male, February 17, 1911, 1:15 p.m. 1:15W. 53:30N. Mars square Moon and opposition Neptune and Asc. March 18, 1926, as progressed, with Sun sextile Mars r and semi-square Uranus p, and Asc. semi-sextile Pluto r and opposition Uranus r, died of blood poison.

BOWEL TROUBLE

Birth-chart constants: An afflicted planet in Virgo, or much less commonly a severely afflicted Mercury.

Progressed constants: A progressed aspect involving the planet in Virgo, or involving Mercury, at the same time rallying forces afflict.

Stellar Treatment: Depends upon the type of difficulty. The birth-chart constants and the progressed constants as they appear in the chart map the dynamic structures which should receive the planetary energies of their antidotes. The thoughts of the individual are always very important in all types of bowel trouble, and he should be educated as to the type of thinking best for his particular case. The thought-treatment in the region of the solar plexus also should be quite thorough. Electromagnetic energies should be applied specifically to the region of the bowels to carry planetary energies into this zone and to invigorate it.

Example: Chart 262. Male, September 10, 1890, 7:20 a.m. 76:45W. 40N. Sun in Virgo conjunction Saturn and square Mars. Saturn in Virgo square Neptune and Pluto. By September, 1927, as progressed, with Mercury conjunction Asc. r and square M.C. r, with Asc. square Moon r and semi-square Mars r (operation), and with Sun conjunction Uranus r (paralysis), the difficulty had become severe enough to paralyze the bowels and they were operated on.

BRAIN FEVER

Birth-chart constants: Usually an affliction in Aries, but at times only an affliction to Mercury; and a prominent and afflicted Mars.

Progressed constants: Some aspect involving Mercury or the planet in Aries, usually both, and at the same time an affliction involving Mars.

Stellar Treatment: There are two types of this disease. In one there is inflammation of the membranes and in the other inflammation of the brain substance. But the diagnosis and treatment are similar for both. Chemical balance should be restored to the nerves through a diet rich in calcium, vitamin B-1 and vitamin D. The planetary

antidote should be applied to any afflicted planet in Aries, and Jupiter planetary energy should be applied to the zone occupied by Mercury; but the chief effort should be to reduce the inflammation by delivering to the Mars zone, and to the brain, the planetary and electromagnetic energies of the Moon. Soothing passes over the brain with the left hand are recommended.

Example: Chart 263. Female. January 17, 1892, 12:15 a.m. 81:45W. 41:30N. No affliction in Aries, but Mercury is square Saturn. Mars is square Moon and square Venus. About July 1, 1904, as progressed, with Mars square Moon r, semi-sextile Mercury r and semi-square Asc. r, suffered from brain fever.

BRAIN, WATER ON (Hydrocephalus)

Birthchart constants: Usually an affliction in Aries, but at times only an affliction to Mercury; and a prominent Moon afflicted by negative planets.

Progressed constants: Some aspect involving Mercury or the planet in Aries, and usually an aspect involving a negative planet.

Stellar Treatment: This is a child's disease and occurs in acute form and in chronic form. It is dropsy of the brain, and in chronic form may exist before birth. An over active back pituitary causes water to be unduly retained, and the affliction in Aries or to Mercury may cause it to be retained in the brain.

The afflicted Mercury or the affliction in Aries should receive the planetary energy of its antidote; but in particular Sun planetary and electromagnetic energies should be applied to overcome the negative influences, and to stimulate the thyroid to drive the water from the system. These solar energies should be applied to the zone mapped by the Moon, and to the region of the brain.

Example: Chart 264. Male. July 31, 1909, 7:30 p.m. 88W. 37:30N. Saturn is in Aries square Moon, Uranus and Neptune. Feb. 4, 1912, as progressed, with M.C. sesqui-square Saturn r, Pluto inconjunct Moon r, Uranus opposition Neptune r and sesqui-square Venus r, and Moon opposition Venus r, died of water on the brain.

BRIGHT'S DISEASE

Birth-chart constants: Usually an afflicted planet in Libra or Scorpio, and Venus or Mars, usually both, severely afflicted.

Progressed constants: An affliction involving Venus or Mars, more commonly Venus, at the same time there are strong rallying force afflictions.

Stellar Treatment: Bright's Disease develops as a condition in which the kidneys are unable to filter the acids from the blood. This is followed by degeneration of the structure of the kidneys. To give the kidneys a chance to recuperate, the diet should be that suitable for Mars and Venus afflictions, and should be such as to keep the blood stream with an alkaline reaction. The nuclear proteins of meat work the kidneys too hard. And because cold, dampness and other exposure disturbs the circulation and makes calls upon the vitality which weaken the kidneys, they should be avoided. Planetary energy the antidote of the afflicted Venus or Mars should be applied both to the zone occupied by the afflicted planet and to the region of the kidneys.

Example: Chart 265. Male, September 18, 1881, 6:00 p.m. 87:10W. 39:30N. Mercury in Libra in an angle inconjunct Saturn. Venus square Saturn. Mars Square Sun. In May, 1929, as progressed, with Sun in Scorpio sesqui-square Mars r, and Mercury square Venus r, developed Bright's Disease.

BRONCHITIS

Birth-chart constants: Gemini highly sensitive due to an afflicted Mercury, or more commonly through the presence in it of Uranus, Neptune or Pluto.

Progressed constants: An aspect involving Mars, particularly if the planet in Gemini or Mercury is at the same time afflicted.

Stellar Treatment: The birth-chart hypersensitivity of the bronchi is due to chemical imbalance permitting irritation to develop, which may become catarrhal and chronic. The parathyroid glands should be relieved of strain through calmer habits of thinking and a diet containing calcium, vitamin B-1 and vitamin D. The zone occupied by the planet indicating the Gemini sensitivity should be given planetary energy of that planet's antidote, and lunar electromagnetic energy should be applied to the bronchi. The zone mapped by Mars should be treated with Moon planetary energy, and the diet should favor the restoration of the adrenal glands to their normal activities.

Example: Chart 261. Male, May 9, 1912, 7:00 a.m. 71W. 42:45N. Pluto in Gemini conjunction the Asc., Mercury square Neptune. In April, 1928, as progressed, with Sun in Gemini semi-square Mars r, and Mars sesqui-square Jupiter r in the sixth, had a severe attack of bronchitis.

BUNIONS

Birth-chart constants: Affliction in Pisces, or Neptune prominent and usually afflicted.

Progressed constants: A progressed aspect involving the afflicted planet in Pisces or Neptune.

Stellar Treatment: A bunion is an enlargement of a bursa, or sack, of the foot. The common cause is the wearing of shoes which in some manner force the toes from their normal position. The first thing, of course, is for the patient to wear shoes which entirely remove pressure or strain on the place where the bunion is developing. Its planetary antidote should be applied to the dynamic structure responsible for the condition. And in addition, both lunar and solar electromagnetic energies should be applied to the bunion itself, with the thought-treatment that the tissues will be restored to normal.

Example: Chart 266. Male, June 20, 1899, 10:00 a.m. 84:15W. 41:30N. Neptune in tenth conjunction Sun and opposition Saturn. Between the ages of 15 and 16, as progressed, with Venus conjunction Neptune r and Mercury sesqui-square Saturn r (tight), he walked about 6 miles a day in his work, in shoes which were too short, and bunions developed.

BURNS

Birth-chart constants: A heavily afflicted Mars, and commonly also Saturn and Uranus prominent.

Progressed constants: An aspect, usually an affliction, involving Mars.

Stellar Treatment: Both the zone mapped by Mars in the birth-chart and the place on the body where the burn occurs should be given Moon planetary energy. A stellar healer should be able quickly to draw the pain and fever from a burn, scald or sunburn, by placing his left hand over the burned area and his right hand on the part of the body or limb opposite. One of the dangers where flesh has been badly burned is from the proteins of the burned flesh poisoning the blood stream. Hospitals now use penicillin to counteract this. The body uses cortin and adrenalin. Their effort to neutralize the protein poison expresses as fever. To assist them the diet and thought-treatment should strengthen the adrenal glands.

Example: Chart 6091. Male, July 20, 1898, 7:00 p.m. CST. 83:01W. 39:58N. Mars sextile Sun and opposition Uranus and Saturn. December 20, 1904, as progressed, with Mars opposition Saturn r, was badly scalded.

CANCER

Birth-chart constants: Saturn, Jupiter, Moon and Neptune prominent and usually afflicted. The detailed analysis of 100 charts progressed to the time its owner developed cancer is given in the reference book, BODY DISEASE AND ITS STELLAR TREATMENT.³

3 Out of print. See } {\plain \f1 Astrology: 30 Years Research} {\plain \f1 .

Progressed constants: A progressed aspect involving Saturn and a progressed aspect involving Jupiter.

Stellar Treatment: Foods should be selected which supply a wide variety of proteins, vitamins and minerals. The zones of the afflicted constants should receive the planetary energy of their antidote, and negative moods and negative thoughts should be ousted and the electrical potential kept high through Sun thoughts.

Example: Chart 267. Male, December 22, 1867, 11:45 p.m. 89:30W. 40:45N. Saturn conjunction Moon, Moon semi-sextile Sun and square Jupiter. Neptune angular and sesqui-square Moon. Under progressed Sun square Saturn r and Moon r, and progressed Asc. trine Jupiter p, developed cancer of prostate gland. When Sun came conjunction Jupiter p in 1929, he went to the best known clinic in the country and was operated upon. June, 1931, as progressed, with Sun square Saturn p, the disease started rapid growth and spreading, and he died before the Sun had progressed beyond the one degree of orb of square Saturn p.

CARBUNCLE

Birth-chart constants: Jupiter afflicted and Mars prominent.

Progressed constants: An aspect, usually an affliction, involving Mars.

Stellar Treatment: When certain foods are eaten too rich in proportion to the other foods partaken, when lack of exercise gives insufficient oxygenation, or when the insulin supply becomes inadequate, the fuels of the body smolder and do not properly burn. And when bacteria, which are always present in the air, are able to get beneath the skin of a person with such a blood stream, there is the type of infection known as boils or carbuncles. The region of such boils or carbuncles should always be kept disinfected to prevent their spreading, and they should not be pinched, as this may spread the infection to surrounding areas. The carbuncle may be drawn to a head by placing the right hand over it and left hand on the region opposite and permitting the electromagnetic current to flow freely between the hands. Mercury planetary energy should be applied to the zone occupied by Jupiter, and Moon planetary energy to the zone occupied by Mars. Education as to proper diet should be given.

Example: Chart 6051. Male, November 19, 1902, 4:00 a.m. 71:25W. 41:49N. Jupiter square Mercury, Mars sextile Mercury and Moon. In June, 1934, as progressed, with Mars sesqui-square Jupiter p, and semi-sextile M.C. p, developed a carbuncle on his thigh.

CATARACT

Birth-chart constants: As in other types of eye trouble, the Moon afflicted by Mars, or at least Mars prominent and Moon severely afflicted; and in addition a Neptune aspect, usually an affliction, to the Moon.

Progressed constants: An aspect involving Mars and an aspect involving Neptune at the same time there are severe rallying forces.

Stellar Treatment: The growth which covers the eyes is due to chemical imbalance in which Neptune actively participates. In addition to the treatment given under blindness, therefore, the diet should contain energy foods, calcium, vitamin B-1, and less protein. Sun planetary energy should be applied to the zone occupied by Neptune, and instead of applying lunar electromagnetic energy, solar electromagnetic energy should be applied directly to the eyes.

Example: Chart 268. Male, April 29, 1870, 4:47 a.m. 88:20W. 40N. Mars and Neptune both conjunction Moon. When progressed Mars reached the semi-square of Moon r, and Uranus was square Neptune p, cataracts began to form. November 11, 1929, he could still distinguish objects, but by November 19, 1929, as progressed, with Mercury semi-square Mars r, and Uranus square Neptune p, he was totally blind. A time was chosen by astrology for an operation, and through it his sight was restored.

CATARRH

Birth-chart constants: One or more upper-octave planet prominent, and Jupiter afflicted.

Progressed constants: An aspect, usually an affliction, involving the prominent upper-octave birthchart planet, or an affliction involving Jupiter.

Stellar Treatment: The diet should be that advocated for an afflicted Jupiter, and for an affliction to the upper-octave planet. Catarrh may develop in the nasal tract, mouth, throat, lungs, digestive tract, bladder, or wherever mucous membranes are present which become overly sensitive to the irritants which the afflicted Jupiter thought-cells permit to remain in the blood. The liver should be energized with solar electromagnetic energy, and the Jupiter zone should receive Mercury planetary energy. The zone of the responsible upper-octave planet thought-cells should be given its planetary antidote.

Example: Chart 269. Male, October 20, 1895, 2:50 a.m. EST. 74W. 40:40N. Neptune and Pluto conjunction M.C., Uranus conjunction Moon, Jupiter square Mercury and Saturn. October 18, 1929, as progressed, with Mars inconjunct Neptune p, and Jupiter square Mercury r, developed a severe case of catarrh.

CEREBRAL HEMORRHAGE

Birth-chart constants: Uranus prominent, usually an afflicted Mars, and commonly an afflicted planet in Aries.

Progressed constants: An aspect involving Uranus, and an aspect, usually an affliction, involving Mars.

Stellar Treatment: Thoughts and diet should reduce the nervous tension indicated by Uranus. Thoughts and diet should strengthen the walls of the blood vessels. Excitement or undue strain of any kind increases adrenalin secretion and speeds up the circulation. If the blood vessels of the head have been weakened by acids in the blood stream, or if they have become brittle through insufficient parathyrin to handle calcium, a little sudden increase in the circulation may cause cerebral hemorrhage. The pressure on the brain where the rupture occurs usually results in a stroke in which some section of the body is paralyzed. Lunar electromagnetic energy should be applied to the region of the rupture, Moon planetary energy should be applied to the zone mapped by Mars, and Jupiter planetary energies should be applied to the zone occupied by Uranus.

Example: Chart 270. Male, April 9, 1869, 10:37 a.m. 74:15W. 41N. Uranus square three of the five planets in Aries, and Mars trine Sun and square Pluto. November 12, 1930, as progressed, with Uranus conjunction Asc. r, Pluto square Mars r, and Mercury sextile Mars p, had a cerebral hemorrhage.

CHILDBIRTH TROUBLES

Birth-chart constants: A malefic planet, or an afflicted planet, in the fifth, or the ruler of the fifth severely afflicted.

Progressed constants: An affliction to the ruler of the fifth.

Stellar Treatment: The planetary antidote of the malefic in the fifth or the afflicted fifth house ruler should be applied to the zone occupied by the planet, and to the zone indicated by the sign on the cusp of the fifth.

Example: Chart 271. Female, January 27, 1903, 7:45 a.m. 158W. 21:30N. Neptune in fifth inconjunct Saturn. April 11, 1928, as progressed, with Sun square Neptune r (ruler of fifth), and Mars (planet of operations) sesqui-square Sun p, a child was born; but it was a Caesarean birth.

CHICKEN-POX

Birth-chart constants: Mars somewhat afflicted.

Progressed constants: A progressed aspect involving Mars.

Stellar Treatment: This is a very mild Mars disease. The diet should be that recommended when Mars is afflicted, and should be quite light for a few days. Quietness should be encouraged. Lunar electromagnetic energy may be applied to reduce the fever, and Moon planetary energy should be applied to the zone occupied by the dynamic Mars thought-cells. The fever is the result of adrenalin and cortin trying to oust the invader and neutralize its toxins. If, therefore, through diet, lack of exciting activities, and Moon planetary energies, the adrenal glands can be kept functioning properly, this disease or more serious Mars contagions, will be able to cause much less trouble.

Example: Chart 272. Male, May 6, 1906, 8:30 a.m. 79W. 42:50N. Mars semi-square Mercury and sesqui-square Moon. In August, 1911, as progressed, with Mars semi-sextile Asc. r and inconjunct Uranus r, had chicken-pox.

CHOLERA ASIATICA

Birth-chart constants: Mars prominent and a planet in Virgo, or Mercury afflicted.

Progressed constants: An aspect involving the planet in Virgo or Mercury at the same time there is an aspect involving Mars.

Stellar Treatment: Asiatic cholera is caused by *Vibrio comma bacilli*. As soon as the diarrhea starts the individual should be put to bed and kept at complete rest. No food should be given for a few days except water, barley water, or water with glucose in it. The room should be kept warm but well ventilated. As recovery sets in, small quantities of light milk food may be given. The energy of its planetary antidote should be applied to the zone of the afflicted planet in Virgo, or Jupiter planetary energy should be applied to the zone occupied by Mercury. Moon planetary energy should be applied to the zone occupied by Mars. The patient's vitality should be reinforced by delivering to him abundant solar electromagnetic energy.

Example: Chart 7207. Male, March 27, 1880, 3:49 p.m. 76W. 42N. Mars angular and trine Moon. Uranus conjunction Asc. in Virgo and opposition Venus. In June, 1906, as progressed, with Saturn sesqui-square Uranus r in Virgo, and Mars square Sun r, had Asiatic cholera. Recovered.

COLD—COMMON

Birth-chart constants: Negative planets quite prominent, or a negative planet severely afflicted.

Progressed constants: The type is a progressed affliction involving either Mars or Saturn; but almost any progressed aspect, if the birth-chart predisposition is pronounced, may permit a cold to develop.

Stellar Treatment: What is known as a common cold is made possible through a blood stream unable to oust invading organisms. People seldom take cold except when their thoughts temporarily are of a negative character. While the thoughts are positive, both the electromagnetic energies and the chemical secretions are such as to resist invasion. Because fruit juices tend to an alkaline reaction of the blood, their use during colds is to be recommended. The bowels should be kept open, the food should be that recommended for Saturn, with special emphasis on vitamin A, the patient should rest, solar etheric energies should be applied to increase the vitality, and their planetary antidotes should be applied to the zone occupied by the Saturn and Mars thought-cells to the end of giving a good output of adrenalin and cortin.

Example: Chart 7208. Male, October 5, 1924, 6:00 p.m. 75W. 40N. Moon, Saturn and Pluto in angles; Neptune and Venus opposition Mars. Suffered from one cold after another. They were particularly bad in April, 1929, as progressed, with Sun square Moon r, M.C. conjunction Moon r, Mars opposition Venus r, and Mars sesqui-square Sun r.

COLIC

Birth-chart constants: More commonly a planet afflicted in Virgo. Less commonly a severely afflicted Mercury.

Progressed constants: An aspect involving the planet in Virgo, or involving the severely afflicted Mercury.

Stellar Treatment: This disease is nearly always due to indiscretion in eating. The diet should, therefore, be tempered to the special requirements of the patient. Jupiter planetary energy should be applied to the zone occupied by afflicted Mercury, or its planetary antidote should be applied to the zone occupied by the afflicted planet in Virgo. To relieve the pain, which may be severe, solar electromagnetic energy should be applied by placing the right hand over the painful area and the left hand on the back opposite.

Example: Chart 272. Male, May 6, 1906, 8:30 a.m. 79W. 42:50N. No planet is in Virgo, but Mercury is opposition Moon and semi-square Venus and Mars. As a child he suffered much with colic.

COLITIS

Birth-chart constants: Affliction in Scorpio, or less commonly an affliction to Mars.

Progressed constants: A progressed aspect involving the afflicted planet in Scorpio, or a progressed aspect involving Mars.

Stellar Treatment: The colon is ruled by Scorpio. Emotional upsets of any kind affect the chemical balance of the blood stream. An aspect to Mars may deplete the adrenalin and cortin supply permitting an acid or toxic condition to develop. The discordant Scorpio thought-cells, or discordant Mars thought-cells permit the imbalanced blood to irritate the colon. A calm mental attitude should be cultivated, and the diet should be such as to restore chemical balance and strengthen the adrenal glands. Lunar electromagnetic energy should be applied to the region of the colon, Moon planetary energy should be applied to the zone occupied by Mars, and the affliction in Scorpio, if any, should be given its planetary antidote.

Example: Chart 273. Female, March 29, 1896, 12:15 a.m. 122:30W. 38N. Mars square Saturn and Uranus in Scorpio. In July, 1911, as progressed, with Mercury trine Uranus r in Scorpio, Mars semi-sextile Mercury r, Asc. semi-sextile Mars p, and Sun opposition Moon r, developed colitis.

COLOR BLINDNESS

Birth-chart constants: Moon prominent and afflicted and in aspect with Neptune.

Progressed constants: This defect is usually hereditary and present from birth.

Stellar Treatment: Eye surgery indicates that color blindness can be corrected. Large amounts of vitamin A are considered helpful. The planetary energy of Mars should be applied to the zone occupied by the Moon, and the planetary energy of Saturn and the Sun should be applied to the zone occupied by Neptune.

Example: Chart 7209. Male, November 7, 1927, 2:52 p.m. EST. 83W. 42N. His brother and father are also color blind.

CONSTIPATION

Birth-chart constants: Saturn prominent and forming any aspect to Mercury, or Saturn in Virgo or in the sixth house. To a lesser extent a prominent Saturn forming heavy aspects, especially afflictions.

Progressed constants: Any aspect involving Saturn, but especially an affliction involving Saturn.

Stellar Treatment: Common causes of this disorder are too concentrated diet, tea, coffee, tobacco, beer, lack of exercise, pills, and neglect to answer nature's call. When the call comes to relieve the bowels, if it is neglected a few times, a habit-system is formed in which the call is no longer felt. With most people the habit is most readily cultivated of performing this act immediately after rising, or immediately after breakfast in the morning. The diet, exercise and stellar treatment should be such as to enable the evacuation to take place as scheduled. And the attempt should always be made at the scheduled time, and without fail, whether the effort is successful or not. People differ widely in the frequency with which evacuation is necessary.

Example: Chart 2013. Female, August 3, 1862, 1:00 p.m. 82:41W. 38:32N. Saturn in Virgo sextile Mercury. In April, 1903, as progressed, with Sun conjunction Saturn and Saturn sextile Mercury, constipation was unusually severe.

CONVULSIONS

Birth-chart constants: Mercury prominent and afflicted, Mars prominent, and one or more of the upper-octave planets—Uranus, Neptune, Pluto—prominent.

Progressed constants: An aspect involving either Mars or Mercury, usually both, with affliction from rallying forces.

Stellar Treatment: The upper-octave planets and Mercury disturb the calcium balance, giving great sensitiveness to the nerves and mucous membranes. The progressed aspect involving Mercury increases this condition, giving spasmodic nervous reactions to irritants, especially in the region of the bowels, which through Virgo are ruled by Mercury. The progressed aspect involving Mars cuts down the cortin supply and permits the irritants to act with little hindrance. The diet should tend to correct the Mercury and Mars chemical imbalance. Jupiter planetary energy should be applied to the zone occupied by Mercury, and Moon planetary energy should be applied to the zone occupied by Mars. Both lunar electromagnetic energy and Moon planetary energy should be applied to the bowels.

Example: Chart 274. Female, October 4, 1929, 1:00 p.m. 112W. 43:30N. Mercury conjunction Sun and square Pluto. Mars conjunction Moon Uranus opposition Mercury, Neptune sextile Moon. Pluto angular and square Sun and Mercury. In June, 1931, as progressed, with Venus semi-square Mars r, and Mercury trine Jupiter r, had convulsions.

CORONARY THROMBOSIS

Birth-chart constants: Heavy affliction to planet in Leo or to the Sun; Venus or Jupiter afflicted, and Pluto or Neptune prominent and afflicted.

Progressed constants: A progressed affliction involving a planet in Leo or the Sun, a progressed affliction involving Venus or Jupiter at the same time there is a progressed aspect involving Pluto or Neptune, and a progressed aspect involving Mars.

The conditions preceding coronary thrombosis are the same as those preceding other thrombi (see thrombosis); but as at birth and by progression the planet in Leo or the Sun is afflicted, the blood clot, or clots, tends to block the coronary arteries.

Stellar Treatment: Through diet and application of Sun planetary energy to zones occupied by Venus, Pluto or Neptune, the vitality should be increased. Mercury planetary energy should be added to the zone occupied by Jupiter, and Moon planetary energy to the zone occupied by Mars. And the heart zone should be given the antidote planetary energy of any planet in it, or that beneficial to the Sun.

Example: Chart 7196. Male, February 17, 1891, 5:46 a.m. 79W. 43N. Venus semi-square Jupiter, Pluto and Neptune angular and square Sun. On May 7, 1940, as progressed, while running to catch a street car he suffered coronary thrombosis. Sun conjunction Mars r, Asc. semi-square Pluto p, Venus and Jupiter square Pluto p.

Chapter 9

Serial No. 205
Original Copyright 1947
Elbert Benjamine

Copyright
August 2002
Church of Light

Cyst — Hay Fever

BIRTH CHART PLANETS

6113	00°57' 21" 00	29°55' 12" 21	18°11' 27" 54	12°54' 14" 50	02°51' 17" 05	♅ 50
275	28°42' 14" 01	05°57' 01" 15	10°30' 06" 18	18°26' 16" 01	10°24' 22" 27	♄ 27R
2042	01°56' 25" 01	16°25' 04" 56	20°33' 07" 24	23°26' 08" 45	14°45' 24" 44R	
7209	13°04' 12" 37	08°03' 18" 7	15°14' 05" 23	06°50' 18" 02	17°59' 12" 37	
7210	03°50' 03" 25	15°18' 17" 53	25°27' 13" 43	01°21' 18" 59	12°59' 13" 26	
276	00°37' 28" 10	11°02' 28" 54	17°35' 08" 56	03°26' 12" 08	29°57' 04" 47R	
277	10°27' 21" 08	05°50' 25" 26	26°03' 04" 26	06°27' 13" 00	17°50' 25" 44R	
6170	02°11' 10" 46	28°21' 22" 23	12°25' 29" 49	07°47' 15" 02	01°32' 10" 16	
1926	17°41' 15" 18	07°54' 05" 49	10°08' 27" 49	28°05' 02" 42	08°58' 25" 59R	
7262	13°43' 10" 23	00°55' 07" 12	23°40' 14" 03	02°27" 54	18°57' 25" 51	
7129	19°07' 24" 10	21°43' 06" 32	09°33' 08" 20	10°05' 20" 12	14°53' 23" 47R	
7263	25°15' 05" 57	21°15' 19" 04	26°40' 29" 19	27°52' 20" 41	04°53' 06" 24	
7264	18°23' 23" 06	26°11' 11" 00	08°05' 17" 58	07°53' 06" 57	15°21' 08" 547R	
280	06°15' 18" 20	10°42' 24" 30	06°44' 10" 17	26°26' 21" 17	17°28' 46" 16" 46	
279	03°16' 05" 12	22°09' 04" 40	09°19' 22" 52	26°39' 10" 26	27°01' 20" 57R	
1804	13°12' 15" 59	11°44' 28" 58	14°55' 25" 53	01°42' 24" 18	01°51' 17" 48R	
7265	04°41' 04" 20	01°37' 09" 38	17°30' 16" 28	12°34' 20" 28	13°15" 15	
281	26°41' 22" 03	25°13' 16" 24	16°45' 28" 33	2°34' 27" 03	11°08' 42' 25" 51R	
1907	18°12' 06" 26	27°56' 05" 26	15°08' 23" 37	37°22" 58	13°15" 11" 58	♃ 33R
248	22°58' 15" 59	10°36' 23" 53	23°57' 29" 51	17°12' 06" 58	24°12' 19" 39R	
7266	24°23' 21" 45	18°54' 24" 16	09°48' 24" 28	29°10' 07" 18	16°44' 28" 47R	
6119	13°30' 02" 23	17°44' 27" 57	19°34' 10" 34	10°06' 22" 59	00°21' 59" 13" 38	
7056	18°12' 14" 29	29°11' 21" 59	08°30' 20" 56	29°24' 06" 05	06°16' 06" 51R	
282	09°15' 10" 25	24°59' 24" 44	26°08' 10" 02	23°54' 03" 50	07°59' 07" 37	
1822	26°29' 07" 19	15°10' 28" 38	27°49' 04" 26	15°10' 14" 45	18°29' 16" 39	
283	17°41' 15" 11	07°54' 03" 48	10°08' 27" 49	28°05' 02" 42	08°58' 25" 59R	
631	22°38' 23" 19	09°42' 20" 18	27°12' 17" 55	06°43' 17" 31	13" 53' 27" 16	
284	15°09' 16" 26	06°11' 54' 14" 46	11°23' 03" 15	15°17" 49' 20" 36	05" 23' 23" 41	
285	05°17' 23" 06	28°56' 19" 49	25°31' 00" 33	25°52' 19" 53	19°53' 10" 05R	
7267	12°48' 29" 49	23°55' 09" 34	00°53' 00" 50	04°36' 18" 22	00°21' 26" 12' 20" 19	

Referenced Example Birth-Chart Data

No. of House Cusp	BIRTH CHART HOUSE CUSPS					
	X	XI	XII	I	II	III
6113	05♂23	II11	♂16	15♂36	♂07	♂05
275	16♂45	♂11	♂04	29♂50	♂10	♂17
2042	27♂38	♂04	II14	17♂57	♂07	♂29
7209	24♂20	♂26	♂23	15♂45	♂13	♂19
7210	29II59	♂03	♂03	29♂59	♂25	♂25
276	13♂14	♂21	♂02	03♂33	♂21	♂13
277	10♂10	♂01	♂00	22♂32	♂29	II21
6170	16♂30	♂09	♂11	01♂29	II03	II26
1926	09II59	♂18	♂20	15♂05	♂07	♂05
7262	17♂00	♂09	♂29	21♂56	♂07	♂18
7129	21♂29	♂16	♂07	27♂17	♂05	♂17
7263	13♂41	♂07	♂09	25♂22	♂29	II23
7264	01♂23	♂03	♂28	19♂10	♂19	♂25
280	21♂47	II23	♂29	27♂49	♂21	♂18
279	19♂10	♂19	♂12	01♂25	♂04	♂12
1804	01♂30	♂04	♂03	26♂52	♂25	♂27
7265	10♂00	♂09	♂17	00II24	II25	♂17
281	16♂13	♂22	II28	29♂33	♂20	♂15
1907	25♂03	♂00	II07	10♂25	♂02	♂26
248	12♂30	♂05	♂25	17♂55	♂01	♂12
7266	09♂36	♂10	♂06	26♂49	♂28	♂03
6119	29♂48	♂28	♂20	08♂09	♂12	♂23
7056	27♂49	♂19	♂11	06♂12	♂24	♂01
882	16♂21	♂12	♂04	23♂50	♂00	♂11
1822	27♂06	II07	♂15	14♂32	♂02	♂26
283	09II59	♂18	♂20	15♂05	♂06	♂05
631	23♂06	♂19	♂12	03♂05	♂10	♂19
284	12♂10	♂17	♂29	07♂26	♂26	♂16
285	11♂41	♂15	♂14	09♂56	♂06	♂07
7267	00II04	♂05	♂07	04♂58	♂28	♂27

Referenced Example Birth-Chart Data

PROCESSED PLANETS

	♁	♂	♃	♄	♅	♆	♇	♈	♉	♊	♋	♌	♍	♎	♏	♐	♑	♒	♓	MC	ASC.			
6113	25°48'	06°23'	11°46'	11°53'	03°39'	00°42'	15°438	16°58	02°17'	17°05'	14°28'	34	05°22'	23										
275	18°26'	10°38'	05°33'	25°42'	25°20'	03°11'	08°12'	6°33'	01°51'	10°12'	12°22'	14°06'	29	24°43'	31									
2042	20°50'	02°58'	13°48'	28°51'	01°02'	10°20'	23°40'	30°09'	14°53'	24°11'	37°18'	4°33'	01°52'											
7209	01°40'	01°36'	25°24'	28°00'	03°50'	08°26'	10°43'	19°44'	17°11'	34°12'	11°22'	7°46'	07°42'											
7210	04°50'	23°05'	16°43'	19°26'	25°32'	13°55'	01°43'	18°56'	12°42'	13°26'	01°52'	41°12'												
276	28°17'	07°10'	21°43'	21°48'	04°28'	12°44'	26°05'	52°15'	29°04'	11°36'	10°54'	54	22°43'	39										
277	17°09'	00°40'	11°33'	00°24'	05°44'	05°44'	05°44'	05°44'	05°44'	05°44'	05°44'	05°44'	05°44'	05°44'	05°44'	05°44'	05°44'	05°44'	05°44'	05°44'	05°44'	05°44'	05°44'	
6170	04°45'	11°38'	21°25'	10°48'	24°07'	15°43'	15°40'	16°11'	23°00'	05°09'	05°19'	402	12°50'	6										
1326	07°21'	14°29'	26°07'	05°53'	13°04'	05°56'	26°06'	04°12'	07°39'	12°56'	05°19'	402	12°50'	6										
7262	23°43'	20°00'	17°43'	18°42'	00°53'	14°19'	19°35'	51°28'	15°15'	13°51'	12°51'	53	26°42'	18										
7129	00°40'	22°45'	05°09'	20°43'	16°06'	07°01'	11°26'	20°43'	14°53'	14°53'	14°53'	49	02°42'	26										
7263	06°39'	20°06'	00°16'	01°46'	03°20'	00°45'	15°29'	29°06'	21°19'	04°12'	06°11'	51	24°05'	12										
7264	05°04'	10°48'	22°36'	01°35'	17°41'	18°47'	07°33'	17°44'	18°43'	14°35'	14°35'	43	14°35'	18										
280	03°37'	25°24'	28°45'	17°25'	28°00'	14°32'	27°39'	20°17'	57°29'	14°17'	10°08'	19	10°08'	19										
279	09°31'	05°40'	07°34'	19°25'	06°26'	28°41'	29°06'	10°23'	02°26'	24°73'	01°51'	11	11°51'	25										
1804	19°55'	14°30'	06°50'	15°48'	27°24'	02°26'	24°73'	01°51'	11°17'	43°08'	13	02°26'	09											
7265	06°32'	02°01'	29°21'	20°29'	07°14'	23°04'	14°01'	20°46'	20°10'	13°11'	36	11°45'	45											
281	22°58'	26°14'	11°38'	25°12'	23°33'	06°53'	26°42'	04°27'	17°07'	19°24'	53	11°23'	30											
1907	26°30'	16°47'	18°15'	03°45'	10°37'	21°16'	25°12'	4°55'	14°45'	11°11'	05°08'	59	10°28'											
248	05°36'	21°59'	16°30'	15°22'	17°16'	01°21'	19°12'	17°33'	05°42'	02°12'	33	58°12'	25											
7266	29°16'	03°56'	20°40'	15°06'	07°56'	16°05'	48°18'	17°34'	14°06'	17°08'	14	17°08'	19											
6119	19°09'	05°39'	24°29'	23°09'	05°27°54'	07°23°23'	39°07'	42°12'	22°13°11'	47°05°27'	07°04'													
7056	23°42'	23°39'	00°28'	03°56'	29°47°55'	12°37'	18°47°13'	23°27'	02°42°25'	17°06°11'	27'	06°11'	54	03°04'	05°52'									
282	16°14'	06°45'	01°07'	23°52'	12°37'	18°47°13'	23°27'	02°42°25'	17°06°11'	27°06°11'	27'	06°11'	54	03°04'	05°52'									
1822	09°54'	03°23'	00°12'	3°58'	19°45'	13°53'	11°45°17'	25°11'	19°30'	17°30'	10	11°14°53'												
283	06°10'	29°43'	24°15'	04°24'	12°41'	08°43'	26°46°04'	11°07°40'	40°25°11°28'	28	21°03'													
631	07°40'	21°20'	10°40'	15°44'	10°53°04'	24°44'	10°46'	15°46°20°02'	21°42°27'	06°59'	25°07'	18°42'	29	05°42'										
284	21°01'	25°14'	01°44'	00°54'	02°48'	29°47°46'	20°02'	21°42°27'	06°59'	25°07'	18°42'	29	05°42'											
285	15°00'	06°28'	26°06'	20°45'	24°48'	00°55°0'	23°18°22'	27°10'	17°29°29'	26°12°30°24'	13°44°22'													
7257	01°44'	17°37'	13°44'	12°36'	03°41'	15°46'	15°46°08'	03°41°26'	26°49°10'	16°54'	19°53°00'	16°54'												

Referenced Example Birth-Chart Data

Chapter 9

Cyst — Hay Fever

THE One Degree Rule For All Progressed Aspects is Valid

—For their research work near the end of 1947, Elbert Benjamine and W. M. A. Drake rechecked the progressed aspects in all the research charts (reports on some of which had been made before there was any ephemeris of Pluto) in which the original report indicated that over one degree must be allowed for progressed aspects involving the Sun or Mars. Their findings, published in C. of L. Astrological Report No. 61,¹ in the January, 1948, number of *The Rising Star*, show that when all the parallel aspects are carefully calculated the one degree orb for all progressed aspects—major, minor and transits—including those involving Sun or Mars, is valid.

But it was found—and with other planets than Sun and Mars—that in judging a particular event cannot take place because the relevant aspect is a little beyond the one degree orb, it is essential carefully to ascertain that ALL parallel aspects by progression involving the planet are also more than one degree from perfect. For a parallel aspect by progression, while it is within the one degree of perfect, is able to widen—both while the zodiacal aspect is applying and while the zodiacal aspect is separating—the influence of the zodiacal aspect, so that sometimes the event indicated by the zodiacal aspect will take place while the zodiacal progressed aspect is as much as a degree and a half from perfect.

CYST

Birth-chart constants: Jupiter afflicted, usually in Scorpio or other watery sign.

Progressed constants: An affliction involving Jupiter at the same time there are severe rallying forces.

¹ Out of print. See *Plain Astrology: 30 Years Research*.

Stellar Treatment: These swellings, which may occur in various parts of the body, are essentially bags with more or less fluid contents. The diet should contain ample sulfur, and care should be taken not to eat too much sugar and fat. The indications are that there is incomplete burning of such fuels, and that the insulin supply needs strengthening. Harmonious Mercury planetary energy should be applied to the zone mapped by Jupiter, and Mercury planetary energy should be applied to the cyst.

Example: Chart 6113. Male, August 23, 1888 4:00 a.m. 74W. 40:43N. Jupiter in Scorpio square Mercury. In July, 1912, as progressed, with Jupiter square Mercury r, and Asc. square Mars p (operation), had an operation to remove two cysts at base of spine. The afflicted Mercury was in the last degree of Leo, mapping the base of spine.

DEAFNESS

Birth-chart constants: Moon severely afflicted by Saturn. If Saturn is prominent and afflicted a severely afflicted Moon may cause trouble with the hearing. Even a powerful harmonious aspect, such as a trine, between Moon and Saturn, may give hearing difficulties of less severity if the Moon is otherwise heavily afflicted.

Progressed constants: An aspect involving Saturn, with severe rallying forces.

Stellar Treatment: The thought-cells mapped in the birth-chart by the Moon need to be harmonized and strengthened through the application of Mars planetary energy. The zone mapped by Saturn should be given Venus planetary energy, and also Sun planetary energy to arouse the thought-cells into activity. Solar electromagnetic energy should be applied to the ears.

Example: Chart 275. Male, October 22, 1905, 12:55 p.m. 90W. 30N. Moon opposition Saturn. In July, 1924, as progressed, with Venus trine Saturn r, and Venus square Mars p as a rallying force, he began to lose his hearing.

DEMENTIA PRAECOX

Birth-chart constants: Negative planets quite prominent and Mercury or the Moon, often both, severely afflicted.

Progressed constants: A powerful aspect involving Mercury or the Moon at the same time there are severe afflicting rallying forces.

Stellar Treatment: This disease may be due to a toxic, or other condition which causes alteration in the physical substance of the brain. The more common form is mal-adjustment of the mental factors giving rise to an attitude in which the mind flees reality and lives in an interior world of fantasy. When there is lack of willingness to face conditions which are present, especially when some event causes a great shock, there is a tendency thus to retreat within.

If there has been physical injury, or if there has been toxic poisoning, this condition must be treated according to its nature. But in all cases the patient must be reeducated to a willingness to enjoy life and face its responsibilities. An analysis of the circumstances leading to the trouble will indicate the best method of approach in this reeducation. The Moon and Mercury thought-cells should be given their planetary antidotes. Proper suggestion during the stellar treatment may be used to advantage.

Example: Chart 2042. Female, September 25, 1907, 11:20 p.m. 71W. 42N. Neptune conjunction Asc., Saturn conjunction M.C., Moon sesqui-square Uranus, and Mercury square Neptune and the Asc. November 24, 1926, as progressed, with Mercury trine Neptune r, M.C. opposition Mercury r, Uranus sesqui-square Moon r, Sun square Mars r, and Asc. opposition Mars p, developed dementia praecox.

DENGUE FEVER

Birth-chart constants: Mars and Venus prominent and usually afflicted.

Progressed constants: A progressed aspect involving Mars, and a progressed aspect involving Venus, usually afflictions.

Stellar Treatment: The virus of this tropical disease is carried by a mosquito. The patient should go to bed and remain there until the eruptions disappear. Fruit juice diet and absence from alcohol are recommended. Cold sponging, cooling applications, and lunar electromagnetic energy may be used to reduce the fever and relieve the headache. The zone occupied by Mars should be given Moon planetary energy, and the zone occupied by Venus should be given Saturn planetary energy.

Example: Chart 7209. Male, October 6, 1895, 8:56 a.m. 77:26W. 37:32N. Mars conjunction Sun, Venus in the tenth square Neptune and Pluto. July 7, 1924, as progressed, with Mars semi-square Venus r, Mars sesqui-square Neptune r, and Sun opposition Moon r, took down with dengue fever.

DERMATITIS

Birth-chart constants: Venus afflicted, especially by one of the upper-octave planets, and one or more of the upper-octave planets prominent.

Progressed constants: An aspect to Venus and an aspect to an upper-octave planet.

Stellar Treatment: The diet should contain calcium, vitamin B-1 and vitamin D, and the thinking should be calm and deliberate to strengthen the parathyroid glands and reduce the hypersensitivity of the nervous system. Planetary energy the antidote of the upper-octave planet responsible for the hypersensitivity should be applied to the zone it occupies. The diet should also contain vitamin A, vitamin E, iodine and copper to strengthen the thyroid gland. Saturn planetary energy should be applied to the zone occupied by Venus.

Example: Chart 7210. Male, September 26, 1924, 5:25 a.m. 86:15W. 41:41N. Mercury sextile Pluto and opposition Uranus, Venus conjunction Neptune and opposition Mars. In March, 1926, as progressed, with Sun semi-square Venus p, and Venus inconjunct Uranus r, developed dermatitis.

DIABETES MELLITUS

Birth-chart constants: Saturn and Jupiter prominent and afflicted, frequently forming an affliction to each other.

Progressed constants: An aspect involving Jupiter or Saturn, often an aspect involving each.

Stellar Treatment: Over-eating, or the eating of too rich foods strains the insulin supply; and worry, anxiety, emotional excitement, or over exertion releases adrenalin which neutralizes the sugar storing power of insulin, causing glycogen to be released into the blood. When the insulin supply is exhausted, sugar can no longer be transformed into glycogen and stored, nor transformed into fat. Instead it remains in the blood as simple sugar, which being soluble, is washed out of the body and lost. In diabetes, therefore, the diet should receive special attention, and a type of thinking cultivated which is free from anxiety, strain and excitement. The dynamic structure mapped by Saturn should receive the planetary energy of Venus. The dynamic structure mapped by Jupiter should be given the planetary energy of Mercury. And the thought-treatment of the solar plexus should be such as to relieve strain, tensions and annoyances.

Example: Chart 276. Male, September 24, 1887, 1:00 a.m. 9:15E. 49:10N. Saturn angular and conjunction Asc. making the square of angular Jupiter. Near his 28th birthday, as progressed, with Jupiter semi-sextile Uranus r, Venus semi-square Saturn p, and Mars semi-sextile Saturn r and square Pluto p, he developed diabetes.

DIPHTHERIA

Birth-chart constants: Negative planets prominent, and often an affliction in Taurus.

Progressed constants: An aspect, usually an affliction, involving Mars, and usually also an aspect involving Mercury.

Stellar Treatment: This is a contagious disease which during an epidemic often has a higher fatality than almost any other illness. The membranes, particularly those of the tonsils and region of the throat and mouth, become the breeding ground of bacilli which form a false membrane, known as diphtheric membrane. A progressed affliction to Mercury, acting on the parathyroid glands, makes the membranes unduly sensitive. The influence of the negative planets lower the vital power, and the progressed aspect involving Mars lowers the adrenalin and cortin output, the

chemicals the body uses to fight invaders. The diet should alkalize the blood stream. Jupiter planetary energy should be applied to the zone occupied by Mercury, and Moon planetary energy to the zone occupied by Mars. Solar electromagnetic energy should be used to build vitality, and lunar electromagnetic energy and Moon planetary energy should be applied to the parts which are inflamed.

Example: Chart 277. Male, October 3, 1908, 6:05 p.m. 122:30W. 47:45N. Moon opposition Neptune from tenth to fourth. In July, 1915, as progressed, with Asc. in Taurus opposition Mercury r, Mercury semi-square Mars r, and Sun square Neptune r, had diphtheria.

DROPSY

Birth-chart constants: A prominent and afflicted Moon.

Progressed constants: A progressed aspect involving the Moon at the same time there are afflicting rallying forces, especially an affliction involving the Sun.

Stellar Treatment: Dropsy is due to imbalance of the salt and water content of the body, governed chiefly by the back pituitary, which in turn responds to the Moon. Thyroxin, which responds to the Sun and also to Venus, tends to drive water from the body, while pituitrin tends to retain it. Therefore the diet and treatment should have for object restoring the back pituitary gland to normal, and strengthening the thyroid. Iodine in the food is a necessity for proper thyroid activity. Emotional stresses should be avoided. Mars planetary energy should be applied to the zone occupied by the Moon, and solar electromagnetic energy and Sun planetary energy should be applied to the thyroid gland.

Example: Chart 6170. Male, July 24, 1861, 11:00 p.m. 92W. 43N. Moon sesqui-square Mercury, square Uranus and opposition Saturn. April 5, 1926, as progressed, with Venus trine Moon r, Uranus semi-square Sun r, and Asc. semi-sextile Mars r in Leo, ruptured (Mars) mitral valve in heart, after which he suffered dropsy until he died in 1932.

DUODENUM TROUBLE

Birth-chart constants: Affliction in Virgo; less commonly a severely afflicted Mercury.

Progressed constants: An aspect, usually an affliction, involving the planet in Virgo or Mercury.

Stellar Treatment: In all digestive difficulties the diet and the thinking are about equally important.

Correcting one without correcting the other is never as effective as it should be. Mental tensions, overwork, and in particular worry and irritation must be avoided and pleasant, constructive thinking cultivated in their stead. The planetary energy

which is the antidote of the afflicted planet in Virgo should be applied to the Virgo zone, if there is such an afflicted planet; and if Mercury is afflicted, Jupiter planetary energy should be given to the zone it occupies.

Example: Chart 1926. Male, October 11, 1878, 3:15 a.m. 1:55W. 53:15N. Uranus in Virgo semi-square Sun; Mercury opposition Moon. In 1928, with Mercury square Saturn p, and Jupiter inconjunct Uranus p in Virgo, a duodenal ulcer formed. In April of that year, as progressed, with Mars (operation) sesqui-square Saturn r, he underwent an operation for its removal.

EAR TROUBLE

Birth-chart constants: Moon afflicted by Saturn. Less severe difficulty may develop if Saturn is prominent and makes even a powerful harmonious aspect with the Moon, especially if the Moon is heavily afflicted.

Progressed constants: An aspect involving Saturn, with severe rallying forces.

Stellar Treatment: The thought-cells mapped in the birth-chart by the Moon need to be harmonized and strengthened through the application of Mars planetary energy. The zone mapped by Saturn should be given Venus planetary energy, and also Sun planetary energy to arouse them into activity. Solar electromagnetic energy should be applied to the ears.

Example: Chart 7262. Male, March 5, 1911, 4:00 a.m. 87:37W. 41:50N. Moon conjunction Saturn, semi-square Pluto, opposition Jupiter. In July, 1920, as progressed, with Pluto semi-square Moon r, and Asc. square Saturn r, developed trouble with his ears.

ECZEMA

Birth-chart constants: Upper-octave planets prominent, and Venus prominent and severely afflicted.

Progressed constants: An aspect involving an upper-octave planet, and an aspect involving Venus; especially an aspect of Venus to an upper-octave planet.

Stellar Treatment: The upper-octave planet through its influence on the parathyroid glands gives a chemical imbalance which makes the individual unduly sensitive; and this sensitiveness, due to the prominent and afflicted Venus, is especially noticeable in the skin. Venus influences the thyroid gland, the secretion of which directly affects the skin.

Careful attention should be given to the diet that there may be no indigestion, that the thyroid has iodine, that there is sufficient copper for blood building, the vitamins required by Venus, and calcium and vitamin D for the parathyroid glands. The zone occupied by the responsible upper-octave planet should receive the planetary energy of that planet's antidote, the zone occupied by Venus should receive Saturn planetary energy, and lunar electromagnetic energy should be applied to the region where the eczema appears. The individual may have an idiosyncrasy as to certain items of diet, or be sensitive to wool clothing, to dyes in the clothing, or to other things usually unnoticed by other people.

Example: Chart 7129. Female, March 10, 1909, 2:00 a.m. 87:37W. 41:50N. Uranus and Neptune in angles, and they, as well as Pluto, aspecting both Sun and Moon. Venus sesqui-square Moon. March 10, 1920, as progressed, with Pluto trine Moon r, Jupiter opposition Venus r, Mercury semi-square Uranus r, Asc. sextile Venus r, and Venus sextile Uranus r, developed a bad case of eczema on arm (Pluto in Gemini in sixth).

EMPHYEMA

Birth-chart constants: Pluto or Neptune afflicted, and either an affliction in Gemini or Mercury severely afflicted.

Progressed constants: An aspect involving Pluto or Neptune at the same time there are severe rallying forces.

Stellar Treatment: The diet should be rich in calcium, vitamin B complex and vitamin D. Mucus forming foods should be avoided. The zone occupied by the aspected Pluto or Neptune should receive the planetary energy of its antidote, and also the vitalizing Sun planetary energy. The affliction in Gemini should be given its planetary antidote, and the region of the emphyema should be given solar electromagnetic energy. Everything should be done to build up the vitality.

Example: Chart 7263. Male, September 17, 1889, 7:06 p.m. 73:40W. 41N. Neptune and Pluto in Gemini sesqui-square Mercury and Uranus. On May 31, 1900, as progressed, with Pluto in Gemini sesqui-square Uranus p and Mercury r, Sun trine Pluto r in Gemini, and Mars sextile Moon r, developed emphyema. Later a piece of rib was taken out (Mars) to drain off the pus.

EPILEPSY

Birth-chart constants: Affliction involving Mars, and affliction involving Venus.

Progressed constants: An aspect to Mars and an aspect to Venus. There are probably other constants, but at present we have too few data of epileptics to be able to discover them.

Stellar Treatment: The abnormal nervous tension, and congestion of electrical energy which gives rise to these seizures seems to derive from imbalanced secretions

of the glands influenced by Mars and Venus. The first seizures often arrive at the age of puberty. The diet should be such as that indicated for an afflicted Mars, and for an afflicted Venus. Strain and excitement and stimulating food should be avoided. The zone occupied by Mars should receive Moon planetary energy. The zone occupied by Venus should be given Saturn planetary energy. Lunar electromagnetic energy should be applied to the medulla oblongata. Hospitals use dilantin for grand mal, and tridione for petit mal.

Example: Chart 7264. Male, January 9, 1922, 3:00 a.m. 104:45W. 42:15N. Mars conjunction Asc., Venus square Saturn and opposition Pluto. June 1, 1938, as progressed, with Mars semi-sextile Jupiter r and sextile M.C. p, and with Venus sextile Asc. p, had first epileptic attack.

ERYSIPELAS

Birth-chart constants: Upper octave planets prominent, Venus prominent and afflicted, Mars prominent and afflicted.

Progressed constants: An aspect involving an upper-octave planet, an aspect involving Venus, and an affliction involving Mars.

Stellar Treatment: The treatment as to diet and irritations should be that advocated for eczema, with the addition of the dietary factors recommended for an afflicted Mars. For in erysipelas there is also a Mars condition, with inflammation of the skin, and fever, which may run so high as to occasion delirium. Cold applications are commonly used to reduce the fever. Lunar electromagnetic energy should be applied to the inflamed areas for the same purpose. Like many Mars diseases it is somewhat contagious. The zone occupied by Mars should be treated with Moon planetary energy, the zone occupied by the upper-octave planet should receive the planetary energy of its antidote, and the zone occupied by Venus should receive Saturn planetary energy.

Example: Chart 280. Male, March 27, 1902, 3:00 p.m. 90W. 40:30N. Pluto in the tenth, Neptune opposition Uranus in the fourth, Mars conjunction Sun, Venus opposition Asc. and square Moon. In February, 1930, as progressed, with Venus square Pluto r, Asc. square Uranus p, Mars square Saturn p, and Mercury conjunction Mars p, he had erysipelas.

EXOPHTHALMIC GOITER

Birth-chart constants: Sun afflicted by Uranus, or less commonly a prominent Uranus and the Sun severely afflicted.

Progressed constants: Sun aspecting Uranus, or Sun involved in severe affliction, especially if Venus at the same time is involved in an affliction.

Stellar Treatment: The diet should be that advocated for a weak thyroid gland and weak parathyroid glands, containing iodine, calcium, vitamin A and vitamin D. The thought education, and the thought treatment of the solar plexus, should have for object a calm, poised and unemotional state of mind. Emotional stress and excitement should be discouraged. Jupiter planetary energy should be applied to the zone occupied by Uranus and to the zone occupied by the Sun. Not infrequently, due to the sensitiveness of the nervous system and the excitable tendency, digestive troubles are also present. These should receive proper treatment.

Example: Chart 279. Female, October 26, 1873, 9:00 a.m. 84W. 43:30N. Sun square Uranus. In October, 1909, as progressed, with Sun trine Uranus r, Venus opposition Pluto p, she developed exophthalmic goiter.

EYE TROUBLE

Birth-chart constants: Moon severely afflicted by Mars. If Mars is prominent and afflicted, a severely afflicted Moon may cause trouble with the eyes. Even a strong harmonious aspect, such as a trine between Moon and Mars may cause trouble with the eyes of a less severe nature, if the Moon is otherwise severely afflicted. When these constants are not present the eyes may give trouble, not because of any defect in them, but due to nervous depletion.

Progressed constants: An aspect involving Mars with severe rallying forces. If due to nervous depletion the Mars aspect may be absent, and an affliction involving Mercury or the upper-octave planets may be present instead.

Stellar Treatment: If the difficulty is due to nervous depletion, the vitality should be built up and the diet should contain ample vitamin A and vitamin B-1. But in typical eye troubles the eyes themselves should be treated with lunar electromagnetic energy, and the zone occupied by the Moon should be strengthened by adding to it harmonious Moon planetary energy.

Example: Chart 1804. Female, February 2, 1903, 11:50 p.m. 81W. 40N. Mars opposition Moon. Has had much difficulty with the eyes. In the summer of 1909, as progressed, with Mars opposition Moon r, and Moon square Mars r, became near sighted.

FAINTING

Birth-chart constants: Sun afflicted or a planet in Leo afflicted, and Pluto or Neptune heavily afflicted.

Progressed constants: An aspect to the Sun or the planet in Leo at the same time there is a progressed affliction involving Neptune or Pluto.

Stellar Treatment: Fainting is due to a momentary failure of the blood supply to the brain. As the heart action is usually depressed at the time of fainting, the afflicted Sun should be strengthened by applying to it harmonious Sun planetary energy, or the

planet in Leo should be given the energy of its planetary antidote. Glandular balance should be restored through proper diet and thinking. And the mental or toxic condition indicated by the afflicted Neptune or Pluto should be given attention. The energy of its planetary antidote should be applied to the zone occupied by the afflicted Neptune or Pluto.

Example: Chart 7265. Female, July 27, 1896, 1:00 a.m. CST. 97:53W. 36:24N. Venus in Leo sextile Pluto. In September, 1929, as progressed, with Venus square Neptune p, started to have fainting spells. These continued for years.

FATTY TUMOR

Birth-chart constants: A prominent and severely afflicted Jupiter.

Progressed constants: An affliction involving the Sun, and an aspect involving Jupiter.

Stellar Treatment: Insulin tries to get rid of the overtaxing burden of fat in the blood due to overeating, or to eating too rich foods, in proportion to the amount of exercise taken. In the effort to rid the blood of fuel which cannot be burned, it finds irritated spots a convenient dumping ground, and thus a fatty tumor develops. Proper exercise and a diet less rich in fat producing qualities is the first need. Then, as there is too much insulin in proportion to adrenalin and thyroxin, the zone occupied by Jupiter should be treated with Mercury planetary energy. In addition, there should be iodine in the food, and the zone occupied by the Sun should be given Venus planetary energy, and the thyroid gland should be treated with solar electromagnetic energy.

Example: Chart 281. Female, October 20, 1878, 11:00 p.m. 94:45W. 38N. Jupiter opposition Asc. and square Sun and Mercury. By August, 1933, after Sun had just passed the semi-square Jupiter p, and had reached the sesqui-square of Neptune r, and Jupiter was square Neptune p, four fatty tumors had developed.

FEMALE TROUBLE

Birth-chart constants: A severely afflicted Venus. More pronounced if there is also an afflicted planet in Libra or Scorpio.

Progressed constants: An aspect, usually an affliction, involving Venus. If an operation takes place there is an aspect to Mars.

Stellar Treatment: A wide variety of complaints come under this heading. But in all of them the thought-cells mapped by Venus are chiefly responsible. If Saturn is not the planet afflicting Venus, its energy should be applied to the zone occupied by Venus. When Saturn is the planet afflicting Venus, or when the difficulty involves a negative planet, Sun planetary energy should be applied to the zone occupied by Venus or the negative planet. Solar electromagnetic energy should be applied to the female organs. The diet should be that recommended for an afflicted Venus, ample wheat germ being especially beneficial. There is also present an unregulated emotional factor which requires mental education and thought treatment.

Example: Chart 1907. Female, December 9, 1893, 6:00 p.m. CST. 83:30W. 32:45N. Venus semi-square Sun and square Uranus. Mars conjunction Uranus in Scorpio. There was chronic female trouble which in July, 1931, as progressed, with Mercury semi-square Venus p, Sun sesqui-square Neptune r, Mars opposition Neptune p, and Uranus conjunction Mars r, resulted in an operation. It was unsuccessful and was later repeated.

FIBROUS TUMOR

Birth-chart constants: Saturn prominent and afflicted. If the tumor is of the uterus, which is most common, Venus afflicted, and a planet in Scorpio or an afflicted Mars.

Progressed constants: A discordant aspect involving Saturn.

Stellar Treatment: Solar electromagnetic energy should be applied to the fibrous growth, and Sun planetary energy and Venus planetary energy should be applied to the zone occupied by Saturn. If the tumor is of the uterus the zone occupied by Venus should be given Sun planetary energy, and the thyroid gland should be given solar electromagnetic energy. The diet should be that recommended for Saturn and for Venus, ample wheat germ being beneficial. Some essential thing is lacking in both the diet and in the thinking. There is emotional imbalance, or lack of emotional expression, and a self-centered quality where affectional matters are concerned. The mental reeducation should be directed toward establishing normal harmonious affectional emotions and toward restoring the thyroid gland to normal activity.

Example: Chart 248. Female, November 14, 1872, 11:00 a.m. 74W. 40:43N. Saturn conjunction Asc. and square Neptune, Sun in Scorpio, Venus square Mars. In March, 1915, as progressed, with Mars square Saturn r, a fibrous tumor of the uterus was removed by surgical operation.

FOOT TROUBLE

Birth-chart constants: Afflicted planet in Pisces or a prominent Neptune.

Progressed constants: A discordant aspect involving the planet in Pisces, or a discordant aspect involving Neptune.

Stellar Treatment: Foot trouble is a term embracing a number of difficulties that may affect the feet. If the difficulty is mapped by a planet in Pisces, the planetary energy of the antidote of this planet should be applied to the zone of the feet. Electromagnetic energy applied to the feet is often beneficial. If Neptune is afflicted, Saturn planetary energy and Sun planetary energy should be applied to the zone occupied by Neptune. Usually there is a physical condition, such as improper shoes or improper exercise which needs attention. Fallen arches, for instance, respond to proper shoes and systematic exercise to strengthen the foot muscles.

Example: Chart 6119. Female, March 4, 1899, 0:54 a.m. 85:30W. 45N. Sun and Mercury in Pisces square Pluto, Mercury square Saturn, Neptune opposition Saturn and square Mercury. She had foot trouble constantly, as progressed Pluto was square Sun in Pisces the first 54 years of her life. In February, 1935, as progressed, with Pluto square Sun r, Venus in Pisces semi-square Mercury p, and Sun square Mars r (operation), it became so serious an operation was performed on her feet.

FUNGUS GROWTH

Birth-chart constants: Prominent and heavily afflicted Neptune.

Progressed constants: An aspect to Neptune at the same time there are severe rallying forces.

Stellar Treatment: During World War II penicillin was successfully used in the treatment of a variety of fungus growths contacted in the South Pacific. The vitality should be built up, and normal activity restored to the adrenal glands, the secretions of which are depressed through the influence of Neptune. Sun planetary energy should be applied to the zone occupied by Neptune, and solar electromagnetic energy should be applied to the region attacked by the fungus growth. The thinking should be positive and of the Sun type. The diet should be ample, and contain calcium, vitamin B-1 and vitamin D.

Example: Chart 7266. Male, October 17, 1881, 9:00 a.m. 87:35W. 37:58N. Neptune conjunction Saturn, opposition Mercury, and square Moon. In September, 1906, when progressed Sun reached the conjunction of afflicted Mercury r, and progressed Mars was sextile Neptune p, the fungus growth got a hold in his throat (Neptune in Taurus) and bronchial (Mercury) tubes. During forty years his health was poor and he was unable to get rid of it. On September 13, 1946, as progressed, with Sun sesqui-square Neptune p, and M.C. opposition Neptune p, he died of this chronic fungus growth.

GALL BLADDER TROUBLE

Birth-chart constants: A prominent and heavily afflicted Mars.

Progressed constants: An aspect involving Mars at the same time there are severe rallying forces.

Stellar Treatment: When the diet is deficient in the alkaline producing minerals, the blood stream becomes acid. An afflicted Mars tends to depress the secretion of adrenalin and cortin which tend to neutralize the acid condition. The bile and the gall bladder are under the influence of Mars, and when the blood stream is acid it may cause inflammation of the bile ducts and the gall bladder. A diet should be used which will alkalize the blood stream. The thinking should be harmonious and soothing, of Moon quality, Moon planetary energy should be applied to the zone occupied by Mars, and lunar electromagnetic energy should be applied to the region of the gall bladder. If there is a progressed Saturn aspect, indicating the likelihood of gall stones, there should be the additional treatment given under that heading.

Example: Chart 7056. Male, February 7, 1892, 6:30 a.m. 74W. 40:43N. Mars in the tenth opposition Moon, Pluto and Neptune. In spring of 1927 the gall bladder became inflamed. On March 6, 1927, as progressed, with Mars square Jupiter p and square Saturn r, had an operation on the gall bladder.

GALLSTONE

Birth-chart constants: Mars and Saturn prominent and afflicted, usually aspecting each other.

Progressed constants: An aspect involving Mars, and an aspect involving Saturn, at the same time there are severe rallying forces.

Stellar Treatment: Gall stones (biliary calculi) are hard masses, composed of cholesterine, an abundant constituent of bile, in combination with various calcarious substances. The acidity of the blood stream is increased through the dietary deficiencies developed under the influence of Saturn. Sedentary habits increase the chemical imbalance through lack of proper elimination. People in the close confinement of jails, and cows that are kept closely in stable in winter, are most frequent sufferers from gall stones. The toxic blood stream may cause mucus to form in the gall bladder or bile ducts, about which the concretions form as hard masses. Heavy doses of olive oil are often used to cause the stones to pass out of the body. To the treatment advocated for gall bladder trouble should be added the diet recommended for an afflicted Saturn, and Venus planetary energy should be applied to the zone occupied by Saturn.

Example: Chart 282. Male, April 28, 1892, 10:00 p.m. LMT. 74:15W. 40:45N. Venus square Saturn, Sun sesqui-square Saturn, Saturn trine Mars in an angle, Mars square Mercury. March 5, 1931, as progressed, with Venus sextile Saturn r, Sun sesqui-square Uranus p, and Mars parallel Neptune p, underwent operation for gall stones.

GANGRENE

Birth-chart constants: Negative planets prominent and Mars or Venus, usually both, afflicted.

Progressed constants: An aspect involving Mars at the same time there is an affliction involving Pluto, Neptune or Saturn.

Stellar Treatment: Everything should be done to build up the vitality. The negative planet afflicted by progressed aspect should be given the planetary energy of its antidote, and it should be given Sun planetary energy. Solar electromagnetic energy should be applied to the region affected by gangrene. The zones occupied by Venus and Mars should be given the planetary energy of their antidote. The diet and treatment should have for their object the revitalization of the whole system, and the re-establishment of the normal activities of the gonad and adrenal glands.

Example: Chart 1822. Female, May 17, 1869, 10:00 a.m. 0W. 51:32N. Saturn opposition Mercury, Neptune sextile Mercury, Pluto semi-sextile Mercury. On June 5, 1914, as progressed, with Mars inconjunct Neptune p, Saturn sesqui-square M.C. r, Uranus (appendicitis) sextile Pluto r, Jupiter square Asc. r, and Mercury semi-square Asc. r, died of gangrene of the appendix.

GASTRITIS

Birth-chart constants: Moon heavily afflicted, especially by Mars, or a planet in Cancer heavily afflicted.

Progressed constants: An aspect to Mars at the same time there are heavy rallying force afflictions.

Stellar Treatment: Acute inflammation of the stomach may be caused by alcohol taken on an empty stomach, by boiling liquids taken into the stomach, or by other gross abuse of the stomach. It is a very serious illness. The stomach must be given absolute rest, and water must be supplied to the digestive tract, and other means should be taken to keep the temperature down in the region of the stomach. Lunar electromagnetic energies should be applied abundantly to the inflamed region. The imbalance where the cortin and adrenalin supply are concerned, resulting from the Mars influence, does not offer the normal check to inflammation. The zone occupied by Mars should receive harmonious Moon planetary energy, and thoughts should be cultivated that will bring harmony between the Mars and Moon thought-cells. Its planetary antidote should be applied to any afflicted planet in Cancer.

Example: Chart 283. Male, October 11, 1878, 3:13 a.m. 1:55W. 53:15N. Moon opposition Mars, Mercury and Sun. In February, 1927, as progressed, with M.C. in Cancer opposition Jupiter r, and Mars sesqui-square Saturn r, had an attack of gastritis.

GASTRIC ULCER

Birth-chart constants: One or more upper-octave planet prominent, Jupiter afflicted, and either an afflicted planet in Cancer or a heavily afflicted Moon.

Progressed constants: An aspect involving an upper-octave planet, an aspect involving a planet in Cancer or Jupiter, and an aspect involving Mars.

Stellar Treatment: Mental stress should be avoided, as it releases adrenaline and withdraws the blood from the stomach. The stomach becomes unduly sensitive due to the influence of the upper-octave planet on the parathyroid glands and the affliction in Cancer or to the Moon. The Jupiter influence indicates inability to handle sugars and starches properly. A catarrhal condition of the stomach results under the Mars influence which may become an ulcer. Thus in addition to calm and harmonious thinking there should be rest for the stomach; and the ketosis (incompletely burned fatty acids in the blood) must be taken care of through a diet low in fats, sugar, and other foods difficult to handle, and through strengthening the insulin supply by treating the zone occupied by Jupiter with harmonious Mercury planetary energy. The zone occupied by Mars, and the zone occupied by the Moon or the planet in Cancer, should be given the planetary energy antidote, and the stomach should be strengthened and soothed through applying lunar electromagnetic energy.

Example: Chart 631. Male, February 11, 1882, 4:00 a.m. 88:45W. 35:30N. Moon opposition Jupiter and Pluto, square Venus and the Sun; Mercury opposition Uranus. In July, 1926, as progressed, with Asc. square Moon r, Venus inconjunct Uranus p, Mercury trine Mars p in Cancer, and Mars semi-square Jupiter p, developed gastric ulcer.

GOITER

Birth-chart constants: Affliction in Taurus, or Venus and the Sun afflicted.

Progressed constants: An affliction involving the planet in Taurus, Venus, or the Sun.

Stellar Treatment: There must be sufficient iodine in the food, as well as the other things advocated when Sun and Venus are afflicted. Goiter is a disease of the thyroid gland, the gland of energy production. It may be produced by lack of iodine in the food, too great a proportion of protein or fat in the food, or by emotional strain. The first thing, therefore, is to provide a proper diet. Then there should be systematic education in the thinking to prevent emotional reactions of a disagreeable kind, and to prevent excitement. Normal love expression and harmonious thoughts associated with the desire for self esteem and power are beneficial. The zone occupied by the Sun should be given Jupiter planetary energy, the zone occupied by Venus should receive some Saturn planetary energy, but more Sun planetary energy. The throat should be given the planetary energy which is the antidote of any afflicted planet in Taurus, and should be treated with electromagnetic energy.

Example: Chart 284. Female, May 5, 1877, 8:00 a.m. 92:30W. 43N. Sun and Venus in Taurus, conjunction Pluto, square Moon and Mars. In September, 1914, as progressed, with Venus semi-square Sun r, and opposition Jupiter p, and Mars

(operation) semi-square M.C. p, goiter became so serious that it was surgically removed.

GONORRHEA

Birth-chart constants: Venus and Mars afflicted, or one of them severely afflicted and the other prominent.

Progressed constants: A discordant aspect involving Venus or Mars.

Stellar Treatment: A discordant Mars aspect reduces the cortin and adrenaline supply which resist infection. A discordant Venus encourages gonad imbalance on which the system must largely depend for vigor. Hospitals use penicillin with excellent results. Diet is very important. Rich foods should be avoided, and fruit juices used abundantly to restore alkaline reaction to the blood stream. The diet should be that recommended for an afflicted Venus and an afflicted Mars. The zone occupied by Venus should be given the planetary energy of Saturn and the planetary energy of the Sun. Moon planetary energy should be applied to the zone occupied by Mars, and lunar electromagnetic energy should be applied to the infected area.

Example: Chart 285. Male, September 26, 1882, 6:30 a.m. 84W. 42N. Mars conjunction Mercury in the first; Venus opposition Neptune and Saturn. In September, 1924, as progressed, with Mercury conjunction Mars r, and Venus square Uranus r, he contracted gonorrhea.

HAY FEVER

Birth-chart constants: Mercury afflicted by an upper-octave planet, or upper-octave planets prominent and Mercury severely afflicted.

Progressed constants: An aspect involving Mercury, especially an affliction.

Stellar Treatment: The affliction of Mercury and the prominent upper-octave planets upset the chemical balance through reducing the ability of the parathyroid glands to handle calcium. Mercury rules the mucous membranes, and they become unduly sensitive to certain weed and flower pollen, to certain foods, or to atmospheric conditions. The treatment, therefore, should have as its aim the restoration of the mineral balance of the body through the diet recommended for Mercury and the prominent upper-octave planet. The nervous strain of the individual should be reduced through the application of lunar electromagnetic energy and thought-corrective education, the zone occupied by Mercury should be given Jupiter planetary energy, and the zone occupied by any prominent upper-octave planet should be given the energy of its planetary antidote.

Example: Chart 7267. Male, July 4, 1872, 9:00 a.m. 72:45W. 42:15N. Mercury conjunction Uranus, sextile Pluto and square Neptune. In August, 1923, as progressed, he suffered from hay fever, a complaint which he had recurrently.

Chapter 10

Serial No. 206
Original Copyright 1947
Elbert Benjamine

Copyright
August 2002
Church of Light

Headache — Mumps

BIRTH CHART PLANETS

	♈	♉	♊	♋	♌	♍	♎	♏	♐	♑	♒	♓	♈	♉	♊	♋	♌	♍	♎	♏	♐	♑	♒	♓
7274	15°46	04°39	29°43	12°49	00°15	15°22	22°18	6°41	03°02	21°50	27°10	02												
2056	17°44	15°43	23°06	06°16	27°33	22°58	59	23°21	28°38	24°14	06°16	16R												
2055	18°35	26°43	24°30	20°12	20°09	22°51	28°45	18°12	25°12	18°12	32R													
7777	07°20	28°03	08°40	20°13	20°13	53°11	02°48	02°11	29°22	24°06	6°27	27R												
297	00°48	16°15	15°36	10°42	01°12	20°00	56°06	22°04	08°11	04	28°01	07°36												
7262A	13°43	10°23	00°46	09°12	23°40	14°46	01°03	02	27°15	18°57	12°51	61												
6233	03°36	15°42	22°15	10°52	11°40	27°23	26°53	37°18	48	03°02	29°02	2547												
1555	01°05	07°58	08°23	15°11	42	06°52	00°09	04°37	37°09	22	15°23	15°07												
6116	11°16	22°37	11°54	26°42	22°42	04°40	17°13	28°02	20°55	54	27°11	44												
7275	05°57	28°21	21°17	29°32	22°23	27	09°04	18°28	08°42	10°48	07°50													
517	20°21	20°33	27°50	14°15	05°18	26°11	06°46	19°50	13	10°05	09°11	48												
19	07°45	00°36	18°43	17°03	17°03	01°18	10°56	12°18	27°17	45	04°41	41R												
300	28°12	00°10	19°11	06°25	22°47	22°02	02°53	29°22	19°14	18°54	29°36													
299	25°47	17°51	15°26	26°29	28°29	09°11	17°43	04°35	26°11	59	16°11	34												
7276	10°16	16°30	22°39	24°38	13°50	27°20	24°11	14°29	17	22°11	51R													
301	24°20	26°42	16°08	05°28	20°06	17°17	16°28	28°45	04	45R	35R													
7277	21°12	29	26°58	06°57	10°40	04	11	15	17°10	26°19	18°10													
3197	18°49	09°03	23°50	04°53	22°17	20°54	19°32	06°11	43	28°49	08°10													
7278	28°20	20°00	25°12	09°25	16°44	27°42	12°31	14°43	02°17	05°11	49													
7279	02°58	16°59	21°12	17°48	04°40	17°38	15°55	15°11	03°23	10°19														
7280	18°43	02°29	15°03	25°15	19°54	25°11	58	14°46	05°59	10°28	22°11	47												
302	17°49	23°06	25°33	07°54	20°53	03°02	58	05°11	45	18°56	29°48R													
303	00°11	36	08°20	16°11	05°10	28°30	19°13	09°49	24°36	12°18	11°40													
7291	06°26	12°02	17°09	06°20	10°04	28°45	21°57	11°24	26°09	03°06R														
304	06°00	06°17	22°42	26°19	29°05	08°11	16°03	16	07°31	03°18	25°46R													
7281	19°40	18°03	08°36	02°58	18°28	20°16	16°06	11°14	00°11	55	06°28R													
7282	20°11	28	18°14	07°11	53	03°41	21°45	08°54	23°47	02°55	19°11													
7283	02°35	00°00	13°11	46	18°28	06°11	59	28°53	00°20	23°27	03°50													
7284	24°46	13°32	05°44	05°44	05°44	04°17	23°33	28°32	11°09	20°47	00°03R													

Referenced Example Birth-Chart Data

BIRTH CHART HOUSE CUSPS						
No. of House	Cusp	X	XI	XII	I	II III
273	09	♌14	♋07	♋29	19♌56	♌25 ♌04
7269	15	♌30	♋18	♌14	06♋16	♌03 ♌08
7268	25	♋58	♌18	♌08	03♌31	♌20 ♋29
7270	12	♌20	♌02	♌24	25♌49	♋15 ♌19
305	06	♋55	♌01	♌23	14♌49	♌26 ♋06
286	04	♋24	♌06	♋01	22♋07	♌22 ♌27
7271	01	♌16	♋04	♌03	26♌54	♋25 ♌27
7272	18	♌55	♌14	♌17	02♌24	♌04 ♌27
278	28	♌31	♌01	♋03	00♌59	♌00 ♌28
287	11	♌41	♌16	♌17	14♋26	♌09 ♋08
7273	21	♌13	♋16	♌07	26♌09	♌05 ♌17
7238	06	♋23	♌00	♌20	11♌41	♌24 ♋05
2141	23	♌11	♌26	♌27	24♋00	♌20 ♋20
7239	01	♌17	♋03	♌06	07♌21	♌04 ♌02
289	05	♋34	♋29	♌18	07♌37	♌21 ♋05
2031	04	♋40	♋29	♌19	09♌51	♌22 ♋03
290	01	♋51	♋27	♌18	09♌30	♌19 ♌29
6303	17	♌01	♌21	♋20	14♌31	♋12 ♌15
6212	19	♌04	♌22	♋22	16♌27	♋14 ♌15
291	29	♌31	♌03	♌07	08♌24	♌02 ♌28
7060	02	♌08	♋06	♌04	26♌22	♋24 ♌25
6278	18	♌02	♌21	♋21	15♌45	♋13 ♌14
292	00	♌41	♌29	♋21	09♌07	♌13 ♌23
6330	19	♌03	♋15	♌07	27♌24	♌04 ♌15
293	17	♌25	♋22	♌02	07♌24	♌28 ♌20
294	08	♌31	♌00	♌29	17♋11	♌25 ♌19
296	08	♌28	♋12	♌09	00♋58	♋29 ♌02
295	29	♌42	♌06	♌14	17♌38	♌08 ♋01
1870	07	♌15	♋11	♌09	01♋16	♋29 ♌02

Referenced Example 1 Birth-Chart Data

PROGRESSED PLANETS

	☉	☽	☿	♋	♌	♍	♎	♏	♐	♑	♒	♓	MC	Asc.
273	11 42 26	16 44 16	24 44 42	15 44 17	21 33 19	29 53 09	18 56 12	R2 42 30	03 R15 37	10 II 57	11 54 31	21 47 56		
7269	18 52 12	06 47 54	07 44 46	R2 65 08	02 47 36	20 46 25	R16 53 14	11 54 14	R7 02 30	03 65 12	R10 47 18	24 44 15		
7268	00 50 50	05 47 13	04 49 44	08 49 25	05 53 10	04 49 09	20 49 17	05 47 03	R11 18 21	26 48 12	02 44 36	24 48 35		
7270	02 44 13	20 53 00	06 45 52	03 45 35	28 48 08	R05 47 22	29 52 40	R15 47 27	4 50 03	II 13 12	53 10 II 08			
305	23 44 23	26 48 11	25 44 50	18 44 33	26 44 40	07 45 50	25 43 1	21 47 13	28 II 41	16 II 40	26 44 28	05 44 59		
286	26 44 32	07 44 54	05 44 04	28 44 48	03 44 50	R08 49 06	13 44 29	15 45 01	R14 49 41	15 48 02	03 44 28	08 44 50		
7271	22 44 56	04 44 21	25 44 54	08 44 45	03 44 43	09 44 11	26 44 37	13 44 53	24 44 50	00 44 25	19 44 07			
7272	11 44 34	17 44 33	22 44 37	R06 II 58	22 II 08	14 44 06	27 44 39	00 44 58	10 44 07	23 44 56	22 44 36	08 44 05		
278	02 44 15	07 44 26	08 44 49	02 44 04	09 44 20	20 44 55	29 44 09	23 44 15	01 44 48	R18 II 03	R14 47 16	14 44 44		
287	20 44 50	03 44 53	25 44 47	25 44 24	03 44 54	21 44 46	09 44 01	16 44 20	R14 47 23	27 44 25	21 44 55	18 44 10		
7273	21 44 33	04 44 16	12 44 22	R23 44 22	12 44 35	R21 44 57	01 44 49	25 44 50	19 44 33	21 44 59	14 44 12			
7238	26 44 05	19 44 58	29 44 47	12 44 44	16 44 13	06 44 27	R00 47 20	28 44 57	17 44 33	R11 II 41	28 44 43	07 44 24		
2141	11 44 33	10 44 17	29 44 37	13 44 02	11 44 47	16 44 46	02 II 07	R29 44 26	55 01 R29 II 46	R14 44 53	12 44 21			
7239	10 44 05	21 44 08	24 44 12	R24 44 45	05 44 47	24 44 04	R06 44 43	00 44 01	R28 44 57	17 44 06	R02 44 00	08 II 00		
289	18 44 00	24 44 10	20 44 01	02 44 53	21 II 09	05 44 53	05 44 56	16 44 46	R12 44 54	23 II 27	27 44 41	02 44 44		
2031	23 44 56	07 44 27	14 44 35	10 44 28	29 44 51	07 44 06	17 44 20	R18 44 11	19 44 51	26 II 24	R09 44 59	15 44 18		
290	03 44 38	08 II 20	01 44 03	02 44 48	15 44 15	24 44 08	R14 44 23	R27 44 06	08 44 07	R21 II 23	R17 44 27	25 44 08		
6303	26 44 46	26 44 32	13 44 15	R15 44 49	29 44 16	04 44 25	29 44 44	00 44 25	R09 44 53	22 II 29	28 44 25	24 44 01		
6212	28 44 35	12 44 22	08 44 46	24 44 22	05 44 35	11 44 10	R09 44 03	R01 44 30	09 44 39	R05 44 49	R09 44 40	03 44 52		
291	29 44 59	10 44 38	06 44 49	29 44 00	16 44 15	02 44 18	R21 44 37	54 44 06	17 44 32	II 34 14	II 46 20	44 15 25	44 21	
7060	06 44 50	08 44 41	16 44 53	21 44 02	25 44 36	R09 44 00	20 44 23	07 44 08	22 II 19	R13 II 49	R23 44 11	12 44 22		
6278	28 44 02	07 44 34	22 44 39	12 44 35	04 II 17	00 44 36	R05 44 10	15 44 54	R02 44 34	22 44 27	22 44 14	05 44 56		
292	23 44 14	22 44 57	08 44 19	02 44 17	16 44 11	19 44 28	R28 44 40	02 44 30	R24 44 40	28 44 13	00 44 49	03 44 13		
6630	09 44 00	14 44 08	14 44 09	25 44 25	12 44 30	24 44 54	R28 44 40	02 44 30	R24 44 40	28 44 13	00 44 49	03 44 13		
293	26 44 03	02 44 43	12 44 36	R08 44 32	12 44 43	17 44 26	26 44 58	R20 44 53	17 44 41	10 44 49	23 44 46	12 44 26		
294	08 44 13	12 44 06	02 44 43	14 44 52	R12 44 21	22 44 20	06 44 39	R19 44 35	06 44 20	24 44 22	14 44 41	11 II 54		
296	04 44 58	24 44 20	03 44 36	19 44 12	05 II 30	01 44 39	28 II 46	28 44 59	24 44 33	02 II 15	22 44 05	02 44 57		
295	15 II 41	22 44 49	13 II 50	14 44 03	27 II 03	18 II 03	14 44 44	07 44 21	R09 44 51	22 II 01	24 44 26	06 44 12		
1870	18 44 03	00 44 20	28 44 12	R19 44 53	R16 44 02	25 44 41	24 44 13	R15 44 12	R10 44 51	08 II 48	07 44 15	23 44 37		

Chapter 10

Headache — Mumps

HEADACHE

Birth-chart constants: A wide variety, depending on the malady which expresses as headache. A planet in Aries, especially if afflicted, tends toward headache.

Progressed constants: According to the disease, but made more likely by an aspect involving Mars, and especially involving a planet in Aries.

Stellar Treatment: Headache may be due to afflictions of the nerves, to digestive disturbances, to cold in the head, to fever resulting from infection, etc. Therefore, before treatment, the disease must be determined of which it is the result. A neuralgic headache needs different treatment than does one due to so-called biliousness. There is nearly always congestion in the head, and this may be relieved by passes from the top of the head downward, and through treating the congested area with lunar electromagnetic energy. One of the most satisfactory ways of causing the pain to cease is thus to bring about a redistribution of the electromagnetic energies of the body. Reduction or removal of the pain, however, must not be considered as healing the condition. The disease of which the headache is a manifestation should be determined and treated.

Example: Chart 273. Female, March 29, 1896, 12:15 a.m. 122:30W. 38N. Sun in Aries opposition Moon and M.C. Headaches since early childhood, due to digestive (Moon and Mercury afflicted) trouble, and kidney (Moon afflicted in Libra) trouble.

HEART PALPITATION

Birth-chart constants: Sun afflicted or planet in Leo afflicted, at the same time the constants for indigestion or stomach trouble are present.

Progressed constants: An aspect involving the Sun or planet in Leo at the same time progressed constants for digestive disturbances are present.

Stellar Treatment: The usual cause of heart palpitation is in the digestive tract. Gas distends the stomach and it presses against the heart impeding its action. This may

give rise to pain or to palpitation. Many people are led to believe they have heart trouble by such pains or palpitation. And, in fact, after eating heavily of food which does not digest, people do die because their heart is stopped by the pressure of the stomach. But the primary difficulty to be treated is not the heart, but the digestive disturbance. This requires proper diet and proper thinking, as well as applying the planetary antidotes to the regions occupied by the planet mapping the cause of indigestion. (See indigestion.)

Example: Chart 7269. Female, September 17, 1915, 10:00 a.m. CET. 7:40E. 45N. Neptune in Leo square Asc. and opposition Uranus. Mars conjunction Saturn in Cancer, Sun and Venus in Virgo opposition Jupiter. In December, 1940, as progressed, with Mars conjunction Neptune p in Leo and semi-sextile Pluto r in Cancer, had heart palpitation.

HEART TROUBLE

Birth-chart constants: An affliction in Leo, or the Sun severely afflicted.

Progressed constants: A progressed aspect involving the Sun, or involving the planet in Leo, at the same time there are severe rallying forces.

Stellar Treatment: Heart trouble may result from rheumatic fever or other infection. But it also may be due to depletion of front pituitary secretion or thyroxin, or over-secretion of thyroxin which causes energy to be used too fast, weakening the heart due to excessive strain. Hard work itself does not commonly place too great a demand on the supply of thyroxin and front pituitary secretion. These glands do, however, and especially the thyroid, respond with great sensitiveness to emotional conditions. The feeling of hurry, of strain, or the forcing oneself to continue after one feels exhausted, all tend unduly to deplete these hormones. It is not so much the work accomplished, as it is the feeling of hurry, strain and high pressure which, through glandular depletion or over stimulation, causes so many Americans to suffer from heart trouble. Worry, in particular, reacts immediately upon the glands which are responsible for normal heart action.

Lying down for rest at given intervals, deliberateness in all actions, and especially a philosophical and religious attitude (Jupiter) which banishes all stress and tendency to excitement often permits those with severe heart trouble to live long lives. The diet should contain iodine, manganese, vitamin A and vitamin B complex. The heart itself should be given either lunar electromagnetic energy to sooth, or solar electromagnetic energy to stimulate, as the case calls for. The affliction in Leo should be given the energy of its planetary antidote, and the zone occupied by the Sun should be given harmonious Jupiter planetary energy.

Example: Chart 7268. Female, February 13, 1880, 6:03 a.m. 81W. 41N. Sun square Mars and M.C. March 20, 1947, as progressed, with Asc. square Sun r, Venus semi-square Sun r, and Mercury square Mars p, had heart attack.

HEMORRHOID

Birth-chart constants: Both Venus and Mars somewhat afflicted.

Progressed constants: An aspect involving Venus and an aspect involving Mars.

Stellar Treatment: Hemorrhoids or piles are dilated or varicose veins at the anus or in the lower inch or two of the rectum. They may be caused by chronic constipation, sedentary habits, congestion of the liver, and commonly in women due to the pressure of a pregnant womb preceding childbirth. The bowels should be kept free not through severe purgatives but through fruit in the diet. Being too much on the feet increases the difficulty. Care should be taken against getting the feet wet and cold, and cold seats should be avoided. The diet should be that advocated for an afflicted Mars and an afflicted Venus. Saturn planetary energy should be given the zone occupied by Venus, and Moon planetary energy should be given the zone occupied by Mars.

Example: Chart 7270. Female, January 22, 1888, 8:38 a.m. 73W. 43:30N. Venus semi-square Sun and Mercury, Mars conjunction Uranus. November 24, 1947, as progressed, with Venus square Pluto p, and Mercury sesqui-square Mars r, was operated on to remove hemorrhoids.

HERNIA

Birth-chart constants: Heavy afflictions from Mars, and usually an afflicted planet in Virgo, Libra or Scorpio.

Progressed constants: An aspect, usually an affliction, involving Mars.

Stellar Treatment: The stellar structure mapped by Mars should be given Moon planetary energy, and any afflicted planet in Virgo, Libra or Scorpio should be given the planetary energies of its antidote. Electromagnetic energies, both solar and lunar, applied at an early date to the ruptured tissues, while the thoughts command them to heal, is very effective. Such tissues should be held properly in contact by mechanical means to enable the healing process to take place.

Example: Chart 305. Male, February 24, 1902, 4:25 a.m. 80W. 37:15N. Moon in Virgo square Uranus and Neptune. Mars conjunction Sun and square Pluto. In August, 1920, as progressed, with Mars opposition Moon r in Virgo, was ruptured.

HIGH BLOOD PRESSURE

Birth-chart constants: A prominent Sun and a heavily afflicted Saturn, or a prominent Sun and a heavily afflicted Mars.

Progressed constants: An aspect involving the Sun, or an aspect involving Mars.

Stellar Treatment: The thyroid gland responds immediately to either Sun thinking or Venus thinking. Under discordant Sun or Venus thinking, thyroxin is poured into the blood stream, and this stimulates the heart and contracts the blood vessels. The hormone of the gonad glands, responding to Venus or Mars, does likewise through its action upon adrenalin. Cortin, which responds to Mars thoughts, and adrenalin which is secreted by Mars thoughts of anger, irritation or haste, and by Saturn thoughts of worry, anxiety or fear, contract the arterial blood vessels, stimulate the circulation and raise the blood pressure even more violently than does thyroxin. The feeling of strain, hurry, or the forcing oneself to continue after one feels exhausted, also releases adrenalin. An acid blood stream causes the blood vessels to contract, and thus raises the blood pressure.

The diet should be such as to keep the blood stream slightly alkaline. Vegetable juices and fruit juices are beneficial for this purpose. Thoughts should be cultivated that will reduce the mental discord and pressure. Harmonious Jupiter thoughts are recommended. The zone mapped by the Sun should be given both lunar electromagnetic energy and Moon planetary energy. The zone mapped by the afflicted Mars or the afflicted Saturn should receive the planetary energy of its antidote.

Example: Chart 286. Male, November 19, 1868, 6:30 a.m. 74:15W. 40:45N. Sun conjunction Asc. and square Mars. December 23, 1926, as progressed, with Sun conjunction Moon r, Mars conjunction M.C. r and inconjunct Jupiter r, and Neptune square Uranus p (stroke), died of stroke due to high blood pressure.

HIVES

Birth-chart constants: Venus and upper octave planets somewhat prominent and afflicted.

Progressed constants: An aspect involving Venus at the same time there is an aspect involving an upper-octave planet.

Stellar Treatment: The prominent or afflicted upper-octave planet depletes the parathyrin supply, making for hypersensitivity. Because of the Venus influence the hypersensitivity manifests through the skin. Frictions or conflicts of any kind within the mind, or over mental activity, tend to disturb the proper action of the parathyroids. Proper thinking is essential, as well as proper diet. The diet should be that advocated for the responsible upper-octave planet, and should include calcium, vitamin B-1 and vitamin D. The energy of the planetary antidote should be applied to the zone mapped by the upper octave planet, and Saturn planetary energy should be applied to the zone mapped by Venus.

Example: Chart 7271. Female, February 13, 1915, 11:00 p.m. 94:38W. 39:07N. Venus semi-square Sun and Moon, sextile Mercury. Uranus conjunction Mars in an angle, Sun and Moon trine Pluto. March 4, 1943, as progressed, with Venus semi-sextile Venus r, Mercury r and Jupiter p, with Neptune inconjunct Sun r and Moon r, and with Uranus sesqui-square Pluto r, developed hives.

IMPETIGO

Birth-chart constants: Upper-octave planet prominent and Mars and Venus afflicted.

Progressed constants: An aspect involving Mars and an aspect involving Venus at the same time there are severe rallying forces.

Stellar Treatment: This is a skin disease due to infection with the impetigo germ. To prevent the infection from spreading, the blisters or lesions should not be fingered, and should be washed with an antiseptic lotion. When the scalp is affected, the hair should be cut short, and white precipitate ointment applied. Lunar electromagnetic energy may be applied to the region affected to soothe the itching. Moon planetary energy should be applied to the zone mapped by Mars, Saturn planetary energy should be applied to the zone mapped by Venus, and its planetary antidote should be applied to the zone mapped by the significant upper-octave planet.

Example: Chart 7272. Male, June 30, 1934, 1:01 a.m. 122:30W. 37:45N. Uranus conjunction Asc., Mars square Neptune, Pluto conjunction Mercury, Venus square Saturn. In June, 1938, as progressed, with Mars trine Moon r, Venus semi-square Mercury p and M.C. p, and M.C. opposition Mercury p, had impetigo.

INDIGESTION

Birth-chart constants: Afflicted planet either in Cancer or Virgo, or the Moon or Mercury afflicted.

Progressed constants: Discordant aspect involving the planet in Cancer or Virgo, or a discordant aspect involving the Moon or Mercury.

Stellar Treatment: The common causes of indigestion are errors in thinking and errors in diet. Anger, worry and mental or physical overexertion releases adrenalin, which withdraws the blood from the digestive tract. The individual must learn to think and feel harmony, vigor and peace. Some stomachs are slow, and others handle certain food combinations poorly, or not at all. Fats are hard for some to digest. Those inclined to indigestion should not eat when very tired, immediately after undue exposure to cold, when the emotions are aroused, or when the mind is very active. The zone of the planet in Cancer or Virgo, or the zone occupied by Moon or Mercury, whichever is chiefly responsible, should be given its planetary antidote, and the digestive region should be treated with solar electromagnetic energy and Sun planetary energy to give it vital power.

Example: Chart 278. Male, December 28, 1902, 4:00 a.m. 5W. 5N. Neptune in Cancer opposition Sun, Moon opposition Pluto. In June, 1918, as progressed, with Mercury semi-square Uranus p, Venus semi-square Moon r, and Venus inconjunct Neptune r in Cancer, developed lasting indigestion.

INFANTILE PARALYSIS

Birth-chart constants: Mars, Uranus, Saturn and Sun prominent.

Progressed constants: An aspect involving Mars, an aspect involving Sun, an aspect involving Uranus, and usually an aspect involving Saturn.

Stellar Treatment: The analysis of the charts and progressed aspects of 100 people who have had infantile paralysis is given, with details of precautionary actions, in the reference book, *BODY DISEASE AND ITS STELLAR TREATMENT*.¹ When infantile paralysis is suspected, the individual should be put to bed at once and a doctor called. Complete rest is essential, and the doctor can determine if it is infantile paralysis, and if it is he can take steps to prevent the spread of the disease. Depending on the area affected he may be able to advise certain mechanical measures that will be helpful. When the acute stage is past, that which is needed is the reeducation of the nerves and muscles. As precautionary measures the diet and thoughts indicated for an afflicted Mars, Sun, Uranus and Saturn should be employed.

Example: Chart 287. Male, January 30, 1882 8:00 p.m. 74W. 41:45N. Mars and Moon in angles, Saturn square Sun. In July, 1921, as progressed, with Pluto semi-sextile Mars r, Sun semi-square Saturn r and Venus r, and Uranus trine Jupiter r, had infantile paralysis.

INFECTION

Birth-chart constants: A prominent and usually afflicted Mars.

Progressed constants: An aspect, especially an affliction, involving Mars.

Stellar Treatment: Infection may be from a wide variety of viruses, bacteria or protozoa. The more specific treatment depends upon the other constants and the precise type of infection. But as cortin and adrenalin are the chief chemicals with which the body fights invasion and neutralizes the toxins of invading organisms, the thoughts and diet should be such as to strengthen the power of the adrenal glands.

The diet should be low in protein, but there should be plenty of variety of the proteins, and there should be plenty of vitamin A, vitamin B-1, vitamin C and iron. Moon planetary energy should be applied to the zone occupied by Mars, and lunar electromagnetic energy to the infected region.

¹ Out of Print. See *Astrology: 30 Years Research*.

Example: Chart 7273. Male, February 9, 1873, 4:00 a.m. 88:30W. 43N. Mars in an angle inconjunct Mercury and Uranus. January 7, 1934, as progressed, with Mars in Scorpio (nose) inconjunct Mercury r, Mercury p inconjunct Mars p, and Saturn opposition Uranus p, contracted a dangerous infection of the nasal passage.

INFLUENZA

Birth-chart constants: Mars, Mercury and Neptune prominent.

Progressed constants: An aspect involving Mars, an aspect involving Mercury, and an aspect involving Neptune.

Stellar Treatment: The progressed aspect involving Neptune depresses the output of cortin and adrenalin, the aspect involving Mars makes contact with the virus more likely, and the aspect involving Mercury indicates the intestinal or respiratory tract is subject to the disease. Rest is imperative to permit the body chemicals to neutralize the toxins. Fruit juices and vegetable juices should be the only food until recovery is well on its way. In Spanish Influenza any coarse food often perforates the walls of the intestines. This caused the deaths of many in the epidemic of 1918. The juices build up an alkaline resistance in the blood stream and thus help neutralize the toxins. Exertion increases the toxins in the blood stream. The zone occupied by Mercury should be given Jupiter planetary energy, and the zone occupied by Neptune should be given Sun planetary energy. The thinking should be positive, and of the Sun type.

Example: Chart 7238. Male, January 23, 1897, 6:00 a.m. 74W. 40:43N. Mars trine Sun, Mercury in an angle and sesqui-square Neptune. On February 1, 1919, as progressed, with Mars sesqui-square Mercury r, Neptune sesqui-square Mercury r, and Mercury sextile Uranus p and Saturn r, contracted influenza.

INSANITY

Birth-chart constants: Severely afflicted Mercury or Moon, usually both.

Progressed constants: Heavy afflictions, and nearly always a progressed aspect involving Mercury or the Moon, usually an affliction.

Stellar Treatment: Insanity takes many different forms, and the factors other than Mercury or Moon affliction vary with the form. In some forms the structure of the brain is affected, in some there is a toxic condition affecting the brain, but in most kinds there is only a dislocation of, or conflict between, mental factors. The effort should be made to conciliate the conflicts, and to harmonize both the thought-cells mapped by the Moon and those mapped by Mercury. Planetary energies which are their antidotes should be applied to the zones mapped by the planets involved in discordant progressed aspects.

The solar plexus thought treatment is especially important in most forms.

Example: Chart 2141. Male, October 14, 1912, 4:00 a.m. 90W. 38:30N. Mercury conjunction Mars and square Uranus and Neptune. Moon semi-square Sun, Mars and Mercury, and opposition Saturn. In September, 1933, as progressed, with Mercury sesqui-square M.C. p and inconjunct Pluto p, and with Sun conjunction Mars p, became insane.

ITCHING

Birth-chart constants: Venus prominent and afflicted, and an affliction involving an upper-octave planet.

Progressed constants: An aspect, usually an affliction, involving Venus, at the same time there is an aspect to an upper-octave planet.

Stellar Treatment: Parathyrin deficiency, due to the action of the upper-octave planet, induces hypersensitivity of the nerves. Under the Venus influence this is most marked in the skin. The skin may not be able to contact wool without itching, certain foods, especially those rich in fat or sugar may induce itching, certain weather conditions may induce itching, or the itching may occur apart from discoverable external cause. The individual should try to discover and avoid the external condition that causes the itching, and he should adopt a diet and thinking which will strengthen the parathyroid glands. Calcium, vitamin B-1 and vitamin D in particular are needed. Saturn planetary energy should be applied to the zone occupied by Venus, and the planetary energy of its antidote should be applied to the zone occupied by the responsible upper-octave planet.

Example: Chart 7239. Male, November 2, 1927, 7:30 p.m. 0:10W. 5:37N. Venus opposition Jupiter, Neptune square Mercury. In July, 1928, as progressed, with Venus opposition Jupiter r, Sun semi-square Venus p, and M.C. sesqui-square Pluto p, commenced itching which continued for years.

JAUNDICE

Birth-chart constants: Mars afflicted, and Jupiter or Saturn prominent and usually afflicted.

Progressed constants: An aspect involving Mars at the same time there is an aspect, usually an affliction, involving Jupiter or Saturn.

Stellar Treatment: Bile is formed by the liver cells. If its passage through the ducts into the duodenum is blocked it is absorbed into the blood and gives rise to jaundice. It may be blocked by a parasitic worm (Mars), by a catarrhal (Jupiter) condition of the lining of the duct, or by a growth or gall stones (Saturn). If Jupiter is involved in the progressed aspects, rich foods should be avoided and the zone occupied by Jupiter should be given Mercury planetary energy. If Saturn is involved the olive oil and other treatment indicated for gall stones may be needed. But in all cases pains should be taken that the diet causes the blood stream to be slightly alkaline. Moon planetary energy should be given the zone occupied by Mars.

Example: Chart 289. Female, April 16, 1908, 1:00 a.m. 93:15W. 44:30N. Mars sesqui-square Moon, Jupiter in an angle, Saturn conjunction Mercury. In January, 1931, as progressed, with Mars trine Moon r, Venus square Saturn r, Sun semi-square Saturn r, and Mars semi-square Jupiter p, became jaundiced.

KIDNEY TROUBLE

Birth-chart constants: A planet severely afflicted in Libra or Scorpio, or Venus or Mars severely afflicted.

Progressed constants: An aspect, usually an affliction, involving the planet in Libra or Scorpio, or involving Venus or Mars.

Stellar Treatment: The upper part of the kidneys is ruled by Venus, the lower part by Mars. While the skin allows some of them to be eliminated, the kidneys are chiefly responsible for filtering toxins and acids from the blood stream. Too much protein places a strain both on the kidneys and the cortin supply. Alcohol is very hard on the kidneys. The nuclei of red meat, when broken down, produces uric acid in quantity. Weak kidneys deteriorate when called upon to filter too much such material. Thus the blood stream should be kept slightly alkaline, foods hard on the kidneys should be avoided, and the zone of the afflicted Mars or Venus or the afflicted planet in Libra or Scorpio should be given the planetary energy of its antidote.

Example: Chart 2031. Male, November 11, 1909, 10:45 a.m. 74W. 40:43N. Jupiter in Libra square Venus, Sun semi-square Venus, Mars square Pluto. February 13, 1915, as progressed, with Mercury in Scorpio sesqui-square Mars p, Venus conjunction Asc. r, and Sun semi-square Asc. r, died of congested kidneys.

KIDNEY STONE

Birth-chart constants: A planet afflicted in Libra or Scorpio, or Venus or Mars severely afflicted, at the same time Saturn is prominent and aspects the planet in Libra or Scorpio or Venus or Mars.

Progressed constants: An aspect, usually an affliction, involving the planet in Libra or Scorpio or Venus or Mars at the same time there is an aspect involving Saturn.

Stellar Treatment: In addition to the treatment indicated for kidney trouble, the diet should be that favorable to a discordant Saturn, and Venus planetary energy should be given the zone occupied by Saturn. The Saturn influence causes urinary calculi—small concretions and brick-dust sediment—to be formed and passed in the urine, accompanied by sharp pain in the kidneys, especially after severe jolting. Special effort should be made through harmonious Venus thoughts and a diet rich in vitamins and minerals to restore balance to the blood stream to prevent further deposits.

Example: Chart 290. Male, October 11, 1904, 1:00 p.m. 95:10W. 38:30N. Sun in Libra opposition Jupiter and trine Saturn in an angle. Saturn square Moon and Venus. In June, 1920, as progressed, with Mercury semi-square Mars p, Venus semi-square Sun r, and Mars inconjunct Saturn r, suffered from kidney stone.

LARYNGITIS

Birth-chart constants: A planet afflicted in Taurus, or Venus afflicted.

Progressed constants: An aspect involving the planet in Taurus or involving Venus at the same time there is an aspect involving Mars and a discordant aspect.

Stellar Treatment: Laryngitis is made possible by a blood stream unable to oust invading organisms, or through inhaling or swallowing irritating substances. The resulting inflammation centers in the throat area due to the active and discordant Venus or Taurus thought-cells. The individual should keep warm, remain in a room of even temperature, and refrain from talking. A hot poultice over the throat often is useful. The blood stream should be kept alkaline through proper diet. Fruit and vegetable juices are good for this purpose. Ample vitamin A, vitamin E, iodine and copper are needed. Wheat germ meal is a fine source of vitamin E. The zone occupied by the afflicted planet in Taurus should receive the planetary energy of its antidote; if Venus is afflicted, the zone it occupies should be given Saturn planetary energy. The zone occupied by Mars should be given Moon planetary energy, and lunar electromagnetic energy should be applied to the larynx.

Example: Chart 6303. Female, August 8, 1905, 10:00 a.m. 73W. 41:33N. Venus conjunction Neptune and opposition Uranus. In June, 1917, as progressed, with Venus sesqui-square Saturn r, Mars square Saturn p, and Asc. semi-sextile Mars r, had laryngitis.

LEPROSY

Birth-chart constants: Negative planets, especially Neptune and Saturn, prominent and afflicted.

Progressed constants: An aspect involving Mars and an aspect involving Neptune or Saturn at the same time there are severe rallying forces.

Stellar Treatment: Poor elimination, low electromagnetic potential, inadequate diet, and general lack of vigor predispose toward this disease. The progressed aspect involving Mars attracts the invading bacillus leprae, and at the same time lowers the output of cortin and adrenalin with which chemically to destroy the invading hordes. The influence of Neptune also depresses the manufacture of these chemicals. Both the diet and the thoughts should be such as to build up the vitality and increase the positiveness. The diet should have wide variety in minerals, vitamins and proteins, but not too great quantity of protein. Calcium and vitamin B-1 are especially needed. To overcome the negativeness the attitude should be cultivated that any situation which may arise will be completely handled, that there is power present to overcome through constructive effort any difficulty which may arise, and that one is a significant factor in the universal scheme. Sun planetary energy should be applied to the zones occupied by Saturn and Neptune, and Moon planetary-energy to the zone occupied by Mars.

Example: Chart 291. Female, April 29, 1899, 9:30 a.m. 158W. 21:15N. Moon opposition Neptune and Asc. and conjunction Saturn. Sun sesqui-square Saturn. Venus in an angle square Moon. In November, 1920, as progressed, with Mercury square Mars r, Neptune opposition Saturn r, and Mars sesqui-square Moon r, developed leprosy.

LEUKEMIA

Birth-chart constants: Mars afflicted and Saturn and Neptune prominent, usually afflicted.

Progressed constants: An aspect involving Mars, an aspect involving Saturn, and an aspect involving Neptune at the same time there are severe rallying forces.

Stellar Treatment: Foods should be selected which supply a wide variety of proteins, vitamins and minerals. As the end sought is the manufacture of enough normal red blood cells and a decrease in the manufacture of white cells, vitamin A, vitamin B-1, vitamin C and iron are important in the diet. In this disease there is an outstanding disturbance of ability to handle vitamin B-1. Especially should all negative moods be avoided, and a high electrical potential should be cultivated by positive optimistic thinking. Harmonious thoughts of the Sun type are especially needed. Sun planetary energy should be applied to the zones occupied by Saturn and Neptune, and Moon planetary energy should be applied to the zone occupied by Mars.

Example: Chart 6212. Female, January 28, 1920, 10:30 a.m. CST. 84W. 39:45N. Mars square Mercury, Saturn semi-square Mars, Neptune opposition Sun. June 3, 1940, as progressed, with Sun trine Mars r, Mars trine Pluto p, Mercury opposition Saturn p, and M.C. conjunction Neptune r, died of leukemia.

LIVER TROUBLE

Birth-chart constants: Jupiter prominent and afflicted.

Progressed constants: An aspect, usually an affliction, involving Jupiter.

Stellar Treatment: The liver, ruled by Jupiter, is the great chemical factory and storehouse of the body. The products formed by digestion of foods are carried to it by the portal vein. The liver converts these products of digestion into other substances, breaking some down and building others up, as required. Glucose derived from sugar and starch is converted into glycogen for storage. When needed, the stored glycogen is reconverted into glucose for distribution as fuel. Protein foods are broken down into simple substances for use of the body, the end product, urea, being discharged from the liver to be excreted by the kidneys. Bile, formed in the liver, is not merely a digestive juice, but also conveys from the body waste products of the liver's activity. And the liver itself converts toxic matter absorbed from the bowels into harmless substances that are then excreted by the kidneys.

As the digested food must be handled by the liver, most liver trouble is due to overtaxing its storage or destructive power. Too rich a diet, or too toxic a blood stream, may cause it to become diseased. The diet should contain sulphur, and should contain a minimum of sugar and fat. Cane sugar should be avoided. Most people handle fructose, the sugar of fruits and honey, much better. Mercury planetary energy should be applied to the zone occupied by Jupiter.

Example: Chart 7060. Male, January 6, 1899, 2:00 a.m. EST. 86:27W. 43:58N. Jupiter square Mars, conjunction Moon, semi-square Saturn and Mercury. In September, 1919, as progressed, with Sun square Jupiter r, Venus semi-square Jupiter r, and Jupiter semi-square Mercury r, suffered liver attack.

LOW BLOOD PRESSURE

Birth-chart constants: Saturn prominent and Sun afflicted.

Progressed constants: An aspect, usually an affliction, involving Saturn, and an aspect involving the Sun.

Stellar Treatment: Under the influence of fear, worry, anxiety, or overwork adrenalin is released, and this contracts the blood vessels and stimulates the heart action, and thus causes the blood pressure to rise. But if the system has become too depleted from lack of adequate diet, from negative thinking, or other cause, the adrenals become exhausted and can no longer manufacture adrenalin. The thyroid and front pituitary glands may also lose their power. The low output of adrenalin, thyroxin and front pituitary hormone tends to relax and widen the individual's capillaries, the heart action becomes poor, and he develops low blood pressure. The

thinking should be positive and harmonious, and the diet should be that favorable to an afflicted Saturn. The vitality should be built up. Jupiter planetary energy should be given to the zone occupied by the Sun, and Venus planetary energy should be applied to the zone occupied by Saturn. General treatment with solar electromagnetic energy is beneficial.

Example: Chart 6278. Female, February 12, 1876, 9:48 p.m. 84:31W. 39:06N. Saturn conjunction Sun and Mercury, Sun opposition Uranus. In September, 1940, as progressed, with Sun parallel Saturn p, Mars square Saturn p, and Asc. square Saturn p, suffered from low blood pressure.

LUMBAGO

Birth-chart constants: A planet afflicted in Libra or Venus severely afflicted at the same time there are afflictions from Mars and Saturn.

Progressed constants: An aspect involving the planet in Libra or Venus and an aspect involving Mars or Saturn, usually both.

Stellar Treatment: Lumbago is either cold or rheumatism which because of the discord in Libra or of Venus settles in the back in the region of the kidneys. Exposure should be avoided, and the blood stream kept slightly alkaline. The diet should be that recommended for a discordant Saturn, excess of meat and acid producing foods being avoided. The afflicted planet in Libra should be given the planetary energy of its antidote, or the zone occupied by the afflicted Venus should be given Sun planetary energy. The zones occupied by Mars and Saturn should be given the planetary energy of their antidotes. Solar etheric energy should be applied to the region where the stiffness and pain are located.

Example: Chart 292. Male, July 14, 1880, 4:30 p.m. 89:15W. 44:30N. Moon in Libra opposition Jupiter and Saturn and sextile Mercury and the Sun. Mars square Pluto. In May, 1912, as progressed, with Jupiter opposition Moon r in Libra, Asc. trine Venus p, Saturn semi-sextile Pluto p, and M.C. semi-square Mars p, suffered from lumbago.

MALARIA

Birth-chart constants: Mars prominent and Neptune, Saturn or Pluto prominent and afflicted.

Progressed constants: An aspect involving Mars and an aspect involving Neptune, Saturn or Pluto, especially Neptune.

Stellar Treatment: Malaria occurs in three chief types, and is due to the presence in the red blood corpuscles of animal parasites of the genus Plasmodium. In their adult form they live in the tissues of the Anopheles mosquito. The young parasites destroy the human blood cells, liberating in the blood plasma an immense number of spores, which release coincides with the chills and fever. The fever results from the cortin

and adrenalin destroying the spores and neutralizing the other poisons liberated. The diet should be that favorable to the discordant negative planet, and in addition should contain plenty of iron, copper, manganese and a variety of proteins that can be used in building new red blood cells to replace those destroyed. The adrenal glands should be favored as much as possible by avoiding strain or excitement, so that they may supply additional adrenalin and cortin. The zone of the responsible negative planet should receive the planetary energy of its antidote, and the zone occupied by Mars should receive Moon planetary energy. Lunar electromagnetic energy and sponging with tepid water should be used to reduce the fever.

Example: Chart 6330. Male, February 7, 1873, 4:00 a.m. 84:45W. 38:50N. Mars in an angle square Mercury and Uranus. Saturn in an angle opposition Uranus, Pluto square Sun, and Neptune in an angle square Saturn. In March, 1893, as progressed, with Mars semi-square Asc. r, and Sun semi-square Neptune r, had malaria.

MASTOID TROUBLE

Birth-chart constants: Saturn and Moon afflicted and in aspect with each other, usually a discordant aspect.

Progressed constants: A discordant aspect involving Saturn or the Moon.

Stellar Treatment: Saturn- Moon afflictions not only tend to affect the ears, but also frequently cause difficulty in the adjoining mastoid region. Mastoid operations are often resorted to, in the endeavor to relieve the condition, and when such an operation is performed there is sure to be a progressed aspect involving Mars. This not merely indicates the operation, but that the cortin and adrenalin supply are insufficient to counteract the acidity of the blood and overcome the inflammation or infection. The diet should be that indicated for an afflicted Saturn. Mars planetary energy should be given the zone occupied by the afflicted Moon, and Venus planetary energy and Sun planetary energy should be given the zone occupied by Saturn. If there is severe inflammation it may be soothed by applying to the mastoid region lunar electromagnetic energy.

Example: Chart 293. Male, May 10, 1924, 8:10 a.m. 122:15W. 38N. Moon square Saturn. In December, 1930, as progressed, with Sun inconjunct Saturn p, Jupiter sesqui-square Moon r, and Mercury square Mars p, had a mastoid operation.

MEASLES

Birth-chart constants: Mars prominent and Saturn, Neptune or Pluto prominent.

Progressed constants: An aspect involving Mars and an aspect, usually an affliction, involving Saturn, Neptune or Pluto.

Stellar Treatment: The diet should be such as to build up an alkaline reserve in the blood stream, and such as indicated by the negative planet chiefly involved. Sun electromagnetic energy should be applied to the zone occupied by the responsible negative planet. Cooling drinks are beneficial; but too stimulating a diet is harmful. Irritation of the skin should be prevented and there should be protection from drafts and anything that may cause chilling. As this is a highly infectious fever the patient should be isolated. Lunar electromagnetic energy may be used to help reduce the fever. Good nursing is quite effective in this disease.

Example: Chart 294. Female, June 23, 1876, 12:30 a.m. 93:10W. 44N. Neptune and Pluto in the first, Saturn trine Sun, Mars in the fourth conjunction Moon and square Asc. In May, 1914, as progressed, with Asc. sextile Mars p, Sun inconjunct Saturn r, and Saturn sesqui-square Moon r, had measles.

MENOPAUSE TROUBLE

Birth-chart constants: Venus severely afflicted.

Progressed constants: An aspect, especially an affliction, involving Venus, at the same time there are severe rallying forces.

Stellar Treatment: The difficulty arising at this period is due to change in hormone secretion. The gonad hormones become less abundant, and instead of finding a more external outlet they may enter the blood stream in small amounts, giving rise to hot flashes. Hormone injections are now used to overcome menopause difficulties with great success. But to be administered in the proper amount they require the service of a very skilled doctor. The diet should contain plenty of vitamin E. The best source is wheat germ meal. Saturn planetary energy should be applied to the zone occupied by Venus, and constructive Saturn thoughts should be cultivated to establish calm and emotional stability.

Example: Chart 296. Female, May 11, 1885, 5:08 p.m. 86W. 45N. Venus conjunction Neptune and square Jupiter. During the 12 months of the menopause change, 1930-1931, as progressed, with Venus parallel Sun p, Asc. inconjunct Mars r and opposition Pluto p, Sun semi-sextile Mars p, and M.C. square Saturn r, there was excessive (Mars increases blood flow) menstruation.

MISCARRIAGE

Birth-chart constants: A malefic planet in the fifth house, or the ruler of the fifth severely afflicted. Venus or Mars affliction, especially to each other, increases the danger of this mishap.

Progressed constants: An aspect to the ruler of the fifth house.

Stellar Treatment: The diet, application of planetary energy, the thoughts, and hygienic measures should have for objective strengthening the stellar structure mapped by the fifth house. Lunar electromagnetic energies (but not solar) may be

applied to the region of the uterus to sooth and relax and strengthen. Vitamin E is essential, and lack of any of the vitamins increase the danger. Hormone injections are being used with great success to prevent miscarriage.

Example: Chart 295. Female, May 12, 1906, 9:00 a.m. 94:45W. 39N. Mars and Pluto rule the fifth. Mars is conjunction Venus and Jupiter and square Saturn. In February, 1932, as progressed, with Asc. semi-square Pluto r, and M.C. semi-square Mars r, had a miscarriage. She later had two children without mishap.

MUMPS

Birth-chart constants: Mars prominent and Saturn, Neptune or Pluto prominent.

Progressed constants: An aspect involving Mars, and an aspect involving Saturn, Neptune or Pluto, at the same time there are progressed afflictions.

Stellar Treatment: Usually the chief seat of the disease, which is contagious, is the parotid gland (the largest salivary gland), but it may transfer to the Scorpio region and there cause serious trouble. Meats and proteins in particular should be avoided for a few days, and fruit and vegetable juices made the main part of the diet. The diet should be such as to favor Mars and thus the cortin and adrenalin supply. Sun planetary energy should be applied to the zone occupied by the responsible negative planet, Moon planetary energy should be applied to the zone occupied by Mars, and lunar electromagnetic energy should be applied to the swelling, and to reduce the fever.

Example: Chart 1870. Female, February 6, 1894, 11:27 p.m. 74W. 42N. Mars sextile Sun and Mercury, Saturn trine Sun and Mercury, Pluto and Neptune square Moon. In July, 1923, as progressed, with Mars sextile Uranus r, Jupiter inconjunct Mars r, and Pluto sesqui-square Saturn p, had slight case of mumps.

Chapter 11

Serial No. 207
Original Copyright 1947
Elbert Benjamine

Copyright
August 2002
Church of Light

Nervous Breakdown — Scarlet Fever

BIRTH CHART PLANETS

	♈	♉	♊	♋	♌	♍	♎	♏	♐	♑	♒	♓	♈	♉	♊	♋	♌	♍	♎	♏	♐	♑	♒	♓	
7274	15°46	04°39	29°43	12°49	00°15	15°22	22°18	6°41	03°02	21°50	27°10	02													
2056	17°44	15°43	23°06	06°16	27°33	22°58	59	23°21	28°38	24°14	06°16	16R													
2055	18°35	26°43	24°30	20°12	20°09	27°51	28°45	18°12	25°12	18°12	32R														
7777	07°20	28°03	08°40	20°13	20°11	16°48	02°11	29°22	24°40	06°07	27R														
297	00°48	16°15	15°36	10°42	01°12	20°00	56°06	27°34	08°11	04	28°41	07°36													
7262A	13°43	10°23	00°46	09°12	23°40	14°46	01°03	02	27°54	18°57	12°51	61													
6233	03°36	15°42	22°51	10°52	11°40	27°23	26°53	37°18	48	03°02	29°02	547													
1555	01°05	07°58	08°23	15°11	42	06°52	00°09	04°37	37°09	22	15°23	15°07													
6116	11°16	22°37	11°42	26°42	22°42	04°40	17°13	28°02	20°54	27°11	44														
7275	05°57	28°21	21°17	29°32	22°23	27	09°04	18°28	08°42	10°48	07°50														
517	20°21	20°33	27°50	14°15	05°18	26°11	51	06°46	19°50	13	05°11	48													
19	07°45	00°36	18°43	17°03	17°03	01°18	10°56	21°18	27°17	45	04°41	41R													
300	28°12	00°10	19°11	06°25	47	22°02	02°53	29°22	19°14	18°54	29°36														
299	25°47	17°51	15°26	26°29	28°29	09°11	17°43	04°35	26°11	59	16°11	34													
7276	10°16	16°30	22°39	24°38	13°50	27°20	24°11	14°29	27°17	22°58	17°11	51R													
301	24°20	26°42	16°08	05°28	20°06	17°17	16°28	28°44	5°04	46	52°33	35R													
7277	21°11	29	26°58	06°57	10°40	04°15	17°10	26°14	7°19	12°00	549	18°10													
3197	18°49	09°03	23°50	04°53	22°17	20°54	19°32	06°11	43	28°43	08°10														
7278	28°20	20°00	25°12	09°25	16°44	27°42	12°31	14°43	02°17	05°11	49														
7279	02°58	16°59	21°11	52	17°48	04°40	17°38	15°55	15°11	03°23	10°19														
7280	18°43	02°29	15°03	25°15	19°54	25°11	58	14°46	05°59	10°52	22°11	47													
302	17°49	23°06	25°33	07°54	20°53	03°02	58	05°11	45	7°53	18°56	29°48R													
303	00°11	36	08°20	16°11	05°10	28°30	19°13	09°49	19°24	36°02	12	18°11	40												
7291	06°26	12°02	17°09	06°20	10°04	28°45	21°57	11°24	26°09	03°11	06R														
304	06°00	06°17	22°42	26°19	29°05	08°11	16°03	01°16	07°31	03°27	18°54	68R													
7281	19°40	18°03	08°36	02°58	18°28	20°16	16°06	11°14	00°11	55°02	03°06	28R													
7282	20°11	28	18°14	07°11	53°03	04°49	03°41	21°45	08°54	23°47	02°55	19°10													
7283	02°35	00°00	13°11	46	18°28	06°11	59	28°53	00°10	23°27	03°25	50													
7284	24°46	13°32	05°44	05°55	04°17	23°33	28°32	11°09	20°47	00°03	03R														

Referenced Example Birth-Chart

No. of House	Cusp	BIRTH CHART HOUSE CUSPS					
		X	XI	XII	I	II	III
7274	05♄50	♈09	♉09	♊09	♋02	♌02	♍02
2056	15♃00	♉20	♊00	♋00	♌25	♍26	♎18
2055	03♃18	♈09	♉15	♊18	♋05	♌01	♍01
777	26♃20	♈04	♉07	♊07	♋43	♌25	♍22
297	01♃29	♈27	♉20	♊29	♋29	♌20	♍29
7262A	17♃00	♉09	♊29	♋56	♌07	♍18	♎18
6233	25♈46	♈27	♉28	♊59	♋24	♌24	♍24
1555	01♃26	♈02	♉02	♊33	♋28	♌29	♍29
6116	26♃00	♉28	♊10	♋31	♌13	♍03	♎03
7275	07♃03	♈14	♉19	♊14	♋09	♌04	♍04
517	16♈07	♉19	♊16	♋50	♌06	♍10	♎10
19	00♈19	♈03	♉03	♊17	♋27	♌27	♍27
300	07♃31	♉14	♊24	♋15	♌15	♍08	♎08
299	27♃50	♊19	♋15	♌58	♍09	♎06	♏06
7276	12♃07	♈23	♉29	♊18	♋14	♌08	♍08
301	04♃22	♉25	♊16	♋34	♌03	♍09	♎09
7277	11♃22	♉16	♊28	♋28	♌25	♍16	♎16
3197	22♃27	♉22	♊14	♋18	♌18	♍03	♎03
7278	05♃26	♉09	♊27	♋55	♌25	♍12	♎12
7279	14♃18	♉13	♊24	♋35	♌02	♍20	♎20
7280	07♃21	♉01	♊21	♋38	♌25	♍06	♎06
302	05♃53	♈12	♉15	♊53	♋07	♌04	♍04
303	19♈15	♈22	♉22	♊19	♋15	♌16	♍16
7291	17♃27	♉11	♊04	♋01	♌10	♍17	♎17
304	00♈39	♈04	♉04	♊35	♋27	♌27	♍27
7281	29♃41	♉23	♊20	♋28	♌09	♍07	♎07
7282	22♃56	♈27	♉29	♊26	♋22	♌20	♍20
7283	11♈47	♈15	♉16	♊47	♋09	♌09	♍09
7284	10♈33	♈14	♉12	♊58	♋05	♌07	♍07

Referenced Example Birth-Chart Data

PROCESSED PLANETS

	♈	♉	♊	♋	♌	♍	♎	♏	♐	♑	♒	♓	MC	Asc.
7274	11♈21	19♉47	19♊16	23♋57	14♌49	13♍59	22♎00	03♏27	21♐15	27♑24	01♒25	26♓43		
2056	16♈51	26♉09	17♊40	20♋00	17♌65	10♍06	29♎56	02♏01	24♐52	07♑21	14♒07	21♓29		
2055	26♊13	23♋02	09♌14	10♍29	11♎36	09♏28	28♐33	28♑06	17♒57	11♓56	13♔32			
777	14♊34	27♋10	01♌14	10♍24	10♎06	13♏08	10♐44	29♑18	58♒23	06♓34	08♔34	25♕15		
297	07♌19	15♍15	14♎03	16♏03	19♐19	02♑45	10♒08	00♓27	08♔48	08♕00	13♖07			
7262A	12♎21	02♏08	26♐07	12♑28	15♒01	12♓50	06♔14	28♕57	18♖46	25♗52	15♘55	14♙40		
1855	15♑34	04♒00	04♓49	00♔58	18♕18	03♖23	03♗43	03♘56	15♙53	15♚27	15♛56	14♜40		
5116	03♞24	27♟11	25♠30	17♞02	07♟45	05♠33	19♞02	27♟02	15♞46	28♠14	18♡08	11♢23		
7276	17♠21	25♡35	15♢01	24♣28	10♤44	08♥56	18♦06	09♧06	11♨02	07♩13	18♪27	26♫42		
517	20♨12	00♩35	27♪47	21♫04	22♬55	29♭57	05♣01	19♤19	04♥13	37	10♧06	15♨58	29♩58	
19	11♫20	25♬02	14♭44	27♭43	06♣50	12♤29	07♥20	20♦18	32	19♧47	03♨57	03♩54	23♪00	
300	15♭08	22♣44	26♤01	24♥52	27♦59	13♧39	06♨24	19♩57	20♪29	00♫38	24♬27	00♭55		
299	12♧54	01♨27	16♩48	18♪15	10♫22	12♭36	18♬43	06♭14	27♭01	16♩11	31♫14	29♭47		
7276	03♭01	19♭54	26♣40	19♭50	00♣02	01♭14	23♩53	00♣40	22♢27	18♣57	57♤01	52	11♥33	
301	11♢04	15♣20	25♤13	27♥38	18♦41	27♧37	21♨34	26♩50	05♪21	23♫37	21♬06	08♭37		
7277	27♩13	09♪26	03♫48	17♬36	08♭29	16♧58	26♨27	18♩57	57♪01	52	18♫20	17♬06	10♭44	
3197	02♭35	04♣33	24♤48	22♥48	22♦22	56♧05	0355	26♨02	10♩55	29♫16	09♬20	06♭33	23♭28	
7278	13♧28	23♨14	08♩27	06♫38	17♬34	03♭57	17♩40	17♫22	02♬03	05♭05	40♥20	00♧34	10♨44	
7279	17♫40	29♬21	07♭56	10♩04	02♣21	21♫55	18♬08	18♩24	03♪52	11♫06	29♫00	18♬54		
7280	25♥24	26♦50	21♧43	03♨37	24♩27	27♪29	14♫38	05♬43	43♩05	43	22♫56	14♭02	19♬35	
302	09♭22	00♣28	27♤49	04♥17	21♦30	02♧18	03♨04	16♩28	8709	18♪30	29♫28	27♬26	02♭01	
303	18♩14	20♪11	08♫40	10♬18	02♭55	21♫31	08♥58	23♬57	53♭02	50	19♩07	06♬53	02♭31	
7291	22♬39	00♩32	03♪23	25♫00	22♬10	29♭33	21♩59	25♪59	25♫45	02♬37	03♫40	20♥06		
304	06♭48	15♬16	23♭50	27♬19	29♫41	08♩11	11♫03	07♫22	07♬31	07♭26	18♩18	2546	01♩18	
7281	21♭53	17♣21	10♥04	05♥41	20♬01	20♫06	10♩08	00♩52	02♬03	06♫64	26♩17	03♪18		
7282	29♥19	12♦30	25♧35	14♨03	21♩58	23♫10	06♫06	30♩22	15♪04	2526	20♩01	01♩55	01♩41	
7283	22♩08	09♩21	25♫08	13♬33	21♫13	03♩04	02♬35	22♥53	04♫09	04♩20	01♩10	01♩08		
7284	04♬11	26♭32	19♭46	17♭36	11♩15	25♪15	26♫23	10♩10	48♩20	07♫57	29♫57	19♬58	13♭41	

Referenced Example Birth-Chart Data

Chapter 11

Nervous Breakdown — Scarlet Fever

NERVOUS BREAKDOWN

Birth-chart constants: Mercury afflicted and an upper octave planet prominent and afflicted.

Progressed constants: An aspect involving Mercury and an aspect involving an upper-octave planet at the same time there are severe rallying forces.

Stellar Treatment: The neurosis leading to a nervous breakdown may be promoted by fatigue, undernutrition or a toxic condition, in which case these conditions should be remedied. Or it may be entirely due to psychoneurosis, in which the mental condition alone is responsible. But in either case, to assist nervous stability, the diet should contain abundant vitamin B-1, vitamin D and calcium. And in either case the chief effort should be to reconcile the individual to events and environment, and to bring about a harmonious readjustment of his mental factors. Becoming familiar with Course 3, *Spiritual Alchemy*, is helpful to some. The patient should be instructed as to the thoughts he should cultivate to displace those responsible for the difficulty, and magnetic passes should be employed to replenish his electromagnetic forces. The treatment at the fifth station (lesson No. 201) is especially important. Jupiter planetary energy should be applied to the zone occupied by Mercury, and the energy of their planetary antidotes should be applied to the zones mapped by the planets involved in the heavy discordant aspect.

Example: Chart 7274. Female, April 5, 1912, 5:45 p.m. 78:50W. 40:14N. Mercury sextile Pluto and square Neptune and Uranus in angles. June 11, 1938, as progressed, with Asc. trine Pluto r, Neptune trine Venus r, Jupiter sesqui-square Mercury r, and Mars square Sun r, had nervous breakdown.

NERVOUSNESS

Birth-chart constants: Mercury or Uranus severely afflicted, especially by an upper-octave planet.

Progressed constants: An aspect involving Mercury or an upper-octave planet, especially an aspect involving Mercury and an upper-octave planet.

Stellar Treatment: Two things are needed; stabilizing the nerves and harmonizing the mental factors. Mercury and the upper-octave planets deplete the supply of parathyrin and make the nerves unduly sensitive. To strengthen the parathyroid glands the diet should contain calcium, vitamin B-1 and vitamin D. The zone occupied by the responsible upper octave planet should receive proper planetary energy antidote, and the patient should be educated relative to proper thinking. Charging the patient with both solar electromagnetic energy and lunar electromagnetic energy gives the nerves needed energy and permits them to relax. The thought treatment should have for its object the establishment of a more peaceful and harmonious state of mind and nerves. Properly applied suggestion is a great aid in all nervous troubles.

Example: Chart 2056. Female, May 8, 1858, 8:00 a.m. 120:45W. 39:30N. Mercury conjunction Uranus and both opposition Mars. During February, 1920, as progressed, with Mercury conjunction Sun p and semi-square Uranus p, and Sun semi-square Uranus p, was in a severely nervous state.

NEURALGIA

Birth-chart constants: Mercury or Uranus severely afflicted.

Progressed constants: An affliction involving Mercury or Uranus, or an aspect involving Mercury or Uranus at the same time there are severe rallying forces.

Stellar Treatment: Mental activities and especially mental strains and discords affect the parathyroid glands, diminishing their secretion and permitting chemical imbalance, chiefly due to improper assimilation of calcium. They also exhaust the nerve currents which, trying to meet the demands, become congested in certain areas to the depletion of other areas. As the areas of congestion and depletion shift, the neuralgia may also shift from one part of the body to another. The diet should contain ample calcium, vitamin B-1 and vitamin D, the vitality should be built up so that there will be more electromagnetic energy for the nerves, and strains should be lessened on the nervous system. As there is frequently over mental activity, interests which require physical activity and little thought, especially of a recreational nature, are valuable. The zone occupied by the afflicted Mercury or Uranus should be given Jupiter planetary energy. The chief thing needed is to reeducate the individual to a more poised and less discordant method of thinking.

Example: Chart 2055. Female, December 9, 1896, 9:10 p.m. 80:45W. 40N. Mercury opposition Mars and Neptune, Uranus square Moon. November 24, 1933, as progressed, with Mercury semi-square Mercury r, Sun sextile Uranus r, and Mars conjunction M.C. p and Pluto p, suffered severe attack of facial neuralgia.

NEURASTHENIA

Birth-chart constants: Mercury or Uranus severely afflicted.

Progressed constants: A progressed aspect involving Mercury or Uranus at the same time there are severe rallying forces, especially involving Saturn, Neptune or Pluto.

Stellar Treatment: The significant factor in neurasthenia is the poverty of mental and physical vigor and the incapacity for effort. Overwork or sexual excess may be contributing factors, or there may be little reserve of nervous energy. But the chief difficulty is mental. The general health should be built up, and the treatment should be that given for nervous breakdown. There is a mental factor which is in conflict with other mental factors and which discourages and opposes effort. This factor must be discovered and reconciled with the other mental factors, and the electromagnetic energy of the individual increased.

Example: Chart 777. Male, October 31, 1858, 1:00 a.m. 8E. 51:30N. Mercury opposition Pluto, Uranus square Asc. and Moon. In March, 1925, as progressed, with Sun sesqui-square Uranus p, Mercury inconjunct Uranus r, and Asc. sesqui-square Mars p, developed neurasthenia following a severe financial loss.

NEURITIS

Birth-chart constants: Uranus or Mercury afflicted by Mars.

Progressed constants: An aspect involving Mars at the same time there is an aspect, usually an affliction, involving Mercury or Uranus.

Stellar Treatment: In neuritis the Mars thought-cells exhaust the adrenalin and cortin supply and the nerves become not merely sensitive due to parathyrin depletion, but actually inflamed. Calcium, vitamin B-1 and vitamin D should be included abundantly in the diet, and Jupiter planetary energy should be applied to the zone occupied by afflicted Mercury or Uranus. Often there is a toxic condition of the blood stream, therefore the diet should be such as to alkalize it. Moon planetary energy should be applied to the zone occupied by Mars, and the region of pain should be treated with lunar electromagnetic energy. A cultivation of domestic thoughts in harmonious association with any aggressive thoughts is advantageous, and the thought treatment of the solar plexus should have for its end the quieting of overstimulation of mind and nerves through the application of soothing mental suggestion.

Example: Chart 297. Male, February 19, 1861, 4:00 a.m. 91:15W. 32:48N. Mars semi-square Mercury and Moon. On May 9, 1928, as progressed, with Mars square Mercury r and conjunction Moon r, developed neuritis.

NEURODERMATITIS

Birth-chart constants: An upper-octave planet prominent and afflicted and Mercury afflicted by an upper-octave planet.

Progressed constants: Mercury involved in an aspect with an upper-octave planet, an aspect involving Mars, and an affliction involving Venus.

Stellar Treatment: The diet should contain ample calcium, vitamin B-1 and vitamin D to give the parathyroid glands power to restore the chemical balance which is back of the hypersensitivity of the nerves. And as it is the progressed Venus affliction which causes the hypersensitivity to affect the skin, it should also contain vitamin A, vitamin E, iodine and copper. The thinking should be poised, calm and harmonious. Jupiter planetary energy should be applied to the zone occupied by Mercury, Saturn planetary energy should be applied to the zone occupied by Venus, and the planetary energy of its antidote should be applied to the zone occupied by the upper-octave planet. Moon planetary energy should be applied to the zone occupied by Mars, and lunar electromagnetic energy should be used to soothe the irritation of the skin.

Example: Chart 7262A. Male, March 5, 1911, 4:00 a.m. 87:37W. 41:50N. Mars conjunction Uranus and opposition Neptune, Mercury sesqui-square Neptune. December 25, 1939, as progressed, with Mercury sextile Pluto r, Venus opposition Jupiter p, and Mars sextile M.C. p, developed neurodermatitis.

OBESITY

Birth-chart constants: Jupiter or the Moon, often both, prominent and afflicted.

Progressed constants: An aspect involving Jupiter or to the Moon.

Stellar Treatment: When the insulin supply, which is ruled by Jupiter, is abundant, such fats as find their way into the blood stream are quickly stored. Unless thyroxin and adrenalin are as abundant in proportion, this stored fat is not called upon as fuel, but continues to be stored. The thymus gland, under direct influence of the Moon, takes an important part in nutrition. The lymph cells in particular, take part in the absorption of fats by the intestines, and these lymph cells are ruled by the Moon. Diet, of course, is important in the reduction of fat. The zone mapped by Jupiter should be given Mercury planetary energy. And in addition the zone mapped by the Sun should be stimulated with Sun planetary energy to increase the activity of the thyroid gland, as thyroxin enables the body to burn its excess fuel. When exercise is taken to consume excess fat, it should be remembered that the diet should contain some starch or sugar, as fat can only burn in the presence of sugar. Absolute elimination of starch and sugar from the diet, while engaging in strenuous exercise, causes the fat to smolder and fill the blood with fatty acids.

Example: Chart 6233. Female, January 23, 1917, 9:30 p.m. 90:04W. 29:57N. Jupiter square Mercury and Sun, Moon conjunction Mars and Uranus. She has been excessively fat since soon after birth.

OBSESSION

Birth-chart constants: Neptune, Pluto or the Moon prominent and severely afflicted.

Progressed constants: An aspect to Pluto at the same time there are severe rallying forces, especially if they involve Neptune or the Moon.

Stellar Treatment: The patient must be aided to avoid thinking about the obsessing thought or entity. The planetary energy which is the antidote of the responsible thought-cells should be given the zone mapped by their planet. Solar electromagnetic energy may be used to build up a more positive attitude. One of the best things is for the patient to engage in some work, which in no way is associated with the obsession, that so completely absorbs the time, attention and energies that there is no opportunity to think about the obsession. The thought treatment is important in that the effort should be made to break the vibratory connection between the patient and the obsession. Judicially applied suggestion may be made of assistance in this. If conversation can be established with an obsessing entity, it may be reasoned with and persuaded, or forced, to leave.

Example: Chart 1555. Female, April 20, 1868 noon. 158W. 12:18N. Moon, Mercury, Mars and Neptune conjunction, Pluto angular and semi-square Jupiter. In March, 1883, as progressed, with M.C. and Sun conjunction Pluto p, Asc. square Pluto p, and Venus semi-square Pluto p, became seriously obsessed.

OPERATION

Birth-chart constants: A prominent Mars, especially if afflicted.

Progressed constants: An aspect involving Mars, an aspect involving the ruler of the first house, an aspect involving the ruler of the sixth house, and an aspect involving the ruler of the twelfth house.

Stellar Treatment: This subject is treated in detail, in connection with the analysis of the charts of 100 people at the time they had an operation, in the reference book, BODY DISEASE AND ITS STELLAR TREATMENT.¹ At the time of operation, and immediately afterward, electromagnetic energy should be applied to the region operated on to hasten the healing process. In choosing the time for the operation, aside from the progressed aspects, which usually cannot be controlled, the Moon as shown in the ephemeris on that day should not be within two signs of the part of the

¹ Out of print. See } {\plain \f1 Astrology: 30 Years Research} {\plain \f1 .

body operated on. The best time is when the Moon is two or three signs past the region of the body operated on, so it will have to travel nine or ten signs to get back to that region.

Example: Chart 6116. Male, July 4, 1911, 3:00 a.m. 88W. 43N. Mars opposition Moon. In September, 1934, as progressed, with Mars, ruler of sixth, semi-square Asc. r, Venus trine Saturn r, ruler of twelfth, and Pluto inconjunct Uranus r (appendix), had appendix removed.

OSTEOMYELITIS

Birth-chart constants: Mars prominent and Saturn heavily afflicted.

Progressed constants: An aspect involving Mars and an aspect involving Saturn, at the same time there are severe rallying forces.

Stellar Treatment: Unless immediate surgical treatment is given the person, usually a child, may die in a day or two from blood poisoning. The surgeon bores into the bone and gives free exit to the poisonous discharges. Venus planetary energy should be given to the zone occupied by Saturn, and Moon planetary energy should be given to the zone occupied by Mars. The diet should be such as to alkalize the blood stream, and contain plenty of variety in mineral salts, vitamins and proteins. Magnetic passes may be used to increase the vitality.

Example: Chart 7275. Male, April 26, 1921, 00:15 p.m. 93-16W. 44:59N. Mars in an angle, Saturn opposition Uranus, square Moon, sesqui-square Sun. January 27, 1933, as progressed, with Sun trine Saturn p, Pluto parallel Mars p, and Venus semi-square Uranus p, was operated on for osteomyelitis. Lost one bone in leg below knee.

OVARY TROUBLE

Birth-chart constants: Venus afflicted.

Progressed constants: An affliction involving Venus, or an aspect involving Venus at the same time there are severe rallying forces.

Stellar Treatment: Vitamin E and vitamin A are absolutely essential if the ovaries are to perform their functions normally. And as there is a close association between the ovaries and the thyroid gland, the diet should contain ample iodine. Wheat germ meal is an excellent source of vitamin E. Ovary trouble is almost always associated with emotional disturbances. The individual should be instructed in thinking to correct these, and the thought treatment should assist in this. The zone occupied by Venus should be given Saturn planetary energy, and if under-vitalized should be given Sun planetary energy. According to whether they are over-stimulated or under-vitalized the region of the ovaries should be charged with lunar electromagnetic energy or with solar electromagnetic energy. The region of the thyroid gland should also be treated with electromagnetic energy.

Example: Chart 517. Female, March 10, 1895, 10:00 p.m. 90W. 42N. Venus semi-square Mercury. In May, 1925, as progressed, with Asc. sesqui-square Venus r, Mars sesqui-square Asc. r in Scorpio, and Saturn sesqui-square Sun r, her ovaries were surgically removed.

PARALYSIS

Birth-chart constants: Uranus prominent, and usually afflicted.

Progressed constants: An affliction involving Uranus, or an aspect involving Uranus at the same time there are severe rallying forces.

Stellar Treatment: The thought-cells mapped by Uranus are involved in all kinds of paralysis, such as spastic, infantile, palsy, or due to cerebral hemorrhage. Other than Uranus the constants and the treatment depend upon whether it is merely functional or whether some section of the nervous system is affected, what section is affected, and whether it is affected by a pressure, by inflammation, by syphilitic infection, by a tumor, or by an injury. There is even a type of paralysis which arises from disease of the muscles. Magnetic passes, suggestion, thought-education and thought-treatment are commonly advantageous. The zone occupied by Uranus should be given Jupiter planetary energy, and the zones occupied by the planets mapping the other responsible thought-cells should be given the planetary energy of their antidotes.

Example: Chart 19. Male, December 28, 1856, 11:30 p.m. 79W. 38N. Uranus square Mars and Venus. September 26, 1919, as progressed, with Mars semi-square Uranus r, Saturn opposition Sun r. Asc. semi-square Sun r, and Mercury sesqui-square Asc. r, became partially paralyzed.

PELLAGRA

Birth-chart constants: Afflictions from Saturn.

Progressed constants: An affliction involving Saturn, Neptune or Pluto, usually involving Saturn.

Stellar Treatments: This is a typical Saturn disease caused by diet deficiency. To overcome it, there must be thiamin (vitamin B-1) and niacin (vitamin P-P) abundantly in the diet. Both of these are contained in vitamin B complex. The food should have a high-caloric and a high-protein value, and contain variety in mineral salts, vitamins and proteins, as indicated by the Saturn affliction. The zone occupied by Saturn should receive Venus planetary energy, the discordant rallying forces should receive the planetary energy of their antidote, and solar electromagnetic energy may be applied to build up vitality. The prime necessity, however, is a proper diet.

Example: Chart 300. Female, May 19, 1883, 8:40 a.m. 83:53W. 43:37N. Saturn conjunction Sun. In June, 1932, as progressed, with Sun semi-square Saturn r and Pluto r, and Mars conjunction Sun r, suffered from pellagra.

PERITONITIS

Birth-chart constants: An afflicted planet in Virgo, or Mercury severely afflicted.

Progressed constants: An aspect, usually an affliction, involving Mars, at the same time there is an aspect involving the planet in Virgo or Mercury.

Stellar Treatment: The individual should be educated to a less irritating kind of thinking, and the diet should contain calcium, vitamin B-1 and vitamin D. Under the Mars influence the adrenalin and cortin supply are exhausted. Therefore the diet should also tend to alkalize the blood stream to avoid possible infection of the peritonium. The zone occupied by the planet in Virgo, or by the afflicted Mercury, should be given the planetary energy of its antidote. The zone occupied by Mars should be given Moon planetary energy, and the locality of the difficulty should be treated with lunar electromagnetic energy. If the inflammation is acute, or there is infection, a competent doctor should administer penicillin.

Example: Chart 299. Male, September 18, 1899, 6:00 p.m. 75W. 40:45N. Sun, Mercury and Venus in Virgo square Saturn and opposition Asc. February 26, 1917, as progressed, with Mars sesqui-square Asc. r, and semi-square Sun r in Virgo, died of peritonitis.

PHLEBITIS

Birth-chart constants: Venus prominent and afflicted.

Progressed constants: An aspect involving Venus and an aspect involving Mars at the same time there are serious rallying forces.

Stellar Treatment: The inflammation of the vein may be simple or septic. It is marked by pain and tenderness in the line of the affected vein, which becomes firm and cord-like. It is more likely to occur in veins that have been varicose for some time. The chief danger is that it may be followed by thrombosis. Treatment with lunar electromagnetic energy may be used to relieve the pain. The diet should contain vitamin A, vitamin E, iodine, copper, vitamin B-1, vitamin C, iron, be low in protein content, but have variety of proteins. The zone occupied by Venus should be given Saturn planetary energy, and the zone occupied by Mars should be given Moon planetary energy. The individual should rest, and should reeducate his thoughts to avoid emotional disturbance.

Example: Chart 7276. Female, October 3, 1884, 2:00 a.m. 2:27W. 54:59N. Venus conjunction Asc., square Neptune and semi-square Sun. September 11, 1907, as progressed, with Sun parallel Venus r, Saturn sextile Venus r, Mars sextile Uranus p, and Asc. semi-square Mercury r, developed phlebitis in one of her legs.

PLEURISY

Birth-chart constants: Mars afflicted and an affliction in Gemini or Mercury heavily afflicted.

Progressed constants: An aspect involving Mercury or the planet in Gemini, and an aspect involving Mars, at the same time there are severe rallying forces.

Stellar Treatment: This disease occurs in two forms; the acute type and the chronic type. The acute type is called dry pleurisy because there is no exudation. In the chronic form there is an accumulation of a large amount of fluid in the chest upon the affected side, which may be simply serum or contain pus. Prominent negative planets, especially the Moon, seem to favor the accumulation of such fluid. Diet, thought-treatment and the educational factor should have for end the restoration of the normal activity of the parathyroid glands and the strengthening of the adrenal glands. Sufficient parathyrin tends to remedy the hypersensitivity of the membrane which lines the chest walls and covers the lungs, and sufficient adrenalin and cortin tends to neutralize the toxins in the blood which inflame this membrane and thus give rise to pleurisy. The zone occupied by Mercury or the planet in Gemini should be given the proper planetary energy antidote. Lunar electromagnetic energy may be used to reduce the pain.

Example: Chart 301. Male, January 14, 1878 8:34 a.m. 79:45W. 42:08N. Sun and Mercury square Mars, Venus semi-square Mars. March 20, 1924, as progressed, with Mercury semi-sextile Sun r, Sun parallel Mars r, and Venus opposition Uranus p, developed pleurisy which was serious for six weeks.

PITUITARY DEFICIENCY (POSTERIOR)

Birth-chart constants: A prominent and heavily afflicted Moon.

Progressed constants: An affliction to the birthchart Moon.

Stellar Treatment: The back pituitary gland produces a secretion which causes contraction of all the arteries except those of the kidneys, and of the plain muscles of the bowels, the bladder, the womb, and other organs. It has something to do with the metabolism of the carbohydrates. Its deficiency leads to obesity. Its deficiency is treated by the medical profession with injections of pituitrin and other hormones. The diet should contain ample vitamin B-2, and the water-salt balance should be regulated. Pituitrin secretion should be strengthened by electromagnetic energy directed to the gland.

Example: Chart 7277. Female, June 13, 1902, 5:00 a.m. CST. 83:03W. 42:20N. Moon in an angle, square Sun. In June, 1908, as progressed, with Sun square Moon r, and Moon opposition Mars p, developed back pituitary deficiency following a fall.

PNEUMONIA

Birth-chart constants: Sun afflicted by Saturn, Neptune, Pluto or the Moon.

Progressed constants: An aspect involving Mars, a discordant aspect involving Saturn, Neptune, Pluto, Venus or birth-chart Moon, and a progressed aspect involving Mercury or a planet in Gemini.

Stellar Treatment: The analysis of 100 charts progressed to the time this disease developed, and detailed information relative to its stellar treatment are given in the reference book, *BODY DISEASE AND ITS STELLAR TREATMENT*.² Everything should be done to conserve and build up vital energy. The individual should be clothed in woolen garments and put to bed between blankets. There should be fresh air, but avoidance of draft, and the room kept at a temperature of 60° F. To conserve vitality he should be kept absolutely quiet and not permitted to get out of bed for any purpose. He should not be allowed to lie flat on his back, or in any position that will impede circulation through the lungs. Cold compresses on the head, and lunar electromagnetic energy, may be used to reduce the fever. An enema of water which is quite warm may be used to cleanse the bowels. Food requirements are indicated by the Sun and afflicted negative planets. The thyroid gland should be given solar electromagnetic energy, and zones occupied by the afflicted planets which are the constants of the disease should be given proper planetary antidotes.

Example: Chart 3197. May 9, 1860, 6:30 a.m. 3W. 56:40N. Sun conjunction Pluto and semi-square Neptune. On June 19, 1937, as progressed, with Venus opposition Mars p, Mercury sesqui-square Moon r, and M.C. semi-sextile Uranus r in Gemini, died of pneumonia.

POISONING

Birth-chart constants: A prominent and afflicted Neptune.

Progressed constants: An aspect involving Neptune at the same time there are severe rallying forces.

Stellar Treatment: The Neptune thought-cells are involved not only when the poison taken internally is a corrosive, an irritant or a narcotic, but also when it is due to insect bite, snake bite or contact with poison ivy. If the poison has been swallowed, and is not a corrosive, first aid should be employed at once to empty the stomach. A tablespoonful of mustard, or two tablespoonsful of common salt in a glass of warm water should be given the patient. Then the back of the throat should be tickled to

2 Out of print. See } {\plain \f1 Astrology: 30 Years Research} {\plain \f1 .

hasten the vomiting. When the vomiting begins, the patient should drink a large amount of tepid water to wash out the stomach. However, if the poison is a corrosive, such as the caustic alkalies, carbolic acid or creosote, an emetic should not be given, as the vomiting may cause perforation of the stomach. Instead, the irritation should be eased by giving milk, thin gruel, olive oil, or white of egg in water. Oil, however, should not be given in poisoning by cantharides or phosphorus, and water should be withheld in poisoning by oxalic acid or lysol. After the emergency treatment, Sun planetary energy should be applied to the zone occupied by Neptune, magnetic passes should be used to give the patient recuperative power, and the diet should be such as to give the blood stream an alkaline reaction to assist it neutralize the toxic condition.

Example: Chart 7278. Female, August 21, 1888, 12:12 a.m. 4:30E. 52:20N. Neptune in house of self-undoing (twelfth) conjunction Pluto and square Sun. December 9, 1934, as progressed, with Neptune sesqui-square Uranus p, Sun semi-square Sun r, and M.C. semi-square Pluto r, committed suicide by taking rat poison.

PROSTATE TROUBLE

Birth-chart constants: Mars or Pluto afflicted, or an afflicted planet in Scorpio.

Progressed constants: An aspect involving Mars, Pluto or the planet in Scorpio at the same time there are severe rallying forces.

Stellar Treatment: Treatment depends upon the nature of the affliction of the prostate gland. When it is inflamed, heat, such as a hip bath, may bring relief. The diet should contain vitamin A, vitamin B-1, vitamin C, iron, be low in protein but with ample variety of proteins. Stimulating and irritating foods should be avoided, and they should be such as to give an alkaline reaction to the blood stream to prevent irritation of the prostate gland. Lunar electromagnetic energy should be applied to the region of the prostate gland, the zone occupied by the afflicted Mars or Pluto should be given Moon planetary energy, and if there is a planet in Scorpio (ruling the prostate gland) the planetary energy of its antidote should be applied to this zone. In some prostate trouble massaging the gland through the rectum gives good results. Cancer of the prostate gland, when discovered early, is often successfully treated with female sex hormones.

Example: Chart 7279. Male, May 24, 1862, 5:00 a.m. 84W. 41:54N. Sun square Mars, Venus semi-square Mars. In March, 1909, as progressed, with Mars sextile Sun r, Venus semi-sextile Pluto r, and Sun square Venus r, developed inflammation of the prostate gland.

PSORIASIS

Birth-chart constants: An upper octave planet, especially Neptune, prominent and afflicted and Venus afflicted.

Progressed constants: An aspect involving an upper-octave planet and a discordant aspect involving Venus.

Stellar Treatment: There is hypersensitivity due to improper functioning of the parathyroid glands. This should be corrected by calm, poised and harmonious thinking, and by a diet containing ample calcium, vitamin B-1, and vitamin D. The hypersensitivity manifests through the skin due to the activity of discordant Venus thought-cells. Effort should be made to ascertain if there is anything in the environment to which the skin is sensitive. And the diet should contain vitamin A, iodine, copper, and vitamin E. For vitamin E wheat germ meal is recommended. The zone occupied by the upper-octave planet involved should be given the energy of its planetary antidote. The zone occupied by Venus should be given Saturn planetary energy. Suggestion and thought-treatment should also be used to overcome the skin sensitivity.

Example: Chart 7280. Female, July 11, 1906, 7:00 p.m. 74W. 40:43N. Neptune conjunction Sun and Mars, Uranus square Moon. In July, 1913, as progressed, with Mercury sesqui-square Uranus r, Venus semi-square Sun r, Mars semi-sextile Venus r, and Asc. opposition Mars r, developed psoriasis.

PYLORIC TROUBLE

Birth-chart constants: An afflicted planet in Virgo, or much less commonly a severely afflicted Mercury.

Progressed constants: An aspect involving the planet in Virgo, or Mercury, at the same time there are severe rallying forces.

Stellar Treatment: Both the thoughts and the diet should have for aim restoration of chemical balance through normal parathyroid secretion, and the correction of digestive disturbances. The diet should contain calcium, vitamin B-1, and vitamin D. Worry and tension should be avoided. If Mercury is afflicted, the zone it occupies should be given Jupiter planetary energy. Any afflicted thought-cells mapped by a planet in Virgo should receive the planetary energy of their antidote. Electromagnetic energy should be applied to the region where the stomach joins the small intestines to give this region vigor and vitality. The mental attitude of the patient is very important.

Example: Chart 302. Female, December 9, 1883, 9:00 p.m. LMT. 112:30W. 39N. Mercury square Uranus in Virgo. February 6, 1905, as progressed, with Mars conjunction Mars r, Venus opposition Jupiter r, Mercury trine Uranus r in Virgo, and M.C. trine Uranus r in Virgo, inflammation of the pylorus had advanced so far that an operation was performed changing the outlet of the stomach to the other side.

RHEUMATISM

Birth-chart constants: Mars and Saturn afflicted, especially if they afflict each other.

Progressed constants: An aspect, especially an affliction, involving either Saturn or Mars.

Stellar Treatment: Whether of the acute type or the chronic type, whether affecting the muscles or the joints, there is always a serious chemical imbalance present in which the adrenalin and cortin supply are insufficient to neutralize the acidity of the blood stream. Sometimes the difficulty is due to uric acid in the blood from the nuclei of meat. Diet deficiencies of the Saturn type are commonly a contributing cause. The diet should be that advocated for Saturn afflictions and Mars afflictions, excess of meat and acid producing foods being avoided. Exposure to wet and cold lowers the vitality, decreases the adrenalin and cortin supply, and enables the disease to develop. It should be avoided. The zone occupied by Mars should be given Moon planetary energy and the zone occupied by Saturn should be given Venus planetary energy. Solar electromagnetic energy should be used to warm and stimulate, and lunar electromagnetic energy may be used to reduce the inflammation.

Example: Chart 303. Female, May 22, 1903, 3:44 p.m. 94:30W. 35:25N. Saturn semi-square Uranus; Mars opposition Moon, square Uranus and sesqui-square Saturn. In October, 1921, as progressed, with Mars square Neptune p, and Saturn semi-square Uranus p, developed rheumatism.

RHEUMATIC FEVER

Birth-chart constants: Mars and Saturn afflicted, especially if they afflict each other.

Progressed constants: An aspect, especially an affliction, involving either Saturn or Mars.

Stellar Treatment: In addition to the factors contributing to and present in rheumatism, there is an infection which enters the body by way of the nose or throat. In about half of those who suffer from this disease, even its lighter forms, there is inflammation of the lining of the heart—in which case the Sun or a planet in Leo is both a birth-chart and a progressed constant. In addition to the treatment indicated for rheumatism, the individual should be kept in bed and not be permitted to get out of it even though the disease appears slight. He should wear a flannel nightdress that opens in such a manner as to be easily removed when he sweats freely. Fever and pain may be reduced by lunar electromagnetic energy and cold compresses or ice-pack. The medical profession uses salicylates. The joints should be covered with cotton wool. Attention should be paid to the state of the throat when the individual begins to

get well. The joints usually recover, but the after-effects on the heart are often serious.

Example: Chart 7291. Female, November 28, 1886, 11:00 a.m. CST. 97:28W. 31:03N. Saturn square Jupiter and sesqui-square Sun and Venus. Mars conjunction Moon and square Uranus. In June, 1902, as progressed, with Mars opposition Saturn r, M.C. opposition Pluto r, Mercury opposition Pluto r, and Sun inconjunct Saturn r and semi-sextile Mars p, suffered from rheumatic fever.

RHINITIS

Birth-chart constants: An upper-octave planet prominent and Jupiter and Mars afflicted.

Progressed constants: An aspect involving Mars, an aspect involving Jupiter, and an aspect involving an upper-octave planet.

Stellar Treatment: Chemical imbalance, due to lack of parathyrin, and an acid blood stream lead to the inflammation of the nasal membrane. In its common form there is acute catarrh. And in this form the Jupiter thought-cells play a part; for they encourage diet habits which cause the blood stream to be over burdened with incompletely burned fuel. The diet should be that advocated for an afflicted Jupiter, and in addition contain ample calcium, vitamin B-1 and vitamin D. The liver should be energized with solar electromagnetic energy, and the Jupiter zone should receive Mercury planetary energy. Moon planetary energy should be given the zone occupied by Mars, and the planetary energy of its antidote should be applied to the zone occupied by the upper-octave planet. Tensions should be avoided, and the thoughts made more calm and harmonious.

Example: Chart 7282. Male, June 12, 1903, 10:20 a.m. 78:59W. 39:26N. Pluto and Uranus in angles, opposition each other; Jupiter square Sun, Pluto and Uranus; Mars square Neptune. March 1, 1944, as progressed, with Mars inconjunct Jupiter r and Uranus p, Neptune square Mars r, Saturn semi-square Uranus p, and Sun semi-square Venus p, developed rhinitis.

RICKETS

Birth-chart constants: An upper octave planet prominent and Saturn afflicted.

Progressed constants: An aspect involving an upper-octave planet, and an aspect involving Saturn, at the same time there are severe rallying forces.

Stellar Treatment: Rickets develop when there is insufficient calcium or phosphorus in the diet, or when, due to lack of vitamin D, these elements cannot be properly handled. Spinach eaten at the same meal with other calcium containing foods decreases the amount of calcium assimilated from them, as do cereals unless irradiated or eaten with lettuce, liver or eggs. The acid condition of the intestinal tract produced by drinking citrus fruit juice markedly increases the ability to assimilate

calcium from foods. Calcium is obtained three times as readily from milk quickly boiled as from the slowly heated pasteurized milk, or as from dried milk. It is difficult to assimilate calcium from sweetened condensed milk, but evaporated milk and raw milk yield their calcium excellently. To handle the calcium and phosphorus, and build bone with them, there must be ample vitamin D. In addition to calcium and vitamin D, the food should contain plenty of variety of the mineral salts, vitamins and proteins. The zone occupied by Saturn should be given solar planetary energy.

Example: Chart 304. Female, December 27, 1929, 11:16 p.m. CST. 84:30W. 39N. Saturn conjunction Sun, and Uranus in an angle square Sun and Saturn. Starting in October, 1930, as progressed, with Sun square Uranus r, and Saturn trine Neptune r, suffered a year and a half from rickets.

RINGWORM

Birth-chart constants: Mars and Venus somewhat afflicted.

Progressed constants: An aspect involving Mars and an aspect involving Venus.

Stellar Treatment: Ringworm is due to the presence of parasitic fungi. The fungi are propagated by spores, and the variety of the infection depends upon the size of the spores and, when it occurs in a hairy situation, whether they are on the surface of the hair, within its substance, or both. The form that commonly occurs on children is ringworm of the body, which may come from ringworm of the head or from close contact with domestic animals suffering from ringworm. As the inner reddish patch on the skin heals it spreads at the edges. Doctors often paint the infected area with tincture of iodine for three or four days and then apply an antiseptic ointment. Clothing which contacts the diseased area must be carefully disinfected. In ringworm of the nail it is customary to remove the nail and kill the parasite by painting with tincture of iodine. Tincture of iodine is also used on ringworm of the scalp. Wherever it occurs, the parasite must be killed. Then healthy growth of skin and hair may be promoted by applying Saturn planetary energy to the zone occupied by Venus.

Example: Chart 7281. Female, January 10, 1943, 10:41 a.m. LMT. 118:15W. 34N. Mars square Moon, Venus semi-square Mars and Moon. In March, 1945, as progressed, with Venus semi-square Mars p, and Mars semi-sextile Sun r, had ringworm.

SCABIES

Birth-chart constants: Mars and Venus somewhat afflicted.

Progressed constants: An aspect involving Mars and an aspect involving Venus at the same time there are severe rallying forces.

Stellar Treatment: Commonly known as itch, this contagious disease is due to a mite which burrows beneath the skin. A hot bath should be taken, and the whole

body, except the head, should be lathered with soft soap. A stiff nail brush should be applied to the affected areas to open up the burrows. The body is then dried with a soft towel and all below the neck anointed with sulphur ointment, or if the skin is sensitive, with equal parts sulphur ointment and zinc ointment. Clean clothing should then be donned. This treatment should be repeated four nights in succession, and on the fifth a bath should be taken in ordinary soap and water, after which the body should be rubbed over with ordinary zinc ointment. Personal clothing and bed clothing should be thoroughly disinfected. After the mites have thus been killed and removed, Saturn planetary energy may be applied to the zone occupied by Venus to increase the vigor of the skin.

Example: Chart 7283. Male, June 24, 1917, 11:00 a.m. 97W. 36:45N. Mars square Moon, Venus semi-square Moon. In January, 1938, as progressed, with Sun semi-square Mars r, and Jupiter semi-square Venus r, had scabies.

SCARLET FEVER

Birth-chart constants: Mars, Venus and Mercury either prominent or somewhat afflicted.

Progressed constants: An aspect involving Mars, an aspect involving Venus, and an aspect involving Mercury at the same time there are severe rallying forces.

Stellar Treatment: This is a highly contagious disease, the infection usually entering the body through the nose or mouth. The mouth, nose and throat should be kept very clean through the use of an antiseptic mouth wash used several times daily. Ice pack and lunar electromagnetic energy may be used to reduce the fever, which may be high. As in other infectious fevers, the blood stream should be kept alkaline to assist in neutralizing the toxins. Fruit and vegetables juices are recommended. Moon planetary energy should be given the zone occupied by Mars, Saturn planetary energy should be given the zone occupied by Venus, and Jupiter planetary energy should be given the zone occupied by Mercury. Careful nursing is important.

Example: Chart 7284. Female, November 17, 1937, 5:00 a.m. 118:20W. 34:05N. Mars square Venus and opposition Pluto, Mercury sextile Mars. In March, 1947, as progressed, with Mars square Uranus r, Neptune semi-square Venus r, and Mercury semi-square Mars r, had scarlet fever.

Chapter 12

Serial No. 208
Original Copyright 1947
Elbert Benjamine

Copyright
August 2002
Church of Light

Sciatica —
Yellow Fever

BIRTH CHART PLANETS

	☉	☽	☿	♃	♄	♅	♆	♁	♂	♀	♃	♄	♅	♆	♁	♂	♀	♃	♄	♅	♆	♁	♂	♀																		
7285	11	17	14	01	90	54	16	17	36	07	30	02	01	17	32	25	40	56	00	00	10	16	24	04	27	42	03	23	45	R												
7286	19	11	51	22	05	18	24	18	24	03	34	27	04	03	34	06	34	06	34	06	34	06	34	06	34	06	34	06	34	06	R											
307	15	11	58	21	10	09	34	28	54	12	21	16	09	04	23	58	02	54	5	19	11	03									R											
308	26	5	36	28	41	10	19	26	09	07	40	17	23	36	06	11	04	07	33	2	34	44	28	11	45							R										
7287	25	1	22	00	00	19	38	06	17	23	13	10	40	12	37	02	37	02	37	02	37	02	37	02	37	02	37	02	37	02	37	R										
7288	23	1	40	23	29	06	37	04	07	14	10	18	10	18	21	24	17	02	15	13	13	1	1	1	1	1	1	1	1	1	1	R										
310	16	11	12	19	48	23	58	14	25	10	29	43	00	1	08	1	30	00	1	56	22	11	01	14	11	09							R									
313	03	3	35	20	50	14	30	18	1	44	28	13	19	1	42	16	1	32	01	1	20	04	11	07	05	11	58							R								
7289	23	9	33	16	1	45	03	14	25	11	24	11	58	00	25	04	1	45	18	1	57	13	11	42	10	11	11								R							
7290	00	8	57	01	1	52	20	1	44	29	1	43	19	1	58	14	1	02	24	1	23	17	23	09	02	1	06	02	3	34						R						
7292	04	9	27	17	34	21	9	55	26	1	54	01	11	02	19	1	23	13	1	30	22	1	12	20	1	09	11	52	5	25							R					
7293	01	5	28	22	11	00	11	11	03	28	1	2	09	1	27	05	1	44	16	1	11	00	24	7	13	22	1	16	11	17							R					
309	27	9	32	22	1	42	09	1	44	23	1	19	10	1	53	1	2	1	1	4	28	50	2	14	01	1	0	51	26	9	04	19	1	40						R		
312	29	1	28	23	0	05	13	1	07	13	1	49	07	1	33	26	1	28	18	1	1	16	21	1	58	29	1	37	04	11	04								R			
7195	02	9	58	17	9	41	09	1	59	11	1	48	01	1	3	50	06	1	4	1	1	12	1	53	12	11	48												R			
7294	06	1	34	26	1	51	17	3	33	05	3	27	14	1	0	2	10	1	9	0	9	1	14	1	15	1	3	26	11	01									R			
7295	08	1	11	16	9	57	24	1	2	22	1	14	28	1	9	0	5	27	1	5	30	28	1	11	1	1	8	25	20	9	00	17	1	0	9						R	
7296	03	1	48	28	1	58	15	1	2	02	1	8	17	1	5	1	6	1	6	1	6	1	6	1	6	1	6	1	6	1	6										R	
7297	11	1	04	07	1	18	20	1	1	21	26	1	27	12	1	23	23	1	08	07	1	1	1	1	1	1	1	1	1	1	1									R		
4447	24	1	12	09	1	23	06	1	50	09	1	46	19	1	40	18	1	59	00	1	28	22	1	54	06	1	07	1	12	1	0	6									R	
7298	10	1	57	29	1	48	29	1	5	2	2	8	1	37	19	1	53	04	1	37	01	1	0	50	24	1	17	1	34	0	25	1	58									R
3239	18	1	44	23	1	02	08	1	1	17	04	1	32	06	1	25	27	1	0	1	1	1	1	1	1	1	1	1	1	1											R	
7131	20	1	25	13	1	19	17	1	1	48	11	1	1	1	1	1	1	1	1	1	1	1	1	1	1	1	1	1	1	1											R	
7299	25	1	53	16	1	25	29	1	1	36	12	1	1	1	1	1	1	1	1	1	1	1	1	1	1	1	1	1	1												R	
1727	06	1	29	29	1	38	02	1	1	48	18	1	1	1	1	1	1	1	1	1	1	1	1	1	1	1	1	1	1												R	
314	03	1	59	08	1	20	24	1	1	1	1	1	1	1	1	1	1	1	1	1	1	1	1	1	1	1	1	1	1												R	
7300	27	1	31	22	1	02	12	1	1	1	1	1	1	1	1	1	1	1	1	1	1	1	1	1	1	1	1	1	1												R	
315	01	1	43	06	1	24	16	1	1	1	1	1	1	1	1	1	1	1	1	1	1	1	1	1	1	1	1	1	1													R

Referenced Example Birth-Chart Data

BIRTH CHART HOUSE CUSPS						
No. of House Cusp	X	XI	XII	I	II	III
7285	14X730	1206	1029	01X37	9019	821
7286	18=53	1013	X701	17X730	1027	X14
307	250239	1127	=24	140062	X714	1019
308	18=10	1013	X704	21X739	1029	X13
7287	020455	1106	=04	25=21	10023	X725
7288	241007	=20	X25	08816	II08	0502
310	270211	1129	=26	17028	X717	1021
313	20II51	0227	028	221146	=16	1016
7289	24803	II24	0523	210759	1121	=23
7290	12911	819	II26	270558	018	1112
7292	22=55	X24	806	18II24	0509	0529
7293	28952	II05	0510	09051	1101	1127
309	29X730	1022	=19	29X07	810	II06
312	29023	1103	=01	23=24	1019	X722
7195	291045	=26	903	21820	II18	0509
7294	06711	1028	=27	11945	819	II15
7295	08853	II15	0519	18033	1110	=06
7296	03X38	907	819	28II30	0518	0109
7297	081052	=01	X01	17909	824	II18
4447	251013	=21	X26	12808	II11	0503
7298	011029	1025	=23	029028	810	II08
3239	15=33	1012	X704	24X727	=01	X11
7131	191104	=19	1013	02X727	1004	=12
7299	051142	=07	1002	211058	X722	1029
1727	19911	826	0503	030249	024	1118
314	10902	817	II26	28036	017	1110
7300	02X39	906	815	22II08	0514	0207
315	28=04	900	812	22II37	0513	0104

Referenced Example Birth-Chart Data

PROCESSED PLANETS

	♁	♂	♃	♄	♅	♆	♇	♈	♉	♊	♋	♌	♍	♎	♏	♐	♑	♒	♓	MC	Asc.
7285	05°26'	12°18'	23°13'	06°26'	19°50'	25°30'	28°54'	49°17'	21°04'	14°03'	16°08'	42°16°	18°								
7286	07°41'	15°39'	12°43'	10°42'	16°13'	28°36'	06°43'	07°43'	07°53'	07°53'	20°11'	40°06'	13°01°	45°							
307	10°54'	04°40'	19°50'	26°05'	12°13'	23°48'	07°51'	12°27'	56°03'	43°19°	17°37'	20°24'	03°	13°							
308	07°15'	28°42'	04°11'	01°29°	16°33'	16°33'	16°33'	16°33'	16°33'	16°33'	16°33'	16°33'	24°	68°							
7287	06°41'	29°45'	22°43'	11°12'	21°43'	13°11'	02°58'	07°54'	00°42'	02°53'	00°13'	0°52'	04°	41°							
310	18°37'	26°22'	27°44'	17°53'	11°34'	00°36'	08°36'	15°00°	22°11'	14°13'	29°36'	19°	17°								
313	04°41'	25°40'	12°55'	17°41'	20°23'	28°55'	14°29°	14°15°	14°15°	14°15°	21°52'	16°	50°								
7289	06°43'	03°13'	03°13'	27°59'	11°20'	03°52'	02°35'	03°43'	18°42'	51°10°	07°11'	53°	06°	04°							
7290	05°57'	08°59'	26°58'	06°03'	23°42'	15°15'	24°53'	23°18'	02°40'	02°53'	17°11'	01°	39°								
7292	10°51'	08°54'	29°34'	04°46'	05°12'	20°21°	13°09°	22°43'	20°41°	11°54'	29°19'	24°	29°								
7293	29°45'	21°41'	27°40'	18°51'	16°06'	18°45°	02°26'	44°30'	19°26°	59°20°	12°	24°	06°	10°	27°						
309	22°07'	26°42'	27°29'	11°01°	01°02°	00°22'	02°16'	15°41°	12°11°	33°03°	05°11'	56°	00°	10°	16°	01°					
312	00°45'	04°29'	22°34'	16°42'	01°40'	02°16'	00°46°	10°24°	02°11°	04°13°	32°16°	52°	09°	34°							
7195	20°06'	22°20'	06°08'	12°11°	09°09°	11°00°	24°10°	24°10°	17°16°	15°25°	25°11°	34°00°	09°	20°	51°						
7294	00°32'	29°46'	04°42'	16°55'	29°45'	25°45'	08°19°	13°17°	17°16°	15°25°	25°11°	34°00°	09°	20°	51°						
7295	24°11'	25°57'	09°11'	36°12'	04°46'	03°11°	18°08°	21°44°	25°18°	20°53°	21°42°	18°	10°	25°	14°	26°	57°				
7296	00°48'	00°22'	14°40'	20°24'	23°34'	13°48°	02°56'	22°47°	51°05°	53°20°	11°24°	00°	48°	20°	53°	12°					
7297	15°41'	23°02'	28°49'	25°45'	01°49°	01°49°	22°42°	22°42°	14°05°	17°21°	51°04°	57°20°	19°	12°	55°	08°	00°				
4447	18°40'	12°53'	26°26'	01°43'	05°23'	21°59'	02°38'	24°11°	04°06°	51°12°	14°19°	55°	08°	11°	40°						
7298	10°53'	22°39'	23°11°	04°11°	08°42'	06°03'	04°45'	23°46°	18°53°	44°26°	14°11°	01°	55°	17°	10°						
3239	06°42'	04°45'	09°41°	13°22°	11°45°	25°42°	25°42°	14°28°	24°02°	35°24°	18°18°	52°	03°	14°	10°	08°					
7131	24°06'	07°42'	03°03°	07°23'	07°51'	21°11°	22°19°	47°22°	26°16°	08°28°	15°22°	45°	28°	15°	22°	45°	28°	55°			
7299	04°42'	25°01'	26°40'	13°58'	01°53°	18°01°	47°00°	37°28°	52°17°	45°11°	50°14°	12°	20°	47°	28°						
1727	27°40'	07°10'	14°36'	11°11°	57°08°	50°50°	25°40°	07°11°	42°24°	50°19°	53°29°	51°	09°	58°	19°	41°					
314	14°11°	04°46°	04°46°	23°50°	24°53°	00°08°	02°26°	13°11°	47°24°	01°21°	42°00°	11°	48°	28°	20°	20°					
7300	01°11'	10°40'	17°45'	07°52'	08°52°	20°02°	10°19°	14°03°	38°01°	21°18°	18°53°	06°	41°	19°	25°	12°	27°				
315	01°40'	11°05°	40°04°	43°59°	16°56°	19°47°	06°29°	51°21°	47°11°	30°29°	26°21°	03°27°	32°	17°	53°	03°					

Referenced Example Birth-Chart Data

Chapter 12

Sciatica — Yellow Fever

SCIATICA

Birth-chart constants: Mercury or Uranus severely afflicted, and a planet afflicted in Sagittarius or less commonly Jupiter afflicted.

Progressed constants: An affliction involving Mercury or Uranus, or an aspect involving Mercury or Uranus at the same time there are severe rallying forces, and an aspect involving a planet in Sagittarius, or less commonly involving Jupiter.

Stellar Treatment: Sciatica is neuralgia, or if Uranus or Mercury is afflicted by Mars in the birthchart and there is a progressed aspect involving Mars, it may be neuritis, affecting the sciatic nerve. The treatment, therefore, should be the same as for neuralgia or neuritis except that the thought-cells mapped by any planet in Sagittarius should be given the planetary energy of their antidote, and the zone occupied by Jupiter should be given Mercury planetary energy. Effort should be made to relieve any strain or pressure on the sciatic nerve. Sitting a long time on a hard chair, prolapsed abdominal viscera, enlargement of the prostate gland, standing too long at a time, or any other condition which brings pressure on the nerve may be a contributing cause. Rest in bed for a few days is helpful when strain due to working conditions is a contributing factor. Electromagnetic energy applied to the nerve is beneficial.

Example: Chart 7285. Female, December 3, 1916, noon. 74W. 40:43N. Uranus semi-square Moon, Sun in Sagittarius sesqui-square Jupiter. In September, 1940, with Mercury parallel Mars p, Uranus semi-square Mars r and Moon r, and Asc. trine Mercury r in Sagittarius, developed sciatica.

SHINGLES (HERPES ZOSTER)

Birth-chart constants: An upper-octave planet prominent and afflicted, Venus afflicted and Mercury afflicted.

Progressed constants: An aspect involving an upper-octave planet, an aspect involving Venus, and an aspect involving Mercury, at the same time there are severe rallying forces.

Stellar Treatment: The blisters form along the course of a sensory nerve. Nervous tension should be avoided, and calm, peaceful and optimistic thinking of the Jupiter type cultivated. The diet should contain calcium, vitamin B-1, vitamin D, vitamin A and vitamin E, iodine and copper. Wheat germ meal is a good source of vitamin E. Electromagnetic passes may be used to soothe the pain, which may continue after the blisters have disappeared. Saturn planetary energy should be applied to the zone occupied by Venus, the planetary energy of its antidote should be applied to the zone occupied by the afflicted upper-octave planet, and Jupiter planetary energy should be given the zone occupied by Mercury. If the blisters form on the eyelids or eyeball, the pupil should be kept dilated with atrophine and the eye bathed with boracic lotion under competent medical supervision.

Example: Chart 7286. Female, February 9, 1906, 4:00 a.m. 121:14W. 50:42N. Uranus in an angle opposition Neptune, Venus and Mercury opposition Moon. In April, 1923, as progressed, with Mercury parallel Venus p, Sun sextile Uranus p and trine Neptune r, Uranus opposition Neptune p, Neptune semi-square Moon r, and Uranus sesqui-square Moon r, had shingles.

SINUS TROUBLE (NASAL)

Birth-chart constants: An upper-octave planet prominent, Saturn or Jupiter afflicted, and commonly a planet in either Aries or Scorpio.

Progressed constants: An aspect involving an upper-octave planet, an aspect involving Jupiter or Saturn, and an aspect involving the planet in Scorpio or Aries, at the same time there are severe rallying forces.

Stellar Treatment: In addition to applying the planetary energy of its antidote to the zone occupied by the upper-octave planet, and to the zone occupied by Jupiter or Saturn and the planet in Scorpio or Aries, the diet should be such as to alkalize the blood stream and to correct the hypersensitivity. To do the latter it should contain calcium, vitamin B-1, and vitamin D. If Saturn is prominent and afflicted, the diet should contain variety in mineral salts, vitamins and proteins. If Jupiter is prominent and afflicted, care should be taken with sugar and fat, and the diet should contain sulphur. Nervous tension should be avoided, and calm and harmonious thinking cultivated.

Example: Chart 307. Male, June 7, 1903, 4:43 p.m. 87:50W. 42N. Sun conjunction Pluto and opposition Uranus, Moon in Scorpio, Jupiter square Sun. May 8, 1929, as progressed, with Mercury conjunction Pluto p, M.C. sextile Moon r in Scorpio and opposition Jupiter r, and Saturn semi-square Uranus p, developed sinus trouble.

SLEEPING SICKNESS

Birth-chart constants: Neptune prominent and afflicted.

Progressed constants: An aspect involving Neptune and an aspect involving Mars.

Stellar Treatment: This unusual malady should not be confused with the sleeping sickness of Africa which is due to the parasite trypanosome. Yet that the sleeping sickness of America is induced by the invasion of some micro-organism is indicated by the fact that when it occurs a progressed aspect involving Mars is present. This aspect also reduces the efficiency of the human chemical fighting apparatus. The diet should contain calcium, vitamin B-1, vitamin A, vitamin C, variety of mineral salts, especially iron, and variety of, but not too much, protein. Sun planetary energy should be applied to the zone occupied by Neptune, and solar electromagnetism should be applied to the patient to increase the vitality.

Example: Chart 308. Male, May 17, 1913, 9:00 p.m. 98:30W. 45:30N. Neptune in an angle opposition Jupiter and square Venus. February 1, 1925, as progressed, with Mercury parallel Neptune p, Mars conjunction Jupiter p, and Sun conjunction Saturn p, became ill; went to sleep February 7, and slept 21 days.

SMALL POX

Birth-chart constants: Mars and Venus prominent and afflicted.

Progressed constants: An aspect involving Mars and an aspect involving Venus at the same time there are severe rallying forces.

Stellar Treatment: This highly contagious disease is typical of Mars, and the more prominent Mars is the more likelihood of contracting it. Unsanitary conditions contribute to its power to afflict. To the extent the blood stream contains toxins, and there is too little adrenalin and cortin is it easy for the invading forces to gain a foothold. Few have a blood stream sufficiently pure, and the adrenal glands vigorous enough, to be free from risk through exposure to the disease. The food should not be stimulating, but productive of an alkaline reaction. Proteins and rich foods should be avoided. Fruit juices and vegetable juices are recommended. Moon planetary energy should be applied to the zone occupied by Mars, and Saturn planetary energy to the zone mapped by Venus. Lunar electromagnetic energy may be used to reduce the fever. As excitement and activity increase the toxic condition of the blood stream, and thus give adrenalin and cortin additional work, they should be avoided. Good nursing is unusually important.

Example: Chart 7287. Male, October 19, 1914 6:20 a.m. 117W. 47N. Mars in an angle conjunction Moon and Mercury. Venus semi-square Sun. In October, 1925, as progressed, with Mercury conjunction Mars p, M.C. square Mars r, Sun semi-sextile Venus r, and Venus semi-square Sun r, had small pox.

SPINAL CURVATURE

Birth-chart constants: The Sun afflicted by Saturn or a planet in Leo afflicted by Saturn.

Progressed constants: An affliction involving the Sun or an affliction involving a planet in Leo.

Stellar Treatment: Treatment depends on the cause. When the back is very weak a support may be needed part of the day. In some forms much may be done by lengthening a leg by a high-heeled boot, or by similar corrective measures. If the curvature is due to rickets, the treatment should include that for rickets, if due to tuberculosis or cancer, the treatment should include treatment of such disease. But in addition, the zone occupied by Saturn should be given Venus planetary energy, the Sun if afflicted by Saturn should be given Jupiter planetary energy and if there is a planet in Leo afflicted by Saturn, the zone it occupies should be given the appropriate planetary antidote. The diet should contain ample variety of vitamins, mineral salts and proteins.

Example: Chart 7288. Female, December 15, 1920, 2:00 p.m. 118:15W. 34N. Neptune in Leo opposition Moon and Mars. Sun square Saturn. At, or soon after birth, as progressed, with Saturn square Sun r, and Mars opposition Neptune r in Leo, had spinal curvature; grew up to be a hunchback.

SPINAL MENINGITIS

Birth-chart constants: An upper-octave planet prominent, Sun afflicted, and Mars afflicted or a planet in Aries afflicted.

Progressed constants: An aspect involving an upper-octave planet, an aspect involving the Sun, and an aspect involving Mars or a planet in Aries, at the same time there are severe rallying forces.

Stellar Treatment: Meningitis may follow infectious fever, blood poisoning, or injuries to the skull which become infected. The ear in particular is a common site of its origin following its inflammation or the decay of the adjacent bone. From the brain the infection may spread to the meninges of the spinal cord. Rest and confinement to bed are essential. An ice bag on the head and tepid baths may be used to reduce the fever, together with lunar electromagnetic energy. Penicillin may be used by a doctor to destroy the infection. Diet should be fruit juices and vegetable juices to alkalize the blood stream. Vitamin B-1, vitamin D and calcium are needed in the diet. The zone occupied by Mars should be given this planet's antidote planetary energy, and its antidote planetary energy should be applied to the zone occupied by the significant upper-octave planet.

Example: Chart 310. Male, June 6, 1898, 5:15 p.m. 94:40W. 39N. Pluto and Uranus in angles, Mars in Aries square Moon and semi-square Sun. In December, 1900, as progressed, with M.C. trine Mars r in Aries, Mars inconjunct Uranus r and semi-square Sun r, had spinal meningitis.

SPLEEN TROUBLE

Birth-chart constants: An affliction to either Sun or Saturn, often Sun afflicting Saturn.

Progressed constants: An affliction involving Sun or Saturn, or afflictions involving both.

Stellar Treatment: The zone occupied by Saturn should be given the planetary energy of Venus and the zone occupied by the Sun should be given the planetary energy of Jupiter. The spleen should be thoroughly and repeatedly charged with solar electromagnetic energy, taking pains to seal it in with a motion of the hand to prevent it oozing out before used. As there is usually a contributing disease of some recognized type, this should receive the treatment advocated for it.

Example: Chart 313. Female, January 23, 1891, 9:00 p.m. 17E. 49N. Sun sesqui-square Saturn, square Uranus, and semi-square Venus. Saturn conjunction Asc. and opposition Mars. In April, 1921, as progressed, with Mars parallel Saturn p, Asc. semi-sextile Saturn r, and Sun square Neptune r, developed hardening of the spleen.

SPRAIN

Birth-chart constants: Mars prominent and severely afflicted.

Progressed constants: An aspect involving Mars at the same time there are severe rallying forces

Stellar Treatment: When the sudden overstretching of a muscle or ligament stops before actually tearing it is called a strain; when there is tearing it is called a sprain. In either case first-aid treatment consists of rest and cold applications and a firm, smooth bandage. Later, heat may be applied to relieve the pain, alternating with lunar electromagnetic energy. Movements that cause dragging on the injured muscle should be avoided, but the joint should be moved gently from the first, and after a few days through its whole range, to prevent the scar tissue forming adhesions. In a few days if there is no acute inflammation massaging will prove beneficial. Electromagnetic passes over the injured part should then also be used. Moon planetary energy should be applied to the zone occupied by Mars.

Example: Chart 7289. Male, April 13, 1895, 2:00 p.m. LMT. 61:18 W. 10:27N. Mars sextile Sun and opposition Moon. In September, 1908, as progressed, with Mars conjunction Jupiter p, trine Saturn p in Scorpio, and sesqui-square Uranus p in Scorpio, sprain caused swollen and painful testicles.

ST. VITUS'S DANCE

Birth-chart constants: An aspect between Mercury and Uranus, usually an affliction.

Progressed constants: An aspect involving Uranus at the same time there are severe rallying forces.

Stellar Treatment: There is a conflict of mental factors which should be reconciled. Psychoanalysis may be used to reveal the conflict, and to point the way to the reconciliation. Calm and unhurried thinking of the Jupiter type should be cultivated. All stress on the nervous system should be avoided. Relaxation through mild recreation is advisable. The diet should contain calcium, vitamin B-1 and vitamin D. The zones occupied by Mercury and Uranus should be given Jupiter planetary energy. Thought treatment and suggestion may be used to reduce the nervous tension and reharmonize the conflicting mental factors. Everything tending toward excitement should be avoided.

Example: Chart 7290. Female, April 21, 1917, 10:45 a.m. 74:11W. 40:44N. Mercury square Uranus. In June, 1922, as progressed, with Mars sextile Uranus p, and square Saturn p, developed St. Vitus Dance.

STUTTERING

Birth-chart constants: Uranus prominent and Mercury afflicted.

Progressed constants: An aspect involving Mercury at the same time there are severe rallying forces, especially if Uranus is involved.

Stellar Treatment: Stuttering is due to anxiety hysteria. When the conflicting mental factors are reconciled the stuttering will cease. Psychoanalysis may be used to reveal the cause of the anxiety, and suggestion and thought treatment to alleviate it. Voice exercises and breathing exercises may help through giving the individual confidence. Jupiter planetary energy should be applied to the zones occupied by Mercury and Uranus.

Example: Chart 7292. Male, March 25, 1925, 10:05 a.m. EST. 83:33W. 41:39N. Uranus in an angle, Mercury square Jupiter. He was in the habit of using both hands with equal facility. In September, 1931, as progressed, with Mercury sextile M.C. p, Uranus semi-sextile Mercury r, and Sun square Pluto p, he started going to school, and there was coerced (Pluto) into using only his right hand. He then commenced to stutter.

SUICIDE

Birth-chart constants: Mars afflicted and a planet in the twelfth house, or the ruler of the twelfth house heavily afflicted.

Progressed constants: An aspect to the ruler of the twelfth house at the same time there are severe rallying forces.

Stellar Treatment: Through education in the true purpose of life desire should be built up in the individual with a predisposition toward suicide to see life through regardless of its difficulties. He should be made to realize he cannot escape difficulty by running away from physical life. Courage should be developed to face any situation, to place trust in higher powers, and he should be convinced he is a significant factor in the universal scheme. He should cultivate Jupiter type thinking. Suggestion and the thought treatment should have for object reconciling the mental conflicts which tend toward despondency or impulse to violence. Moon planetary energy should be applied to the zone occupied by Mars, and its planetary antidote should be given the zone of the afflicted ruler of the twelfth house.

Example: Chart 7293. Male, June 22, 1884, 7:30 a.m. 86:12W. 39:47N. Mercury and the Moon conjunction Saturn, Mercury and Saturn square Mars, Moon co-ruler of twelfth. On July 14, 1945, as progressed, with Saturn conjunction Moon r, ruler of twelfth, Mars trine Saturn r and sesqui-square Pluto r, Asc. and Mercury conjunction Uranus p, and M.C. square Uranus p, deliberately shot himself through the head with a revolver and died.

SUNSTROKE (HEATSTROKE)

Birth-chart constants: Watery planets, chiefly Neptune or the Moon, prominent and afflicted, often an affliction in Aries.

Progressed constants: An aspect, usually an affliction, involving the Sun, and an aspect, usually an affliction, involving Mars.

Stellar Treatment: The same conditions develop in furnace workers and those in glass works, laundries, etc., where the heat is great, as with those who suffer from the direct rays of the Sun. The salt balance should be reestablished by the individual drinking water containing some salt. He should be taken into the shade or as cool a place as possible and head and body soused with cold water. If, as usual, the temperature is high, ice packs or bath. together with lunar electromagnetic energy, should be used to lower it. If, instead, the skin is cool and pale and the temperature subnormal, a hot bath, or hot water bottles, together with solar electromagnetic energy, should be used after he has been put to bed. Fruit juices and vegetable juices should constitute most of the diet. The throbbing in the head may be relieved by cold packs and electromagnetic passes from the top of the head downward.

Example: Chart 309. Male, April 17, 1873, 4:15 a.m. 122W. 38N. Sun conjunction Neptune in an angle in Aries, and both square Uranus. Moon square Asc. In August, 1898, as progressed, with Sun square Jupiter r, and Mars square Uranus r and square Saturn r, suffered sun stroke.

SYPHILIS

Birth-chart constants: Venus or Mars, usually both, afflicted, and especially an affliction between Mars and Venus.

Progressed constants: An aspect, usually an affliction, involving Mars.

Stellar Treatment: The medical profession treats this disease successfully with penicillin. Highly seasoned and spicy foods should be avoided, also strain and excitement. There should be vitamin A, vitamin E, iodine, copper, vitamin B-1, vitamin C, iron and variety of, but not too much, protein. The utmost in cleanliness should be observed. The zone occupied by Venus should be given Saturn planetary energy, the zone occupied by Mars should be given Moon planetary energy, there should be exercise enough to insure elimination, and electromagnetic energy should be employed to build up the vitality.

Example: Chart 312. Male, January 18, 1889 11:50 p.m. 99:50W. 47N. Mars conjunction Venus and sesqui-square Uranus and Asc. Venus semi-square Sun. In June, 1919, as progressed, with Asc. sesqui-square Mars p and inconjunct Venus p, Uranus sesqui-square Mars r, Mars sesqui-square Saturn p, and Sun square Neptune r, contracted syphilis.

THROMBOSIS

Birth-chart constants: Venus or Jupiter afflicted, and Pluto. Neptune or Saturn prominent and afflicted.

Progressed constants: An affliction involving Venus or Jupiter at the same time there is an aspect involving Pluto, Neptune or Saturn, and an aspect involving Mars.

Stellar Treatment: Venus rules the veins and the venous blood. Jupiter rules the arteries and the arterial blood. The cause of thrombosis (plugging of a blood vessel) is a marked change in the circulation or an injury to the walls of the blood vessels. An affliction to Pluto or Neptune decreases the adrenalin and cortin supply, an affliction to Saturn exhausts the adrenalin supply; and especially if there is a depleted condition, lack of adrenalin may slow down the circulation markedly. But under the influence of the progressed Mars aspect there may be bacterial infection, temporary irritation and excitement, a toxic condition, or a spurt of exertion, which releases adrenalin. Adrenalin, as well as certain bacteria, has a tendency to cause blood to clot; and released at a time when the circulation markedly alters, a blood clot may form either in the veins or in the arteries. This clot may cut off nutriment from a given area of the body. Lodging in the heart it may cause death, in the brain some degree of paralysis may result. Through diet and application of Sun planetary energy to the zones occupied by Venus and Pluto, Neptune or Saturn, the vitality should be increased. Mercury energy should be given the zone occupied by Jupiter, and Moon energy to the zone occupied by Mars.

Example: Chart 7195. Male, March 23, 1898, 7:54 a.m. 87:39W. 41:52N. Venus opposition Jupiter, Pluto and Neptune opposition Saturn. June 3, 1946, as progressed, with Venus opposition Saturn p, Sun sesqui-square Jupiter r, Mars square Asc. p, and Asc. square Mercury r, was taken to hospital where later little finger (Venus p in Gemini) on right hand was amputated. Depletion and low blood pressure preceded thrombosis which blocked blood supply to arm, causing little finger to turn black.

TICK FEVER

Birth-chart constants: Mars prominent and Neptune prominent and afflicted.

Progressed constants: An aspect involving Mars and an aspect involving Neptune, at the same time there are severe rallying forces.

Stellar Treatment: The micro-organism which causes this disease is carried by ticks or other parasitic insects. This virulent disease is now successfully treated in hospitals with streptomycin. The fever, which runs very high and then suddenly falls, and continues to repeat this process, may be relieved by ice packs, sponging in tepid water, and lunar electromagnetic energy. As in other infectious fevers, complete rest in bed is advocated, and a diet to alkalize the blood stream, chiefly fruit and vegetable juices. The zone occupied by Neptune should be given Sun planetary energy, and the zone occupied by Mars should be given Moon planetary energy. The vitality should be reinforced by electromagnetic passes. Good nursing is important.

Example: Chart 7294. Male, July 29, 1908, 10:00 p.m. 90:40W. 40:27N. Neptune in an angle conjunction Mercury and square Saturn and the Asc. Mars conjunction Sun and Moon, and inconjunct Uranus. On July 15, 1933, as progressed, with Sun conjunction Mars p, Venus conjunction Neptune p, and Mars and Sun semi-square Neptune r, was bit by tick and a few days later developed tick fever.

TONSIL TROUBLE

Birth-chart constants: Pluto, Neptune or Saturn prominent at the same time either Venus or a planet in Taurus is afflicted.

Progressed constants: An aspect involving Mars, an aspect involving Pluto, Neptune or Saturn, at the same time there is an aspect involving Venus or a planet in Taurus.

Stellar Treatment: The influence of Pluto and Neptune depress the manufacture of adrenalin and cortin, and the influence of Saturn tends to exhaust the adrenalin supply. The blood stream becomes acid, and under the Mars influence adrenalin and cortin are exhausted, and inflammation or infection develops. It attacks the tonsils because of the Venus or planet in Taurus affliction. The blood stream should be alkalized with a diet chiefly of fruits and vegetables. The diet should contain vitamin A, vitamin E, iodine, copper, iron, calcium, vitamin C and vitamin B-1. Sun

planetary energy should be applied to the zone occupied by the significant negative planet and to the zone occupied by Venus. Its antidote planetary energy should be applied to the zone occupied by any planet in Taurus. Electromagnetic energy should be applied to the region of the tonsils.

Example: Chart 7295. Female, April 28, 1870, noon. 84:30W. 42:30N. Saturn square Venus, Sun in Taurus conjunction Pluto and Mars. Neptune conjunction Moon. Had much trouble with tonsils until they were removed in July, 1918, as progressed, with Mars semi-square Uranus r, Venus sesqui-square Saturn r, and Pluto in Taurus sextile Uranus r.

TOOTH TROUBLE

Birth-chart constants: Saturn prominent and afflicted, and an upper-octave planet prominent.

Progressed constants: An aspect involving Saturn and an aspect involving Mercury or an upper-octave planet at the same time there are severe rallying forces.

Stellar Treatment: The normal action of the parathyroid glands is essential to maintaining good teeth. Therefore the diet should contain calcium, vitamin B-1 and vitamin D. Nervous stress and strain should be avoided, and harmonious Jupiter thinking cultivated. Also, to maintain good teeth, there should be variety of vitamins, variety of minerals and variety of proteins. Poor teeth indicate either something is lacking in the diet, or that it cannot be properly handled. Venus planetary energy should be applied to the zone occupied by Saturn, and its antidote planetary energy should be applied to the zone occupied by Mercury or the significant upper-octave planet. Worry, fear and anxiety contribute to poor teeth by interfering with the action of the Saturn growth hormone of the front pituitary gland.

Example: Chart 7296. Female, September 27, 1903, 9:45 p.m. 71:25W. 41:49N. Saturn trine Sun and sesqui-square Venus. Neptune in an angle square Sun. Had neuralgia headaches from bad teeth until in March, 1931, as progressed, with Saturn sesqui-square Venus r, trine Sun r and Mars r, Mars conjunction Uranus p, Mercury semi-square Moon r, and Venus square Pluto r, had all her upper teeth removed.

TRENCH MOUTH

Birth-chart constants: Saturn and Mars prominent and afflicted.

Progressed constants: An aspect involving Saturn and an aspect involving Mars, at the same time there are severe rallying forces.

Stellar Treatment: This disease is secondary to infection of the teeth and gums by a bacillus. Doctors advise massaging the gums with sodium perborate and gargling the throat with antiseptic solution. The diet should be such as to alkalize the blood stream and to strengthen the production of adrenalin. It should contain vitamin A, vitamin B-1, vitamin C, iron, and a wide variety of other vitamins, mineral salts and proteins. The zone occupied by Mars should be given Moon planetary energy, and the zone occupied by Saturn should be given Venus planetary energy.

Example: Chart 7297. Female, July 3, 1403, 11:45 p.m. 87:39W. 41:52N. Saturn trine Moon, semi-square Jupiter and semi-square Uranus. Mars square Sun and opposition Asc. On May 4, 1940, as progressed, with M.C. trine Mars r, Jupiter sesqui-square Moon r and semi-square Saturn r, and Saturn sesqui-square Mercury r, developed trench mouth.

TUBERCULOSIS

Birth-chart constants: Saturn, Neptune, Jupiter and Pluto prominent and usually afflicted.

Progressed constants: An aspect involving Saturn, an aspect involving Jupiter, an aspect involving Neptune, and often an aspect involving Pluto, at the same time there are severe rallying forces.

Stellar Treatment: The analysis of the charts of 100 people progressed to the time tuberculosis developed, and the details of precautionary measures and treatment are given in the reference book, BODY DISEASE AND ITS STELLAR TREATMENT.¹ Even when the disease is in an advanced stage, other than taking care of the cavities, if these have developed, the outstanding problem presented in tuberculosis infection is to build up a physical vitality so vigorous that the body can heal the attacked tissues and prevent further infection. Fresh air, sunlight, moderate exercise, rest from hard work, and nourishing foods are important. The food should contain a wide variety of vitamins, mineral salts and proteins. The thinking is very important also, and the type should be cultivated which will give greater activity to Sun thought-cells. Negative thinking should be avoided. The zones of the constants should be treated with the proper planetary antidotes, and solar electromagnetic energy should be applied to build up positiveness and vitality.

Example: Chart 4447. Male, July 17, 1863, 0:10 a.m. 122W. 38N. Mercury square Saturn, Sun square Jupiter, Mercury square Neptune, Pluto conjunction Asc. In July, 1888, as progressed, with Sun semi-square Saturn p, Sun sextile Jupiter r, Mars inconjunct Neptune p, and Pluto conjunction Asc. r, developed tuberculosis.

1 Out of print. See }{\plain \i\fl Astrology: 30 Years Research}{\plain \fl .

TUMOR (BENIGN)

Birth-chart constants: Jupiter, Saturn, Neptune and the Moon prominent and often afflicted.

Progressed constants: A progressed aspect involving Jupiter and a progressed aspect involving Saturn.

Stellar Treatment: Although the progressed aspects at the time are usually more severe when cancer develops, especially the one involving Saturn, it is difficult from the astrological constants to determine whether the predisposition is merely toward benign growths or toward those more malignant. The constants for tumors of all kinds indicate an acid blood stream, and one filled with toxins. The Jupiter influence tends to cause the blood stream to be filled with incompletely burned fuel, and an excess of fat which may be deposited as a fatty tumor. Saturn rules the growth hormone of the front pituitary gland, and when afflicted may promote abnormal growths. The diet should be such as to alkalize the blood stream and furnish it with not too rich foods, but those containing a wide variety of vitamins, mineral salts and proteins. The thinking should avoid negative conditions and emotional discords, and should include harmonious Sun type thinking. The energy of its planetary antidote should be applied to the zone occupied by each birth-chart constant.

Example: Chart 7289. Female, June 2, 1910, 1:15 a.m. 117:05W. 33:07N. Jupiter in an angle opposition Asc., Saturn in an angle square Moon, Neptune in an angle opposition Uranus. May 20, 1941, as progressed, with Venus trine Jupiter r, semi-sextile Saturn p, and semi-square Mars r, and with M.C. square Saturn r, a benign tumor was removed surgically.

TYPHOID FEVER

Birth-chart Constants: Mars rather severely afflicted. Saturn, Neptune or Pluto prominent increases the predisposition.

Progressed constants: An aspect involving Mars, an aspect involving Mercury or a planet in Virgo, and usually an aspect involving Saturn, at the same time there are discordant rallying forces.

Stellar Treatment: The analysis of the charts of 100 people progressed to the time they had typhoid fever, and the details of treatment and precautionary measures, are given in the reference book, *BODY DISEASE AND ITS STELLAR TREATMENT*.² As the blood stream is already filled with toxic acids, it is obvious that the diet should tend toward neutralizing this condition by tending toward the alkaline. Any physical exercise results in acid products of combustion entering the

2 Out of print. See }{\plain \ifl Astrology: 30 Years Research}{\plain \f1 .

blood stream, therefore the patient should be kept lying down, but turned from side to side on his back every few hours to prevent the development of bed sores. The mouth should be cleansed frequently with water, boric glycerin or listerine. Water should be taken copiously. Fruit and vegetable juices should be the chief diet until the patient is strong enough to handle foods more substantial. Then, to strengthen the adrenal glands, it should contain vitamin A, vitamin B-1, vitamin C, iron and variety of proteins, but little meat. The zone occupied by Mercury should receive Jupiter planetary energy, the zone occupied by the significant negative planet, and the zone occupied by any planet in Virgo, should receive the planetary energy of the appropriate antidote. Good nursing is important.

Example: Chart 3239. Male, February 7, 1873, 3:47 a.m. 84:50W. 38:45N. Mars in an angle square Neptune, Pluto square Sun. In August, 1890, as progressed, with Sun trine Mars r, Mercury semi-square Neptune p, and Saturn inconjunct Jupiter r, had typhoid fever.

ULCER

Birth-chart constants: Mars and Uranus afflicted and Saturn, Neptune or Pluto prominent and usually afflicted.

Progressed constants: An aspect involving Mars, an aspect involving Uranus, and an aspect involving Saturn, Neptune or Pluto, at the same time there are severe rallying forces.

Stellar Treatment: Ulcers fall into three main groups, those due to some kind of irritation, those due to micro-organisms, and those due to malignant new growths. In either group nutritional deficiencies contribute to keep it going, and usually contribute to its origin. Those due to micro-organisms are now successfully treated with penicillin. The floor of the ulcer should be kept antiseptic. But after the micro-organism has been eradicated by the penicillin, as with the other two groups, there is need to build new and healthy tissue. For this purpose the food should be ample and nourishing, but with plenty of vegetables and fruits to alkalize the blood stream. It should contain variety of vitamins, mineral salts and proteins, especially vitamin A, vitamin B-1, vitamin C, and iron. The vitality should be increased through giving the patient solar electromagnetic energy. Moon planetary energy should be applied to the zone occupied by Mars, Jupiter planetary energy should be applied to the zone occupied by Uranus, and the planetary energy of its antidote should be applied to the zone occupied by the significant negative planet.

Example: Chart 7131. Male, December 12, 1882, 5:55 a.m. 94W. 41:37N. Mars in an angle square Uranus, Saturn inconjunct Sun, Neptune inconjunct Mercury, Pluto sesqui-square Moon. July 22, 1945, as progressed, with Mars sesqui-square Uranus r, Sun inconjunct Uranus r, Mercury sesqui-square Uranus r, and Asc. trine Pluto r, started to develop a serious ulcer on his right thigh.

UNDULANT FEVER

Birth-chart constants: Mars and Moon prominent and afflicted.

Progressed constants: An aspect involving Mars and a progressed aspect involving the Moon, at the same time there are serious rallying forces.

Stellar Treatment: As this disease is caused by *Bacillus abortus*, and the similar disease, Malta Fever, is caused by a germ, *Alcaligenes melitensis*, both found in goat's milk, precautionary action consists of either refraining from goat milk, or boiling it for 20 minutes to destroy the infection. At the onset the fever gets a little higher each day for about seven days, then gradually subsides to normal, but after two or three weeks the process is repeated, and thus recurs for a few months up to two years. The medical profession now treats this disease by administering streptomycin and sulfadiazine simultaneously. Otherwise, it should be treated as are other fevers. There should be rest, and sponging and lunar electromagnetic energy to keep the fever down. The diet should be such as to alkalize the blood stream, and to reinforce the adrenalin glands. It should contain vitamin A, vitamin B-1, vitamin C, iron and variety of proteins, but not too much protein. The zone occupied by Mars should be given Moon planetary energy, and the zone occupied by the Moon should be given Mars planetary energy.

Example: Chart 7299. Male, February 14, 1897, 1:30 a.m. EST. 84:33W. 43N. Mars in an angle conjunction Neptune and Pluto and sesqui-square Mercury. Moon square Venus and sesqui-square Uranus. In August, 1935, as progressed, with Mars sextile Jupiter p, and inconjunct Saturn p, and Jupiter semi-square Moon r, had undulant fever.

UTERUS TROUBLE

Birth-chart constants: A planet afflicted in Scorpio, or an affliction to Mars or Venus, especially if the Moon is afflicted.

Progressed constants: An aspect, usually an affliction, involving a planet in Scorpio, or involving Mars or Venus, especially if the Moon is also involved in an aspect.

Stellar Treatment: The Moon has considerable influence over the feminine cycles through its influence on a back pituitary hormone which causes the cavity where the follicle is ruptured when the egg matures to be transformed into the corpus luteum which secretes another hormone called progesterin. Progesterin has successfully been used to overcome sterility in women when due to insufficient development of the organs involved. It prepares the lining of the womb for the fertilized egg. If the Moon is afflicted, the zone it occupies should be given Mars planetary energy. Usually difficulty with the uterus is due to the thought-cells mapped by Venus or Mars. If there is a planet in Scorpio, especially if afflicted, any difficulty is more likely to

affect the uterus than it otherwise would. Electromagnetic energy should be applied to the region. The planetary energy of its antidote should be applied to the zone occupied by any planet in Scorpio, Saturn planetary energy should be applied to the zone occupied by Venus, and Moon planetary energy should be applied to the zone occupied by Mars. Vitamin A, vitamin E, and iron are especially important. Insufficiency of one of these will seriously affect menstruation. The diet should also contain iodine, copper, vitamin B-1, vitamin C and variety of protein.

Example: Chart 1727. Female, March 26, 1884, 12:40 p.m. 71:53W. 42:03N. Sun, Moon and Mercury semi-square Venus, Mars conjunction Asc., Moon opposition Uranus. May 20, 1905, as progressed, with Asc. square Venus r, Mars semi-square Uranus p, and Pluto sextile Moon r, underwent operation to correct inverted uterus.

VARICOSE VEINS

Birth-chart constants: Venus afflicted.

Progressed constants: An aspect involving Venus at the same time there are severe rallying forces, especially involving Mars.

Stellar Treatment: This difficulty is often brought on through the strain of constant standing, or in women through pregnancy. The afflictions involving Venus cause the irritants in the blood stream to weaken the walls of the veins. The chemical imbalance encouraged by Venus is due to imperfect functioning of the thyroid and gonad glands. But very frequently the other planets afflicted encourage toxins to accumulate in the blood which, under the progressed aspect involving Venus, cause the veins to become dilated and tortuous. The diet should favor Venus, including vitamin A, vitamin E, iodine and copper. Wheat germ meal is an excellent source of vitamin E. The diet should also be such as to alkalize the blood stream and free it from irritants. Emotional stresses should be avoided, and a poised attitude cultivated. Saturn planetary energy should be given the zone occupied by Venus, and each group of thought-cells contributing to the toxic blood stream should receive its appropriate planetary energy antidote.

Example: Chart 314. Female, April 23, 1884, 10:40 a.m. 123W. 44:30N. Venus semi-square Sun and square Uranus. In July, 1926, as progressed, with Venus sextile Mercury r and sextile Uranus r with Sun conjunction Saturn p, and with Mars square Pluto r, varicose veins caused severe trouble.

WHOOPING COUGH

Birth-chart constants: Pluto, Neptune or Saturn prominent, and Mercury or a planet in Gemini afflicted.

Progressed constants: An aspect involving Mars, an aspect involving Mercury or the planet in Gemini, and usually an aspect involving Saturn, Neptune or Pluto.

Stellar Treatment: This is a contagious disease more readily contracted in the presence of a common cold. The Mercury, Pluto or Neptune aspect tends to cause deficiency of parathyrin, resulting in hypersensitivity of the membranes of the throat and bronchi. The Mars influence tends to exhaust both adrenalin and cortin, the Saturn influence exhausts adrenalin, Pluto and Neptune depress the manufacture of adrenalin and cortin. Infection is thus facilitated. There is an accumulation of tough, tenacious mucus in the throat which causes the cough. This may be severe enough either to cause collapse of some portion of the lungs, or the dilation of the air cells accompanied by shortness of breath. The diet should alkalize the blood stream. For this purpose fruit and vegetable juices are excellent. To combat the hypersensitivity of the membranes the diet should contain vitamin B-1, vitamin D and calcium. The zone of the significant negative planet should be given the planetary energy of its antidote, the zone occupied by Mercury should be given Jupiter planetary energy, the zone occupied by the planet in Gemini should be given the planetary energy of its antidote, and the zone occupied by Mars should be given Moon planetary energy.

Example: Chart 7300. Male, November 19, 1928, 6:16 p.m. 118:15W. 34N. Mercury square Moon, Asc. in Gemini opposition Saturn, Pluto trine Mercury, Neptune square Sun. July 4, 1932, as progressed, with Pluto trine Mercury r, Sun square Neptune r, and Venus opposition Mars p, developed whooping cough.

YELLOW FEVER

Birth-chart constants: Mars afflicted and prominent, and Saturn, Neptune or Pluto prominent.

Progressed constants: An affliction involving Mars at the same time Saturn, Neptune or Pluto are involved in an aspect.

Stellar Treatment: This disease is caused by the invasion of the blood stream by a virus through the bite of the Stegomyia mosquito. Cold sponging, ice packs and lunar electromagnetic energy should be used to keep the fever down. To alkalize the blood stream, the diet should be chiefly fruit and vegetable juices, with vitamin B-1, vitamin C and iron to assist the adrenal glands produce adrenalin and cortin to fight the infection. Through positive Sun thinking, through the application of electromagnetic energy, and through the application of Sun planetary energy to the zone occupied by the significant negative planet, every effort should be made to build up the vitality and help the body chemicals overcome the invading organism. The patient should rest, and be kept free from excitement and stimulating food.

Example: Chart 315. Male, February 20, 1875, noon. 82:45W. 40:45N. Mars square both Sun and Moon, Neptune semi-square Mercury, Pluto square Saturn. In August, 1904, as progressed, with Mercury square Mars r, Saturn square Pluto p, Jupiter opposition Neptune p, and Mars sextile Saturn r, had yellow fever.

Book 17

Copyright
August 2002
Church of Light

Cosmic Alchemy

Chapter 1

Serial No. 164
Original Copyright 1946
Elbert Benjamine

Copyright
August 2002
Church of Light

The Conquest of War

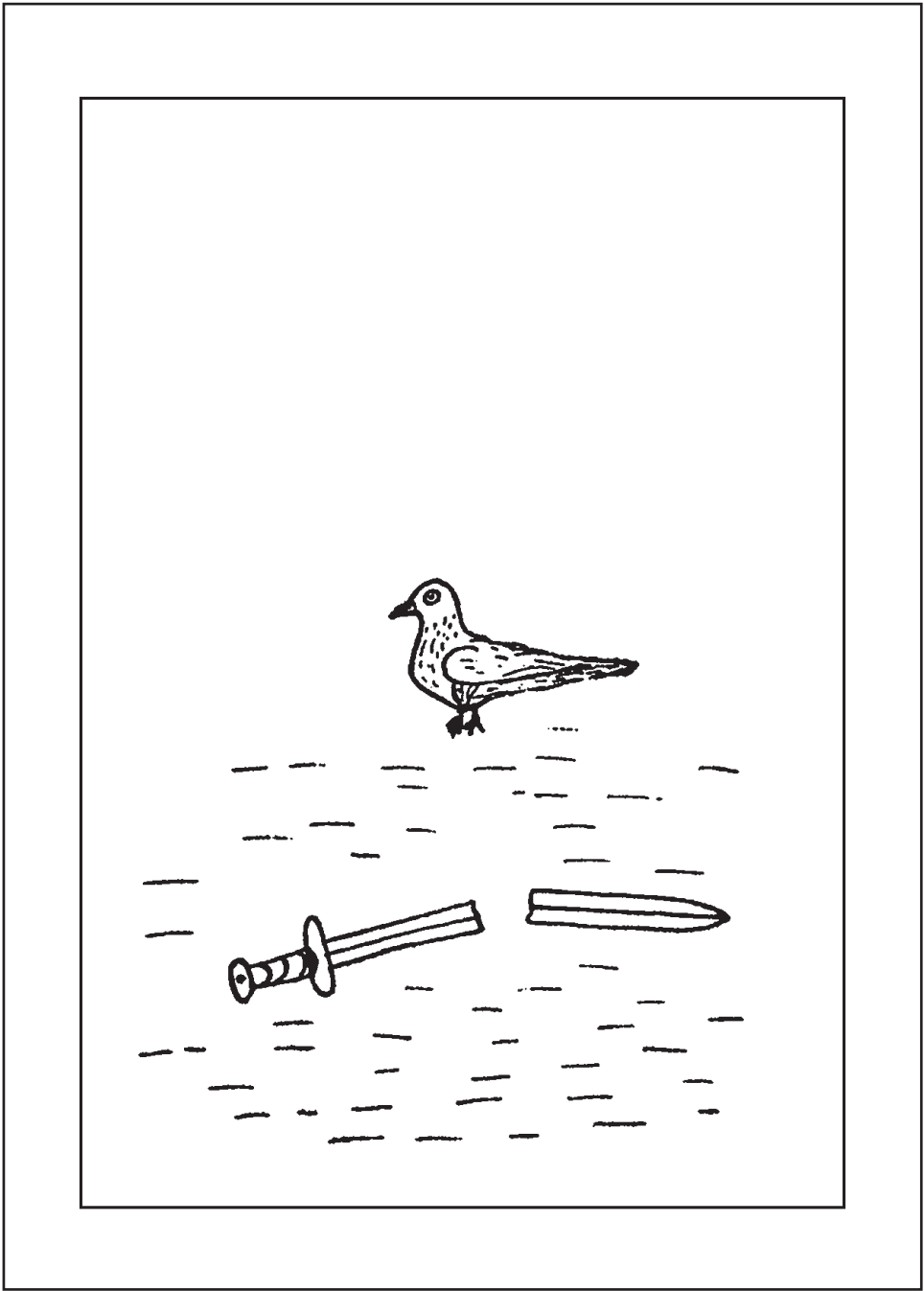

Chapter 1

The Conquest of War

COSMIC alchemy differs from each of the other six branches of alchemical science in that it seeks to transform the energies of society as a whole into those channels of action which are most beneficial to it, that most effectively assist in the highest development of its members, and that most completely cooperate toward the realization of God's Great Evolutionary Plan.

The other branches of alchemy, one and all, recognize the desirability of mankind as a whole steadily advancing toward greater perfection, and they give very definite instructions for the individual to follow in perfecting his character and abilities, and thus increasing his usefulness both to himself and to society. They also indicate to him how, for legitimate ends, he may best influence the course of actions followed by others; and they point out certain occult sciences it would be well for society to recognize and study, and certain spiritual principles that mankind would do well to understand and utilize.

But they offer no suggestion in reference to many important problems that society must face. They do not indicate, for instance, for what measures a citizen should vote when he goes to the polls. They do not advise him whether the installation of television in homes is to the best interest of the public. They do not inform him whether he should encourage or discountenance the development of automatic machinery. They shed little light on whether or not it is truly advantageous to the race for more people to gain an appreciation of the beauties and grandeur of nature, or to cultivate love of poetry, literature, music and art. If these and other things are to the detriment of the race, the spiritual individual should exert as much pressure as possible to discourage their popularity; but if they lead in the direction of real race betterment, he should work tirelessly to develop a wider and increasing interest in them. Such is the field embraced by cosmic alchemy.

Cosmic alchemy gains no support from materialism, however; for materialism cuts off from humanity all spiritual light. It denies the existence of Deity. It denies there are other forces than those physical. It denies there is an inner realm of existence. And it denies that personality survives the tomb.

It not only denies these things, but it goes to great pains to convince people that there is no evidence whatever that favors the belief of any reasonable person in any one of

these four. And some of its advocates have resorted to trickery to discredit such belief. They have made fake tests of astrology, and they have employed experts in legerdemain to make it appear that all psychic phenomena are produced by deception.

So determined are they that their authority must never be challenged that they have even tried to get laws passed which would keep people from learning about astrology and from learning about extra-sensory perception. If it is permitted that these subjects may be taught, they have argued to themselves, more and more people will try them out.

And they have succeeded in their object in so far as the radio is concerned. To quote from an article by J. Hugh Pruett, Astronomer, General Extension Division, University of Oregon, appearing in the December 11, 1945, issue of Signs of the Times:

“But Astronomers are universally intolerant toward astrologers and bitterly resent any insinuation of amity. A few years ago the American Astronomical Society, with the aid of the American Society of Magicians, persuaded the Federal Communications Commission to rule astrological broadcasts off the air. This seems almost like intolerance, yet to many of us it was a desirable move.”

To many materialists, fostering such intolerance is a desirable move. They do not want people to try out astrology for themselves; for progressed aspects prove conclusively that there are non-material energies which upset the whole scheme of materialistic philosophy. And these materialists do not want people to try out extra-sensory perception; for it enables people to contact the inner plane sufficiently that they become convinced of its existence, and often are able to gain for themselves conclusive proof that personality survives the tomb.

And through extra-sensory perception many people are able to tune in on the all-pervading intelligence of Deity and sense the general outlines of His evolutionary scheme. They thus perceive that all souls are being educated to perform a function in carrying out this universal plan, and that the more people there are on earth who make satisfactory progress, the more souls will there be who have developed some skill and obtained the knowledge which furthers them on the road to becoming effective workmen doing their own particular job in the realization of God's Great Plan.

The cosmic alchemist, therefore, rejects the idea that only the special privileged few should be permitted to enjoy such advantages as earth has to offer. Instead, he works to the end that all the people of the world should have as ample opportunity as possible to make both intellectual and spiritual progress. Such opportunity is made possible only under favorable economic, social and political conditions.

However prosperous a people may be, if religious intolerance prevails they are limited in their spiritual progress. Religious intolerance, whether it is exercised by some orthodox hierarchy or by some group of materialists, strives to keep the people from having access to facts which are incompatible to its tenets.

For instance, throughout the years 1943, 1944 and 1945 it was only through great effort and sacrifice on the part of those whose religious teachings would have been suppressed by such laws that the effort was defeated to get laws passed in California prohibiting teaching either extra-sensory perception or astrology.

These laws were framed as models later to be enacted elsewhere, and it was the expressed hope of their sponsors that the whole United States eventually could be blanketed with them. It was even suggested that the sale of literature on these subjects be prohibited. Had these efforts succeeded, people in this country would thereafter have been prevented from learning about the inner plane.

Because to make the most intellectual and spiritual progress people must have access to facts of both the inner plane and outer plane, and be permitted to live in the manner indicated by these facts, the cosmic alchemist works vigorously to enable all the people of the world to have **FREEDOM OF WORSHIP**.

A people, however, who are sadly undernourished, or a people who must toil each day until exhausted in order to keep the body alive, have too little energy left for effective study. If they cannot spare the time to get an education, or if educational facilities are unavailable, they are curtailed in their intellectual and spiritual progress even though they have freedom of religion. And if they are too poor to acquire or otherwise contact the physical things from which spiritual values can be gained, their progress is retarded.

Because to make the most intellectual and spiritual progress, people must have sustenance, must have some leisure from arduous toil, and must enjoy certain social, recreational and physical facilities, the cosmic alchemist works energetically to enable all the people of the world to have **FREEDOM FROM WANT**.

Such freedom from want can be obtained for all the people only under the most favorable political conditions. It cannot be obtained if the privileged few are permitted to exercise censorship over the views expressed by those who believe in equal opportunity for all. And it can be attained in full measure only when each individual is given opportunity to use his natural aptitudes.

Because to make the most intellectual and spiritual progress people must be permitted to select, without interference by special privilege, their own leaders, and must be permitted to use their special talents, the cosmic alchemist works strenuously to enable all the people of the world to have **FREEDOM OF EXPRESSION**.

Fear restricts activities, impairs the health, and chains the attention to images which engender a dominant vibratory rate which is too low to permit contact with the higher inner-plane levels. It thus not only hinders the development of spirituality, but it hinders clear thinking and the most satisfactory intellectual progress.

Knowledge of after-life conditions should banish the fear of death, the economic conditions of the world should be handled in such a way that abundance will banish

fear of want, and proper organization and cooperation between nations should banish the fear of war and the atomic bomb.

Because to make the most intellectual and spiritual progress people must know about after-life conditions, must not be faced with the specter of want, and must not be compelled to sacrifice time, energy or their lives to war, the cosmic alchemist works ardently to enable all the people of the world to have **FREEDOM FROM FEAR**.

Spirituality Carries a Responsibility to Society

—No truly spiritual individual can put any one of these four freedoms aside with a shrug and the platitude that he is not his brother's keeper. He should recognize that he is an intelligent cell in the body of the Cosmic Man, and that as such he has a part to play in carrying out the Divine Plan of universal progression. It is his mission to exert his energies, to the fullest extent he is capable, toward assisting other cells in the body of the Cosmic Man to develop to their highest possibilities. The deific objective calls for the fullest cooperation of all in its attainment. And every individual has a responsibility, that rightly he cannot shirk, to exert as much pressure as he is capable toward advancing the real interests of other members of society. To the extent of his abilities and opportunities each is responsible for the progress of society as a whole.

But before the individual, no matter how spiritually inclined and energetic, can be of service toward the advancement of the race, he must know what things really contribute to race advancement, and what things are detractive.

If he permits his opinions to be directed by popular vogue, or if, in the erroneous belief it is spiritual, he supports fanaticism; no matter how good his intentions, instead of assisting human progress, he is a hindrance, and often a nuisance besides. Our popular reformers, no doubt, find great self-satisfaction; but more often than not, in their ignorance both of human nature and of what constitutes real welfare, they make a sorry muddle of their own and other people's lives.

Before we can advance the interests of the race through publicly and privately advocating right measures, through the ballot box, and through personal example, we must know what things rightly may be expected to benefit society. It is the province of cosmic alchemy to supply this information.

Experiment Rather than Theories Needed

—Of some things, without further investigation and discussion it can be said that they are beneficial to the race, or that they are not beneficial. But of other things, because they are as yet so incompletely understood, or because their influence under one set of circumstances is quite different than under other conditions, no such flat statement should be made. About these things it is better to make judgment provisional upon additional experience.

Take, as an example, the form of government best adapted to human progress. It is probable that a form quite suitable for a nation at one period of its development is equally unsuitable at another period. And it is probable that a form that is successful with one race of people, because of cultural and temperamental differences, may with another people prove a rank failure. Nor is it likely that any group of individuals is so wise that it can foresee all the contingencies that would arise from the adoption of a system not as yet thoroughly tried.

Such wisdom is not expected in the world of mechanics; for even Edison remarked how unusual it was for an invention, or new device, to perform at first trial as the originator had been led to expect. So seldom does it do so that Edison said he was always suspicious of anything that worked according to the original plan. Nearly every one of his more than a thousand inventions had to be brought into final working condition through the method of trial and error. At first it was defective; but constant application to finding the cause and remedy for these defects at last brought it to a state of final utility.

Whether we interest ourselves in mathematics, in chemistry, in biology, or in other sciences or professions, we find with each that in its application, unless they have been modified from their original form through observing the effects in actual operation that fine spun theories fail to get the expected results in their practical application. Why then, if the human mind in its capacity to predict by reason alone in all other fields is known to be so fallible, should we expect it to perform with perfect precision in predicting the effect upon human conduct of some untried political system? Did those, for instance who forced prohibition on the United States in 1919 anticipate that it would be followed by far the greatest crime wave the country had ever had? Does anyone actually know whether there is more graft and corruption under private ownership or under government ownership?

It seems to me that it is far better to admit that as yet we do not know enough about the practical workings of certain advocated changes to be sure just how they would result. This does not mean that they should be rejected; but that they should be subjected to experiment as well as further study. In time, if we try them out experimentally, we will have definite and accurate information as to their practical value.

Thus the boundary line of conjecture recedes, and that of knowledge equally advances, as human experience widens. That which once was supposed to be an impenetrable morass yields to man's ingenuity, has its bogs and sink-holes sign-boarded, and a trail through found that offers firm footing to human feet. But beyond the frontier reached by this safe road there always lies other uncertain ground. Should we completely shun this, saying that mankind has traveled sufficiently far, and that we should leave good enough alone? Or should we, after mapping a theoretical path, leave firm footing and plunge ahead on this speculative route, to survive or perish as our theories are correct or false?

I think the example of the chemist, the physicist and the inventor can help us here. They never rest content with present accomplishment. If they did mankind would enjoy far fewer conveniences. But neither do they risk their all on untried theories.

Instead, they devise means by which in some manner their theories may be tested experimentally on a small scale.

The chemist, devising a formula to make some new substance, does not at once sell stock and build a huge plant for its manufacture. Not if he is a successful chemist. He first tries out his process on a very small and inexpensive scale. Usually, at this first trial, it does not work as expected; but not having exhausted his financial resources, he makes one change after another in the process until finally it works as desired. Then, and then only, does he risk his all on a plant. So also the physicist, before risking his theoretical calculations of stress and strain resistances of materials, devises experiments that in a small way demonstrate the degree of accuracy attained. Only after the practical application of his calculations have been put to the test in various lesser ways does he turn them over to engineers as safe tables to follow in the construction of vast dams, huge skyscrapers, and impressive bridges.

The most important problem facing the world today is how to provide that all the people of the world shall be able to enjoy freedom from want, freedom from fear, freedom of expression and freedom of religion. The attainment of these freedoms seem, logically enough, to be the next great strides in race development. If anything needs doing on a world scale, one might think from the brief summary previously given, it is the attainment of these freedoms. Yet before discussing possible means to such ends we first should be sure that they would actually conduce to human progress. And as war is so potent a cause of fear, let us give it first consideration.

Origin of War

—Biologically war is the transference toward members of one's own species of an impulse as old as life itself. All creatures have natural enemies from which they must escape, or escape being impossible that they must destroy if they are to survive. As a general thing the ability to fight is a prime requisite either in a race or in an individual. Those not possessing it usually perish.

Even among the members of a species, those possessing unusual ability to destroy their opponents are commonly most favored. The strongest wild stallions whip the others and gather to their leadership and protection the most mares. Thus few colts, in the wild state, are sired by weaklings. The most powerful bulls, the strongest stags, the most pugnacious cocks, are fathers of the most offspring. And even among monogamous animals, those skilled in combat hold the safest retreats and gain the choicest supply of food. By virtue of these advantages the strong, the courageous, the skillful and the cunning more often live to reproduce themselves, to pass these attributes on to their progeny.

Man, emerging from bestiality, also found it advantageous to be a good fighter. He was surrounded by predatory creatures that were a constant menace to his existence, and he must destroy them to survive. As family expanded into community, and community enlarged into tribe, and tribes banded together as a nation, the effectiveness of concerted action against an enemy became apparent. And because, as yet, large groups of men had not learned how to cooperate with each other to the mutual advantage of all, there was rivalry for choice of habitat and food supply. Even when society had progressed to a point where it no longer tolerated the settling of personal differences through the slaughter of one individual by another, it still glorified the slaughter of the enemy in the prosecution of war.

At a time when war was largely a matter of personal combat, unusual skill and strength tended to prolong the lives of the hardy and valorous. Sagacity and alertness also permitted escape from a too numerous enemy. Such qualities, because they aided the survival of the individual, were perpetuated in the children, and contributed to the development of such qualities by the group.

The Survival of Weakest

—But exactly the reverse was true in World War I and World War II Strength and courage and keen intelligence were attributes that spelled almost certain doom to any individual. The first to reach the modern battlefield are the flower of the land. As call after call for additional troops arrive, finally defectives are all that remain. Nor does the strength and intelligence and courage of those who go prevent their extinction. Against machines and chemicals and atomic energy the strong perish as quickly as the weak.

Political affiliations of chance or design are of more importance today than the individual ability of the soldier. And scientific developments that can be utilized to wipe out a large part of the population of a whole nation in a single night before they are aware an attack is contemplated, are possibly more important still. This state of affairs may encourage political adroitness, and it may encourage scientific discovery, but it does not save the life of the fighter. The ten million men who fought and died in World War 1, and the greater number who fought and died in World War II were not inferior to those who stayed at home. They were the best examples of health, strength, intelligence and ability the world could provide. Did they live to

perpetuate these sterling qualities? Not so I And the race as a whole is sadly weakened by their loss.

Nor is it likely that the over-all picture would be changed by the use in war of the binding energy of the atom. Civilian populations would be wiped out, it is true; but those who would do the fighting, and who also would die in great number, would be the most capable men and women that could be found. Nor would there be any guarantee that the nation making the most scientific progress would survive; for the discoveries of its scientists no doubt would be used by any ruthless and barbaric aggressor group seeking world domination.

But, after all, is it desirable that more than a few of the most intelligent, strong and courageous should survive? Just before each of the first two world wars a philosophy was popularized in the aggressor nations that found no place for compassion, that looked upon morality as weakness, and that exalted ruthless selfishness to the throne of superman. It advocated that the strong should climb the hill of progress by trampling under foot the bodies of the weak. The masses were to be but cattle to do the work of their overlords, to be housed and clothed only because of their usefulness, to be educated only sufficiently to be good servants, but not enough to make them dangerous rivals. Thus, it was taught, the superman would rise above mercy, would have no morals but his own ambition, and would develop courage, strength, cunning and leadership to the end of vanquishing his enemies and dominating a servile human race.

In such a materialistic scheme the only important thing is victory. If it enables the more cultured few to survive and propagate their offspring, and thus perpetuate the race of overlords, what matter that tens of millions of the world's finest perish on the field of battle? Their only usefulness, according to this culmination of materialistic philosophy, is to do the work and fight the battles that give more power to their masters. And if some of the masters also perish in the fight, that is the chance the masters must take. It is their job, at any cost to themselves and others, to be victorious.

Yet in its application such a philosophy would yield only a temporary and material advantage to these devilish supermen. Unless skill, originality, initiative and intelligence are encountered among those who do the work of the world, that work becomes shoddy. A man who is intelligent enough to make a valuable discovery in chemistry, in physics, or in astronomy, is intelligent enough to plan means to end serfdom. A man who is engineer enough to construct bridges, aqueducts and skyscrapers, is capable of engineering the downfall of oppressors. The inventor who has the ability to construct a new device is not so lacking in ingenuity that he fails to invent a way to gain freedom.

The things that add to human comfort and prolong life do not originate in the minds of ruthless military or political leaders. Without the development of high intelligence and skill among the masses those things upon which progress depends would not be forthcoming. Almost every family today possesses conveniences that were not even dreamed of by royalty a few generations ago. Yet the same intelligence that brought the motor car and the radio is the intelligence that found a way to decrease the power of aristocracy.

We cannot cut off one end of a stick and have a stick possessing only a single end left. Nor can any group of men decrease the welfare of other large groups of men without, after a time, finding themselves less advantageously situated.

World Advance Depends Upon the Progress of All Men

—The world needs leaders to be sure, just as it needs various other types of ability. But leadership alone is unavailing. In addition to competent leadership and organization, to travel far there must be the cooperative effort of highly trained specialists. Competition between business firms has demonstrated this. Intelligence, initiative, skill, loyalty to the concern, and friendly cooperation are the outstanding qualities of the individual working for the most successful institutions.

Such institutions prosper and advance beyond their competitors by encouraging the development of the utmost in ability, and affording ability opportunity to work. The world also is just an institution, only on a larger scale. As yet a vast number of its individuals are ignorant, unskilled and incompetent. But give them proper training along the lines of their natural aptitudes as revealed by their charts of birth, encourage the use of the abilities thus developed, raise the level of intelligence, and the whole organization is benefited. Every backward person in a business slows its pace, and every undeveloped person in the world retards its progress. Those at the top can reach only so high as standing on the shoulders of others permits, and if these shoulders are low, so is the highest reach.

Einstein, with his theories, is valuable to the world only because there are others who sufficiently understand them to put them to practical use. Excellence in authorship is encouraged because there is a reading public sufficiently educated to appreciate better writing. Better music, better art, better movies, better television, will be forthcoming when the people have developed a taste demanding them. Thus do those of exceptional ability stand on the shoulders of the masses, and without such support their efforts prove futile.

From our standpoint as cosmic alchemists, therefore, we view the world as one big organization of workers in which the success of the organization depends upon the development to his highest possibilities of every person, and upon the opportunity to exercise his full abilities. World progress depends upon the advancement of all people.

War Breaks Conservatism

—Due to a peculiar conservatism of the human mind this advancement in the past often has been hastened by war; and in some directions, notably in the perfection of chemical substitutes for natural resources that may be lacking, and in the invention of engines of destruction, war acts as an accelerator even today. But because chemistry and invention are already far ahead of economic organization and social control, to hasten their further development through the agency of war is to pay for these things that are not vitally needed now the enormous price of destruction of the most treasured possessions of society.

Among primitive peoples living today, however, and among those of the past in so far as their records reveal, we find a condition well illustrated in the migratory flight of birds. In more ancient times there were rivers and lakes where none now exist, and various natural barriers that long since have disappeared. But the birds in that time in their flight were compelled to detour to avoid the barriers, and to gain more ample food supply followed the streams. Thus were migratory routes established; much as human beings become accustomed to do something in a particular way. Yet in the long course of time streams dried up and mountains were leveled. Nevertheless, the birds still keep to the customs established by their ancestors. They follow the course of streams that no longer exist and dodge what once were highlands but now are level plains.

And thus it is in primitive society. Whether it is the making of an arrow, the painting of a piece of pottery, the building of a home, or the manner of wearing the hair; once a custom is established it tends to remain. Even the simplest matter of household routine, because of custom, takes on religious significance. Among those more highly organized, penalties are prescribed for anyone so injudicious as to depart from the established methods; and among those with no centralized authority for enforcing the will of the group, the individual who thus Haunts the sacredness of group tradition is promptly ostracized. No one speaks to him, no one gives or trades him food, no one extends him succor in sickness, no one even recognizes him as having existence until he retracts in suitable manner and returns to the methods prescribed by his ancestors.

Nor is this slavery to habit confined to primitive peoples of the present and the past. It stands today, even among the foremost nations, as the greatest single obstacle to racial progress. Because we are all too apt to think this tendency to crystallize has been routed, let us consider a few rather modern examples. They appear ridiculous today because the innovation that then seemed such a menace has now become the accepted custom. Yet innumerable things are opposed today on quite as flimsy grounds, and the arguments so seriously advanced against them now will seem just as ridiculous tomorrow.

The use of anesthetics in surgery, for instance, was stoutly condemned at the time of its introduction. It was held immoral, to be in violation of God's holy ordinances. God had decreed that man should suffer, and to lessen this suffering by artificial means was held to be sinful. Only after a struggle was the opposition gradually worn away. And even now similar arguments are advanced with considerable success against contra conception and against modern painless methods of childbirth.

Quite as vigorous an opposition arose to the introduction of the bath tub in America. A great controversy ensued, and an ordinance was passed in at least one large city against the use of this newfangled idea of cleanliness. It threatened, for a time, to become a political issue, but was finally elbowed to one side by other matters. Almost everyone is aware of the struggle necessary to introduce the telephone, and the fight that developed against the use of the steam engine. The British Admiralty went so far in 1804 as to declare it their duty to discourage the use of steam vessels, because the introduction of such vessels was calculated to strike a fatal blow to the naval supremacy of the Empire. (Energy of the New World, by Slosson.)

About the same time there was a vigorous opposition to the use of coal as fuel, and Colonel George Shoemaker was threatened with arrest for endeavoring to sell a few wagon loads of it in Philadelphia. Going back still further, we find that in 1306 King Edward I issued a proclamation making the use of coal as fuel in London a capital offense, and for this crime one man was executed. (Energy of the New World, by Slosson.)

Usually whatever has been sanctioned by custom, however inadequate it may be, is defended upon religious grounds. Not to draw down displeasure of the gods, primitive man must dress in a particular fashion and use only certain weapons in the chase; or if he had arrived at the agricultural stage, he must plant his crops and tend them only with tools such as were used by his forefathers. One more example, quoted from Energy of the New World, by Slosson, this time giving the arguments in detail, will suffice to show this at all times numbing influence of conservatism:

“A German paper, in 1816 (Koelnische Zeitung, March 28) condemned the project of street lighting on six points: (1) Theological, as blasphemous, since God had divided the light from the darkness; (2) Judicial, people should not be compelled to pay for gas they do not want; (3) Medical, the emanations were injurious to health, and people would stay out late and catch cold; (4) Moral, the fear of darkness would vanish, and crime would increase; (5) Police, the street lights would frighten horses and embolden thieves; (6) Economical, great sums would be sent to foreign countries.”

Such great pressure is brought to bear in support of ancient customs that races often live side by side in almost daily contact without adopting conveniences and better methods from each other. Such being the nature of the human mind, marked steps in progress often are taken only as a last resort in dire extremity. Such a situation has frequently been furnished by war.

A people threatened with extermination at the hands of an enemy will grasp desperately at any means that offers hope of survival. When greatly outnumbered and thus sure to be defeated if they use only the old war-club, they will take the only chance left open and use the new-fangled bow and arrow just invented by some young radical. Slaying their opponents at a distance, living through the agency of this new contraption, they retain it as a part of their equipment henceforth. Or, faced with starvation due to siege, one more adventurous than the rest tries out a vegetable that hitherto has been considered inedible. He does not die as expected, so others try it, and thus it becomes after a time a staple of food. Harassed by enemies, with their lives in constant danger, even better tools are developed; for there is the necessity to make things in haste, and no opportunity to indulge the taste for precedent and decorum.

In time of war, or in time of other great crisis, civilized peoples often bring about changes quickly, both for good and for ill, that otherwise would be held back a hundred years. The abolition of slavery at the time of the Civil War, the introduction of nation-wide prohibition made possible by World War I, and the utilization of atomic energy during World War II are examples in the history of America. It is probable also that both chemistry and aviation were advanced at least half a century of their normal development during World War I, and that radar and the use of plastics made equal strides during World War II.

But for these advances we have paid far too great a price. The brutalizing effect alone, to say nothing of the lives lost, the maimed and diseased, and the loss of vigor to coming generations, far outweigh any chemical or mechanical advantage.

Once the Greek city-states were the glory and the envy of the world. Yet in spite of their magnificent culture, these city-states, led by Sparta on one hand and by Athens on the other, so weakened themselves in warfare with each other that within a little over one hundred years after the repulsion of Persia they could offer almost no resistance to Macedonia. The fragments were gathered in with little adieu by Phillip and Alexander.

Today, aviation and radio have brought the nations of the world as closely together as were those little warlike Greek city-states. And because the world is capable of producing and distributing abundance for all, there is no more real need for war than there was for those little Greek city-states to decimate each other.

With the production of atomic bombs, we have reached a point in the development of mankind where we must divert our aggressiveness, initiative and ingenuity into constructive channels if the race is to escape extinction. The wars of the future must be against disease and other obstacles to human progress and happiness. Never before has there been such opportunity to exercise talent for human betterment. And the most valuable talent of all just now is that which can unite the nations of the world into a cooperative whole.

The amalgamation of business concerns has reduced duplication of effort, effected economies in management, and increased total output, thus benefiting both business and the buying public. The difficulties in the way of forming such combines have often seemed insuperable. Traditional jealousies and hatreds have had to be overcome. It is the outstanding business achievement of the last half century that these difficulties have been surmounted.

Likewise among nations, there are bitter feuds, temperamental dislikes, suspicions, and hereditary animosities. To draw them into one great cooperative organization is a Herculean task. Yet it must be accomplished. It is the only way to preserve and foster civilization. And the advantages to be gained by all are so tremendous as well to repay every possible effort.

Nor do I minimize the importance of competition. Unity and peace have their dangers. When Babylonia, Egypt, and the Roman Empire had for some time attained immunity from their neighbors, there set in a species of dry rot in each that corrupted their institutions and led to downfall. But these were absolute monarchies, imposing their will, by means of adequate standing armies, upon their subjects. The independence and initiative of the subject peoples were crushed out. In a world of cooperative peoples, however, it would not be difficult to encourage competition among individuals and among races, even as modern business encourages competition among its employees and among departments, to devise and develop ideas and things that are beneficial to the whole organization.

To Conquer War

—It would seem that the only practical manner in which to attain this world-wide unity and freedom from wars is through a United Nations Organization. The peoples of the world at present have customs so different, and the education they have received is so unequal in different areas, that at first the authority of the United Nations Organization will need to be limited to certain essential functions.

First of all it must have at its command a military force of sufficient power to impose its will on any nation, or any likely group of nations that otherwise might go to war. This military force, at all times under the command of the United Nations Organization, would perform for the world the duties of the police force of a city. It would simply be a law enforcement agency. And to be effective, it must have its units so deployed, and possessed of such powerful weapons, that any nation or likely group of nations would realize it would be suicide to make a sneak sudden attack on any other nation. It must possess the power and be given the duty of preventing war in any section of the globe.

And even as in a city or nation there are secret police whose activities help prevent crime and apprehend criminals, so must the United Nations Organization have under its direction investigators with authority to examine activities in all countries of the world and reveal the production of such destructive weapons as are forbidden to be

produced by any nation, but which may be produced and owned only by the military force of the United Nations Organization.

When, through the competition of other nations a nation finds itself deprived of access to materials on which its very life depends, it goes to war. And the foreign policies of some country or group of countries may work other unbearable hardships on the peoples of some land, Therefore, even at start, the United Nations Organization should have the authority to regulate the foreign policies of all countries in the world.

As the present backward peoples of the world gain in education and experience in self-government, the governing functions of the United Nations Organization should gradually be increased. National sovereignty in certain matters other than foreign policy, armament and the making of war, should then gradually be relinquished in favor of the authority of the United Nations Organization, even as certain state rights were gradually relinquished to the Federal Government when the 13 colonies banded together to form the United States of America.

As time passes, the nations of the world, while retaining the independence possessed by the various states within the USA, should permit the United Nations Organization to exercise much the same function in world affairs that at present the Federal Government exercises in the affairs of these United States. This not only will abolish war and increase the prosperity of all, but will provide the machinery through which any nation can seek just treatment from any other nation or group of nations without going to war. There will be no more incentive or opportunity for one nation to go to war with another than there is for one of our 48 states to go to war with another of these states.

The United States of America affords a working model that long has passed the experimental stage It worked. But in building a world organization following a similar pattern new and serious problems are sure to arise. These problems must be faced and solved as they appear. It is not necessary that they all be solved now. But the cosmic alchemist knows what the initial step must be to prevent much of mankind being exterminated by the tremendous power of present-day weapons of war, and he knows toward what ultimate goal the peoples of the world should be working.

In spite of leaving the details to be worked out step at a time, he knows what kind of a world he wants. And he realizes that the only way to build such a world is first to create a public sentiment favoring it. When public sentiment throughout the world is insistent enough, leaders will be chosen who have the skill to build a cooperative world organization.

Long before a world can be built in which there will be freedom from want, freedom from fear, freedom of expression and freedom of worship, and long before a world organization can be constructed in which specialization of parts, division of labor and effective cooperation between the parts contribute to man's physical, intellectual and spiritual progress, an organization can be formed to perform the essential functions necessary to prevent further wars.

But such an organization, or one providing still greater benefits, can only be constructed if there is sufficient public sentiment throughout the world favoring it. If public sentiment is strong enough, leaders will be found and selected with sufficient skill to form and handle such a United Nations Organization. Therefore, the cosmic alchemist works with unflagging zeal to create a worldwide sentiment for a United Nations Organization that can and will abolish war.

Chapter 2

Serial No. 165
Original Copyright 1946
Elbert Benjamine

Copyright
August 2002
Church of Light

The Abolition of Poverty

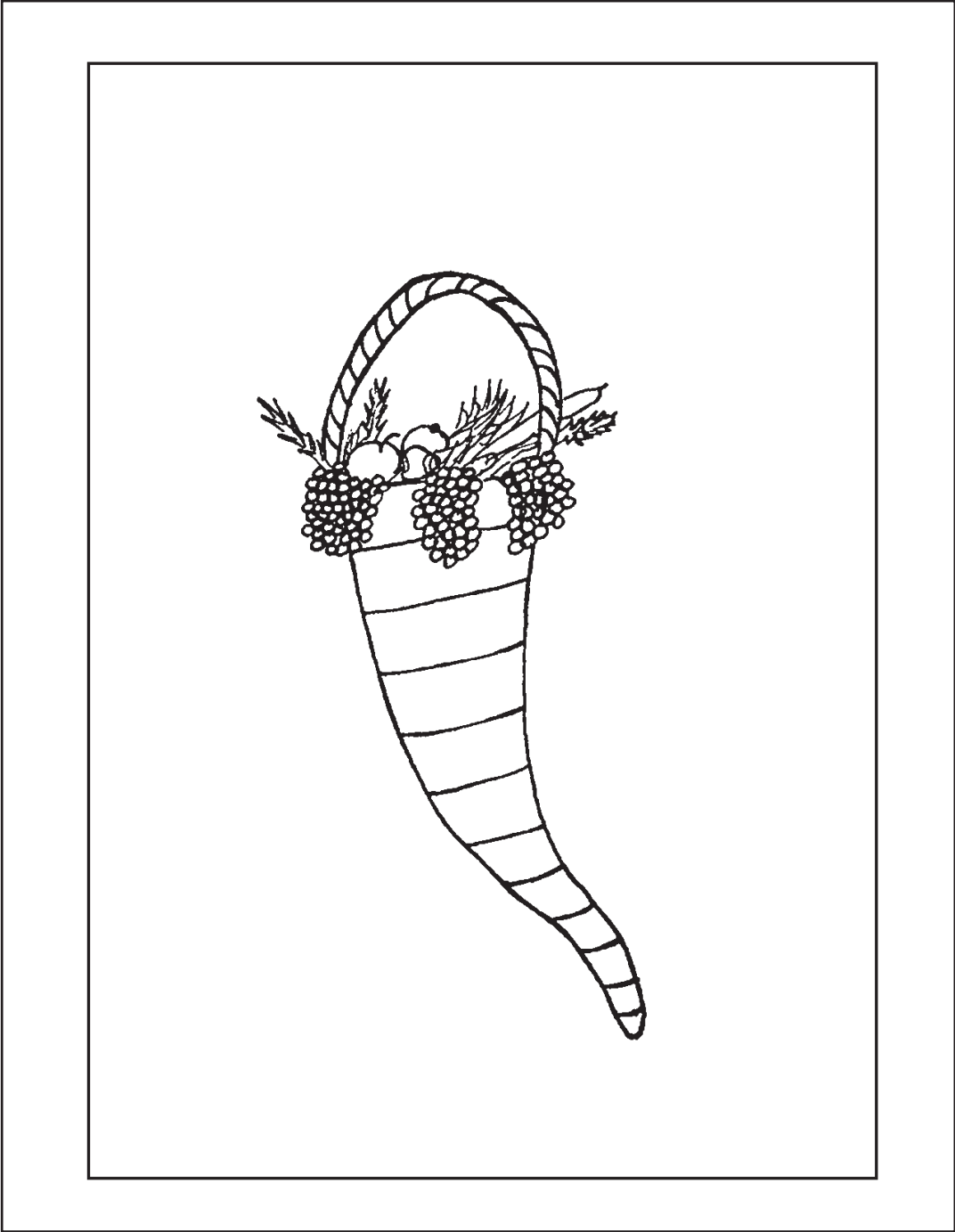

Chapter 2

The Abolition of Poverty

THE cosmic alchemist, almost as soon as he has decided to cooperate to the fullest extent in carrying out the Divine Plan, is abruptly halted by the wall of economic want. The easiest course for the ordinary man is for him personally to get over or around it as best he can, and then hope that others also will be able to pass it without his assistance. But the cosmic alchemist cannot do this; for as such he has taken upon himself the responsibility of assisting the advancement of all other members of the cosmos, and particularly, because he understands them better, the advancement of the members of the human race. It is, therefore, an essential part of his work to assist others to pass the economic barrier and to enable all the people of the world to have **FREEDOM FROM WANT**.

Yet even as we previously discussed the benefits and detractions of war, so also before discussing possible means to attain freedom from want let us first be sure it would actually aid intellectual and spiritual progress.

It is undoubtedly true, as explained in detail in Course 3, *Spiritual Alchemy*, that any and every situation offers opportunity for creating spiritual values. But he is only the rare individual, who has already made enough progress to become skilled in spiritual alchemy, who is able to convert privation into strength of character. And even he may not rise to what otherwise would be possible in the refinement of his conceptions, the exaltation of his emotions, and the elevation of his works through lack of adequate leisure for meditation, and through inability to contact the thoughts and works of others.

Whatever is spiritual in this earthly life rests firmly upon an adequate physical foundation. Doctrines emanating from the Orient tend to discountenance this; but in spite of theoretically spurning material things, their most saintly men are dependent upon things physical. Even the Lord Buddha had to have leisure in which to think. He deserted his wife and child with a clear conscience because he felt assured their material needs would be provided. But if, instead of sitting seven years under a banyan tree, he had supported his family by the arduous long hours of toil customary to his less prosperous countrymen, it is doubtful if he should have had enough energy left for much thought of any kind, let alone the protracted clear thinking and extension of consciousness that led to illumination.

According to tradition, he consumed very little food. But even the single grain of rice a day had to be raised by someone's toil, and brought to him at the expense of other labor. Someone, likewise, raised the grain that Jesus allowed His disciples to pluck and eat as they passed the field, and about which there was so much disturbance because it was plucked on a Sabbath.

No one should object either to the Nazarene's corn or to Buddha's rice, as both rendered to society infinitely more than they took. They were specialists, each doing a valuable work, and it was quite proper, on the plan of division of labor, that they should share in the fruits of the work of others. The point is that each required physical sustenance both before and after commencing his life work, and that while preparing for this work there seems to have been freedom from unduly severe, grinding, heartbreaking toil.

Furthermore, if we scan the periods of history closely in which the advancement of man is recognized to have been most marked, we find without exception — Egypt, Babylon, Greece, Rome — that these were times in which there was a rather large leisure class. Freedom from constant drudgery gave this class the opportunity to develop philosophy, literature, music, art, astrology, alchemy and the social niceties. But when this leisure class fell, in each instance there followed a period of stagnation; for the common people had not gained enough leisure to develop an appreciation of cultural advantages.

From these and numerous other considerations it seems clear that through affording more leisure, not merely to a special class, but to all the people of the globe, industrial development may be made a means to intellectual and spiritual advancement. Those thus freed from too long hours of numbing labor may, or may not, take advantage of the time so gained to advance themselves. It is not compulsory, but there is opportunity. Anything, therefore, that lightens the labor and shortens the hours that man must devote to gaining a livelihood is certainly beneficial to the race.

It may be objected that man can live without a multitude of the things by which he now surrounds himself. This is undoubtedly true; but the quality of life would not be the same. To understand and make use of these things require considerable skill and intelligence. They thus afford an incentive to mental development. Contact with any of them enlarges the vision by that much, and adds something to the sum of the individual's knowledge. Still others are more directly and intensively educative. The auto, through popularizing travel, the radio and press through the information they bring, and the movies through familiarizing the people of each nation with the customs and living conditions of each other country of the globe, are tremendous engines of enlightenment.

Yet gain of information is but a single side of human progress. Another and equally important side is emotional appreciation. If, as students of ancient art infer, because their literature contains no words for such colors, the Greeks were unable to see the orchid shades, they missed something in their emotional experiences that adds richness to present-day life. Even the multifarious and seemingly useless gadgets

that are manufactured to entice the buyer to part with his money must appeal to some human want to find a sale. Such as add to man's comfort or afford him recreation increase his ability to work and think efficiently. Such as afford non-destructive pleasures, through building thoughts into harmonious combination within his astral form enable him to render better service to himself and to humanity. And those that appeal to him through their beauty tend to refine his emotional nature, and thus contribute to his spirituality.

New things are being invented every day. More and more things are coming into use. There is danger, therefore, that people will so burden themselves with variety of possessions that their time and energy will be consumed in caring for them. But the penalty of 211 advance is the opportunity to use it for destruction as well as for construction. Every gain in knowledge gives man more power to injure others. Every mechanical invention can be put to some subversive use. So, likewise, an ever increasing abundance of material things is not without its dangers. But with this, as with other steps in progress, real gain implies discrimination.

The opportunity for the individual to select those things his development needs increases with the number of material objects available. Just because his neighbor has a car, a radio and a new-fangled ultraviolet lamp, he is under no compulsion to own them. He may prefer a comfortable and quiet library; where he can read and meditate at length, or the apparatus with which to carry out original scientific experiments.

We may be sure of this, that whatever continues to be made appeals to some human want. If it is detrimental, experience with it will make this evident. If not, it serves a purpose in man's welfare. Too many possessions may encumber the individual; but only by having the largest assortment from which to choose can those most suitable to individual progress be selected. We should not, then, discourage the production of material things. On the contrary, as cosmic alchemists, we should encourage production and invention, not only of those things which save labor, but also of those that conduce to man's pleasure, to his convenience, and to the development of his finer tastes and more exalted emotions.

From this viewpoint, work is for the purpose of providing people with the things they want. Yet there are those who seem to take the view that one of the main objects of society should be to keep everyone employed. That is, they seem to think employment is an end in itself, instead of a means to an end.

As frequently takes place, suppose a machine is invented that may be operated by one man that does the work previously performed by ten men. Some would have it that such a machine is a disadvantage to society because it throws nine men out of employment. Yet if we hold the view that the object of industrial work is the production of things to satisfy human wants, there is no loss to society even should the nine men remain idle, because just as much in the way of goods is produced to satisfy human wants.

But as it actually operates, the nine men thus thrown out of employment do not remain idle. They are really freed from the work previously performed so that their energies may be devoted either to their own cultural development, or to producing other things to satisfy human wants. Every machine or device, therefore, which lessens the amount of human labor necessary to produce something used by mankind is an advantage to humanity and its use should be encouraged. It liberates human energy that may advantageously be applied in some other direction. But any effort to enslave human energy needlessly, by using more human labor to accomplish a task that can be done with less, should be discouraged. The effort of human industry should be to produce as much to satisfy human wants as possible with the lowest consumption of human time and strength.

Civilization Measured by Surpluses of Energy and Materials

—There is now the promise that the binding energy of the atom may become available for industrial use. If this promise is realized, energies will become available which if used for that purpose, rather than to give special privilege still further selfish advantages, will quickly free the people of the world from want. For that matter, as production and distribution during World War II amply demonstrated, even without atomic power there is enough energy available to provide freedom from want in a properly organized world economy. But let us review the part surplus energy has played in the development of civilization.

Before the time of the building of the great pyramids of Egypt, it is believed that man made almost no use of mechanical forces, work animals or slaves. He had, therefore, at his command almost no energy other than his own. As a consequence, progress was very slow. There was too little surplus in the way of either time or accumulated goods. The people of this early day were able to carry only the heavy burden of economic necessity.

It was the habit, at that time, to put a vanquished enemy to death. But later certain peoples found that they could retain some of those conquered and force them into service doing menial work. These were slaves. An individual having one such slave found himself with double the energy at his command that he had before. This gave him some leisure either to think or to produce goods that previously he had been compelled to do without.

In time, also, animals were domesticated and pressed into service. The burdens of their masters, to the extent they were capable of assuming them, were shifted to their backs. This released still more human energy to be used in other enterprises. Only as man made available for his own uses the energies of other creatures or other things did civilization advance.

Egypt, Babylon, Greece and Rome each moved forward by these steps while adjacent nations, failing to take advantage of such additional energies, remained in primitive stagnation. Historians believe that each of these nations at times had available for each freeman the energy of one human slave plus combined animal and mechanical energy equivalent to still another slave. Is it any wonder, then, that the people of these nations, each freeman with the energy of two slaves at his command, should forge ahead of other peoples with no additional energy supply?

Another group also made unusual progress, not so much through the steps mentioned as through appropriating from peoples who had taken these steps. Moses found ready at hand a culture and material surpluses built up by the Egyptians. And when the Jews were in captivity in Babylon they also made great strides; because they were able to borrow from the culture of their captors, and because the material surpluses ready at hand afforded them sufficient leisure to develop a written literature. The Jews were able to make a remarkable advance then, and seem to continue to make advance through the same means, by availing themselves of the surpluses of other peoples who have developed some additional supply of energy.

Starting with the ancient civilizations that made some advance through each man having additional energy at his command the equivalent of his own, then taking Egypt, Babylon, Greece and Rome at the height of their ancient power when each freeman had at his command energy the equivalent of two slaves it could be shown, step by step, how what we term civilization advanced through the centuries in proportion to the energy available. This would take us through feudalism and the early development of the present machine age.

Here we might pause an instant at a census at the close of the Civil War, after human slavery had been abolished in the United States. This census of 1869 reveals that the combined power of draft animals and machines gave to each man, woman and child in the U. S. on the average, an additional energy supply the equivalent of 12 slaves. That is, the additional energy available for productive purposes was six times as great as that of the ancient civilizations at their height.

Yet since the Civil War the amount of energy made available to man has increased amazingly, the 1930 Census indicating that at that time there was serviceable energy of 853,015,755 horse power in the U. S., which works out as the equivalent of 177 slaves for every person in the country. The greatest source of power at that time was the automobile, next came the locomotives, then manufacturing plants, with central power stations fourth on the list, and horses and mules taken together constituting a poor fifth. It will be seen, therefore, that the burden of labor has not only been lifted from the backs of slaves, but is rapidly being lifted also from domestic animals.

Statistics are not yet available as to the amount of additional energy supply that was used during World War II. But in the U. S. it was far more than the equivalent of 177 slaves for every person in the land, and it was ample throughout the globe that had it been so used it could have afforded every person on earth freedom from want.

We know from the success of the effort to produce for war that, even without atomic energy which promises so much, the people of the world are quite capable of turning out sufficient foods and goods that no person anywhere need suffer privation. Freedom from want actually can be a reality for every person in the world if the people and the nations will but cooperate sufficiently in the effort to banish want.

Surveys of the natural resources of the world and the aptitudes of its manpower, and how these resources and aptitudes best can be utilized for the benefit of the people of the world so that all may enjoy physical and educational advantages is not beyond the ability of present-day engineers. Technical experts are available who could without much delay blueprint such a plan of effective world production and distribution. The great problem is to induce people to abandon their desire for selfish advantage sufficiently that they will permit such a plan to be put into operation.

Opportunity for Full Employment is Essential

—Freedom from want requires abundant production and adequate distribution. The greater the amount of production to supply human needs the nearer does freedom from want approach. Utilizing new energies, improved machinery and better management can produce more for each man-hour employed. But in addition to these generally recognized methods of increasing output, production probably would be doubled if each person were placed, not in the job chance forces him into, but in the job where he has most opportunity to exercise his natural aptitudes.

There is an unpardonable loss of production through people trying to do work, or engaging in business, for which either they have no talent or in which, due to the inharmonious organization of certain thought-cells within their finer bodies, they are just unlucky through continually encountering unfortunate events.

The birth chart shows unerringly both the natural aptitudes and the environment within which these aptitudes can be employed that will result in the attraction of fortunate events. Taken with the training and experience of the individual, the birth chart indicates the kind of job or the business in which each individual will be most efficient and content. Thus placing each individual where he can best exercise his talents is an important step toward freedom from want.

But whatever talents he possesses, he is unproductive during periods of idleness. The nation and the world is deprived of wealth that otherwise would be produced for every day an individual seeking work is unable to find employment. Strikes, lockouts, and economic conditions that result in unemployment deprive people of products or services they otherwise might have enjoyed.

Furthermore, any system which permits either raw materials or the machinery of production to fall under the control of a special privilege group which, for the sake of larger profits, curtails production and causes unemployment, is a detriment to the nation and a detriment to the world. It deprives people of the things they want and which otherwise they could have.

Full employment is essential to abundant production not merely from the standpoint of output, but also to enable employment to continue. That which is produced by one group must be exchanged for that which is produced by another group. And if the other group is idle, and has nothing to exchange, the first group has no incentive for further production.

It is said the Khufu, or Cheops, employed 100,000 men during the three months of the year that the population otherwise would have been idle due to their farms being flooded by the Nile. It took him three years to build the road over which the stone was hauled, and another 20 years to build the Great Pyramid. He was able to accomplish so large a task because he could avail himself of concentrated energy. Those who accomplish large tasks today also require concentrated energies and material surpluses in large amounts. But for the most part they face a very different problem than did Cheops; for Cheops was unhampered by thoughts of how he would dispose of what he produced.

The modern industrialist, however, is entirely dependent upon his ability to dispose of his products, just as the professional man or the laborer is dependent upon disposing of his services. In order for a product to be sold or exchanged, the other person to the transaction must have something to exchange or with which to buy. Cheops needed to take no thought of the lack of wealth of his slaves; but our modern producers, whether they be one-horse tenant farmers or wealthy manufacturers, know that they can dispose of their products only as others have wealth to exchange for them.

Because the energy at the command of industrial leaders is now so enormous, if they are to keep busy they must have a very wide demand for their products. That is, their products must be such that a great many people can secure them. But these people can secure them only if they have enough wealth to afford them. Thus it is that what is produced with the enormous surplus energy now at our command is dependent upon the buying power of the masses.

The buying power of the masses, in turn, is dependent not upon the amount of goods they produce, but upon the amount of goods, or their equivalent, that they receive. That is, they can exchange for other goods only the share they receive of that which they produce.

In the olden days, before the development of mass production, it required only that a small fraction of the public should possess some wealth to be able to dispose of what was produced. But today the wealthy industrialist is dependent upon the buying power of a wide public. If the masses cannot buy his products he can no longer

produce them; for they are of value to him only as he can exchange them for various things others produce.

A few of the more brilliant industrialists have already realized that only as people have money to buy with can such industrialists dispose of their products; and that only as they are able to get employment and receive a larger measure of what they produce do people have the money with which to purchase. No longer can the output of goods be absorbed by the few. Instead, it requires the combined consumptive power of the whole public. The more wealth the people of the world have the more goods they can purchase, and the more goods purchased by the people of the world, the more demand there is for what the industrialist has to sell.

Wealth thus is a complete circle which is kept revolving only so long as the public has the ability to secure what is produced. But if the buying power of the public is hampered by receiving an inadequate share of what it produces, by many of its members remaining unemployed, by being swindled out of its wealth, or through its wealth being tied up in unprofitable enterprises, the circle is broken. That is, if from any one of a number of causes the purchasing power of the public is reduced, everyone engaged in productive enterprises is injured, the wealthy man as well as the laborer. It is, therefore, advantageous to the wealthy individual, even from the most selfish standpoint, that there shall be no poverty.

Some hold that the poverty of the many may be cured by taking the wealth of the rich and dividing it among the poor. But the wealth of the world is not a constant factor. When things are produced they add that much wealth to the world. When things are used up this detracts that much from the wealth of the world. If there is greater production there is greater wealth. Therefore, that there shall be wealth in the future, production must continue.

Skillful Managers Needed

—Production, in this industrial age, is not merely a matter of unintelligent labor. Production, to be efficient, depends upon intricate machines, proper organization of men, and skillful management. Such efficient management is possible by comparatively few men in the world. If more men had high skill in management there would be fewer failures in business and more outstanding industrial successes.

That production and distribution of wealth may be efficiently accomplished, the world must enlist the services of the men who have this unusual ability. And that they may exercise this ability to the highest extent, there must be some inducement offered. The unusual efforts of these men to meet and overcome competition, to produce something better, or more cheaply, or to distribute it more efficiently, at the present time is called forth largely by the offer of personal reward in the form of money.

We have a right to hold that a man should put forth just as tireless energy to better the conditions of his fellowman as to advance his personal interests and those of his family; but at the same time we must concede, from observation, that only a very small minority have been educated as yet to a point where they follow this in the practical affairs of life.

With many individuals the attainment of honors is quite as strong an incentive as the making of money, and affords an inducement to productive work. To what extent this may take the place of the money incentive in causing people to work ceaselessly to develop higher abilities to produce and be of service probably largely depends upon the type of education they receive. In those regions which for over a quarter of a century have been experimenting with a system of equal pay for everyone, this appeal to the Drive for Significance has not been 100% successful. To stimulate maximum effort it has had to be supplemented with certain material advantages not available to those of less ability. Nevertheless? it has played a large part in stimulating high productivity.

The thing that should be emphasized here, however? is that freedom from want depends upon the continued activities of men who have unusual ability in leadership and management. Freedom from want depends upon both the production and the worldwide distribution of abundant good; and this adequate production and distribution requires ability of the highest order. Those who have this ability must be kept on the job using it; and to keep them as active as they are under the present system some ample incentive must be offered.

It is undoubtedly true that the undue appropriation of wealth by certain people is a sad handicap upon its wide distribution and the abolition of poverty. The real question is not so much a matter of right or wrong, as to what extent it is possible for mankind to utilize the maximum productive and organizing ability of those with this kind of ability, without permitting them the opportunity to take altogether too large a share of the wealth they help to produce.

Nor is this the only side of the situation that needs consideration; for men work to the limit of their powers not merely to accumulate money for themselves, but also to provide for the security and luxury of their children. Would the person with unusual productive ability, as soon as he had acquired all the money he could use, retire from work and deprive society of his usefulness if he were prevented from leaving wealth to his children?

Here again it is not so much a question of right or wrong as of expediency. We cannot afford, if we can retain them at any reasonable cost, to deprive society of the continuous and maximum efforts of certain exceptional individuals. As a matter of human rights, there is no reason why one child should inherit more in the way of material wealth than any other child. The right of bequest could well be done away with were it not that it would discourage the productive activity of parents. Parents, very frequently, will work more arduously to provide for their children than to provide for their own wants. If this incentive is removed through society prohibiting

the inheritance of wealth, society will suffer unless some other equally strong incentive be substituted.

Accumulations of Wealth Essential

—Then again, to what extent should society permit wealth to accumulate in the hands of any one individual? To build machines, to harness power, and to conduct the distribution of goods economically, requires the concentration of vast wealth. Freedom from want requires that such accumulated wealth be available for the use of those possessing the technical and managerial skill to devote it most effectively to the production of still further wealth.

There is a tendency today thus to handle accumulated wealth through corporations. Shares are issued and sold, and profits are distributed on the basis of the number of shares owned. Often wealthy individuals purchase 51% of the shares, or manage to control the votes of 51% of the shareholders, and the balance of the shares are sold to as wide and numerous a public as possible. The influence of the many shareholders is depended upon to block legislation unfavorable to the corporation. But the one or a few wealthy individuals controlling 51% of the stock are able to determine the policies of the corporation.

Such a corporation often is able to produce and distribute far more economically than can enterprises with less wealth at their command. But some have been known to buy inventions which would enable a superior product to be produced far more cheaply, or which would give the public some great convenience, and neither use the invention nor let anyone else use it, because its use would make the equipment or some product of the corporation obsolete.

Big business may, or may not, be beneficial to the public interest. Just as this is being written, at the end of World War II, there is a great paper shortage. The paper mills have attempted to supply their old customers on the basis of a percentage of what each used before the war. But, to be able vastly to increase their circulation, a few of the big magazines have purchased the paper mills producing coated papers, and the orders of other firms have been canceled. This means that many worthwhile books will not be published for a long time to come. People will get more of certain magazines, but will be deprived of other magazines and will be deprived of books badly needed.

Because great wealth often is not used to benefit the public, some advocate that only the government be permitted to accumulate wealth on a large scale. Everything then, requiring much wealth to handle, would be done by the government. Yet the general experience has been that as soon as there is a monopoly in any activity, efficiency rapidly deteriorates. Competition between rival firms leads each to exert its utmost

efforts to develop its product to the highest quality, to devise means to lower costs, and to manage its affairs with the utmost economy. There is a realization that any slackening of effort will be followed by personal loss. Each also strains itself to the utmost to think of improvements, both in the product and in the efficiency of methods, that an advantage may be gained over the rival.

Such competition, undoubtedly, is wasteful in the sense that there often is duplication of effort, and that the incompetent are forced into failure and loss. But it does work to promote efficiency of operation and excellence of product. It is, after all, the method Nature has used throughout the ages. Forms of life unable to adapt themselves to changing environment have perished, even as obsolete machinery and obsolete business methods are now being pushed into the junk heap. This is hard on the individual who owns the old type machine, or who follows old time business practices; but it means better conditions for society as a whole. It was hard on lower types of life when man appeared upon the earth. Dangerous beasts and reptiles had to go, and many types of insects are putting up a losing fight; being forced aside by the competition of man. Yet as the result of this competitive struggle the world as a whole has made marked progress.

And we may be sure that so long as there is strenuous competition between business firms, between manufacturers, and between other forms of productive activity, that those dependent upon the gain derived from such undertakings will see to it that they are run at maximum efficiency. Stockholders and a board of directors care little whether the manager of a firm is, or is not, a good fellow, or if his private life is according to approved standards. What they require is that he run the corporation at a profit. If he does not, in spite of excuses and alibis, he is removed and a manager hired who can make the enterprise a success.

But when there is a monopoly the firm continues in business in spite of obsolete methods and inefficient management. Its stockholders and directors have no adequate standard of comparison with which to gauge its performance. It is in a position to force the public, regardless of the quality of its product or services, to yield it an adequate return.

Government Ownership

—If the government were to go into the various lines of business, as it would be compelled to do if it alone were permitted to accumulate large-scale wealth, or as it would be compelled to do if labor unions and private management were unable to reconcile their differences, it would be a monopoly of the most powerful kind. Through more complete organization of its resources much duplication of effort would be eliminated, and much of the waste now due to individuals entering business with inadequate capital, or failing because new competitors enter the field, would be saved. But at the same time, the leading positions in any government enterprise are usually obtained, not because of unusual ability in handling such an enterprise, but

because of unusual ability to make friends, or because of usefulness to political candidates.

The number who make outstanding successes in large-scale production, compared with the number who fail even to escape business failure, implies that very few men have the qualifications successfully to manage large industrial organizations. There is serious question if the few really competent men, who seldom are good politicians, would be chosen to head any business conducted by the government.

Then again, there is the question whether or not the government can be induced to spend money for the development of worthwhile projects, or with complete efficiency in the alleviation of human distress.

Our President during most of World War II, under the stress and uncertainties of that war, set aside two billion dollars for nuclear research and the development of the atomic bomb. Under peace-time conditions such a gamble would have been unthinkable unless taken by private enterprises.

At their inception, from the locomotive, steamboat and telephone on, our congressmen have had a habit of scoffing at new inventions. Kings and emperors, likewise, have been scoffers. It takes a very different kind of ability to be a politician, or even a statesman, than it does to perceive the commercial possibilities of some new device. Consequently, not only in the development of inventions, but wherever there has been a hazard, government officials, in fear of condemnation if there should be failure, have declined to offer government's support. There are always ultra-conservatives with enough voice to block the government from entering any enterprise where they, because temperamentally so inclined, fear a loss. Such hazards have been taken, as a rule, by optimistic individuals who have risked their own capital. Many times such optimism is followed by failure and loss. But those who do make a success of something new not only are recompensed more or less financially, but also contribute to the advancement of society.

The elimination of the hookworm in America and the sleeping sickness in Africa, as well as numerous other diseases which lower human efficiency, should have had immense government appropriations. The educational requirements of the country called for government expenditures to install numerous libraries. This was perceived by various politicians; but they were also well aware that their constituents at home would withdraw their support if, for any such purposes that were commonly considered visionary, they increased taxation.

But the Rockefeller Foundation not only saw the need, but was supplied with the capital to fight these diseases; and Andrew Carnegie saw the need and devised a way to furnish libraries. Many other individuals who have had the peculiar ability necessary to accumulate wealth also have used quite as exceptional ability in spending it for the benefit of the public.

Whether private ownership or government ownership of wealth is more effective in giving freedom from want depends not so much upon the form of ownership as upon the kind of individuals that in each instance have control of the wealth. If it should become a universal habit of wealthy men, who have acquired their wealth through the exercise of initiative and ability, to devote most of such wealth to bettering the conditions of their fellow man, private ownership seems to offer the most hope of advancement. But if such men withdraw too great a portion from accessibility to their fellow man, it is better that the government alone should possess great wealth.

Not only national planning, but world planning and considerable control by some central authority is necessary to free all peoples from want. But the extent to which government ownership should or should not replace private ownership of industry and wealth varies with the human attitude toward responsibility to others. And this is in a constant state of flux. Private enterprise can be made to abolish poverty in the world if those of unusual wealth-accumulating ability can be induced to perceive their responsibility to their fellow man. On the other hand, if the government conducted all business, poverty could be banished in the world if those who now make a success of private enterprise could be induced to work as hard and be given the responsible positions.

Banishing Poverty

—The world has become so narrowed in recent years that what affects one nation affects all nations. We cannot afford to have backward nations in this world, no more than we can afford to have illiterate regions within the United States. We cannot afford to have poverty stricken nations in this world. No more than we can afford to have poverty stricken areas within the United States. Poverty stricken people cannot buy what we produce, and poverty stricken nations cannot buy — either with dollars or the things they produce and we need — the things we produce. Poverty in any section of the world restricts distribution. People must have products or services to exchange — at first perhaps turning them into money — for the products and services of others. Provided the variety is sufficient, the more that is thus produced and exchanged the nearer they come to freedom from want.

Every case of poverty represents an individual who under more fortunate circumstances would be a potential customer. Over-production is merely a lack of customers; and with an increase of customers there would be no over-production. Even if the world want for one article were completely satisfied, production readily could be turned to the output of something else that still was wanted. There is thus no real over-production, only a lack of people with wealth enough to buy. For until every human want for material things is satisfied there is still underproduction. Therefore, the cure for so-called overproduction is the cure of poverty. And the cure of poverty lies in opportunity for full employment in which the great run of mankind receive as great a share as possible of what they produce.

Idle individuals are unproductive of wealth. No one is permanently benefitted by the enforced idleness of those desiring to work. Nor is anyone permanently benefitted by the existence of a class of individuals that receives so little for energy expended that their purchasing power is confined to the bare necessities. In fact, it narrows down to this: so long as there is a poverty stricken individual in the world, other people suffer through the lack of this individual's purchasing power.

Consequently, it should be a chief function of government to devise whatever means may be necessary to enable every individual willing to work to have as remunerative employment as possible. There should never be lack of opportunity for any individual to produce wealth. And it should be another function of government to make it possible for every person to receive training in the use of the natural aptitudes indicated by his chart of birth, thus increasing his skill, and enabling him to produce a maximum of wealth.

With wealth at hand, there must also be sufficient leisure for those possessing it to use it. Leisure to make intellectual and spiritual progress is essential. Furthermore, whatever is produced must be used if it is to create a demand for more. Everyone thus should be both a producer and a consumer.

At all times there is work that needs to be done, because human wants are never satisfied. But the money-chain that exists between the person who wants and the person who has the ability to provide may be inadequate to meet the strain placed upon it. It may be weakened or completely broken through certain individuals hoarding too great a share of wealth, through raw materials or the machinery of production falling into the hands of those who restrict production to gain greater profits for themselves, through numerous individuals ceasing to spend through lack of confidence in their ability to continue gainfully employed, or through any number of other causes that decreases public purchasing power. When such a situation arises an unusual number of persons are thrown out of employment. And even at other times the wealth-distributing system is now so ineffective that numerous individuals who desire employment are idle.

To banish poverty and provide freedom from want every person in the world should have opportunity at all times for productive and remunerative activity. Such full employment is possible only when the worker gets as large a share as practicable of what he produces so that there is buying power to purchase the things produced. And that this buying shall be adequate, the greatest possible facilities of trade between the nations of the world must be established.

Thus the cosmic alchemist works vigorously to create an overwhelming public sentiment for full employment everywhere, at as great a share of what is produced as practicable, and for measures to facilitate trade between all the inhabitants of the earth; for through these three all the people of the world can have Freedom From Want.

Chapter 3

Serial No. 166
Original Copyright 1946
Elbert Benjamine

Copyright
August 2002
Church of Light

Cosmic Politics

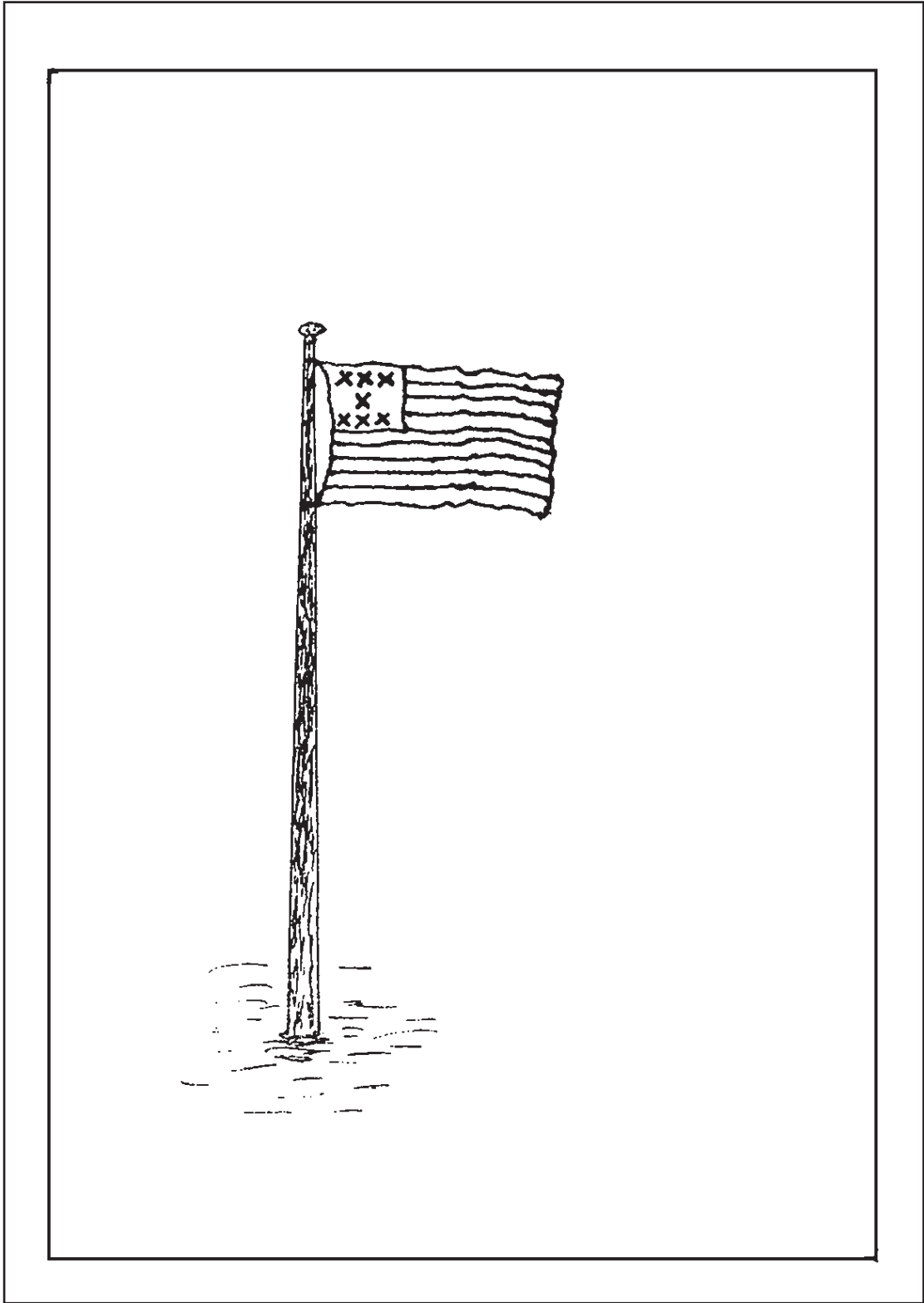

Chapter 3

Cosmic Politics

BECAUSE all too often politics has been used by the unscrupulous to acquire advantages for special privilege at the expense of public welfare, it has gained for itself, in the minds of many, a noxious odor. Yet this is merely one more example of the principle — exemplified by aviation, and still more recently and forcefully by atomic fission — that anything which can be used for good can also be used for evil.

Cosmic alchemists must be realistic, willing to face facts without being influenced by popular prejudice. And the fact concerning important changes in the social structure, by which people can be benefitted, is that the only way they can be brought to pass is through politics. Under a democracy, those elected to office are supposed to enact legislation that will carry out the desires of the people. If they pass laws disapproved by the people, it is likely they will not be returned to office at the next election. But even in a dictatorship, the dictator, to remain in power, must be able to sell his ideas to his immediate henchmen, and if he is to be successful in any really large enterprise he must have the willing support also of a large portion of the people.

It is the desire of the cosmic alchemist that all the people of the world shall make as great intellectual and spiritual progress as possible, and for reasons briefly stated in lesson No. 164 he believes this can be accomplished only by providing freedom from want, freedom from fear, freedom of expression and freedom of worship to all the people of the world.

These freedoms, or any one of them, can only be gained by the people of the world exerting sufficient political pressure upon their leaders to cause them to strive to devise means to attain them.

Already, in the two preceding lessons, it has been shown that only through proper organization can poverty and war be abolished. And such organization is possible only under governments which permit it. That is, they are dependent upon politics.

The fear of want and the fear of war are not the only fears harbored by man. There is the fear of death, the fear of disease, the fear of failure, and many other fears. Nor can there be freedom from fear among a people who are persecuted because they have different religious views than those advocated by the state. And the only manner in

which man can be freed from these other fears is through adequate knowledge and freedom to govern his actions by this knowledge.

When he understands after-death conditions, he should no longer fear death. When he understands how to protect himself from disease, and gains the viewpoint of the spiritual alchemist relative to it and other disagreeable experiences, he will no longer fear them. But to gain the knowledge which will thus banish fear, he must have access to the facts. And this he can have only where there is freedom of expression and freedom of worship.

From the standpoint of the cosmic alchemist the best kind of government for a people is one that gives no undue advantage to any group or class, but which affords the greatest opportunity for every individual to develop his highest talents, and which affords him an incentive to use these talents in a manner that will benefit others as well as himself.

As any astrologer quickly can demonstrate, people are not born equal in the sense that they have equal natural aptitudes which can be developed into abilities. But all should be given the opportunity to develop into abilities such natural aptitudes as their charts of birth show they do have. Regardless of race, sex, creed or color, people should be given equal opportunity to work, equal pay for doing the same work, equal political opportunities, equal educational opportunities, equal social opportunities and equal recreational opportunities.

But they cannot have such equal opportunities if they permit the form of government under which they live to be selected for them by some hereditary strain, by some special privilege group, or in any other manner than through self-determination. And even when there is self-determination there are always individuals seeking special privileges and always groups striving to gain unfair advantage over other groups.

Here in democratic America, for instance, groups which largely submerge their selfish interests in time of war in the all-out struggle for national victory, in time of peace work almost exclusively for their own advantage with little regard for the effect upon other groups or upon the nation. Many of these groups subsidize press publicity and maintain political lobbies in the effort to gain the advantages they desire. Other groups work as energetically to thwart these efforts and instead gain advantages for themselves.

Agriculture works vigorously for high prices for agricultural products, and vigorously opposes high prices for the products of industry; while industry works for high prices for industrial products and low prices for the products of agriculture.

The labor unions struggle continually for full employment and to raise wages; while organized capital seeks a condition where enough people are unemployed that it can always hire help and force wages down.

Those on the public pay roll work for higher taxes, so that money may be available to enable them to retain their jobs; while the general public works to have taxes, which they must pay, lowered. And states compete greedily for government appropriations which will benefit themselves at the expense of the tax payers of all the states; and cities and counties strive to grab as great a share as possible of the available tax money.

The movies organize to find means of drawing patronage that otherwise would spend their money on sports or other forms of entertainment; and other types of entertainment form groups to draw trade from the movies.

These groups too often ignore the public welfare and exert political pressure to get legislation passed that benefits themselves at the expense of the nation. In other words, they enter that class of individuals which we term special privilege. And special privilege means that others are deprived of the equal opportunities which are essential for the greatest intellectual and spiritual progress of the people of the world.

To correct or prevent the injustices of special privilege, people must have the opportunity to select their leaders and to bring pressure to bear to get just laws made. But this opportunity alone suffices little until a people are educated enough properly to reason correctly from facts, and have access to all the relevant facts.

It has often been pointed out that the backward peoples of the world are not yet ready for self government. These peoples, it is urged, are so ignorant of what kind of government is good for them that they can readily be induced to place in power individuals who would rob and enslave them. And it is undoubtedly true that having had little access to facts, and no experience in self government, they would make mistakes. But Germany was not considered a backward nation when it was robbed and enslaved by Hitler's cunning propaganda, nor was Italy considered a backward nation when Mussolini was given power of life and death over its people.

The United States was not considered a backward nation when in 1943 it permitted two special privilege groups — the American Astronomical Society and the American Society of Magicians — to get astrological broadcasts ruled off the air. Nor when, as at present, the big newspapers and magazines are either owned, subsidized, or otherwise largely under the control of big corporations which are interested in suppressing or distorting facts which if widely known would prevent them making huge profits.

Yet if self determination is to result in proper benefits to the people who exercise it, the people, whether of a backward nation or a progressive nation, must have access to as many facts as possible relative to what will give them the most opportunities, and, instead of being led into slavery or poverty by some demagogue or some self-seeking group, must have the intelligence to discern inversive propaganda and to recognize and work for conditions which will really benefit them.

Capable Leaders Needed

—In the attainment of these benefits they should enlist the services of capable leaders. Government should be managed, not by individuals who muddle even their own small affairs, but by the best possible ability obtainable. For that matter, the fact may as well be faced that under any form of government that has existed in the past or is discernible in the future, the many are always governed by the few. So long as there are those with more energy, intelligence and ambition than their fellows, these will find some means by which to direct the destinies of other people. The ability of the cleverest to influence and manage the less clever cannot be abolished by law. But proper legislation can prevent the clever from gaining too great power and wealth at the expense of others.

When a person is taken to a hospital because of a serious accident, the relatives do not gather and take a vote on what shall be done for the patient. Instead, they select as good a surgeon as they can find, permit him to do what he thinks is best, and hold him responsible for results. Realizing that the surgeon is a specialist in his line, they make no attempt to dictate to him what to do. Such undue interference would jeopardize the life of the patient.

Nor is any successful business of size conducted by permitting numerous share holders to vote on the many decisions that from time to time arise. Instead, a board of directors is elected, or a group of men of ability selected, to pass judgment on policies; and these commonly select some one individual to hold responsible for the administration of these policies.

In the San Joaquin Valley some years ago a farming colony was promoted in which every individual was to have an equal voice in every decision affecting the colony. They had a huge tract of land, part lying on one side of the road and part on the other side. It had been decided to use practically the whole tract for raising small grain. No difficulty arose until the plowing had been finished and the time for seeding was at hand.

An argument then started whether to seed the north side piece first, or the south-side piece. As the result of the argument a meeting was called in the assembly building to put the matter to vote. A few more practical men implored the rest to get the seed in the ground with no delay as already it was time for the rains. But there were numerous long winded speakers, and they did not finish on the first evening, so that the vote was postponed until the next formal meeting a week hence. Nor did the speakers finish on this occasion. It took three weeks, with a meeting but once a week, to get the matter settled. In the meantime the rains arrived and mostly passed. Adjoining farms had splendid crops that year; but the seed put in the ground three weeks too late failed to mature a crop. As a consequence the colony disbanded and the land was taken for its debts.

What every business concern needs, and what every government needs, was needed by this colony. It needed men of exceptional knowledge and ability in positions of responsibility, with sufficient authority to enable them to carry out their decisions. This much certainly should be clear: To have a good government, we must have the best possible brains to run it.

This brings up the question as to how the best possible brains may be secured for such tasks, and how they may be prevented from using their authority for the advancement of personal interests rather than for those for which they were selected. Large business concerns seem to have solved this difficulty rather well. For important positions they customarily pick men with training and experience along the line of the position they are expected to fill. These men are judged, not by their vote getting ability, but by their past performance in other positions of some responsibility.

A railway president may have started with pick and shovel on a section gang, and have worked up through the various departments. Through long experience and arduous training he is a specialist in railroading. So, likewise, the superintendent of a manufacturing plant often makes his start as a mechanic, then becomes foreman of a department, and finally achieves still higher. There is, no doubt, some favoritism shown in business advancement; but the competition of other concerns is so keen that favoritism is largely routed in the interest of self-preservation. Consequently, we find the men at the head of present-day large business and manufacturing concerns, almost without exception, to be men of outstanding ability.

But can we say as much of those we select to run our government? Are the governors of our various states as thoroughly trained in the principles and practices of sound administration, as the presidents of railroads are trained in the principles and practices of railroading? Or take the men at the head of our national government and compare them in ability with the men at the head of nation-wide merchandising concerns, at the head of nation-wide banking systems, and at the head of manufacturing organizations with nation-wide distribution.

Merchandising, banking, or manufacturing cannot be successfully carried out on a large scale by men who have spent most of their lives occupied with something entirely different. Yet the science and art of government is more difficult than any of these. An MD must pass four years at medical school, must pass examinations, and usually must serve a considerable period as intern at some hospital before he is permitted to practice. A lawyer also must have requisite schooling and pass certain tests before being admitted to the bar. But a jack-of-all-trades who turns his hand a few years to politics, if he is a convincing talker and a hail-fellow-well-met, need know nothing of governmental principles nor have had any experience in administration, to win enough votes to get him a post where he exercises much influence over the destinies of his fellow man.

This is common knowledge; but what can be done about it? It is to be hoped that legislation and political administration may be critically studied and formulated before long into definite sciences to be taught in colleges. Any individual, then, who

becomes a candidate for a given office, should be required to show, by his college certificate, or by passing special examinations prepared for those who have studied at home, that he is thoroughly familiar with what already is definitely known about government. Instead of having to experiment on the public with every idea that enters his mind, to find out if it actually will work, he should be thoroughly familiar, through his studies, with ideas that already have been tried out, and to what extent, and why, they have or have not, succeeded. The starting point of every political career should be a thorough schooling in the science of government.

But because a man or woman has a diploma that entitles the holder to practice a given profession is no assurance of real ability. Ability is tested out and increased by the actual application of knowledge. No one would think of giving a newly graduated engineer charge of some great project. He would be tried out, and given opportunity to gain experience, in connection with smaller and less important ventures. As he demonstrated actual ability through doing, he would be advanced to more important positions. If past performance warranted, in time he might be placed at the top. Because he had proved himself the best man for the position, the position would be his.

Dictatorship and Aristocracy

—Of all the forms of government, when an unusually talented man is at its head, a dictatorship or an absolute monarchy is the most efficient. In either case authority is so centralized that the man-power and the material resources of a country can be organized and directed in a manner that is quite impossible under other forms of government. There is one man at the top whose word is law. Making a survey of the country's needs, he decides how much acreage shall be placed in this or that crop, and how many men shall be engaged in the production of each commodity. Without red tape or long delays the energies and the man-power of the country are thus completely mobilized and directed into channels of production that yield the most in the way of goods and public improvements for the nation.

Why, then, are not dictatorships more popular?

This we can perceive readily, not merely from theory but by reviewing the conditions in this and other countries during each of the World Wars. Because of the threat to the existence of the country, in war time there is necessity for the utmost efficiency; and to gain this efficiency the authority of those in high position is increased until there is virtually a dictatorship. Those who were not engaged directly as combatants were told what to do. Factories that had been built to manufacture peacetime articles were commanded to manufacture war products. There was conscription of men. People, regardless of wealth, were regulated in the amount of various foods they might procure, and in the amount of various products they might buy. Very little account was taken of the desires or inconveniences of individuals. The only thing considered of consequence was whether it helped or hindered the nation as a whole.

Thus it is under a dictatorship the freedom of the people to decide the kind of lives they will live is taken from them. They are slaves of the state. A man, or group of men, at the top decide what is good for people, and force them to live according to this decision. And under competent guidance such a dictatorship may make for the utmost in industrial advancement. But it tends to prevent the development of talent and individual initiative except such as has the approval of those in authority. The dictator may determine what religion alone is to be permitted in the country, may decide that all facts shall be suppressed except those favoring his regime, and may divert the wealth and resources of the nation to furthering his own ambitions.

The slave, in the olden days, was usually well taken care of; and when he exhibited promise often the opportunity was given him to develop his talents. But in spite of being parts of a more efficient industrial machine, men find both slavery and rigid dictatorship irksome. A dictator has the power, and it was thus used by both Hitler and Mussolini, to deprive people of the things they otherwise could have had, to encourage fear, to curtail expression and to prevent religious freedom. Either a dictator or an absolute monarch has it within his power to thwart all the things for which the cosmic alchemist works, including freedom from want, freedom from fear, freedom of expression and freedom of worship.

When a man, or a group of men, gain absolute authority over others, they are very apt to abuse their power to their own selfish advantage. As a matter of fact there have been only a few monarchs, such as Napoleon, Louis XIV, Ivan the Terrible, Peter and Frederick who have been real rulers. Most of the others, like Kaiser Wilhelm who merely voiced the thoughts and policies of the Junker crowd, and Hirohito who was but a front and took orders from the Japanese military caste, have been the tools of dazzle, display and seeming authority through which a powerful and secret group has been able to work its will upon the people. And this will, as revealed by the history of monarchies, with the gaining of complete authority by the few, has almost always been to practice oppression on those less fortunately situated.

The aristocracy of the past not only despoiled the people of their wealth, but it used them, as hunters now use dogs in the pursuit of dangerous game, in the sport and pastime of war. Nor do we find, with rare exceptions, that aristocracy has nursed and developed the highest in culture. The Greek drama was encouraged and supported by the business men of that day. The fortunes of Roman gentlemen also made possible the literary works of Horace, Lucretius and Virgil. The merchant guilds erected the Gothic cathedrals, and the treasures of the banking house of Medici were largely responsible for the renaissance. Very seldom has aristocracy contributed either influence or ability toward the development of those things that make for higher standards of living, or for an appreciation of art, music and literature among the people.

Socialism or Private Enterprise

—The only safeguard the people have against exploitation and oppression is to retain in their own hands the power to select their leaders and to change their leaders and through these leaders to form and administer just laws. And even when such democratic processes prevail there are always present those who seek to have laws passed which will give them special privileges. The only safeguard against them is an enlightened and vigorously interested public opinion.

Thus while it is perfectly clear that the cosmic alchemist should work to establish democratic processes throughout the world, and for the enlightenment which prevents special privilege from using democratic processes to exploit the people, it is not yet clear to what extent government ownership and management of natural resources, industry, agriculture, business and all other economic activities should supplant private enterprise. But this is the great issue before the world today, and a struggle for supremacy between the two systems is inevitable. It is a struggle that relates not only to the manner in which the affairs of a particular nation are to be conducted but, unless each system is modified to embrace many features of the other and thus presents a modified form acceptable to all important nations, it is a struggle that inevitably will pit nation against nation and system against system in a contest for world mastery.

Agricultural people are dependent upon their land for a livelihood. It is quite natural of them, therefore, to desire to own the land. Owning the land gives them a feeling of security, a feeling that they have control of the source of their living. For this reason a farming population resists socialism which would deprive them of the private ownership of their lands.

As a people turn from agriculture to industrialism they wish to retain the same feeling of security that they had in the past. Now, however, instead of being able to raise what they eat, and what they wear, they must purchase these with the returns from industrial work. Such employment, however, unlike the work they did upon the land they owned, must be furnished by some organization. Unless they can find an organization willing to employ them they cannot secure the necessities of life. In the past private enterprise even in normal times has not been able to furnish jobs for all willing to work, and under exceptional conditions the distress resulting from unemployment — some 14 million being forced into idleness in the U. S. a few years after the commencement of the Pluto Period in 1930 — has been intolerable and widespread.

The worker feels, and rightly, that he is entitled to security. A job is not to be owned in the same way that land is to be owned; but he feels that he should have quite as much control of it. The socialist solution is for the government to own the resources and control the organizations and the jobs. Instead of being initiated and conducted by privately owned organizations in competition with other privately owned organizations, all would be conducted through the avenue of politics.

As opposed to this political method of conducting affairs we have the development of corporations, trade associations, trade unions, syndicates, and chain groups. In competition these develop a high degree of efficiency, the most efficient often absorbing the others until, like J. P. Morgan and Co., which exercises a governing power over huge groups of railroads and industries through its banks, they are so powerful that they have little to fear from competition. At this stage, unless these great organizations take unusual care to function for the general welfare quite as much as for profits, it is necessary for the government to establish regulatory measures.

We have the Sherman Anti-Trust Act, the Interstate Commerce Commission, the Federal Reserve Board and the Federal Trade Commission, all empowered to prevent unfair practices of huge organizations. Yet it certainly is an unfair practice for the great privately owned and managed enterprises to acquire either so much of the raw materials or the machinery of production that millions are made poverty stricken through inability to have access to these essentials for production. And in addition, this enforced idleness and unproductivity detracts from the wealth and prosperity of the nation and of the world.

While there is full employment it may be wise for the government to permit private enterprise to handle business and industry. subject to certain government controls. But it certainly is not wise to depend entirely on private industry to furnish that full employment which alone can give freedom from want. Here government should step in. Instead of abolishing the private ownership of business, which is the method of socialism, the government could set up adequate reserves, to be used in the construction of roads, public buildings, canals, dams for flood control and generation of electrical power, irrigation systems, reforestation, erosion checks and other things beneficial to the whole population. Such a reserve set aside for the purpose of absorbing the unemployed in constructive government work would, through keeping money in circulation, be of advantage to everyone, and be an insurance against hard times.

But whether accomplished through this method or through a still wider application of the principles of socialism, full employment must be insured. Those who are dependent upon employment will then have that feeling of security that all people demand. Not only will it make for freedom from want, but people will not live in fear of being deprived of a means of getting a livelihood. And we may be quite confident that they will never cease struggle and agitation until, either through the wisdom of those engaged in private enterprise, through governmental regulation, or through the application of the principles of socialism, they have this security.

Whatever prosperity now exists in the world is largely due to organization by which leaders or managers have the control of large resources. Under either system of government, then, unless the benefits that so largely determine prosperity are relinquished, the managers must be given access to vast material means that they can induce labor to function, and that raw materials and machines may be had in quantities and handled in such ways as to afford economical production. Under any

system, to free people from want sufficiently that they may develop higher standards of life and culture, there must be huge concentrations of wealth and vast groups of well organized men. The problem that confronts each political system therefore is the same: how to secure the most efficient managers, how to insure that these managers will perform their functions in the most efficient manner, and how to insure that they will utilize the products of combined wealth and organization for the general welfare instead of for the selfish ambition of the few.

Because competition weeds out those with less ability the managers of big corporations in this country usually are efficient. But too often the corporations are managed to insure immense profits to their stockholders rather than for the benefit of a wider public. Large oil interests are accused of attempting to gain, through corrupt public officials, vast holdings that belong to the people. Power interests are believed to be engaged in grabbing natural resources and making the public pay usurious profits for their development. It is charged that there is a monopoly on the production of aluminum. To the extent private enterprise, whether through gigantic corporations or through smaller groups, shows the desire to benefit themselves unduly at the expense of the public, to that extent will the political method have to be invoked to restrain them.

In this country, up to the present time, the political method has been applied through politically appointed groups given legal authority to exercise a certain amount of control. That is, when people or groups do not exercise their functions in a manner conducive to public welfare, laws are passed and agents appointed to administer these laws. Thus as affecting the well being of the consuming public we have the pure-food act, the drug act, meat-inspection laws, fire prevention regulations, building regulations, and laws of sanitation. In the interest of the employee we have laws regulating the hours of work, the conditions surrounding work, the amount of compensation, and safeguarding against dangerous machinery. Then there are laws governing the employer's liability and determining how and when wages shall be paid. Other regulations are imposed on banks and institutions of trust. Those who enter certain professions and callings also must, in the interest of the public, prove their qualifications.

This political method of regulating affairs is on the increase. Wherever and whenever an industry or a group fails to control itself in the interest of the general public, the public, through the political method, is compelled to assume the responsibility of that control. Thus in this country it would seem that the amount of control exercised by the government, and the extent to which it takes over and manages business and industry in the future, will depend upon the department of private enterprise and the department of organized labor.

Telephone service throughout the nation can be completely paralyzed by the strike of the 263,000 members (1946) of the National Federation of Telephone Workers, lack of steel can cause a shut down of the majority of the factories in the nation should the 800,000 CIO steelworkers (1946) go on strike, a strike of the Railway Brotherhoods can tie up transportation, a strike of the A.F.L. and CIO packing house workers can

cut off the supply of meat from the nation, a strike of the 500,000 members (1946) of the United Mine Workers can deprive the nation of coal, and strikes of other unions can prevent the people of the nation from getting clothing, groceries, gas, light, local transportation and other things on which life directly depends or upon which the ability of people to continue productive activity depends.

It is not in the public interest, and should not be tolerated, that one group should starve all the other people of the nation, cause illness and hardship to many thousands through lack of heat, or prevent the other people of the nation from continuing the productive activities upon which their subsistence and the welfare of the nation depend. Therefore, when a strike or a lockout seriously threatens the welfare of the nation there seems to be no recourse but for the government, at least temporarily, to take over the industry under dispute.

The danger under the system of private enterprise is that big business will control the government to its own advantage and to the disadvantage of the people as a whole. Think, for instance, of the power to influence public sentiment of such an organization as the National Association of Manufacturers with a membership (1946) of 14,500 corporations employing 10 million workers.

The danger under the system of politics (socialism) is that the government will be controlled by a few whose good fellowship, wire-pulling and political strategy are able to influence the greatest number of votes, and that productivity and distribution will be handled by cumbersome bureaus and politically appointed managers whose ability is chiefly confined to getting votes for the higher-ups.

Under any system of government the many will be ruled by the few. But the few who run things under socialism may be wire-pullers and their friends who are unable efficiently to handle production and distribution, while the few who run things under private enterprise (capitalism) may be efficient but use their abilities for their own advantage instead of for the benefit of the public.

Socialism thus has its disadvantages, and private enterprise has other disadvantages. In each case the disadvantages chiefly relate to the personal equation of its managers. Not only does this personal equation change from year to year, and not only is it different in different countries, but just now it is difficult to determine the effect atomic fission and perhaps the utilization of the cosmic ray will have on industrial, political and international relations.

If we look back in history to the end of the Stone Age, we find that the use of iron changed not only methods of warfare, but also radically changed society. Then, at a much later date, gunpowder again changed methods of warfare, political boundaries, and the economic situation of many countries. Within our own time aircraft have once more changed the methods of warfare, narrowed the world to a space which makes of it, relative to the ease of reaching any part, merely a small country, and has revolutionized industry. And now comes atomic fission, a great new force to be used for good or evil.

In view of great changes which lie immediately ahead, and in view of the as yet unknown personal equation of the leaders in that near future, it seems wiser to place reliance on observation rather than on untried theory. Each system is now being tried out on a large scale in different parts of the world. It should be apparent, therefore, before too long, from the actual results attained in these areas, whether private enterprise or socialism will do most to insure all the people of the world freedom from want, freedom from fear, freedom of expression and freedom of worship.

Every Nation, Every Group and Every Individual Should Get a Square Deal

—In a properly organized world, even as in a properly organized nation or in a properly organized industry, there must be division of labor, specialization of parts, and cooperation between those parts. Certain areas of the world are better fitted to grow or manufacture certain products, and other areas are more suited to producing other things. Each type of merchandise should be produced where conditions are best suited to its production. And it should be a function of the United Nations Organization to provide facilities for the equitable exchange of the products of one region for the products of other regions.

When world planning or national planning is supplemented by compulsory measures which regiment the people and force them into narrow grooves of activity, it interferes with freedom of expression. But lack of world planning and national planning is highly wasteful and interferes with freedom from want. It is not the planning which is distasteful, but the compulsion which forces people to follow activities they do not desire.

Through lack of national planning many of the natural resources of the U.S. have been squandered. Timber now sadly needed for paper pulp and for building homes was logged off in earlier days with no provision for reforestation. Oil was pumped from the underground reservoirs and used up with needless extravagance. Farm land was single-cropped to death until much is now worthless. In other areas the top soil was loosened with no provision to keep it from blowing away, or from being washed into the rivers. Ponds and swamps were tilled that crops might be raised on the land thus made available, and the water no longer retarded, but drained into the rivers almost as fast as it fell, caused the rivers to overflow, inundating and destroying not only vast areas of farming land, but villages also.

It certainly contributes to want when car loads of oranges are dumped into the Pacific Ocean, when peaches and apples are left to rot on the trees, and when wheat and corn are used as fuel in the regions where raised, because they cannot be exchanged for the products of other areas. And it certainly would not contribute to freedom from want were all manufacturing concerns to concentrate on producing washing machines, and neglect to produce other things.

Without compelling people to follow occupations distasteful to them, and without curtailing either initiative or independence so long as they work no injury on others, the government should make a survey of needs and make recommendations based on this survey. Its recommendations should follow the quota system. Certain areas should be called upon voluntarily to produce some crop in quantity such as indicated, with plantings large enough to leave a margin of safety in case of unseasonable weather. Different areas should be allocated other crops, and other regions called upon for manufactured products of a type for which the area has production facilities.

What would people think of an auto manufacturer who, with no demand for his engines except in his completed cars, built three or four times as many engines as he could build or procure car bodies or chassis? World planning and national planning, through the widespread dissemination of information, through tentative quotas whose fulfillment depends upon the voluntary activities of people having regional organization, and through inducements — including public opinion — to discourage quotas being exceeded, but to encourage their being met, can prevent such unwise use of time, materials and energies in world production as is illustrated by the inefficient auto manufacturer.

Whether in time the resources, productivity and business of the countries of the United Nations Organization are chiefly state owned and managed, or are chiefly owned and managed by private enterprise, there will be, as now, division of labor. Whenever there is division of labor there are groups which perform different tasks. Some of these tasks take much preparation and a skill acquired only by many years of application. Some require patient mental training and unusual intelligence, and some require little but brawn. The most obvious groups today are the capitalist, the merchant, the professional, the farmer, and the industrial worker. But within these broad categories are lesser classifications. And between such groups, as previously indicated, there is always a struggle for advantage.

Even should it come to pass that the members of all classes receive equal pay, some groups, because of the greater strain, would feel that they should work shorter hours than those under no such strain. There seems to be no prospect, therefore, under any kind of regime, of everyone being satisfied. One coterie, for instance, may be able to get more significance, or to exert greater political pressure than another group. Until everyone becomes wise enough to strive to contribute his utmost to universal welfare, and wise enough not to overestimate his own importance, there will be some who struggle to gain an advantage in some manner over others.

The common method of solving such problems is for the stronger to ignore the claims of the weaker. When there is a dictatorship, the less popular are shoved to one side with little ado. In the representative form of government, the minority are voted down by the majority. Right at the end of World War I a “dry” majority ignored the desires of a “wet” minority. As a result there was prohibition that failed to prohibit, because it was forced upon an unwilling group.

In any country there are always many groups, and these often pull in opposite directions. And in the United Nations Organization there are many nations, some of which will seek their own advantage at the expense of other nations. Yet when any person has a grievance, and feels unjustly treated, he is in a mood to stir up trouble. When any section of the human mind is repressed, it finds some outlet for its energies through a destructive, and often subtle, channel. A repressed proletariat, a repressed merchant class, a repressed professional group, a repressed religious sect, or a repressed nation, are always a potential source of disturbance and dissension.

But psychologists find when adequate recognition is made of a repressed emotion or thought, and some pains are taken, not necessarily to permit it to have its way, but to reconcile it to the rest of the mental structure, that its power for damage ceases; because it then works with, instead of against, the larger organization. They find, also, in settling labor disputes, and even in larger political issues, that a minority recognized, and such measures taken as will convince it that at least it has had a fair hearing, tends to remove the animosity, even though the minority is not given that for which it asks.

In any form of government, therefore, if it is to remain stable, it becomes fundamental that every group — in the United Nations Organization, every country, and in the U.S., every state — and in so far as possible every individual in it, must be given ample consideration and a square deal. In the modern world, disputes must be settled through all the relevant facts being discovered and made public, with conciliation and just arbitration based on these facts instead of violence or war.

As political measures arise, the cosmic alchemist will work for those that promise an increase in productivity, for those that give assurance that there will always be remunerative employment for every person who will work, for those that tend toward the widest practical distribution of wealth, for those that will give economic and cultural advantages to the greatest number of people, and for those that insure adequate consideration of, and a square deal for, everyone, including even the disfavored individual and the unpopular minority.

At all times he will work vigorously for these and other measures which, to the best of his knowledge, will advance all the people of the world toward freedom from want, freedom from fear, freedom of expression and freedom of worship.

Chapter 4

Serial No. 167
Original Copyright 1946
Elbert Benjamine

Copyright
August 2002
Church of Light

Heredity and Environment

Illustration of hereditary combinations.
Open circles represent normal genes.
Shaded circles represent defective genes.

Diagram No. 1.

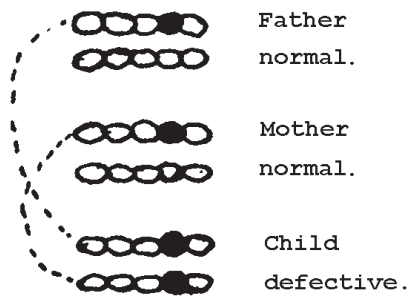

Diagram No. 2.

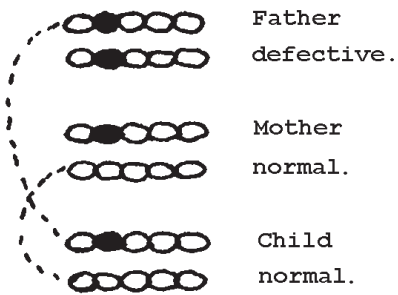

Illustration of hereditary combinations.
Open circles represent normal genes.
Shaded circles represent defective genes.

Diagram No. 3.

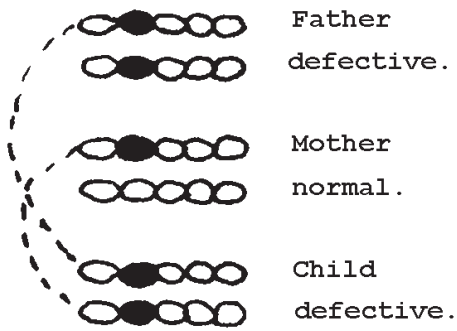

Diagram No. 4.

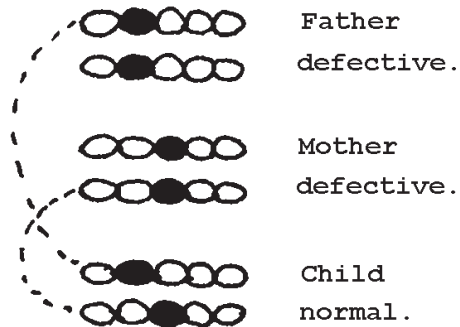
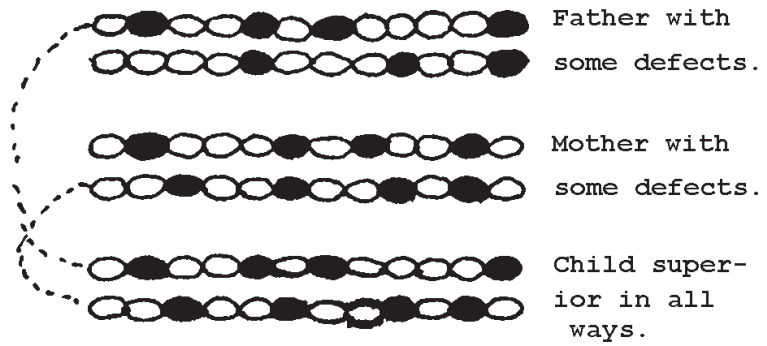

Illustration of hereditary combinations.
Open circles represent normal genes.
Shaded circles represent defective genes.

Diagram No. 5.



Chapter 4

Heredity and Environment

MANY theories for the betterment of the human race seem so plausible that they strongly seize the imagination of the partially informed and are rushed into legislation on the tide of well-meaning enthusiasm. Already certain eugenic measures have been seriously considered by some of the law-makers, and the future may well bring to pass a demand for legislation aimed at bettering the human stock through permitting only a favored class to bear children.

Not only is this method highly impractical, except for weeding out a very small group of defectives, as will later be explained, but it may be used by the politically unscrupulous as a club held over those who fear being deprived of parenthood. And what is even more significant, it may also be used to blind the people to the importance of superior living conditions as a far more effective means by which may be developed a higher type of man.

It is true that Nature has made use of selective breeding to perfect her various forms, and that stockmen use it successfully in developing superior strains, as do florists and nurserymen. Why, then, the layman has a right to inquire, cannot the same methods be used to produce finer strains of humanity?

Selective Breeding

—Undoubtedly they could if as ruthless methods were applied to human breeding as to the production of other stock. The first principle of successful selective breeding requires innumerable individuals from which to select only the few individuals which show qualities in the desired direction. All the rest must be prevented from propagating. Out of twenty thousand young plum trees, for instance, Burbank would select not over a dozen, and the balance would be consigned to the flames. From these picked individuals, as large a number of offspring would be produced as possible, and from these only a few showing desired tendencies would be selected. The others would be destroyed.

By inbreeding, outbreeding, and constant selection, it is possible to build up in animal stock such qualities as are desired. But only by prohibiting the reproduction of any but a very few picked from as large a number of individuals as possible. These

selected few also must then be united to produce progeny, not just as they choose, but between such individuals as the breeder indicates, and he must be able to bring about union between any individuals that fit into his plan.

To start with, he must have a clear idea of the qualities for which he works. Then he must apply his methods with complete thoroughness over a long period of time. Selecting a few individuals showing a tendency in the desired direction, he will mate only these. Then he inbreeds the result, mating brothers with sisters, and parents with offspring, to bring both the strong points and the defects into prominence.

As a result of this inbreeding, a great number of deformed and defective individuals will result, along with a few that show no defects. This host of defective individuals is eliminated, and the more perfect specimens are bred again with close relatives. Again the vast majority are dwarfs, cripples, or in some manner decidedly inferior; a few only showing superior traits. In fact, his object in inbreeding — which is the breeding of close relatives — is to bring the defective traits together, that they may be eliminated from the stock by removing the individuals in which they appear.

Humanity, however, discourages mating close relatives for the very reason that in this manner the defective qualities are brought to the surface and many of the resulting progeny tend to be deaf, blind, crippled, insane, or otherwise defective; even though in a limited few of the individuals so produced certain strong traits are usually accentuated.

But the practical stock breeder unites close relatives deliberately to bring defectives into the world that they, along with the weaknesses they carry, may be eliminated from the strain. Continuing this process to get rid of defects, at intervals he also crosses the few superior individuals left from the discarding process to strengthen the qualities desired, and then for a few generations again inbreeds the progeny to still further get rid of the undesirable qualities by producing and restraining from reproduction other defective individuals. Given such complete control over his stock, with time enough a marked improvement can be brought about.

But I cannot think, at least in our time, that humanity will consent to the deliberate production of defective children, through inbreeding, for the purpose of eliminating them, and the defects they carry, from the human race. Nor that it will consent to prevent all propagation except that of a few individuals selected by a practical breeder, nor that it will permit this breeder to determine whom among these few thus selected may unite. As a preliminary hindrance, I think it would be unusually difficult, with the diverse ideas afloat as to the purpose of life, to get people to agree even on just what qualities for which it would be best to work. Yet with these qualities selected, and a practical breeder in charge, with power to compel breeding as he chose, and to prevent all other breeding, it seems quite certain that a new and superior human type could be built.

Biological Basis of Heredity

—Just why inbreeding tends to bring the defects to the surface requires an understanding of the biological basis of heredity. The microscope and the laboratory, during the last two decades, have yielded a vast amount of definite information on this subject, so that what previously was surmise is now definite knowledge. It is knowledge of the kind that enables the experimenter repeatedly to get a specific result from a specific combination. A very wide literature has developed, dealing with these experiments and microscopical studies; but the limitations of this lesson enable me to touch only the more salient points. And even so, as World War II has now ended, and scientific men can return to the research closest to their hearts, any detailed experiments I might cite will no doubt soon be outdated by others made possible by more highly specialized apparatus.

In B. of L. lesson No. 3, Physiology and Correspondence, I have already made some mention of the chromosomes as the physical carriers of heredity, of how these filaments within the reproductive seed reduce to half their original number before fertile union with a cell of opposite polarity, and how the new cell, which by cell division produces the offspring, thus obtains half of its chromosomes from the mother and half of them from the father.

It is now further known that these chromosomes, which in each species are of a definite number, are composed of many hundred bead-like bodies strung together in a very definite order. That is, the nucleus of the reproductive cells carry filament-like chromosomes, which in turn are made up of bead-like strings of smaller bodies called chromomeres. These chromomeres not only are the physical carriers of heredity, but in a given species of animal each bead in the string always governs some particular characteristic, and always occupies the same position in the string. Thus bead No. 3 may govern the color of the eyes, No. 4 the shape of the nose, and No. 5 the texture of the skin; and it may be depended upon that the given characteristic is governed by the bead of this number, and not by some other bead.

The definite hereditary characteristics which are carried by the chromomeres are called genes. But the foremost biologists do not assert that the physical beads, or chromomeres, are the actual elements of heredity. They say that the actual elements of heredity, whatever they may be, always seem to be associated with these physical beads according to a definite plan. From the standpoint of occult science, the actual elements of heredity are the vibratory rates in the astral substance associated with the beads. But because the elements of heredity are so associated, it is convenient to use these physical beads, that may be seen with a strong microscope to be strung along the filaments of the chromosomes, as the actual genes.

One string of genes is supplied by the mother, and one string by the father, so that for every hereditary characteristic there are two beads, one of the pair furnished by each of the parents. And No. 3 in each string has to do with the same characteristic, so that both members of the pair always have an influence, let us say, over the color of the

eyes. Each member of any pair of genes, one of the pair being furnished by each parents, thus always has the same general function.

This doubling of the genes is nature's insurance against defectiveness; for commonly if one member of the pair is defective, the other sound gene has strength enough so that no defect appears in the offspring. That is, if the gene from the mother governing hearing is defective, the mother being deaf, and the same gene from the father is sound, the offspring would show no weakness in this respect. But if both members of the pair were defective, the offspring would be deaf.

The normal gene, because of its strength to impress its qualities on the offspring, is called dominant; and the defective gene, because it has much less power to influence the offspring, is called recessive. As a matter of experiment it is found, according to the long recognized Mendel's Law, in random matings when the dominant genes and the recessive genes for the same characteristic are equally numerous that the offspring show the characteristics of the dominant genes three times as often as they show the characteristics of the recessive genes. This results because when a dominant gene pairs with a recessive gene the dominant characteristic shows, as it does also when a dominant pairs with another dominant. Only when two recessive genes governing the characteristic are paired does the defective trait commonly appear in the offspring.

Dominant genes that are a disadvantage do occur, but are extremely rare. One, for instance, is that which causes the fingers to have only two joints instead of the normal three. But usually the dominant gene of a pair determines a characteristic that is beneficial to the individual. In a state of natural competition between forms of life there is thus a gradual weeding out of the recessive genes through the failure to live and propagate of those individuals that are weakened by the possession of two defective genes of the same pair.

CHILDREN INFERIOR TO BOTH PARENTS (See diagram No. 1): This also explains why children sometimes possess characteristics that are exhibited by neither of the parents. In both parents, and perhaps in the more remote ancestors as far back as can be traced, because in each instance a recessive gene was paired with a dominant gene, the characteristics were strong and normal. In their children, likewise, it would be possible that the dominant gene of one would unite with the dominant gene of the other to produce normal results. Also, if the dominant gene of one united to the recessive gene of the other, the result would be a normal child. Or if the recessive gene of the one united to the dominant gene of the other the result would be normal. Any one of these three combinations would produce a child normal like the parents.

Averages, where human reproduction is concerned, according to the teachings of occult science, are upset by the mental attitude of the parents previous to, and at the time of, conception. But if we disregard mental and emotional factors as having an influence, on the average of one child out of every four, from parents such as we are considering, would be defective, and thus unlike either parents, because it would get the one recessive gene from the father and the one recessive gene from the mother in the same pair. Thus from two sound parents can be born, through the known laws of inheritance, a child that is feeble-minded, deaf, blind, lame, lazy, irritable, or incorrigible.

CHILDREN LIKE SUPERIOR PARENT (See diagram No. 2): If one parent has a pair of genes composed of one dominant and one recessive, and the other parent has the same pair composed of two recessives, the one parent will be normal and the other parent will be defective. Under such circumstances a child may receive a gene that is recessive from one parent, and a gene that is dominant from the other parent, and thus be quite normal, like the superior parent.

CHILDREN LIKE INFERIOR PARENT (See diagram No. 3): Or from the same parents a child may get a defective gene from the father and a defective gene from the mother, both in the same pair, and thus exhibit the weakness of the inferior parent.

CHILDREN SUPERIOR TO BOTH PARENTS (See diagram No. 4): Feeble-mindedness, indolence, incorrigibility, irritability and other deficiencies often arise in different people from genes that are not of the same pair. That is, two people may both be feeble-minded, but not exactly feeble-minded in the same way. Two people may be deaf or blind, and the deafness, or blindness be a slightly different kind of deafness or blindness, arising not from the same, but from adjoining pairs of genes. Of course, in people who are closely related, a defect affecting a given part usually arises from the same pair of genes, but with people not closely related it may well arise from genes lying in quite different pairs.

The defect for feeble-mindedness may come from one pair of genes that are recessive in one individual, and from another pair of genes that are recessive in another individual. These two, when they unite, may then contribute one dominant gene to each defective pair of the other, so that both pairs of genes in the offspring have one normal gene. Thus from two feeble-minded parents it is quite possible to get children who are bright and intelligent, superior to both parents.

GENIUS (See diagram No. 5): Defective genes are scattered very thoroughly throughout the human race. When the happy combination of genes occurs in which the defective genes of one parent are paired with normal genes of the other parent, they become supplementary, and bring forth a strong trait. And sometimes the defective pairs of one string may be united only to normals in the other string, and the recessives in the other string only to normals in the one string. Thus the strong points are all brought out, and the weak points from both parents are entirely submerged. To the extent this takes place, we have an individual who in all respects is superior.

We have discussed these strings of genes as if they were each an unbroken string, when as a matter of fact there are a number of sections of filament, each section called a chromosome. From the father, then, a child may get a certain segment from either the father's father, or the father's mother. Certain genes that do not give much evidence may come from still more remote ancestors, and be carried along unnoticed until brought into combination with another segment that permits them more pronounced expression. That is, in outbreeding, such as is the custom of humanity, the hereditary genes of the 48¹ distinct chromosomes that are contained in each human reproductive cell have opportunity to make an infinite number of different combinations, producing very diverse individuals. And when certain unusual combinations occur that afford supplementary genes that cover up common defects, and that bring a number of striking dominant genes together as qualities in a single individual, we have the physical requirements for genius.

Like Produces Like

—Tall parents have more tall offspring on the average, because the genes giving tallness are more numerous than those giving shortness. Yet on the average some short offspring will occur, because the parents nearly always have some genes giving shortness. So with eye-color, with facial resemblance, and with traits of character. People of the same family more often resemble each other, because they have more genes in common than people not of the same family. Yet, on the average, because of the diverse manner in which genes combine, the difference between members of a family are about one-half as great as the differences between those not closely related. That is because, and not in violation of, the known processes of inheritance, certain members of a family are unlike other members of the same family.

Furthermore, because the method employed in the human race to improve it has been to cover up the defective genes through marriage with another who has the same genes normal, we find about the same genes, or inheritance factors, scattered throughout the human race. People, mostly, who are inferior, delinquent, criminal, stupid and otherwise defective because of inherited traits, merely happen to have two defective genes in the same pairs, while the normal individual has more normals paired with the same defective genes, and the decidedly superior person has a happy combination in which the defective genes in both strings are largely supplemented by a dominant of the same pair.

This covering up process has gone on from primitive times. The laws of the tribe usually do not permit individuals of the same clan to marry. A man of one totem must marry a woman of a different totem. The utmost pains are taken by savage people, and laws are passed in civilized countries to prevent close relatives from marrying. The marrying of close relatives, because the genes are so similar, tends to bring the

1 At the time of this writing it was thought human body cells each contained 48 chromosomes. In fact, we now know each human body cell contains 46 chromosomes.

defective genes into pairs, and the dominant genes together in other pairs. This pairing of recessive genes results in defective individuals. But when by marriage with one to whom there is no close relationship, a dominant is paired with a defective, the defective gene is not removed from the race, for it will still persist and will be passed on to the next generation. Yet it is covered up, and the individual who carries it, and who passes it on, is normal.

Because the various genes, both normal and defective, have been so thoroughly scattered throughout humanity, the eradication of deficiency due to recessive genes is too slow to make the claims of eugenics very attractive. Although the time may come when by chemical analysis, or by other means, it can be determined what genes an individual carries that are dominant and what genes he carries that are defective, there is no way at present to determine this except in the small class of individuals who have both members of a pair recessive, and are therefore deficient. Yet these represent but a small number of those who possess at least one of the defective genes, and who therefore are carriers of it, so that in the next generation it may pair with another recessive, and defectiveness result.

According to the latest statistics available, the feeble-minded make up about 1/3 of 1% of the population, say 440,000 in the U. S. A. Supposing these all to be due to heredity, they each have a single pair of defective genes, and by calculation the known proportion of those who have a single gene to those who have both members of a pair alike, it works out as 10% of the population, or say, there are 13,200,000 normal individuals who carry feeble-minded genes. There is left, then, some 118,360,000 people in the U. S. who carry no feeble-minded genes.

If it were possible to prevent the 440,000 feeble-minded and the 13,200,000 carriers from producing offspring, hereditary feeble-mindedness would disappear in a single generation. But at present there is no way to distinguish the 13,200,000 carriers from the 118,800,000 who are not carriers of this defective gene.

According to R. A. Fisher, 11% of the feeble-minded of any generation come from the mating of those who are feeble-minded, and 89% come from the mating of the normal individuals of the carrier group. We thus could get rid in one generation of 11% of hereditary feeble-mindedness by prohibiting all feeble-minded persons from bearing children; but the carrier group would still produce 391,600 feeble-minded, and after the 11% were removed further reduction would be increasingly slower. So slow that Fisher computes that if the proportion of the feeble-minded were one in a thousand normal individuals, that it would require 68 generations, or two to three thousand years, to reduce the number to one in ten thousand normal individuals by prohibiting the feeble-minded from propagating.

There can be no doubt that certain individuals should not be permitted to propagate, and I have no intention of disparaging the value to society of getting rid of 11% of defectives of certain types in the first generation by making it impossible for them to bring children into the world. But at the same time I do not feel that a process that requires thousands of years to reduce the number to one-tenth their present strength,

and that would not completely eradicate them even after several thousand years more, holds forth any great promise of effectively eliminating from our midst the delinquent, the feebleminded, the insane, the criminal, and the otherwise seriously defective.

There are, however, four other methods — the mental, the astrological, the radiational, and the environmental — each one of which offers the hope of much swifter and satisfactory solution to the problem. The mental yet requires competent experimental research to determine just what results may be expected from it. The radiational method also requires experimental work to develop a proper technique. But enough is known about the astrological method and the environmental method to make it quite certain that swift and positive results of a most favorable nature may be obtained from their application.

The Mental Method

—In the ancient mysteries it was taught, as I have explained in detail in B. of L. Course 4, *Ancient Masonry*, that the power of thoughts and aspirations of the parents preceding their union have a definite influence upon the general type of soul attracted to them for incarnation. And it was emphasized that in addition to the general level of harmony or discord maintained customarily by them, that the specific thoughts and emotions, as well as their intensity, at the time of union attract to them, by the magnetic field thus set up, a soul that corresponds closely in its aspirations and in its harmonies and discords, to their combined thought energies then set in motion.

Although their teachings also embraced the effect of loving emotions and kindly thought images to rejuvenate and revitalize each other, the most important part of the ancient Ansaitic Mysteries revolved around how, through formulating and holding an ideal mental pattern, superior children might be brought into the world. The teaching was known to initiates as the Legacy of Aphrodite.

Now it is anything but scientific to draw conclusions from a few known instances. But every now and then through the newspapers, or through personal acquaintance with the case, instances are brought to the attention in which one parent, being deeply in love with someone from whom separated, holds the image of this loved one in the mind strongly and constantly, and that a child is born greatly resembling this absent person, who is not the other parent.

As a single instance of this power of mind to shape the image of the unborn child, there was given in the Los Angeles Daily News, issue of Feb. 13, 1931, the picture of Nancy Ellen Crouch, 9 years of age, together with the picture of the bust of a child by Tochini, showing the remarkable resemblance between the two. This bust was then 130 years old. The father is quoted as saying that previous to the birth of the daughter he had loved this bit of statuary ardently, had it in his mind almost constantly, and even called it his little marble daughter. Is it any wonder that the child was an almost exact image of the face portrayed in marble?

Just how potent such mental influences are will never be known until experiments are made and data carefully collected to determine it. But we do know that from the same parents are born children possessing the most diverse qualities. With a million sperms present, containing, we may suppose, strings of genes derived in various proportions from different ancestors, there is opportunity for unusually favorable, or unusually unfavorable, combinations. Unlike Hereford cattle, or Reid's yellow dent corn, humans do not breed true to type, because strains have not been made permanent through inbreeding and selection. Something, nevertheless, determines that one particular sperm out of the million present shall reach and fertilize the ovum. Something determines that the gene string furnished by the female, likewise, is one string and not another.

I know of no experiments to determine if the thoughts and aspirations of the mother previously have an influence on which string of genes is expelled and which retained during the process of maturation. Nor to determine if the combined thoughts of both parents at the time of union give a magnetic polarity to a certain sperm that enables this particular one of the million present to reach and fertilize the ovum. These things have not been experimentally determined yet, but they offer a most attractive and useful field of investigation.

We do know, however, that something, and not mere chance, determines the string of genes possessed by the fertilized egg, and that, consequently, will be possessed by the child. And we do know that in both plants and animals when the gene combinations are supplementary that there may be striking results. Certain races of maize, for instance, both of which are short, weak, spindling, and producing almost no yield of corn, when mated together give large, vigorous offspring with a high yield of corn. Also, our great geniuses often have brothers and sisters who show no remarkable traits. Either the thoughts and emotions of the parents were different when genius was conceived, or some other condition was present, that determined the unusual combination of genes that made genius possible.

The Astrological Method

—Of these other conditions the planetary influences at the time are certainly most potent factors. By gauging the time of conception one may determine, within certain limits, the kind of birth chart a child shall have. Looking 273 days ahead in the ephemeris will indicate the sign the sun will be in at birth, and also the distribution and aspects between the heavier planets. It is true that conception may not be coincident with union. But in several instances known to me personally in which the time was selected for union with a view to having a child with a particular birth chart, following the general rule regarding the prenatal epoch and birth, in each the degree of the moon at the time of union became either the degree on the Ascendant or Descendant, as indicated by the rule, at the time the child was born.

I must confess, however, that on several other occasions I have assisted friends to pick a time for union that would give the child an unusually favorable birth chart in

which the results were not so favorable because there was no conception. It is doubtless too much to expect that merely by picking a favorable time for union that just any combination of parents can give birth to a marvel of intelligence and nobility. In the instances cited, it may have been that the emotional and mental levels of the parents were not high enough to attract a soul of the marked qualities they hoped their child to possess, or it may have been due to other conditions.

Usually the planetary configurations to give an unusually favorable chart are present only at rather long intervals, and parents who desire children often do not care for the postponement necessary to bring a child into the world during one of these exceptional periods. But even within the period of a year some times are far more favorable than others. If, for instance, two heavy planets are in opposition, it is possible to have a child born when the sun is square to both, or when the sun is trine to one and sextile the other. Furthermore, the rather limited experience I have had with the selection in advance of the birth chart of a wanted child convinces me that the selection of the rising sign by observing the position of the moon at the time of union is not only well worth while, but quite feasible. Anyone who is familiar with rectification of the horoscope by means of the prenatal epoch, as explained in lesson No. 117 will be able to determine, by means of the same rule, when a child should be conceived to have a certain birth chart.

Undoubtedly, we still have a great deal to learn about predetermining the birth chart, and thus the character of the child, through the application of astrological laws; but my own observation of actual results thus obtained convinces me that even with our present knowledge we can improve the race through this means quite rapidly and effectively. It is well worth a trial, instead of the ordinary hit and miss method, by anyone contemplating the bearing of offspring.

The Radiational Method

—Aside from the unusual individuals produced by unique gene combinations, we have in nature other marked alterations produced by changes in the materials of which the genes are composed. As observed by intensive study, the unknown agent in nature that commonly causes the change is so minute that it affects only one of a pair. When, however, the substance of which the gene is composed is changed, the characteristic it influences in the offspring is likewise changed. Furthermore, the divergence from type is an inheritable quality. That is, any changes in the structure or functions of the offspring that are brought about by alterations in the substance of the genes — and such changes often are remarkably great — become a permanent acquisition of the strain. Such changes are observed in nature, often giving entirely new types. And these new types breed true. From such mutations, as they are called, new strains also are derived under artificial conditions.

Most mutations, as observed experimentally, are disadvantageous to the organism. But as occurring in nature, some are no doubt advantageous and give a superiority that enables the organism to survive in competition with others in which the new characteristic is lacking. Hundreds of new varieties of animal life have been produced in the laboratory by artificially stimulating mutation. These new varieties breed true to the new type; and it is quite certain that in nature new species are derived through a similar process.

One of the most interesting things about these mutation is that they can be, and are, produced by radiations. It is interesting, among other reasons, because we are just moving into a period of history in which atomic fission apparently will be used widely as a source of industrial energy, as well as in bombs during warfare. And atomic fission is accompanied by radiations of great power. The question is thus raised not merely how extensively these radiations may cause mutations in the plants and animals accessible to them, but also what mutations they may cause in the human species.

It is known, through extensive experiments, that when a developing organism is exposed to the X-ray, which is less powerful than some of the radiation of atomic fission, that some of the genes are altered without being destroyed. Not all the genes are so altered, but enough of them that the resulting organism is an entirely new type. Other radiations in nature also affect the gene structure. Babcock and Collins, as well as Hanson and Heys, carrying out extensive investigations, are of the opinion that the mutations that are known to take place in nature, and that occur spontaneously in the laboratory, result from some natural source of radiation. They bred fruit flies in a region where there was little radiation, and others in a region where the radiation was known to be about twice as great. It was found that the number of mutations was much greater in the region where natural radiation was most intense. As yet we have not advanced far enough in our knowledge of the effect of such radiation upon the substance of the genes to be able to apply it intelligently with a view to changing the genes in a manner that will give desirable and predetermined results. But with the knowledge that the genes, and thus the inheritance factors, can be thus influenced, we may hope confidently that the method, more and more, will be brought under control, and ultimately, through preliminary experiments on lower forms, be brought to a state of perfection in which it may be applied effectively to the betterment of the human stock.

In the experiments referred to, the radiations were those of radioactive minerals within the earth's crust. But these, X-rays, and the emanations accompanying atomic fission are by no means the only radiations that possibly may produce a profound effect upon the structure of the genes. Both the thoughts of the parents and the radiations of the planets may very well, not merely determine the gene combination which takes place at conception, but also may have an influence to alter the gene material at the time of union and during the process of gestation. Material science, I know, scoffs at birth-marks, and all such influences of the mind of the mother over her babe during gestation. But the number of those who read this who personally

know of instances where happenings to the mother have impressed themselves on the babe is so great that I feel it unnecessary to offer comment or detailed proof.

Sex-Linked Characteristics

—Just at this point, and before a discussion of the environmental method of improving the human stock, some mention should be made of sex-linked characteristics. These characteristics explain why the daughter always inherits certain characteristics from her father, and why the son always inherits certain characteristics from his mother.

It has been found in certain animals, notably insects, that the female at the very beginning of its existence as a single cell always has one more chromosome than the male. The female has an even number of chromosomes, the two of each pair being alike; but instead of one of these pairs the male has a single chromosome, called X chromosome. But in other animals, including man, the X chromosome of the male has for its mate a minute and rudimentary chromosome, called the Y chromosome. The Y chromosome does not appear in females. This makes it possible to trace a particular X chromosome, or a particular Y chromosome, from one generation to another, along with the group of characteristics determined by its genes.

The germ cells of a woman contain 48 chromosomes, including two X chromosomes. The germ cells of a man contain 48 chromosomes, including one X chromosome and one Y chromosome. The X chromosome of a father, together with the different characteristics it influences, always passes from a father to his daughter, never to his sons. The sons always get their single X chromosome and the different characteristics it influences, from the mother, and never from the father. Thus it is possible to trace from generation to generation, from father to daughter, and from mother to son, those particular qualities that are gathered together in the chromosome that also determines sex.

This discovery of the sex chromosome also substantiates a very ancient occult doctrine; the doctrine that a male is a male, and a female is a female, from the very moment of conception. This doctrine was brought into some question through the discovery of the effect of the endocrine glands in altering secondary sex characteristics. But if the present teachings of biology are correct sex is far more deep-seated than any external qualities or actions. Gland treatment may cause a female to develop strong male tendencies and a masculine appearance, but the real sex is part and parcel of the cells. At conception, if there are two X chromosomes the child is a girl and its germ-cells will always have two X chromosomes. If at conception there is an X chromosome and a Y chromosome, the child is a boy, and its germ-cells all continue to carry the Y chromosomes. A female soul may have a body that expresses masculine characteristics, but the germ-cells, each containing two X chromosomes, definitely determines the sex as female. Nor can we imagine a male soul incarnated in a female form. Such impressions are due merely to external appearances.

The Environmental Method

—Thus far we have considered the genes as if they of themselves produced the characteristics observed in heredity. But experiments very completely show that the genes produce certain effects under one set of conditions, and that under another set of conditions the same genes give rise to very different attributes.

Thus an individual that normally would become a female, having two X chromosomes, develops many male characteristics if the male hormone is caused to circulate in its body, or if its ovary is removed and a male gland is substituted. A child that otherwise would become a cretin, a dwarfed imbecile, becomes an intelligent, normal person when fed thyroxin. And this thyroid chemical can be manufactured synthetically, as can the active principle of some of the other endocrine glands. Thus, to a great extent, the genes are dependent upon the endocrine glands in developing their hereditary traits, and the glands in turn, to manufacture a normal quantity of their secretion, are dependent upon certain vitamins and other factors in the diet. Thus can certain hereditary traits be altered and certain hereditary deficiencies overcome by supplying the factors that enter into the composition of the gland secretions.

Not only do the vitamins profoundly affect the development of an organism, but many instances can be cited in which the external environment affects a hereditary character. Thus R. A. Emerson found that the hereditary color of maize may be altered by growing conditions. Red plants produce red offspring, and green plants produce green offspring. Yet true red plants grown in the shade are green like the green plants which are green through heredity.

To what extent characteristics which are acquired through the influence of environment are inherited by the offspring is at the present moment a subject of debate among scientists. But there is increasing evidence that, at least in some degree, such acquired characteristics are inherited. And at least we have irrefutable evidence that in spite of inheritance suitable environmental conditions can eliminate most disease, can cause those who otherwise would be criminal to be straight-forward citizens, and can increase not merely the knowledge of the individual, but also his ability to learn.

A tendency toward tuberculosis, toward diabetes, or toward some other disease runs in certain families. That is, there is a hereditary weakness which is handed down from one generation to the next. But under environmental conditions in which the individual gets proper foods, fresh air and sunshine, and does not come in contact with the tubercle bacillus, he does not have tuberculosis even though his ancestors and the other members of his family have died of it. Nor, if he avoids cane sugar and the emergency emotions, is he apt to get diabetes even though this disease has afflicted the members of his family for generations.

The tendency toward insanity is handed down, from generation to generation in certain families. Yet when these people are given instructions as to what to expect during the period of puberty and menopause, and perhaps given hormone treatment to ease the strain, they weather these periods with no great mental difficulty. And when instructed on the cause of mental breakdown, as explained in lesson No. 159, and are shielded from too severe impact and stress, they often remain quite normal throughout long lives.

Heredity is not a force or entity set off from other conditions of development. It is something that develops in one way under certain conditions, and in another way under other conditions. And experienced biologists have come to believe that any kind of change of characteristics that can be induced by altering genes, can likewise be induced (if we know how) by altering conditions. The fundamental urges of life, whose strength and harmony or discord are mapped in the human birth chart, cannot successfully be repressed. But, as explained in detail in lesson No. 157, they can, by proper environmental conditions, be conditioned to express through constructive and beneficial channels. A child born with a strong drive for significance, as indicated by a prominent birth chart Sun, will struggle all his life to gain the esteem of others. If, at a very early age, he finds he can gain that significance through leading a gang of young hoodlums on pillaging forays, the satisfaction he derives from being looked up to as a daring leader by his irresponsible associates is apt to condition him to become a leader in criminal activities in adult life. Or if he is hungry as a child, and can only satisfy that hunger by stealing food from the neighborhood vegetable stands, he becomes so conditioned that later in life he is apt to turn to burglary as a profession.

Yet had the environmental conditions been such as to enable either child to have satisfied his quite natural urges through socially beneficial behavior, he would have grown to become an honest and useful citizen.

Chapter two of the reference book, WHEN AND WHAT EVENTS WILL HAPPEN, gives the details of experiments with twins and with the children of those feebleminded, and lesson No. 155 mentions them in less detail. True twins, identical twins that are formed before birth by halving of the original fertilized egg, carry exactly duplicate sets of genes, and thus have exactly the same hereditary characteristics. Intelligence tests given such twins who have grown up together have been found to be practically identical, but when the twins have been separated since early childhood and reared amid quite different social and intellectual environments, the difference in their IQs and the difference in their mental and emotional attitude toward the same situation is as great as if they belonged to different families. And it has been found that the orphans of feebleminded parents, when adopted by, and reared in, highly intelligent families, have an IQ not below, but well above normal.

Instead, therefore of encouraging doubtful legislation for the eradication of criminals and defectives through wholesale sterilization, the cosmic alchemist will encourage the study of the power of mind, the power of radiation, and the power of gland extracts, to improve the offspring. He will advocate predetermining the astrological birth chart, and he will work unremittingly to raise the general standard of living throughout the world.

Chapter 5

Serial No. 168
Original Copyright 1946
Elbert Benjamine

Copyright
August 2002
Church of Light

How To Be Spiritual

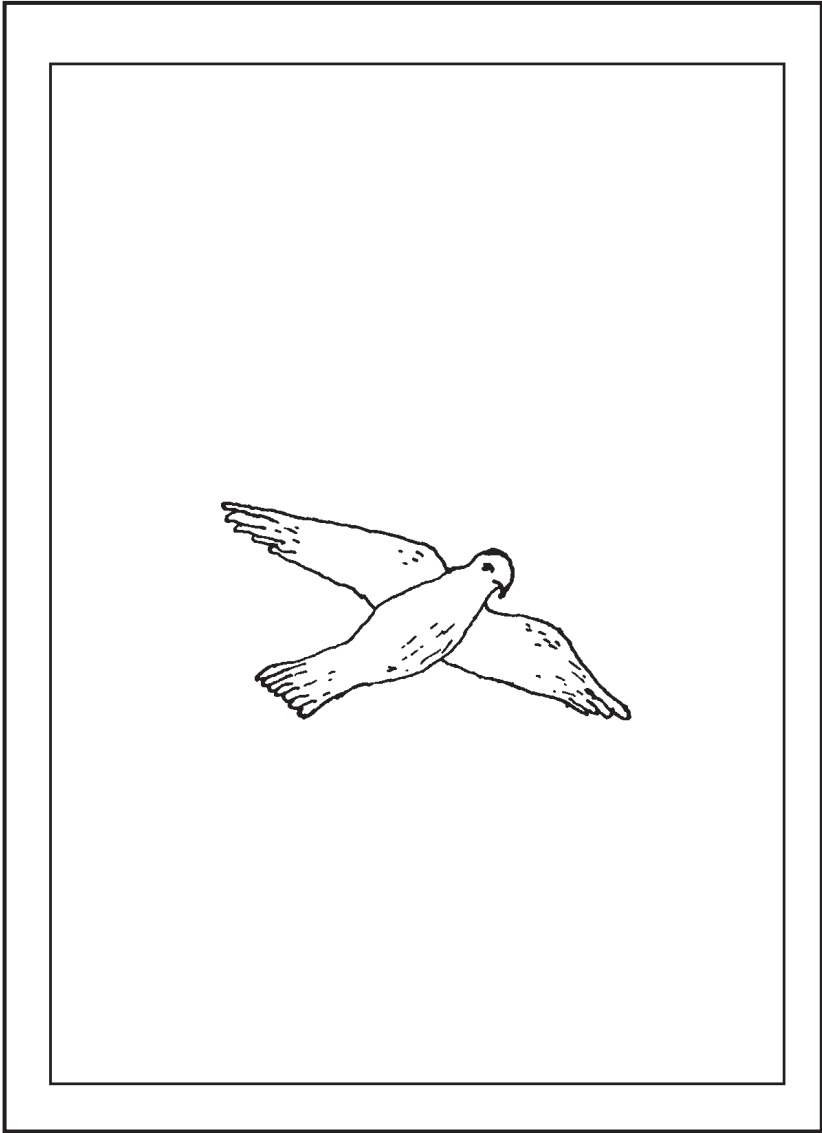

Chapter 5

How To Be Spiritual

BEFORE any attempt is made to give instructions on how to be spiritual we must first have a clear cut idea of what is meant by that term. Before we can intelligently discuss how to get something, we must first know what it is that we are trying to get. Yet the idea of spirituality commonly held is anything but clear cut and well defined.

To be sure, the word “spiritual” is to be heard on every lip in all those circles which converse so fluently about the aspirations of the human heart. Yet I can recall no word that conveys so many divergent meanings, or about which, in the minds of those who speak of it most frequently, there is such utter confusion. It seems to be taken for granted, by those who write and talk so assuredly about it, that there is nothing of higher import to man; yet, when pinned down to any clear statement, opinions differ as widely as the poles, or at least as widely as West is from East; for the Oriental conception of spirituality varies from the Occidental conception no less than the dreamy, passive temperament of the peoples of such languid climes is opposed by the aggressive, red-blooded enterprise of a temperamentally vigorous and virile race.

There is prevalent today an Oriental notion of spirituality that arises from the view that life is an intolerable condition to be endured only because it is forced upon the individual and cannot be avoided, and that whatever effort must be expended may best be devoted to those acts which will enable the individual to escape from the wheel of karma and rebirth into the negation of nirvana. But entwined with these purely Oriental notions are numerous inheritances from Christianity, long since outgrown in their actual practice, but which theoretically are expounded as spiritual virtues.

No one is so impractical, for instance, as to insist that a gangster shall take still other of his belongings when the gangster, either by force of arms or by law, takes part of them; although we are still taught from the pulpit it is a virtue to give a man one's cloak if by law he takes away one's coat. Nor when smitten do we turn the other cheek; for if we did we should suffer the fate of those adjoining nations that offered no resistance to Hitler, or the same fatality that overtook the one who gave this precept. Most of us recognize that the doctrine of meekness leads to slavery, and that instead of mourning being a blessing, it is psychologically a crime. Yet these and a

dozen other notions, including the idea that Deity is pained to see man enjoy himself, and that the saintly life is lived only by those who make themselves unusually miserable, are vaguely blended with Oriental views on the desirability of escaping life, and together comprise what passes among many for spirituality.

The Oriental views I have discussed in some detail in lessons No. 20, No. 21, and No. 129; and in lesson No. 129 I have analyzed some of the obvious absurdities of Christianity. Here, therefore, I shall not consume space by discussing such ideas. Nor are they here mentioned in a carping, fault-finding spirit; but only because no clear conception of real spirituality can be presented without at least thus briefly sweeping away the rubbish and debris with which the centuries have covered it; and because, further, it is only fair to make plain at the start of this discourse that there is a distinctly Western conception of spirituality which is quite dissimilar to either that of the Orient or that of orthodox Christianity.

This dissimilarity is most pronounced. For instance, the Western cosmic alchemist places very little emphasis on what people are not to do, and instead of the many prohibitions of the Orient, and the thou shalt nots of Christianity, he constantly insists that something should be done, and points out specifically what that something is.

Instead of a vocabulary of Sanskrit words that to most Western students may mean nothing or anything; instead of the Latin and psychological pageantry employed by the Roman Catholics to impress their devotees with the holiness of their leaders; and instead of the ambiguous and contradictory passages that Protestants make mean anything they wish, and thus are able to present a Scriptural quotation to prove whatever they may desire; the Western School uses as plain language as possible, carefully defines such technical terms as must be employed, and if any feeling of mystery lingers in the student's mind, deems that its work has been ineffectually presented.

Then again, a certain mood of fatality and inevitability is engendered by the Eastern doctrines; and while predestination is not so vigorously debated in the Church as it once was, the conception still prevails in Christian circles that instead of being dependent upon initiative, intelligence and effort, man is largely dependent upon the grace and mercy of a Divine Being who can be wheedled into granting special and quite unmerited favors.

But the cosmic alchemist perceives that all nature is under law, and not subject to the whims and caprices of either Jehovah or His Son. That there are intelligences higher than man he has good reason to believe. Nor does he scoff at prayers, but considers that they also operate under laws; and these laws he strives to understand. He believes, furthermore, that there is an all-pervading Deific Intelligence Whom he calls God. But above all, he emphasizes the importance, not of permitting things to happen because apparently they are foreordained, but of applying initiative and

intelligence towards making those things happen which he deems to be in the direction of individual betterment and human and universal progress. He considers man not merely as an inert and passive creature, but as a dynamic force capable of uniting himself to Deity for the purpose of accomplishing a useful and progressive work in the constantly expanding domain of universal development.

Spiritual Values

—Now either spirituality is real, and has come meaning to life, or it is a vague nothingness. If it has a value to life, it must contribute either to quantity or to quality; that is, to length of life or to its richness, because aside from these two there can be no value.

Orientalists imply, with their doctrine of repeated human births on earth, that the region where the human soul can effectively express itself is more restricted and narrow, while Western cosmic alchemists find innumerable realms in space in which, by means of finer vehicles, mankind can work and develop and continue a vividly self-conscious and progressive existence. But if life has a value, both its duration and what is thought, felt and done in its duration are significant.

We never hear the term spirituality applied to mere duration of life. At least the duration of physical life cannot be used as a measure of spirituality. For although a Sequoia tree may gain experiences that contribute quality during its existence, it is probable that its spirituality is much less than that of many men who live less than one-fortieth of the time it thrives on earth. Yet duration of life, because it affords the opportunity to develop the soul, and affords man the opportunity to gain spiritual treasures, has a very real value.

Mere duration of life is not spirituality, as spirituality depends upon how the duration is utilized. The opportunity is not the treasure; but has a value in that it makes it possible to obtain the treasure. Yet aside from this duration, which has spiritual value only as an opportunity, there is left of life only one thing of value, and that is the quality of life. Consequently, true spirituality must in some manner relate to the quality of the thoughts, feelings and actions of life.

Experiences add states of consciousness to the soul, and these through increasing the knowledge give a certain quality to the life. Yet many thoughts, feelings and actions while affecting the quality of the life do not increase its spirituality. Spirituality is not intelligence, it is not merely activity, nor is it merely knowledge, nor all of these three. It is not the quality of life resulting from its complexity, but the quality of life that, irrespective of its complexity, tends to lift it to a higher level.

Even as physical objects have two other dimensions than that of length, so has life two distinct and different measurements of quality. Of course, considered from the standpoint of the movements of a physical, and therefore three-dimensional, entity, time is the fourth dimension. But when we measure states of consciousness we must consider life from another view. And as we are familiar with three dimensions, all at

right angles to each other, for the sake of simplicity of illustration let us also consider life as having three dimensions, all at right angles to each other and thus to be measured much as we measure the volume of some physical object.

From this analogical viewpoint we may as well consider time as most people do, as the measure of the length of life. As the breadth of anything is measured at right angles to its length, from this view point it would seem that the breadth of life would be measured by the number, variety and intensity of its experiences. Thus in one of its dimensions a life is rich in proportion to the amount of thought, feeling and action packed into it.

Yet however active a man may be, however varied his experiences, however much he has felt, and however much knowledge he has acquired, from these and the length of his life its value cannot be completely measured. To appraise its worth, in addition to these two measurements at right angles to each other there is needed another measurement at right angles to both of these, even as to measure physical volume the thickness of that which is to be measured must be ascertained as well as the length and breadth. This dimension of thickness, when applied to man's life, relates to the refinement, or vibratory level, of the thoughts, feelings and actions. It is the distance these are above those of the brutes. It is the lowness or the height of this vibratory level that affords, regardless of the length of the life or its richness in breadth, the true measure of its spirituality.

In the first lesson on *The Next Life*, lesson No. 173, it is explained that there are innumerable levels of the inner-plane world, on each of which life exists. Each level has its own basic vibratory rate. And it is there pointed out that everything has a dominant vibratory rate, and that on the inner plane the principle of resonance supersedes the law of gravitation. Not only after physical dissolution, but in so far as the astral form and soul are concerned while they are still in the flesh, people gravitate to the inner-plane level the basic vibratory rate of which most nearly is that of their own dominant vibratory rate. This attraction is as inevitable, and as powerful, as is the force of gravitation to hold their physical bodies to the earth.

Thus from the inner-plane effect we have a quite clear criterion of that which tends in the direction of spirituality. Any thought or experience which tends to raise the individual's dominant vibratory rate tends to increase his spirituality, and any thought or experience which tends to lower his dominant vibratory rate decreases his spirituality. This dominant vibratory rate is little influenced by knowledge as such. But it is powerfully influenced by the emotions.

Knowledge when used for selfish ends, to enslave others, and to find means to enable the individual to be more brutal, detracts from spirituality. The lowest astral levels are inhabited by those who while on earth had keen intellects and had acquired much knowledge, but who so decreased their dominant vibratory rate by using that knowledge to cause others misery that they have gravitated to the very slums of the inner world. Either length or life or breadth of life is valuable in that it affords opportunity to increase the spirituality, but unless thus utilized it has no power to add to the life in this direction.

In general, because commonly they are accompanied by emotions that possess a very high vibration and constructive potency on the inner plane, we may broadly classify all those thoughts, feelings and actions that spring from a desire to help others, rather than to gain some profit for themselves, as spiritual. Such constructive efforts and the emotional states accompanying them generate some of the highest vibratory rates known to human life, and consequently are very potent sources of true spirituality.

People add most to their spirituality who live by the universal moral code — which is explained in detail in lesson No. 214 — stated thus: A SOUL IS COMPLETELY MORAL WHEN IT IS CONTRIBUTING ITS UTMOST TO COSMIC WELFARE. This implies that all, instead of just a few, of the thoughts, feelings and actions are motivated by the desire to benefit others, and that to be able to render greater service the individual, among other things, strives to gain more knowledge and to advance spiritually. In thus seeking to become a more valuable workman in the universal scheme, when he develops far enough he will become a spiritual alchemist. He will then seek out such experiences as he needs, and taking the proper attitude towards each and every event of his life, as explained in *Spiritual Alchemy* (Course 3), he will insure its final spiritual transmutation.

But in addition to these two methods: (1) viewing events from the standpoint of spiritual alchemy, and (2) cultivating thoughts, feelings and actions that arise from the desire to benefit others, there is a third effective way to raise the dominant vibratory rate and thus to increase the spirituality. (3) As distinct from grosser experiences, a heightened intellectual and emotional appreciation may be cultivated that raises the vibratory rates and adds to the height of human experience.

Intellectual processes, however wide their scope, while adding to the richness of breadth to the life, in themselves cannot contribute to spirituality. If the aim associated with these mental processes has been to gain a selfish advantage over a fellowman, the coarse vibratory rate of the ulterior motive lowers the spirituality. If a man remains brutish in his desire, no amount of intellectual attainment will confer upon him spirituality. His widened mental functions will merely enable the brute to be more successful in his brutishness.

But if in scanning the universe and solving many of the problems of its laws he has a feeling of uplift, an exaltation at the majesty of nature and an admiration for its laws, he has added to his spiritual stature. Or if associated with mental attainment or the exercise of any ability is the desire to render service to humanity, the spirituality is

increased. When activity of the intellect brings aspiration, or when finer emotions not centered in self arise from it, there is distinct spiritual gain. Real education, therefore, is one avenue to true spirituality.

Literature, music, art, the drama, the movies, nature and social intercourse all may, under certain conditions, engender gross and selfish impulses that detract from spirituality. But each one of these, as well as education, prayer and devotional exercises, through stimulating refined emotions, noble impulses and high aspirations may contribute to the vibratory height of individual existence, and therefore to spirituality. The remaining lessons of this course, consequently, will be devoted to explaining how these elements of culture may be approached and used as stepping stones to spiritual attainment.

Erroneous Notions of Spirituality

I trust, now that the cosmic alchemist's conception of spirituality has been made plain, that we can turn with some confidence to an examination of current, and I believe, erroneous notions of spirituality. And in this, in spite of it being poor taste to mention personal matters, as concrete examples are better than abstract dissertations to make a viewpoint clear, I shall discuss the attitude The Church of Light has taken when confronted with real situations.

Many years ago we issued a folder to interest people in occult and spiritual matters. It was entitled, "What Do You Want?" A certain occult magazine solicited our advertisement and we sent it copy of an advertisement of this folder appearing in various other magazines. This advertisement asserted that occultism will assist you to get what you want. Thus, astrology, to our certain knowledge, has helped innumerable people to get what they wanted. Psychology and mental alchemy also are known to have helped many get what they wanted. But the editor of this magazine held that occultism should not be used to get what one wants, and refused to carry the advertisement on this grounds. He, of course, was well within his right, and we admired his determination to keep his magazine up to certain spiritual standards. But because his viewpoint is a prevalent one, it is worthy of careful examination.

The very first thing real occultism teaches is that man should not want something at the expense of his fellowman. And the next instruction of true occultism is to show the individual just what he should want. Then, after indicating what man should not want, and what he should want — that he should want only those things which are beneficial to society as well as to himself — it points out the most certain road to the realization of these worthy wants.

I am unable to discern that it is more wicked, or more unspiritual, to injure another, or to deprive him of what justly is his, by occult processes than it is to injure him or take property from him with a gun, or through a superior knowledge of values to deprive him to the same extent in some shrewd business deal that is well within the law.

But because I have had the advantage, over more than forty years, to observe closely those who take up occult study and practice, I unhesitatingly say that I consider it far more dangerous to use occult means to deprive another unjustly or to injure him, than it is to use a gun or questionable business methods. Even in reading birth charts one tends to tune in on unseen forces, and in using magic or psychology to influence another one contacts invisible entities. And so far as such forces are used a link is established with them. Under the law of resonance, that like attracts like, the grade and quality of invisible intelligences are attracted that correspond to the motives, desires and mental state held. One contacts the entities of the inner-plane basic vibratory level which corresponds to the dominant vibratory rate at the time. If, therefore, one is intent on taking advantage of another, intelligences are attracted that have no scruples about taking such advantage. But these same intelligences, as explained in detail in lesson No. 185, because essentially unscrupulous, do not hesitate to take advantage of the one using them. Usually sooner, but surely later, according to my observations of real life, those who use occultism to the disadvantage of their fellowman are themselves victims either of the projected forces which have completed their orbits, or meet disaster through the misguidance of invisible intelligences.

Unhesitatingly, therefore, I can offer this advice to anyone who contemplates dishonesty: To follow the common criminal channels is far less hazardous, and is far more likely to escape severe penalty, than to use occult means as a means to such ends.

Yet to the individual who has no dishonest intention, but who accepts the cardinal doctrine of occultism that we should develop our highest efficiency the better to serve our fellowman, occultism offers both a safe and a most effective means. Nor, Oriental doctrines to the contrary, is there anything unspiritual in wanting or possessing material conveniences, so long as in their acquisition others are not made to suffer.

As explained in lesson No. 165, material objects, as well as various experiences, give us the ingredients through which we increase the range of both intelligence and emotion, and therefore within proper limits they may be used as aids to spiritual progress. Furthermore, because a knowledge of occult laws is the most effectual way to attain what we want, and enables us to accomplish for ourselves and for society what otherwise we could not, it becomes a duty to the cosmic alchemist to become familiar with these laws, and to make use of them for his own unfoldment, and for the alleviation of the suffering by which he is surrounded.

It is true that those who try to use elementals usually end by becoming their slaves, and that those who use modern gangsters for their ends also usually end by becoming victims of the underworld. But anyone with a real knowledge of occultism will not employ ceremonial magic and elementals, no more than an intelligent citizen will employ machine guns and gangsters to get what he wants. There is a wrong way to try to accomplish anything; but because this is true does not imply that all methods are wrong.

If we conclude that because a force is invisible it is wrong to use it, we must discard the electric motor and radar, and take the telephone, radio and electric lights from our homes. By astrology, which is one of the three great divisions of occultism, it can be determined what we can and what we cannot accomplish at a given time. To commence something that is sure to be a failure is a waste to society and is anything but spiritual. To attempt something that can be accomplished, and that in some manner will make the lives of others happier and richer, agrees well with our definition of spirituality. Yet the use of astrological knowledge certainly is the use of occultism, and in this case it is used to get what is wanted. After all, reason is an occult process; for we cannot see it work. If it is unspiritual to employ occultism to get what we want, it is also unspiritual to employ reason for the same end. Is it, then, spiritual to go blundering through life making mistakes that cause ourselves and others endless suffering, and unspiritual to use either intelligence or the definite road map of our possibilities that astrology affords?

Some years ago, here in Los Angeles, I was invited to speak before a gathering of metaphysicians. I gave them, as best I could in so brief a time, my ideas on astrology. At the close of my talk a man, who at that time had a very large following as a metaphysical healer, arose and said that no true metaphysician would pay any attention to astrology. He held that any knowledge worth while must come from within, and that the stars, or anything other than man's mind, could have no influence over him.

This same metaphysician a few months later went to a then developing suburb of Los Angeles and commenced to promote the settling of a tract of land. Within two years from the time he publicly proclaimed that all information worth anything must come from within, he had lost not only all his own money, but the money of many of his friends, in the inadvised real estate project. This man who was a brilliant speaker, and who was not dishonest, caused himself and his friends great loss by entering upon investments at a time when the progressed aspects in his chart made it impossible for him to have success in this kind of a venture, even with the help of metaphysical treatments. I have no doubt most of his audience, when he spoke of astrology, became convinced of its uselessness. Yet any astrological student capable of working progressed aspects could have told him, before he entered upon it, that his real estate venture was doomed to certain failure.

Then also, there come to our classroom from time to time, those who proclaim loudly that they do not read books, that they have no need of getting any information from others, because, after all, whatever they need to know is revealed to them from within. Nevertheless, I observe these people, like the metaphysical orator just mentioned, blundering through life and causing themselves and others hardships because their egos are so inflated that they will not condescend to check their views against the experiences of others as recorded in books or as expressed in conversation. This is their idea of being spiritual.

But The Church of Light idea is that those who consult and use whatever means they can find to make their lives successful, who thus make fewer painful blunders, and who consequently contribute more to human welfare, even if some of their knowledge does not come from within, are more spiritual.

True occultism shows you where you can be of greatest service in the cosmic scheme, shows you what you really want, and aids you to get it.

Charging for Occult Services

—Every organization has the right to impose its own restrictions, and as will be explained shortly, The Church of Light does not permit its ordained teachers or ordained ministers to charge a price for teaching Church of Light classes or conducting Church of Light services. But when, as we are so often informed by students of other organizations, it is held that to make any charge for astrological work is in violation of spiritual law, we must strenuously object.

Division of labor in human society makes it inconvenient for each individual to perform all the services he requires. In fact, it is quite impossible. It has become the custom, therefore, for those who use the time and energy of another in securing some service that they are unable or unwilling to do, to give that person something in way of recompense. To become really efficient in performing some service usually requires arduous training, and to maintain that efficiency the person often must continue to devote much time and energy to it. Were he to receive no compensation for his efforts, his efficiency would become lower, as he would be compelled to spend more of his time in some field that would yield a living. Specialization, which makes services most valuable, therefore is commonly maintained by rewarding the specialist with money for services performed.

If one kind of service from which an individual benefits deserves financial reward, any other kind of service that benefits an individual deserves its pay. If you pay the farmer for the products he raises, you should also pay the healer for the use of his time and knowledge. If the community believes it is being benefited by the sermons of an orthodox preacher, or by the discourses of an occult lecturer, there is nothing unspiritual about it if the preacher or lecturer demands pay for the time and energy he uses. Whatever his vocation, he must live to continue it; and if others receive that which is valuable to them from his efforts it is but fair that he should receive something from their efforts that is of value to him.

We frequently hear the platitude that truth cannot be purchased for a price. This is true as far as it goes; for truth implies inner comprehension, which depends, not merely upon availability of information, but also upon ability and effort. Yet the other side of this platitude is that many never have the opportunity to grasp truth except as certain facts are presented to them from the printed page, or from the lips of some teacher. Even learning to read and write commonly calls for the assistance of

another. And to present the necessary information that assists another to grasp truth, the printer's bills must be paid and the teacher must have food, shelter and clothing.

We are forced to conclude, then, that any service rendered which is beneficial to mankind, if approached with the sincere desire to be helpful rather than solely actuated by desire for personal gain, is a spiritual service. That is, the growing of potatoes, the milking of a cow, the healing of the sick, and the teaching of children, as well as instructing people in the occult sciences, if approached with a desire to assist universal welfare, engenders those emotions in the performer of these services that may be considered spiritual. And because he must receive recompense for his labors if he is to continue performing them, it is not unspiritual to receive money for any service — providing groceries, giving psychic readings, doing astrological work, or piloting an airplane — by which society is really benefitted.

The converse of this is that to exploit and take an undue recompense for any service — whether it be a speculation in Wall Street, the use of psychological forces, or the shrewd cornering of some natural resource — is unspiritual, as are all acts motivated by disregard of the welfare of others, and those that injure rather than benefit society.

Those who teach the occult sciences, who talk of things spiritual, who do astrological work, who do stellar healing, and those who use their psychic faculties for the benefit of others, are quite as justified in making a charge for their work as are those who perform menial labor. If one kind of work is immune from reward, provided it is valuable, then all kinds of valuable work should be immune from reward.

Take notice, however, that The Church of Light gives no astrological, psychic or other kinds of readings. Our function is to teach and preach The Religion of the Stars, not to give readings.

Yet even in the performance of these functions, in the interests of spirituality, we have the rule that no one is permitted to charge a price for teaching or conducting services under the auspices of The Church of Light. All such activities are supported by voluntary contributions. This restriction is imposed not because taking money for teaching Brotherhood of Light lessons would be unspiritual, but for two other purposes.

First — There has been a custom for occult lecturers to go about the country, give a few free lectures to lead their prospects on with glowing promises, and then charge from \$10.00 to \$50.00, and even \$100.00, for a course of lessons in some subject. Many of these lecturers have no real knowledge, and have exploited people and given nothing of value for the money they received. A few have given instructions that were well worth the price to those with money enough to take such expensive courses. But those who most needed the courses, and were best qualified to profit by them, all too often were prevented from taking the studies because of their high cost; and others who had the price, but who never made good students, thus largely made up the lecture class.

Teachers of The Church of Light may charge what they like in giving private instructions, or in classes not held under Church of Light auspices. But The Church of Light feels it is desirable that classes and services on the Religion of the Stars shall be maintained in every community where anyone, whether he is rich or poor, may attend and receive instructions. The rule that no charge shall be made for admittance to Church of Light activities enables those who are low in finances to have access to our teachings. Second: Spirituality demands that there shall be some exercise of unselfish effort. Those joining The Church of Light sign a contract that they will devote some time and energy to the assistance of others without thought of recompense. Where the thoughts are centered solely upon personal advantages to be gained, there is no spirituality. We feel, therefore as expounders of this doctrine of a spiritual life that our teachers should by example, as well as by precept, demonstrate it in their lives. By devoting time and energy to teaching others, without receiving pay for it, even though to receive pay would not be unspiritual, they reveal that their interest in a spiritual life is something more than empty words.

When I assert that the taking of money for the exercise of the psychic faculties is no more unspiritual than taking money for any other service rendered another, I do not imply that such exercise of the psychic faculties is no more dangerous to the spiritual nature than the rendering of commonplace physical services. On the contrary, one who exercises his psychic faculties for the benefit of others is beset by special perils. He contacts the forces and denizens of the inner-plane much more intimately than do others; and to give successful readings or demonstrations he usually becomes quite sensitive to their influence.

If — and I am not here talking about irresponsible mediumship, but about the use of Intellectual ESP — he resolutely keeps his thoughts and aspirations to a high plane, he will contact only forces and entities of high quality and sterling integrity. But if he allows himself to entertain greedy, licentious, or grossly animal thoughts, he attracts to himself, and cannot fail to be influenced to some extent by, forces and entities of the inner-plane of a similar quality. In giving a psychic reading Intellectual ESP alone is seldom employed, and the psychic commonly comes into close rapport with the person for whom reading. He usually thus temporarily takes on the quality, to some extent, of the person for whom reading; and if this person has low, unworthy, dishonest, or unspiritual thoughts of any kind, the psychic not infrequently, for the time being, acquires these qualities and thus attracts from the invisible, entities and forces that are low, unscrupulous, or otherwise degrading.

Through thus giving readings to all kinds of people, and contacting invisible energies corresponding to their desires, the psychic reader may find that the forces thus attracted have enough influence gradually to undermine his character and cause his thoughts and feelings to deteriorate in quality. The psychic may be able to protect himself from such deterioration, but, at least, there is such danger to one who makes his living giving psychic readings. His calling, therefore, is more perilous than some others; but so long as he has the desire to render honest service, and is able to do so, his calling is in no way unspiritual.

Yet we find occasionally those who heal others through their psychic powers, as well as those who give readings and otherwise exercise their psychic faculties for a money reward, entering their profession with high aspirations and dominated by ideals of real service, only to deteriorate in character and in quality of service rendered by becoming too greatly engrossed in the financial rewards. I have witnessed more than one psychic who did excellent work at start become absorbed in acquiring the dollar, and then swiftly deteriorate in the quality of the service rendered.

Money, at start, was only a secondary consideration. They worked to heal the sick, or to help people through sound advice. But gradually money grew to be the dominant desire, and as it did so the higher, inner energies that made for their previous success could no longer be contacted. Their greed and inconsideration of others made an effectual barrier that cut them off from the vibratory influences that previously had been the source of their power. The accepting of money for their services was not unspiritual; but becoming dominated by the money motive instead of by a sincere desire to be helpful was decidedly lacking in spirituality.

How People Are Bewildered

—The plain common sense of people would indicate to them just what things are, and what things are not, spiritual were it not for the bewilderment from which they suffer due to Oriental superstition and Christian dogmas.

In the application of suggestion, and in hypnosis, the subject must first be placed in a certain frame of mind before the suggestions will be accepted as facts, irrespective of their verity, and acted upon. But if this state of mind can be induced, the subject will believe a stick is a snake, that black is white, and that two plus two equals five, and will act upon these beliefs without question, because his critical faculties have been inhibited.

For inducing the hypnotic state it has been common for the subject to gaze steadily at a bright object while the operator drones some phrase over and over. The dazzling object concentrates the attention and bewilders the mind to a state in which the critical faculties are quiescent. When the critical faculties become so confused that they no longer stand guard, the subject is in a state where the monotonous phrase dominates him, and in this state he can be led to accept any other suggestion the operator offers.

Furthermore, it has been found that suggestion can be applied with quite as much force, and that it will be accepted quite as fully, without inducing the hypnotic sleep, but by inducing a state in which the critical faculties, nevertheless, are off guard. Such methods are applied in certain clinics to make the patient insensible to pain during a surgical operation; and they were once given great popularity by Coue in his

system of applying auto-suggestion. In fact, Coue found that there is a state which is not total wakefulness, and is not sleep, but somewhere on the border line between the two, in which a suggestion takes hold with tremendous force and quickly becomes a dominant influence over the individual. His cures were all effected through the use of this principle.

Coue' induced this state of susceptibility to suggestion by having the patient repeat to himself his well known suggestion, "Every Day, In Every Way, I Am Getting Better And Better." The monotony of repetition tends to still the critical faculties. Also, if the suggestion is repeated just before going to sleep there is a point just between the two states in which the critical faculties are so thoroughly off guard that the suggestion takes hold with tremendous force.

But any thoroughly bewildered state of mind — whether induced by looking at a bright object, by hearing some phrase repeated monotonously again and again, by being on the boundary between wakefulness and real sleep, by hearing a monotonous and pointless sermon, by witnessing monotonous and apparently meaningless rituals, or by receiving a medley of ideas that have no clearly defined meaning — lulls the critical faculties of the human mind to that peculiar state where the individual may be made to accept any idea, however fantastic and lacking in plausibility, and hold to it with all the tenacity of a hypnotized subject.

Give an earnest student a mass of theories that may be twisted so as to signify this, that or anything just as occasion requires, and which really signify nothing because they are words which do not represent facts, and in the course of pondering on them his mind becomes bewildered. Give him a lot of strange words of supposedly mystical import — whether Sanskrit or Latin — but which to him denote nothing definite and specific, and let him pour over them for a time, and his mind is as numbed as if he had been looking at some dazzling object. Or give him enough Scriptural passages so that anything which comes to his mind can be proved by gospel reference, and his mind becomes confused. In any one of these instances the mass of dimly perceived thoughts and meanings are so muddled in his mental makeup that he is, quite unknown to himself, enough bewildered that his critical faculties have been lulled into quietude.

In this peculiar mental state — whether induced by looking at a crystal, by looking into a hypnotist's eyes, by being on the boundary between wakefulness and sleep, by being given a hash of Scriptural passages, a conglomeration of Sanskrit words, a medley of ritual or a plethora of mystical theories — he is susceptible of being dominated by any strong suggestion that reaches him. He is as open to accepting ridiculous and unplausible ideas as if he first had been formally put to sleep by a stage hypnotist.

Only through a recognition of this peculiar quality of the human mind can we satisfactorily account for the inconsistent mystical ideas held by many, for the irrational religious conceptions that dominate some, for the gullibility of the public

by political methods, and for the silly notions some hold as to what is, and what is not, spiritual.

But of more importance to us, as cosmic alchemists, than the recognition of the method by which others are brought to believe in inconsistencies, is the discernment that in forming our own conclusions in regard to what is spiritual, and what is beneficial to racial welfare, we must constantly exercise our critical faculties, and be on the alert to guard against accepting unwarranted suggestions. Nor are all these suggestions given orally, or through the printed word. They also are radiated from the minds of powerful thinkers, and wherever they find a bewildered mind, or one that through mediumship or other causes has entered a passive state, they enter and tend to dominate it. The person thinks he has plenty of proofs for his beliefs, just as does a hypnotic subject; but in fact he is dominated by a powerful suggestion.

The Proof of Spirituality

—Not only should people be alert to prevent being unduly influenced by others, but there is no need for any intelligent person to rely on the dictates of some leader to ascertain what is, and what is not spiritual. Thoughts, feelings and actions that tend to raise the dominant vibratory rate are spiritual, and thoughts, feelings and actions that tend to lower the dominant vibratory rate are unspiritual.

Whichever of the methods an individual has used to raise his dominant vibratory rate, if it has been raised sufficiently that he may be termed a spiritual individual, he is sure to exhibit that spirituality by his thoughts, feelings and actions. Not only does any effort to gain a selfish advantage over a fellowman have a coarse vibratory rate which lowers the spirituality, but to remain unmoved in the presence of injustice, or to be callous to the misery of others, also lowers the spirituality. And those who, regardless of their religious pronouncements, make no effort to correct these prevalent conditions in the world lack that refinement which indicates a high dominant vibratory rate.

Whichever of the three methods of raising his dominant vibratory rate a person has most employed in becoming spiritual, we may be sure of this, if he is truly spiritual he occupies a basic vibratory level where the welfare of every individual on earth is a matter of concern.

Abhorring both injustice and misery, the truly spiritual individual therefore rejects the idea that only the special privileged few should be permitted to enjoy such advantages as earth has to offer. Instead, he works to the end that all the people of the world should have as ample opportunity as possible to make both intellectual and spiritual progress. And this means, as explained in detail in lesson No. 164, that he works to enable all the people of the world to have freedom from want, freedom from fear, freedom of expression and freedom of worship.

Chapter 6

Serial No. 169
Original Copyright 1946
Elbert Benjamine

Copyright
August 2002
Church of Light

The Spiritual Value of Education

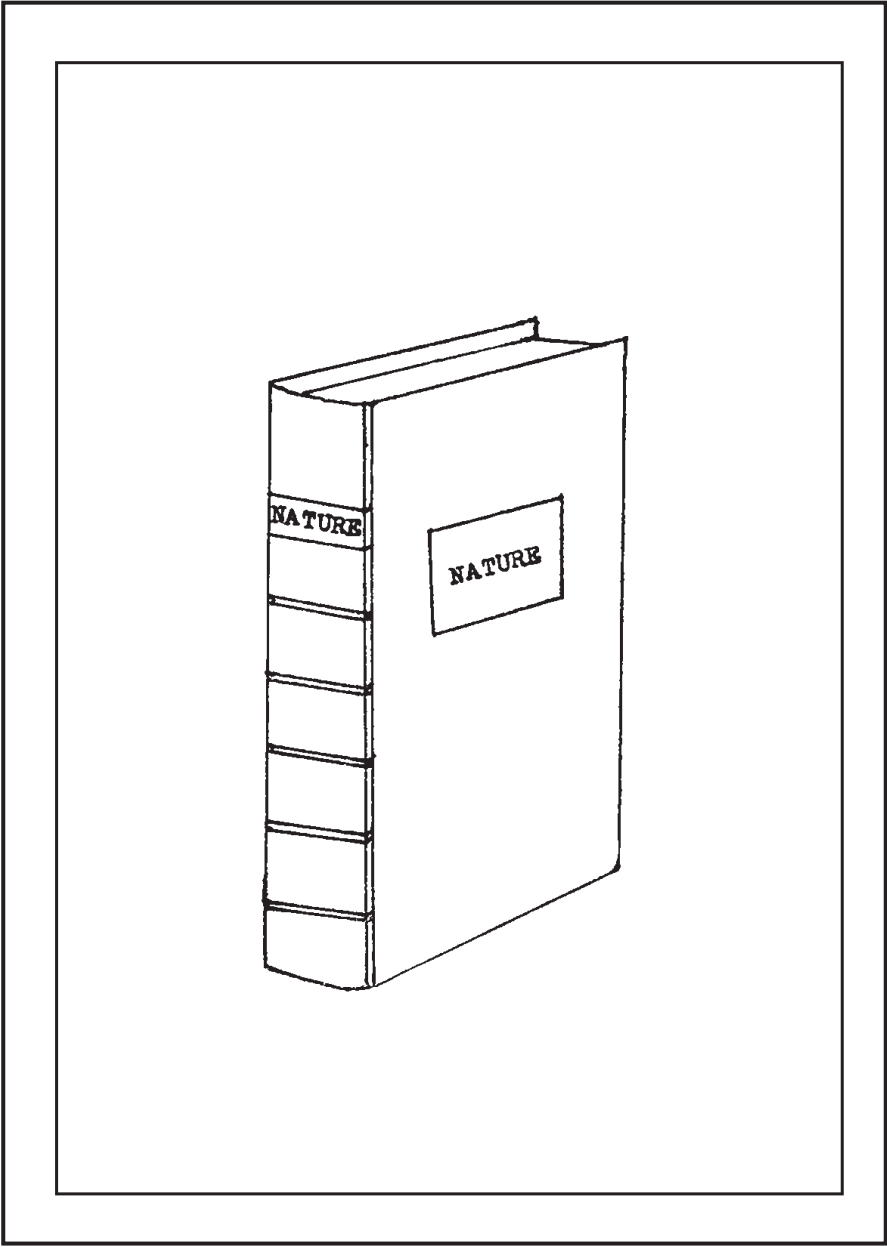

Chapter 6

The Spiritual Value of Education

IF WE consider education to embrace, not merely what is acquired in formal schools, but also every experience that affects the behavior, it is evident that spirituality depends upon education. Whether an individual's life is rich and refined, or scanty and gross, is contingent, in large measure, upon the kind and number of his experiences. True, one child under certain conditions will develop characteristics quite different than does another child under the same circumstances. Nevertheless, what the child likes and what it dislikes are conditioned by the kind of experiences it has early in life. Whether its inclinations through life are to be coarse, self-centered and brutish, or are to be refined, unselfish and noble can be quite definitely determined by an intelligent use of conditioning factors very early in its career.

As the means that may be employed for conditioning factors to determine the developing child's emotional reactions, and the various important traits of character that spring from such conditioned responses, are given much detailed discussion in Course 14, this subject will not be presented here. But it is here essential to our purpose to point out that once it is determined what likes and dislikes a child should have, there is at hand an adequate method in the application of sound psychology by which these trends, or almost any other traits of character, may readily be developed in the child.

And even when such earlier training has been neglected, and traits of character, leanings, and tendencies have developed that seem undesirable, we adults need not despair; for although the modification of adult character is more difficult, through determined, persistent and intelligent effort adult desires, reactions and propensities may likewise be completely altered.

But before commencing to educate either the child or the adult in the direction of spirituality, we must determine in the individual case just what tendencies, qualities and actions should be developed. The capacities of people, even from their births, differ. Therefore, there are individual problems to solve; problems in determining what kind of education in each particular case will yield the highest and fullest spiritual satisfactions. And in addition to these, it is necessary also to determine what inclinations and tendencies in general, as applicable to most of mankind, lead to

breadth of life, and raise the dominant vibratory rate and thus increase the spirituality.

The adequacy with which humanity can successfully solve the problems of its life depends upon the correct amount of information available. It makes mistakes, and fails to reach its highest possibilities, either because impulse overrides reason, or because the insufficiency of its information causes it to draw wrong conclusions. The impulses and emotions that cause individuals sometimes to disregard the dictates of knowledge, themselves are susceptible to education. But mankind cannot have the knowledge that enables it to act correctly, even when its emotions are properly trained, unless there is a wide range of properly classified facts.

The acquisition of these facts in itself does not add to the spirituality; it only contributes to the mental development, that is, to breadth of life. But mental development and length of life both can be employed to increase the spirituality.

And in addition to acquiring facts and ideas there is another type of highly beneficial mental development which should not be neglected. It requires the patient application of energy, but no time taken from other duties. It can, and should be, not merely a part time practice, but a training used all of each day. It consists in thinking the type of constructive thoughts which have been selected properly to recondition the thought-cell discords revealed by the birth chart, and of forbidding entrance to the mind of thoughts which increase the thought-cell discords. And it should be used with equal vigilance and persistence in spiritual development through preventing entrance to the consciousness of thoughts and emotions which lower the dominant vibratory rate, and encouraging the presence of thoughts and emotions which raise the dominant vibratory rate.

Such daily training in directed thinking and induced emotion may accompany any activity in which one is engaged. The chief difficulty encountered is to remember in proper time just what types of thoughts and emotions are not wanted and just what types of thoughts and emotions are desired.

As thoughts and emotions commonly enter objective consciousness, it seems proper to think of them as guests. Some of these mental guests are pleasant, desirable and beneficial companions. Others we are far better off without. But these have a habit of slipping stealthily in without asking permission. Here they are, creating a disturbance or perhaps even an emotional uproar almost before we are aware of their presence.

If we are not to permit them to work great and continuous harm we must shut them out; and to do this we must become habitually alert. Unless such alertness is carefully cultivated they will continue to sneak in. One way to cultivate such alertness, though there are also other ways, is to acquire the habit of mentally speaking to trains of thought just as they start. Call them Welcome Guests, or Unwelcome Guests. When

something stimulates constructive thinking, or a beneficial emotion, say “Welcome!” to it. But when you commence to worry, when you commence to be despondent, when you start to feel irritated, when you start to be jealous, or envious, or begin to feel sorry for yourself, or think that everything is all wrong, mentally shout “Unwelcome!” at the intruder.

You have decided what mental guests you want, and when they appear you should welcome them gladly. And you have also decided what mental guests you will not tolerate, and are quite justified in yelling at them, “Unwelcome Guests!” as soon as they put in an appearance, although if your family is to remain convinced of your sanity the yelling to keep these obnoxious intruders out should better be only mental.

Here we have illustrated that ability to attain the ends we seek physically, mentally and spiritually depends upon knowledge. To make satisfactory spiritual progress it is not enough to recognize that it consists of raising the dominant vibratory rate. There must also be know-how information, and effort directed by this knowledge.

The more complete its knowledge, the more effectively can mankind direct its efforts into those channels which make it physically, mentally and spiritually successful. And as knowledge rests upon classified facts, the better they are classified and the more available they become by plainness of presentation and accessibility in printed or other form, the better opportunity mankind has to enjoy life and develop its spiritual possibilities.

The cosmic alchemist may, or may not, according to his capacity, contribute in a marked manner directly to the finding and presenting of new facts. But at least, in the interest of human welfare, he exerts as strong a pressure as possible to encourage those who are qualified to search the universe for information, to classify it, and to make it available for the use of as many people as possible.

And because his conception of the universe is not limited to the material world, but embraces invisible planes as well, he encourages research in these realms. Enough evidence is already at hand to prove to him conclusively that the death of the physical body is not the extinction of the soul. There is another life in different velocity of substance that he is going very shortly to be called upon to take up. If he is to meet the problems of this new phase of existence, should he now remain in total ignorance of its requirements?

The physical life is but one section of the larger life of the soul. It is but one link in the chain of existence. And as knowledge of conditions on earth enables man more successfully to live here, so knowledge of the inner plane where shortly he is to dwell doubtless will enable man to find greater satisfaction there. Furthermore, the cosmic alchemist believes the whole chain can be made more valuable by an increasing knowledge of the requirements in its successive links. That greater life can be lived more completely if he uses some effort to prepare himself to fit harmoniously into the next phase of his existence. The cosmic alchemist, therefore, encourages such efforts as lead to a more comprehensive knowledge of the life that follows physical dissolution.

I realize that in many pseudo-occult circles there is a strict injunction against trying to find out anything about the life after death. In such groups the very word Spiritualism is anathema. Anyone who communicates with a loved one who has passed on, according to these, is close to the brink of perdition.

One cannot avoid the suspicion that the leaders who so vociferously condemn attempts at spirit communion fear that such communion ultimately will provide information that will show how shallow and erroneous are the ideas they teach. One suspects that they fear the mask of their pretensions will be removed, revealing them to be the charlatans and conniving priests of false doctrines that they are.

Not but that spiritualism holds many dangers; perils so real that they are emphasized and set forth in detail in the first B. of L. course of study. We feel it desirable that the student at the very beginning of his studies should be aware of them, and should also know that there are methods of gaining information about inner-plane conditions without exposure to these perils. But if Columbus had been deterred by perils he would not have discovered America. If such men as Copernicus, Galileo and Kepler had desisted in their researches because of the very real danger that threatened them from the Church, the world might still believe the earth to be flat and stationary. After all, radium had its martyrs, the development of aviation has been marked by disasters, atomic fission has placed humanity in grave peril, and human accomplishment is bordered by the gravestones that measure the miles of its advancement.

For the ignorant and innocent to enter upon grave peril in the belief that the enterprise is free from danger is quite a different matter from entering upon hazardous exploration by a skilled investigator who is fully aware of the difficulties to be encountered and the chances he is taking. For women and children, in the belief it is a pleasant task, to start on a polar expedition is quite a different affair than the attempt of Byrd to fly across the earth's axis, or the attempt of Wilkins to reach it by submarine travel beneath the ice. We applaud these explorers rather than condemn them, because they have tried to add something to the sum total of human knowledge. Shall we then not also applaud those who, aware of its dangers, but especially fitted for such work, explore that even less known frontier of human knowledge, the realm where man sojourns in the discarnate future?

Preconceptions often are erroneous. Guesses usually lead to failure. Theories not based upon facts are worthless. Therefore, we might as well face the situation as it exists in spite of creeds, false occult notions and bigoted assumptions of superior knowledge. Man can have no real science of a future life except that science is based, as are the other sciences, upon carefully collected and critically observed facts. Until, through the investigation of the phenomena of the next life correct information was obtained and tabulated, our conception of the life hereafter was but a surmise, or at best but the reports of certain individuals as to what they have uncritically examined in that region.

Trained minds that at present laboriously are plodding the road of careful psychic research are really doing something to increase our knowledge of this inner-plane. Some of its problems, by the most critical methods of experimental science, they have already solved. Many more problems lie before them. But they are on the right road, and I am justified in saying the only road that will ever yield a real science of the life beyond the grave. Their ingenuity enables them, from time to time, to discover new and improved methods of investigation. The proper application of Intellectual Extra-Sensory Perception became apparent from a study of their experiments. In time, doubtless, a purely mechanical contrivance will be perfected by which those of earth can talk with their acquaintances who have passed on as easily and certainly as people now communicate with each other by radio. Then we shall quickly develop a very comprehensive science of the future life.

In the meantime, while recognizing that the processes of experimental science are slow in yielding results, and not nearly so facile in giving explanations as are those individuals who jump to conclusions about the devachanic plane, the cosmic alchemist, in the interest of true education, supports and encourages whenever he can, all competent research that has for object the gaining of more definite information about the future life.

Is Information From the Inner-Plane Spiritual?

—But because information, or pseudo-information, comes from the inner-plane, he does not make the mistake that is so often made of considering it more spiritual, or more infallible, than such information as is received through the physical senses. Information received through any of the psychic channels regarding this plane or any other is merely information, and valuable only if reliable. Information received from those who occupy the inner-plane, from friends who have passed on, or from some unseen entity who purports to be a Master, is merely information; and is no more, and is no less spiritual than information of a similar grade and similar reliability received from a friend whom one chances to meet and pass the time of day with on the streets.

Nor is the exercise of the psychic faculties and of occult powers more spiritual than the exercise of physical powers and faculties, except when it increases the dominant vibratory rate. The yogi who is buried under ground for a month exercises a certain ability of suspended animation such as a bear, or a groundhog exhibits at the approach of winter; but such burial, unless it is done to benefit some other being, has no spiritual quality.

To leave the physical body and travel in the astral form to far places, in itself is not a spiritual act. But thus exploring the astral realms, or exploring the physical world in the physical body, through increasing the amount of information adds breadth to the life which may, or may not, be used to increase the spirituality.

A person of low morals, through natural ability or through persistent cultivation, can develop his clairvoyant powers, his psychometric perception, or his mediumistic quality, quite as readily as can a person of high morals. To develop a keen ear for musical notes, or the appreciative eye of an artist, does not depend on morals. Nor does the ability to exercise any psychic faculty; although the results obtained by the exercise of any of these abilities is modified by the moral nature.

The shamans of the primitive northern tribes, the witch doctors of Africa, the fakirs of India, and even the early fathers of the Church, impressed their holiness upon the masses by performing apparent miracles. But these miracles are under law, are the result of using certain unseen forces, and while they often rest upon special abilities this does not signify that these abilities are spiritual. Jesus did not prove himself spiritual because he could perform miracles; but because in each instance that he exercised his superior talents he used them to alleviate suffering or to benefit someone.

Is the Yogi Spiritual?

—If the Oriental yogi does something through the use of his specially cultivated psychic powers to benefit others, he performs a spiritual act. But if he exercises these powers merely to show others what he can do, to cause them to revere him as a saint, or merely to excite amazement, nothing spiritual has been accomplished. And if through the exercise of these powers he has the ability to alleviate the misery of others, and refrains from doing so under the belief that any help he might render would interfere with the payment, through suffering, of their just karmic debts, he is decidedly an unspiritual man.

Magic, as well as the exercise of any other capacity or power, may be grossly selfish and material, or unselfish and spiritual; depending on the motive behind it and whether it is helpful or detrimental to others. The man with great ability, whether that ability be physical, intellectual or magical, may be spiritual, or again, he may be crassly material.

The development of Intellectual Extra Sensory Perception and its exercise, because it increases the range of information obtainable, and because it may be used to enrich and make more valuable the life, gives greater opportunity for spiritual progress. It does not assure spirituality, but it offers opportunity to gain spiritual values. Therefore, the development of Intellectual Extra Sensory Perception may be made of value in spiritual progress.

Is Accumulating Wealth Unspiritual?

—Before turning from this subject of the exercise of powers, there is still another ability that should be mentioned; the ability to accumulate wealth. How such wealth is accumulated is still another aspect that needs consideration in its spiritual implications. Here, therefore, the question only is whether the accumulation of wealth is spiritual or unspiritual.

Like the exercise of any other ability, it all depends on the motive behind it and the use to which it is devoted. To accumulate money at the expense of the suffering of others, and to use it for self-gratification rather than to benefit society, is the opposite of spiritual. But if the money accumulated has been acquired without hardship to others, if it has been acquired largely under the prompting to be useful to others, and if it is then used to accomplish some needed improvement in conditions which could not be accomplished without the concentration of capital under the direction of a single competent mind, the act of accumulation becomes spiritual in character.

Accumulating money in small amounts, or in large amounts, is neither spiritual nor material, but the ability to do this, or the exercise of any other ability, can be used for either end.

Education For Those Desiring to be Spiritual

—With these preliminary questions now cleared up; let us consider what kind of education the individual desiring to be spiritual should have, and how much of it. As, in addition to length, life has both breadth and thickness, his education should be such as to increase it in all three dimensions. While not necessarily contributing to spirituality, either greater length or greater breadth of life may be used to increase it. Education should not neglect instruction in how to obtain the physical things which are necessary to health, length of life and usefulness. And as mental education not only broadens the life but enables the individual to increase his spirituality through usefulness to others, he cannot receive too much of it. But at the same time, if his life is not to lack in the most important of its dimensions, the individual should receive training to raise his dominant vibratory rate.

The amount of time and effort devoted to gaining an education should be limited only by the amount of both required to use the education he already has to advance himself and the world of which he forms a part. Should he devote all his time to gaining an education, he would accomplish nothing else. And if he should devote all his time to trying to accomplish something, without learning what is best to accomplish and how best to do it, what he would accomplish would amount to nothing. Thus should the energy and time be intelligently balanced between study and action, that the yield both to himself and to others may be the maximum harvest.

In regard to his mental education if his information is so broad and general that he devotes little time to the details of any one thing he is unable to accomplish any one thing with unusual ability. If he devotes himself too exclusively to some specialty he is unable to perceive how it is related to other things, and so fails to use it in the manner that will yield the widest good. Thus his mental education should be divided appropriately between the effort to gain as inclusive a knowledge of the universe and its laws as possible, and into the effort to learn all that it is possible to know about the one particular thing in which he has specialized.

The schooling of a child, or of an adult, should be such as to give him as wide a grasp of information as possible. Only through such general knowledge which should include the facts of astrology, the facts of extra-sensory perception, the facts of induced emotion and the facts of directed thinking, can he learn either the purpose of life or how he best can adapt himself to that purpose. But at the same time, too much energy should not be devoted to learning the details of a multitude of subjects which are unrelated to the application of the natural aptitudes mapped by his chart of birth.

Our public schools waste a vast amount of valuable time and energy teaching children subjects that give them no real insight into the meaning of life, and for which they will have no use in after years. Furthermore, a child who is a natural musician should not be given the same education in early years as the child who is naturally a merchant or who is naturally an engineer. Such waste of time and energy of the child-power of the world is as criminal an extravagance as the much and rightly heralded waste of timber, coal, oil and other natural resources.

Time and energy consumed in learning something that is of no value to the individual, and which does not assist him later in his calling, could be spent to better advantage in learning those things and in cultivating those abilities that will aid him to be of competent service later in the society of which he forms a part. To adjust himself intelligently to the universe in which he lives, the child should be given wide information concerning it. But the balance of his training should be determined, from the very start, to assist him to become proficient in the line of work to which in later life he will be devoted.

This implies that the natural abilities of the child must be known in earliest infancy and the proper line of instructions then planned for him. And it implies that much about his temperament and peculiarities also should be known from birth, that such methods may be employed in his individual case that most effectively will impart the selected information, develop his natural abilities to the maximum, and prevent the formation of quirks of character that are against his own interests and against the interests of society. Such knowledge of the child may be ascertained, at any age, from its birth chart.

Already, in lesson No. 151, it has been discussed in detail how both the vocation and the cosmic work of a child, or of an adult, may be selected. For an individual to follow some occupation for which temperamentally unadapted, or to spend years gaining some special type of education that he is unable to use in any way, is a gross waste of human material. It is not in the direction of spirituality; for true spirituality is a high dominant vibratory rate acquired through benefiting others, through spiritual alchemy, or through heightened emotional appreciation. The cosmic alchemist, therefore, exerts his influence toward enabling the child who is fitted for one calling to obtain an education that will assist it in this calling without devoting its energies to learning things that do not raise its dominant vibratory rate and are beneficial only to those who follow entirely different lines of endeavor.

But whatever may be the line of mental education followed, there are two separate and distinct factors that should be constantly kept in mind. With the first factor nearly all our schools are concerned. This factor is the imparting of such information as has been acquired by man relative to various subjects. The information is poured into the growing child, and he is expected to retain this information in his memory.

But of even more importance than the acquiring and repeating, parrot like, of the information taught, is the development of the ability to use whatever information is at hand, including that obtained from his own observations, to form correct and independent conclusions. The accumulation of facts is valuable, and is the foundation of man's superior adaptability at the present time. We have recorded observations and conclusions (many of the latter erroneous) from a long stretch of time. We, therefore, have a more complete mastery over many phases of nature than did the ancients, to whom no such numerous observations of others were available. But it is very doubtful, in spite of more complete knowledge, if man has increased in intelligence during the last ten thousand years; for intelligence is not based on the data available, but upon the proper use of whatever facts happen to be at hand.

Because our schools are chiefly concerned with making facts available, they do very little toward developing the real intelligence of those who attend them. The result of this is readily observable in the attitude of these children when they are grown toward religion, political issues, popular fads and whatever has to do with the formation of public sentiment. Unaccustomed in their school years critically and carefully to examine the statements and conclusions of their teachers and their text books, but accustomed to accepting unquestioningly whatever is presented to them by these authorities, they fail to discern in political propaganda, in real estate or stock market booms, in religious discussions, and whatever fads become epidemic, the fallacies these so obviously contain. They have been accustomed throughout childhood, not to think for themselves, but to receive their ideas ready made. And when the newspapers, the political leaders, the religious potentates, and the financial heads tell them something, they without question accept and act upon it, just as they accepted and acted upon the thoughts presented to them by their teachers in earlier years. If children are not given the habit of thinking for themselves, how can we expect these children when grown up to form such new and completely foreign habits?

Along with the imparting of information, therefore, the school should be conducted so that an equivalent amount of time and energy will be spent by the child in thinking out things for himself. Information is something; but it is probably less, rather than more, than half in mental education. Intelligence implies the ability to visualize facts in such a variety of relations that it enables the individual to perceive just how nature actually operates, and what may be expected to take place under a given set of conditions. The cosmic alchemist, therefore, exerts an influence to encourage the development of Intelligence in our educational processes.

The Public Fails to Discriminate

—Such lack of intelligence, it seems to me, is quite strikingly exhibited by the popular attitude toward the morals of those who occupy positions in public life.

A man may be known to pull many unfair strings to obtain a public office and there will be little comment. He may be shown to have exploited the position of public trust in which he has been placed, and while such use of the public confidence to gain his private ends and enrich himself is condemned, it gets scant publicity. He may be known to be a man who has by sharp practices accumulated a fortune, and still be held in public esteem. Even if he has ground the face of the poor, has paid the lowest wages and demanded the most work, has crushed competitors by force, and has taken an exorbitant profit wherever possible, he suffers little in the respect of others.

But if, as every politician and boss of the underworld knows, this man's name, or the name of another who has committed none of these sins against society, can by fair means or foul be linked with that of a woman in a transgression of the conventional standards of sex, his political career is at once ruined. When the underworld has tried all other means to remove a conscientious man from office, and has failed, it invariably "frames" him with a woman.

It is very easy with money to get some woman on a pretext of needing help, of wishing expert advice on some personal problem, or other well-planted bait, to have a private conference with almost any man. And once in such a conference it is also easy for the unscrupulous woman to give conclusive evidence to the detectives, who are "planted", when they rush in at the opportune moment, that the man's intentions or conduct were not honorable.

There is no intention here of condoning the transgressions of the conventions. But it should be pointed out that many able men are removed from office on such "framed" charges; and that others are brought into general public disfavor through lies circulated about them which have no foundation whatever in fact. Occasionally, as occurred some time back here in Los Angeles, the actions of the charged individual can be vindicated by proving in the courts that the whole situation was a deliberate "plant". But more often, because the charges are so widely heralded in the newspapers, the defendant, even if through long litigation he proves his innocence, is ruined in the confidence of the public.

Yet even if the charges were true, what has the conduct of his domestic life to do with his ability to serve the public, or his integrity as a public official? As Course 14 reveals in detail, a man is made up of various habit-systems that are largely independent each of the other. He has a habit-system that governs the conduct of his work, a habit-system that governs the manner in which he performs the responsibilities entrusted to him, and still another habit-system that is responsible for his domestic life and his attitude towards the opposite sex. Why, therefore, should the public be so willing to deprive itself of the integrity and high ability of one who is particularly fitted to serve it in a certain capacity, just because in some other more private respect he is unable or unwilling to live up to its strict requirements?

One would think, to read the papers, that there is only one real sin; the transgression of the standards of sex relationship. When the papers state that an individual is charged with immoral conduct, or when the individual's morality is brought to issue, it is implied that this in some manner has to do with his sexual conduct. Is it, then, moral to steal a million dollars? Is it moral to cause the suffering of others through providing inadequate living conditions? Is it moral to murder and rob and commit arson? Well, while these things are not considered exactly moral, they seem to be in a class by themselves; for a question of morals seems always to involve a relation between the sexes.

Again I must insist that I am not upholding the transgression of conventional standards in reference to the domestic relations. But I must point out that these laws, like those governing property rights, were made by the majority in the interest of a standard of conduct that to this majority seemed not difficult to attain.

But all persons are not alike in their emotions, in their urges, or in their necessities. Some people are temperamentally cold, and others are more vivid. But hot or cold, emotionally strong or emotionally weak, strongly physical or strongly mental, refined or gross, active or passive, we have attempted to formulate a single standard of conduct for all. For its self-preservation, society has carved out a rigid and unbendable pattern; and attempts to make every individual fit into this form. The wonder is, not that people transgress its narrow boundaries, but that there is not more transgression.

After all, has it been thoroughly and convincingly decided just what form of domestic relationship is best? Is it better for people who quarrel and fight continuously to be compelled to live together, or is it better that they separate? Is it better that people who thus cannot live in harmony shall find consolation elsewhere, or is it better that they shall forever live as celibates? Is it better for people who because of responsibility to their children, or who because of responsibility to something contributing to public welfare, feel the inadvisability of divorce, yet who no longer can have any emotional interest in each other, to refrain from allowing any affection to kindle for another? These are questions that society, through experiment and the process of trial and error, is trying to solve; but they are not yet closed questions.

Nor, beyond suggesting that real love is one of the most spiritual of all forces, do I here attempt a solution. I mention these questions because, as it seems to me, lack of proper education causes the public to place undue stress upon transgressions of the standard of conduct it has set in sexual matters, to the serious neglect of emphasizing the importance of various other moral and spiritual transgressions.

Unspiritual Conduct

—Cheating the public through graft is becoming more and more common, but in spite of its increasing occurrence it is decidedly unspiritual. Anything that degrades the individual, or has for its object the injury of others, lowers the dominant vibratory rate and is unspiritual. The extent to which an unconventional affair does this varies with the individual circumstances; but grafting on others, either in or out of public office, always lowers the spirituality.

But what about the individual who, because of superior ability, or some unusual combination of circumstances, is able to grab a large section of the wealth of a country, appropriate it to himself, and hold it irrespective of giving society anything of value in return? I am not here speaking of his legal right, or whether or not others should permit a situation to exist where this is possible. I refer to it from the standpoint of how it affects his dominant vibratory rate.

Such an individual, because he is unable to perceive himself as selfish, because as yet he is unable to grasp the idea that abilities, capacities and resources should not be used merely for self but are responsibilities to society, is not spiritual. Whatever he gains physically and mentally is more than compensated for by the effect on his character. Because through hoarding resources that others might enjoy he deprives society of that which otherwise it would have, he is inimical to his fellowman. Nor could he remain callous to such injustice if he had a high dominant vibration. One who cannot perceive that might does not make right is sadly lacking in spiritual education.

Let us suppose that three-fourths of the population of the earth are keen enough to acquire all the resources and wealth of the world and to pass laws by which it remains within their possession. What are the balance of the people to do? Is it the spiritual thing for them to perish from the face of the earth rather than break these arbitrary standards raised by the majority, or is it more spiritual for them by stealth or force to take what they need to survive. If a man is honest, cannot obtain employment, has children and a sick wife, is it more spiritual for him to steal food or to permit his family and himself to die? One who has a real spiritual education finds no difficulty in answering such questions. He finds no difficulty because he is trained to do his own thinking.

Scientists and Their Assumptions

—In all the departments of science, of course, we cannot conduct painstaking investigations to ascertain if the scientists have performed their work accurately. But there are innumerable fields in which things are now taken for granted because the prevalent opinion of notable persons has set its seal of approval on certain ideas, that need occasionally to be completely reexamined. For instance, in lesson No. 129 and in this lesson I have reexamined certain moral conceptions. Taking for granted is not the method of those who are truly educated; it is the method of those who are parrot taught.

As a single example of what I mean, the question is asked again and again of astrologers why, if astrology is a real science, astronomers ignore it? The reason is simple, but to the ordinary layman, who places scientific men in a compartment where all such are supposed to know everything, this explanation is unconvincing. It is as unconvincing as the similar fact that only an occasional scientist will really take the pains to investigate psychic phenomena. They are too busy with other pursuits, and take for granted that the old opinion that all such things are rubbish is true.

Yet in regard to astrology we have indisputable evidence that this is the case through the published statement of one of the foremost astronomers, and one who, through innumerable magazine articles perhaps more than any other recent writer has given astronomy popularity. Isabel M. Lewis, of the U. S. Naval Observatory, is not only a capable astronomer but is especially conversant with the lives, ambitions and leanings of astronomers. What she writes about them, therefore, rather than what she writes about astrology with which she is not conversant, bears the earmark of authority. Writing in NATURE MAGAZINE, April, 1931, under the caption ASTRONOMY AND ASTROLOGY she says:

“The average man of today prides himself upon the fact that he lives in a scientific age and that he keeps well informed upon current events. He reads of cosmic rays, protons and electrons, the structure of the atom and the nature of light. He even takes a keen interest in the theory of relativity and then maybe to offset it all, he glances over the daily horoscope and gets interested in something discarded some three centuries or more ago...”

“In spite of the fact that today astrology is absolutely discredited it is surprising to know how many people are still unaware of this fact. This is evinced by the great number of queries that astronomers are constantly receiving, individually, or as members of staffs of observatories, on the subject of astrology and its relation to astronomy. Some people want to know if there is anything to astrology. Others ask for information regarding the astrological signs and how a horoscope is cast. If one has been dabbling in astrology for himself and has some ideas of his own on the subject he may decide he will read his own fate in the stars and cast his own

horoscope. He then asks the astronomer for the information upon which he bases his readings, the positions of the heavenly bodies upon a certain date.

“It is probably because of the fact that the astrologer must come to the astronomer directly, or indirectly through official almanacs, for the positions of the stars and planets on certain dates that confusion has arisen in the minds of many as to the relation between astronomy and astrology. The astronomer may good-naturedly furnish the astrologer with some facts regarding the heavenly bodies, but he is not accountable for the use of such facts.

“As a government institution it is customary for the United States Naval Observatory to furnish to individuals who ask for it, by mail or otherwise, information on astronomical subjects provided too lengthy a calculation is not involved. People who seek information on purely astrological subjects are told, however, that the Naval Observatory does not furnish information of an astrological nature. *It is doubtful, indeed, if any astronomer would know how to cast a horoscope or make astrological predictions of any kind.* Certainly any astronomer worthy of the name would feel that he had lost caste in his own profession if he should undertake to do so (Italics are mine.)

I have taken the liberty to place in italics the sentence that explains why Mrs. Lewis wrote the article in which she disparages the growing popularity of astrology; But the real reason why the “average man of today is becoming more and more interested in astrology is not because he is as dumb and thick-skulled as Mrs. Lewis supposes. It is because through a wide variety of periodicals he has been brought into contact with astrological delineations and predictions. Many of these are nothing but trash, and are issued by those who have little knowledge of Standard Astrology and what can be accomplished with it. But some of the periodicals and some of the articles in most of the astrological magazines are the work of those with sound astrological knowledge. Mr. “average man of today” places a great deal of dependence on what the scientists, such as Mrs. Lewis, have to say. But when these pronouncements of science conflict diametrically with his own personal experiences, he is apt, at least surreptitiously and without the knowledge of his friends, to cling rather tenaciously to what he has found to work in actual practice. And through his increasing contact with astrology he is brought face to face with the fact that when the person giving it is skilled, that the information gained by means of astrology is both useful and accurate.

He is inclined to believe, of course, that the astronomers, who are recognized to be, and are, great scientists, must know all about any influence that the planets exert. He is quite unaware of the complete ostracism from astronomical circles, and the academic condemnation, any astronomer would incur who let it be known he took the slightest interest in astrology. He does not realize that no astronomer who was known to be friendly to astrology could hold his job. And it never occurs to him that, “It is doubtful, indeed, if any astronomer would know how to cast a horoscope.” Furthermore, not knowing what natal astrology should not be expected to do, but led to believe by a hostile press that if it is a valid science it should reveal that the birth data submitted by a police woman is that of a non-existent person, he may be

influenced by the ridicule and persecution of its enemies. But if he knew these things much that now perplexes him would be clear. For even the “average man of today” is not so lacking in wit that he places dependence in the utterances of people about things that they have never investigated, favoring which would deprive them of their livelihood, and the very first principles of which they admit they are in total ignorance.

The cosmic alchemist, in the interests of spiritual education, encourages instructions to enable the physical things necessary to health, length of life and usefulness to be acquired, instructions that give as wide a grasp of information as possible, instructions on reconditioning the thought-cells, instructions that cultivate original thinking, and instructions on raising the dominant vibratory rate. These should be included in the education of every child.

Chapter 7

Serial No. 170
Original Copyright 1946
Elbert Benjamine

Copyright
August 2002
Church of Light

How To Appraise Spiritual Values



Chapter 7

How To Appraise Spiritual Values

FROM any event of life it is possible to extract spiritual values. Whatever occurs, by taking the proper mental attitude toward it the character may be improved and the dominant vibration raised. And if the vibrations are sufficiently high they may affect substance of greater velocity than the astral and contribute to building a form on the spiritual plane. Course 3 fully explains the technique employed in this, and indicates that all experiences are the ores of life from which soul values may be extracted.

Yet it also points out that some of these ores are easily handled, that some yield precious metal only with difficulty, and that still others are so refractory that only the skilled spiritual alchemist can, with great effort, obtain anything of worth from them. It seems desirable, therefore, not merely to have a measure of spiritual values such as is afforded by the amount an experience contributes toward raising the dominant vibratory rate, but also to list a number of things from which spiritual values can be acquired with ease, and to indicate how these values may be obtained.

The cosmic alchemist is interested in all three dimensions of life. He is interested in them not merely as they affect himself, but as also affecting all mankind. It is his desire, in every way he can, to aid the rest of humanity to attain that superior development which is his own great aim. But what he can do to influence others to take the proper highway toward such development, as well as what he can do properly to direct his own progress, depends upon him having a clear idea of just what it is he seeks. As we shall presently see, life's values often are sadly muddled in the popular mind.

These values, as we have already discovered, have to do with length of life, with the breadth of its experiences, and with the height, or spirituality, of its experiences. Length and breadth are valuable in that both afford opportunity to make spiritual gains. From the standpoint of mankind, therefore, the individual who contributes to providing the necessities of life performs a spiritual service. But whether or not this activity contributes to his own spirituality depends entirely upon his motives and feelings in rendering the services. If he cares only for the physical reward derived from the service, and dislikes those he serves and perhaps has an inward enmity toward them, he has gained nothing spiritual. But if he has an actual desire to benefit others, and feels some glow of satisfaction in the thought of being a useful member of

society, he has raised his vibratory rate at least a little, and thus has made spiritual gain.

In addition to these things which are merely useful in the maintenance of existence, there are other things which may or may not contribute to length of life, but which do contribute to its breadth. Religious exercises, poetry, music, dancing, moving pictures, radio programs, lecture courses, paintings, sculptures, fiction, architecture, decorative effects, politeness and many other things are not considered necessities of life; but they each and all add something to existence that makes life broader, and which may be utilized also to lift life to a higher spiritual level than that occupied by brute creation. Anyone, therefore, who contributes through these or other channels to the breadth of life is rendering a valuable service. But the effect on his own spirituality depends on whether, in performing the service, his motives and emotions are such as to increase or decrease his dominant vibratory rate.

Greatness is not synonymous with spirituality. It is measured not by the effect of the individual's actions on himself, but by their effect on others. We know very little about the private life and motives of Kepler, who formulated laws by which the movements of the bodies of the solar system can be measured, or of Einstein who in the velocity of light found a yard-stick for measuring the universe. Both of these men are great because each contributed something by which human life can be greatly broadened, and properly used can also be made to yield spiritual values. The measure of any individual's greatness is the degree to which he contributes to the length of life, breadth of life or height of life of other people.

Yet how often do we find even those who assume to be thinkers either attributing greatness to the acts of a man whose influence is devastating to others, or magnifying some small and inconsequential trait that to them seems repugnant, into a mountain that dwarfs some real and valuable accomplishment.

There are those even yet who look upon Napoleon with admiration. A man whose abilities, however great, were not devoted to benefiting his fellow man, but toward turning Europe into a human slaughterhouse for the gratification of his own personal vanity. Others there are who think of J. Gould, the wrecker of railroads, as a man worthy of emulation. And the financial giant of Wall Street who is able to corner some commodity, and thus make living harder for millions of his fellow men, is not without attractiveness in certain quarters.

Yet so long as selfish men are idealized, so long will people strive to be like them, to the detriment of the race. It becomes the duty of the cosmic alchemists, therefore, to set them forth in their true lack of worth; or better still, because the cosmic alchemist believes whenever feasible to work on the side of construction, it becomes his pleasure to set forth in the clear light of their great value the acts of those who are truly noble and great among mankind.

Men exercise their talents under the social conditions by which they find themselves surrounded. However much we may deplore the concentration of the wealth of the world in a few hands, we cannot but admire those individuals who acquire wealth in ways that add to the richness of others, lives, and then with their accumulated wealth perform vast services for the advancement of the race.

If the youth of our land must worship at the feet of material power, is it better that it make heroes of George Eastman and Henry Ford than do homage to, and strive to emulate, Al Capone or some other racketeer who impressed his will upon the public and long remained immune from punishment?

George Eastman contributed markedly to the education of the public. He made it possible for almost everyone to take photographs. These photographs are informative, arouse interest and develop skill in their taking, and lead gradually toward a discrimination of artistic composition. Artistic effects obtained often arouse refined emotions in those who look at them, and thus tend to increase the dominant vibratory rate. The popularity of the camera has contributed to breadth of life and the spiritual progress of the world.

The development, perfection, and cost reduction in the production of movie film has given impetus to the motion picture industry. And the motion picture industry has markedly increased the power of education. It enables twenty million in the United States alone each day to see and hear the important happenings in all parts of the world, to see and hear artistic and dramatic presentations, and to have explained to them visually as well as audibly facts and their relations that otherwise would remain to them obscure. In slow motion they are able to see just how mechanical contrivances perform their work and just how growing things unfold. The moving sound picture is a tremendous force in practical and aesthetic education. By showing the people in one land just how the peoples of other lands live it assists in developing a spirit of cooperation among nations, as well as giving greater breadth to the lives of those who see and hear it.

It lengthens lives through disseminating information on hygienic measures. And it is a medium through which people are led by gradual steps to an appreciation of beauty and refinement. It thus can readily be used as an agent through which spiritual values may be acquired.

Out of the productive activity which has so markedly advanced both still and moving picture photography, and thus benefited the world, George Eastman made a vast fortune. And having been keen enough to acquire it, he was also keen enough to spend it wisely; giving it away to establish educational centers, and to beautify and otherwise improve the community where live those whose labors, under his direction, were responsible for his success.

Henry Ford also was the product of the economic system under which he lived; one of its finest products. The popularity of the automobile has advanced the world mechanically, and through facilitating travel has greatly broadened life. Whether the numerous accidents it has brought are offset where length of life is concerned by

otherwise improved health due to the facilities it has afforded for recreation is a moot question. But it has been an educational agent of great value, increased the enjoyment of many, and has led to a higher appreciation of the beauties and grandeur of nature. Those who otherwise would have had little contact with the out-of-doors, now, on their vacations, take to the open road and visit lakes and mountains and seashore, and fill themselves for the time being with the spiritual richness stimulated by majestic settings and glorious vistas.

Contact with nature of itself does not increase the spirituality. The individual, regardless of glorious out-of-door surroundings, may keep his mind filled with envious or lewd thoughts, or his desires may be so centered on killing some wild creature that he is oblivious of the beauties around him. His vibratory rates, and hence his spirituality, may thus be lowered. But there is more than usual opportunity for feelings to be stimulated that add to the spirituality. And there is reason to believe that the majority do make spiritual gain when their recreation takes them closer to nature.

Henry Ford accumulated vast wealth in supplying the world with something beneficial. But this wealth was not hoarded in idleness. It was used to increase production and lower the price of the product so that more people could possess and enjoy it. It was used to shorten the hours and increase the wages of employees. It was used to give the Ford employee time in which, if he so desired, he could broaden and heighten his life, and to give others more opportunity also, through possession of means of travel, to both broaden and heighten their lives.

I have here mentioned two men who became very wealthy; not because they were wealthy, but because they used their wealth largely for the benefit of society. These are not isolated examples, as many others come to mind. But there are far more at the present day probably, who being very wealthy, are making no marked contribution to human betterment with their affluence. And in the popular mind the mark of distinction is all too faintly drawn between these two classes of influential men.

But when the people become energetic in their approval of those of wealth who contribute strikingly to human progress and happiness, and vigorous and loud-voiced in their disapproval of those who contribute nothing of value to society while accumulating money, and then use it solely for their selfish ends, we shall be on the road toward improvement.

Public opinion is a vast force, and so long as it tolerates and admires ruthless individuals who have no consideration for the welfare of others there will be a new crop of such monsters with every generation. But when society becomes thoroughly saturated with the idea that such individuals are ignoble as well as pernicious, and that the only real greatness is attained through contributing to the common welfare,

the youth of the world will have a different ideal toward which to work. To express his Drive For Significance he will no longer wish to be a racketeer, or even one who oppresses others while remaining within the law. Instead, he will aspire to become a hero after the fashion of those illustrious men who are recognized to have made the world a better place in which to live.

Stressing the Inconsequential

—Yet now, often, how slight and inconsequential a flaw is made to overshadow some truly great accomplishment!

George Washington, to the people of the United States, is a great patriot. Although opposed by almost insuperable obstacles he had the faith and vision to push on toward the founding of a nation that has contributed, in its ideals of freedom and its industrial developments, to world welfare. Not perceiving he had accomplished as much as he really had, toward the end he became somewhat bitter. But he was a man of true character.

One might think, in the light of the difficulties he surmounted, and the persistence with which he pursued worthy endeavors even when there seemed but the slightest hope of success, that trivial matters would have no power to tarnish his reputation. Yet not many years ago, when an ultra-realistic journalist revealed to a shocked public that there was no word of truth in the cherry-tree episode, and that following the custom of his contemporaries, Washington was not averse to a drink of liquor, his credit fell at least fifty per cent in the eyes of many unthinking people.

His personal habits were discussed by these as if they were the really important things about his life. Such people utterly fail to grasp the attitude of the cosmic alchemist, that a man's worth to society should be measured by what he accomplishes for the benefit of others.

What George thought and felt raised or lowered his spirituality. But whether he took a drink or did not take a drink probably neither added to nor detracted from that which he was able to accomplish. In fact, the personal habits and mode of life that enables one individual to do his best work, due to the factors mapped in his chart of birth and their subsequent conditioning, are those that would hamper a differently constituted person. Washington probably lived according to the customs of his times, and tempered his method of life with such acts as he had found through experience enabled him to do his best work. And the really important thing is not whether he did this or that thing that had little influence over the welfare of the nation, but that he did something that markedly was to its benefit.

Still later there was a great furor because Dr. Brill, the eminent psychiatrist was going to read a paper before a meeting of his profession in which he analyzed the character of Lincoln and attempted to show that because Abe seemed to enjoy jokes which at present seem out of place in the best circles, there was a split in his personality. Some of Dr. Brill's colleagues protested the reading of the paper, and were highly indignant

that he should dare suggest that there was anything not absolutely perfect in the character of America's best loved statesman.

Lincoln was a man of the people. His early life was spent among the rugged people who were carving a place to live from the wilderness. The men with whom he associated in the Blackhawk war and as a country storekeeper liked rough stories. They would have been repelled by an expurgated version. Lincoln found that ability to entertain such men was an avenue to popularity. He told the kind of stories these men liked, and he told them unusually well. They liked him because he gave them pleasure. They elected him captain.

As a store keeper, he always had a joke on tap. The people who came to his store liked rough jokes. They considered him very clever. Consequently, he was appointed postmaster, and later elected to the Illinois Legislature.

The people of that time had become suspicious of the polished individuals at Washington who properly had been accused of corruption and graft. Lincoln had earned a reputation for ability and honesty; and had become famous for the aptitude with which he could tell a story either to amuse his listeners or to illustrate a point. His roughness in speech, in dress and in general appearance, as contrasted with those of the slick individuals they wished to remove from power, gave them confidence in him. But in addition to confidence, his constituents liked him because he gave them the kind of pleasure they enjoyed. It is doubtful if Lincoln would have reached the White House had it not been for his jokes and story telling.

Coarse jokes and rough stories lower the vibratory rate and decrease the spirituality. On the other hand, the feeling of sympathy for the downtrodden, and the effort to relieve distress, for which Lincoln was noted, increase the vibratory rate and increase the spirituality. People commonly have different habit-systems, some of which tend to decrease the spirituality and some of which tend to increase the spirituality. But we here are not trying to strike a balance between the lowering and raising influences in Lincoln's life to determine the height of his spirituality. Instead, we are interested in him from the viewpoint of the cosmic alchemist.

Lincoln was an honest man, a sincere man. He was sympathetic and kind to those in distress, even to his own personal disadvantage. And he was the instrument through whom the institution of slavery in the U. S. was abolished. The thing of real importance to all thoughtful people is not whether he had several personalities, whether some of his jokes were in poor taste, or to what extent he compensated in his stories for lack of harmony in his domestic life. The thing that really counts, in so far as others than himself are concerned, is that he contributed by greatness of character, and by his acts, in a pronounced manner to human welfare.

A lady of my acquaintance once said that she had always thought of Thomas A. Edison as a great man until she learned that he chewed tobacco. But what has chewing tobacco to do with it? At worst it contributed some small unpleasantness to his immediate associates. To paraphrase Lincoln's remark when he received the complaint that Grant drank whiskey and made the rejoinder that he wished the other generals would find out what brand of whiskey Grant used so they could have a few victories also; I am tempted to say that if it would contribute to their doing something worth while it might be well for those who criticize the unimportant habits and actions of great men to acquire these habits.

The really important thing about Edison is that he lightened the burden of labor for mankind more than any other man who has ever lived, and every civilized person on earth lives with less hardship because of him.

Nor are such remarks and viewpoints of depreciation confined to the uneducated. A few years ago I attended a meeting of scientifically inclined persons at a lecture devoted to the work of Luther Burbank. The speaker holds several scientific titles, and was personally acquainted with the plant wizard. He gave a very complete account of the important flowers, vegetables and fruits that we now enjoy that were developed by that remarkable man. But he took much pains to stress the great imperfections of Burbank's character. These great defects, according to this speaker, were two in number, and detracted seriously from what otherwise would have been really a worthy life.

These two derogatory traits of Burbank were that he believed in Spiritualism, and that he used profane language. It never occurred to the lecturer that Burbank's ability to use extra-sensory perception not only convinced him of the reality of communion with those on the inner plane, but also made it possible for him to select from innumerable seedlings that to those who worked for him looked exactly alike, the few which when mature would have characteristics in the direction he was seeking. Instead, he looked upon him as a simple minded, superstitious, vulgar and uncultured man. Yet Burbank had warm friends in all parts of the world, and he contributed more than any other man who ever lived toward a better human food supply, and toward placing in people's hands new and more beautiful flowers to decorate their gardens.

Who are we to judge his motives? The many with whom he corresponded found him lovable. Did the profanity which he expressed to release his emotions when all did not go as he wished lower his vibratory rate more than the stored up irritation which many others feel? To what extent was the lowering of spirituality due to profanity offset by the kindness he felt when he sent seeds and other help to acquaintances in various parts of the world? We cannot accurately judge another's spirituality, because we do not know what goes on inside him. But we can judge of his greatness. That can be appraised by his contribution to human welfare.

It may be that on occasions the sensitive ears of some of Burbank's associates were shocked by his language; but such pain could have been experienced only by a few.

Yet everyone who eats vegetables, and everyone who has flowers or looks at the blossoms of others, in the whole civilized world, has benefited by Burbank's labors.

I think this tendency to belittle actual accomplishment and magnify the unimportant, but slightly disagreeable trifles needs energetically to be discouraged. I am inclined to think that youngsters who have pictured to them a character free from all blemish — an idealized George Washington or Lincoln — know in their own hearts that they could not be so perfect in all ways as these men are usually represented. They are given the impression that no one can be great unless he is a paragon in every respect. Realizing that they cannot become such examples of perfection, they become discouraged from attempting worth while accomplishment. If they were given a truer picture; that in spite of many an unimportant blemish a man often is able to perform a signal service in the onward march of humanity, they would be heartened to effort.

The Really Important Thing

—As a matter of record, the conditions under which men perform their highest labors are unusually varied. Astrological influences, the conditioning factors that early in life give a set to their emotional reactions, their physical responses to certain environments, and a wide range of other things often contribute in a marked manner to what men can do.

I know a writer of "best sellers" who spends a long period thinking out the plot and details of a novel. But when he feels moved to start the actual writing, he hardly stops to eat or sleep until it is finished. Unquestionably he has injured his health by this method. He has written on occasions for forty-eight hours without sleep, and with only a bite to eat now and then; has written until he fainted from exhaustion, fell from his chair unconscious, and had to be packed off to bed and a physician called. As a result of this method his health is poor his wife is worried and harried all the time he is thus writing, and his immediate associates suffer in various ways. But he turns out reading matter that not only conveys a real message to those who read it, but which sells often over a million copies. From the standpoint of society it is unimportant that he is now a millionaire, that his health has failed, or that on the occasions when he is actually writing he makes himself and several others quite miserable.

The important thing is that he has given enjoyment and a fine outlook upon life to millions of those who have read his books.

Personally I believe in temperance. Having no use for tobacco, alcohol in any form, riotous living, or any kind of stimulants, I feel confident their use would cut down the volume and quality of my work and detract from the quality of my life. But in my birth chart there is plenty of fire, and enough air to make it burn well. I have never felt the need of anything artificial to give me the impetus to work. But am I to judge all others by myself? How about the individual who has little fire in his chart, has a sluggish circulation, low blood pressure, and a general tendency toward inertia? Or how about the man who has so much fire he has to quench it to keep from burning

himself out? As to these individuals I cannot say. I would counsel them to the temperate mode of life that I have found generally best for others and which I know is best for myself. But if the exceptional individual can add something of value to the world only under some mode of life that is different from mine, should I grumble if he lives in that manner, provided he injures no one but himself?

I do not know whether or not James Whitcomb Riley drank to excess. But if it so chanced that he could write only when under the influence of liquor, and that without liquor we should have been deprived of his homely verse, I, for one, am glad that he was occasionally drunk.

Such a statement, I quite realize, places me open to the criticism of the unthinking, conventional mind. But my point is that whether or not Riley imbibed spirits freely has no lasting influence on mankind; while the soul-stirring melodies which he left have lightened the hearts of innumerable people. Whether Riley's emotions when he wrote and read them raised his vibratory rate more than enough to offset the other influences of any dissipation in which he may have indulged relates to the spirituality of Riley. But the emotions they arouse in others measurably add to their spirituality. They are a lasting contribution to the advancement of the human race. The thing of real importance in a person's life, in so far as others are concerned, is to what extent he detracts from, or adds to, their welfare.

I think this point can best be illustrated by a story about a Jew. I do not select the Jew as better or worse than the members of other races, but because it is the custom to use a Jew in any story of money made by sharp practice.

This particular Jew, the story goes, was asked by a friend who came to visit him, why he looked so worried. The Jew then went on to explain that twenty years previous, when still in his youth, he had been tempted, and had fallen from the orthodox faith to such an extent that he had eaten a piece of pork. Since that day he had been haunted by the immensity of his transgression, the taste of that one piece of pork still lingering in his memory; and he could not free himself from remorse.

His friend sympathized with him, and went on to say that he had supposed the worried look arose from financial troubles. The Jew, at the mention of finances, brightened immediately, rubbed his hands together in an expression of enjoyment, and revealed to his friend that on the contrary he had recently been unusually fortunate. He had purchased a hotel at a very low price because it was infested with bedbugs; and then, by keeping the knowledge of the bedbugs from a prospective customer, he had been able to sell it at a profit to himself of fifty thousand dollars.

Many people are similar to the Jew; their conscience would harass them for years at the breaking of some trivial convention that really injured no one; but within the conventions and within the laws of the land, any injury to another, howsoever serious, would be a cause of no regret. They are trained in conventions, and in obedience to their laws, but all too often they have no training in the appraisal of true spiritual values.

Legislation is valuable in keeping the actions of certain individuals within some bounds; but no system of legislation can be devised that will prevent an unusually shrewd man from taking advantage of an unusually dull person. Legislation offers some protection, but in spite of it the strong can still prey on the weak. To obey the laws of the land is not sufficient to be spiritual. If by your actions others are injured, even though you are well within the legal requirements, the motives behind those actions lower the dominant vibratory rate and decrease the spirituality. To be spiritual you cannot be callous, but must make a sincere effort to help others.

Spirituality Implies Positive Action

—Do not think, as is the widespread belief in the Orient and in some Christian circles, that spirituality is a negative quality. To retire from contact with your fellow man, except through it you are able to benefit him, is not spiritual; it is just plain selfishness. To wear a frown, to refrain from all pleasure, and to lead a narrow life, conduce neither to length nor breadth of life, nor does it increase the dominant vibratory rate and thus the spirituality.

Puritanical Christians strove for a rigid austerity here so they might escape the pain of hell and enjoy the pleasures of heaven in the hereafter. But if the escape from pain is good hereafter, why not now? And if enjoyment is good in heaven, why not good on earth? So long as no one is injured by enjoyment, why should it be shunned? If it is a type which lowers the dominant vibratory rate it is unspiritual. But if it is of a kind that adds either length or breadth to life and does not lower the vibratory rates it has value, and if it tends to refinement of the emotions it is spiritual.

Stimulating the Spiritual

—I have now mentioned a few men who have contributed in a marked manner to human welfare; and earlier in the course I have made some mention of those things which tend to increase, through better economic conditions, the length and breadth of human life. It is time, therefore, that we turn our attention to some details of the objects and conditions of environment that most readily tend to stimulate and cultivate the loftier, finer emotions, as distinct from those lower and coarser that we share with brute creation.

Again it must be pointed out that, in so far as the individual is concerned, a thing is spiritual or unspiritual as it evokes in him higher or lower vibratory rates. The effect of any object or situation, therefore, on one person may be entirely different than on another person. The spiritual alchemist will have thoughts and develop emotions that contribute to his spirituality under circumstances that beget only gross animal passions in the common man. Our appraisal of the value of things from the standpoint of stimulating and assisting man's spirituality, therefore, will be made on the basis of the ordinary person's reactions.

The average run of mankind experience certain sensations, certain emotions and certain thoughts when brought into contact with stimuli of a definite kind; and these common reactions determine whether or not the stimuli in question are beneficial or the reverse to man's spiritual advancement.

Spirituality Through Recreation

—Let us turn, therefore, from man's vocation and his other activities through which he should do something to benefit his fellows, to the various other activities and contacts which contribute to his experiences with life. At once, because serious and concentrated application to work calls for it, we think of his recreation. The business man not only applies himself to his calling, but to find relaxation from it, frequently turns to sports. He is a golf enthusiast, attends prize fights, drives a car, or goes to races.

Because of a certain odium attached to them, due to the rough crowd, due to the gambling and carousing of some who attend them, and because some of them are conducted in a brutal manner, the unthoughtful person would quickly reply, if asked, that nothing spiritual can come from our sports. But sports may be conducted in such a manner, and some of them are, as not to arouse coarse or brutal feelings, but on the contrary, to stimulate an appreciation of graceful and effective activity, of alert intelligence, and of fair play toward even a successful rival.

Good sportsmanship has become synonymous with giving the other fellow his just dues, even if it means the loss of what one is striving to gain. In a contest watched by others, these others identify themselves and their interests with one side as against its opposition. If their sympathies and desires are not thus intensely partisan, they get little pleasure or excitement from the contest. But to the extent they identify themselves with one side against the other, do they experience, vicariously, the thrills of the contest.

Under these circumstances they expect the contestants with whom they have merged interests to conduct themselves in the same manner they would if they had the skill and were in the contestants, place. Through attending sporting events the public has become so thoroughly conscious of good sportsmanship that it voices its disapproval of any unfair practice on the part of its favorite as quickly as if the unfair practice had been adopted by an opponent.

Let us give some credit to our national sport, baseball, for educating people to a more spiritual emotional reaction.

And the emotional reactions that have been conditioned toward fair play and honorable conduct in baseball, football and golf, exert also a powerful influence toward similar fair play in all the contacts of life. The man who develops a sense of good sportsmanship during his recreational hours, is likely more and more to adopt an attitude of good sportsmanship in his domestic relations and in his business life. Not only does he scorn to take advantage unfairly of others, but he praises true ability

wherever found. Instead of whining or running away when his affairs go wrong and hardships are at hand, he faces them with resolute courage, because that is the sporting thing to do.

It is a good sign, I am sure, when some opposing player through phenomenal skill and brilliance snatches the victory from the home team, to see that not only the visitors, but also those who most excitedly have been urging the home team to victory, rise in a great ovation. They are downhearted at their loss, and some of them, no doubt, have lost money as well as their pride — for sports still have an unspiritual side — but in spite of such loss and disappointment, the home people rise as a man to do homage to their opponent who has exhibited superior skill.

Superior ability should receive recognition; for the advance of mankind along every line is made possible by the exercise of unusual talent. Not only should there be, as encouraging each individual to develop and use his abilities to the utmost, an emotion of enthusiastic pleasure when such superior ability is displayed, but the emotion of joy in a contest is quite appropriate to the forward movement of mankind.

Life is a series of contests; and it becomes far more effective and enjoyable when these contests are approached as a game, a game to be played fairly according to all the spiritual rules, to be played with utmost energy to obtain the victory, and without whining and self-pity when there are temporary, or even more permanent, defeats. Every situation is a contest in ability to solve the problem of how best to conduct oneself toward it. Every difficulty and hardship is an opponent to be defeated. Good sportsmanship, which is encouraged by the right kind of recreational interests, makes for a more useful and a richer life.

Contests may be, and often are, brutal. In the measure that they engender cruel and brutal emotions in those who witness them, they are unspiritual. It certainly is unspiritual to take joy in the suffering of either man or beast. But the individual who voluntarily and joyfully undergoes some pain and temporary suffering in his effort to vanquish an opponent is seldom an object of pity. People admire his courage; and courage is a fine thing to cultivate. Mankind needs plenty of it in its conquest of the forces of nature.

Almost everything we do is a contest with something or someone. Everywhere there is competition. The cosmic alchemist competes with others in his efforts to aid human progress. This spirit of contest is not to be deplored; for competition is the method Nature has used throughout in the development of more perfect forms. It is doubtful if any other method is quite so effective. But these contests need not be struggles in which one individual destroys or punishes another. Instead, they should be contests to contribute most toward human life and happiness.

There is an aspect of witnessing contest games that is not altogether beneficial. In some an attitude may be developed in which struggle is experienced, with all its emotional reactions, only vicariously. That is, experiencing hardship and contest only through sympathy with others who actually and physically engage in it may, under certain circumstances, create an attitude toward life in which the actual facing of difficulties is increasingly avoided. Such an individual may become so engrossed in his emotional reactions that he feels no need of actual events to satisfy his longings.

This, however, is not the fault of the sport; but that of any individual who lives too exclusively in his emotions. Emotions should energize appropriate actions. It is possible to cultivate a condition in which emotions are permitted to pass without stimulating to accomplishment; but this is due to the formation of inadequate habit-systems in which the energy that otherwise would drive to accomplishment is dissipated; much as an auto stalls while the engine is running if the clutch be disengaged.

Then again, in such sports as are not based upon contest, symmetry, grace, coordination and harmony of movement are factors to call forth admiration. And form, as it is called, is essential to success in all athletic pursuits. This so-called form is an expression of greater perfection; and perfection is that toward which man should strive. Such activities, therefore, cultivate a habit of striving for superiority, a habit which readily can be employed for spiritual ends.

Why Gambling Is Unspiritual

—The gambling which is associated with many sports detracts from their usefulness. Not that taking a chance is unspiritual; for all through life when called upon by necessity to do so man should have the courage, without flinching, to take whatever hazards are required. But gambling is not just taking a necessary chance. On the contrary, it has for foundation, and tends to cultivate one of the basest, and another of the most pernicious of human traits. When successful, gambling usually takes from another without giving adequate compensation that which makes the other poorer. It therefore cultivates the ignoble trait of attempting to benefit at the expense of others. And even when no one is made poorer by it, it cultivates the tendency which, if it takes a strong hold, totally unfits the individual to fulfill his responsibilities to society. It cultivates the pernicious desire to get something for nothing.

As to drinking and coarse talk, these do not of necessity belong to sport. But wherever found they are decidedly unspiritual. Vulgar language coarsens and degrades. Liquor, on the whole, tends to the stimulation, not of spiritual tendencies, but of base propensities and animal desires. It also tends to break down that which man, throughout his evolution, has been at most pains to build, and upon which rests most of his superiority. It tends to break down self-control. In so far as liquor coarsens the thoughts, excites the animal passions rather than the nobler impulses, and in so far as it lessens self-control, it is unspiritual in its effect. There may be those

who need it in small quantities to do their best work, but any tendency toward drunkenness is certainly the opposite of spiritual in its common effects.

Education Should Never Cease

—Life differs from death in that the former implies activity and consciousness, and the latter lack of them. Do not think, consequently, that not to do this and not to do that is spiritual; for in fact it is but the absence of life. How shall there be spirituality without life to develop it? No doubt it is true, as so often complained, that some moderns rush through life at such a tremendous pace that they destroy themselves; burn themselves out, as it were. But my own observation is that far more people placidly and passively drift through life, doing very little they are not compelled to do. They thus fail to gain breadth for their lives that comes only through varied activities and mental and emotional contacts; breadth that may be employed to acquire the spiritual treasures that so abundantly are at hand.

There is such a thing as over-work and such a thing as over-play; and dissipation quickly drains the vital forces, leaving only ashes where spirituality might have bloomed. Each one must experimentally determine just how much physical, mental and emotional activity he can stand without detriment to his health and length of life. To live below this maximum is a sad waste of opportunities. We can only be of greatest service to others, and can only attain the utmost in our own mental and spiritual advancement, when we cease to be negative and cultivate habit-systems that find joy in energetic application to every situation of life.

Just as an example, while an increasing number of people take vacations and travel, many more could do so but for their listlessness. Do you think listlessness is spiritual? It is merely a lack of interest in life; and no one can get the most out of life for himself or others who is bored with it. Nor would I mention this so emphatically were it not that usually it is the direct result of the development of pernicious habit-systems and, as explained in detail in Course 14, can be changed by the development of different habit-systems.

Then again, from the attitude of some at commencement exercises, one might be led to believe that finishing high school, or finishing college is the completion of education; when in fact, as the common expression implies, it is but the beginning, not merely of putting into practice what has been learned, but of learning. One might think also that education is comprised merely of cramming the head with facts. Facts are essential, but of quite as much importance is the education of the emotional reactions. Not only do our feelings more than our intellects determine how we behave when confronted with each situation, but they influence the fortune or misfortune the thought-cells attract into our lives and determine the dominant vibratory rate, and hence our spirituality.

Neither mental nor spiritual education should cease at any period. When we no longer serve others and no longer gain information and have emotions that broaden our lives or elevate them we have truly ceased to live. But until the fires of vitality burn so low that no strength is left and the body is on the road to disintegration there is no necessity to cease interest in things, no necessity to abandon physical and mental activity, and no necessity to refrain from joyous emotions. With advancing days the range of mental comprehension should increase. The type of physical activity, no doubt, will change from time to time, but there should still be an eagerness to do something. And because of the long years in which the emotions have been educated there should be a keener appreciation in age of the things that can be employed to raise the dominant vibratory rate and thus increase the spirituality; a keener appreciation, for instance, of all that is beautiful in literature, music, art and nature.

Chapter 8

Serial No. 171
Original Copyright 1946
Elbert Benjamine

Copyright
August 2002
Church of Light

Minor Aids To Spiritual Advancement

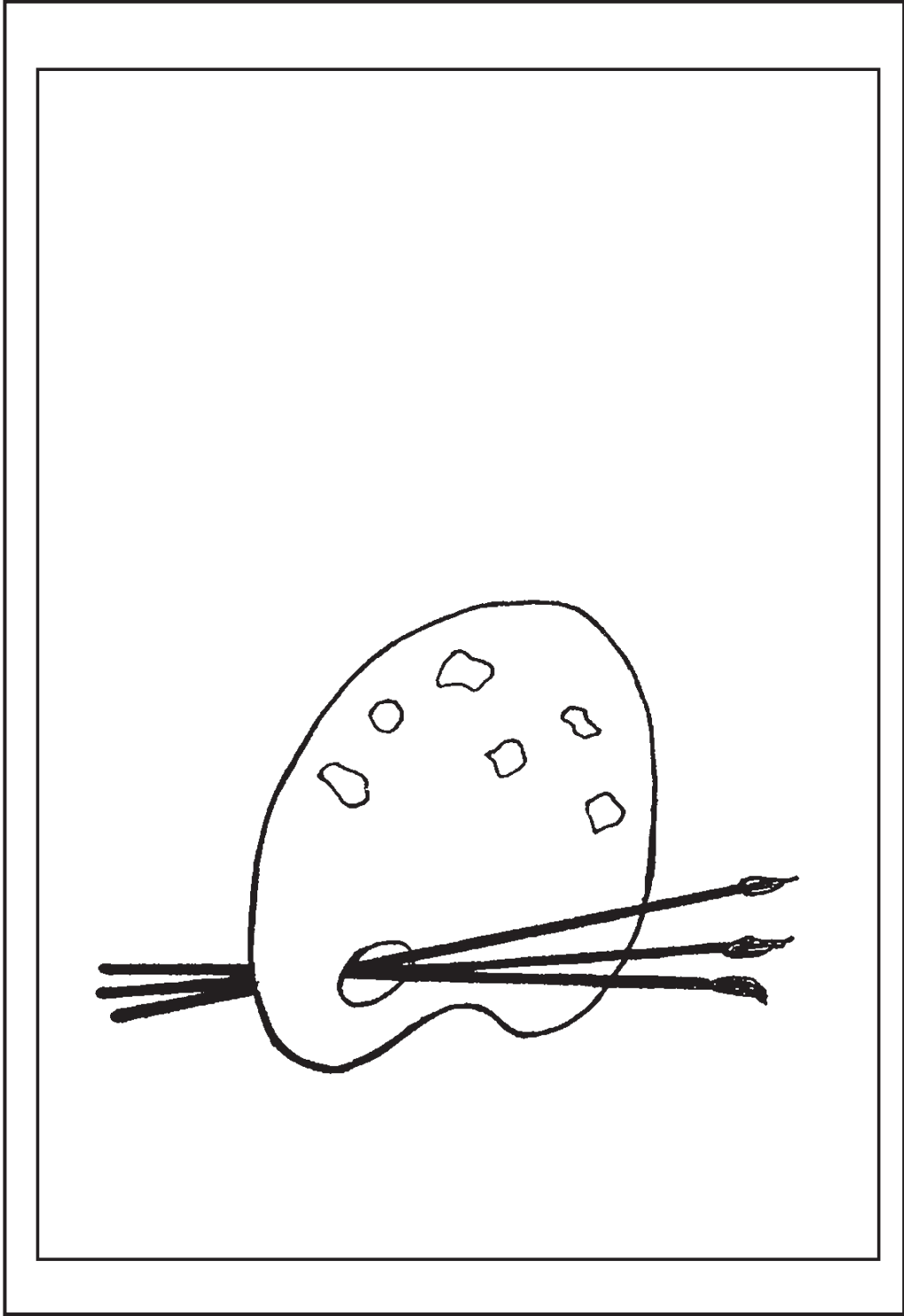

Chapter 8

Minor Aids To Spiritual Advancement

BREADTH of life, length of life and elevation of life are the chief interests of the cosmic alchemist. Not merely for himself, but also for humanity, or for so large a section of it as it is possible to reach. As for himself, perhaps he is so skilled in transmutation that he can make large gains no matter what ores of experience life has to offer. But for others, and in the interest of the progress of the cosmic whole, he finds it expedient to throw the weight of his utmost in energy toward furnishing people with as many facilities as possible by which these three things may be gained.

Life, he finds, is divided into alternate periods of effort and relaxation, of work and play. Those work best who also play most completely. Days of activity are separated by nights of sleep, mental strain is relieved by physical exertion, and the tensions of both mind and muscle are soothed by pleasant emotional expression.

Some there are, he knows, who drudge so persistently in the groove of a chosen occupation that any real meaning of life escapes them. They are mere machines performing work. And while perhaps they add something material to the wealth of the world through their activities, because of lack of variety in thought and emotion they nevertheless impoverish the race by so much as otherwise they might have attained. The life of the world in its breadth and height is the total of the experiences of its numerous individual lives; and every individual who fails to reach high and noble emotional experiences, whose life is barren of diversity and mental interests, detracts from the value of total human existence.

And others there are, mostly those with ample and unearned incomes, who seek variety at the expense of responsibility. They do no work, because they have money, and instead of finding in this leisure the opportunity to perform some worth while and needed labor through which society in some measure may be benefited, they flit hither and yon, seeking this pleasure and that. Contributing nothing of value to mankind, they really are parasites. Some of them are men who have inherited money. Others, in large number, are women who have been freed from productive activity through the incomes of their husbands.

But real wealth of life can neither be inherited nor vicariously attained through the efforts of the marriage partner. No more so than can learning, and no more so than can character. To have richness of life one must gain it through individual effort; and

no life can be considered truly rich that shirks productive labor. However varied and diverse his interests and emotions, he who fails to make some contribution of productive effort has lost what otherwise would have been his most precious possession. Instead of pulling his share of the load, he has weakened himself through becoming a retarding brake on the revolving wheel of human progress.

Those whose eyes are so fixed on their toil that they fail to note the beautiful things of life and who fail to partake in its wholesome joys, alike with the so-called fashionable set that wastes its time in artificiality, each get less than half the blessings life has to offer. Some constructive work upon which enthusiastically to enter is a prime essential to acquiring those spiritual values that make life worth while. And as alternating from this work, and making for fitness in its performance, as well as refining the mind and feelings, certain intellectual and emotional work becomes only less imperative.

But pity the wasters! Pity those whose chief interest in life is selfish gratification! Pity those who take from society and make to it no adequate return! Pity the parasitic women who marry into idleness, and do nothing more constructive than give parties and dinners to other equally idle women and men. Pity the man about town who has nothing more serious to occupy his mind than to seek perpetual entertainment! Pity those who waste their time, who in reality are loafers and parasites on industrious people! Pity them more even than those who do something constructive and at the same time, through dissipation, waste both health and money!

Graciousness and Tastiness

—But we must not conclude that graciousness of manner and beauty of surface, upon which the idle moneyed folk so dote, are without their value. They may be, and often are, but a thin veneer by which licentiousness and unscruple are hidden; but at least we must recognize that even a pleasant artificial covering makes more endurable the daily contacts of life. It contributes little that is sterling, perhaps, to the character beneath; but it does detract from the harshness and the discords of social communion.

A character of great worth may express itself in a raw and brutal manner. Yet such form of expression gives something of pain to others, and adds nothing of value to the character. Gentility of manner and politeness of speech may be the cloak of a wanton woman or of a rascally man, and such outward appearances should not be taken for inward reality; but they do impart a sense of refinement that gives pleasure and detracts from the possession of no one.

Then again, we all must live somewhere and all must use certain implements and utensils. Primarily, perhaps, the home should be a place of shelter from the inclemencies of the out-of-doors. But increasingly important as a secondary function is its power to enrich the life with finer emotional values.

If a home provides shelter only, it has failed in its own almost equally important function. That function is to educate the sense of beauty. As a shelter it tends to prolong life, but by its artistic effects it should add richness. If so situated that there can be a summer lawn of growing grass the eye is rested, the mind is refreshed, and emotions of peace and contentment are engendered that have a real value. If there can be a little hedge of shrubbery, and a little plot of flowers, whose blooms one cannot help but love, something else, something fine and high and good for the soul is added to existence. The tender care of growing things softens hate and jealousy, and even the sight of flowers, to the appreciative, is enough to dissolve incipient thoughts of strife and turn the mind into the soft, warm channels of their adoration. A beautiful home is no insurance of increased spirituality, but it does afford the facilities that encourage it.

The morning meal, no doubt, sustains the effort of the day as well when partaken from thick and coarse-grained plate, when the table-cloth is frayed and dirty, when the silver is battered, and when the chair on which one sits is rickety and without comfort. But apart from physical food, we are also absorbing emotional impressions; impressions that tend to the coarse and brutal, or impressions that refine and elevate. Length of life is assisted by the food partaken, but the richness of life is added to, or subtracted from, somewhat by the surroundings in which we eat. Clean linen, flowers on the table, china that appeals to the touch and that presents some attractive design, silverware, not necessarily costly, but that gives pleasure by its form; all these things, while not essential to length of life, do add to its richness.

What this really means is that there is greater enjoyment in the presence—the sight, sound, smell, taste and feel—of certain things than in the presence of others. Such enjoyment, however, is not static; it is progressive. That is, by gradual steps we educate ourselves to more intense enjoyments, enjoyments of a more refined quality. And because life moves toward that which it enjoys, and away from that which causes pain, it is quite proper and essential for human advancement that refined things, as contrasted with those vulgar and brutal, shall increasingly be enjoyed.

About the first indication that man had ceased to be merely a brute, and had become human, is to be found in the primitive paintings on the walls of his caves, carvings on the ivory tusks of mammoths, and in the pains he took to make his stone implements not only more useful but more attractive to the eye and to the touch by a better grade of workmanship. Coincident with the emergence of the caveman from stark bestiality we find the development of artistic tastes, the development of an appreciation of symmetry, harmony and beauty. And from that ancient day to the present we are wont to judge the advancement of a people more by their artistic attainments than by any other measure; more by the quality of their emotional appreciation than by those industries which contribute solely to the length of life.

It would, of course, here be out of place for me to go into a discussion of how artistic effects can be obtained, either about the home or elsewhere.

But it is not apart from my function as a cosmic alchemist to indicate that there is no virtue in ugliness. Ugliness begets pain, and pain is both repellent and destructive. The road of progress for the human race is along the cultivation of habit-systems that lift it from that which is sordid, brutal, selfish or gross. And habit-systems are built on enjoyments. Man, therefore, should learn to enjoy, to the utmost, those things which are refined and beneficial.

If we take joy in having the tools we use of symmetrical design, the utensils about the house graceful in outline and otherwise attractive, in having the rooms properly planned and tastefully decorated, in possessing a lawn of growing green bordered by thrifty shrubbery and bejeweled by little plots of smiling flowers; we are lifting our emotional experiences from the muck of gross passions, and our lives from the plane of sordid materialism. Such joys displace the thought and tendency to crime; while filth, harshness and confusion in the environment suggest and engender similar mental and emotional conditions. It is easier to think sunshiny thoughts on a sunshiny day; and easier to feel the noble and more spiritual impulses of kindness and aspiration when surrounded by objects which by their nature tend to divert the energies into lofty channels.

Architecture

—Let us take a ride through the tenement house district, or go to the region where some factory or mine has erected row on row of houses of a dingy sameness for its employees. Or let us take a trip through the gas-house region, where smoke and dirt and squalor are rampant. Do the distressing sights, the abominable rackets and the vicious smells here encountered give us the feel of well being? Soot and grime all over, and ugliness staring at us from every visible contour, make us neither happy nor turn our thoughts to anything except misery and distress. To be sure, the spiritual alchemist who long has trained himself, can shut out the sight and sound of external conditions and live companion to the beautiful thoughts within himself. But the people living here are not spiritual alchemists, and the impact of such misery-creating stimuli is so strong that when endured for years, day after day, even the spiritual alchemist would find it difficult to live above its degrading power.

The mind of man unconsciously is influenced by the suggestions offered by the things he contacts. A decent suit of clothes thus gives self-esteem to a man who in rags is a cringing bum. A run in her stocking, if she knows it, gives almost any woman on a shopping expedition a decided feeling of inferiority. And those square cubes of steel and concrete, rising sheer from the sidewalk without bend or break, except for window-glass, one story above another, reaching their ugly backs to the sky, make those who pass them, and those who work in their unattractive cells, feel that utility is the all of life, and that existence is but a machine-like routine grind.

But this old-style and repellent office-building type of structure is now being replaced by something else. The box-like effect is giving way to a pleasant tapering and an effect of height. There is something

of the pyramid in the broader outline. Yet the tapering is pleasantly presented through repeated steps from the massive base, each sudden recession being followed by a renewed rise, thus holding back the eye, yet after each pause directing it more strongly upward; up and up, to a final substantial tower that pierces the blue of heaven, and lifts the soul to a meditation on ineffable things.

Those to whom we entrust our savings have long been aware of the power of suggestion in architecture. The bank is built of massive stone, with small windows to increase the impression of solidity; and huge granite pillars in front, as if the earth itself might crumble and still the bank remain firm. The interior is spacious, the floors beautifully tiled, and the furniture rich, solid and strong. And so thoroughly is this suggestion absorbed unconsciously by the public that it deposits its money with almost no knowledge whatever of the character and ability of the bankers, which are the real factors of safety and risk, in full confidence that there can be no doubt about the reliability of so firm a looking bank.

So also, this same power of suggestion is offered by the outline of our homes, by the form of our stores, and by the tremendous upreaching of the better designed office buildings. The towers of these edifices point heavenward in sheer beauty and cannot fail to lift the mind in aspiration. They suggest clean living, lofty ideals, independence, freedom and the power of the human soul to accomplish. The squat and ugly boxes by which they still often are surrounded bind the soul to earth; but the smooth pinnacle of a better architecture points the way to a higher destiny.

Personal Appearance

—There is a legend, inherited from Puritan ancestry and the Orient, that it is extravagant and even wicked to spend good money for that which, instead of being merely useful to prolong life, is only beautiful. Coming to our classroom in Los Angeles are visiting occult students who deem themselves the very essence of spirituality. A certain type of these, both men and women, make great virtue of wearing the plainest, most inexpensive, and most unbecoming clothes. These clothes, together with the seriousness of their demeanor, the circumstance that they never go to any but educational movies, and that they deny themselves everything but the barest necessities of life, are the tokens by which they impress others with the idea that they are now so spiritual that nothing on earth longer is of interest to them. The things of the flesh they have completely put behind them.

But why cause others pain in the effort to be spiritual? People recoil from that which is ugly; and these individuals by their dress and manners repel those who come in contact with them. We are always glad to have people attend our classes and our Sunday sermons; and even if they are dressed dowdily they are quite welcome. Yet it seems inappropriate that they should make a virtue of that which causes their associates so much discomfort.

One cannot help but feel that if the region toward which they are moving is characterized by ugliness and disorder, if their heaven is a confused and slatternly heaven, if the spiritual state in which they hope to dwell hereafter is as drab and dreary as their appearance suggests; one would prefer to find some other land in which to dwell. Yet if the spiritual state which they ultimately seek is bright and happy, instead of dull and morose, why should they not seek to establish something similar here? Man does not come into one state of consciousness by cultivating its opposite; and if spirituality is a joyous state, we do not reach it by being sullen.

I am not unaware that too many material possessions, however beautiful they may be, may so absorb the energies in taking care of them, or in acquiring them, that no time is left for real living. But usually the same amount of effort required to build a town whose unattractive houses are scattered about in confusion, whose streets are shabby, and whose stores are box-like affairs, if there were proper planning could be made to produce a town of neatness and beauty, whose general appearance would give an atmosphere of well trained tastes. And the people living in such a place, where hovels and slums were non-existent, unconsciously would be impressed by this atmosphere to such an extent that much that is sordid in thought and action would disappear; and it would be easier for everyone living in the place to turn his mind to kindly deeds and noble aims.

People Feel Two Environments

—Man's environments may shove him about, as when a tornado comes along or a flood sweeps him away. But their more customary influence over him is exerted through their power to make him feel. When there is a blizzard he feels, and consequently acts, in one way. When the sun beats down upon him with unaccustomed vigor he feels, and consequently acts, in quite a different way. When a progressed aspect from Mars adds energy to his thought-cells he feels aggressive and combative, and is apt to plunge into strife. When a progressed aspect from Saturn adds energy to his thought-cells he feels cautious and thoughtful, and is likely to be more deliberate and less rash than usual in what he does. Nor is it necessary for him to know why he feels as he does in order for him to act in accordance with these feelings.

He may not know what causes him to be ill; but if he feels ill, he will act in a manner quite other than if he were well. He may not be conscious that the disorder and grime in the room where he works is what makes him feel uncomfortable; but the uncomfortable feeling, nevertheless, will cause him to think thoughts that otherwise he would not have. The suggestions of environment, quite as much as its obvious contacts, strongly influence man's thinking, and consequently his life.

The events and conditions that come into the life are chiefly due to the activity of the thought-cells. They are not directly due to planetary influence, nor are they chiefly due to the physical environment. Progressed aspects may give the thought-cells harmonious or discordant desires, and they give them more energy with which to work, but the events are chiefly due to the pressure exerted on environment and behavior by the thought-cells.

An approximately correct picture may be obtained if we think of our physical body, our inner-plane form as mapped by the birth-chart, and our thoughts as different phases of ourselves. We then exist in, and are influenced by, two different environments. The physical world, including the behavior of the people we meet and the various material things we contact, embraces the outer world environment. Astrological energies, other peoples' thoughts, the astral radiations of objects both of the outer and the inner plane, and the influence of the spirits of the dead and the denizens of the astral world constitute the inner world environment.

On an average the inner world environment has as much influence over the individual and what happens to him as does the outer world environment. He is aware that the physical things he contacts and the people he meets influence the trend of his thinking. But usually he is unaware how powerful are the suggestions he receives from such sources, or that the energies of progressed aspects, the thoughts of other people, and various inner-plane forces and entities also influence his thoughts and behavior. Yet on an average the inner-plane environment has as great an influence over his thoughts, feelings and actions as does the whole of his outer-plane environment.

But whether his thoughts and emotions are stimulated by the conditions of his outer-plane environment or by those of his inner-plane environment, they influence the desires of his thought-cells and thus powerfully affect the events that come into his life.

His thought-cells bring events into his life such as they desire through influencing his behavior, and through bringing extra-physical pressure (which university scientists now call the psychokinetic effect) directly to bear upon the physical environment. From our studies of the manner in which progressed aspects coincide with characteristic events, we are warranted in concluding that on an average the events which come into the individual's life are about equally due to his physical behavior and to the pressure which, unknown to him, his thought-cells, working from the inner plane, bringing to bear upon his environment.

Unfortunate events arrive unheralded, even as typhoid fever once arrived with no intimation of its cause. But just as surely as typhoid can be escaped if its bacteria are not contacted, so can the individual escape certain other unfortunate events when he recognizes the conditions of the inner world environment which make them probable. and avoids them.

He cannot, of course, avoid a certain discordant progressed aspect forming in his chart. But he can avoid the type of thinking which it commonly stimulates. And even

as were he in a physical environment in which the water was apt to be polluted with typhoid bacilli he would boil the water before drinking it, so with the knowledge that his thought-cells are receiving energy of a kind that will tend to cause them to work for a certain type of unfortunate event, he can deliberately cultivate thoughts and feelings designed to give them other and more beneficial desires.

And as what the thought-cells are able to accomplish depends not only on the energy at their disposal, but upon the facilities of the physical environment for the type of event they seek, he can select physical conditions that will offer great resistance to them.

Other than offering resistance to certain events and facilities for others, everything man contacts in the external world has some influence on the way he feels, and hence on the way he thinks and acts. This makes it possible not merely to select conditions which assist him to give his thought-cells more beneficial desires, but also to select interests and enjoyments that, instead of making him feel degraded, coarse and mean, make him feel joyous kindly, refined and filled with noble aspirations. And because such stimuli tend to elevate mankind and assist in its progress, he encourages them wherever he can.

Such things the individual desirous of spiritual progress will find of much aid. But in making selections it should be recognized that, due to temperament and previous conditioning, something that causes one person to feel one way may cause other persons to feel quite differently. It is well, therefore, that we possess a yard-stick with which to measure spiritual values. Length of life is measured in years. Breadth of life is measured by the variety and intensity of its experiences. Both offer opportunity for gaining spirituality. But the measure of spirituality itself is the height to which these experiences raise the dominant vibratory rate of the individual.

The effect on raising the dominant vibratory rate, or lowering it, depends upon both the type and the strength of the emotional response. The grade of feeling induced determines the direction in which the dominant rate is influenced; but the strength of the emotional energy determines whether or not the customary vibratory rate of the individual is more than fleetingly moved from its previous level. The spiritual help to be derived from anything depends on the individual. A beautiful painting in the nude, for instance, may cause the soul of one man to soar aloft to a contemplation of deific beneficence, and kindle in him the utmost in feelings of tenderness, kindness and well wishing. It may bring an upwelling aspiration to be noble and fine. Yet to another the same painting may stimulate only licentious thoughts and the desire for animal gratification. Due to difference in unfoldment the picture is an aid to the spirituality of the one, and a detriment to the spirituality of the other.

What is beneficial for an individual, it will thus be seen, depends upon his conditioning. But the cosmic alchemist being primarily concerned with the progress of mankind as a whole cannot permit himself to be too greatly restricted by the special requirements of some one individual. Instead, he desires to throw the weight of his influence toward causing society to become familiar with those things which, through awakening finer and loftier feelings, usually tend to increase the spirituality. Consequently, he studies the common effect of various things on man's emotions, and encourages familiarity with those which usually elevate, and discourages familiarity with those which usually lower, the level of man's desires.

Comic Strips

—It is not at all clear how much some things, such as the popular comic strips and the animated movie cartoons, elevate or lower the spirituality. Through their appeal to fantasy thinking, often forsaking everything that is even near the plausible, they may tend to break down the power of discrimination, and through the crudeness of the action portrayed they may tend somewhat to cultivate a tolerance of rough behavior and even violence. But on the other hand, through accentuating and bringing to notice certain human frailties that otherwise might go unobserved, and through poking fun at the crudities of life as it is commonly lived, they may engender thoughts that lead to desire for something better. Probably it is as well not to pass a blanket judgment on such things, but to advise each to observe the emotional effect upon himself.

The Measure of Any Art

—I shall not attempt any definition of art; for on this those who have made life studies of it do not agree. But in any art, whether that art be the making of cartoons, dancing, architecture, music, literature, painting or the drama, as it seems to me, the artist has some idea or feeling which he is trying to express. This emotion or conception may be noble or ignoble, trivial or sublime; but whatever it is, in expressing his art he endeavors to communicate this something he perceives in a manner that will cause others to think or feel as he does. To the extent he is able to convey, through the medium of his art, his conceptions and feelings to others, I think we are warranted in considering him a skilled artist.

However, we can hardly consider him a great artist unless the thing he tries to express is great. A man might very well be able to express trivial thoughts in adequate poetry; but unless he also has noble ideas, or at least those that in some manner contribute to the wealth of the race, he could hardly be called a great poet. To be a great artist in any line, one must have something really worth while to express, and then be able to convey, through the medium of his art, this worth while something to the minds of others. This distinction will enable us to gauge and measure the real value of any art or artist.

Names and Dancing

—As stimulating more refined emotions, it does seem that the rather romantic names given to many of our hotels are a step in the right direction. The Ambassador or the Biltmore has a pleasant suggestion that is missing in Union Hotel or The Commercial House. In business, I am sure that Realtor is better than Real Estate Agent, and that Mortician is better than Undertaker. Even a name may thus subtly suggest dignity, or importance, rather than cunning, or the fact that the body will be placed below the surface of the ground.

Turning from these less powerful agents to affect the emotions to one of the most powerful, it is generally recognized that music quickly engenders a sympathetic response. People are incited to take up arms by martial music, and are led to seek salvation through the influence of revival hymns. Even the first and most primitive element of music, the rhythm, quite apart from the other two elements, melody and harmony, has a power of its own. The movements of the body tend sympathetically to follow the tempo of any musical instrument, or under emotional stimulus to create a tempo that permits the emotion to find expression.

In primitive lands the beating of the tom-tom is the signal for the swaying of bodies and the stamping of feet in unison with their throbbing. In more civilized lands others are moved to rhythmical gliding steps by the sweet, measures strains of the waltz. Then, also, without music, but making their own rhythm, some perform, mostly before audiences, intricate and beautiful movements to express, and to convey to others, a variety of emotions.

Now if we turn to experimental psychology, we find that every mental state is accompanied by an appropriate physical movement. Every thought is at least coincident with the relaxing or contracting of certain muscles in the human body. And furthermore, if a set of muscles that habitually move in a certain way as accompaniment to a given feeling or thought, are made to move in that way, there is a strong tendency for the feeling or thought to be stimulated by such movement.

Thus it is that certain movements of the human body, or parts of it, become powerful factors in stimulating thoughts and emotions of a given type. As a consequence, dancing, when the dance is chosen for its power to stimulate emotions of a desirable character, may be used as an agent for the proper development of feelings and aspirations.

Dancing not only affects the person experiencing the physical movements, but may, and often does, affect those who witness it. It is not merely something in which a great many people participate on social occasions; but as performed by artists, it enters conspicuously both on the stage and in some private gatherings, as a feature of entertainment. But whether witnessed or engaged in, through its stimulation of the emotions, it has a power either to elevate or lower the spirituality.

How are we, then, to gauge whether or not a certain type of dance should be encouraged? Should the waltz be encouraged and the black bottom ostracized? What about the acrobatic dances that one now so frequently sees on the stage? What is the spiritual effect of buck-dancing and clogs? When, as related in 2 Sam. 6:14, "David danced before the Lord with all his might," did he do a wise thing?

The answers to such questions must be based upon the emotional effect in each specific instance. The hula dance of the Hawaiians is a religious dance, and it is said that the natives who participate in it and the natives who witness it feel only devotion, thanksgiving, and a prayerfulness that blessings may come to them and their people. If this is the emotional effect upon them, to them the dance is elevating and a means of attaining spiritual values.

This same dance, to an outsider who is unsympathetic to their religion, and who sees little in beauty of movement other than a means to appease carnal desire, may arouse only selfish passion. To him, because it stimulates degrading desires, this dance is spiritually a detriment.

Does the waltz, in which there is graceful and pleasing unison of movement as an embracing couple move rhythmically over a waxed floor, stimulate tender compassion, or does it excite ungovernable lust? This depends upon the individual. Some, no doubt, have been led to gross conduct through its sweet harmonies; but others have been lifted to emotional levels far above anything carnal or sordid in life. The individual must solve the problem of its effect upon him; and the cosmic alchemist must solve the problem by studying its average effect upon the race.

That something may be beneficial to one and a detriment to another leads us to a further important consideration in reference to art. It is that through being unable to grasp the artist's thought one may experience a feeling of degradation which the artist never had. The nude figures of classical statuary excite nothing more than a feeling of shame and disgust in certain provincial folk, who see in them only a sinful representation of a naked human body. Yet one who has cultivated his emotional reactions — or as experimental psychology puts it, has trained his conditioned responses properly—gains a glow of illuminating ecstasy from the same figures. Hence the great value to the spirituality of the race of educating itself to as high an appreciation of artistic values as possible.

But to return to our dances: We have the seguidilla and the fandango from Spain, the tarantella of Italy, the Bacchanalia and sacred dances of olden times, the waltz which originated with the French peasants, the polonaise and mazurka of Poland, the tango of the Argentine, and the charleston and black bottom of America. And as synthesizing all of these, selecting what it needed from each and expressing all with a superb technique, we have the New Russian Ballet.

Each and every one of these, either from the standpoint of participant, of spectator, or as influencing society as a whole, must stand or fall by the quality of emotional response it arouses. We must not be too hasty in discarding the newer and more bizarre forms. I am willing to admit that the black bottom seems to outrage decency

and that the collegiate seems but an expression of, and a stimulation to, the wild tendencies of the crowd devoted to hip-flasks and “necking.” However, even the best of artistic things are seldom accepted at first when presented in some new form. The conditioned responses have not been established that give an appreciation of them. It takes considerable time to determine whether something new, in the long run, will stimulate high or low desires.

All the new dances are at least expressions of inventive ability. Someone had imagination and initiative enough to get out of the old rut and try something different. The names of some of the dances here mentioned will not be recognized by those who read these lines because they will have been outmoded and replaced by something newer. Ninety-nine of the inventions, no doubt, will ultimately prove worthless and go into the discard. But the one out of the hundred that is retained because of its worth will add something of value to human possessions that could never have existed if the too conservative people had their way. By all means we must discourage the gross and ugly; but we must not jump to the conclusion a thing is repulsive just because we are used to something different. Most people have an early distaste for both olives and caviar; which may be considered great delicacies by them after further gustatory education. We should never discourage the trial of something new, even though a thousand new things fail; because the human race makes progress only through new discoveries.

As markedly in contrast one with another, and seemingly equally popular at this time, we have the acrobatic dances and the classical dances. In the latter, through rhythm grace of movement and beauty of form, the myths and legends of Greece and Rome and the Orient are given interpretation. In the acrobatic dances it would seem that the speed of movement, the bendings, twistings, and sometimes even angularities, strive to give expression to the present mechanical age. The contortions often are far from beautiful, but they do express mechanical skill and accomplishment.

Because the dance affords an avenue for the expression and the arousing of the emotions, it is an encouraging sign that, more and more, instructions in it are finding their way into our public schools. The cosmic alchemist uses his influence to encourage such of these forms as develop refinement of body and more lofty sentiments.

Painting and Sculpture

—To those forms of art known as painting and sculpture we must bring the same measure and the same elements of discrimination.

Some of man's most vivid sensations are received through the eye. What he sees has the power to make him feel and make him act, due to long and constant habit. He sees a car swiftly approaching, and even before he thinks he has moved from the path of danger. He sees an apple of cheerful red, and it gives him hunger and a desire to eat it. Or he sees the pleasing face and figure of one of the opposite sex, and is beset with impulses for possession. What he sees customarily stimulates him to such thoughts as he is capable of, arouses emotions, and moves him to action.

But what he sees, if he is discerning, is not merely concrete physicality. Behind many of the combinations observed he perceives universal principles, philosophical significances, and subtle shades of meaning that are difficult to define. Turning his attention to these he finds his consciousness undergoing a sudden and happy expansion in which he is able to grasp more completely the verities of existence.

These more significant things, the things that appeal to the unconscious mind and illumine its vision, are often overlooked, however, by most of us. Then again, things that in the world of affairs are widely separated, that singly have little significance, if they can be brought together in certain combinations, stimulate thoughts and feelings, and open up the channels of the psychic senses sufficiently to enable us to apprehend stupendous facts and gain ecstatic feelings that otherwise would not enter our lives. But we have neither the time nor the ability to search out these single things, nor to bring them into the combinations that most fully expand the consciousness and make us more keenly alive to the joy and significance of living. We look to the artist to do this for us.

Lights and shadows, color and form, appeal to the eye, and through the eye may reach the soul. The artist must have the ability not merely to present something attractive as it appears in life, so that it looks natural, as does a photograph, nor is it enough that his picture tells a story. He must also be able to grasp the underlying essence, and communicate the very feel of the thing he is trying to present.

His picture of a woman is not merely a representation of some particular woman; but it conveys the impression of character that is common to all women of a certain type; or it enables the beholder intuitively to grasp the majestic glory of the essential principle of womanhood. If it is the picture of a dog, it is not just a canine likeness; it is the presentation of the principle of fidelity that pervades both dogs and certain men. Or it conveys, perhaps, the very spirit of sport if it is a sporting dog picture, so that the universal meaning of sport is borne home to the onlooker as it never had been before.

As one looks at Rodin's Thinker one sees a powerful man engrossed in deep cogitation. But the sculptor, in this figure, has grasped the power, the method, and the significance of thought, so that one's consciousness is tuned in its vibratory rates to just that level where it contacts the whole, deep thought of the race.

The limitations that are imposed by objective consciousness, in the presence of a masterpiece of sculpture or painting are thrust aside, and the unconscious mind enters into rapport with the idea embodied by the artist. And in this rapport, this

opening of the avenues to the astral plane, the faculties of the observer need not remain within the boundary of the idea of the artist; for the artist, presenting the essence of something, places the mind in communion with a sphere of thought and feeling that has its existence in the astral world, and if the observer has the capacity of comprehending more than the artist, his psychic senses reaching out in the astral world may bring him conceptions and feelings relative to this plane of thought far transcending those possible to the artist.

To get the most from a painting or sculpture one must endeavor to enter into the spirit of it. There must be not merely a critical and an intellectual comprehension of what the artist is trying to convey; but one must be able to feel its very essence and cosmic significance.

Artists are specialists who devote their lives to finding and revealing immutable principles and that which is most beautiful. Perhaps the presentation is even terrifying; but terror and stark fear also have their significance in the world in which we live. Artists enable others to enter into the consciousness of experiences that otherwise they would not have they direct the attention to the beautiful things and fine pleasures that commonly escape observation in the scrimmage of every-day living. Their sculptures and their pictures, therefore, afford an adequate stimulus for increasing the range of thought and intensifying and refining the emotions, and thus markedly enriching the life.

In the galleries of our cities are hung the paintings of the old masters. There are also the works of the impressionistic school of France, which are the outcome of a rebellion against the older technique. And through a still more recent revolution other and more bizarre forms are also to be seen. The Cubists, Vorticists, Futurists and others of the modernistic school of art intrude their works. These are not so easy, yet are worth trying to understand. Whether or not they endure, they at least are experiments in trying to find some better technique of expression. And we may be sure that whatever form becomes the more permanent it will be richer for their contributions.

Not all works of art are beneficial to the individual. He must measure their value by the kind and intensity of emotions he is able to develop from their contemplation. He may, or he may not, be able to get more from the abstract presentations of the modernistic schools, which call upon him for a vigorous use of his imagination. But his imagination must be active to get much benefit from any form of art. Nor will he be able, all at once, to gain the utmost from artistic productions. His appreciation, and therefore what he gains emotionally, depends in great measure upon a gradual education. A dog, a savage, and a cultured man do not see the same thing in a picture, nor is there much similarity in their emotional response to it.

Like everything else in life that is worth while, if he is to receive the high benefit to his spiritual nature that painting and sculpture open to him, to gain it he must put forth personal effort. As art does afford, to those who are willing to put forth some effort, unusual facilities for raising the vibratory rates and increasing the spirituality, the cosmic alchemist encourages people to take an increasing interest in it.

Chapter 9

Serial No. 172
Original Copyright 1946
Elbert Benjamine

Copyright
August 2002
Church of Light

Major Aids To Spiritual Advancement

Chapter 9

Major Aids to Spiritual Advancement

IN a vague and nebulous way, because those in our educational institutions advocate them, there is a general impression that in some manner society is benefitted by certain kinds of music, literature, dramatic art, nature interests and social affairs. And with an uncertainty that leads to recurrent controversy as to which is better and which worse, it is likewise felt that some music is degrading, that the published works of some writers are corroding, that even some poetry is not fit for the public eye, that the movies must be censored, the stage made subject to police regulations, and certain social contacts, such as the so-called night-life in our cities, should be discouraged or even prohibited by legislation. But the man in the street commonly has no means of gauging either the value or the menace of any of these things.

Consequently, because it is his work to encourage all those things beneficial to society, and to discourage all those which detract from human progress, the spiritual alchemist should furnish a yardstick by which all such things can correctly be measured.

The arts, various interests and social contacts have a value in that they contribute either to length of life or to its breadth. Most of them, in addition to furnishing variety of experiences, increase the range of information. But in addition to the facts they furnish, and of more importance to man's progress, they each also appeal to the emotions and tend to make desires of a certain type habitual. The desires thus cultivated through repeated stimulation may be coarse, brutal, degrading, selfish and directed to the gratification of the individual at the expense of the welfare of others. And in so much as this is true the production or interest is a detriment to the individual and the race, for it tends to restrict and limit life in its most important dimension. On the other hand, the desires so aroused and habitually indulged may be those seeking refinement, aspiration to higher accomplishment, those associated with noble intent and the zealous determination to make whatever sacrifice of purely selfish aims is necessary for the welfare of others and general human advancement. To the extent such desires are encouraged to become man's companions the contacts stimulating them are beneficial to the individual and the race; for they increase the dominant vibratory rate and give life height as well as length and breadth through lifting it to a higher spiritual level.

Mans actions are directed by his desires, and he desires and is attracted toward that which gives him pleasure. That he may have desires that spur him to actions that give him the experiences that enrich his life he should be encouraged to enjoy life to the utmost. But at the same time he should recognize that the most enjoyment is not to be had through those things which degrade and make gross.

One who has experienced merely the pleasures of the animal appetites has missed intense enjoyment. A dog, no doubt, enjoys his food; but the enjoyment is of a very inferior nature to that experienced by a cultured man with his favorite music. The pleasures of the drunkard, of those who dissipate, and of others who gain something for themselves through the oppression of those less vigorous, are not in the same class, but much inferior in quality to the enjoyments of those who have trained their minds and nervous systems to higher appreciations.

The more refined the organism and the more trained in its appreciations the more enjoyment it is capable of experiencing. Refined enjoyments, through making the proper desires habitual, lend themselves to the advancement of the individual and the progress of the race. In addition to their utility in directing the behavior into channels beneficial to the race, they are experiences which in themselves give breadth and height to the life of the individual undergoing them.

We should not think of seeking enjoyment as materialistic. If we conduct ourselves wisely, when we pass to the next life we there also will seek enjoyments; for in that realm as well as in this one they afford a means of directing the energies into channels that are best. If sorrow and privation come, here or hereafter, let us meet them bravely and gain spiritual values from them all through the methods of spiritual alchemy. But let us not seek misery. On the contrary, let us seek the highest enjoyments, which come only from those things which call out the tenderest and most exalted desires in behalf of others, and the flaming zeal for high accomplishment.

Music

—Of these enjoyments, and one capable of considerable quality cultivation by almost everyone, is that obtained from music. Music is good for us, or bad for us, in proportion to the elevation or degradation of the impulses which it arouses.

It has a language all its own by which it communicates to us any possible emotional state or combination. It speaks rather definitely, but not in words. Through rhythm, melody and harmony it may arouse longing, wistfulness, despair, elation, joy, happiness, sorrow, passion, lust, frenzy, hatred, greed, envy, revenge, or any other emotion of which the soul is capable. Its vibratory rates reach the astral form through the consciousness without the medium of definite images, and set up changes in the astral body much as do images of the most powerful intensity. The feelings engendered thus are such as might be aroused by any set of thoughts or by any kind of objective experiences. And because they do thus awaken such feelings, the behavior

consequent upon them is that which might equally result from intense thought or objective experience. Thus does music have a power to direct our conduct.

But a peculiar thing about music, and one that should cause us to avoid hasty judgment as to which kinds are good and which kinds are bad, is that at first hearing a type to which we are not accustomed is usually most unattractive.

Melody, undoubtedly, is the creative energy in musical production. But what constitutes melody is very difficult to define. Certain notes that when first heard seem quite unrelated sounds, when heard repeatedly come to be considered melody of exceptional beauty and power. The later developments of what was originally known as jazz, much of it, aside from its syncopation, is denounced by many as harsh and discordant. How are we to judge?

It would seem that musical productions, to prove their worth, must undergo a period of presentation. It may be that great treasures of music are sometimes discarded because the audience cannot educate itself to their true worth. It may be that Wagner's composition of late life which was discarded, although he held it to be his greatest, is better than his earlier productions. But in the long run music stands or falls through the appreciation of its public. And so far in musical history only those works have endured as great which men have come to recognize as built on melodies of power and beauty.

The music of the West has been erected on the diatonic scale of thirteen equal-value semi-tones to the octave. The East deals with smaller intervals; implying ears more delicately adjusted. Certain music from the Orient, of singularly haunting charm, makes use of intervals in which our semi-tones are divided into four parts. But these smaller divisions, giving greater freedom of melody, are sadly handicapped in another essential; they offer an obstacle to harmony. Such small intervals when they enter into a harmonic structure sound to us as though something were desperately wrong.

Because, as already mentioned, something new sounds incomprehensible or even diabolical at first, is no criterion as to its real beauty. But if on subsequent renderings it continues to sound horrible, we may be sure that people will not accept it. Some there are who have tried to use quarter tones in modern composition, and some others have attempted to found schools not on harmony, but on frankly unresolved dissonance. But these rackets, called music by their creators, have so violently distressed the nerves of their listeners who have been grounded in the traditional concepts of harmony, that they have not gained an appreciable footing.

At the same time, their originators are to be commended. Because good music has been produced only by conforming to certain rules is no indication that other and better methods may not yet be discovered. It may be that a hundred new forms will be brought to light and experimented with before something really better than we now have comes to light. But if, in the long run as the result of all this experimenting, something of real value is added to musical expression, the work of these inventors in the realm of sound will have been well worth while.

Yet so long as these new forms tend to disrupt, through their violent and prolonged clashes, the nervous poise of those hearing them, we cannot consider their effects for the better. Life depends upon harmony; and discord tends toward dissolution. Discords entering human consciousness as alleged music, through the sympathetic response of the finer body tends to arouse discords in the astral form, and these, in turn, attract misfortune in the external environment. The material success of the individual, as well as his poise and happiness, depends upon his inner harmonies.

I presume in the later adaptations of what was originally called jazz we have something that will add somewhat to the richness of musical expression. From the weird cries and crude force of its syncopations one might think such music came from the jungle. But as a matter of research, those who have sought to trace it do not find it there, but conclude that its intense, ceaseless movement is the interpretation, in musical language, of the hurry, strife and industrialization of American life. The inexhaustible rhythms and its blue notes bear the label, "Made in America."

It is really not a new music, but a new language through which old music is presented. It has been shown, for instance, that "Yes, We Have No Bananas," is note for note and in exact rhythm Handel's magnificent "Hallelujah" chorus in its opening, and that in its second part it appropriates "I Dwelt in Marble Halls," from Balfe's "Bohemian Girl" "Avalon" had to pay damages in court to Puccini as being taken from the tenor aria in the last act of "Tosca"; and many others have been shown to be but classical compositions that have been given this new dress. So while jazz and its derivatives may contribute something permanent in the way of expression, up to the present moment those using it have created almost nothing.

Without emotion life is a very thin rind. Yet music, in these days of radio, is an easy means of giving it greater depth. The most complex form that has yet evolved, and that requires greatest training fully to appreciate, is the symphony orchestra. The interweaving of contrapuntal threads, the richness and variety of tone and coloring, and the interrelation of rhythms give it a liberty that nowhere else can find expression. In fact, its creations are limited not by its technical requirements, but by the receptivity and discriminatory powers of the human ear.

Like almost anything else really worth while in life, the ability to appreciate good music, and thus through it elevate the emotions to sublime heights, requires training and effort. Being in its presence, listening to it, and endeavoring to feel its meaning, is an avenue to this training. And he who can enter completely into the enjoyment of a symphony orchestra always feels well repaid in pleasure alone for whatever effort such appreciation has cost.

Most people, however, find the symphony too heavy except for an occasional addition to the musical diet. But on the screen and stage and over the radio a wide variety of really good music is now easily available; and it is a healthy sign, just at the moment this is being written, to find the public demanding less and less of the so-called "swing", and more and more of what are considered to be better productions. Grand opera, vocal solo work, and instrumental recitals seem to be

gaining new life. These types of music are mostly good in that they stimulate a desire for unselfish work, pity for those in misfortune, and such other feelings as are not antagonistic to race welfare.

Some of the derivatives of jazz, on the contrary, in their wild shrieks and maudlin whinings give rise to the impulse to abandon all self-control; to such lack of restraint and dignity as may be commonly witnessed only in those drunk. To shout and laugh and have a hilarious time is a detriment to no one; but to be drunk with wine or with emotion to an extent that neglects any thought of the effect of actions on oneself or on others is certainly most detrimental. And there are other forms of undesirable music that stimulate lust and base desires; forms that invite man to selfish gratification at the cost of pain to others, or that degrade and lower him to thoughts and feelings that are coarse and brutal.

Such music as expresses, and therefore stimulates, hate, blood lust, frenzy, fury, rage, licentiousness, self-abandonment and other anti-social emotions should be shunned by those aspiring to spirituality. Consequently, the cosmic alchemist uses such influence as he has to create a popular demand for the types of music that lift the soul of man above these sordid emotions, any one of which lowers the dominant vibratory rate and hence the spirituality.

Drama and Fiction

—With a radio in nearly every home, and twenty million people in this country attending the movies every day, where music also commonly is heard, music must have a profound influence upon the spiritual trend of our people. And as their emotions are so repeatedly played upon by the heroes and villains of screen, stage and radio, the drama also must be given a place of importance in determining the popular emotional trend.

With these so numerous avenues of entertainment at hand that require almost no effort to enjoy, it is impossible to determine to what extent the realm of literature is being also used for relaxation and entertainment and is consequently influencing the general emotional level. But as publishers still report a high sale of novels, and the newsstands are prospering from their sale of magazines, we may conclude that the printed page, while not having so unrivaled an influence as it once had, is still of arresting importance.

Through music and dancing the emotions are played upon directly in such a way as to stimulate aspirations and desires and perhaps suggest images and events that take place in time. In sculpture and painting some great moment, or conception, or feeling, or the outcome of something that has taken place in time, is fixed and made permanent. But fiction, whether presented in print as a story, or over the radio or on the screen or stage as a play, presents the images of actors or the sound of their voices together with events rather than merely suggesting them as music does; and it has a greater freedom than sculpture and painting in that it presents them during the passage of time. It thus much more closely resembles the experience of actual life.

The play and the story are very much the same thing except that each is presented in a medium that has its own technical restrictions. In the printed page, for instance, the author by means of words must be able to persuade his reader to see the images of people doing certain things amid certain surroundings. Not only must he be skillful to convey just the images he wishes to his reader; but at best it places more burden of work upon the reader to imagine the various people, settings and actions described than it does actually to see them as presented to him from stage or screen, or to hear them talk to the accompaniment of suggestive sound effects.

On the other hand, a stage or screen presentation is greatly limited as to the number of scenes and the amount of detail that can be given, because the whole action of the story must be compressed within a few hours at most. And an even greater restriction to the stage or screen play is that no analysis of the motives is possible during the interchanges; and no explanation as to the bearing of a scene just witnessed in relation to the main plot can be made. In radio presentations explanations can be made of thoughts, motives, or anything else that otherwise is not clear, after the manner of the printed story; but it is even more limited than stage or screen in the amount of time into which the whole must be compressed. Thus there is time only for the briefest of explanations. Yet the author of a story commonly goes thoroughly into the thoughts of at least his main character, and is careful after each scene to explain just what bearing it has on the development of the plot as a whole.

Other than these natural restrictions imposed on each form of presentation, the story and the play are handled in much the same manner, and their effect upon the public is not diverse enough to call for entirely separate discussion.

Other than the forms mentioned, the realm of literature holds serious books that are non-fiction in character. In the magazines are to be found articles, and on the screen are presented travelogues and educational themes that frankly and openly are informative in character. In so far as the information they present is reliable they are to be encouraged; because man cannot acquire too much information. But even such serious material often is so artistically clothed and beautifully handled as to lend it a grace and charm that results in emotional pleasure. And in so much as it does this, through calling up delightful images and pleasantly stimulating the imagination, these works by means of the emotional impressions they engender, add a richness to life that may become a spiritual asset. In addition to their power of intellectual instruction they educate to finer feelings as well.

Novels differ from short stories—and both are often given screen and radio presentation—in that the novel commonly goes into the enterprises of various characters, while the short story, to be typical, is concerned with the attempt of some central character to accomplish something, or at some critical point to make an important decision. The serial is a long short story with the installments ending in a suggestion that something menacing and sinister is about to happen. In the novelette two groups are commonly involved, often contending for the same prize. And it is usually handled by the cut and flash method in which the thoughts and actions of each group are alternately presented. The novelette, as well as the novel, affords room to show the development of character.

But whether a story is unified by the effort of one character to accomplish something or to make a decision of importance, or whether, as in most novels the minute details that contribute to the development of character amid certain surroundings are set forth, editors, reflecting the demands of the public, are more and more exacting in that all descriptions of places and typical conditions shall be accurate. If the story is laid in New York, the author must be familiar with, and picture to the reader, New York as it actually exists. If the plot takes the hero into South American jungles, the author must be able to give the reader an authentic conception of just such a jungle. Even the swift-action pulp magazines, in which the characters are permitted to do quite miraculous things, have a present-day requirement that descriptions of places shall be true to fact. And thus, the reading of almost any current fiction has commendable informative value.

We must not overlook, however, that the reading of fiction and the movie and radio habit sometimes become a vice. While absorbed in them we escape from the world of reality. We live in an imaginary world in which the duties and cares of external life are, for the time being, forgotten and neglected. The living in fantasy removes us, while it lasts, from the harsh contacts of daily existence, and thus affords our jaded nerves the opportunity for a more harmonious adjustment. As a temporary surcease from the impacts of external environment, therefore, such recreation is highly beneficial; for it conduces to higher efficiency in the real work of life.

But if, instead of using such avenues merely as temporary relief from conditions that have become too hard, the individual permits himself to form the habit of fleeing from reality in order permanently to avoid its harshness, he is on a road that is of benefit neither to himself nor to society.

To make a success of life on any plane it is essential that the problems of that plane be courageously faced and the energies concentrated upon them. Consequently, to persist in living in an imaginary world such as is created by movies and the radio and books of fiction, to the neglect of the practical, though more harsh, affairs of life, is to hinder adaptation to the real environment and thus encourage and hasten dissolution.

One can narcotize oneself into inability to cope with the real problems of life in many ways. I have known people so to saturate themselves with nicotine from cigarettes that it became too much effort to meet the common responsibilities of providing a livelihood. I have known others to get so much satisfaction from their radio that they worked as little as possible and spent day after day for weeks, in which they could have accomplished something worth while, merely dreamily listening to it. And so it is with the fiction of the printed page or on the screen; if substituted for the effort that should be used in accomplishment it destroys initiative and is decidedly pernicious. Yet as a relaxation that permits greater effort later toward accomplishing something really worth while, it may prove of high value; particularly when it is selected with a view to the higher culture of the emotional nature.

I have already spoken of the swift-action stories of the pulp magazines; and how the things that the chief characters do in these stories are often quite impossible and at other times highly improbable. Here in the interest of imaginative pleasure the mind is called upon to visualize situations that a little analysis would cause it completely to reject. Yet if the mind accustoms itself to accept without question these unplausible feats, it is cultivating a habit of uncritical acceptance that probably will be carried over into the more practical affairs of life.

When some bizarre creature—a mouse, a cat, a rabbit or a dog—in an animated screen cartoon leaps from mountain peak to mountain peak, rides a whale across the ocean, and clubs some farmer into insensibility, this may be very entertaining; but unless the critical faculties at once assert themselves in a protest at the impossibility of such behavior, in a day or two one may find oneself listening with growing conviction to another fairy story told by a real estate agent who is determined to get one's name on the dotted line.

If we do not carefully discriminate in all our fiction between what is plausible and what is not, it also becomes increasingly difficult for us to discern the subtle fictions that tend to pass for truth in our daily papers and magazines. Most periodicals that are not devoted entirely to fiction desire to exert a political influence in a given direction. Often they owe their very existence to the power they possess to create public sentiment favorable to some financial clique. But if we do not dull our powers of discernment by accepting unplausible fiction of other kinds, it usually is not too difficult to perceive just what ends such subversive propagandists seek, and to recognize the cunning manner in which each scrap of important news, each noteworthy current event, each factual article, and each story published is given ever so slight a twist to make it apparently prove their contention or suggest the advisability of that which most they favor.

For the most part, the fiction published in the slick-paper magazines has credibility in detail, is presented in a polished style, and contains considerable in the way of analysis of feeling, thought and motive; while the prime requisites of the pulp magazines are excitement and violent action.

Even in magazine reading, therefore, it will be seen that there is a difference in appeals to the emotional palate. Those less sensitive get no satisfactory taste unless there is constant physical clash, just as there are those who must cover their food with strong condiments in order to enjoy it. Their taste is so blunt that finer savors entirely escape their notice. And in reading, likewise, the subtle movements of the story, the delicate analyses of emotion, the humanness of the motives, and the portrayals of traits that should be recognized as possessed by their acquaintances, are missed by them. Yet by cultivating their tastes to an appreciation of these less obvious literary elements their enjoyment in reading would be greatly increased.

Certain Types of Fiction

—We are, and should be, anxious to learn as much as possible about life about the way people live in the different social strata, and about the conditions that exist in parts of the world either physically or socially far removed. One claim to our interest, therefore, is made by an author who presents to us something that is unusual.

It is even good for us to know, through stories and screen and radio portrayals, what the thoughts, feelings, outlook and circumstances are of those who choose the less desirable paths of life. And it is good for us to learn what there is to be known about certain diseases; but if we are wise we shall avoid either too much physical contact with, or too much thinking about, any disease. Diseases, both physical and social, have a way of spreading themselves through intimacy.

It is well to see one or two pictures of the wild night life of the city, to become informed on such conditions as they actually exist; but to steep oneself in stories dealing with it, or night after night to witness such carousels on the screen or hear them over the radio, breeds a familiarity that through its suggestive power tends to encourage an attitude of too great tolerance.

Also, we need to know the facts about gang warfare, about bootleggers, about smuggling rings bandits and robbers. Of course, in the interest of public morals these anti-social characters, after a long period of success, are made to come to a bad end. But with the magazines, the screen and the radio so constantly filled with characters who defy the law, and at least for a time lead a glorious life of excitement and opulence, such malefactors in actual life are beginning, more and more, to be taken for granted; and such conditions, more and more, are being accepted as less deplorable than formerly was thought.

This type of story, in which the chief actor is a villain, and finally meets just retribution, is the least desirable of them all. Of course he receives his final punishment. And it may be that his mal-treatment of less powerful figures in the story calls out a commendable pity for them. Such pity, arousing the desire to defend the weak and minister to those in distress, has much spiritual value. But in such a story as we are considering—which is typical of the gangland setting—the interest centers chiefly in an undesirable character. The emotional response, therefore, if the story is

successful—aside from admiration for such unselfish tendencies as the gangster exhibits—is that of ardently hoping, wishing and desiring that he shall meet destruction. And while, in the interest of self-preservation or the preservation of others, destruction at times may be necessary, the emotions accompanying it, or the desire to injure another, or to see another meet punishment or suffer, are coarse, gross and disruptive.

As cosmic alchemists then, let us recognize that such stories as arouse the feeling of hate, anger, lust, resentment, desire for vengeance or the downfall and destruction of another, lower the dominant vibratory rate and detract from the spirituality, as do those also which too frequently bring people into intimate contact with the debasing side of life. I am not suggesting censorship; as censorship too frequently suppresses that which is most worth while in the interest of narrow conventions. But I am suggesting that the better class of stories should receive as much encouragement as possible.

Of course, even in the more desirable stories, there is often a villain that the reader or audience is called upon to hate. Because the progress of life throughout has been so dependent upon the successful repulse of invasion, it is very easy to arouse the emotion of hate. Politicians constantly make use of this tendency. They know if they can find some flaw in their opponent it will be very easy, through attacking this, to persuade others to join with them in throwing mud. And thus it is also that the writers of stories, realizing how easy it is to get people excited by pointing out something to hate, quite commonly add to the interest of their presentation by portraying some character that everyone is keen to have destroyed.

In some of the very best stories none of the characters is either very good or very bad, but all are just human beings subject to the pressure of circumstances. In the better type of stories, even though there is a villain, the desire for frustration or destruction of anyone plays a very subordinate part. Instead, in the accomplishment story the desire aroused chiefly is that certain individuals shall gain a well-merited reward; and in the story of decision that such decisions as are made shall conform to a high and unselfish standard of conduct.

An author, to the extent he is a competent artist, perceives certain beauties, certain things of significance, certain glorious conceptions, that others, absorbed in their daily pursuits, miss. These he points out to us, and gives to what was commonplace a new allure and an enhanced emotional association. When we have read of a certain place, or of a certain type of person as portrayed by a skilled writer, and then in the course of time we visit the place, or some other place that suggests it, or when we see someone who resembles the type thus encountered in fiction, there is an added charm and a pleasant thrill that we should have missed but for our reading.

For lack of space I cannot discuss in detail the ecstatic pleasures to be gleaned from poetry, or even from the better class of fiction. But if the emotions thus stimulated are expansive, tending to move away from self-centeredness; if they increase the desire to benefit others, to rise above the sordid and spread the spiritual wings, so to speak;

if the feelings and desires thus cultivated are elevating and noble; we may be sure that the life has not only been broadened, but that it also has been heightened through the increase of the dominant vibratory rate. Through literature, through stage and screen, and through the radio it is possible to make more habitual those emotional states which increase the spirituality. The cosmic alchemist, consequently, encourages such vibratory rate lifting productions.

Social Contacts

—Through social contacts also there is opportunity to raise the vibratory rates. Of course, when the tide of conversation turns to gossip, when envy is engendered because another has more wealth or prestige or receives more favors, the results derived from social gatherings are detrimental. After all, it is so much easier to tear down—and in the process lower the dominant vibratory rate—than to build. It is so much easier to criticize those who receive unusual notice than it is to do something constructive. Inwardly dissatisfied with themselves, there are those who find little good in anyone; and because their temperament runs thus they criticize the government no matter what it does, find fault with their families on little or no pretext, and always can think of something derogatory to say about those who are looked upon as having attained some measure of success.

Yet to listen sympathetically to such expressions of envy, to become intrigued by the reputed misdeeds of others, or habitually to scan with interest such gossip as appears in the daily papers, is to cultivate emotions that are coarsening in nature and lower the spirituality.

Nevertheless, social gatherings in which there is a pleasant exchange of ideas afford opportunity for elevating emotional culture. It is true that the mere exchange of commonplaces gives rise to few emotional responses. But conversation may take place on almost any vibratory level, and when the discussion has to do with something worth while the impact of thought upon thought awakens new realizations. Viewed from many angles, and with additional information contributed first by one and then by another, there comes to be a clearer comprehension of the subject. This broadens the life. But also often in association with such a satisfactory intellectual exchange there is a peculiar and high emotional Hush that has a keen though subtle flavor. Even the silent company of those with whom there is complete sympathy and understanding holds an element of fine enjoyment. And thus our various social contacts, if chosen with discrimination, may be made to yield intense pleasures that lift the emotional level and therefore contribute to the spirituality.

Nature Communion

—Yet above all other external contacts for refining the body, thoughts and feelings, and stimulating the most spiritual emotions, to one who can develop such an appreciation, is the intimate association with Nature out-of-doors. Sunrise on the desert, or sunset seen from some majestic mountain peak, gives to the Nature lover an unspeakable joy. That intimate friendship with flowers, with birds, with the little rodents that can be coaxed to eat from one's hand, is an avenue by which the ecstatic rapture of cosmic consciousness may rapidly be attained. Yet it is appalling how many people know almost nothing of the lives of creatures other than men.

I have deliberately curtailed to a minimum the space here devoted to this subject, because it is one about which I realize I am apt to be over enthusiastic. In addition to my occult pursuits, in the section where I reside I also am recognized as a naturalist.

As an avocation, in addition to lecturing and giving radio talks on wild life, over a period of seventeen years I led one or two field trips each month for clubs and societies interested in Nature study; a program interrupted by the approach of World War II. I know the birds both by sight and song, can call the trees and plants by their first names, and when we walk afield have at least a speaking acquaintance with such lower orders of life as we meet. At ebb tide the creatures that crowd the tide pools are my acquaintances. And even as I learn the habits and receive the confidences of my human companions, so also I like to know the habits and problems of my non-human friends of field, of forest, of seashore, and of the mountain. But if this were merely an intellectual pursuit it would do no more than add breadth to my life. Yet, incomprehensible as it no doubt appears to many of those who have accompanied me on these jaunts into the desert, into the mountains, along the streams, or by the seashore, I feel, and enter into a sympathetic relationship with, the lives of the creatures thus contacted.

This avenue of giving both breadth and height to the life I must discuss from the personal standpoint, because it is an avenue less widely recognized than those previously mentioned. Yet it is the avenue which, as I followed the streams, made intimate friends of the trees, talked to the birds, and entered into the very soul and consciousness of all the denizens of the wild, as a boy led me into the paths of occultism. True friendship is rich in vibratory-raising emotions. It engenders the desire to benefit all and to harm none. An understanding is established. And this understanding friendship with creatures and plants in their native state that came to me as I walked through woods and field as a boy brought me to whatever insight I have of Nature's forces and occult laws.

Because of the personal bias I should be sure to exhibit were I to discuss more extensively the value of actual contacts with Nature out-of-doors, I shall not express fully my enthusiasm for it. After all, what the artist attempts to present to the attention of others is something pleasing, inspiring, or notable that he has discovered. And the

Nature lover, while finding pleasure in the works of the artist, gets even greater joy in making interesting discoveries and reveling in them at first hand.

Each flower has a message for the Nature lover. The birds, the bees, the katydids and crickets, each are conscious entities with which he communes. The lightning and the storm and the waving tree tops exalt him as manifestations of power, the rugged mountain peaks offer him a friendly challenge, and the warm rains of summer enfold him in a soft embrace. Feeling thus, no ignoble or sordid thought can reach his mind, his soul is elevated to the highest, he enters into true cosmic consciousness, and reaps a rich reward of spiritual treasure.

Prayer and Devotional Exercises

—The mind of one person is not insulated from the minds of other persons or from the minds of other life-forms by some impervious wall. No more than the individual thought-cells and thought structures within the soul are walled off from each other. Each has a separate organization, and therefore a separate identity; but each also is capable of exchanges with others through the principle of resonance and the Law of Association.

While your mind contains innumerable thought-cell structures, each under the Law of Association capable of communicating its state of consciousness to any others, all are, or should be under the guidance of the over-all authority which is you. The organism as a whole has a purpose. And all the various factors which enter into the organism should, irrespective of their individual desires, cooperate in realizing the objectives you have set for yourself.

Thus also should we, to the best of our intelligence and ability, cooperate with other souls in assisting to realize the purpose of the over-all cosmic authority which we speak of as Deity.

Each ego, or spirit, is a spark, or emanation from Deity, and has the potential of developing and exercising deific powers. And each soul is a cell of consciousness within the universal consciousness, capable of extending itself to partake of the thoughts and feelings not only of other souls and groups but in some measure, and on the vibratory level to which its aspirations raise it, of the all-pervading intelligence and power of Deity.

Before a prayer is offered there should be clearly formulated in the mind that the soul is one with the universe, that the spirit is an emanation of Deity, just what it is that the prayer is expected to accomplish, and why the all-pervading intelligence and power of Deity should grant the prayer.

A worthy prayer, one that can be expected to contact the all-pervading intelligence and power of Deity on a benevolent level, not only must not be to gain some unfair advantage or to injure some other person, but must have within it elements the realization of which will in some measure also aid in the realization of God's Great Plan.

A prayer should not only be linked up with the intention of cooperating in the divine scheme of things, but its purpose should be clear. One of the most effective means of raising the dominant vibratory rate and thus increasing the spirituality is through prayer and devotional exercises. If this is the purpose, it should be clearly formulated in the mind before the prayer is commenced, and the effort made during it, or during any devotional exercise employed for this purpose, to arouse strong emotions and lift them to as high a level as possible. A prayer of thanksgiving should express thanks. A prayer for health should clearly state that health is desired. A prayer for character development should make this purpose unequivocal. All should be stated explicitly and with positiveness, and nothing in the prayer should be ambiguous.

Before the prayer is offered it is well for the devotee to contemplate his relation to the universe and to Deity.

The recognition that his spirit is an emanation from Deity will lend him a confidence and an inner power that otherwise he may fail to attain.

And the recognition that his soul is not some isolated unit, but is in rapport with the soul of the universe, and is cooperating with it for a common purpose—a grand purpose which in some small measure will be furthered by the realization of the purpose of the prayer—will aid in gaining for the realization of the prayer the cooperation of any inner-plane intelligences that may be contacted. And it will aid the devotee, through the Law of Association, to contact the all-pervading power and intelligence of Deity on which he relies to bring the prayer's fulfillment.

To get the relation clearly established it may be well for the devotee after withdrawing his consciousness from consideration of external things—withdrawing his consciousness to the inner plane to the extent he has ability to do so—to repeat earnestly a few times: My Soul is one with the universe my Spirit an emanation from Deity."

When he feels this relationship has been firmly established in his consciousness, he is then ready to make more specific contact and appeal to Deity. If he is a Church of Light member he does this by starting his prayer thus: "O Thou Eternal Spirit, in Whom I Live, Move, Breathe and have my Being!" The mind should be lifted at this point in aspiration and devotion as high as possible. It is not thought, but the emotion which accompanies it, which is able to lift the soul to high basic vibratory levels and there contact the all-pervading intelligence and power of Deity.

This high level of feeling should be maintained throughout the offering of the selected prayer. The prayer may be offered either silently or audibly, but it should have earnestness, positiveness and emotional energy behind it. It may be offered

only once, or it may be repeated as many times as desired. A good plan is to set aside several short intervals daily for employing the same prayer. Asking for too many things at one time, or changing the prayer from day to day to different purposes, divides the mental energies necessary to make proper contact and gain realization. And one prayer backed by earnest devotion and powerful aspirations is far more potent than giving mere lip service to some prayer daily for a year.

Even as the salutation to Deity with which the prayer begins will vary according to the religion in which the devotee believes, so the ending of the prayer also will be different. Instead of "Amen," those of The Religion of the Stars find it preferable, due to the operation of the Law of Association and because a more positive effect is acquired, to close the prayer with the affirmation, "So Shall It Be!"

Book 18

Copyright
August 2002
Church of Light

Imponderable Forces

Chapter 1

Serial No. 183
Original Copyright 1945
Elbert Benjamine

Copyright
August 2002
Church of Light

How to Act Under Adverse Progressed Aspects

Chapter 1

How to Act Under Adverse Progressed Aspects

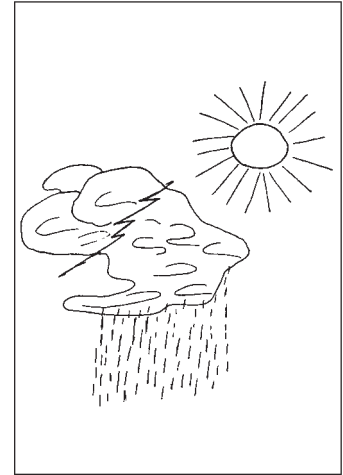

By imponderable forces I refer to all those energies recognized by occult science which as yet have not been investigated by the leading authorities of material science. The objects of our environment, for instance, radiate an energy which has an influence upon our lives. The thoughts of living people impinge upon our consciousness. Under certain circumstances those who have passed to the next life can contact us. Aside from their thoughts, the actions of people have a suggestive force. The press commonly shades the news it reports in such a manner as to enlist our sympathies with its views. Religious and other rituals come to our attention. Astrological energies stimulate our thoughts and actions. And there is the whole subject of ceremonial magic. All these influences, which though imponderable, may nevertheless exert an influence upon human life, are embraced by our subject.

Superstition

—Some people would say a belief that any of the things mentioned has an influence in our lives is pure superstition. Yet my object in here discussing them is, in as far as possible, to banish superstition.

Superstition, according to Webster's New International Dictionary, is, "An excessive reverence for, or fear of, that which is unknown or mysterious; hence the attitude of mind of a person or persons whose beliefs are regarded as false and as leading to idle or foolish practices; especially a religious belief regarded as irrational and misleading."

Now it is true that so long as an effect is observed to be produced by an unknown force, and so long as something is shrouded in mystery, there is apt to be excessive reverence and fear. Therefore the best way to remove that excessive reverence and fear is not to deny the effect, which people actually see for themselves is produced, but to find out just how it is produced.

If the energy actually is inimical to human welfare, or to the welfare of some individual, denying its existence will not prevent its operation. But whenever it is fully understood and is no longer wrapped in mystery, a means can be devised to render it harmless. Thus superstition is not banished by ignoring a situation. But by a full understanding of a situation it may be shown harmless and unworthy of fear; or if really inimical, a means can be devised to counteract it and make it no longer something which excites fear.

So in this Course I shall delve into all sorts of peculiar corners of existence, and shall even explain the principles of such forbidden things as sorcery, necromancy, black magic, and witchcraft. Not to induce fear, but to banish all fear of them. When they are really understood, they perhaps cannot be denied, but, because understanding them makes them harmless, at least they will no longer be revered or feared.

People are not superstitious because they believe in these things, but because they have an irrational dread of them. And even about things that do not specially excite horror, I find that numerous people are very superstitious; for they greatly exaggerate the influence certain things exert.

The most powerful of all imponderable forces to influence our lives are our own thoughts. But because in other Courses I have discussed their use and influence in great detail, here I shall consider them only in so far as may be necessary to understand the operation of other energies.

Next to our own thoughts in their ability to influence our lives, and therefore the first imponderable force here to be considered, I believe astrological influences are the most powerful. And although there are seven different Brotherhood of Light Courses devoted to these influences, I find the present Course would be incomplete without one lesson devoted to their discussion. Especially is this true because, although they have a very real power, they are the objects of so much superstition.

The very first contact a person makes with astrology may be through a birthday reading. Now the zodiacal sign in which the Sun was located at birth usually impresses its quality upon the individual; but this is a single one of many positions which must be considered to give even a character reading. Without looking in an ephemeris for the year, the birthday denotes only the sign and degree of the zodiac the Sun was in at birth. And while the aspects made by the transiting planets to the place of the Sun, thus located, are not without some effect, they certainly are not of sufficient consequence to form the basis of a reading of what is going to happen to the individual during the year.

As there are some 1,800,000,000 people in the world, a "horoscope" based merely upon the month of birth is equally applicable to about 150,000,000 persons. And a "horoscope" for the year based merely upon the day of the month of birth, such as the printed day by day readings issued in vast quantities, and the birthday information published in some of the daily papers, is equally applicable to some 5,000,000 other persons in the world. One certainly wants something more individualized and specific as a guide to his endeavors.

The Daily Aspectarian

—In the ephemeris, and in other publications, all the aspects that occur between the planets for each day are listed. After these aspects are usually to be found symbols or words denoting whether the aspect, and therefore the day, is good or bad.

Now I have known people so superstitious—using the word as indicating an exaggerated fear or reverence—that they will hardly stir out of the house on any day thus indicated to be unfortunate. Yet we must consider that all the eighteen-hundred million people in the world are subject to every aspect thus shown. Surely, all these people do not suffer misfortune on such days, as they go about their daily occupations.

Exceptionally heavy afflictions thus shown, and exceptionally heavy benefic aspects, it is true, are reflected by world conditions. But even the affairs of nations, and the current events that are of importance enough to be given prominent headlines in the daily papers, require more specific information than can be gained from the aspects as shown in the ephemeris. That is, to make accurate predictions from day to day as to what events of importance will happen in a country or city, a horoscope erected for a specific hour and minute of a given day at a definite longitude and latitude is necessary.

Except for some quite extraordinary aspects, such as occur at intervals of many years, any specific predictions as to what will happen at any given place on a given day requires either a cycle chart erected for the place, or the horoscope of the place; and it is better to have both.

Because there is a severe affliction to Mars on a given day, as shown in the ephemeris, it is quite likely that if a census of the world could be taken that it would show more than the average number of accidents. But if you expect to verify predictions of this kind by newspaper headlines, you will be disappointed. We have tested out such influences very thoroughly in our research department. They are so general in character as to produce no results that are pronounced enough and reliable enough to warrant making predictions. And if the tendency to accident on such a day is so unreliable as to make predictions unwarranted, it seems to me that to permit such an aspect to deter one from going about one's daily affairs is an exhibition of superstition.

However, if you will erect a Mars Cycle chart for the place where you reside, you will find when Mars moves to a strong aspect to any planet in an angle in this chart that you can predict events of the nature of Mars as affecting the things indicated by the house of the chart occupied by the aspected planet, and that this prediction can later be verified. In our weekly evening Mundane astrology class we make predictions for

each day of the week for a week in advance. And for a score of years such predictions have been fully verified. And if you will watch the reports in the daily papers on those days when Mars makes aspects to the planets as they appear in the Mars Cycle chart, you will perceive that every strong aspect that Mars thus makes is coincident with noticeable fires, accidents and violence.

So if you were to guide your daily affairs by aspects so general in nature that they affect the world, the country, or even the city where you reside, as a whole, it would be much better to refer to the aspects in these Cycle charts, because these aspects are reliable enough in the effect they produce on groups of people that you may be sure some of the group is going to be influenced in a very definite way.

I am not trying to disparage the use of the aspectarian in the ephemeris. Instead, I am pointing out that many people try to make it do something which is not its true function. They try to make the daily aspectarian do work that is the specific function of a personal chart.

Now, on the other hand, when you commence some definite venture, or even take the initiative, such as going to a tradesman for a purchase, or set the time for an interview; because this is the birth of the thing at hand, so to speak, the aspects as shown in the ephemeris become important. You can prove this by erecting the charts for the commencement of a large series of ventures, and noting how their success or failure compares with the aspects ruling the ventures in these charts.

In view of actual results that have followed starting ventures when the planets favored them, as contrasted with the failures shown when ventures were started under adverse aspects, you are fully warranted in choosing a time when the planetary positions favor it to start any venture of importance. Furthermore, if you will check up on your successes and failures in interviews, you will find that it is quite worth while to have the planets, as shown in the aspectarian, favoring you when you have such an appointment, and also, when possible, to have the interview fall in a planetary hour favorable to the issue as you desire it.

If you are compelled to take issue with another, it is to your advantage to go to him while there is a good aspect applying to Mars. If you would make a sale, do not overlook the aspects to Jupiter. And if you would buy a bargain, see to it that Saturn has a strong and favorable aspect on that day. Even these aspects, however, are quite subordinate to the Major and Minor progressed aspects in your birth-chart. But they have value enough to warrant you taking the trouble to notice them. They give the best conditions that are obtainable under your heavier personal progressed aspects.

But for all things that are already commenced, and in the conduct of the everyday affairs of life in which no new thing is started and no especial initiative is used, I believe paying much attention to the aspects as they appear in the daily aspectarian is a waste of time that should be devoted to things more specific to your own chart. That is, other than in such ways as I have signified, your attention should be given to the influences that come specifically to you, rather than such general and vague conditions as are shown in the ephemeris. And to have fear merely because the daily ephemeris shows heavy evil aspects is to exaggerate their importance far beyond what experience shows to be their real power.

Your own observation will quickly convince you, if you watch the affairs of others, that some people have very good luck and other people have very bad luck, in practically every department of life during every day of the year. But you also probably have discovered that during certain periods all the “breaks” are in your favor, and that during other periods all the “breaks” are against you. And there are still other times when success comes almost without effort in one department of your life, yet in spite of all your efforts there is loss or failure at the same time in some other department.

This is because you are a unique individual, the thought-cells of whose finer body is acted upon by the rays from the planets in a way different than they act upon the thought-cells of any other person in the world just at the same time. How the world is affected by planetary rays can be discerned only from a world chart. And how any particular individual is acted upon by planetary energies, as a distinct member of a larger group, can be determined only by comparing a map of his astral body with a map of subsequent planetary positions. That is, to determine how planetary energies will affect one individual differently than other individuals, we must possess his birth-chart.

To be specific, there are three distinct types of astrological influences operative in every person’s life, each of which is of more importance to him than the various aspects shown in the aspectarian of the current ephemeris. They are: 1. Major progressed aspects. 2. Minor progressed aspects. 3. Transit aspects. Each of these three as calculated specifically in relation to himself, which means, in relation to his own timed chart of birth.

Rely on Major Progressed Aspects

—Of these three types of influence, I believe that commonly only the major progressed aspects are of sufficient power to determine whether or not an individual is warranted in entering upon some important undertaking. Both minor progressed aspects and transit aspects are sufficiently important to receive consideration; but the broad outlines of one’s endeavors, I believe, should always be determined by a thorough consideration of the birth-chart in relation to the major progressed aspects operating at a given time.

I consider that any individual can only live to his maximum when he has studied his birth-chart sufficiently to know in what departments of life he may expect difficulties and in what departments he may expect favors; and then at all times keeps apprised of just what major progressed aspects are delivering planetary energy to him. With this information at hand, and properly assimilated, he is in a position to weigh accurately the possibilities of every apparent opportunity or apparent obstacle that comes to him.

But certainly this does not mean that because he is under adverse progressed aspects he should cease effort, have fear, or fail to take hold of ventures that promise success. If the aspects in the birth-chart are harmonious, he may be able to make a success of a venture in spite of progressed afflictions.

If a man is a good mountain climber, he may be able to reach the top of the mountain in spite of a snowstorm. The same snowstorm would probably make it impossible for a weaker climber to reach the top. If the weaker man knew he would be caught in a snowstorm, he no doubt would avoid disaster by not attempting the climb. Yet the stronger man might set out in spite of knowing he would encounter a snowstorm. But it certainly would be to his advantage, because it would enable him to prepare for it, to know that he would have to fight his way through the snow.

Now I submit that neither the stronger nor the weaker man could prevent the snowstorm arriving on its destined day. Nor can we, no matter how strong, prevent the arrival of those astral discords shown by inharmonious progressed aspects. But in either case we can estimate our strength to overcome such a storm, and whether or not it is wiser to try to push through it, to await a more favorable time, or to abandon the venture entirely.

Yet when I speak of strength, I speak not of physical courage and mental ability, but of the harmony and power of the thought-cells of the astral body, as shown by the birth-chart.

Of this you may be sure, that as the heavier major progressed aspects form in your chart, some of the things signified by the departments of life mapped by the houses occupied by the aspecting planets will be brought prominently into your life. Some of the things thus brought will be optional with you whether or not you will accept them. Concerning other things, such as the loss of acquaintances through death, you will have no option.

Most Events Are Optional

—Of the optional matters—such as whether or not you will go into some business, whether or not you will accept some position of importance, whether or not you will remove your home, marry, take a trip, form a friendship, or what not—your decision should be guided not merely by the progressed aspects operative, but by a careful consideration of these in relation to the harmony or discord shown governing the matter at hand in the birth-chart, and in relation to past conditioning and present environment.

Just what can, and just what cannot, be done under any given set of progressed aspects is a subject of Brotherhood of Light Astrological Research, based upon what people have been able to do, and what people have failed to accomplish, under different charts and different progressed aspects. I believe from a careful analysis of the various progressed aspects operative at any particular time, and of the background and past conditioning and present environment, in comparison with the possibilities shown in the birth-chart, it is possible to determine in advance whether an individual can, or cannot, make a success of a venture then entered into.

Furthermore, such an analysis will indicate how great are the obstacles that must be overcome, and how severe the opposition. In regard to the important developments of life, we are perfectly warranted in being guided in our decisions as to acceptance or rejection, and in our various undertakings, chiefly by the birth-chart as modified by major progressed aspects. Minor progressed aspects and transit aspects have quite discernible influence, and are of great importance as influencing the details within the larger trends which are indicated by the major progressed aspects.

Even in those things in which choice seems to be curtailed, it is as foolish to consider astrological influences in terms of compulsion as it is to think of the weather in terms of compulsion. It is true, of course, that there are things we can do successfully only when the weather is clear and fine. Yet most of us find other things that are well worth doing even when the weather is most inclement.

If you wish to photograph landscape, a rainstorm may make this impossible. But if you knew this rainstorm was approaching, and just when it would arrive, you would not try to take out-of-door pictures at that time. Instead, you would have arranged your affairs so that you could take pictures indoors by artificial light, or you would turn your attention during the stormy weather to something other than picture taking.

Of course, if instead of a severe storm, you had discerned that the day would only be somewhat cloudy, you might have prepared to take the pictures anyway. You could have given a longer exposure, and otherwise taken additional pains. So also if the progressed aspect storm was comparatively mild you might have put forth the effort to overcome whatever obstacles it held. But if the storm was severe enough, in spite of all your pains and efforts, it would have been impossible to get good landscape pictures. And knowing that such a rain, or astrological progressed aspect, was at hand, you would not attempt it, but would turn your energies into something you could do even while it rained.

Just How to Regard Major Progressed Aspects

—Now if you will regard the birth-chart as a map of yourself, as an accurate map of your aptitudes and of your character, and therefore, of your tendency to attract certain conditions into your life, you will have the right conception of it.

Then, if you consider every progressed aspect and position as a definite weather condition—not a general weather condition, but as a weather condition affecting only specific departments of your particular life—you will have as clear a picture of their method of influence as can be obtained. They are, of course, truly astral storms and astral sunshine; but because of the high-velocity properties of the astral world, they affect you in a way they do not affect others, and they affect you only through certain departments of life, and not through other departments.

It may be that you have a crop growing in the field, and the government weather bureau sends out a frost warning. You cannot prevent the weather thus turning cold, nor can you prevent a Saturn progressed affliction from having a chill and depressing affect on conditions. Knowing that such conditions are at hand you may be able to do something to save your crop, to insure it, or to mitigate the loss. Then again, you may be so situated that nothing can save this particular crop. Or, speaking of progressed aspects, you may be already in business in such a way that a severe affliction to Saturn in your chart by progression is certain to bring you heavy loss in spite of anything you can do.

But because the weather bureau sends out a warning that it is going to freeze, that it is going to rain, that it is going to hail, or that it is going to blow a gale, should cause no person to cringe with fear.

Fear gives no help, and paralyzes effort. Every such weather warning, or astrological warning, presents a definite problem. That problem is: What is the very best thing to do under the approaching atmospheric or astral condition? In every such instance there is always a best solution to the problem. Usually Precautionary Actions can be taken to ameliorate the difficulty. But even when nothing can be done to prevent loss, the issue can be met courageously, spiritual values can be gained from it, and the attention can be turned to something else that offers better promise.

Because Course IX goes into the details of counteracting astrological influences through the deliberate use of specifically selected thoughts, I shall here neglect that phase. But entirely aside from thought-power to annul the influence of undesirable astrological vibrations, there is always, in any person's life at any time, somewhat more sunshine in one department than in some other department. That is, no matter how terrific the astrological storm may be, it never strikes all phases of the life with equal intensity. Under a whole group of adverse progressed aspects the sky may not be wholly clear in any region but, resulting from the structure of the birth-chart alone, there is sure to be less storm in one section than in other sections. And an analysis of the birth-chart and the major progressed aspects will reveal this least afflicted area, as well as those where the elements rage fiercest.

Even when it is possible to do so, I do not advise that you should always avoid the stormy areas. Such departments of your life as are indicated by the houses in which planets are located that make strong progressed aspects are sure to come into prominence under these aspects. If the progressed aspect is favorable, go ahead to the extent warranted by the possibilities of the birth-chart. And even if the progressed aspect is somewhat adverse, a careful survey of your birth-chart, and a gauge of the probable force of the affliction, may convince you that you can win out in spite of the temporary astrological storm. Or a matter of principle may be involved, causing you to feel that even though you are sure to be severely battered in the encounter, it is better to fight and suffer than to sidestep the issue.

The storm warnings which major progressed aspects give should not serve the purpose of frightening you, or deterring you from undertaking anything possible to accomplish. But they should, and they do, when correctly understood, indicate the times of approaching sunshine or storm, as affecting each section of your life. They give you definite information when you will have difficulties to overcome in each department of life. And by giving you a measure of the help or hindrances you are quite sure to encounter in each line during a given period, they enable you to count the probable cost of victory. By pointing out the cost of victory, and whether it is possible even by paying the price, your major progressed aspects taken with your birth-chart, give you a weather map that serves accurately to guide you as to whether any particular venture is worth while.

Furthermore, if you decide effort in one field is useless, or that to accomplish some particular thing will cost too much in energy expended, this astro-weather map also indicates to you in what departments, at any given time, there is most sunshine and least storm, and therefore, about what measure of success may be expected from a given amount of effort in each.

These major progressed aspects may come singly, but more often there are several operating. Often at the same time there are storm signals where investment and money matters are concerned there are fair weather signs over the areas devoted to domestic life, over the areas devoted to social activities, or over the areas devoted to building up the health and vitality. When such is the case, in so far as practicable, if you will turn your attention more to these latter departments your gains will be more satisfactory.

When several major progressed aspects are thus present at the same time it is quite possible that each will work out very largely in its own terms. If one is decidedly discordant, some unfortunate event may be attracted bearing the characteristics of these planets and affecting the department of life ruled by one of these planets. And if another major progressed aspect is quite harmonious, some other event may occur almost at the same time which is decidedly fortunate, bearing the characteristics of its planets and affecting the department of life ruled by one of these planets. Thus an individual may have an accident on a journey at the very time he acquires a large estate through inheritance. In such instances RALLYING FORCES have very little influence.

But it is more common than otherwise for the individual to react so strongly in his thinking and feeling to some one of the progressed aspects present, usually the most powerful one, that his nervous system keeps tuned to its frequencies. And the nervous system, through the electrical currents flowing over it is tuned, by the thoughts and emotion to pick up, radio fashion, the type of planetary energy, including its harmony or discord, corresponding to these thoughts and feelings. The nerve currents thus serve as conductors to the terminals of all the aspects. If, as is common, the nervous system through the thoughts and feelings engendered, keeps tuned to the energies of the dominant progressed aspect, these find their way, through the short circuit thus provided by the electrical energies, not only to the thought-cells mapped at the terminals of this aspect, but also to the terminals of other aspects, including all the other major progressed aspects, which are giving energy to the thought-cells. And thus the dominant progressed aspect becomes a RALLYING FORCE which influences what happens relative to the departments of life reached by other progressed aspects.

While RALLYING FORCES made possible by the feelings and thoughts stimulated by the dominant progressed aspect rather commonly dominate a period, the individual, by persistently cultivating the thoughts and feelings characteristic of some weaker progressed aspect which is also operative, can cause its energies to be the dominant factor of the period. In other words, RALLYING FORCES often can be used to attract the kind of events desired rather than the kind that otherwise would have come into the life.

But other than through the short circuit provided by RALLYING FORCES, which is made possible by the thoughts and feelings, the astral weather influences the thought-cells, and therefore the life, only in those departments of the life shown by the houses ruled by the aspecting planets. And whether RALLYING FORCES are present or not, the astral weather influences the life only through the avenues characteristic of the planets involved in the aspect. These are the chief avenues through which each of the ten planets affect the life.

SUN: Any progressed aspect of the Sun affects the vitality, the significance, and the authority.

MOON: Any progressed aspect of the Moon affects the mental attitude, the domestic life, and the everyday affairs.

MERCURY: Any progressed aspect of Mercury affects the mental interests, the facility or accuracy of expression, and increases the cerebral activity.

VENUS: Any progressed aspect of Venus affects the emotions, the social relations, and the artistic appreciation.

MARS: Any progressed aspect of Mars brings strife, haste and increased expenditure of energy.

JUPITER: Any progressed aspect of Jupiter affects the individual through abundance, increased optimism, and joviality.

SATURN: Any progressed aspect of Saturn brings work, responsibility, and economy or loss.

URANUS: Any progressed aspect of Uranus affects through something sudden, through a human agency, and brings change into the life.

NEPTUNE: Any progressed aspect of Neptune increases the imagination, increases the sensitivity, and attracts schemes.

PLUTO: Any progressed aspect of Pluto affects through groups, through subtle force, and brings coercion or cooperation.

What To Do In An Astral Storm

—If there are storm signals from a certain house, unless sunshine is present from some RALLYING FORCE you may be sure of a storm in that department of life. But that does not signify you cannot receive help, even in this matter, from some other house where there is sunshine. But if you are to get assistance from this other department of your life to help you weather the storm in the one department, that help must come through the other department; it cannot come through the department where the storm is raging.

Here is a common example of what I mean: A man runs for some political office at a time when the ruler of his 10th (honor and credit) is afflicted by major progression. Now all the difficulties shown by this aspect will arrive; that is, bad weather will set in so far as his honor is concerned. No matter how bright and shining some other department of life may be by reason of favorable aspects, the storm shown will strike him in the matter of his honor.

But if, at the same time, his chart shows a fine sunshiny spell where his 11th house is concerned (his friends), he may look for great help from his friends. Now a friend may lend one an umbrella, a friend may come out in a boat and rescue one from drowning, or a friend may be of various kinds of assistance in a storm or deluge. So while the storm rages, as indicated by the affliction in his house of honor; his friends may be loyal enough, and have ability enough, to rescue him from what otherwise would be a 10th house disaster. And many a man has obtained political office when by progression his 10th was badly afflicted, by at the same time having strong benefic aspects from the house of friends, or from the house of money. These aspects have not been to the ruler of the 10th, but he obtained money enough to buy his way, or his friends were good enough to carry him, through the storm in his 10th.

I do not think that any person, no matter whom he may be, can get the utmost out of life without the astro-weather map furnished by his birth-chart and major progressed aspects. If you are discerning, even though you are no expert in astrology, you quickly come to know just about how hard it is, on the average, to make satisfactory progress in each field of your interest.

Your Own Weather Chart

—You should have at hand, at all times, a birth-chart, with all the major progressed aspects that are within one degree of completion marked down at the side of it; and the date when each of these major progressed aspects is completed; or if past, when it was completed. Just bear in mind that each such progressed aspect, at all times while within one degree of perfect, tends either to sunshine or storm in the department of life ruled by each planet. The closer the progressed aspect comes to completion, the more violent the storm, or the more balmy the sunshine, as the case may be.

Do not think, however, that the event indicated by this storm or sunshine necessarily will arrive exactly on the date when the progressed aspect is complete. It may do so, of course. That is, you may have enough pressure brought to bear upon you just when the storm rages fiercest that you then go out into it. Or it may be that the sunshine is so alluring when strongest that you are impelled right then to take advantage of it. But, on the other hand, while the aspect is within one degree of perfect, yet not complete, or even past completion, there may be minor progressed aspects, or even strong transits, that in combination with the influence of physical environment cause you to move into such sunshine or storm as is signified by the heavier progressed aspect.

Yet you should get this clear in your mind: that even when you feel no effect of such astro-weather conditions, if the major progressed aspect is within one degree of perfect, the storm is there, or the sunshine is there, which it indicates. Your not being affected by it is due to your remaining within an appropriate shelter. That is, you have refused to become active within the departments of life affected by the progressed aspect.

Minor Progressed Aspects and Transits

—And right here Minor progressed aspects, and to a less extent Transits, come in. For during a storm in a certain department of life, a Minor progressed aspect or even a strong Transit aspect may come along from one of the planets involved in the storm. If the Minor progressed aspect or Transit aspect is also stormy, it indicates a gust added to the strength of the general storm for a few days, which added violence may precipitate the condition threatened by the storm. But if the Minor progressed aspect or Transit aspect is itself sunshiny in nature, it indicates that within the storm there is a glimpse of fine weather. And because of this illusory promise of fair weather you may be lured into the storm Yet the storm as a whole may be so strong that the little bright spot in it has no power to afford shelter.

Thus while a major progressed aspect affecting a certain department of life is operating strongly, any minor progressed aspect or transit aspect also directly affecting that department of life is likely to indicate the time of its most pronounced effect. Under such astro-weather conditions, when action becomes necessary, it is better to avoid even the good minor progressed aspects and transit aspects of the planets causing the more general storm. Instead, action should be taken under whatever indirect shelter can be found in the sunshiny minor progressed aspects and transit aspects of planets not directly involved in the storm.

Timid People

—I have seen people, and so have you, who dash madly to cover if even a gentle spring shower comes up. Just a pleasant breeze is sufficient excuse for them to neglect their daily duties. And there are astrological students who are frightened over any little discord that shows up in the progressed aspects of their chart. Neither of these groups gets very far in life. They lack the very essence of success, which is discretion and courage.

Let me implore you not to scan your chart to find something to fear. If a government weather map gives you a nervous chill when it shows a little bad weather ahead, it is better for you not to see such a map. Our desire to know what kind of physical weather will be at hand on a certain day is not so we can run like a whipped cur if we perceive it is to be cloudy. It is so we can go about the necessary duties of life in greater comfort and with greater efficiency than we otherwise could. If it is necessary for us to go to the office, we go in spite of impending rain; but we take along an umbrella or a raincoat to use when we are on the way home.

A chart showing there will be a late frost does not prevent us from planting our crop; it just enables us to delay planting until the indicated frost has passed.

So, with a map of the major progressed aspects for your chart before you, try to realize that every discordant progressed aspect signifies stormy weather in the departments of your life it influences; and every harmonious progressed aspect signifies fine, clear weather in the departments of your life it influences. Such weather obtains all the time the aspect is within one degree of perfect, but grows in intensity up to the time the aspect is complete, then gradually diminishes. From this, together with the birth-chart, try to form a clear image in your mind just how strong the storms, or the fair conditions, are as affecting each of your affairs.

Then, with this information before you, plan your life accordingly. Do not be afraid of storms; getting a little wet may be good for you in the long run. Going out in the wind once in a while may wake you up. But, at least, know where and when the storms are, and where and when is the clear fine weather. And then adjust your life by the aid of this information. As a trader uses the market quotations to guide his buying and selling, use the knowledge of your major progressed aspects as the chief guide to all your activities.

House Transits

—I am not advising you completely to ignore transits and minor progressed aspects. Look upon the transits of the slowly moving planets through the houses of your chart, not as storms and spells of brightness, but as seasons that are unusually hot, unusually cold, unusually wet, or unusually windy. The transits of the planets through the houses do not give rise to storms and sunshine governing the departments of life so affected. They give seasons of a certain type, within which the sunshine and storm indicated by progressed aspects take place. As seasons of a particular type they deserve consideration.

Less Important Affairs

—But the minor progressed aspects and heavier transit aspects, such as the conjunction of a planet with the degree on the ascendant, or the degree occupied in the birth-chart by a planet, are not so general. They are little spells, within the larger storms or fine periods. In themselves they are not strong enough to produce weather of such permanence as to offer great hindrance or great help. Yet they do indicate the little flurries of rain, the brief gusts of wind, and the other temporary weather conditions that often make for the success or defeat of our day to day or week to week affairs.

You can well afford to watch your heavier minor progressed aspects, and even some of the heavier transit aspects; for within the more important periods, and when the astral weather is little affected by major progressed aspects, they give you a map of the days, and the weeks, when the astro-weather will favor or hinder your ventures.

In all those little affairs of life over which you have the power to choose whether you will do a thing or not, and when you will do it, you will find that a knowledge of what minor progressed aspects are operative will make your life far more pleasant and less subject to discomfort and little annoyances.

It is not a disaster to plan an outdoor picnic for a certain day, and to awaken on that day to find it raining. Nor is it a matter of grave importance that you go on a visit to relatives just when they have left for other parts, or their children have just been quarantined for scarlet fever. But such things are awkward and annoying.

Then again, to go for a social evening with friends to find that they have just had one of their quite infrequent but rather violent family rows, is somewhat disconcerting.

Yet for all such small occasions as I have mentioned, and the score of others that readily come to your mind, if you will consult the astro-weather map of your minor progressed aspects, you will be able to avoid picking the times when irritations are sure to be in the offing. You can quite easily learn to pick fair-weather minor progressed aspects for all these little ventures. Of course, if you ignore minor progressed aspects entirely, yet have a thorough knowledge of your map of major progressed aspects, you will be able to make a success of your life. You will take the proper time for the big things, and direct your chief energies wisely. But if you do not also know your minor progressed aspects, you will have to fight through a lot of disagreeable trifles that they would enable you completely to avoid.

Summary

—At all times, regard your birth-chart as of far more consequence than any other astrological influence. Consider it as a map of your character, your aptitudes, and your peculiar susceptibility to certain types of astral storm or astral sunshine.

Next, consider only the major progressed aspects as of sufficient influence to afford a reliable map to guide you in deciding the really important issues of your life. Yet every major progressed aspect should be carefully weighed as to its possibilities and probabilities. Gauge the volume of influence, the time when it reaches its maximum, and the departments of life which it may influence, of every major progressed aspect.

But never consider progressed aspects as events in your life. Instead, look upon them only as astro-weather conditions that either favor you or hinder you in specific hopes and endeavors. So, weigh each carefully, to determine how best to act; for while you cannot prevent the weather from being what it is, you can direct your actions under such weather conditions as obtain.

Look upon the transit of a heavier planet through a house as a season corresponding in quality to the planet, and as affecting the department of life ruled by that house.

Make use of minor progressed aspects and even of the stronger transit aspects; but especially the minor progressed aspects of the Sun. Consider them merely as little spells of sunshine or little squalls, within the astro-weather conditions shown by the major progressed aspects.

Keeping in mind that the astro-weather conditions shown by the major progressed aspects and minor progressed aspects are the most important influences that bear upon the success of all ventures, when you commence something of importance, take the initiative in any enterprise, or choose a day for some special purpose, also consult the aspectarian in the back of the current ephemeris, and select a time which gives strength and harmony to the planet ruling the particular venture.

Chapter 2

Serial No. 184
Original Copyright 1945
Elbert Benjamine

Copyright
August 2002
Church of Light

Sympathies and Antipathies

Chapter 2

Sympathies and Antipathies

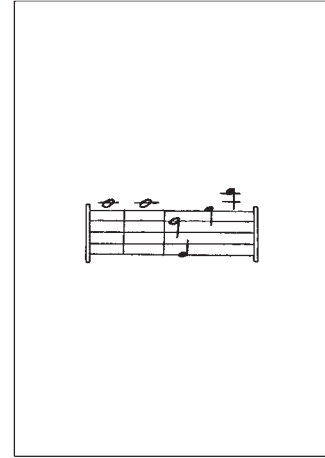

I SUPPOSE that no one will be so hardy as to deny that a given environment affects different people in markedly different ways. Most of us know those who become chilled and so devitalized that their lips begin to turn blue after a few hours on the seashore. And we know other people who find no better tonic than the cold salt sea wind. Those who suffer asthma here along the coast are advised to move to the high, dry desert of Arizona, and those of the desert region suffering from the same complaint frequently get relief by a journey to the coast. A Colorado rheumatism, likewise, sometimes disappears when the patient gets to sea level, and a sea level rheumatism sometimes vanishes in the high mountains of Colorado. People are different in the makeup of their astral bodies, and consequently do not offer the same response to identical external conditions.

Many of your own responses to conditions are so easily noted that they require no more than mention. You know it if wearing a wool garment next the skin causes the appearance of a rash, and you probably have learned, long before now, that certain articles of diet that other people eat with impunity, do not agree with you. But there are numerous other subtle surrounding conditions that are well worth some attention.

And of quite as much importance as knowing that they should be given some attention, is to determine just how much attention their importance warrants. To burden ourselves needlessly with a multitude of observances is so to expend our energies upon unessentials that we have none left with which to meet the real and vital issues of life.

The most important of all imponderable forces to influence our lives are our own thoughts. But because in other courses I have discussed their use and influence in great detail, here I shall consider only their employment to recondition discordant thought-cells. Next to our own thoughts as having great power to influence us I consider astrological forces. As third in power to affect our lives I should place the thoughts of other people, our acquaintances and immediate associates in particular. Fourth in importance, I believe, are the objects, animate and inanimate, of our environment. And finally, as the fifth, and under ordinary circumstances the least important power in most persons lives, are to be considered entities and intelligences of the astral world.

Relative Importance of Imponderable Forces

—This means, in its practical application, that the person with a limited amount of energy to devote to such things should use about one-half of it learning intelligently to direct his own thoughts. If he neglects this, the aid he gets from other imponderable forces will be correspondingly small; but if he gives time in full measure to cultivating proper mental attitudes, the aid he gets from other imponderable forces will be very great.

Of the energy at his command to devote to occult pursuits, he will do well to devote about one-fourth of the total to learning about himself astrologically. One-eighth of the total can advantageously be devoted to a consideration of other people's thoughts as influencing agents. Ordinarily he is warranted in devoting perhaps but one-sixteenth of the energy set aside for occult pursuits in reference to selecting suitable objects, or situations, for his environment. And there is then left to him, of the total devoted to occult pursuits, another one-sixteenth which he can use in the study of, and adjustments to, all other imponderable forces, including the spirits of the dead, and various denizens of the astral world.

Now I am well aware that this ratio of $1/2$, $1/4$, $1/8$, $1/16$, $1/16$ is quite arbitrary, and certainly would not be applicable in all instances. But it seems to me better to have even such an arbitrary scale, open as it is to controversy, than to have no gauge at all. New thought enthusiasts and metaphysicians will deem that $1/2$ is far too small a portion to allow for the development of proper thinking. The astrological fan will be sure that astrology should receive even more attention than thought. And the spiritualist will feel slighted to note that the influences from the next life are allocated an importance in our everyday affairs that warrants only $1/16$ of our energy spent in occult pursuits being devoted to understanding and using them.

I shall find no fault with anyone who thinks I have underrated or overrated the importance of some particular type of imponderable force. But human time and energy are limited, and there is great need of some standard of values, so that they will not, in ignorance, be frittered away. As a practical occultist, interested in all imponderable forces, and somewhat familiar with the various types, I have attempted to give a ratio based upon my experience of the relative importance of each in the average run of people's lives.

Some may be surprised that I advocate so much energy spent in learning about thoughts and emotions and in directing them. But the object of the study of imponderable forces is to learn how to take advantage of such of them as coincide with our ambitions, and how to escape the obstructing influence of those which oppose us. In some few instances this object can be attained through knowledge alone. But mostly, in spite of mere knowledge of their existence and just what they are doing, imponderable forces reach and influence us.

To prevent them reaching us we must be able to tune in on some other wave-frequency; and we can only do this through properly directed thoughts and emotions. And there are others, such as astrological forces, which, due to responsive thought-cells within our finer body, we cannot tune off and break the connection. They reach us, wherever we are, and in spite of ourselves. Yet even so, we can prevent them, in large measure, from influencing us in adverse ways. We can do this in a minor extent through intelligent control of our environment. But really to control them and make them serve our purpose, we must be able to change the desires of the thought-cells they reach so that these will use the energies thus acquired in activities which are beneficial. This we can do only by cultivating proper mental and emotional attitudes.

Even where planetary influences are concerned, while not being able completely to tune off the energies from birth-chart or major progressed aspects, we can tune the nervous system, through intense feeling of a selected type to pick up, radio fashion, other more harmonious planetary energies in great volume; and these will then be fed to all the thought-cells reached by any major progressed aspect then operative. Even as Rallying Forces not consciously selected often change the desires of the thought-cells and cause them to bring events into the life of a fortune or misfortune not indicated by the progressed aspect directly reaching them, so Rallying Forces also can be deliberately utilized to change thought-cell desires, and the consequent event attracted, in the direction selected.

But in addition to tuning in on some more harmonious energy, the desires of the thought-cells may also be altered in the direction selected through either Conversion or the use of a proper Mental Antidote.

As the feeling of pleasure or pain at the time these thought-cells were formed is entirely responsible for their desires before they are given unusual activity through the energy fed into them by a progressed aspect or by the character vibrations of an object or some other person's thoughts, their desires can be altered in the direction of harmony by adding pleasant feeling energy to them in as much intensity and volume as possible. This process does not add thought-elements of a different planetary family to the thought-cells, but it does rearrange in a more harmonious compound the thought-elements of which they already are composed.

Rallying Forces change the desires of the thought cells by delivering to them energies of a selected type. Conversion changes the desires of the thought-cells by a rearrangement of the thought-elements in the compound of which they are formed. A third way of changing thought-cell desires is through the use of Mental Antidotes.

When the two planets which are mental antidotes do not heavily afflict each other in the chart of birth, it is usually easier to substitute thoughts and feelings ruled by the antidote planet, than merely to think constructive thoughts and have constructive feelings ruled by the planet whose thought-cells are to be made more harmonious. When thinking and experiences of the nature of the antidote are substituted for the old type of habitual thinking and feeling, there is apt to be less resistance to

developing pleasant thoughts. If Mars is heavily afflicted at birth, for instance, it may be difficult to think of the departments of life it rules in terms of initiative and constructive endeavor without at the same time thinking of the irritation, anger and antagonism which has been experienced in the past relative to the events and conditions of these departments of life. It may be easier, in reconditioning the Mars thought-cells more harmoniously, to substitute for belligerent and destructive thoughts their mental antidote, constructive thoughts and feelings about domestic life and assisting the weak and helpless, ruled by the Moon.

Unseen energies ruled by the Sun need no mental antidote, and any constructive thoughts of the other planetary families added to Sun thought-cells are beneficial to them.

Constructive thoughts ruled by the Moon or Pluto are the mental antidote for Mars energies, and constructive Mars thoughts are the mental antidote for Moon or Pluto energies.

Constructive thoughts ruled by Jupiter are the mental antidote for Mercury or Uranus energies, and constructive Mercury thoughts are the mental antidote for Jupiter energies.

Constructive thoughts ruled by Venus or Neptune are the mental antidote for Saturn energies, and constructive Saturn thoughts are the mental antidote for Venus or Neptune energies.

In applying mental antidotes, only the constructive thoughts and feelings of the antidote should be used. They should be substituted for thoughts which arise belonging to the planetary family of the thought-cells to be reconditioned, and used whenever there is close association with the thoughts of others, or with an environment, belonging to this planetary family, and whenever there is a progressed aspect involving the indicated planet.

The most important factor in employing either conversion or mental antidotes is to give the thoughts substituted for those undesirable as high a harmonious emotional content as possible. And at first to make them thus highly pleasurable it may be necessary to associate them with as many other pleasant desires as possible. Thus at first artificially conditioned by association, in not too long a time these new thoughts will develop a highly pleasant content of their own.

I place so much stress upon the cultivation of thoughts and emotions because they are the most effective agents for the control of all the other types of imponderable forces.

Charting Our Thoughts

—Let us understand that a thought radiates from the thinker's mind, and that a given thought has a definite vibratory rate. The nature of the thought determines its rate. Thought-vibrations may sound either on a higher or a lower decave (an interval of ten), just as a tone may be sounded on a higher or a lower octave (an interval of eight). Did we but perceive the thoughts of any individual as completely as we hear the tones of his voice, the vibratory rates of the thoughts could be charted with the aid of a staff similar to that used in the notation of music. Each distinct thought has its own vibratory-tone within the decave; but those of the next decave just above the staff, because of a responsiveness somewhat similar to overtone effects in music, up to and including note 22, have individual qualities that are repeated in still higher decaves.

This is not the place to enter into a technical discussion of how the lower decaves of thought are repeated in higher decaves, so that the same key can be sounded on upper or on lower frequency-levels. But it will assist in understanding imponderable forces if you realize that a train of thoughts is just so many thought-tones.

If we could discern them properly we could set them down on a piece of paper, and the chart so formed would look not so dissimilar to a musical composition. Each separate thought would have its own place on, or above, the staff, and it would be related to other thoughts that came before and that followed after, according to sequence.

Such a train of thoughts, if it were clear cut, would have its own dominant key. We might designate this key after the name of the thought-note corresponding to it. If the thought-train, or composition, revolves about accountancy, we know its key is 1, corresponding to the planet Mercury. If the thought-train revolves about war and strife, we know its key is 16, corresponding to the planet Mars. If the dominant note is despondency and discouragement, we know the key is 15, corresponding to Saturn. If hope and faith are the controlling elements, we know the key is 17, corresponding to the zodiacal sign Gemini.

Someday, I believe, an apparatus will be constructed delicate enough to record thought-waves. With such a device it will be possible to tabulate the vibratory frequency of each thought as it is radiated from the thinker's mind. But at the present time there is no such machine. Consequently, to chart the tones of a complex series of thoughts so that each shall occupy its proper place in a charted thought-composition is as yet beyond us. But at least we can, through a quick analysis of the feeling and desires associated with it, determine the key of any clear cut thought composition of our own.

Other people about us also are having thoughts and these thoughts often are radiated to us. And because we devote attention to our own thoughts, and to the thoughts of others, as imponderable forces capable of influencing us, the question next arises as to which are the more important and deserving of attention and energy. In many connections this same problem will arise. And while there are unusual circumstances that alter this, and while there are plenty of exceptions to it, under normal circumstances the thoughts of the individual about himself are far more powerful in affecting his life than those coming to him from without. Even the thoughts of others more frequently influence him markedly through causing him to change his own thoughts and opinions than through those more direct alterations of his finer body that thought-impacts tend undoubtedly to produce.

We all entertain ideas about ourselves. We all habitually entertain certain types of thought, and habitually experience certain kinds of emotional states. At the same time our associates may hold quite different opinions, and more or less constantly bombard us with the emotional quality they feel thus thinking of us. But unless we are unduly negative, their influence thus exerted is far less important in molding our destiny than what we ourselves think and feel.

Of the thoughts with which we are associated, abstractions, such as names and numbers, are the least apt to arouse emotions in those thinking them. Their effect, therefore, upon the individual with whom associated is more often than not entirely determined by their own essential vibratory rate, uninfluenced by incidental polarities.

Thoughts which are less abstract usually have added to them the feeling of pleasure or pain that arises from past experience with similar objects or situations. And some people who think of a person by name, also may experience a feeling of attraction or of dislike due to previous encounters with the person to whom the name belongs. This is due to the incidental association of the name, and not to its own vibratory rate. But perhaps the majority who think of the same name will feel no emotional response whatever.

This incidental polarity of a thought, the feeling of pleasure or pain associated with it, determines the manner in which it unites into combination with other thought elements within the finer form. But it does not change the essential key of the thought. The key, or essential vibratory rate of the thought, determines what group of thought-cells within the finer body will be given greater activity by the thought, and therefore what type of external conditions will be attracted.

Vibratory Influence of a Name

—When people think of us by a name, whether that name is spoken, whether it is a matter of reading our signature at the bottom of a letter, or merely that our name flashes into their minds, they usually, at least vaguely, visualize us. Or if they do not know what we look like, the reading of a letter from us serves the similar purpose of focusing their minds so that their thoughts travel directly to us. While speaking or

reading our name, they think about us, either clearly or vaguely, and the vibratory rate of the name is radiated from their minds to our own. Thus we receive a thought-wave, coming directly, because at the moment their minds are trained on us. And whatever the vibratory rate of the name thus wafted in our direction, the impact of it stirs up within our finer body those thought-cells having a similar vibratory key.

But of even more importance than the name others know us by, is the name by which we think of ourselves. Under ordinary circumstances the thought-treatments we give ourselves, although we may never have considered them thought-treatments, are more important than any thought-treatments from others. Therefore, the name by which we think of ourselves is usually more important than the name used for us by someone else. And while some may consistently think of themselves by the designation applied to them by familiar associates, one who is called upon to sign his name to letters, checks, and such papers, frequently tends to acquire the habit of thinking of himself by this signature. And those who read this signature, at the time they read it certainly think of him by this name. Under such circumstances it would seem, then, that the name as thus signed probably would be more powerful as influencing him than any other designation. It would be more powerful because more thought energy of the vibratory rate of this particular signature would reach him than that of the rate of any other name.

Yet other names also would have some effect. If he is a boy going to school and his schoolmates always call him Dan, and perhaps few ever think of the balance of his name, and some who call him Dan do not even know all his name, he is bombarded, by the thoughts of these schoolmates, with the vibratory rate of Dan, which happens to be 19, corresponding to the zodiacal sign Leo.

But his mother may always think of him as Danny. Thus she gives him another vibratory rate. And his father may call him, and consider him only as Daniel. This gives him still another rate to absorb or contend with. Yet, because the people who think of him by these different names are not equal in the power with which they project their thoughts, nor do they think of him with equal frequency, these names have different importance as influences in his life. Nor do I think the name with which he was christened has much influence over him, unless he continues to use it and be known by it.

Nicknames, pen names and such other designations as we may be known by have a certain amount of influence. How much influence can be approximated by an estimate of how often each is used and whom the people are who think them. But how much energy we are warranted in spending getting others to call us by a name that is keyed to the vibration that within ourselves we know to be harmoniously organized and attractive to the things we want, is an open question. I do believe, however, that it is well worth whatever trouble is involved to select a signature, which usually can be done by using initials for the middle name or making some slight alteration in the given name, that has a key-vibration corresponding to fortunate influences in the life.

This opens the whole subject of sympathies and antipathies. And much confusion may readily arise in connection with this subject unless we carefully distinguish between vibratory affinity and our own likes, and between the sympathetic vibration of some external energy toward some particular group of thought-cells within ourselves, and the vibration of that energy as affecting our welfare.

Birth-Stones

—We will come back to names and numbers; but to make this matter clear, for the moment let us consider birthstones. A birthstone, according to the prevalent opinion is a stone or gem ruled by the same zodiacal sign occupied by the Sun in the birth-chart. Wearing such a gem, because it has the same vibratory rate as the sun-sign, has considerable influence. A live gem has a rather potent vibratory rate, and because of the law of affinity, it vibrates in sympathy with the thought-cells in our astral body ruled by the same zodiacal sign. That is, wearing a birthstone adds activity to the section of our astral body in which the Sun was located at our birth.

Let us suppose now that a birth-chart has the Sun in the 2nd house. The 2nd house rules money, and the chief influence of increasing the energy of the thought-cells in the astral body ruled by the sign in which the Sun is located, in this case, is upon finances. Furthermore, whether by associating with a name, a number, animate object, inanimate object, human acquaintance, or thoughts, the activity of the sun-sign is accentuated and increased; by just so much as it is thus accentuated does it increase the power of the money thought-cells in the life. It does so because the astral radiation's of the birthstone or other object or a thought ruled by the birth-sign adds energy to, and increases the activity of, the thought-cells in the finer form whose desires relate to money.

The Important Factor

—It will be seen, therefore, that the common idea of birthstones is really founded upon the law of affinity. Yet the most important factor has so far been omitted from consideration. That factor is whether or not increasing the sun-sign vibration will benefit or injure the particular individual.

Suppose, for instance, in the birth-chart both Mars and Saturn are in the same sign with the Sun, and not only conjunction the Sun, but all are square Uranus. To accentuate the thought-cells in the astral body occupied by the Sun means also to accentuate Saturn thought-cells and Mars thought-cells, and to bring out the influence of the conjunction and the discord of the aspect from Uranus. For if you accentuate in the astral body the vibration of a sign, you at the same time accentuate the activity of all the thought-cells mapped by the sign; even as when you agitate a certain pool of water you at the same time agitate every boat or stick floating on its surface.

In this case the money section of the astral body would be given much added activity; but that activity would all be discordant. Increasing the activity of its thought-cells would attract the loss of money. In fact, in this case, the birthstone, or friends, thoughts, names, numbers, locations, or any other things that would increase the activity of the thought-cells ruled by the birth-sign would be the very worst possible vibratory influence that could be selected.

But suppose, in this same birth-chart, the Moon made a trine aspect to the Sun, Mars and Saturn, and was unafflicted. Because there is a harmonious aerial leading from it to the section of the astral body that influence money, the vibratory rate of the Moon, then, becomes the best influence in the life for money.

Its energy can be increased in either of two ways: If there are no afflicted planets in the sign it occupies, and if the ruler of this sign is not heavily afflicted, the energy of the Moon vibration may be increased by a gem, thoughts, friends, names, numbers, etc., ruled by this sign. Whatever increases the thought-cell activity of the sign, however, increases the thought-cell activity mapped by every planet in the sign; and also, to a lesser degree, increases the influence of the planet ruling the sign. But increasing the activity of that part of the astral body ruled by the sign does not change the harmony or discord of the thought-cells located there. It merely gives whatever thought-cells are there located additional power to attract things and events of a corresponding quality into the life.

Consequently, in this case, if there are other and afflicted planets in the sign occupied by the Moon, it is better to wear a Moonstone, and to associate with other things directly ruled by the Moon than with the things ruled by the sign occupied by the Moon.

Usually there is felt quite a strong attraction toward gems, people, locations, etc., ruled by the sign rising in the birth-chart. This also is a matter of affinity. We have certain thought-cells quite active, and when we contact other things with the same vibratory rate we experience a distinct, and often quite pleasant response. But whether or not the association with things ruled by the rising sign will prove beneficial depends entirely upon whether planets in this sign, and the ruler of this sign, in the birth-chart, are harmonious or discordant. If there is a severe affliction in the first house of the birth-chart, it is best to associate as little as possible with the things ruled by that sign.

The point I am trying to make here is that all twelve departments of life, which embrace every kind of endeavor and activity, correspond to the sections of the astral body mapped by the positions of the zodiacal signs on the mundane houses of the birth-chart. Therefore, the thought-cells of any particular department of life can be given added activity by associating with the things ruled by the sign corresponding to them in the birth-chart, or by associating with the things governed by the planets in the appropriate house of the chart. But whether this added activity of the thought-cells will prove beneficial or not is determined by the harmony or discord of such sign and planets in the birth-chart.

However, in any birth-chart it is possible to select some influence that is more favorable to any department of life, and some influence that is more adverse to such department of life. Consequently, no matter in what direction one desires to have more success, it is possible to increase that success by proper vibratory association.

But any such selection must be made with a view to individual requirements, and not because in a general way certain things are lucky and other things are unlucky. And not simply because the individual happens to like some association very much. We can say that strawberries are very good food. Yet if some persons eat strawberries they break out with hives. Yet these people that break out in hives when they eat strawberries are sure to like them quite as much as other people do who suffer no inconveniences from them.

As a matter of observation, people usually like, and almost invariably are drawn into, activities of the type indicated by the strongest influences in their charts of birth. This is a valid operation of the law of affinities. The more active a group of thought-cells is the more power it has, working from the inner plane, to bring events such as it desires into the life. If the group desires events which are beneficial to the individual, well and good. But, as is the case when the group is mapped by a heavily afflicted planet, if the thought-cells desire and work for events which are inimical to the individual, activities of the type indicated by them afford special facilities for them to bring into the life disastrous events. The very people, for instance, who should avoid danger, often take the keenest delight in wild hazards, and thus early meet a violent end.

There are things, of course, and people, whose vibrations are of such a nature that we feel uncomfortable in their presence. These discords are obvious, and should be avoided. But more people suffer loss through friends, acquaintances, and confidence-men whom they really have liked than through the influence of those toward whom there is a strong magnetic antipathy.

How Important Are Numbers

—Now coming back to the vibratory influence of abstract ideas, just how much energy are we warranted expending in the selection of proper numbers? The number of the house on the street, or the number of the room in an office building, or the number of a post office box, usually stands out in the mind quite apart from the name of the street, building, or post office. As commonly visioned, I believe, the number is the important element of such an address. And when many people think of this number each day in association with the person using it, that person receives quite a bombardment of thoughts of the particular vibratory key of the number. Also, he becomes accustomed to think of himself as associated with this number. And in this case the number has quite an appreciable affect on him.

Then when an individual is called by telephone many times a day, those calling him think of him while calling the number. In our cities it is customary to have a name as a prefix for the telephone number. If it is a dial telephone, only the two first letters of the prefix are dialed. Nevertheless, in answering the call, in listing it in the directory, and usually, I believe, in thinking about it when giving the call, the prefix in full is considered as a part of the number. Consequently, in determining the vibratory key of such a telephone number, the prefix part and the number part should be added together as a single vibratory unit. And if the person is called over the telephone frequently, this vibratory rate, so often projected by thought to him has considerable influence. How it will affect him, of course, depends upon the corresponding thought-cell harmony or discord in his own astral organization.

But how often do people think of an individual in association with the license plate number of his car? When I am called upon to write the license plate number of my car, I usually have to pause a moment to remember it. When I go into an auto park after the car, even though the park is full of other cars, I seldom glance at the license plate. I recognize the car as I would a horse or a cow, by its familiar features. Of course, some people may recognize their car only by looking at the license plate, and should I be in doubt, I also look for the number. But ordinarily I do not often think of the number, and therefore, in so far as my thinking is concerned, it has little power to influence me.

As to the influence of others thinking this number in connection with me, I do not think I have half-a-dozen friends who remember the license plate number of my car. And although I see the license plates that approach and pass me on the road, and those of cars going ahead of me in the same direction I am going, I do not read these numbers. The common extent of my observation is to notice when the color of the plate denotes it was issued elsewhere, and when this is the case to notice the state in which it was issued.

I am aware there may be others who always read the license plate numbers. In so doing they may also think of the occupants of the car, and waft to them thus the vibration of the number thought about. But I am inclined to believe that if attention enough is given to the number of a passing car to fix it in the mind, that the car will be gone before there is any very clear picture also in the mind of its occupants. Or if attention is given to the occupants, that the number on the license plate will undergo at best but a faint recognition.

I do not wish to imply that under certain circumstances the number on the license plate may not be so frequently and clearly associated with the occupants of the car, or its owner, that it produces a quite discernible affect. But under ordinary circumstances I am inclined to believe that the influence thus exerted is rather small.

Yet people will go to unusual extremes sometimes to get a number for their license plate that vibrates to some particular rate. I grant that it is better to have a number that is harmonious to one than a number that is discordant. But to fear to ride in a car because it has a certain license plate number, or to insist that a garment shall have just a certain lucky number of buttons, is very close to the excessive fear or reverence which may be termed superstition.

In the attention we pay to imponderable forces we must learn to use discrimination. We must learn to gauge the comparative power of these influences, so that we may not spend much energy on those which are inconsequential. The power of names and numbers resides in the thought energy of those who think them. Consequently, in gauging their importance, the frequency with which they are thought, the thought-power of the individuals thinking them, and the directness with which, through association, they are sent to the individual, all must enter into the calculations.

Character Vibrations

—But in our contacts with people, we have both the characteristic vibration of the individual and the thought attitude toward us to consider. That is, like localities, plants, gems and domestic pets, people have a vibratory keynote. And in addition they have within their astral forms various thought-cell groups which radiate characteristic energy strongly. Furthermore, people think, and the thoughts they radiate each has its own vibratory rate. Unlike a name or a number, the thought radiation of a person is capable of quickly changing from one rate to another.

Thus a person whose astral organization is quite harmoniously attuned to our own, and from whom commonly only such radiation's are received as are highly beneficial, might for some cause become highly critical of our conduct, or even have a strong thought of enmity. And so long as such a thought was strongly projected against us, we should be bombarded with energies that would have a destructive effect upon us.

There are limits within which we can select our human companions. Had we the power to choose it would be better to associate closely only with people whose strongest vibratory rates were of the same key as harmonious thought-cells within ourselves. From a vibratory standpoint, how one person will influence another, and which departments of life will be most affected, can be learned from a comparison of birth-charts. But the birth-charts of our close associates are not always accessible; nor even so, is it always possible to choose whether or not we will associate with some person.

Not infrequently those of the same family are not altogether harmonious, yet have obligations that do not permit them to live apart. Sometimes, in the business world, people are compelled to work in the same office or shop with others toward whom they can feel only something of antipathy. And also, those who commonly are quite harmonious toward an individual may be subject to periods during which their thoughts are violently destructive.

We should, of course, choose our associates with considerable care, whenever this is practicable. But when such choice is impossible, or can only be made at too great a sacrifice, we should know how to prevent being unduly influenced through such contacts. A life of usefulness does not permit us to be too egocentric. The advancement of society requires the friendly cooperation of many rather closely associated individuals. To become too sensitive to the character vibrations, or to the more temporary thought vibrations, of others is to suffer; and to withdraw from close cooperative effort is to prove selfish. Consequently, in the home, in the business, or in more public contacts, it is very desirable to get along with people toward whom no natural sympathy is felt, without undue friction.

In protecting ourselves from any sort of thought influence, we can do so very effectively by assuming a cold, unbending, firm attitude of mind, and resolutely turning the attention to something else of interest. In this manner we break the connection, and the thought impulse recoils from our astral body without setting up changes in it. So long as we are in the presence of some person, object, or even astrological energy, if we were to hold this cold, unbending, inflexible attitude toward it, we could deflect its influence. But to continue in such an attitude would also shut out other energies which are beneficial.

If we must enter some obnoxious place temporarily, or if we are brought into contact with some inharmonious object temporarily, we can shut its vibratory influence out, just as on entering a place filled with smoke we can shut the smoke from our lungs by holding our breath. But holding our breath has its limit of usefulness, and assuming so chilly an attitude toward our immediate environment is also quite undesirable. People will cooperate with us only when they feel that we are friendly, and if we are coldly aloof and reticent they are sure to feel that we are unsympathetic.

Best Technique for a Disagreeable Environment

—But there is another technique that we can apply quite effectively during the time we must remain in the company of those toward whom there is some antipathy, in the company of those who for the time being are angry, critical, fearful, despondent or otherwise radiate destructive thoughts, or while we remain in any environment, or in the presence of any thing that we have reason to believe, either from a knowledge of its astrological signature, or because we sense it, is detrimental to us.

Under such circumstances we are not warranted in severing the vibratory connection completely. We cannot, for instance, act with cold and calculated indifference toward our employer. Even though the locality where we are employed has a vibration inharmonious to us, it may be quite necessary for us to work in it. If husband or wife periodically flies into a temper, or grows morose and despondent, it is neither expedient nor good policy usually to go elsewhere until the storm blows over.

There is, however, a Jupiterian technique that can be used in such situations. Many a wife and many a husband have learned this technique without other instructions than the necessity of getting along with the matrimonial partner. And many a partner and many a subordinate in business have learned, not only how to get on with the partner or chief, but also how to do so with least inconvenience to themselves.

This mental attitude, which can be cultivated and held indefinitely without shutting entirely out the character vibrations or the thought vibrations of others, is neither negative nor submissive. It is rather jovial and cheerful; an attitude that expresses itself in a smile and in kindness. It refuses, however, to take any notice whatever of unpleasantness. It refuses to argue or complain. It looks upon life as good. If others display a nasty disposition, or if the environment is discordant, they are tolerated pleasantly and kindly. But no attention is paid to discord.

This sweetness and pleasantness is not to be just on the surface, it must be felt. And it must be maintained with some positiveness. The object is so to saturate the astral body with cheerful, kindly, optimistic thought-vibrations that every thought-vibration reaching it from the outside will be given an incidental polarity that is harmonious. The basic rate of the vibration received is not thus changed.

A Mars vibration still remains a No. 16 vibration; and a Saturn vibration still remains a No. 15 vibration. But because the attitude of the person receiving these vibrations is calmly, cheerfully and radiantly positive to them, whatever discord they were originally endowed with by the one who sent them forth, or that they characteristically had, has its incidental polarity changed as it comes in contact with this pleasing thought-energy that suffuses the astral form. Therefore, this energy, while it adds to the activity of certain thought-cells within the astral form, at the same time, through the Rallying Force induced, increases their harmony and gives them additional power to attract conditions that are beneficial.

Now the imponderable forces that have some influence over us are of three distinct categories: 1. Character vibrations; which are the radiations of people, objects, and energies, due to the organization of their finer bodies. 2. Astrological vibrations, which reach us directly from the planets and zodiacal signs. 3. Thought vibrations.

A person radiates energy of the vibratory quality of the thought-cells already organized by states of consciousness in his astral form, whether he is engaged in active thought or not. This is his character vibration. But in addition to this, if he is thinking intently about some specific thing he is radiating a thought-vibration of a definite key, which is something separate from his character vibration.

Mechanical objects, localities, and colors all have character vibrations, but practically no thought-vibrations. Their affect upon a given individual can be determined as to kind by noting their astrological ruler-ship, or vibratory key, and how it stimulates his thought-cells, as pictured by his birth-chart. The amount and importance of their influence on the individual requires careful discrimination to determine.

Other things, however, in addition to character-vibrations have thought-vibrations due to the temporary activity of either their conscious or their unconscious minds. Among minerals, gems have the most intense thought-vibrations; and these are directed toward benefiting the wearer if the stone feels the sympathy which is aroused by harmonious thought-cells of its own key within the astral form of the wearer.

Domestic pets, such as cats, dogs, birds, and even horses have a thought-vibration, aside from their character vibration that, while of the unconscious mind, nevertheless may send energies of devotion and good will with much power to the one they love.

The flowers and shrubs of the garden, also, if tended with loving care, respond with quite potent thought-vibrations. Few people realize the benefits they derive from the thought-treatments of the various lower-than-human forms of life which they love, and which respond by sending them inarticulate, but nevertheless very potent treatments of love and well-wishing. The one who ministers sympathetically to make the lives of plants and animals happy, commonly receives full value of benefit for energy thus expended.

Chapter 3

Serial No. 185
Original Copyright 1945
Elbert Benjamine

Copyright
August 2002
Church of Light

Ceremonial Magic

Chapter 3

Ceremonial Magic

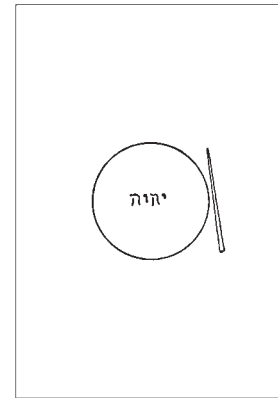

Ceremonial magic embraces those magical practices in which there is more or less definite ritual, and in which, often, specially prepared equipment, such as wands, circles, pentacles, inscriptions, formulas, etc., are used. Such magic may be black, white, or gray; depending upon the motive and the effect produced, or which it is desired to produce. And at the outset it may be well to differentiate between these types of magical practice.

Regardless of the method employed, black magic embraces all those mental practices which have for object the injury of another, the gaining of an unfair advantage over another, or which result in the enslavement of the individual practicing it to other entities.

White magic, on the other hand, has for object the benefit of another; and employs no practice which injures or enslaves the one using it.

Gray magic is the use of mental practices for the satisfaction of curiosity about phenomena, or for the gaining of something without injury to another and without depriving another unjustly; yet which does not greatly endanger the liberty of the one using it.

With or without the ceremonial element, magic may be white, black or gray; all depending upon the motive of the person employing it, and the ultimate effect both upon others and upon the magician. The New Thought method of Demonstrating Success, for instance, is white magic when the success is sought so that there may be a wider usefulness to others. It is black magic when it endeavors to deprive society of wealth without giving society something of equivalent value in return. And it is gray magic when the success chiefly is desired from selfish motives, yet with no desire to deprive or injure another in attaining it, and resulting in no detrimental effect to others.

After all, New Thought Practices, Metaphysical Healing, Mental Treatments, Christian Science, Mental Alchemy, Practical Psychology, and Realization Through Prayer, are each the utilization of those forces or entities which at an earlier date, and before material science lent to the word magic its meaning of charlatanry, were considered magical. Sitting in a chair and giving a distant person an absent treatment is magic, but it is not necessarily ceremonial magic. Yet if this treatment is preceded by a specific prayer, or is preceded, or accompanied by, certain gestures, fixed phrases of speeches, or even by Coue's formula, "Every day, in every way, you are getting better and better", it may rightly be considered ceremonial magic.

The Three Functions of Ceremony in Magic

—The ceremonial factor in magic is not a simple one, but may perform one or more of three distinct functions. And to understand these functions it is requisite that we understand the relation of the astral plane, the astral body of man, and astral entities to magic in general. Magic, if worthy of the name, utilizes forces of the astral plane, even though such forces are limited to the astral energies of the magician.

Yet going still further afield, we must recognize that what is built upon the astral plane by the mental imagery of an entity either incarnate or discarnate has an actual concrete existence on this inner plane; and under suitable conditions of contact with the external world may become more or less completely manifest on the physical plane. That is, once formed in the astral spheres, if it makes proper contact with the astral forms of those on the physical plane which connect it up with electromagnetic energy, or if through other contacts it gains a suitable electromagnetic energy supply, it has a power to mold and shape physical environment and circumstances to coincide with this astral state of affairs.

Now, to build anything on any plane, or to do work anywhere in the universe, there must be an energy supply of sufficient volume available. Nothing can be done without consuming energy. And to build any condition on the astral plane, or to direct its contact with the physical plane after it has once been built, requires energy. The energy suitable for such astral work is mental and emotional in character, the emotional property of the thought being especially important, for a thought not endowed with feeling has a very low energy content. One function of ceremony and ritual in magic, therefore, is through INDUCED EMOTION to supply in the most abundant manner the energy which is directed into magical acts.

But energy is not sufficient to build a house, to move a hill, or to attract gold. To do work of a desired character, the energy must be directed into carefully selected and suitable channels. In building a house, it must be directed into those avenues shown by the blue-print of the structure. To move a hill it must be made, by means of manual labor armed with shovels, or by an engine governing a mechanical shovel, to attack the hill in a particular and predetermined way. To attract gold it must be diverted into the channels of trade, or into wise speculation, or into some other well thought out plan.

Energy also, to perform any magical function, must receive specific direction just what it is to do. It must be guided accurately into those avenues which will work toward the accomplishment of the desired result. And this is a second function of the ceremony in magic, through DIRECTED THINKING to steer the energies into the specific channels which will cause them to labor for the anticipated result.

And there is just one other function of the ceremony.

When the task of building a house is too great for us, or when an object to be moved is too heavy for our strength, or even when we desire to conserve our own energies, we frequently call in help. The skyscraper is not built by one man, but by many men who are employed in its construction. A plow is no longer pulled by man power, but by horses or a tractor. And to move the iron beams that go into the framework of a modern office building, engine and crane are employed.

Ceremonies, rituals, and various kinds of equipment are employed in magic for the definite purpose of enlisting the aid of entities which have their abode on the astral plane. This is done in the hope, or expectation, that these entities will aid in the work at hand, and thus enable the magician to accomplish what he would be unable to do alone. This is the third function of ceremony in magic. By the aid of demons, of spirits, of elementals, or of angels, the magician endeavors to accomplish his purpose much as the modern “big-shot gangster” attempts to carry out his plans through criminal underlings; or as the industrial owner hires mechanics to run his factory. The kind of help enlisted, of course, depends upon the type of work they are expected to do.

Contacting Invisible Help

—Now let us suppose that you have never personally had any dealings with bootleggers, yet for some reason you become intensely interested in getting illegal liquor. What would be the first thing you would do under such circumstances?

You would probably endeavor to think of some friend or acquaintance who would be apt to know a bootlegger. And you would ask this friend how to locate such an individual. If you desired to employ a yegg to crack a safe, or a gunman to commit a murder, it is still less likely that you would know how to locate efficient help; but you, under such circumstances, would make inquiry in those quarters which you are led to believe do know about such matters.

And the individual who becomes predisposed toward magic, especially the black and gray varieties, must follow about the same method of procedure. He desires the help of invisible beings to bring him power, wealth, or to perform some iniquitous injury upon another. To commence with he is unacquainted with such invisible entities; and he does not know how to enlist their aid. But he makes inquiry among those whom he thinks know about such matters, and is either given some personal instruction, or is directed to some book on ceremonial magic.

In the Sixth and Seventh Book of Moses, in The Greater Key of Solomon, or in The Lesser Key of Solomon, let us say, he finds certain circles, diagrams, or seals, each bearing either names or symbols, or both, of strange significance. These names commonly are in a language with which he is unfamiliar; but they are the names of invisible entities.

Should he enter the underworld of one of our large cities he likewise would encounter an argot which he would find difficult to understand. One better informed could tell him that a “rod” means a pistol, that a “typewriter” means a machine gun, that a “dope” signifies a drug addict, and that one individual’s name is “Lefty” and another’s “Sleepy Joe”; the latter, perhaps, not as he might at first think, because the individual so known is drowsy by habit, but because of unusual ability to put those whom he robs to sleep with a deftly delivered blow from a black-jack.

What I am endeavoring to explain is that people on earth who follow questionable pursuits usually have a language somewhat apart from that employed in more straight-forward circles, by which they convey ideas to one another. To “take him for a ride” is an instruction they understand; but is quite different in meaning from that which the high-school girl conveys when she thus mentions transportation to her boy friend on a Sunday excursion. And people who follow illegal occupations also have the custom of calling each other by names other than those with which more upright people are familiar.

Let us suppose that someone having no previous contact with a criminal or a bootlegger is advised by a friend who knows more about such matters. He is given a telephone number to call, just as the practitioner of doubtful magic is given a seal, or diagram, such as are to be found in the books mentioned, and in other treatise on ceremonial magic.

In addition to a telephone number, when he makes the connection he is given the name of someone to ask for. So, around the magic circles, or inscribed on the seal, and also as a part of the conjuration, are names. These names mean very little to one unfamiliar with their argot import; but they are the names of invisible entities.

Then when the individual called by ‘phone makes response, he may want some assurance that the person calling him is not prompted by mere curiosity, but actually desires conversation with him on his own ground. So it is customary for those in illegal pursuits, when their aid is asked, either to furnish illicit drink or for some more serious crime, to demand some password, or symbol, of one making the request. If he gives this sign, whatever it may be, he is considered to be on the “inside”, and of a character safe to do business with. But if he does not know the secret sign of the gang with which he tries to deal, they tend to look upon him with suspicion, as an outsider. And thus it is that magic rings, seals, and diagrams have certain symbols traced upon them that are the badge of entrance into unhallowed groups.

Innocence Is No Protection

—Nor should we consider that the use of circles, signs, symbols, names, and incantations given in books on ceremonial magic are without danger to one who uses them under the belief he will contact some good noble angel.

If you have been given the telephone number of a bootlegger, and call that number while under the impression it is the telephone number of a college professor, your intention does not alter the result that it will be the bootlegger who answers the telephone. And if you have actually been given the name of the bootlegger, but have been told it is the name of the professor, when you speak that name it will be the bootlegger who acknowledges it, and not the professor.

Let us suppose, also, that you have been given a number of sentences in a language you do not understand, and that you repeat these sentences to the bootlegger under the impression that you are asking the professor to send you a book on the electronic structure of the atom. Yet in reality, though unknown to you, these phrases mean to the bootlegger, and are so used by his customers, that he is to deliver a dozen quarts of gin at midnight to your address, and that you will have the cash to pay on delivery. You may be sure that you will not get the electronic treatise, but that the gin will be delivered. Furthermore, under these circumstances, you will probably be rudely routed out of bed, and unless you have considerable cash with which you are willing to part for the gin, there will be trouble that night on your doorstep. The fact that you thought you were talking to a scholar and expected to receive a book does not prevent difficulty arising with the bootlegger.

He will feel that as you called him up, talked to him by name, and gave an order in the terms used by his other customers, that you should also pay as his other customers do. Even though he believes your excuse of ignorance, he has been too much trouble, and will not feel pleasant about it. He will demand some settlement of the account. And likewise those who dabble with ceremonial magic, using names, giving signs, and placing orders to be filled by invisible beings, are called to account, even though they think they are contacting highly benign beings.

In this matter of calling up astral entities for assistance, before illustrating how such calls are put through, even when the one making the call thinks he is calling a quite different type of character, the time element should be mentioned. The books on magic are quite explicit that certain positions of the moon must be observed, and suitable times of day or night, and the correct planetary hours used.

And this is quite logical, and true to fact. Whether you call up a college professor or a bootlegger, either probably has hours when he is accessible to call and other hours when he is not so easily reached. Even the gangsters of earth observe times when they can commonly be found in certain haunts, and other times when they sleep, are out on criminal business, at the home of a sweetheart, or otherwise so engaged as not easily to be reached. And we may be sure that entities of the astral plane are under somewhat similar conditions as regards to time. The astrological conditions, through their correspondences, indicate when it is easier to contact any such astral being.

Let us understand that names and symbols, such as are used in ceremonial magic on seals, circles, and other diagrams, have a definite vibratory rate. For that matter, any name or number has its own vibratory rate. But those names vibrate to the same key and frequency as does the astral entity whose aid is thus being invoked.

When we visualize a person intently, this automatically tends to raise or lower our own mental vibratory rate to the same frequency as the vibratory rate of the person. That is, thinking concentratedly about a person tends to tune in on his vibratory rate; and if the tuning in process is fairly complete it makes possible an exchange of energies with the person so thought about. Those who give absent treatments, some under one cult and some under another, nearly all recognize this process as requisite to obtaining satisfactory results.

When the appearance of the absent person is unknown, it is customary to touch some article—a pen, a handkerchief, a lock of hair—which has been worn by him, which carries his vibration. Through this article the vibratory rate of the one sending the thoughts is tuned in to the same vibratory rate as the person to be treated. And because it is a map of the astral body, nothing is more potent for this purpose than the birth-chart of the one to be reached.

These seals, circles, and written symbols which are said to represent certain spirits, are the names of astral entities, and diagrammatically portray the true nature of the entity to which each belongs. And one familiar with such diagrams, even though he has never seen a particular one before, can at once discern the character of the astral entity to which it belongs by the structure of the diagram.

For instance, the seals given in the Sixth Book of Moses show characters which are unsymmetrical. That is, they indicate forces that are distorted and inharmonious. Lines which seemingly should be entire, are at times broken, indicating the influence of the entity to break up and destroy. The symbol of the moon, when it is used, shows it as it appears in the decrease, and not as it appears while increasing in light, indicating that the entity possessing this astro-chart is disintegrative in character, and works to bring things about that are dark and evil. To anyone familiar with the language of universal symbolism it is quite plain that an astral entity whose vibratory rates correspond to any of these seals, or diagrams, could have no good influence, but is devoted solely to perversion, as shown by the twisted lines, and to injury, greed, passion, and destruction.

If you are a student of universal symbolism, a little examination of the characters used in these seals will convince you that they are the signatures of gangsters of the invisible world.

The individual who uses one of these seals in magical work tunes his own vibratory rate to that of the invisible evil being. He takes down the receiver of the astral telephone, calls up the number, as it were, of a head gangster, speaks his name over the telephone, and if he goes through with the formula of invocation, he asks the astral gangster to do some definite thing.

However, in the books of magic previously cited, and in other magical books and instructions, the magician is not content merely to call up the invisible entity and ask his help. Instead, he calls him on the 'phone, and conjures him. That is, he demands that certain things be done, and threatens him if he fails to do them. He conjures the astral entity in the name of certain powerful and terrible beings. He gets in touch with him, and at once starts to talk of coercion.

What would you think of an individual who had been given the telephone number of some powerful criminal ring, and called up the "big shot" of the gang and commenced to tell him to do certain things, and threatened to report him to the Chief of Police, to place before the District Attorney a full record of the gang's criminal activities, and to ask for an indictment by the Grand Jury unless the gang at once complied with these demands of blackmail?

To be sure, coercion is the language best understood, and most often employed, by the Lower-Pluto forces on both planes. One employing such tactics places himself thereby on the gangster vibratory level. He reveals himself to be driven by the common gangster motive, and trying to employ common gangster tactics. But if the individual thus giving orders to the gang were merely a private citizen actuated by greed or curiosity and without powerful backing, you would expect him to be missing in a few days. And even if he were a man of some intelligence and considerable backing, you would be quite certain that there would be some kind of fireworks. Not only so, but if the one making the demand were powerful enough to enforce it, you would be quite within the bounds of the probable to suppose that henceforth that gang would watch its opportunity to get revenge.

The idea I am trying to convey is that you cannot enlist the aid of criminals in advancing your own selfish ambitions, or even unselfish ambitions, without making connections that ultimately will prove highly dangerous. And this is quite as true of astral entities thus enlisted as of those that might be contacted on the earth.

To enlist the aid of a criminal, either he must be made to believe he will personally gain by the work he does, or he must be made to fear the consequences of not rendering the service asked.

Those Who Sell Themselves to the Devil

—Thus we have ample traditions of various individuals who, for a price, sold themselves to the devil. What they really did, of course, was to enter into some kind of agreement with an astral entity. Having opened their psychic faculties sufficiently to hold converse with, or at least to get impressions from the astral plane, they have agreed to do certain things in return for certain other things. The stipulation may have been that if they were given a certain amount of wealth to enjoy a certain number of years, at the end of that time, in return, they would become the servant of the astral entity and do his bidding, on this plane and in the next.

Such compacts are not mere figments of the imagination. Astral entities can be contacted. Some of them are intensely malicious, evil, and cunning. They can use an individual whom they get control of for many selfish purposes. They are keen to strike bargains. Perhaps they keep their part of the bargain, and perhaps they do not.

Sometimes the “big shot” gangster keeps his word with the simpleton whom he has entered into relations with, and sometimes he does not. But of this we may be confident; that the powerful criminal on either plane, when he makes an agreement, sees to it that he does not get the short end; and in so far as possible that the individual who joins forces with him, or who uses him for getting something, pays in full, and remains within the gangster’s power. In spite of the trite saying about honor among thieves, the facts, as shown by court records, indicate that commonly they do double-cross each other whenever it is to their advantage, and they think it safe to do so. Crooks on either plane strive for unfair advantages. That is why they are crooks.

For purposes of protection from the astral entities thus invoked, the books on magic, such as the Old Book of Magic, advise that with due ceremony a circle, or double circle be drawn about the magician who, while communicating with the astral being, stands within the circle, which astral entities are supposed to be unable to enter. In addition, certain implements are consecrated and used, such as a magic wand, sickle, robe, and what-not. By the use of the circle the magician is supposed to be immune from harm, and by means of the implements he is able to compel a reluctant spirit to do his bidding.

The idea is about the same as if an individual wished to compel the members of some criminal gang to do some dirty work for him, or even some work of a better character. He would go to the headquarters of the gang to enforce his demands, or he would have the gang leaders come to see him. But whether he went to them in an armored car, or they visited him in an armored room, he would keep himself behind steel walls thick enough to stop their bullets. There would be grills through which he could look, and carry on conversation. And he would keep at hand a proper arsenal of weapons, so that should these criminals refuse to do his bidding he could level a gun at them and compel them to do as he desired. The magic circle serves the purpose of an armored room, and the wand is used as if it were a pistol.

An individual who would thus summon and compel criminals might be foolish enough to believe that after he got what he wanted the criminal gang would forget all about the incident. He would therefore go about the common duties of life without armored protection, and with no side-arms or body guard. But if he were a wiser man in the ways of either physical or astral criminals, he would know that they would in time try to collect in full, and that if he, at any time subsequently, relaxed his vigilance, or strayed too far from adequate protection, he would be in great danger. His life, from this time on, would be under the threat of retaliation.

Nor is this merely figurative language. In the more than forty years I have devoted to occult matters it was inevitable that I should have brought to my attention, from time to time, those who practiced ceremonial magic of the black variety. Some of these individuals, for a time, wielded tremendous power; some, for a time, had much wealth; some, for a period, were able to draw to themselves, with irresistible force, those of the opposite sex.

But I have never known prosperity or selfish advancement gained from such a source to last. Invariably, those whom I have known who practiced such arts have had stark tragedy enter their lives. One still lives, but is serving a long term in the penitentiary. Another fell from a water tower, had almost every bone broken, yet lived to suffer terribly before his death from this accident. Still others I have known who became maimed and crippled for a time before death, or who suffered for years from some strange disease which finally was fatal. Tragical lives, all of them, in some respects, and usually ending in untimely and terrible deaths.

It is a noteworthy fact that those who enter the criminal gangs of earth often prosper for a few years. At times the rewards seem great. But it is very seldom that they prosper over a long period of years. Fully as many of them are killed, or otherwise disposed of, by members of their own, or of rival gangs, as suffer conviction in the courts. And astral entities of the criminal type—that is, such as are willing, or can be compelled, to work injustices, or to help another obtain a selfish advantage—seem to take comparatively as large a toll of those who join them, or fall into their clutches.

Enlisting Elementals

—The entities whose help may be obtained through ceremonies in which seals, circles, pentagrams and such charts of their astral nature are used, which I have so far considered, are those possessing full human intelligence. But even as on earth man has domesticated the cow, the horse, the goat, the pig, and other creatures to render him service; so among a certain class of magicians there is the attempt made to use nonhuman creatures of the astral plane in the performance of their work.

To take an unfair advantage of another, or to take to oneself an unjust share of what society produces, is the reverse from spiritual; and is no more evil because an invisible entity is employed to do it than if it were done at the point of a gun or by tricky bargaining. But the use of invisible intelligences for such purposes is far more dangerous.

The animals we use for domestic purposes on earth have been made tame through long generations of service. But the elementals of the astral world have not been so domesticated. They are wild yet; and such of them as can be called upon to render compulsory service in the attainment of selfish ends are apt to be fierce as wolves. Yet, by one skilled in such matters, they can be pressed into servitude; even as the part-wolf dogs of the North are trained to draw a sled. But these elementals, so drafted into the service of human beings, are more vicious than the worst sled dogs. And some such dogs will attack their driver if he stumbles or falls.

Yet once the contact is established with an elemental, even though it is dismissed with a proper magical formula, any one of a variety of otherwise not very significant conditions are sufficient to recall it. At the time of its return the clairvoyance of the magician may be at low ebb; for this return may be years later, even after the magician has lost interest

in such matters. He may be unaware that the savage creature has once again been attracted to him, and is lurking about, ready to work some dreadful injury upon him. He is quite unprepared, therefore, for its onslaught, and quite unable to fend it off, even if he is conscious of the cause of his terrible misfortune.

It is true that unusual and startling phenomena can be produced with the aid of elementals. And it is true that they can be invoked and sent on missions that successfully perform some work. But the hazard involved is out of all proportion to what thus can be accomplished.

For the accomplishment of white magic, that is, the kind that benefits society and is not grounded in some species of selfishness, there is no call consciously to invoke the aid of elementals, or other non-human entities. It may be that non-human entities will respond actively to the noble desire, and work energetically with the thought form sent out. But commonly the white magician will not know that they are so working, and certainly does not compel service from them. What they do in the interest of his idea thus sent forth, is done in a spirit of loving kindness. Fine thoughts and desires beget a sympathetic response on both planes. Elementals never need be invoked or commanded by the white magician in the performance of his work; for he does not desire to produce amazing physical manifestations, nor selfishly to advance some interest beneficial solely to himself.

White Magic

—For the purpose of benefitting or protecting another, the white magician may need to reinforce his will with the proper ceremonial practices. But he has no need for, and can receive no help from, either the gangster type of discarnate human beings that can be invoked by the aid of a seal, or for any elemental of the type that is savage enough that it must be invoked or compelled. The only elementals that can give him any real help are those sympathetically responsive to his thoughts, that spring to his aid voluntarily because of this sympathy, that do not need to be called, and of which he need take no cognizance.

The white magician never calls upon entities with which he is not completely familiar as to their nature and aims. He often uses prayers, but these prayers are directed to Deity, or to such saints as he believes in. That is, they are to intelligence's of a very high order. And even if the saint is a mythical one, nevertheless its name has been so thoroughly linked with definite holy qualities that the prayer offered it must be high in vibration, and exalted enough to penetrate above the lower astral spheres. That is, the thought of the saint, or holy name, tends to tune the individual offering it prayer to a level corresponding to the noble qualities attributed to it.

There may be individuals-departed loved ones, for instance-on whom, in stress, the individual may call for help. At a critical moment in his life many a child has been thus assisted by a departed parent. And such assistance asked, or rendered, is no more reprehensible than if both were still in the flesh. Under seance room conditions, of course, there is the chance of deception as to identity. But the person who has no such seance conditions, but needs help in some crisis of his life, and calls upon a loved one who has passed to the next plane, not infrequently receives needed advice or assistance.

On the inner plane, also, there are orders and brotherhoods whose characters are well known because of their representatives on earth. When need arises, the white magician does not hesitate to call upon the invisible representatives of such organizations for assistance; if the assistance desired is of the kind that comes within the province of the activities of such a brotherhood. That is, he feels free to call upon the invisible members of the brotherhood for the kind of help he would have no hesitancy in asking from members yet on the physical plane.

And in the performance of a task, or the attainment of some worthy end, he may enlist the aid of appropriate ceremony. In fact, internal energies are only directed at their maximum potency through the employment of some ceremony. But in seeking the aid of benign brethren of the inner plane, he uses no words of compulsion, no conjuration, no extravagant terms, no flattery, and no mysterious names. He asks of the invisible person the favor he wishes in very much the same words he would ask the same favor if the invisible one were a man still upon the earth. He asks earnestly, and gives his reason for asking; even as he would to one yet on earth. And as the being so addressed is supposed to be kindly disposed and quite just, he is not foolish enough to ask for something that deprives someone of what justly belongs to another, or which gives an unmerited advantage over someone else.

Brotherhoods and orders on earth usually have some insignia, symbol, or gesture by which they commonly are known. And this insignia may be used as a seal, and the symbol or gesture may be employed in making the contact with the brotherhood on the inner plane. It focuses the mind on the individual there is desire to reach. In a way of speaking, it puts through the telephone call. But no such sign, symbol, token, or insignia should ever be used unless the one using it is completely aware of its import and to whom it belongs.

He may be sure, of course, that the cross will assist him to contact Catholics on the inner plane, that the Compass and Square will put him in touch with Masonic brethren, and that the common lodge emblems of other organizations will be safe to use in making contact with their invisible members.

For magical work of much importance, either white or black, there is usually a preparatory period of considerable duration, in which, by fasting, chastity, rising at an early hour, and other strict obedience to a set routine, the magician puts himself in training to perform the contemplated work.

It is not infrequent for the performance of some magical process of high import, for the one who undertakes it to observe such a strict training for a period of six months preceding the final ceremony. During all this time he conducts every act of his life according to prescribed rules. He rises at a certain hour, offers up prayers of a given nature at certain intervals of each day, clothes himself in a certain type of robe, and enters a specially prepared room for an hour at a certain time each evening, where he goes through a prescribed ritual.

Then there are the instruments of his art that must be prepared according to a rigid formula. The robe which is to be worn at the final ceremony must be of a certain color, and composed of a certain material. It must be washed in clear running water for so many minutes on each of seven consecutive days, at a time ascertained from the position of the moon. A prayer, or mantram, then must be said over it, and it is then laid in a new cedar box, and it is not to be again touched until it is removed to be worn at the final ceremony. The wand, of course must be witch-hazel, cut at midnight of the Full Moon. And it must be consecrated at a later date, with due ceremony, at midnight of another Full Moon. Then it likewise must be placed in a specially prepared receptacle to await the time of the final ceremony.

Then there is the wooden sword to get ready, and the bowl, and whatever other implements that shall be required. And each of them must be prepared in a very special and painstaking manner, and carefully guarded from human touch until the time they are to be used in the great magical process.

The room in which the final ceremony is to take place must be purified thoroughly. Fumigating with a good disinfectant is a good way to start this; to be followed by a thorough scrubbing with soap and water. Then incense may be used to place it still more in tune with the ultimate purpose. And if a table is to be required in the process, it should be made specially of new pine, and appropriately consecrated.

Because things can be magnetized, and because certain times of the moon conduce to receptivity of an article in the taking and retaining of both human magnetism and thought-impressions, these procedures are not superstition. That is, they do contribute to results.

But the most important function performed by such a strict and undeviating routine of procedure is fully to concentrate all the internal energies and direct them completely into the task to be accomplished.

Ritual

—To the extent there are devotional exercises in connection with the preparatory rites, or that otherwise through the process the emotions are aroused, the additional function of contributing energy also is performed. To the ordinary individual the going to a distant patch of timber at midnight in the cold weather of January (so that the Moon is in Cancer when it is full, and thus directly overhead in its most potent sign) and cutting a witchhazel switch, is not without some emotional accompaniments. And if, for a period of months, the individual must kneel at three different and specified times a day, facing in a certain direction each time, and repeating a mantram or prayer of specific import, he will no doubt feel rather intently about the matter; and it is feeling which furnishes magical energy.

To the extent, therefore, that the preparatory process, and the final ceremony afford stimuli to the emotions, they give energy that may be used in the performance of the work at hand. But the chief function of long and painstaking preparatory periods is to direct all the available energy into the desirable channel of work.

Every act performed according to the ritual focuses the attention of the unconscious mind upon what it is expected to do. It not only concentrates the inner attention upon the work to be done, but through repetition and symbolic acts it builds up a powerful faith in the unconscious mind that the thing actually will become an accomplished fact. It is the application of suggestion in its most powerful form.

Every act of the preparatory period, performed according to the predetermined schedule, drives home into the unconscious mind that a certain result is going to be obtained at a certain hour on a certain day in the future. The suggestion is driven home not merely from one angle, but from a dozen different quarters. Each implement constructed, and each ceremony of consecration, hammers home the suggestion in a little different way.

The result is that if the formula has been rigidly followed, and no relaxation of discipline allowed during the period of preparation, the magician enters upon the final rite with all the energy of his inner being concentrated to give a terrific impact toward the magical accomplishment of the work he has planned. Consequently, he is able to do what under normal circumstances would be quite impossible.

Inner-Plane Activities Are Essential

—The physical brain has very little power to handle the electromagnetic energies which make magical processes of any kind possible. Cerebral concentration tends to generate electrical frequencies which are not suitable for either inner-plane activities or the production of psychical phenomena. For use in white magic, the electrical frequencies generated by the nervous system while the mind is in a state of exaltation are most suitable. These not only tune the individual in on inner-plane levels which are spiritual and constructive in character, but they readily become converted into inner-plane energies which permit the soul to become highly active on the inner plane.

The work accomplished by magical procedure always first brings about some change on the inner plane. And to bring about this change the soul, or as it more commonly is referred to, the unconscious mind, or subjective mind, needs to be active on the inner plane. If its attention is glued to physical interests through continuing its habitual thoughts about them, it is unlikely to be active enough on the inner plane to direct the energies furnished it to bringing about the inner-plane changes necessary for the results desired.

For changing the inner-plane pattern of a physical thing or condition, it is highly advantageous that cerebral thinking cease and that the soul abandon its close attachment to the physical and move out on the inner plane to do its work. When the inner-plane pattern of the physical thing or condition has thus been changed, or the inner-plane trend of its movement, this in turn exercises extra-physical power upon the thing or condition to the extent there is electromagnetic energy available for that purpose.

Without being aware of the exact process employed, mental and spiritual healers make use of this process. And the thought-cells within each of us employ the same principle to attract into our lives events characteristic of the planets and houses of the birth-chart involved when progressed aspects form to planets in our horoscopes.

All of which may seem so amazing to those who have been grounded in the traditions of material science that it may be well here to indicate where indisputable proof can now be found that physical objects can, and are, influenced by just such nonphysical energies, which university men term the Psychokinetic Effect. Ceremonial and all other magic depends upon this Psychokinetic Effect.

Coincident with the experiments conducted since 1934 at Duke University on extra-sensory perception, other experiments were conducted there in great volume on what is called the Psychokinetic Effect. The first report on these exhaustive experiments was made in the March 1943, issue of *The Journal of Parapsychology*.

The experiments as conducted were to determine if by mental power alone Hand-Thrown and Mechanically-Released dice could be influenced in a predetermined way. The conclusion of the article starts with this sentence:

“At the end of the first PK report, we have to conclude that we know of no better explanation for the result of the tests in dice-throwing herein described than that of the PK hypothesis; i. e., that the subject influenced the fall of the dice without the aid of any recognized physical contact with them.”

Each issue of The Journal of Parapsychology since has contained further reports and statistical analyses on tests of the Psychokinetic Effect, and the March 1944, number of this Journal issued by Duke University Press in the first three paragraphs states:

“The issue of the PK hypothesis can be decided within the scope of a single article. We refer to the paper on the quarter distribution (QD) in this issue.

“This abrupt departure from the earlier position is due to the fact that a superior order of evidence has been found which was not known at the time of the first report. In the analysis for the QD there have emerged evidences of Lawfulness in hit patterns throughout so large a portion of the available experimental data that all reasonable doubt of the validity of the PK hypothesis has, we maintain, disappeared, and all counter-hypotheses seem to us manifestly out of the picture.

“These statements are, we recognize, very strong, and they must seem to the reader who has not yet read the QD report very bold ones; but they are made with due deliberation and with what we regard as good reason.”

Chapter 4

Serial No. 186
Original Copyright 1945
Elbert Benjamine

Copyright
August 2002
Church of Light

Sorcery and Witchcraft

Chapter 4



Sorcery And Witchcraft

In considering sorcery and witchcraft we leave behind the domain of white magic and gray magic; for sorcery implies the aid of evil spirits, and witchcraft is a type of the black art. Nor do we approach these subjects for the purpose of instructing anyone in these nefarious practices. Instead, let us hope to become so familiar with the processes and principles involved that there will be no more inclination to dabble in such dark matters than there is to fondle a mad dog; and at the same time, through such understanding, let us become immune to injury and free from any fear of them.

In evil magic of this kind the three elements mentioned in connection with ceremonial magic are present. Ceremony, of a nature appropriate to the purpose is nearly always present. Some method of directing the attention to the purpose to be accomplished is commonly used. And usually entities of the astral plane are contacted and their assistance procured in the work to be accomplished.

Sorcery and witchcraft can hardly be set entirely apart from other ceremonial magic by drawing a strict line of demarcation; but in one respect, at least, they present a contrast to ordinary magical processes. This is the great accentuation of the emotional element, by which energy is generated and directed into channels of evil. For the purpose of arousing the emotions to the highest possible activity, the most horrible rites are conducted, the most frightful excesses encouraged, and the most terrible practices are followed.

Because emotion generates and liberates electromagnetic energy that can be used magically, and because the type of electromagnetic energy used in black magic has need of great volume and low-frequency, those who practice the black art exhaust every possible avenue by which the emotions can be increased to a pitch of frenzy. Revolting deeds, crimes which are usually repugnant, actions which engender horror; everything is made use of that is terrifying. Anything they are capable of imagining which is against decency and the welfare of society is employed in the effort to arouse the emotions sufficiently to produce diabolical phenomena or to injure others.

Emotions, as analytical psychologists have discovered, are ambivalent. That is, an emotion and its opposite are closely linked together. Hate and love, courage and fear, and so on. Thus in affectional matters, it is not infrequent to find people who at first violently hate each other, to end by violently falling in love. And people who have been violently in love and who become enemies, often hate quite as energetically. The coward, also, when he is cornered, may convert his fear into desperate courage. And thus it is, also, that religious aspirations, under certain circumstances, are given an inversive trend, and the individual delights and thrills in the perverse, the wicked, the evil and the horrible, quite as thoroughly as he might have enjoyed high ecstasy had his energies been directed into a truly spiritual channel.

Considering that it is not pleasant emotion, nor socially acceptable emotion, that is desired for black magic, but merely volume of emotion, the more destructive in quality the better, do you think the Congo initiation of a sorcerer, as described by Dean R. Allier, is sufficiently arousing?

“In the Congo, the initiation of sorcerers gives occasion for horrible scenes. Among other tests the candidate is compelled to make a human sacrifice, the victim chosen from among his nearest relatives, usually his mother or his eldest daughter, and being immolated upon the stalk of euphorbium, a small tree from which flows a sap which is viscous and narcotic. When arteries and veins are emptied, and the victim’s last struggles have ceased, sap and blood are mingled together; the neophyte drinks the sap, then in turn those present do likewise, until the body is entirely drained of its blood. It is then placed on a pyre, is slowly roasted, and is then divided into as many portions as there are participants in the rites, generally twelve. The flesh is at once devoured, the bones being carefully set aside; again they are placed upon the pyre and left there until they are almost charred; then they are once more removed and divided into twelve parts. All evidences of the hideous feast are carefully removed and the participants all return to the village. These bones, ground in fine powder, will later be used in the preparation of powerful charms.

“As a final test, the corpse of a female, or a man-prisoner, or of a stolen child, is bound to the neophyte sorcerer, breast to breast, head to head, mouth to mouth, and the two bodies are hastily lowered to the bottom of a ditch, which is then covered with branches. During three whole days, the neophyte remains in that position; sometimes he becomes insane before the expiration of the time! Then there succeed three days of trial during the course of which, in his hut, but ever bound to the corpse which is now putrefying, he may neither eat nor drink without making use of the corpse’s right hand.

“After six days, the test having been ended, the initiate is removed from the corpse and washed with lustral water; his entire body is painted with red powder and oil (baza), and in a clearing of the forest, he performs a sacred dance. The body is brought to him. With a knife employed in initiation he cuts off the corpse’s hand at the wrist and, seizing it, performs another dance. The hand is put to dry, to be used by him henceforth in certain magic practices. It will be a powerful fetish.”

There is a wide literature upon the practices of sorcerers; but the above single quotation serves my purpose of drawing attention to the common practice among primitive sorcerers of doing the most horrifying things they can imagine. Dancing on the graves of the dead, and defilement of every variety, is thus employed. The end attained is a terrific and perverse emotion, which generates electromagnetic energy for their purpose.

Everyone, at least by mention, is familiar with the outbreak of witchcraft at Salem, Massachusetts. In the abstract of the laws of New England printed in 1655 appears this article: "III. Witchcraft, which is fellowship by covenant with a familiar spirit, to be punished with death." The earliest execution for witchcraft in the U. S. appears to have been still earlier, in 1648. In the Salem epidemic of witchcraft, 1691-1692, in which Cotton Mather became so energetic as a witch finder, nineteen persons were executed for witchcraft, Giles Cory, who refused to plead, being the only person in America who legally was tortured to death. In 1692, fifty persons were tried for witchcraft, but only three were convicted, and these three were later pardoned by the governor.

The Salem epidemic of witchcraft, while the most notable outbreak in America, is not an isolated example, but represents a condition that frequently occurred in Europe all through the dark ages. In France the clergy obtained drastic laws, such that public rumor, or the accusation of a single witness, was sufficient to cause the suspected witch to be subjected to torture, the legislative power for witchcraft being given solely to the Church.

Under authority of an act of Parliament, which was passed in 1281, Nicholas Remigius burned 900 persons in Lorraine; in less than six weeks the Bishop of Geneva burned 700 victims in 1596, earlier in the same century Grillandu, the inquisitor of Arezzo, admitted over 2,000 victims, and Sprenger and Pierre de Lancre were responsible for other thousands of deaths of those charged with witchcraft. Between 1320 and 1350, four hundred witches were put to death in the city of Carcassonne; in 1485, 85 witches were burned at the stake in the district of Worms. Also in Germany we find in 1659 there were 900 victims in the diocese of Wurtburg, 600 in the bishopric of Bamberg, and that children from one to six years of age were included among those burned.

These are a few instances cited from the many, merely to indicate the prevalence of witch persecution at that time. But before proceeding to explain the cause of these manifestations, and the principles involved in the crime of witchcraft, it should be mentioned that in addition to the evil influence these witches were reputed to exercise upon others, there were two other standard characteristics.

It was generally believed that a witch had entered into a compact with the devil. It was also believed that in witness of this pact Satan placed his brand upon the skin of his new subject. Thus in the trials it was not uncommon to search for this devil's mark. For example, at the trial of Elise Guyon, March 11, 1660, the master executioner was ordered to examine her whole body before putting her to torture. On

March 13, Jacob Fleurdelys, the executioner, as a result of this examination, found “at a certain point below the back, a mark like a little scar, in the middle of which could be seen a little black point, into which having thrust a pin, the accused felt nothing, and the executioner having withdrawn it, there followed it neither blood nor water.”

It was still further believed that witches commonly, and rather regularly, went to a certain meeting place, riding through the air, perhaps on a broomstick, to take part in a diabolical orgy, called the sabbat. This witches, sabbat was as horrible and revolting as a tortured imagination could make it, a very curtailed description being sufficient to show its general nature:

“It is not enough for the women to rush into such devilish practices; into them they must also drag their children. One can divine the growth of a forbidden emotion when it is thus allowed to defile innocence! The little beings are presented to the Devil, who rebaptizes them in his own way and brands them with his claw or horn. As the novices are as yet unable to participate in the essential rites, they mind the toads. On occasion they will be incited to incestuous unions.

“Orgies and the most shameless libertinage are thus given free rein in the sabbat. Now frightful devils dressed in blue, wearing caps surmounted with cock feathers, give themselves over to acts which may be guessed; now sorcerers and witches satisfy without the least scruple, their lubricity. According to the testimony of one of these victims of hallucinations, finally they perform a dance two by two with interchange of couples.

“As Satan is determined above all things to justify his title of King of Evil, often in the sabbat he, or those affiliated with him, not content to excite their adepts against wretched human beings, command them to trouble the elements and to unchain storms, which bring ruin and devastation upon the fields. One of these witches says that whenever she went to the Goutte Benoist near a spring, or assembled the people of Etobon and of the neighboring villages, their masters the devils would force them to beat the waters with white clubs, pronouncing the words: Hail! Hail! come and fall upon the woods or the seeds! Then there formed a sort of vapor which rose in the air and fell again as hail.”

The Birth of Modern Spiritualism

—That witches are not more prevalent today is largely due to the better understanding of psychical phenomena which followed the birth of modern spiritualism in 1848. In all ages and in all climes there have been many individuals whose nervous systems generated an excess of low-frequency electro-magnetic energy which could be used by astral plane entities to produce phenomena of a physical nature. In earlier times these individuals either were witches, or innocent of any wrong were branded as witches. Now they become mediums.

The Neptune period of the Piscean Age commenced with the discovery of Neptune in 1846. In 1843 and 1844 a Mr. and Mrs. John C. Bell lived in a house in Hydesville, New York. One day a peddler called, the next day Mrs. Bell and her servant girl left for a visit, leaving the peddler and Mr. Bell alone in the house. No one ever saw the peddler again.

In 1846—the year Neptune, the psychic planet was discovered—Mr. and Mrs. Weekman took the house, but were so constantly disturbed by mysterious knocking and rappings that they moved in 1847. The house was next taken on December 11, 1847, by Mr. and Mrs. John Fox. They had two daughters, Kate, aged twelve, and Margaretta, aged fifteen. The rappings heard by the Weekmans continued.

Every effort was made to discover what caused the rapping, and on Friday, March 31, 1848—which date I suppose may be considered the birth of modern spiritualism—Kate Fox found out that whatever made the noises could see and answer questions. A man by the name of Isaac Post thought that by means of a code alphabet it might be possible to talk with the entity responsible for the haunting, and devised such a method. The entity claimed to be the spirit of the peddler. He gave many details of his life, and said he had been murdered for \$500 and buried in the cellar.

His rapped out accounts caused quite a furor in the community; and there was much digging in the cellar. No skeleton was found, although some human bones and some quicklime were unearthed.

While the importance of these events relates to the commencement of a new religion—Spiritualism—they also have an interesting sequel. Over half a century later—in 1904—a false wall which had been built across the cellar a few feet from the true east wall partly tumbled down, and behind this false wall the existence of which the diggers in 1848 had not suspected, the skeleton of a man and a peddler's pack were found. Whatever had done the haunting, even if it could not reveal the false wall, knew the body of the peddler had been placed in the cellar.

After the unsuccessful digging in the cellar in 1848, interest in what might have happened to the peddler at once gave way to wonderment that in the presence of Kate Fox raps gave answers to questions. Men of science were called in to investigate the raps. They pronounced them genuine; and were attacked in the press by skeptics. Kate Fox began to give seances for money, and following all this publicity, mediums who professed to give messages from those who were no longer of earth began to spring up everywhere.

Those capable of generating low-frequency electromagnetic energies had at all times been present, but the idea of a person being a medium for the transmission of messages or forces from the next plane of life, as that term is now understood, was quite foreign to earlier days. From the time of the Witch of Endor, whom Saul consulted, those who had converse with the unseen world, or through whom the invisible world was able to exert its influence upon the physical world, down to the time of the Fox sisters, were looked upon solely as agents of the devil.

The Church decreed that any communication from other than physical sources that was spiritual and constructive in character could only come through it. Any other communication from, or manifestation of, any entity not of the earth, and any manifestation of supernatural power outside the sacred precincts of the Church, came from the devil. And the individual or individuals responsible for it must be ferreted out at any cost, and must die a horrible death.

Today in America there are many thousands of natural mediums, and thousands of others who have become such through training. Also, because of their peculiar negativeness, supernatural phenomena sometimes takes place as records from all parts of the world show-in the presence of certain children. Course I, THE LAWS OF OCCULTISM, describes the various types, and explains the cause, of such phenomena. Here I merely wish to point out that they do take place, even when the natural medium has no notion of the fact that he is a medium.

We should face what obviously is the fact; that the Church alone is entirely responsible for the various epidemics of witchcraft that once took place in Europe and America. Cotton Mather, in the early days of New England, I feel convinced, was chiefly responsible for the Salem outbreak. His furious diatribes against it kept the minds of people focused on it, and directed the trend of what otherwise would have been harmless mediumship into questionable channels. The furor he created helped it to spread. There have always been what now are known as spirit mediums; but the Church condemned each and every one of them. The Church persecuted them, and branded everything that came through them as a manifestation of the devil.

These mediums of yesterday were essentially no different from the mediums of today; but unlike mediums of today the only explanation of the phenomena that manifested through them was that offered by the Church; that it came from the devil. Mediums are the most suggestible class of people in the world. And the suggestion had been hammered into their minds from childhood by Church teachings, and by all their associates, that any supernatural phenomena were from the King of Evil.

What more natural then, when such strange phenomena began to manifest as is now the rather common experience of mediums, that they, as well as their associates, should attribute it to the devil. And fear that they had thus lost their souls, in some incomprehensible manner, riveted their minds to this conviction. They were thus set apart from the balance of mankind by the possession of strange powers that, because of their religious teachings, they believed could only come from the evil one. There could be no doubt about it in their minds; they, for some inexplicable reason, were eternally damned.

Believing this centered their minds the more firmly on the devil and hell. And a medium with his mind thus occupied quite quickly does "tune in" on the actual astral hells. Or, if he is an individual preoccupied with wicked desires, he likewise easily "tunes in" on the slums and iniquitous dens of the invisible world.

The wicked individual could attract nothing higher to him than wicked entities. And the really innocent and well-meaning medium, under the Church teaching that all such communications and influences came from the devil, had his thoughts so centered on evil entities and regions that he could contact nothing else. His imagination, fevered by Church doctrines, pictured devils and obnoxious regions so strongly that he of necessity attracted them.

On the high-velocity inner plane the principle of resonance supercedes that which on the low-velocity outer plane we call gravitation. The soul of the individual always moves to the basic vibratory level of the inner plane which has the frequency of its own dominant vibratory rate. Regardless of the material locality of his physical body, the soul, the real individual, lives on the astral level to which it has adjusted its dominant vibrations. These dominant vibrations are determined by the habitual mood.

The thought of the individual that he is eternally damned, that he is an outcast, and is unutterably evil, develops a feeling that so lowers his dominant vibrations that his soul moves to, and lives on, a level which supports the so-called astral hells.

Furthermore, intently thinking of something or someone on the vibratory level where the soul functions, brings the soul, through the principle of resonance, into contact with the thing or person thought about. Due to one of the most outstanding properties of inner-plane existence, if a person thinks persistently about the devil, or about all manner of evil, his soul will be brought into contact with evil entities. And if at the same time he is mediumistic, these evil entities will take control of him, and may perform much mischief.

The same mediumistic individual, if his mind had been directed to thinking about saints, might very well, through the feeling of exaltation induced, have moved his consciousness and soul to function on a high basic level of the inner plane, and might have contacted benign intelligences that would have assisted him in healing the sick, and in performing other works quite beneficial to mankind.

But before the advent of modern spiritualism, the Church so insisted that outside its precincts nothing supernatural could be contacted other than the devil, that those who contacted inner-plane entities of any kind through what is now recognized as extra-sensory perception were easily convinced that because of such contacts, which they often were unable to prevent, they were unutterably evil and forever damned.

Now if some naive individual should visit the slums of earth while under the impression that he had lost all moral responsibility; and under the belief that he could gain the things he wished by making some kind of an agreement with a gangster or crook thus contacted; he would find little difficulty in finding someone to make such an agreement with, if he offered sufficient service in return. And the poor, innocent

medium of days gone by, who imagined he had lost his soul anyway—because the Church said so—and who had been taught by that same Church that it was possible for a man to gain in material things by forming a compact with the devil, had no great difficulty in contacting some being from the astral slums who assumed the role of devil and sealed such a bargain.

Because there are beings who have passed to the next life who are quite as cunning, evil, and destructively inclined as any remaining yet on earth, the individual who trains his mind on such entities is quite sure to make the contact, and if, at the same time, he is an irresponsible medium, this entity will probably be able to obsess him and compel him to acts of which he otherwise never would even think.

Today the followers of modern spiritualism select certain meeting places where they congregate and hold seances. Even today it is not uncommon—although protected by a State Spiritualistic Church Charter—for a seance room where materializations are held to be raided by the police. The mediums producing the most amazing phenomena are still subject to considerable persecution by those in authority. And in the days before spiritualism became recognized as such, all those attending a seance were in danger of death by torture at the hand of the emissaries of the Church.

The Witches' Sabbat

—It is not strange, there fore—knowing that many people who now attend seances do so only in secret for fear of public condemnation—that those of an earlier day who were familiar with such phenomena should hold their meetings in secret. Their lives depended on keeping their activities from the knowledge of the Church. Mediums were then called witches, and their seances were called sabbats.

But because of Church doctrines they believed they were working under the auspices of the devil. At these seances, therefore, they contacted no influence of good and light, but only such dark and perverse creatures as were called to them by their terror stricken imaginations. These mediums, like those today who develop the disintegrative forms of mediumship, had no power to resist forces from the inner plane who desired to debauch them. We can well imagine, then, from what we know of present-day irresponsible mediums who have lost their wills and their characters through permitting complete control by low entities, that these seances, held in the olden days by such mediums under the control of debased invisible entities, were obscene, revolting and terrible in every way.

No doubt, to some of these seances thus held, these benighted mediums of old sojourned in their physical bodies. But mediums at the present day who go into the trance state are not confined to their physical bodies and the earth. They can leave the physical and travel through space to regions of the astral realm. And in making such a journey either to a distant locality on earth, or to some place of congregation in the astral world, the sensation is not that of walking, but more nearly that of flying.

It seems probable, then, that all cases of witches flying through the atmosphere to their place, were either actual instances of astral travel, or were merely imaginary journeys of those who entered a trance-like condition. Yet because it is well attested that people at the present day can and do visit distant places on earth in their astral bodies and there manifest their presence; and because it is not uncommon for those advanced in occult matters, as well as those who are negative mediums, to travel to localities on the astral plane in their astral bodies, we can assume that the witches of medieval times also had the same power, and actually visited the sabbat, either on the physical plane or on the astral plane, as the case called for, in their astral bodies, and there took part in its iniquitous ceremonies.

The Witches' Ointment

—As additional testimony to this probability, we know that certain drugs have the power to release the astral body from the physical. People, for instance, while under the influence of anesthetics, sometimes leave their bodies and go elsewhere, and are able to recount what they there saw when they regain consciousness. And one of the traditions that persists about witchcraft, and which has been commemorated in various famous paintings of witches, is that it was common practice for them to anoint their bodies with an unguent, which enabled them to travel through the air to the sabbat.

What really happened, no doubt, was that the drug thus applied caused them to lose physical consciousness and enabled them to travel to the desired spot in their astral bodies. When they returned to their physical bodies they retained a memory of all they had done at the sabbat, as well as the aerial journey to it. But quite likely they were not aware that their physical bodies had been left behind, as they had no knowledge of any other body, and they had appeared in a body at the sabbat.

The Church Was Responsible For Most Witches

—The Church had branded all mediums as lost souls, and they had no information with which to contradict this doctrine. The Church and the populace related that witches at certain appointed times had the custom of attending a meeting presided over by the devil. The medium, already believing her soul to be lost because of the supernormal phenomena so expressly forbidden by the Church, felt attracted to others of her kind. These she was able perhaps to contact physically, who instructed her in the . Or if they were not thus contacted, the suggestion was sufficient that when she went into trance she traveled to such a meeting place. And you may be sure, having heard the details of such diabolical meetings since childhood, that she was attracted by the very power of the images in her mind to just such a place in the astral region.

Furthermore, if anyone is so insane as to wish to visit such scenes as are described in accounts of the sabbat, you may be sure, if he gets out of the body, that he can still attend them. In the hells and slums of the lower astral spheres, there still exist almost any terrible condition that can be imagined. But because people who are mediumistic now nearly all know that the invisible world is divided into realms of comparative darkness and light, of evil and of good, of bestiality and spirituality; when mediums, or occult neophytes, leave their bodies for visits to the astral plane, they have their minds fixed on brighter realms, and take as much pains to avoid the astral slums as they would to avoid a den of venomous serpents.

There is another feature of the modern seance room which offers an adequate explanation also of the epidemic nature of witchcraft outbreaks. This is the developing circle. That is, those who have little mediumistic ability, by associating with mediums and attending circles devoted to supernormal manifestations, develop that ability. Furthermore, the constant thinking about such phenomena tends to attract invisible entities, and hastens to develop whatever latent quality is present. And in particular fear, because fear is so negative an emotion, quicker than any other attitude, tends to break down the power of resistance to any encroaching force and place the individual in its power and control.

So we find many historical cases in which witchcraft swept a whole village, so that most of the women and children were possessed. And in particular were such outbreaks more frequent in religious communities and convents. In religious communities, the suggestions of the Church that all supernormal phenomena indicated a compact with the devil were highly forceful. In convents, the suppression of natural functions by confinement and abstinence encouraged every variety of psychical disorder.

In such convents, occasions arose in which, one nun being seized by convulsions, and accusing some priest of casting a spell over her, the contagion spread to all the nuns in the institution. In the rather famous case of Urban Grandier, for instance, who committed indiscretions with one nun; all the other nuns were possessed with convulsions. And they all accused the unfortunate priest of sorcery. Perhaps the unnatural conditions of his life did cause him to endeavor to gain satisfaction for suppressed desires through magical means. But nothing was ever proved against him. Nevertheless, he was tortured horribly, and later burnt at the stake.

A village swept by an epidemic of witchcraft, that is, by a wide development of mediumship directed into perverse channels through Church teachings, was Mohra in Sweden. This case was examined in all its details by the legal authorities in 1669-1670, and the records enter into all its phases; investigating where the sabbat was held, the diabolical rites which were there performed, and the evil which these witches promised to do to other persons.

As was common to those initiated into the sabbat, the neophytes were baptized, this time by priests of the devil, confirming this new baptism with fearful oaths and imprecations. They were required to write their names in their own blood in the devil's book, and to do various things which plainly were the inverse of Church ritual. This is the common practice of those devoted to the destructive principle; they invert all constructive practices. Thus we have the traditions of the Black Mass, of prayers said backward, and of every manner of perversion. As to the manner in which these misdirected epidemics of mediumship were handled, a short quotation from the investigation at Hohra is enlightening:

“On the fourteenth of August the Commissioners met again consulting how they might withstand this dangerous flood. After long deliberation, an order coming also from His Majesty they did resolve to execute such as the matter of fact could be proved upon examination being made. For there were discovered no less than three score and ten in the village aforesaid, three and twenty of which freely confessed their crimes and were condemned to die. The rest, one pretending that she was with child and the other denying and pleading, were sent to Fahluma where most of them were afterwards executed.

“Fifteen children who likewise confessed that they were engaged in this witchery died as the rest. Six and thirty of them between nine and sixteen years of age who had been less guilty were forced to run the gauntlet; twenty more had no great inclination and yet had been seduced to those hellish enterprises, because they were very young were condemned to be lashed with rods upon their hands for three Sundays together at the church door, and the aforesaid six and thirty were also deemed to be lashed in this way once a week for a whole year The number of seduced children was about three hundred. The examination was conducted as follows:

“First the commissioners and the neighboring justices went to Prayers; this done the witches, who had most of them children with them which they either had seduced or attempted to seduce, were set before them. Some of the children complained lamentably of the misery and mischief they were thus forced to suffer sometimes of the witches. The children being asked if they were sure of being at any time carried away by the devil, they all declared that they were begging from the commissioners that they might be freed from that intolerable yoke.”

The inclusion of children even younger than those mentioned in this instance, I believe, is sufficient evidence that many witches were not persons unusually selfish, or unusually wicked in character. They were merely people of average morals in whom, either naturally, or because of contact with other mediums, was exhibited the phenomena nowadays common to private and professional mediums. But because of the attitude of the Church, they were driven to consort with entities on the inner plane, who actually were wicked. The appalling ignorance concerning the inner plane and the next life, left them no alternative but to become affiliated with entities who were enemies of society. The Church thus drove them into a life of debauchery and wickedness.

But, without doubt, there were others in those days, just as there are at present, who were unusually selfish, wicked and cruel by nature, who voluntarily turned to sorcery and witchcraft in the premeditated attempt to gain power and wealth, or for the purpose of satisfying lust and wreaking vengeance upon enemies. We may be sure such then existed, for we find their counterparts in the sorcerers and black-art fraternities of present-day uncivilized tribes.

Yet whether the individual was wickedly inclined to start with or not, knowing himself ostracized from the society of normal persons by reason of his occult practices, for the purpose of self-preservation he allied himself with others who also were similarly ostracized. Today if a man unwittingly commits a crime for which the law demands his life, even though he is not naturally criminally inclined, he is very apt to ally himself with some existing criminal organization the better to escape punishment. And once having joined such a band, and taken oath of allegiance thereto, the band is in a position to compel him to actual criminal activities. Should he refuse to do so he would instantly be under suspicion, and subject to punishment from them, or exposure. It is common knowledge how almost impossible it is even in our present so-called civilization for one who is a criminal, or even a member of a criminal gang, ever afterwards to go straight.

Thus it is that those who in innocence become affiliated with fraternities of sorcerers, or who attend the witches, sabbat, continue loyal to these gangs of the slums of the invisible world, participate in their debaucheries, and aid in their crimes. They do so for the fundamental purpose of self-preservation. And in such instances as the belief in the mark of the devil is strong, there is as much reason to believe that some such mark does appear upon the bodies as there is to believe that stigmata appeared, as is well attested, on the bodies of some of the medieval saints. One familiar with phenomenal mediumship in its more startling form, as exhibited by certain public mediums, will find no difficulty in believing that through such agencies a mark might be placed upon the body of the medium.

Debaucheries of the Sabbat

—The debaucheries which are described as attendant upon the sabbat no doubt served somewhat in the gratification of unhallowed desires. Even criminal gangs on earth have their wild parties. But they served also a magical purpose; for magical phenomena of any kind depend upon the energy available, and such terrible carousals and horrible practices could not fail to cause shudders, to set up powerful emotional revulsions, and to drain the mind and nervous system of its last reserve of emotional intensity. And the energy thus liberated in frenzy, if directed concentratedly by means of an appropriate ceremony which kept the unconscious mind fixed upon the thing to be accomplished, would have a powerful leverage for the production of low-grade, or criminal, physical phenomena.

The initiatory rites of the sorcerer, in which he is driven almost insane of horror, serve a similar purpose, as well as cementing, through a common crime, his bond of fealty to the sorcerer band. One passing through such an experience, or attending the sabbat, undergoes a change, and is never the same afterwards. Henceforth, the emotions are easily aroused to a pitch of intense excitement. Witches, according to tradition, when they pronounce curses, are worked up to a point where they are crazed with wrath.

The priests of certain oriental religions apply the same principles in a much milder way. They keep dancing girls, not to satisfy their lascivious inclinations; but through the contortions of their dancing to arouse the priests to a high degree of passion; the intensity of emotion thus engendered being used by the priests in the performance, not of injury to others, but of such magical phenomena as will awe the multitude and serve the ends of the temple.

As to the manner in which sorcerers injure others there is a wide literature available. The chief method is through sympathetic magic. That is, a miniature image of the enemy to be disconcerted is made, and the injury is performed upon this miniature image; the affliction thus being thought to register upon the astral body of the one attacked. In one region of Africa, as an instance of another type of sympathetic magic, the sorcerer follows the one to be injured and drives thorns in the tracks his feet have left in the dust. The one so to be afflicted is supposed to suffer as if the thorns were actually driven into his feet. And, as the sorcerer after a time lets it be known what he is doing, the one so attacked, in his fright, no doubt soon does begin to feel pain.

Black Magic Feeds Upon Fear

—For, after all, the greatest aid black magic has ever had, and upon which it must rely in great measure for its effectiveness, is the fear of its victim. Take, for instance, the regions of America and Africa where voodooism is most prevalent. The white man, because he does not believe in it, and therefore has no fear of it, is seldom harmed by such practices. But in the same vicinity it may be very common for Negroes, who believe in and fear it, to be its victims.

If I were to say that society has no cause to consider that it may occasionally be injured by an evil sorcerer, I should have to claim also that society is free from injury from the professional criminal. If I were to say that magicians are not banded together for mutual advantage and protection on the inner plane, I should have to say that criminals are too ignorant to organize into efficient groups.

But as a matter of fact, criminals on both planes often organize into bands. And those of the inner plane are quite willing to impersonate the devil if they can dupe some unfortunate of earth into signing a compact with them; for, of course, a personal devil is a myth. It is merely the personification of the force of destruction and disintegration. But there are actual entities on both planes whose hands are against society, whose efforts are chiefly toward destruction, and whose energies attempt to turn everything into perverted channels. Call these physical “big shot gangsters” and “dope addicts” devils, if you choose; and also their contemporaries on the inner plane.

Anyone who follows this path of evil, also, certainly is ignorant. For an individual on the physical plane who, with full recognition as to what he is doing, becomes addicted to drugs so that he can be compelled to use a machine gun in the murder of people in order that his boss will supply him with the drug he is unable to live without, certainly may be considered crazy. Those who arrive at such a state of affairs certainly are in a bad way.

But they are still much more fortunate than the habitual sorcerer. Such a one has placed his hand against the evolutionary forces of the cosmos; he is allied with all forces of destruction. He cannot know happiness, for he has joined forces with the creatures of the astral hells, and to these hells he will go when he passes from the earth. And surrounded by others of his ilk, it will be eons, perhaps, before he can break the chains of his evil attractions and gradually and painfully crawl out of the murky pit into which his awful deeds have plunged him. Anyone, anytime, who uses magic to injure another, or who allies himself with the invisible gangsters of magic for some fancied gain, I unhesitatingly say is either grossly ignorant or else completely mad.

This is certainly not a pleasant subject to discuss. It is full of morbid conditions and revolting thoughts. But we cannot sanely ignore a wound because it festers. We cannot shut our eyes to the widespread crime and lawlessness existing in America. Nor can we dismiss with a shrug the crimes of sorcery and witchcraft.

Instead, we need to know why all these conditions exist; to the end of removing their cause. And I trust that this explanation of the cause and practices of black art may deter some who otherwise in a spirit of curiosity might dabble in such matters to their sorrow.

Protection From Black Magic

—Having discovered the cause of any obnoxious condition and how best to remove that cause, which in this case I believe to be through full enlightenment, the next thing is to devise adequate means of protection. For ignorance is never full protection.

So in matters magical it should be recognized that effects produced, either good or bad, depend upon the impact of astral energies. But these astral energies can only affect a human being when they establish sufficient rapport with his astral body to be able to transmit to him their energies. And unless he is unduly negative, through cultivating irresponsible mediumship, he has the power within himself of preventing the formation of such conditions of rapport.

If he has cultivated directed thinking to any degree, he is able to turn his attention to whatever matters he desires to think about. And if he completely turns his inner and outer attention to some elevating subject, to some pleasant emotion, or to some problem requiring concentration, he automatically destroys all rapport with vibrations of a lower or destructive nature. Magical injury can take place only through the principle of resonance, best illustrated by the radio. A low and harmful vibratory rate cannot tune in on a high and constructive rate. Therefore, while one is absorbed in high aspiration, or with some thought of a constructive nature, this automatically tunes out destructive magical influences, and renders them ineffective and harmless.

Fear, however, more than anything else except thoughts similar to those of the magician, focuses the mind to the vibration of the thing feared, and forms a rapport with the very thing that should be avoided. Fear effectively tunes in on the thing feared.

Faith in some higher protecting power, however, effectively tunes the vibratory rate to a higher frequency, and shuts off those that are pernicious.

Chapter 5

Serial No. 187
Original Copyright 1945
Elbert Benjamine

Copyright
August 2002
Church of Light

Ritual and Religion

Chapter 5

Ritual And Religion

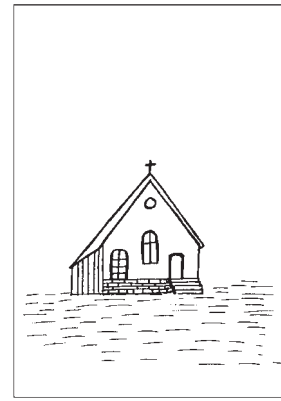

If we are to discern the significance and value of ritual in religion it becomes necessary to trace that ritual back to more primitive times and people and learn what it originally meant. For, without exception, these rituals are merely modifications of practices handed down from an age in which the priest followed the same type of ceremonial as the sorcerer, except that the magic of the priest was directed to disperse evil spirits and benefit people rather than to harm them.

The ceremonials of the various churches not only are derived from the practices of white magic in ages gone, but they still perform the essential functions of ceremonial magic.

These functions, as set forth in a preceding lesson, are three-fold: 1. Through arousing the emotions of those present to furnish an energy supply sufficient for magical purposes. 2. To direct that energy into the proper channels to perform the work desired. 3. To contact intelligences of the inner plane who will assist in the work.

White Magic Today

—As an illustration of white magic performing these three functions, I turn to newspaper reports. March 1, 1932, the baby of Colonel Charles Lindbergh and Anne Morrow Lindbergh was kidnapped, and up to March 7 it had not been discovered that the child had been murdered. In the Los Angeles Examiner dated March 7, 1932, there is the reproduction of a photograph of school children kneeling before a shrine, and the following inscription below it, “Two hundred Youngsters of old St. Stephen’s School, Chicago, praying at shrine for Lindbergh baby. Youngsters knelt in earnest hope that son of national hero was unharmed.”

Other quotations from the same newspaper on that day read: “Supplications Offered Up In All Churches. Hopewell Residents Turn Out En Masse For Services to ‘Soften Kidnapers’ Hearts’.” Hopewell, N. J., March 6. “Fervent prayers were offered up today in Hopewell’s six churches for the safe return of Charles Augustus Lindbergh, Jr., 20-month-old son of Colonel and Anne Lindbergh, who was kidnapped last Tuesday night.

“Virtually all residents of this small, sleepy town that nestles in the valley under the Lindbergh Sourland Mountain estate turned out to pray for little Charlie.”

Further headlines in the same paper: “Los Angeles Implores Divine Aid for Child.”
“Britons Pray for Safety of Lindbergh Baby.”

It is apparent from the above quotations that people believe that their prayers are more efficacious when they congregate in a church or kneel before a shrine. Such a ceremony, simple as it is, does heighten the emotional element; and it gives collective force to the energy so released.

The energy is directed by the ceremony to the accomplishment of a definite purpose, in this case to “Soften Kidnapers’ Hearts.”

The ceremony does not, however, merely direct the thoughts of those present; but also solicits Divine aid in the undertaking; that is, it directs the mind to an intelligence, or intelligences (angels) on the inner plane who are asked to assist in the accomplishment of the work thus undertaken.

Religious ceremonies make use of the same principles for benefiting others, and aiding in cosmic progression, that the black magician uses to block progress and injure mankind. And even the witches’ sabbat has its counterpart, although directed into constructive channels instead of those destructive, in contemporaneous religion.

Anyone who has ever attended a revival meeting of the old-fashioned “Shouting Methodists” will find it difficult to believe that even the witches in their sabbat became more excited. And this enthusiasm, like the olden epidemics of witchcraft, often swept a whole town or countryside. Each night, after an hour or two of singing and praying, the spirit had hold of numerous new converts, and they then realized, between hallelujahs, that they were saved, and as such they came forward and knelt before the altar.

In the conduct of such a meeting, it was common to interlard the enthusiastic mass vocal efforts of the congregation with the most pathetic and soul-stirring songs obtainable, sung by a trained singer who could render, “Oh, Where Is My Wandering Boy Tonight”, and “Tell Mother I,11 Be There”, with unusual pathos. The more efficient the leader in stirring the congregation to emotional abandon, the more successful became the revival.

In these religious seances, which called upon Deity as a guiding power, the efforts of mass hysteria, instead of being directed into channels of iniquity, were turned to converting the individual to a better life, or to something helpful. They were designed to arouse a frenzy of emotion directed to some beneficial end.

Probably the closest present-day approaches to the witches' sabbat principle, yet directed constructively instead of destructively, are some of the Pentecostal meetings. Here it is the common thing for those most devout to expect the "power" to descend and take possession of them. Some, in this state, fall to the floor and roll about, hence the term, "Holy roller." Others "speak in foreign tongues." Some go about healing those who are ill by laying on of the hands.

Anyone who thinks that some of these people, who often are simple in faith and quite illiterate, are unable to do rather remarkable healing in this manner has certainly never investigated them thoroughly. After all, they are merely following, according to their conception, the precedent of the healing and talking in foreign tongues of the early apostles.

Nor, in this mention of the functions of ritual in religion, do I discountenance the belief that these people, or those who pray at a shrine for the safe return of a kidnapped child, actually contact beneficial intelligences on the inner plane. God is an abstraction, or, if you will, the intelligence that permeates all nature. But when the devout person offers up a prayer to God, he has in mind a much more definite image of attributes which are beneficent. And this prayer penetrates the concentric layers of the astral region, and reaches a realm corresponding to its vibratory rate. And the fact that it is directed to an image, or even a quality, of high beneficence, increases its carrying power in this direction.

Just as the black magician with his sign and symbol and inversive evocation, calls up the telephone number, so to speak, of some unknown gangster, and asks this crook's aid in his undertaking; so the devout individual, by his prayers and religious ceremonies, calls up the telephone number, so to speak, of some benign intelligence of a higher and better plane. And some intelligence occupying the plane to which his devout thoughts connect him will be reasonably sure to get the message. If the ceremony and prayer are unselfish and of high aspiration, and not directed to some restricted lower circle, he need have no fear that the message will be received by a gangster. The gangster is unable to tune in on any high-frequency rate, because his own rate is too sluggish. Furthermore, the high-plane intelligence thus contacted will be quite apt to do what can be done, under the circumstances and in all justice, to render the help desired.

Religious Ceremonies May Wall Out Essential Information

—Right here, however, another element enters that must be given full consideration. It is the influence of organization.

Even as the gangsters in the astral slums have organizations, so also the churches of earth, and the various religious sects, are quite as completely organized on the inner plane as on this one. Of course, when the individual belongs to any organized religion, and becomes more enlightened than the others of its membership, he resigns from it and joins something more progressive. Or, at least, he severs his association with the organization.

But if the organization on earth is narrow in tenet, and manifests doctrines that are wholly unsound, those who remain faithful to the organization on the inner plane will still cling to these outmoded notions. For if they have outgrown them they will no longer remain members of it.

As is explained in lesson No. 174, those of fixed belief, especially when there are many of the same thought, often build up an artificial environment on the astral plane that quite vindicates—until they awaken to the true condition—all their preconceived ideas about what the next life is like, how the universe is run, and the appearance of God and the angels.

It is necessary to understand this in order to recognize how religious ceremonies under certain conditions may greatly benefit an individual, but at the same time place him within a wall through which little enlightenment can penetrate; and how such ceremonies, by specifically directing his thoughts and prayers to a preconceived and limited region, prevent their rising above, or recognizing a response from, other than this restricted area of the inner world.

I believe in this place no proof need be advanced that religious organizations, as a rule, offer to their followers the idea that they are each the one and only avenue of mediation between man and God. Each holds forth the doctrine that salvation is assured in its own fold, but is doubtful or quite unobtainable to those belonging to other denominations. They are like political parties, which commonly proclaim that the country will be saved if it adopts the platform and candidates they advocate, but will certainly go to ruin if any other candidates are elected, or any other platform accepted.

And like political organizations—for religious heads are the modern representatives of the priest-king ruler of old, and of the medicine man who counseled the chief in still more primitive society—religious groups are jealous of rivals, and those in authority are keen to retain their station and power. The essential ceremonies are only efficacious when performed by the Brahman caste, for instance; which gives them power, prestige, and an easy and ample income. Or, in America, the burial services can only adequately be performed by a priest—in certain organizations—otherwise the body cannot be placed in sacred ground, and the soul will probably have a hard time of it. And although the laws of the country make a civil marriage ceremony legally binding, in order for it to be a real marriage, and not just prostitution legally authorized, one

church holds that the ceremony should again be performed by the proper religious official.

What I am trying to bring out here is that those possessing religious authority have, from the earliest times, set themselves apart as a favored caste, and have neglected no possible means to maintain their caste and enlarge the scope of its power. I am not implying that religious leaders do not endeavor to benefit their followers. But I am pointing out that they have so invariably “rationalized” their desire for authority that they have deluded themselves into the belief—as political leaders also often do—that the salvation of the world depends upon them retaining power and assuming still more authority.

From such a “wish fulfillment” motive, comes the doctrine, for instance, of Apostolic Succession. This doctrine holds that only those who have been duly ordained by the Church can perform spiritual ceremonies; which really means that those already in power in the Church reserve to themselves the right to appoint their successors and other religious officials. And to maintain this right they pretend that the Holy Ghost is thus passed on from one to another.

Kings also, throughout the past, pretended that they were appointed by God, and that the Divine power to rule and exploit their less fortunate brethren could be passed on only through heredity. If present day politicians could formulate some plausible theory by which they could convince their constituents that it was the intention of God that they should select their successors and all others who should hold office, how much more secure they would be, and how relieved of the responsibility of serving the people efficiently!

Religious potentates, themselves, have propounded numerous cunning explanations why they should be allowed to pass divine power to those who later prove, by their acts, to be even unworthy of any esteem of decent men. But it remained for the most subtle, and yet manifestly self-seeking, theory to be advanced under the guise of occultism:

“If the faithful had to institute an exhaustive inquiry into the private character of a priest before they could feel certain of the validity of the Sacraments received from his hands, an element of intolerable uncertainty would be introduced, which would practically render inutile this wondrously-conceived device of the Christ for the helping of His people. He had not planned His gracious gift so ineptly as that. To compare great things to small, to attend a celebration of the Holy Eucharist is like going to a bank to draw out a sum of money in gold; the teller’s hands may be clean or dirty, and assuredly cleanliness is preferable to dirt; but we get the gold all the same in either case. It is obviously better from all points of view that the priest should be a man of noble character and deep devotion, and should thoroughly understand, so far as mortal man may, the stupendous mystery which he administers; but whether all this be so or not, the key which unlocks a certain door has been placed in his hands, and it is the opening of the door which chiefly concerns us.

“First, only those priests who have been lawfully ordained, and have the apostolic succession, can produce this effect at all. Other men, not being part of this definite organization, cannot perform this feat, no matter how devoted or good or saintly they may be. Secondly, neither the character of the priest, nor his knowledge or ignorance as to what he is really doing, affects the result in any way whatever.”

Attempts of the Unfit to Retain Power

—We might just as well claim that Thomas A. Edison was incapable of inventing anything useful because he was not a college graduate; or that Henry Ford could not succeed in manufacturing because he does not belong to a trade union. And we might just as well say that any ignorant man, if he were but sanctioned by certain people in authority, could build automobiles or invent useful machinery.

But, while wealth and social station can be conveyed through inheritance or gift, ability in any line—and religion is no exception—cannot thus be conveyed. An Abraham Lincoln is not made through the favor of a political party; otherwise we should have more Lincolns; and spirituality, as well as the ability to transmit any real spiritual energy, lies within the character of the individual, and cannot be passed about like so much gold and silver.

This does not signify that those who attend the celebration of the Holy Eucharist, or other religious ceremonies, do not receive a certain amount of benefit. Such benefit as they derive, however, with a bloated, dissipated religious factotum officiating, is due to the elevation of their minds by the ceremony. If their emotions are energized, and the vibratory frequency raised sufficiently, they tune in on truly spiritual regions, or at least on realms of the higher astral, where kindly disposed beings dwell. Yet, as the ceremony, and therefore the thoughts of those present, revolve around the one who conducts the service, as a center, the character vibrations and the temporary vibratory rate of this individual tend to tune all in on entities and forces of his rate. Thus, because those present are somewhat in rapport with him, they are influenced, in their rates and in their contacts, by him.

If the one conducting the ceremony is noble of character and spiritually minded, he assists those present to contact regions and entities of like spiritual power and beneficence. But if he is gross and lustful—in spite of any apostolic succession or other folderol—such influence as he possesses to determine the vibratory rate of the congregation is toward bringing them into contact with unseen entities of licentious proclivities. As much so as the influence of a corrupt ward heeler is to besmirch the honesty of all those over whom he gains an influence.

It is certainly true that the church itself becomes a center which collects and conserves the vibratory rates that are tuned in on under the emotions of those who participate there in praise and worship. It becomes saturated with the astral influence thus contacted. But this influence is of the grade of spirituality, or lack of it, of the thoughts, aspirations and desires of those who habitually come there; and these vibratory rates, in their quality, are determined in large measure by the officiating

priest. To the extent that he has influence, he exercises a controlling influence over his audience and synchronizes their thoughts and vibratory energies to those which he holds. And if his vibratory rates are gross, those who attend such a service, influenced by the prevailing vibratory rate even as are those who attend a mediumistic seance, are brought into contact with lower entities, and are anything but benefited by it.

Spirituality, or any inpouring or downpouring of spiritual force, is not like gold handed out by a bank teller. If it were like gold our wealthy class could buy their way into heaven, as some attempt to do. Nor is real spiritual force like rain, which falleth on the just and the unjust alike. Instead, it is like education, and must be gained. Money can be passed from hand to hand, but spiritual energy can not. No one can acquire an education for another; but a competent teacher can assist a student to acquire an education. No one can acquire spiritual energy for another, but a competent spiritual instructor can assist the individual to raise his vibratory rates to the spiritual frequency, and can assist the individual in making contacts with spiritual beings.

I do not say that a gross man cannot assist people in a material way; for even evil sorcerers are able to heal the sick and help people acquire wealth, when they are so inclined. The handling of astral energies to gain physical results is not dependent upon morals. The witch performs deeds that if accomplished by a priest would be deemed miracles. But a gross man cannot impart spirituality; for his vibratory rates are so low he cannot contact spiritual planes or spiritual beings.

One might as well say that it makes no difference if a college professor knows nothing; for he is quite able to instruct others efficiently because some college has given him the title of professor. Thus the illiterate man, by being ordained a professor, should be able to teach students higher mathematics and the classic languages.

It is true that a student in a college with an illiterate professor might by his own efforts make considerable attainment. But it would be in spite of the teacher, and not because of his help. And also, those who attend religious rituals conducted by corrupt and licentious officials may, through the uplifting influence of the ceremony, gain in spiritual power. But such gain is made in spite of the tendency of the priest or minister in charge to attract low entities.

Aside, however, from the influence of the one conducting the service—who often is really a spiritually minded person, and therefore helpful in tuning up the emotions and minds of his congregation to a higher level—there are two other features of religious ceremonies, and of lodge ceremonies also, which should receive recognition. One of these features is usually very beneficial, because it arouses emotions of a higher vibratory rate, elevating the fundamental and the transitory vibratory rates. The other, through directing the mind to make specific contacts and walling it off from other contacts, sometimes is beneficial, but more often, at present, curtails and limits the budding spiritual powers.

I shall consider this latter first.

The Ceremonial Wall

—The majority of those belonging to a political party have certain beliefs in common, to which they are firmly attached. Fraternities and occult organizations usually are grouped, likewise, about certain definite principles and ideas. And the most obvious thing about a religious sect, or church, is usually the fanatical manner in which it holds to certain tenets, even though they are disproved completely by experimental science and the developments of philosophy.

These religious bodies, as well as the chief fraternities of an occult nature, exist also on the astral plane, and are there constantly recruited from members on the physical plane who pass from the physical body. And so long as they belong to this group on the inner plane, they must continue faithful to the doctrines it propounds. Because of the thought-building power of the mind on the astral, they live, until such time as they receive new light and abandon the organization, in just such an artificially created environment as their religion describes. As is more fully explained in lesson No. 174, they cling to the same beliefs they had on earth, and reject every effort to bring to their notice any evidence that contradicts the notions they held on earth.

Their leaders continue to lead them on the astral plane, and they are still bound into an organized group working for the spread of their religion. And because they have not yet discovered its fallacy, whenever opportunity affords, they exert what pressure they can to confirm this belief to those on earth, and to influence them to hold fast and refuse to permit any other conceptions to be received.

The ritual of the church on earth, the vestments, the various paraphernalia used, especially those bearing symbols, the consecrated water, the magnetized incense; each and all are devices to concentrate the mind on the one particular religion and tune in on those belonging to it on the inner plane. They are, in fact, instruments of ceremonial magic which, instead of the instruments of the sorcerer which place him in contact with invisible gangsters, are instruments to place the congregation in contact with the invisible brethren of the particular church.

Usually such religious ritual begins with hymns of praise. This singing in unison tends to give a common mental swing to the whole congregation, so that lesser vibratory rates are suppressed, and the unified force dominates to a point where the chief thought-vibrations of all are completely synchronized. At later points in the service, oral responses are required of the audience or some part of it, tending still further to unify the vibration.

Amen, for instance, is a word of endorsement. When the leader says something, and the response is Amen, there is a thought interchange, and the leader has the dominant influence. Thus the swing of the music, and such responses as are called for, unite the audience in a common strong vibratory rate, and enables the priest or leader to direct the frequency of the rate, and the type of invisible influence to which all are tuned.

Under these circumstances this congregation vibratory rate may be really spiritual and uplifting; but at the same time, because the signs, symbols and tokens of this religion are used, it contacts only the members of this particular religion on the inner plane. If these members are liberal minded, and searching for further information, this will have no restrictive effect. But if the members of the organization on the inner plane—which is the case of a religion of narrow ideas—have a fixed faith that the universe is run according to their preconceived ideas, their influence will all be toward confirming the congregation in these narrow concepts.

Among the western nations the most universally used ceremony is that of the Eucharist. Primitive man believed that by eating some of the flesh and drinking some of the blood of a slain creature it was possible, by means of a magical ceremony, to cause the attributes of the creature to pass to the character of the man thus partaking of it. Cannibalistic practices were not due to a taste for human flesh; but were magical ceremonies, in which eating a fragment of the body and drinking the blood of the slain enemy was supposed to transfer the bravery and energy of the one slain to those partaking of the feast. Cannibalism today, wherever practiced, is well known to be chiefly for this magical purpose.

The using of wine for the blood of the god, and a wafer of bread as a substitute for his body, was practiced in Mithraism and other cults long before the Christian era. It was a magical process, conducted by the priest-magician, by which the quality of the god was supposed to be conveyed to those who took part in the ceremony.

Some western denominations conduct the ceremony of the Eucharist with great pomp and splendor. And, of course, the more impressive it is to the eye, the ear, the nose and other senses, the more it tends to arouse emotion and impress its suggestion upon the unconscious minds of those present. But even when the ceremony is merely the offering up of a prayer, followed by the ceremonial partaking of the bread and wine, it is a ritual which tunes in the minds of those present on the members of their denomination on the inner plane. And while these invisible intelligences no doubt exert an influence to help their members follow the straight and narrow way, as outlined by their religion, and therefore tend to give moral benefit, they also wall them about with as much influence as they can to keep them from accepting anything not taught by their leaders. So, while an uplifting influence is often present in religious ceremonies, all too often such rituals imprison the mentality of those subject to them.

Of course, if the ritual is that of some organization which does not limit the thoughts of its membership, but encourages them to research and investigation, such a limiting influence is not present. On the other hand, it places those on earth in closer contact with their invisible brethren who have advanced further along the path of knowledge, and who are able to do something to assist in broadening their mental horizon. It is not that the religious ceremony, as such, stunts mental growth; but only that it ties the

individual closely to a particular organization. If this organization is narrow in belief, this makes it far more difficult for him to form broader conceptions; but if the organization is progressive and alert for new truths, this aids him through unconscious contact with those on the inner plane who likewise are striving for real knowledge and real spirituality.

Raising the Vibration Through Ritual

—Now, the rather elaborate services and rituals conducted by some denominations are very effective, through appealing to the various senses, in arousing emotion. The solemn procession, the unusual and symbolic garments of those conducting, the chants, the colors, the banners, the incense, the gorgeous settings; all tend to fire the imagination. The whole process is laid out along efficient psychological lines for releasing emotional energy. It has been handed down from times most remote, unknowing the term psychology, but nevertheless psychologically sound, as determined by the effects upon the participants as observed by a long line of priests, and by the pagan medicine men that preceded them.

More commonly, in these religious rituals, the minds of those present are directed to higher levels of aspiration. In the sense, therefore, of tending to raise the fundamental vibratory rate of the individual, they have a spiritualizing effect. It is only when some corrupt and debased leader dominates the trend of the vibratory rates with his own vile thoughts that there is apt to be thought-contagion spreading unwholesome desires.

But whatever gain in fundamental vibratory rate is made under the influence of present-day orthodox rituals, is usually more than paid for by the loss at the same time due to shackling the mental freedom. Not merely do those on the physical plane who lead such services discourage any thought or investigation which might reveal facts which would upset their creeds, but the ritual serves habitually to tune the mind in on invisible regions where only those holding to this creed abide. The ritual, therefore, under such circumstances, becomes an invisible instrument to hold the minds of those who attend its performance in a set and predetermined groove.

Yet until the mind is free from the fetters of such narrow conceptions, and is willing to accept a progressive conception of life, in which the soul does not merely attain a stationary heaven, or sink into a permanent hell, the amount of spiritual progress it can gain is quite limited. A ritual, therefore, to be of high spiritual advantage must not only arouse the desire for high endeavor and an unselfish life, but also must tune the mind in on regions whose inhabitants are not walled about by ignorance of nature, but are seeking out new facts, and themselves are making true spiritual progress.

Thoughts-Forms in Motion

—The holy water, which is used in some denominations, is water that has been prepared according to usage; that is, according to magical formula. In its preparation, therefore, it has been thoroughly magnetized for its purpose. This purpose is to carry the will—the thoughts—of the priest using it.

Water is one of the most readily magnetized of substances. As it is sprinkled, or cast, so the astral energies which the priest has brought to a focus are directed. The drops of water thus act as carriers of his magical power. They are usually used in the ceremony for purifying something or someone. And as thus prepared and used they are quite effective instruments for driving out and dispersing other entities or vibratory rates than those sanctioned by the priest. That is, the vibratory rates of the priest are conveyed to the object or person so sprinkled, which tunes the thing or person in on his vibratory rates strongly; and this, of course, cuts off any other vibratory rate which has been present. Very similar methods are used by native witch-doctors to drive out evil influences; and are quite as successful. Both modern priests and native witch-doctors make use of the same principle to attain similar objects.

“It was the duty of the exorcists in the ancient Church to cast out devils, to warn the people that non-communicants should make room for those who were going to communion, and to pour out the water needed in divine service. The book of exorcisms was handed to him with the words: ‘Take and commit this to memory, and receive the power to lay hands on demoniacs, whether they be baptized or catechumens.’ The candidate was admonished that as he cast out devils from the bodies of others he should rid his own mind and body of all uncleanness and wickedness lest he be overcome by those whom he drove out of others by his ministry. For then only would he be able safely to exercise mastery over the demons in others, when he should first have overcome their manifold wickedness within himself.”

This driving out of devils is mentioned in the Bible, and is occasionally practiced by a modern priest; but has mostly fallen into disrepute. It is an inheritance of the Church from the period of the witch-doctor. Nevertheless, even in modern times, it has been known to cure cases of obsession.

But before discussing further either the influence of the Church, or the effects upon devotees of healing relics, baptism, or the absolution of sins, a few words must be devoted to the creation and attributes of thought-forces.

Any image clearly held in the mind and vitalized with energy actually builds an astral counterpart of the thing so envisaged. In this manner houses are built in the next life; and in some detail I have discussed in Course 20 how the environments which are visualized by religious enthusiasts on earth are thus artificially constructed on the inner plane, and afford a place of occupancy for those who pass over with a fixed belief in such a heaven or hell. And I there also indicated that even a being with some semblance of intelligence could thus be constructed to act the part of God or devil, until a more thorough conception of things revealed the source of its construction and apparent intelligence.

But in addition to this, it should be understood that a strong and vivid thought sent out with a given work to perform not only possesses power to influence, but also a certain amount of intelligence to accomplish the purpose for which it was formulated. I do not mean that it is a living thing, possessing living intelligence. It is an automaton. Nevertheless it can perform a rather complex function, and make a variety of adaptations to accomplish its ends.

A torpedo sent out to attack a ship travels directly toward the ship. Yet even if the ship change its course and maneuvers about, this does not prevent the torpedo from finding its mark; for it is so constructed that it will follow the ship until it strikes it. And an aeroplane loaded with bombs can be sent forth, with no human being aboard, to be steered, it is said, to a city a thousand miles away, there to drop death-dealing missiles. Calculating machines now do the work of many accountants, and do it accurately. Sorting and tabulating machines exercise uncanny ingenuity in accomplishing the work for which they are created. And new mechanical robots are coming into existence every short while, exercising the ability to adapt themselves to a wide variety of circumstances and yet perform their function as if endowed with human intelligence. They do have intelligence of a sort; but this intelligence is that used in their construction, which enables them to do a definite thing under any circumstance that is likely to arise.

In a very similar way a thought-form sent out to accomplish a definite mission exhibits quite an uncanny appearance of intelligence. It does not have the kind of intelligence possessed by a living thing, but the kind of intelligence that a torpedo has in finding its target, or a sorting machine has in discarding certain things and retaining others, or a tabulating machine has in analyzing a report. It is a mechanical device constructed of thought energy and endowed with the ability to accomplish a definite thing under almost any circumstance that may arise. It does apparently exercise intelligence in the performance of its set task; but has no intelligence of its own, nor does it exercise intelligence about other matters.

In addition to the faith engendered by its reputation, a holy relic becomes saturated by the thoughts of those who have faith in it; and after numbers have witnessed its power to heal, and have projected their thoughts toward it, a healing thought-form may be gradually built up around the relic that has a surprising power to heal.

Likewise, those who make the pilgrimage to Mecca to kiss the kaba stone, perform a magical rite. They expect to gain in spirituality by their toilsome journey and the great sacrifice it entails. This has an affect upon their minds. And when they approach the sacred stone in reverence, they add to the accumulated energy of the thousands who have kissed it, and give it a little more potency to influence future devotees, because of the addition of their thoughts to the thought structure with which it is enshrouded. Because of their reverence and aspirations, they do benefit by having their vibrations raised.

About such a stone, or about a church in which ritual is conducted over a period of time. there accumulates an enveloping and penetrating mass of thought-forms. The thoughts of the priests usually are the dominant forms, and the thoughts of the congregation furnish additional energy. Those who enter this thought-edifice cannot help being influenced by its strong vibratory rates. And these may mostly be spiritual and uplifting.

But commonly those who dominate the ritual or service send out imperious thoughts that those attending shall remain faithful in all details to the belief and creed of the Church. That is, in such an edifice, or place, long used for ritual or service, there are usually present energetic thought-forms which have been sent out during the process of ritual, which have the definite mission to perform of compelling the members of the congregation to remain faithful to its tenets and creeds.

Invisible Persecution

—It is not surprising, then, to find numerous instances of those who withdraw from membership in such an organization who believe they are being persecuted by the Church. They find that they are unaccountably emotionally and mentally disturbed; that a seeming pressure is exerted by invisible forces to compel them to discountenance the findings of their reason and return to the fold. As a matter of fact, no one in the Church may even be aware of their change of views; but the thought-forms of the Church, like faithful robots, are at work endeavoring to keep them in line.

Baptism is a ritual of considerable importance in many churches. It is essentially a magical ceremony, using symbolism to impress the purport of the change on the mind, and by other portions of the service tending to tune in all present, as well as the one baptized, on the invisible brethren of the denomination. The person realizes that his life has been far short of what he desires in the past. But he has determined henceforth to do differently. To commence with a clean slate, as it were, he goes down into the water, where his “sins are washed away.” His conscience need not bother with past derelictions. Only the future need now be considered, and he is tuned in somewhat on forces, perhaps on strong thought-forms, which help him keep his resolution.

The conflicts within man's mind between the standard of conduct which he has set for himself, or which his religion has set for him, and what he actually does, leads to inefficiency and unhappiness. If he believes the priest has the power to absolve him, he has a means of reconciling these conflicting forces within himself, and starting a new day also with a clean slate. Confession and absolution of sins at times have been used by the Church as destructive agencies; and have aided the Church to retain its temporal advantage. But they also have been of benefit to those who believe in them, because they have enabled them to release mental disturbances and quiet inner conflicts. Believing they were no longer sinful, it became easier for people to tune in on high-frequency energies.

Like almost everything that is powerful, when used strictly for a constructive purpose, religious ritual accomplishes much that is of great worth; but when used to restrict the minds of others, or to exploit them, it is equally powerful as an agent to retard human progress.

Effective Prayer

—Prayer as well as progressed aspects affords the thought-cell groups within the unconscious mind with additional energy for use as Extra-Physical Power. And although these thought-cell groups have intelligence of their own, and as witnessed in their response to progressed aspects, know how to bring physical events to pass, prayer, through the directive power of thought, may divert the activities of thought-cell groups to performing a new and desired type of work. That is, prayer may not only furnish the energy for work on the inner plane, but may also effectively direct the intelligence of a thought-cell group to performing the job required in the answer to the prayer.

In other words, prayer may cause the same thought-cell groups which are responsible for the events attracted into the life when progressed aspects are operative, to exert themselves to bring to pass other conditions and events which are sought.

Yet in bringing about the condition sought through prayer, man need not depend upon the intelligence of the thought-cell groups of his unconscious mind. Each level of inner-plane existence is inhabited by intelligent entities, and these respond to the earnest desires of those of similar aspirations who can contact them. In the physical world we do not rely entirely on our own abilities and efforts. There are friends and associates with similar interests who give advice and who cooperate in various ways. And through the avenue of prayer, which is a deliberate effort to enlist the aid of a superior power, we more or less contact intelligences occupying some level of the inner plane. And we more or less contact the all-pervading intelligence of Deity.

How much, in any given instance, the all-pervading Divine Consciousness responds to prayer, how much inner-plane intelligences give their aid, and how much of the results obtained are due to the activities of thought-cell groups within our unconscious minds, is determined by a variety of conditions. But however much one or all of these three contribute to the answer to prayer, the result is effected through the Extra-Physical Power brought into play, Extra-Physical Power which in principle is similar to that which brings other events, including those not desired, into the life coincident with appropriate progressed aspects.

Such Extra-Physical Power may be directed from any inner-plane level. Under proper conditions, even the brutal prayers of bestial men gain a force which brings their answer. But the brutal prayers of bestial men can only reach and bring a response, if they bring a response at all, from the bestial levels of the inner plane. They only have a force which operates with intellectual cunning on the gross and selfish levels of the animal world.

It is only those prayers which are motivated by the unselfish desire for the welfare of others which have a vibratory frequency that extends the consciousness to those basic levels of the inner world where dwell those who have once lived on earth, and other entities which have never had earth experience, but which work for all that is good and true, and which are willing to assist the beneficent purposes of man.

If the dominant mood engendered by the act of prayer exalts the soul in noble unselfishness, if the thoughts and supplications are chiefly for the benefit of others, the inner-plane level contacted will have a similar vibratory rate, and such intelligences as there reside will be unselfish and devoted to being as truly helpful as possible to all.

Chapter 6

Serial No. 188
Original Copyright 1945
Elbert Benjamine

Copyright
August 2002
Church of Light

Press, Radio and Billboard

Chapter 6

Press, Radio And Billboard



One can hardly consider any treatment of the imponderable forces affecting human life as at all adequate which omits the various agencies of propaganda. Commonly these agencies commence their work soon after we arise in the morning; at least as soon as we turn on the radio or glance at the morning paper.

As we drive to the office, or go to whatever work awaits us, their impact strikes us from sign boards along the way, or from car signs placed conspicuously in the public vehicles within which we must ride. Salesmen make their appearance during the day, the magazine we read during the noon hour adds its weight, and in the evening, as we relax a few moments before retiring, we turn on the radio again, and receive a final bombardment.

From almost the moment of awakening until we go to sleep, and even after we go to sleep if some member of the household keeps the radio on, we are under a constant but subtle pressure to compel us to do something that someone else desires us to do.

Now there can be no objection to our obliging other people and complying with their requests, provided such compliance is mutually beneficial, or not derogatory to the welfare of society. Perhaps the greatest single economic problem of today is that of distributing the products of industry. A high standard of living among the people can be reached only through informing a wide public of the advantages that may be derived from the purchase of new conveniences and improved articles. And it requires education and salesmanship to break down prejudices that favor the old and tried things. Advertising thus, when received with discrimination, is of utmost value not merely to the producer but to the consumer.

But along with their benefits, not only advertising channels that are recognized as such, but all avenues of education, are all too commonly used to warp and distort the judgment of men, to the end that they shall act through the compelling force of subtle, infiltrating suggestions, or through misinformation, to their own detriment and the grossly selfish benefit of those who make it a business of exploiting others.

History Is Mostly Lies

—The histories that children study in school invariably inculcate in them the belief that the conflicts of their country in the past were always forced upon them by the outrages of some other nation. Children are led to believe that their patriots, their generals, their great men, are superior to those of other nations. Their country has always been right in its controversies. Their soldiers have always been noble and brave. Opposing countries have always been base and vile.

Thus the histories of two countries about the same war, or the same crises, in which they were antagonists, are always varnished in such a way as to convince the child that his nation is vastly superior and that the other nation is filled with detestable people. Napoleon, who made considerable history of sorts, and therefore was entitled to his opinion, decided that history is mostly lies. That is, like so much else we read, see, and hear, its chief concern is to convince us, regardless of the actual facts, that someone was right and someone else was wrong.

Then we find, if Senate Investigating Committees are to be believed, when the child has graduated from High School and gone to College, that he comes under the influence of learned men, some of whom are granted salaries, much larger than they receive from College, paid to them by large corporations. These additional salaries are allegedly to enable them to do research or other special work; but in reality carry the implication that the instructor is to give a slant to his discourses that will be favorable to the political and other aspirations of the corporation.

Of course, the majority of college professors would scorn to take gifts or emoluments from such corporations. But there are enough of them willing to do so that it is not hard for such interests to place very capable speakers under their pay at such strategic points in our institutions of education, and on lecture tours, as to make their influence widespread.

And even the instructors who would not take pay ostensibly offered to further educational work yet with the implication that some corporation be favored, not infrequently have strong and unreasonable prejudices in regard to religion, prohibition, politics, and other things which so commonly rest upon the emotional background of the individual rather than upon research and experiment.

I have singled out history as a single example in the schools, and corporation propaganda as a single example in the colleges, and no doubt these are the most obvious examples; yet numerous others might be cited, all going to show that from the time a child enters an educational institution until he leaves college he is more or less under the influence of those who are not impartial in their views. Propaganda of some kind is constantly at work seeking to sway his thinking into biased channels.

The Slant of the Press

—Now I suppose no one needs to be told that such a thing as an impartial press is practically non-existent at this day. Many of the newspapers and magazines which carry other than fiction, are owned by syndicates who have purchased them with the view of influencing public opinion in a definite direction. Many other periodicals not actually owned by such syndicates are subsidized by them. And nearly all the others at least have some definite political view which they are determined, at all costs, to sell to the public. And even the most widely read stories are written chiefly with a view to proving or disproving something; and not infrequently their authors are assigned by the publisher to write a story of so many words showing something to be true, the editor indicating the “slant” he desires.

Banks, railroads, political bodies—Anti-Saloon League, Anti-Prohibition League, World Court Advocates, Anti-League of Nations Group, and every other powerful group with an axe to grind—have their press agents whose work it is to manipulate the public through their utterances in the press. It is estimated that New York City alone contains no less than twelve hundred such press agents, all working to sell the public some particular brand of thought.

An illuminating way in which to learn how prevalent and strong are the influences of propaganda is to read the reports on the same important events in newspapers and other periodicals that “slant” their news from different angles. Let us take, for example, an account of some foreign disturbance, or even a local disturbance, as reported in the Los Angeles Examiner (Democratic), the Los Angeles Times (Republican), and The American Freeman (Socialistic).

If the event is really important, Mr. Hearst’s Examiner will show that in the last analysis the trouble was due to prohibition; and that light wines and beer if easily to be had would make of earth a paradise without hardships. The same difficulty will be shown by the Los Angeles Times to be solely due to trade unions or radical labor elements in their efforts to destroy civilization. And the American Freeman will quite as convincingly prove that the only source of the difficulty was the greed of Capitalists in their effort to exploit the downtrodden wage slaves.

When prohibition is solved, the Los Angeles Examiner will have something else to blame for everything disagreeable but as the Times has always blamed the workingman for every disaster, and the American Freeman can see no evil except it is inspired by those of wealth, we may confidently expect them to retain their special “slant” as long as they have existence.

What has been pointed out in connection with these three papers is largely true of nearly every news sheet in the land. And not only many of the best stories, but practically all the articles that appear in the magazines are written specifically to support the views that the magazines are endeavoring to sell the public. Today there is almost no such thing as an unbiased source of information.

The Radio

—The radio programs do the same thing that is done by the press, but as a rule they are more frank about it. The press is really trying to influence public opinion, trying to sell people some idea, and uses the news as the avenue to get their attention and confidence. But it does not inform the public that it is giving a biased version, or that in its news items and articles it is selling an idea advantageous to itself. The radio program, however, makes no secret that it is entertaining people, giving them something they desire, in order to get their attention and sell them something. The radio announcer makes his station call at intervals and plainly makes it known what his sponsor wishes the public to buy.

Radio programs are mostly paid for by someone who is trying to sell something. As a rule, about three minutes out of every fifteen are devoted to selling effort, and the balance of the time is given over to holding the public attention through some form of entertainment. It is the work of the radio announcer to word his sales talk so that you will have the utmost confidence in what he says, and will be possessed by an intense desire to buy what he has to sell.

In addition to these paid for programs, radio stations have what are known as sustaining programs. These are periods of time which the station has been unable to sell to some advertiser. The station procures as attractive entertainment as possible for these sustaining programs, because in order to sell time to advertisers it must hold the attention of its public. A good sustaining program adds to what in newspaper work would be called “circulation.” This attracts to it those who wish to buy time; for time is what the radio station has to sell. But the notable lecturer it hires to hold the attention of the public and make the paid-for time of this station valuable to the advertiser may, and usually does, have some particular “slant” which he is promoting in his broadcasts.

Billboards

—Billboards and posters are unlike the press and educational institutions in that no one is led to believe they are not trying to sell something. They are like the radio, except that they appeal to the eye instead of to the ear, in that although they use many subtle methods to make sales, they are not so completely camouflaged as to their real objective.

Not only is there practically no unbiased source of information available to the public, but, human life being what it is, it is unlikely that such will be forthcoming in the future.

Since men have been upon the earth they have had opinions formed from incomplete data that they have been eager to persuade others to accept. They have had material possessions which they were desirous of trading to others at the best possible profit to themselves. They have wished other people to do certain things; and have ransacked their wits to find some means by which they could induce the action that would, irrespective of its effect upon society, be beneficial to themselves. And it is too much to expect these tendencies to vanish. We may as well accept the situation as it now exists, and as it probably will exist in the future, that there are many men either through ignorance or self-seeking, using all available channels of information to influence people to think and act in the way they desire they should.

This being the case, what can we do about it? How can we prevent, through the lies of purported history, through smooth statements of half facts by educators, through the “slant” of fiction and news items, and the subtleties of radio and billboard, forming erroneous conclusions and acting as a consequence in a manner detrimental both to ourselves and to society?

When we become conscious that all these sources of information have something they are enthusiastically trying to sell, we can then make an effort to discern the “slant” they give to information. That is, before accepting information as such we can delve to find the real motive behind the source of its dissemination.

Add to this a clear comprehension of the chief methods by which we are subtly influenced without usually being aware of it, and the common method by which fact is distorted to make it signify something different and yet remain plausible, and we have a means at our command by which we can discriminate effectively between the real truth of any situation and the appearance that is given to that truth by the organ presenting it. Through our knowledge of the methods of those purveying information we will be able, in great measure, to separate the real kernel of truth from its chaffy covering.

Inversion

—There is a form of distorting facts in which a lie is resorted to, plain and simple. Political opponents, on the night before election, sometimes publish a bare-faced lie about their antagonist, and count on it swinging public opinion before it can be proved false. But an unadorned lie usually can be made effective only over a brief period of time; for unless it is very cunningly concealed amid such truth, or given wide repetition, it is too easily proved untrue.

To maintain plausibility, and therefore confidence that it is not a lie, the common method used by those both on the physical plane and in the astral slums, is to use truth—the more obvious the truth the better—and within it to insert a very small and inconspicuous distortion of the truth, which cleverly makes the meaning of the whole just the opposite of its true significance. This method is called inversion; and because it is the almost universal method employed by astral gangsters, they have come to be known in occult circles as the INVERSIVE BRETHREN.

The success in misleading the public, of an inversion, depends chiefly upon three factors:

1. It must present facts that are widely recognized to be true, or which can easily be proved to be true; and if they have a strong emotional appeal, so much the better.
2. The inversive twist—the misinformation or misinterpretation—by which the whole matter is made to appear to have a meaning exactly the opposite of its true purport, must occupy so small a part of the whole presentation, or be so cunningly concealed by sophisticated handling, that it escapes the notice of all except those with critical faculties highly developed.
3. The inversive twist—the misinformation or misinterpretation—must be so worded that it can be subjected to no direct and simple test of accuracy. In fact, the more loopholes left by which to sidestep any direct test of its truth the more it fulfills its purpose.

To accomplish this last, for instance, no direct accusations are made against an opponent; for these could be brought to trial. But instead insinuations are published, which if brought to trial could be said to have meant something entirely different, and to have no derogative import. Or, in setting forth some matter, so many alternatives are left, any one of which seemingly supports the inversion, that as fast as one is traced down and proved to be a lie, another can be substituted. Thus the number of such substitute lies becomes so great that the public has not the patience to follow the efforts of anyone who has the diligence to hunt them down, one after another. This is the real hydra-headed monster which grows two heads in the place of each one which is cut off. That is, when one lie is slain, those responsible for it have two others ready at hand to take its place.

As illustrative of the inversive method, the Senate Investigating Committee previously mentioned found that a certain huge corporation was granting large salaries to certain college professors to travel about giving lectures. These lectures were something in the nature of University Extension Work, under the auspices of some college. The lecturer was always a man recognized as an authority on his subject. And in his lecture he did his utmost to impart real information to his audience. But subtly injected into these lectures, which were otherwise of much educational value, were observations on economics which were given such a twist that those listening felt the corporation in question had been much maligned, and that when the matters affecting it were made a political issue, they should use their influence to favor this benign and unselfish syndicate.

There is no question here as to the right of a corporation to hire a lecturer to inform people of its virtues. The inversion consisted of hiding behind recognized colleges to give the impression that those of unbiased authority were of the opinion that the corporation was wholly benign; hiding the fact that the lecturer was actually being paid for creating this impression, and in presenting half-truths thus cunningly concealed amid a large amount of information of real value.

If we drop back to the commencement of the Christian era we see this principle of inversion vigorously at work then.

There can be no question but that in all ages it has been quite common to abuse the sex functions. Sex often has led to bestiality, to gross passions, and to extremes of selfishness and grossness. Also, material possessions, from the most ancient times, have caused many people to be dishonest, to become selfish and cruel, and to develop unspiritual qualities. Such facts are so obvious and so well recognized that no one requires them to be proved.

And because of the popular acceptance of them as facts, it became easy to use them for inversive purposes; for the more widespread a belief the easier it becomes to use it as a trap to snare the unwary.

It was therefore argued by church zealots that if sex and money were the source of most of the evil in the world that the spiritual man should renounce both completely. The other half of this truth was completely ignored; that sex and money are also the sources of most of the good in the world. The fact that only by means of material possessions are we able to alleviate the suffering caused by the poverty of others, providing for them medical care, shelter and food, and that only through wealth—the product of labor—can we sustain ourselves and develop the resources of the earth so that people may have more comfort, education and more happiness; this was entirely overlooked.

It was also ignored that family life is the most potent source of unselfish emotions in the world. If spirituality is based upon unselfishness and love, family life is the most effective training school of spirituality at hand. Man and wife frequently are unselfish in their relations with each other; and parental love is commonly unselfish.

Therefore, the inversive doctrine that it is spiritual to renounce sex and wealth was disseminated; resulting in a period during which monastic life flourished. And the inmates of these holy institutions were so self-centered in their determination to attain salvation for themselves that little of real spirituality could penetrate to them. They shifted the responsibility of the world from their own selfish shoulders to the backs of others; themselves seeking spiritual safety while materially provided for by the institution they had joined. And having renounced love, except a vague and abstract affection for all mankind, it is not surprising that the histories of these monasteries are a record of epidemics of hallucination and outbreaks of mental aberration.

Following down the centuries to the settling of America, we find the Pilgrim Fathers believing in a not unrelated inversion.

It has been noted throughout man's development that he often spends time that should be devoted to work in play, that he frequently dissipates wealth that should be used in sustenance in securing enjoyment, and that in the quest of pleasure he often disregards the rights of others and becomes gross and brutal. Hence, by the inversive method, it was easy to get a following for the doctrine that all pleasure is wicked.

And as I have pointed out elsewhere, so-called “American nerves,” are probably largely the result of the doctrine of suppression that has been handed down from the early settlers of our country. Their religion cultivated a rigid austerity, the restraint of every emotion, and looked with horror upon fun of any kind. The partial truth which gave rise to this doctrine failed to recognize that pain is contractive and pleasure is expansive, that pleasure is constructive and only its excessive and perverted use is destructive, and that happiness is an aid both to constructive work and to spirituality. That happiness or pleasure is a sin, according to the findings of psychology, and according even to facts understood for centuries, is an inversion.

As an illustration of the complexity of alternate factors, which is a favorite method of escaping detection when an inversion is given propaganda, I can find no better illustration than the doctrine of repeated reincarnation.

I am well aware that many who read these lines will not agree with me in this. I am not questioning their right to believe in repeated human reincarnation if they desire to do so. Nor am I making any accusations against them because they thus believe; or against those who now teach it; for I am sure they are sincere, and they have as much right to their opinion as I have to mine. Yet, as a free soul, I maintain I have the right both to have and to express my own ideas on this or any other subject.

The truth, as I see it, is that the soul does incarnate successively through various lower forms of life in its evolution. It passes through various forms in mineral, vegetable and animal kingdoms, but never reincarnates in the same species twice. But when it has undergone experience once in the human species, this being the climax of physical evolution, its progress from that point on is in worlds above the physical. It no longer returns to the physical earth, because it has lessons to learn and work to do in realms that offer it advantages that cannot be had on earth.

To me—and this is the Hermetic view—the truth that the soul reincarnates in many forms of life has been used to cloak an insidious doctrine of materialism which implies that nowhere can experience worth while be had except on the physical plane. This materialistic doctrine demands that the soul keep coming back to earth to gain experience and to pay debts; entirely overlooking the fact that when self-consciousness is once attained through even a brief human incarnation, that any further necessary experience—even the paying of debts—can be had in the next world.

Human reincarnation ignores that education, evolution, and constructive effort are continued in other regions that are even more real than the earth. It loses sight of the fact that as each soul is being prepared for a special mission in the cosmic scheme that the experience, or education, of no two souls is the same. But these things I have set forth in lessons No. 20 and No. 21, and in Course 19.

But any specific doctrine in connection with remembered past lives, the period between rebirths, or how many times such rebirths can occur, as soon as it is attacked in one quarter, is shifted in another quarter to an entirely different doctrine. It now appears, from a lecture by an international authority on the subject given in Los Angeles a few months ago, that human reincarnation is entirely optional. If one wants to return to the earth to reincarnate he is privileged to do so, and if he does not wish this additional experience on earth, he need not return.

In times past repeated births of a single soul have been traced back many, many thousands of years. But when such a remembered series is shown, upon indisputable historical evidence, to have been impossible, it is relinquished and someone comes forth with the idea that, after all, incarnations take place quickly and are few in number. If it can be shown, upon archaeological evidence, that no such dwellings existed in a region at the time when a remembered life took place, this is also relinquished and something else is quickly substituted.

But I think I have said enough to illustrate my point; for I have no desire to offend anyone who holds to any belief. But whether it be in politics, in religion, or in business, whenever the factors representing evidence can be shifted first to mean one thing, then to mean another, and finally relinquished in favor of still other substitutes, it is the part of wisdom not to accept them without the most careful research and thought.

Additional Technique of Inversion

—Since the foregoing was written that master of inersive methods, Adolph Hitler, rose to power and plunged mankind into World War II. Also, in these United States certain unscrupulous academic scientists have endeavored to get laws passed prohibiting both the teaching and the practice of astrology.

While enslaving the people of Germany, Hitler orated constantly on the great benefits they would derive from the Socialistic State which he was championing. In his book outlining his program, he set forth a method which later he successfully used. And others, witnessing this success, have employed the same tactics. He said that if one told a big enough lie people would believe it, because they were themselves accustomed to telling small lies, but they would not believe anyone audacious enough to tell a gigantic untruth.

In political campaigns in the U. S., we now find that an unscrupulous opposition at times spreads a barrage of unreasonable lies about a certain candidate believing, quite correctly, that in spite of the refutation of these lies by the candidate, these “smears” will stick in the mind of the public and, due to personal bias, will influence a certain number. It is recognized that some people, to raise their own opinion of themselves relatively, are all too willing to believe any evil they hear or read about another.

One of the inversive methods employed by Hitler was to accuse those he wished to destroy with the crime he was committing or contemplated. If he contemplated appropriating the property and wealth of a certain minority group he first spread the propaganda that this minority group had unfairly gained property and wealth from others. When he desired to attack some other nation, he spread the propaganda that this nation was arming to help in an invasion of Germany. He made accusation after accusation so plausible that, to their ruin, the people of Germany believed him.

The inversive propaganda of certain academic science groups—which, to maintain their prestige as the final authority on all information relative to natural law, are determined to recognize no energies other than the physical, and no possibility of life beyond the tomb—takes two chief forms. Straw men are set up and knocked down as fake tests are made and given wide publicity through the press.

Astrology, as are other sciences, is progressive. In books of thirty years ago on almost any material science one can find statements which since have been proved erroneous and are no longer held by scientists. This is equally true of the science of astrology. Thus it is possible for the foes of astrology to unearth such statements and prove them false.

For many years competent astrologers have recognized, for instance, that sun-sign alone is not a reliable guide to the vocation followed by an individual. Yet it is possible to find astrological textbooks that state the sign Libra inclines to music. And, other things being equal, it does give a love of music, although not necessarily causing the individual to follow music as a profession.

But some years ago a professor at the University of California collected the birth-date of over 1,000 musicians. He found more born under the sun-sign Scorpio than under any other sun-sign. And this finding was given wide and repeated press publicity as completely disproving astrology.

The latest such straw man set up and knocked down to disprove astrology appears in TIME magazine, issue of September 24, 1945, page 52. Academic psychologist Mrs. Lee R. Steiner went to an outstanding New York astrologer and got a reading for her husband, and denounced the science of astrology because the astrologer did not tell her her husband was dead.

Yet progressed aspects do not indicate inevitable events, merely probabilities. And it is never wise to predict death, as due to precautionary actions or mental treatments or other factors, the individual may slip by death's door. If Mrs. Steiner had asked the astrologer what happened to her husband during a given year—instead of deliberately misleading the astrologer—she would have been told he had experienced a most serious illness.

Where extra-sensory perception and psychic phenomena are concerned, the foes of the belief in any other realm than the physical commonly employ a professional skilled in legerdemain, who offers to reproduce the ESP test or phenomena. But when he attempts to do so he employs his own paraphernalia and selects his own conditions. Yet the wide publicity given such exhibitions convince many people that all psychic phenomena is legerdemain.

Platitudes

—There are words which have come to mean those things which are highly desirable to society and which, because of the desirability of those things thus generalized, come to possess strong emotional power. The unconscious minds of people are so accustomed to responding either favorably or unfavorably to the things designated by these words, that the words themselves have come to be symbols that arouse a special type of emotion, regardless of their association at the particular time.

Good, true, honest, unselfish, patriotic, benign, high-minded, noble, divine, and charming are a few of such words as are responded to in a favorable manner. Murder, avariciousness, selfish, coward, yellow, tyrant, grafter, seditious, crafty, cruel, and bully are a few that thus incite instant antagonism.

Now, as has been learned by those who exploit the weaknesses of the public, if some person, some cause, or some object can adroitly be coupled with one of these words, due to the habit of emotionally associating only things of a definite kind with the words, the unconscious reaction to the person, cause or object thus associated is that habitually aroused by the word. The emotional reaction, because of the power of habit, is so spontaneous as to lull reason. Before the critical faculties have time to question whether the association between the person, cause or object and the word is warranted, the habitual emotion aroused by the word has taken charge and embraced the whole phrase or sentence in its customary pleasant or unpleasant feeling.

For instance, not long ago the subject of "birth control" came up in the city of Syracuse, N. Y. In this country we are supposed to have free speech. Nor did those who wished to stifle even a discussion of "birth control" commit the error of bringing up the question of free speech. Yet they were convinced "birth control" is a terrible thing, and that the surest way to prevent any change in the New York statute in regard to it was to prevent the facts about it from being presented. How, in the face of the constitutional guarantee of free speech, were they able to do this?

Well, it is commonly accepted by the public that murder is about the worst of crimes. So they coupled the word murder with "birth control." They gave wide voice to the opinion that "birth control" is murder. Those thus appealed to responded spontaneously to the emotion aroused by the word murder, and dominated by this emotion failed to question the appropriateness of the association.

It seems never to have occurred to them, amid their repugnance at the thought of murder, to inquire if it were possible to murder a child before it is even conceived. And the emotional element so dominated the aldermen that they not only failed to consider whether the present laws on the subject are just or not, but they stifled our boasted free speech to the extent that they passed an ordinance, on the ground of indecency, prohibiting all discussion of the subject, even any discussion of whether the present laws on the subject are good and just.

As this is being written there are some 8,000,000 people seeking, but unable to get employment in this country. Under such conditions it is bound to follow that there is considerable hunger and privation. And at times there are parades of protest or gatherings of people who are hungry and who wish food or employment by which they can secure food. The word "Red," because of the Russian revolution, has become a word arousing terror in the hearts of those who have property. Therefore, every parade no matter how just or how far removed from thought of revolutionary activities, is reported by those who suppress it as a demonstration of the "Reds." Several such hunger parades were shot down at Dearborn, Mich., a few days ago; and the newspaper headlines screamed with the news of a "Red Outbreak." The word "Red" was used to justify the killing.

On the other hand, we have the words "Capitalistic Exploiter of the Masses," and "Capitalistic Grafters," used by those who wish to disparage the usefulness of any individual who is not utterly poverty stricken. No matter how much a man may have added to the wealth of society, if he possesses, or even controls, some wealth, his enemies can cause him to be hated by a large part of the populace. They keep calling him a "Capitalistic Exploiter"; and those who hear and see this term used in association with him are moved to hate, because it is their habitual reaction to the words. The habit is so strong that it suppresses any desire they might have to make a detailed inquiry whether or not, in his case, the term is appropriate.

And a man in the employ of the State is just as readily and unwarrantedly attacked by repeatedly attaching to his name the words "Grafters" and "Tool of Big Business." The fact that those in public life have frequently been grafters, and tools of big money, has developed an habitual emotional aversion to those words, and it comes to the surface so quickly that it commonly suppresses reason. For reason would make diligent inquiry to discover if the man so designated really does belong to the group designated by the words.

Insinuations

—There is another type of influence that is very prevalent. It is really an inversion, but is less cunningly concealed than the more elaborate inversions, and relies almost wholly on suggestion to do its inversive work. To distinguish it from the more complex inversions, it may be termed an insinuation. Some proposition is stated in such a way that the public is led to believe that things are dependent upon each other that in reality have little or no relation.

During the war it was recognized that people were desirous of helping win it. Streetcar placards and bill posters appeared, therefore, advising the public to "Buy Mr. Skokum's Pills and Help Win the War"; "Patronize Your Corner Grocer and Do Your Bit"; "Eat Sanded Wheat Husks and Help the Boys Over There"; "Mail Your Son or Sweetheart Over There a Package of Cow Tobacco to Give Him Fighting Strength." I have not, of course, quoted the names of the firms exactly, but all will be familiar with the type of advertising that was used.

As a matter of fact, there was no real help toward winning the war in any one of these items; but the advertisement gave the suggestion strongly that doing the thing suggested would help the cause which was so close to people's hearts. And because of the power of suggestion, when repeated over and over, many people, no doubt, made such purchases with the feeling that they were doing something patriotic, when in reality they were merely doing what the advertiser wished them to do for his own selfish advantage.

And as this is being written I find some radio announcers, and many bill-boards and newspaper advertisements, thus capitalizing the present period of unemployment and money shortage.

We are told to go to a certain Finance Corporation and borrow money on our car, "To Help End the Depression." We are informed that we should buy certain nationally advertised products, "To Provide Work for the Unemployed." We are admonished to buy our merchandise at a certain department store, "To Discourage Hoarding."

In some of the advertising of this nature there may be a little truth, but most of it merely makes use of the public desire to help restore prosperity to insinuate that this need may be accomplished by borrowing, buying, or selling, to a certain firm, when in truth the transaction urged has little or no bearing upon the restoration of normalcy.

Repetition

—Now we come to a factor that is unusually potent in getting an Inversion, a Platitude, or an Insinuation accepted and acted upon. It is the power of suggestion gained through repetition. This power is baldly stated by politicians thus: "In order to get people to believe a lie it is only necessary to go on repeating it."

Coue', in his famous formula, "Every Day in Every Way, I Am Getting Better and Better," gave a world-wide demonstration of this power in its constructive aspect. But constant repetition is quite as potent to hammer a lie into the unconscious mind and get that lie acted upon as it is to heal the individual of his ills when constructively applied.

If you see on the printed page and on bill-boards, twenty times a day for twenty-five days a month, the words, "Smoke Hemp Rope and Get Kissable," unless your critical faculties are unusually awake you will unconsciously accept the idea that smoking hemp rope actually adds to your attractiveness, and that others will have far less desire to kiss you if you do not smoke anything.

Or if you have it dinned into your consciousness by the radio announcer that a certain merchant sells for less, you will probably not stop to reason that where he is located rents are higher, that his displays are costly, that his whole overhead is such as to make it unlikely he can sell goods at as reasonable a figure as certain other merchants you know. Because you hear his name so often, and the assertion that he sells cheaply, when you desire merchandise you forget about the other tradesmen and go directly to his place.

Thought Dissemination

—In addition to the objective influence of inversion, platitude association, insinuation, repetition and suggestion, when there is an enthusiastic body of thinkers who desire to put over some program, or who desire that some idea shall be accepted, there is also to be considered the very potent invisible influence exerted by their thought-forms. These thought-forms once given sufficient impetus, and irrespective of truth or reason, may gather as they move, like a snowball rolling down hill, until they have sufficient power to sweep a whole nation into a war-hysteria, into a stock-gambling mania, into a land-boom craze, or into a panic of depression. In this country we have had all of these within less than a score of years.

Religious, political, occult, and other organizations which have some definite idea to sell sometimes are able to enlist individuals who have oratorical and literary ability to sway the public. In this enthusiasm for the "cause," these protagonists send out, perhaps quite unwittingly, powerful thought-forms impregnated with the mission to make converts. These thought-forms, throughout the duration of their existence, work unremittingly to convince people, through impression, or in extreme instances even through obsession, to adopt the standard of the particular cause. And those who become thus enlisted in the same effort, and zealous in its mission, unwittingly add the strength of their thoughts to the thought-form creation already working out its mission.

The unconscious response of people to such energetic thought-forms, when they once gain headway, is illustrated by the well-recognized irresponsibility of a mob. Incited by the words of a few leaders, who may be extremists and quite unbalanced, otherwise well-poised people, when part of a mob, often abandon reason entirely and help commit murder, arson and other crimes that undominated by such group thought-form influence they would never dream it possible for them to countenance, and for which, after reflection, they are heartily remorseful.

Such thought—dissemination—or collection of smaller thoughts about a more powerful nucleus for the accomplishment of a given work is usually, but not always, a process unrecognized by those responsible for it. And used thus unconsciously, as in the case of the religious evangelist to sweep a whole town into the fold at a revival meeting, it may result in no great damage, or may, when public sentiment is aroused thus in favor of some good cause, even help to bring about conditions more favorable to society.

But used by crooked politicians, by those who make propaganda for selfish advantage, and as encouraged by crooks and gangsters, it results in tremendous damage. Where the underworld is concerned they, of course, are interested only in promoting those conditions which assist them to prey upon more honest and spiritual men. And while they may support many things that aid them in this, one thing in particular that they sponsor, because it leads to disorganization of society and thus weakens it and permits them to have their will, is confusion. Confusion of any sort enables them to gain their selfish and unfair ends without discovery and punishment.

Nor are all those who use this thought-dissemination method—collecting the less potent thoughts of those they have persuaded to sympathize with their movement into a huge and powerful thought-form as snow is gathered into a ball as it rolls along—of the physical plane. Racketeers, gangsters, and leaders in iniquity on the astral plane find such thought-dissemination a potent means of getting the things done on earth that they desire. They must, of course, make contact with some negative individual whom they can influence to send out such thoughts and to promote the ideas they have formulated. Anything that leads to confusion they hold to be to their advantage, because a confused mind is one easily influenced by another through suggestion.

Chapter 7

Serial No. 189
Original Copyright 1945
Elbert Benjamine

Copyright
August 2002
Church of Light

The Wholesome Pathway

Chapter 7

The Wholesome Pathway

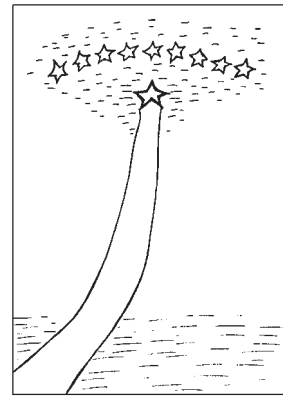

It should be plain to any individual that an energy is capable of being diverted to a wide variety of uses, and that some of these possible applications are destructive in character and that other possible applications are constructive in their work. Even dynamite must be used to blast the building occupied by public officials, and thus destroy their lives; in addition to being used to secure the gold which is locked in dense rock in the course of mining operations. And thus it is with imponderable forces. They may be used to add life or to bring death; and it is the object of this lesson to indicate how they may be applied for constructive purposes.

But before we begin to indicate their constructive operation, as distinct from that destructive, we must form some conclusion as to the things in man's life which are truly desirable. We must know what it is that is worth while building before we enlist any energy in constructive work, so that what is built will be of real value and not a liability.

The Three Highly Desirable Things of Life

—From the Hermetic viewpoint we can state the matter quite concisely; that there are three mutually dependent and highly desirable things in life which are worth supreme effort to obtain. These three are usefulness, happiness and spirituality.

Usefulness implies that one is doing something which helps along the tide of cosmic progression, and adds something of value to society. Man has no excuse for existence unless ultimately he can be of some use to other entities. Otherwise he is constantly a recipient of help without being able to render compensation in return. He is indigent and a burden upon others.

But man can not arrive at his highest efficiency in any line if he is unhappy. Unhappiness contracts the muscles and the thoughts and hampers movement. Pain is restrictive. Nor can man be of highest use unless he is also spiritual; for only when spiritual can he perceive what he should do to be of real service. And only when spiritual does he operate from a plane of frequency high enough to do the best class of work.

Yet an individual who is idle, or an individual who is destructive, or an individual who is a burden upon others can not have any high degree of happiness; for any high degree of happiness implies a consciousness of self-esteem and a feeling of kindly helpfulness toward others. Nor can an individual have a high degree of happiness unless he is also spiritual. For unspirituality coincides with grossness, and grossness is incapable of experiencing the fine feelings and intense consciousness that alone yield great happiness.

Furthermore, because spirituality rests upon tuning up the dominant vibratory rates of the individual to permanent high-frequency through cultivating certain thoughts and emotional states, there can be no spirituality not based upon constructive work and happiness. That is, the unselfish desire to be helpful to others which inspires and accompanies the better class of constructive work, builds up the spiritual vibratory rates. And real happiness, also, through intensifying the vibratory rates, conduces in a similar way to building up the spiritual body. Happiness and effort to benefit others both yield spiritual vibrations.

Control Must Be Commensurate With Energy Volume

—Not only should it be apparent that an energy is capable of being diverted into either destructive or constructive channels, but it should be equally apparent that when an energy is tapped in too great volume, irrespective of desire to use it constructively, it breaks away from control and usually brings disaster.

Driving a car around a curve in the highway, if the speed is too great, in spite of the good intentions of the driver, it escapes from the road and piles up in the ditch. Even on a straight course under the most favorable conditions, as exemplified by the attempts to break auto speed records at Miami Beach, if too great speed is attained it results in ruin.

It used to be said of the White Steamer Auto that it could go much faster than anyone could hold it to the road. That is, there was more energy than the driver could properly control. And I might go on to show that too heavy an electric current burns out a lighting system, that too much water in a canyon tears out or overflows the dam built to gather its power, that too much wind destroys the windmill, and that too much of any kind of energy becomes destructive because it cannot adequately be controlled.

And having said this, I may take another step and say, as the result of observing people for more than half a century, and of contact with occult aspirants for over forty years, that most people generate normally about all the mental and psychical energy they can properly handle. When an individual is well poised enough so that he never loses his temper, never becomes irritated, never permits himself to feel fear, anxiety, or any other disagreeable emotion, he proves that he has the energy at his command well under control.

But the most touchy people I have ever contacted, those irritated at the least, and who fly into a tantrum when things do not go just right, have been some who live what they believe to be unusually spiritual lives. One man, living near Los Angeles—just to give a concrete illustration—who is so holy that he never wears shoes, does not cut his hair, never wears a hat, and is looked upon by many as a saint, flies into a rage at the smallest provocation and curses his burros and beats them unmercifully. Another similar saint whose hobby is breathing, diet and few clothes, when others do not agree with his beliefs, gets red in the face and shouts and storms around asserting that the others have no sense.

If you are desirous of meeting people who are easily upset emotionally, quickly thrown off balance by unexpected events, and who become unduly excited when slightly opposed in anything, just visit almost any occult colony. Not that colonial life is to blame; but commonly those who reside in such colonies have gone there to develop their spiritual qualities, and are undergoing some sort of training.

I am not condemning colonies. I am merely stating that I know many people who belong to these colonies, and have acquaintances who have lived in practically all of them. And I find that the average man of the street is much better poised than the average individual who lives in an occult colony. For the person who lives in such a colony usually strives either to develop new energy-sources, or places himself under some kind of nervous strain.

Again I must say that I have no fault to find with colonies. I only draw attention to their membership because there you can more readily find, and study the conduct of, numerous individuals who are living unnatural lives.

Because, as I have already pointed out, so few people have trained themselves to control and direct the thoughts and nerve currents they normally have, when these individuals begin to turn on new and unaccustomed energies through arousing the kundalini, through stimulating the chakras, through rhythmic breathing, or through any one of the dozen methods commonly advocated by those following Oriental procedure, they quickly get into a lot of trouble.

I do not say that these methods as used in the Orient get those there into such difficulties; for there the teacher may train his disciple for years in the art of thought control before permitting him to start playing with new energies. And here in the West, when we are thoroughly established in the habit-system of at all times directing our thoughts and controlling our emotions, no harm can come from taking on, through breathing, for instance, an additional energy supply. But the energy supply should never be developed, as it so often is among those mentioned, to a volume too great for continuous and perfect control.

A man or woman who flies into a temper, who worries, who becomes sad, who experiences fear, who is irritated by what husband or wife does or says, who cries, who becomes despondent, or who permits himself or herself to have any disagreeable emotion under even the most trying circumstances, has all the energy already present that can be handled with safety. And the individual who cannot keep his thoughts from wandering to some particular object or particular subject, should better avoid psychic experiences until he can learn to focus his thoughts, like the beam from a spot light, on the region he chooses, to the exclusion of everything else.

This is not merely the opinion of the Western School of occultism, but also that of the Oriental School; for the Yoga System emphasizes the same thing over and over again. But Western students, in a hurry, and hoping to find a short cut and avoid arduous work, too often ignore it.

Furthermore, these bodies we possess are inherited from ten thousand generations of ancestors; in fact, they are inherited from a time when the only life on earth was single-celled in form. A minute portion of that single cell has come down to us without suffering extinction on the way, and as it came it subdivided, developing organs that through division of labor have constructed a very complex organism. And this complex physical organism we now have has very gradually developed many distinctive traits.

Not all of these traits, these ways it has of doing things, or the things it does, are the best that can be thought of; but they are the ones that, through countless repetition, have become firmly fixed in our inheritance.

Now there can be no question but that certain improvements in the way this physical body performs are desirable. It is desirable that it shall live on certain foods instead of those on which its ancestors mostly lived. It is desirable that certain fundamental urges be diverted into channels that are more acceptable to the present status of society. It is highly desirable that this organism become sensitive enough that it can be tuned in on messages and programs from the inner planes. It is desirable that psychic (astral) energies be developed in volume, so that they may perform work at a distance, and that nerve currents become more intense, to the end of using electromagnetic energy to produce wonderful phenomena. These, and many more that might be mentioned, are all within the possibilities of what can be done with the human body under control of a highly developed mind.

But this body has not been accustomed to these things, and its ancestors have not been accustomed to them. Therefore, if the desired condition is forced, if a very delicate process of development is not observed, the balance of the whole organism is disturbed. It is possible to cure virulent germ diseases by saturating the body with mercury. If enough mercury is given the patient it kills the disease, certainly. But it may also kill the patient. And even when it permits the patient to live, it is a long, and often impossible process to get the mercury out of his system.

By far, too many occult schools adopt a policy toward their neophytes which is comparable to saturating the body with mercury to cure its ailments. With a completely distorted view of what is meant by spirituality, they have decided that the animal propensities in man are all different, but malignant, types of spiritual diseases. And they set about the task, with great vigor, of killing them out, regardless of how the patient is weakened, or even destroyed, in the process.

Animal Propensities

—Yet, in truth, these animal propensities, which nature has been ten thousand generations building, are the only source of energy which can be utilized for spiritual purposes. If one has never acquired the desire for self-preservation, how is he to acquire the more complex desire for race preservation? If one has never developed the ability to benefit himself, how shall he learn the technique, which is still more difficult, of effectively helping many others? If he has had no experience with loving one individual, how shall he learn to love all mankind? If a man has no capacity for being happy, how does he know what will most conduce to the happiness of others?

The fundamental desires of the animal are transmitted by inheritance to man. And should he succeed, through some artificial method, in destroying them, he would have nothing of any worth left. He would be a negative, listless individual, who would have that greatly heralded quality of “detachment.” He would be so “detached” that nothing would matter to him, and he would do nothing, and his spirituality would be about on the level with that of a piece of driftwood floating down the river.

“Detachment” is the opposite of love. We attract things or conditions when we think about them, or when there are thought-cells within ourselves that have been organized by consciousness, of a similar vibratory rate. To visualize a thing, and then to feel intently about it, tends to attract it. But when we feel intently about something we certainly are not “detached” from it; we are, on the contrary, attached to it. But unless we are, either consciously or unconsciously, able to feel about a thing, we are unable to affect it in any significant way.

It is certainly not through becoming “detached” that we become spiritual, but through becoming attached, just as strongly as possible, to those things which are spiritual in quality. The more intense the desire for a quality, the quicker that quality is developed.

Energy, under the direction of the soul, is directed by feeling. A “detached” individual implies lack of feeling about things. But the stronger the feeling is to perform spiritual acts, and the stronger the feeling is to refine the thoughts and inclinations, the more will spiritual acts be performed, and the more will the thoughts and inclinations be refined toward truly spiritual vibrations. Which all means that if we are to become spiritual we must determine what things and qualities are spiritual, and then cultivate as great a joy in these things, as great an attachment to them, as it is possible for us to form.

In truth, however—although many occult schools have so failed to keep abreast of modern experimental psychology that they are unaware of it—those who attempt to deprive their fundamental animal propensities and think they have risen above them, merely suffer an illusion; for the propensities manage to find a substitute outlet elsewhere. It may be set forth as a general rule that the suppression of any fundamental urge or function merely drives the energy of that urge or function into some less obvious, and less beneficial, channel of expression. Those who attempt such suppression unbalance their nervous systems, or otherwise disorganize their faculties; which explains why those who follow prevalent methods of occult training so often are flighty, unreliable, and easily aroused to uncontrolled emotions.

Yet it is true that so long as the animal propensities express in animal-like channels there is always an absence of spirituality.

What must be done by the neophyte seeking the healthful and normal highway to spiritual attainment, is gradually to lead all his fundamental animal desires and propensities, as well as those not so fundamental, into methods of expression which will give them full satisfaction and at the same time build spirituality.

There is not one of the fundamental urges—love of the opposite sex, desire to live, desire for self-esteem, desire for self-expression, etc.—which cannot find satisfaction in a manner which will conduce to all the three most highly desirable things in life: service to society, happiness, and spirituality. That is, each can express in a manner which refines the emotions, gives pleasure, and aids in some manner to give the ability for useful work.

How these desires may thus be led to find satisfaction and enjoyment in the channels of expression which have been selected as more befitting the spiritual man has already been set forth in lessons No. 155 and No. 156 in connection with the formation of new habit-systems. Through the gradual formation of new habit-systems the animal is not killed, but is deliberately transformed into the spiritual man.

Psychic Development

—Such character development may be accompanied by practices which tend to make more active the psychic senses. These psychic senses are the organs by which we are made aware of what is taking place through inner-plane perception.

There is nothing unnatural about using the faculty of clairvoyance, the faculty of psychometry, the faculty of clairaudience, the faculty of thought-transference, or any other psychic faculty. They are the use of the sense organs which, in less than one hundred years when we no longer have a physical body, we will commonly use. Nor does their use necessitate negativeness.

Feeling Extra-Sensory Perception is present when the nervous system becomes sensitive enough that the electromagnetic currents flowing over it are able to pick up, and the nerves interpret, the inner-plane radiations of objects and events. Yet what is said about the danger of developing new sources of energy faster than they can be controlled likewise is applicable to the development of such sensitivity. Sensitiveness should never be developed faster than the ability to determine what vibrations will be received is developed. This insures that one is not subject to the call on the phone connecting with the invisible world except when one wants to listen, and that one does not have to listen to someone whom one does not care to hear.

The most valuable faculty anyone can possess who becomes somewhat sensitive to imponderable forces, is the ability to hang up the receiver and cut the connection whenever it is desired.

I have already, at some length, explained how this may be accomplished, and that when the connection is thus cut no invisible entity can have any influence on the individual. Yet merely turning the objective thoughts in a concentrated manner to some other subject often is not sufficient, unless the habit-system has become well established also to direct the full attention of the unconscious mind into the same channel. This is because feeling may be able to keep a part of the attention on the sensation felt, and this keeps the unconscious mind tuned in on the source of the feeling.

Under such circumstances, something must arouse some other feeling to an intensity greater than that induced by the invisible energy in order to turn the unconscious attention, as well as the conscious attention, from the invisible connection. In cases, therefore, when such an invisible influence once contacted tends to become obsessive in character, it may be necessary to have some quite exciting event happen, something that gives the person so afflicted an emotional shock, to break such an undesirable connection with an entity or thought-form. This is applying Induced Emotion.

Many people have nervous systems so sensitive that they exercise Feeling ESP without training or effort. But so far as training for psychic development is concerned, it is much better to direct the efforts toward developing Intellectual Extra-Sensory Perception. This depends not on picking up innerplane vibrations with the nervous system, but on extending the consciousness to the inner-plane information to be apprehended. While either intuition or inspiration may be experienced through Feeling ESP, more commonly it is the exercise of Intellectual ESP. When without any pronounced feeling, one has the conviction, apart from reason and the reports of the physical senses, that something is true or that some event will take place, such intuition is derived from Intellectual ESP. And when, without any pronounced feeling, ideas beyond the normal capacity seep into objective consciousness, such inspiration also is derived from Intellectual ESP.

Intellectual ESP derives from the Intellectual activity of the soul on the inner plane. The soul on the inner plane can either feel the radiations of objects and events and interpret these feelings, or it can apprehend them intellectually. Thus also, on the physical plane, one may feel the distress of some person in ill health, or one may investigate the symptoms intellectually without feeling any of the distress. And those who learn how not to feel the suffering of their patients make the most successful healers. Likewise, those who learn how to acquire inner-plane information through Intellectual ESP in which feeling is not a prominent factor, can use this ability without the annoyance of feeling disagreeable or perhaps even dangerous influences.

Consciousness can move out or it can move in. The necessity of keeping aware of outer-plane conditions, and reasoning about them correctly, in order to survive in the physical world has developed the habit of keeping the consciousness out. This is termed objective consciousness. But if cerebral thinking ceases, except to retain sufficient awareness to keep from going to sleep, the consciousness can be thrust down and back to function on the innerplane and become aware of the objects and thought-forms of this high-velocity region.

Of course, merely ceasing cerebral thinking does not insure that the soul becomes active gaining information on the inner plane, no more than the fact that an individual is objectively conscious implies that because of being thus conscious he is gathering and reasoning about outer-plane information. Inhibiting cerebral activity merely withdraws the attention from outer-plane activities and gives it the opportunity to focus on inner-plane conditions. Whether or not it takes advantage of this opportunity depends on the electromagnetic energy with which it is directed. What is it on the outer-plane that permits one person to gain and remember information of value while another person in the same environment learns almost nothing? It is chiefly the difference in habit-systems. One has developed not merely the desire for information, but the habit-system of becoming cerebrally active in the determined effort to realize this desire. The other perhaps has just as good brain-cells, but either has a less strong desire for information, or has not developed the habit-system of becoming resolutely active in realizing his desires. He does not mobilize electromagnetic energy to produce the required kind and intensity of cerebral activity.

With training, an individual can learn how to inhibit cerebral activity and shove his consciousness out on the inner plane to acquire knowledge not possible to acquire through reason and the physical senses. But information thus contacted does not necessarily reach his objective awareness. To impress his brain and thus become perceived by objective consciousness, the information sought and gained by the soul on the inner plane must be able to mobilize and use enough electromagnetic energy successfully to compete with the electromagnetic energy mobilized and used by other thoughts and impressions derived from either the physical plane or the inner plane. Whatever is perceived on the inner plane resides within the soul, or unconscious mind, even as a physical experience which has been forgotten resides thus also within the unconscious mind.

In either case, to affect objective awareness this memory must be able successfully to compete for attention with other thoughts and impressions. Therefore if there are imperative unconscious desires struggling for attention, these may either prevent what was perceived on the inner plane by the soul from getting recognition, or they may warp and distort it as it impresses objective consciousness. And if cerebral activity of any kind, such as common objective thinking, is taking place it may be, and usually is, impossible for the ESP information to mobilize enough electromagnetic energy to compete for attention with these images and thoughts. In this case, even when the soul on the inner plane has sifted the desired information from other innerplane images it has contacted—and such discrimination requires practice to exercise at will—the information continues to reside within the unconscious mind as a memory of which the individual perhaps never becomes objectively aware.

Even as accomplishing work on the outer plane and acquiring information on the outer plane become possible through training, so doing work on the inner plane and gaining knowledge on the inner plane also become possible through proper and persistent training.

Psychic Instability

—As the subject of innerplane work has been brought up, it may be well here to mention certain organizations which are always accusing other organizations and people of different belief of using black magic.

As a matter of fact, there are very few organizations in existence on the physical plane which do very much in the way of black magic. Nearly all the various occult schools, and the colonies which I mentioned earlier, are composed of earnest, well-meaning people who have no real desire to injure others, and who really aspire so make the world better, and themselves to become more perfect.

Some of the members of such organizations, however, become unduly sensitive. Also they are violently intolerant of any belief other than that which at the time they entertain. Thus they connect up with those on the inner plane of similar intolerance of belief, and become accustomed very thoroughly to the vibratory rates and thought-form vibrations of the particular school or organization to which they belong.

While they are in a region permeated with these thought-vibrations to which they have become accustomed, and in contact only with people of belief similar to their own, they feel quite at peace with the world. But, because they are so sensitive, when they come in contact with some individual who has positive beliefs which are quite at variance with theirs, they at once intensely feel the clash of incompatible thoughts. When they come into contact with some organization which holds to ideas displeasing to them they are quite upset by the clash of vibrations. And because they feel this discord, which really arises from psychic instability, they think, and say, that others are black magicians.

What I mean by psychic instability is the condition that arises when people have undergone training which so places their feelings on edge that any slight inharmony is exaggerated by them to feel like an overwhelming force. In the world of affairs a certain amount of give and take is essential to getting along with others. It is not to be expected that all people shall agree in detail. Two people should not, and under normal circumstances do not, feel distress because they do not completely agree. But under forced development of psychic sensitivity, even a slight jarring of thoughts that are not compatible is sufficient to give the individual so afflicted the “jitters” and cause him to think he is being attacked by “black magic.”

Discerning the cause of such reactions to be the unbalanced psychism of the individual, I always look askance at the methods of those groups which make much of black magic persecution, or which seem to think that every group which does not agree with them must be black magicians. There must be something wrong with the method of training they use or their students would not get into such an abnormal condition.

Invisible Brotherhoods

—All mental practices which are grounded in the desire to injure others or to gain a selfish advantage over others are virulent diseases of the soul. But it is never wise for a doctor to think too protractedly about any disease; for in so doing he is apt to develop the disease in himself. Cancer specialists, for instance, with unusual frequency die of cancer. And it is even more dangerous, because more contagious, to let the mind dwell too much on the “brethren of the shadow” (really invisible racketeers and gangsters), or on inversive forces.

I believe every occult student should be informed in detail just how these malicious and destructive intelligences and forces operate, so that he can distinguish their activities when present, and so that he knows just how to avoid contact with them and how to protect himself and others from their cunning. But as soon as he has accomplished this, the less thought he gives to such matters the better; for thinking about them much tends to ring them up on the invisible telephone.

With such a comprehension of processes, he will certainly not use magical symbols with whose import he is unfamiliar in the effort to arouse energy, accomplish work through invisible forces, or in attracting Invisible assistance. In fact, unless he has completely lost his common sense, he will avoid both black magic and ceremonial gray magic completely, and will no more think of trying to use elementals to get something done than he would of taking a trip to the arctic with the purpose of trapping a pack of wolves to make them serve him.

It is permissible to use rituals of a spiritual character such as are used in many religions. And it is permissible to use the rituals of lodges and organizations which are known to work consistently for human betterment. The Masonic ritual, for instance, when understood, may not only intensify the emotions, but tends to connect the individuals with those of the lodge on the inner plane. And if one is a member of some organization which works energetically to help and enlighten people, there can be no objection to asking the invisible brethren of that organization for assistance. And in making the contact, the ritual, or the symbols, of the organization may be employed ceremonially.

But in asking help from the invisible brethren of such an organization, or in taking part in the ritual and worship of any group with which you have sympathy, it should be remembered that the general attitude of the invisible members tends to be shadowed in the attitude of the membership on the physical plane. If the physical membership seem unbalanced, morbid, nervously irritable, and not useful citizens, you may be sure that the membership on the inner plane have similar characteristics; for those on the inner plane who yet belong to it have not changed greatly since passing over.

If you find the membership of an organization on this plane to be narrow in their views, intolerant of any ideas but their own, with a tendency to keep others from thinking, reading about, or getting acquainted with, anything that does not confirm the beliefs they hold, you may be sure that the invisible membership also, in so far as they are contacted, and in so far as they can make their influence felt during the ceremonial gatherings of those on earth, will make strenuous efforts to blind anyone taking part in the ritual, or who is present, to everything but the creed which they advocate. Therefore, in taking part in such ceremonies, even when the general trend of aspirations of those present is high and helpful, bear in mind that those who are ignorant, but well-intentioned, often are violently opposed to truth and progress; and that under such circumstances there is often present a strong psychic influence that discourages the acquisition of information and strives to dominate the beliefs. Other than this influence of religious and other organizations to bind the individual to their views, which may be determined from a knowledge of the membership, the spiritual benefit, or otherwise, to be derived from attending such a gathering can be determined quite accurately from the feelings. If, upon leaving such a gathering, ceremony, or place of worship, there develops a feeling of dejection, of discouragement, or worry and discord, or other low-vibration feeling, you may be sure that the imponderable forces thus contacted are detrimental. But if the feelings that follow, and which are sustained, are those that give buoyancy, which encourage the desire to perform some good deed, which engender tenderness and unselfishness and a high aspiration for a noble life, you may be sure that the imponderable forces contacted have been constructive and—other than possibly limiting intelligence quite—spiritual.

The same criterion may be applied to almost all the circumstances of life in determining whether they are beneficial from a spiritual standpoint or not. It is applicable as a test of the spiritual value of music, of other entertainment, or of social relations.

Sex Magic

—Because passion associated with any selfish objective is a coarse and base emotion, it should be apparent that sex-magic is a delusion and a snare. That is, while it is true that the emotions can be aroused to a height of magical possibilities through sex, where love is not the dominant motive for sexual expression the element of selfishness is so strongly present that only energies of the lower astral region can thus be contacted. Those, therefore, who try to use sex magically to attain worldly prosperity, to injure others, or to gain some unfair advantage, connect up only with the scum of the invisible region. And such use of sex for magical purposes is destructive to the soul and detrimental to spirituality.

On the other hand, sex is the fountain from which springs true, unselfish love. Unselfish love is not concerned with benefiting self; it is concerned with tenderness, helpfulness and the welfare of another. And this unselfish attitude engenders an intense longing to be noble, to be of some vast service to the world, to be better in every way, and to help others to be better. And, in so far as the kind of imponderable forces contacted is concerned, and in so far as the spiritual effect is concerned, it is the type of emotions, and their intensity that count.

We can state it as a general rule, therefore, that whenever domestic or social relations—irrespective of what they may be—engender tenderness, loving solicitude, unselfish desire for greater service, a lifting of the mind to higher and nobler things; these things raise the dominant vibratory rate, and are spiritually beneficial.

Fear, on the other hand, is a destructive and unspiritual emotion. It tends to tune the individual in on the very thing feared. And the most potent avenue of any malignant invisible force is through the fear it engenders. But, as I trust I have shown in this course in detail, there is really nothing to fear from “black forces.” Astral gangsters do exist, and physical persons who try to gain an unfair advantage through psychic channels have not become extinct; but the individual who knows that they can only reach him when he tunes in on them through thinking intently about them, or through fear of them (which is one way of thinking intently about them), is quite fully protected by the application of this knowledge.

After all, destructive imponderable forces are merely the carrying to the astral plane of propensities that nature has been at extreme pains to develop on earth. They are merely a continuation of the animal nature. But none of this animal nature can exist above the astral. Even animals and plants continue to live in the astral; but their vibratory rates are not high enough, nor are the vibratory rates of the animal soul of man high enough, to in any way affect spiritual substance. Therefore, while the destructive intelligences and thought-forms we have been considering persist for a time on the astral plane, they never reach nor influence the true spiritual world. They have, thus, no immortality.

To build up positiveness and initiative, which in spiritual realms will be used exclusively for constructive purposes, Nature sent the soul through the lower kingdoms of life. Life on earth is a constant struggle for survival. One form of life exists only at the expense of another form. Big fish eat little fish, and these eat those smaller, while the smallest fish feed on diatoms, which are single-celled plants; and even vegetarian man lives at the expense of the vegetable kingdom.

In addition to other enemies, nearly all types of life suffer also from some kind of parasitism. The chief diseases to which man is subject, for instance, are due to minute organisms endeavoring to live within his body at man's expense. Everywhere—from mineral up to the Wall Street banker who floats an international loan by which he takes advantage of the trust placed in him by the public to sell them foreign bonds that later turn out to be worthless, in the process of gaining a fat commission for himself—everywhere in the animal domain we find organisms trying to gain an unfair advantage over others. It is the law of the survival of the cunning and the strong. The racketeers, high-jackers, and criminal gangs of our cities, and the so-called inversive brethren of the inner plane, are merely yet living under this law of animal life.

But when evolution reaches the state of man, if it is to continue, the law of survival is broadened to embrace a universal scope. It cannot develop above the astral while dominated by so narrow a view as that the individual, or group, is the important survival unit. Evolution, to continue according to the Divine Plan, must be broadened to the conception that the Cosmic Whole is the thing which must survive at all costs.

Spiritual life is dependent upon the correlation of the individual to cosmic advancement. To survive in spiritual spheres he no longer must think first of himself, but he must think first of the welfare of universal society. In the animal kingdom he has developed his constructive powers; but to survive on any plane above the astral he must use these powers for universal service. This is the law of spiritual life and of Immortality.

But still existing in the lower astral regions, and still existing on earth, are many individuals who have developed a cunning intelligence, but who as yet have not attained to this cosmic viewpoint. They will have opportunity in the astral of the next life to develop it, but as yet they are essentially still animals; for the human form does not of necessity confer spirituality. And as I say, there are many human animals on both planes who have as yet developed no more spirituality than a tiger, or than the protozoa which, in the blood stream cause malaria and its chills and fever.

We who have acquired at least the rudiments of spirituality must continue for a time to live in a world which contains among its membership those who have spirituality in various degrees, and others who have cunning intelligence but who still live in that stage of evolution that ruthlessly destroys everything that stands in the way of its own selfish advantage. Thus living, we are privileged to lead such lives, at least to an extent, as those live who occupy the real spiritual world. For we can so order our lives as to make all our efforts constructive; and we have unusual opportunities for spiritual work in leading others into spiritual enlightenment.

But in addition to this more direct spiritual work, we cannot afford to forget that we still live on a plane, visible and invisible, that is largely dominated by the might-is-right, take-what-you-want-if-you-are-smart-enough motive of the animal kingdom. In order to preserve ourselves, and to secure opportunity by which others can have access to truth and spiritual knowledge, by which others shall live under such economic and educational conditions as will not stifle their spiritual aspirations and noble efforts, we must be constantly vigilant to prevent the unspiritual from dominating the situation.

And because the unspiritual of both worlds commonly resort to certain types of endeavor in order to accomplish their selfish ambitions, we should understand their methods thoroughly, and exercise a constant guard against them.

Let us remember, therefore, that the easiest way by which another can get what he wants at our expense is commonly through influencing our desires and opinions. If he can cause us to want something, no matter how untrue, how devoid of reason the method he employs, he has taken the longest step toward selling it to us.

Even if it is a lie, if he keeps shouting at us from bill-boards, from newspaper advertisements, from the radio, that something is a fact, unless we stop and analyze it, we become in our unconscious minds convinced that it is true. Not only so, but if it implies something else which is not really stated, we will tend to become convinced that the implication is true, and may act upon it. The habit of careful analysis of facts is the only safeguard against such methods.

Politicians, when they wish to put something over which is unscrupulous, often resort to the expedient of kicking up a big furor over something else which is of no real importance. While the public is heatedly debating this unimportant matter, the politician unnoticed slips in and gets what he wants, and goes his way. And this same method of creating confusion is employed by invisible gangsters also, to get ideas

about the occult and about psychic matters accepted that will make such dupes on earth readily susceptible to their control. Amid a jumbled medley of notions, some of which are true, and others of which are heatedly debated, they slyly inject some pernicious doctrine which escapes analysis in the subsequent discussion, but which enables them to get certain less keen individuals within their power.

But whether such propaganda comes from those on the physical plane, or from “big-shots” in the astral slums who have lieutenants on the physical plane, it can be detected by those who take the trouble thoroughly to test it out. This method of testing is first to secure all the facts possible about the matter. Consult those who oppose as well as those who advocate. Then consider what the individual or group is trying to sell, why he is trying to sell, and what methods are open to him to create a favorable sentiment. And finally give facts and motives a very careful analysis.

Under such a rigid scrutiny your favorite breakfast food may not appear quite so attractive, you may not be so keen to walk a mile for a smoke, you may not be convinced your political party will be able to save the nation at once, and you may even find yourself relinquishing some religious belief or some pet doctrine. But for these various apparent losses you will be more than amply compensated by the satisfaction you will derive from the assurance that you are now, and without confusing detour, traveling in the proper direction, along the wholesome pathway.

Book 19

Copyright
August 2002
Church of Light

Organic Alchemy

Chapter 1

Serial No. 209
Original Copyright 1944
Elbert Benjamine

Copyright
August 2002
Church of Light

The Ceaseless Surge of Life

Chapter 1

The Ceaseless Surge Of Life

The tide of life surges ceaselessly upon the shore of our tiny planet. And the line between the organic and the inorganic is so thin that even the clairvoyant gaze is often unable to differentiate it clearly. For life abounds on every hand, in forms commonly considered insensate as well as in more complex structures, and in regions where our dull physical senses can perceive only a void. It permeates all existence, throbbing and pulsating; as diffusive and pervading as sunlight on a cloudless day. And this abounding life, of which we each constitute a single moving spark, has a meaning which is well worth our effort trying to discern.

But the endeavor to encompass the significance of life by considering man as some special creation, as do the orthodox, or even by considering him as differing in kind from the other struggling entities, visible and invisible, by which he is surrounded, is like attempting to perceive the meaning of a tadpole while ignoring the egg from which it came and the frog which it later will become. And because the physical is but one velocity realm on which life exists, we cannot comprehend it by considering one plane of existence alone. No more so than we can perceive the meaning of the tadpole if we consider solely the water in which he now swims and ignore the land over which the frog will hop.

The expanse of life is so illimitable, and the forms it assumes are so infinitely diverse, that the puny human brain can at best perceive only a minute section of it. What can come directly under our observation is but a drop in the ocean of life. Yet, even from a drop of ocean water, by careful analysis, we can get a very good idea of the nature of the substance which covers three-quarters of the surface of the earth. Let us, therefore, bring under observation of both the physical senses and the psychic senses the drop of the ocean of life by which we are intimately surrounded.

The first impression one gets when thus viewing life, is of the infinite number of separate life entities. We know, for instance, that our sun and billions of other luminous bodies in the firmament, radiate light. Each tiny photon of light has its own individuality. How many such photons are sent out from our sun each second? Too many for human comprehension. Yet in so far as science has been able to determine, a photon of light thus sent out from our sun, unless it meets with some obstacle, travels on and on, without ceasing; and has the same energy and velocity a million years after it started that it had at first.

The giant telescope on Mt. Wilson receives light from distant nebulae that started on its journey at the time the Trinal Ape Man hunted through the jungle of Java, while elephants and sabre toothed tigers roamed the plains about Los Angeles, and before the age of ice came down on Europe and North America with its grip of rigid cold.

Life has its parallels with light. The number of its individual entities is beyond calculation or comprehension. But once a little photon of it is radiated from the Infinite Mind, it travels on and on, without loss of momentum, in the direction it is sent; nor time nor space diminishes its energy. On and on it travels, and never reaches the end of its glorious journey.

Abundance of Life-Forms

—The abundance of life, like the number of photons of sunshine, staggers the imagination. How quickly a slice of bread or a piece of cheese, left in a moist place, accumulates a coating of mold! This mold, like rust on wheat and smut on corn, is vegetable life. It is a fungi, the spores of which, too small to be visible to the naked eye, float about in the air. The moisture assists millions of such minute plants to grow. Food isolated from such spores is not thus affected.

A still lower form of life is responsible for the decomposition of both animal and vegetable forms that have died. This is a valuable function, too; for if a leaf never decayed, a tree remained just as it fell, and flesh retained its form except when devoured by other animals, the food elements of earth would soon all be stored in the carcasses of the dead, and none left to support succeeding generations. But the bacteria attend to this. And how numerous they must be that so soon animal and vegetable matter, from which the dominant entities have departed, should undergo decay!

A small sample of air, from almost anywhere, when placed under a microscope, reveals a host of minute living forms. And a drop of water likewise examined may reveal a swarm of animacules.

Think of the extent of the ocean, and that on and near its surface, live an infinite number of minute entities. These free-floating organisms of the sea are called plankton. I shall here speak of but two types of them. One embraces the diatoms, which are microscopic vegetables having a glass shell. It is to these diatoms, chiefly, each in life secreting its minute quantity of oil, that geologists attribute the formation of the oil deposits of the Pacific Coast. The oil manufactured a few million of years ago by these tiny plants floating about on the water, so small as to be invisible to the naked eye, now drives a car along the streets of the city, over the very spot where, when their physical span of life was over, they sank to rest.

Of the little animals embraced within the plankton, the Foraminifera are like the diatoms in having a shell-like covering. One genus of them, the Globigerina, are particularly abundant; and these, together with the diatoms, fall in immense numbers to the bottom of the sea and form either diatomaceous ooze or Globigerina ooze. And it is interesting to learn that telegraph cables raised from the depth of two miles show that the bottom of the ocean at that depth is composed almost entirely of the chalky shells of the little animals, Foraminifera.

This ooze, in time, becomes fossilized into rock; and the stone of which the city of Paris is built consists of the fossilized shells of such Foraminifers.

Then again, the pyramids of Egypt are built of nummularies, which is another genus of Foraminifera. As in one ounce of this stone it is estimated there are four million of these once-living animals, the number which is contained in these massive monuments alone is inconceivable.

I might go on to explain how certain limestone mountains have been formed by the secretions of single-celled algae, how certain iron-ores of vast extent are the residue of bacteria, mention the extent of coral formation, and otherwise draw your attention to the incomprehensible number of life entities that both in past and present have made the earth their abode. But any further enumeration of examples could not expand the grasp of the mind in its conception of the number of living entities. Like the separate photons of sunlight that beat upon the surface of our planet, the number of surging life-forms is beyond computation.

The Influx of Life To The Earth

—Like the photons of solar energy, a new innumerable host of living entities continually arrives.

From an inner-plane viewpoint, they are already adjacent to the earth, awaiting opportunity to manifest in form. But this does not mean that they are in three-dimensional proximity to the earth. Instead, it means that the astral world, which is a high-velocity realm, and consequently has different properties than the physical world, is crowded with these life-forms. And they are adjacent to the earth only in the sense that they have a vibratory rate not dissimilar to the vibratory-levels of this physical planet.

Things in the astral world which have a similar vibratory rate are in close proximity to each other in much the same way that when you tune your radio to the frequency used by a certain broadcasting station the individual who is then speaking into the microphone is in close proximity to you. Although his physical body is perhaps across the continent, you can plainly hear what he is saying. In the astral world, however, either entity can become the broadcasting station and cause the other to feel its influence.

Thus when I say that untold myriads of life-forms are in the proximity of the earth, I do not refer to three-dimensional proximity, but to vibratory proximity. Yet when the vibratory-rate proximity of any two astral things is close, no matter how distant they may be in the three-dimensional sense, it takes but a slight desire, or attractive force, to permit them to influence each other physically.

By reason of its high-velocity, the properties of the astral world often seem to contradict all our experiences. And this property by which an individual can transport himself instantly to a distant spot—as witnessed by an individual on earth who in sleep appears and manifests to others on the other side of the earth, and the next instant is awakened by someone and is again in his physical body—is one which is contrary to more common experience. Yet in the astral world if one thinks intently of a spot, and desires strongly to be there, no matter how distant, if its basic vibratory rate is not too different, he almost instantly finds himself in that spot.

It is something that, due to our experience with low-velocity existence, is a little hard for most of us to realize, but it is nevertheless a fact, that the real distances which separates things are not those of space, but are those of vibratory-rate level. The mind can travel a billion miles almost instantly; but to traverse from a habitually slow vibratory rate to a rate of intensity habitual to the angels may take aeons of time.

When, therefore, I say that seen by clairvoyant sight the proximity of the earth is crowded with an infinite number of life-forms, I wish it to be understood that this proximity is in the vibratory-rate sense. These entities have a vibratory-rate level very similar to the dominant vibratory level of the astral bodies that occupy physical bodies on the earth. How far from the earth, or how close, in the three-dimensional sense is unimportant.

I have already spoken of nebulae so distant that it takes light, traveling 186,300 miles a second, a million years to reach the earth. But in thought you can travel to such a nebula almost instantly. And if, while out of your physical body in the astral form, you could tune in on it perfectly, you would almost as instantly find yourself there. As a matter of fact, however, you would find such a journey not so speedy as this. But this would be due to the difficulty of tuning in exactly on the vibration necessary, rather than to the three-dimensional distance to be traversed.

It is true that three-dimensional distances have a meaning in the astral world, just as two-dimensional and one-dimensional terms have a meaning on earth. But due to high-velocity properties of the inner plane, three-dimensional distances entirely lose the importance they have here.

That three-dimensional distances have a meaning, but lose their importance on the inner plane can be illustrated in this way: Mentally you can perceive two objects, each having on the physical plane three dimensions, and mentally you can perceive these objects at a given distance from each other. Or you can visualize some road you have traveled, or even some road which has no physical existence, and mentally see the trees, fence posts, telegraph poles and houses along this road. These are stationed, according to three-dimensional experience, at certain distances from each other. Therefore these dimensions have a meaning. But if you, or some other person in mental sympathy enough with you to perceive what you thus visualize, try to measure the distance between these mental (astral) objects, you will find the distances between them cannot be measured with a three-dimensional instrument. How high, for instance, in three dimensional space, is a tree which has no physical existence? Or how high is the image in your mind of a tree which has a physical existence?

Because distance on the inner plane is of a different order, when I say that all astral space is literally crowded with life-forms in all conceivable states of development, I am placing no three-dimensional limits on the space included. And however distant, in the three-dimensional sense, these life-forms may be from the earth, whenever the astral substance associated with a physical form has the same vibratory rate as some astral entity, this vibratory sympathy constitutes a proximity of the two in the real sense. And if the physical form is not already dominated by some entity, and is such that life can express through it, the astral entity, through this rapport, can instantly take control of the physical form. So far as being a hindrance to forming a contact with a physical form, three-dimensional space is negligible.

Camille Flammarion was one of the first great experimenters with psychical phenomena to note that whenever physical conditions were such as to permit the expression of a given type of intelligence, that intelligence was always present to make itself known. Other scientists who have studied psychical phenomena have noted the same thing. The difficulty of producing any of the startling types of supernormal phenomena is not in attracting some entity to manage their production, but always in preparing the suitable physical conditions by which the manifestation can take place. If the conditions on earth are right for a given manifestation, there is always an intelligence present to direct it.

This is because, irrespective of three-dimensional distance, entities of similar vibratory rate are already in close proximity. And when the physical conditions become such that an astral intelligence can manipulate them, there is always an astral entity of similar vibratory rate somewhere in space—but in the vibratory sense in close proximity—which responds to the desire of those seeking the phenomena. Or it may handle the phenomena irrespective of the desires of those on earth, merely because the conditions are such that it can do so, and of its own desire.

I am not here going into the various phases of mediumship; as they are discussed fully in Course 1. But I do wish to point out the intimate and vibratory relation between the physical and the astral plane, because without an understanding of this no proper comprehension of the processes of life can be had.

For instance, physical life propagates itself through cell-division. When an amoebae divides there are two cells instead of one; and there are two intelligences, one for each cell, instead of one. Where did the second intelligence come from?

How Higher Intelligences Move In

—The materialist would say that the intelligence is merely the manner in which chemical substances are arranged. I have shown in lesson No. 56 (Chapter 1, Course 5, *Esoteric Psychology*), however, that the intelligence resides in the astral substance associated with a living thing. And when a cell divides, the intelligence it originally had remains to dominate one of the resulting cells, and an intelligence of similar vibratory rate moves in from the astral, to take charge of the other cell. Whenever the physical conditions will permit, there is always a life-entity from the astral plane eager to take charge of a physical form.

The bodies of living things are composed of cells, and each of these cells is dominated and directed by an evolving soul. The growth of the body of an organism takes place through the multiplication of its cells through cell-division. And as fast as new cells are thus formed, through the division of old cells, new souls having a development of intelligence sufficiently advanced to take charge of a single cell move in. For every living cell there is an intelligence directing its functions. And the human body is composed of billions of such cells.

Single-celled plants and single-celled animals perform all the necessary functions of living, such as nutrition, secretion, excretion and reproduction. But the experiences such a life-form can have, and the work it can accomplish, are rather simple. Yet a colony of such cells, grouped as a single organism, often has better opportunity of survival, and a wider range of possible experiences.

Such plants and animals as we are more familiar with are colonies of cells, some of which more completely perform one function, and others of which more completely perform another function. That is, there is division of labor. Some cells grow resistant, to form the outer protective covering of the group, other cells become even more plastic, the better to perform the function of assimilation, and still other cells specialize in the function of reproduction. We speak of such a cooperative group of cells as an organism.

An organism affords the opportunity for an intelligence which is superior to that of any single cell to manifest itself. Furthermore, because the physical conditions are thus present for a particular type of manifestation, an astral entity is always there to take charge. As a matter of fact, through the operation of vibratory affinity, as soon as the physical conditions are present by which an intelligence more complex than that of a single cell can express itself, such an intelligence moves in.

More commonly an organism thus has in charge of its growth and other activities a single dominating intelligence, or soul. This soul, because of its past experiences, knows how to direct the development and functions of the particular organism. Within certain limits it is able to command obedience from the single-celled intelligences within its domain. It directs them in their activities.

The reproduction of an organism, either plant or animal, is commonly either through simple cell division, or through specially developed cells or groups of cells, such as seeds, spores, bulbs, runners and offsets.

A cutting from a geranium, or a limb from a willow tree, when placed in the earth under favorable circumstances will grow. It will develop into a mature plant which will bear leaves and flowers. If the soul which directed the growth of the parent plant remained with the present plant, from whence came the intelligence to direct the growth and development of the new one?

The material conditions being present for the expression of a given kind of intelligence, vibratory affinity causes such an intelligence to move in from the astral. An astral intelligence with experience enough to be able to handle the development of such a plant, and needing the new experiences for which this afforded opportunity, in each case was attracted to, and occupied, the plant which was separated from its parent. Just as soon as the conditions for a life apart from the parent stem was presented, there was an intelligence ready to grasp the opportunity and direct the activities of the newly independent life processes.

So also with seed and spore. These are cells which have specialized in the propagation of the race. Under certain conditions, as when the seed is fertilized, they afford the material requisites for the development of a physical life-form after the parent pattern. And whenever the material requirements are present, vibratory affinity attracts an intelligence of the necessary experience to take charge.

Life as it occurs on the earth signifies that, for the time being, an intelligence has found the opportunity by which it can undergo experiences in a physical form. When, for any reason, the intelligence occupying form and directing its processes is unable longer to handle these processes successfully, the organism begins to break up, and the entity is compelled to move out into the astral again. This is known as death.

Within the body of man, as within the body of complex plants and other complex animals, there is a constant outflow of cell-intelligences as cell structure is consumed in the life processes, and a constant influx of new cell-intelligences as new cells are formed to take the place of outworn tissue. The life of an organism, to the clairvoyant vision, is a process of lesser intelligences moving in, doing more or less as they are directed by the soul of the organism and, as their vehicle is destroyed, again moving out into the astral. They have rendered somewhat of service, and have gained somewhat in experience.

The kind of an organism occupied by any evolving intelligence depends upon the ability of that evolving intelligence to gain the allegiance of lesser evolving intelligences, such as those occupying single cells, and to direct their activities into building a form of a suitable type and functions. And its ability to gain such allegiance and direct such activities depends entirely upon its own past experiences.

Where it gained the experiences is not essential; but before it can be attracted to the physical conditions that will permit it to occupy a form of a particular type, it must have had experiences of sufficient complexity to afford it a preliminary training in handling such a form. Such preliminary training gives it a dominant vibratory rate of a particular type of life-form. As a result of this dominant frequency-rate, whenever the physical conditions are present for the manifestations of a form of this life-type, there is opportunity for it to move in and take charge. That is, there is opportunity for it to express itself in some physical life-form.

Competition For A Physical Form

—Throughout space there are other intelligences also which have developed a similar dominant vibratory rate. The physical conditions also present an opportunity for them to express, or be born, into earthly experience. But the one of these various intelligences, or souls, which actually takes charge of the growth and development of the new physical form is the one whose vibratory rates in their complex details—that is, the one whose past experiences—most perfectly coincide with the vibratory rates of the cutting, the bulblet, or fertilized seed which affords the opportunity for physical development. This law of vibratory affinity holds true alike for plants, for animals, and for man.

A walnut tree, for instance, is a particular type of life-form belonging to the vegetable kingdom. A fertilized walnut which has fallen to the ground, when the rains of spring cause it to germinate, affords the opportunity for an intelligence of a certain dominant vibratory-rate to take charge of the growth and development of a sprouting walnut tree. This intelligence has never previously had any experience with walnut trees. It may have never had any experience with any kind of a tree. But it has had experience with some lower form of vegetable life. It has occupied the form of some growing plant in the past. When it no longer could hold the allegiance and direct the activities of the still lesser intelligence of this plant, the plant died and it passed to the astral world.

On the astral plane it also existed as a plant, the counterpart of the physical one. And during this period of existence on the astral plane it acquired many additional experiences. And these, as well as those resulting from its experiences on earth, built the thought-cells of its astral form; the sum total of the states of consciousness thus acquired through all its experiences constituting its soul.

Life Also Develops On the Astral Plane

—It is a mistake to think of the astral world as static. Things on that plane develop and progress much as they do on earth. People who pass to the next life continue with their education and development. And likewise, the lower forms of life, when they pass from physical expression, continue to develop on the inner plane. Not only the experiences of physical life, but these additional experiences of astral life, at intervals are assimilated and reorganized.

The most obvious thing about life is its constant struggle and effort. And this struggle and effort, which we see in every living thing about us, does not cease when it passes to the next plane. Even as on earth, it is still eager for experience. And in this restless desire to advance it is assisted by cosmic forces, by tides of astral energy which have come to be known as life-waves.

Therefore, the astral form of the plant which we have been considering, by the time it is attracted to another physical form—incarnated in another plant—has made appreciable strides in its abilities. Its intense struggles to advance have brought it experiences which give it the dominant vibratory-rates of a germinating walnut.

It may never have lived as a tree. This, perhaps, is a long step physically from the simpler vegetable form it previously occupied on earth. But it has been carried forward by the tides of cosmic energy to a point where its desires for still further experience and development give it not merely the dominant vibratory-rates of the walnut tree type of life, but the detailed vibratory-rate of a certain germinating walnut. And it is attracted to, and becomes associated with, this germinating walnut, because its vibrations more nearly correspond to those of this walnut than do the vibrations of other astral plants having the walnut tree type of vibration.

The genes of the chromosomes of the germinating walnut are associated with the astral vibratory rates that carry the racial characteristics. The incoming astral intelligence which takes charge, now acquires these vibratory rates as a part of its own organization. And the latitude of its power to mold the developing form is limited by these racial vibrations which it thus acquires. These rates determine that the tree shall be a walnut and not an elm. And soil and wind and rain and the prevalence of insect pests and various other physical factors place still other limits upon its expression. But, nevertheless, the form which develops under the direction of this soul is an expression of its own powers and capacities.

During the lifetime of this tree the intelligence occupying it brings under command a myriad of simpler intelligences, such as those which occupy the cells of its structures. It directs that certain cells shall take on coarseness and become the protecting bark, that other cells shall perform the delicate and complex function of the Cambrian layer, that still other cells shall develop into sapwood. How much energy shall be devoted to leaves and how much to root structure, to

flowers, and to fruit are under the jurisdiction of its thought-cells. It does not reason about these things, no more so than our own intelligence reasons about how much tissue shall develop here, and how much there, in our own anatomy. These are functions of the thought-cells and thought structures of the unconscious mind, or soul. And the soul knows, because of past experiences, how to direct them.

But when the walnut tree dies it does not cease to exist. It may still be seen upon the astral plane, where it continues to live and develop. The astral plane is quite as real as the physical, and quite as capable of imparting experiences, although experiences of a different kind. The walnut tree gains new experiences as a tree on the astral plane. These experiences build in it new thought-cells. And in time it is carried forward, its experiences assimilated and reorganized, to a point where its dominant vibratory rates correspond to the dominant vibratory rates of some other and more complex life-form.

But you may be sure of this, having had experience as a walnut tree, it never has the detailed vibratory rates which are simple enough again to attract it to a germinating walnut. Its thought-cell structure, even at the time the tree it occupied died, is so complex as the result of its experiences as a mature tree, that it has no affinity for the simpler rates of a new walnut shoot. And, for that matter, as soon as any degree of assimilation and reorganization has been made, the thought-cell structure is too complex for the walnut tree type. It still belongs to the walnut tree type so long as it exists on the astral as a walnut tree. But as it develops on the astral plane still further, and has new experiences, its dominant vibratory rates become of a character quite different, and in time are those belonging to some still higher form of life on the physical plane.

Assimilation and Reorganization

—This principle of the assimilation and reorganization of experiences, which is a function of astral life, takes place on a small scale, and has come to be well recognized, in the physical life of man.

An individual who has been applying himself to some task requiring great dexterity or unusual mental ability, and seems to have reached his best performance, often finds that additional practice leads to no greater perfection. When the individual has reached such a stage, for instance, in playing golf, in rendering musical compositions, in literary production, or any other art, those having his training in charge, if wise, advise him to take a vacation from it. It is better for a time that he does not even think about it, but that he should become interested in something entirely different. Then, at the end of his vacation, he is usually amazed to find that he not merely commences to improve where he left off, but that somehow, during the vacation, he has moved forward a marked step, and that he takes up his practice again at a point far in advance of anything he had attained during the previous period.

This well known psychological law, which is applied practically in many fields of endeavor, is based upon the principle that, unhindered for a time by other physical experiences of a like nature, experiences already acquired, under the urge already given them for greater perfection of performance, undergo assimilation and reorganization within the astral form. And as a result of this assimilation and reorganization, abilities of far greater perfection come into existence than any which had ever previously found physical expression. There is a decided gap between what the individual could do when last he tried, and what he now finds he can do. It has not been just a gradual progress, but he has moved forward by a clear-cut step.

Business men are advised by psychologists, and many of them follow this advice, that when they have worked hard to solve some perplexity, or to devise some method of overcoming a difficulty, and have not arrived at anything satisfactory, to put the thing from their mind and take a drive in the country with a friend, go to a baseball game, or otherwise spend the balance of the day in recreation. Business psychologists tell them to let the problem “stew in its own juice” without thinking about it. Then the unconscious mind, or soul, takes the various thoughts about the problem, and such information as it can reach concerning it derived from both the physical and astral planes, and assimilates and reorganizes this knowledge. And when, after the individual has forgotten all about it in some interesting sport, it pops into his mind, it has been worked out in detail, and is ready to be given physical expression.

The finer body of any life-form is composed primarily of psychoplasm, even as its physical body is composed of protoplasm and its secretions. Psychoplasm, in turn, is composed of thought-elements in various proportions. Thought-elements belong to ten different families. Whenever a state of consciousness registers on the soul it adds thought-elements belonging to one or more of these ten families to the soul. These thought-elements which are added by experience tend to build up definite thought-cells, even as assimilated physical food tends to build up the cells of the physical body. These thought-cells and the thought structures they form constitute the astral body, and their organization, embracing all previous states of consciousness, is the soul.

This astral organization is changed not merely by experiences coming from the outer plane, but also by experiences coming from the inner plane. Every objective thought adds its energy to the thought-cells, giving those of similar type more power. And in addition, through the feeling energy accompanying it, the thought cells thus given more energy become more harmonious or more discordant. Also, through the association of this type of thought with thoughts of a different type, it tends to cause the thought-cells thus given energy to have an influence upon other thought-cells.

Not only does later objective thinking about experiences tend to link together in the unconscious mind the thought-cells in which the energy of these experiences have been stored, but the thinking about them below the threshold of objective consciousness also tends to link them together. A strong desire will set in motion trains of unconscious thought which tend to bring together the various factors relating to the desire. Not only are past experiences relating to the desire assimilated, but the soul exercises extra-sensory perception to gain new information and assimilate it. Thus, after a time, the individual is able clearly to grasp a problem, or is aware of just what he should do.

Here we have an instance in which there has been some assimilation and reorganization of thought. But probably there has been no pronounced change in the thought-cell organization; for such a change is soon apparent in the change of fortune and in the change of character. Nor is there probably any pronounced change in the thought-cell organization of the individual who takes a definite step in skill at the end of a vacation. Other than possessing the desired skill, he is much the same as before where his character is concerned.

Something has occurred, however, relative to the ability of his thought-cells to direct the activities of the intelligences occupying the physical cells and physical structures of his body. His thought-cells, impelled by the desire to acquire the given skill, have gone to work to get cooperation from the intelligences occupying the cells of certain muscles and nerves. These were given new orders and brought into such alignment that they would work for the accomplishment of the desired act of skill. It is true that certain thought-cells have been reorganized. But in addition, a myriad of astral intelligences constituting the souls of the physical cells and organs of his body were given instructions and brought into greater obedience, that they might the more effectively assist in the performance of new tasks.

How An Organism Operates

—An organism is not just one intelligence, but in addition to the thought-cells of the dominating soul embraces many minor intelligences which have come under the dominion of the mind, or soul, of the intelligence ruling the organism. And in addition to the various intelligences guiding the physical cells, there are still others of higher complexity within the body of man, such as those which have charge of certain organs.

That organs have an intelligence of their own, and are not merely occupied by the thought-cells of the human soul, is demonstrated by their ability to carry out their function in some degree after being removed from the physical body. The intelligence associated with the organ has learned how to do certain things, and to the extent it is provided with proper conditions—perhaps a nutrient solution—it continues to carry out this work, as explained in lesson No. 95 (Chapter 1, Course 9, *Mental Alchemy*), after the organ is no longer a part of the original physical organism.

To the clairvoyant vision, man is not merely a superintendent directing in person a host of laborers of the intelligence and ability of cell-life. Instead, there are bosses which more or less take instructions from his thought-cells and thought structures and direct the work of certain organs and certain functions. His own thought-cells and thought structures know how each job should be done, and give the orders to the intelligence associated with the physical cell or organ or function. Each of these intelligences which is not an integral part of his soul has its own domain and, if of greater advancement than a single cell, has its own laborers, or cell intelligences, which take instructions from it. In turn, it is given directions by a certain group of thought-cells which are an integral part of the individual's soul.

Life-forms are not simple. Even a molecule of matter is composed of rapidly moving atoms, each with its field of energy; and these atoms in turn embrace moving electrons, each with its energy field. Some of the energy fields tend to hold the electrons from departing, some of the energy fields hold the atoms together by what is called gravitation, and other energy fields keep the atoms themselves from collapsing, and hold each other at a distance.

And even as there are energy fields and still other energy fields embraced within each molecule of matter, so are higher forms of life very complex, not merely in the division of the labor performed, but in the number and variety and types of intelligences, which like the energy fields of the molecule are interdependent in giving the whole its proper integrity.

But whether the intelligence is merely that expressing in a single cell, or even still less as the intelligence of an atom of mineral matter taken into the cell, or still greater as the intelligence governing such an organ as the heart, for instance, these intelligences do not constitute the soul of the organism. They each and all make use of the organism where they temporarily sojourn to express themselves and gain desired experiences. They each and all are performing their own evolution, and except for the time they are associated with the organism, are as independent of it as its soul is independent of them.

It is common, in occult circles, to refer to all the various intelligences within the organism of man, whether thought-cell intelligences, or those intelligences which supervise functions and direct organs and otherwise take charge of affairs, as sub-mundane atoms of life. Sub-mundane means below the earth, and strictly speaking these intelligences, many of them, are as closely associated with physical life as is man, himself. But if we were to use the word subhuman, it would embrace intelligences, such as animals and plants, which are not so closely associated with man. These so-called sub-mundane entities, which also include thought-cells, are the lesser members of an organization over which man is rightfully the ruler.

Few of us ever stop to consider just how interdependent, even in the physical sense, life is upon life. The handling of food within the digestive tract requires bacterial life of certain kinds. The pollination of many flowers, without which no seed is produced, depends upon insects. Earth-worms, passing soil through their digestive tracts, give it a texture and fertility that favors vegetable growth. And in a thousand other ways life-form depends upon life-form.

But when we consider an organism in reference to the intelligent entities it embraces, we find even a far greater interdependence. Such an organism is like some great industrial organization, with departments presided over by foremen, and more or less under the control of the soul which is manifesting through the body. The soul of an organism, whether it be the soul of a plant, an animal, or a man, is an intelligence which by virtue of its past experiences has acquired thought-cell structure ability to attract to itself and direct the efforts of a host of lesser intelligences. These lesser intelligences are of various grades and functions.

Of course, it is not the objective mind which controls and directs these lesser intelligences. What does your objective mind, or mine, know about the proper handling of the digestive ferments, about the proper number of red corpuscles that should be given birth to under certain circumstances, about directing those soldiers of the blood stream, the phagocytes, so as best to protect the body from invading bacterial and protozoan foes? It is the thought-cells of the unconscious mind, or soul, which attend to all these things.

The soul of the organism is the dominant intelligence which has attracted to itself such other intelligences as it has need of. But these other intelligences are merely workmen, they are not the soul. They are paid for their work through the education they get, just as the soul is paid for its endeavors in the wages of expanding character.

When the soul, or intelligence, which has built and lived in an organism no longer can hold that organism together as a living form, the physical form dies and the soul of the organism moves out into the astral world. This astral form is not dependent upon the various intelligences which were embraced within the physical form. I do not wish to say that the astral form and its functions are completely independent of other intelligences than the soul dominating it. But it is no longer dependent upon the various intelligences which were embraced within its physical form.

As the physical form disintegrates not only the cell-life, but the other intelligences associated with man's physical form during physical life, separate from it and travel on their own independent paths of development.

And the soul, or intelligence, which had directed the building of the physical form, and undergone experiences in it, then undergoes a shorter or longer period of life and development in the astral world. At the end of this period of development on the astral, in which still other experiences are added to its thought-cell organization, a process of assimilation and reorganization sets in. This, only on a vastly larger scale, is similar to the assimilation and reorganization of experiences which enable an artist in any line to take a marked step after a vacation, or a business man to solve difficult problems during recreation.

At the end of this assimilation and reorganization process, the soul is not merely ready to build a form on the physical plane just a shade higher than the one built previously. Instead, it has taken a pronounced step forward, and has the ability, when attracted to the physical plane by conditions corresponding in basic vibratory-rates to its new stage of development, of animating and building a form of quite different character and of far greater complexity.

The Evolution of the Soul is Through Long Physical Steps

—Yet if we consider the physical the only place where life-forms can develop and function, we have a sadly limited conception of the universe. The physical is merely the cellar of a vast skyscraper, and the best that can be grown here are mushrooms and similar fungi. The physical is the place where such life-forms as we are most familiar with start their upward development. And, taking the upward trip step at a time, each experience in a physical form meaning that the next form is considerably advanced in complexity, life develops alternately on the physical and in the astral realm.

Yet the highest to which it ever reaches on earth is the puny stature of man, whose intellect and functions are infinitely small in comparison with the intellect and functions of beings still higher in the scale of existence.

But man's form is, nevertheless, the highest that can be developed in this cellar called the physical world. It is only one step, although the last step on the physical plane, in the upward journey.

The ascending soul animates the form of any species but once, and it does not occupy the forms of all species, for it ascends the physical by rather long strides. It does, however, commonly occupy the form of the species man once, although only once. But, because what it has acquired requires properties that cannot be found on the physical plane for complete expression, after once being man, it does not again take any form on the physical plane. Instead, the law of vibratory affinity attracts it to a region of higher velocity, where it can find expression for its rapidly expanding acquired abilities.

Chapter 2

Serial No. 210
Original Copyright 1944
Elbert Benjamine

Copyright
August 2002
Church of Light

Every Life Form
Manifests A Soul

Chapter 2

Every Life-Form Manifests A Soul

To expand man's conception of the universe has been accomplished with the utmost difficulty. It has even been accomplished at great peril to those audacious enough to question the accuracy of prevalent opinion. Galileo, Copernicus, and their followers had a rather rough time of it when they endeavored to induce people to abandon the idea that the earth was flat and the center of the universe.

That the earth is merely a revolving planet moving about the sun attacked man's most cherished asset, his colossal egotism. It is this same colossal egotism which makes it impossible for a certain type of spirit medium to receive messages from just ordinary people who have passed to the next life. The messages, to satisfy the inflated ego, must come from some historically important individual, and with some mediums with delusions of grandeur, the sense of importance requires that the messages must come from no less than Jesus Christ, Himself.

Analytical psychology proves that man will relinquish the requirements of any other urge sooner than the urge of self-esteem. His egotism holds fast to the last. He clings tenaciously to the idea that the earth is the center about which cosmic life revolves, and that the physical plane is the one place where anything of value can be learned or expressed; because this makes him feel of consequence. He lives on the physical plane, and on the earth; therefore, to prevent a collapse of his sense of superiority, he likes to believe that this material planet is the one place of supreme importance in existence.

To tell him that astronomers now recognize a million other universes, that our universe embraces some two billion suns, and that our earth is a second-rate planet revolving about a second-rate sun may dazzle, but makes no deep impress upon him. This is hearsay evidence. What he actually sees and contacts is a portion of the surface of the earth, and these vaster conceptions, while interesting enough in a vague sort of way, have no concrete meaning in his life. He knows, from actual experience, something about a portion of the earth; and anything beyond this seems nebulous and unreal.

The radio, furthermore, illustrates how vibratory levels become real to those who are tuned in on such levels; and carefully conducted experiments in physical research by men of great accomplishment in other lines prove that life, thought and personality exists, not merely upon the low-velocity physical plane, but also upon many vibratory levels of the high-velocity inner planes. Lesson No. 173 in Course 20, *The Next Life*, goes into the details of this, and the balance of Course 20, describes existence on some of these next-life levels. But the ordinary man finds it just as hard to think of any other place than the physical for life to function, as he does to comprehend how really insignificant the planet earth is in the astronomical scheme. His egotism, in spite of the evidence of other realms, insists because he lives here, that the physical plane must be tremendously important.

And so we find an orthodox conception in the Occident, and an orthodox conception in the Orient, both springing into existence from the narrow view of life that earth is the one place of tremendous importance in the general scheme of things. And because of the limited knowledge of Nature at the command of those propounding these conceptions, they are essentially static.

Everything we observe in Nature is in a state of change, even the dissolution of one body being but the prelude to its materials being used in some other body. All is moving forward from the less complex to the more complex. Yet those of the Far East who formulated the doctrine of Nirvana, and those of the Near East who propounded the doctrine of Heaven and Hell, conceived of things as soon reaching a point where they were stationary.

In either version, the earth is the place of tremendous significance. According to the orthodox Occident, one lives on earth according to the demands of convention and the Church and on passing to the next life exists eternally in a harp-playing heaven; or one transgresses the demands of convention and the Church and on passing to the next life blisters in hell, forever and forever.

According to the orthodox Orient, one lives on earth according to the demands of convention and the Church, and again returns to earth to enjoy wealth and position; or one transgresses the demands of convention and the Church, and again returns to earth, this time to undergo suffering. By and by, after enough births in human form, according to this conception, and enough living according to priestly dictates, one is liberated from the wheel of rebirth.

In such narrowed conceptions of existence there is no place where one sins, or where one can perform meritorious deeds, other than the earth. The physical plane is so important—egotism censors any less myopic view—that deeds of kindness or deeds of vileness are limited to it. We need a new Galileo, this time not to show us the true place of the earth in the firmament, but to demonstrate the insignificance of the whole material universe in comparison with the unlimited number of vibratory-levels of the high-velocity realms, on each of which life can function, and on most of which it can function in a manner far superior to that possible in matter, where opportunities are hampered and curtailed by low velocity, which is the chief characteristic of that which is physical.

Such a new Galileo, however, would meet with just as much intolerance, and with just as vigorous efforts at suppression, as did the Galileo who in 1616 was haled before the tribunal of Rome and made to deny that the earth moves, and commanded: “That you should neither teach it to others, defend it, nor say anything concerning it; and that if you should not submit to this order, you should be put in jail.”

Today, even as in that time, there are two powerful groups of people who hold positions of special privilege because they are looked up to as the final authority in their particular domain. Many in both of these groups are willing to resort to almost any unfair practice to prevent people being presented with facts which, by proving those in these groups are in error in the doctrines they teach, would destroy their prestige and, in the long run, tend to deprive them of the financial, social and other special privileges which they enjoy.

One of these groups embraces certain academic individuals who pose before the world as the final and infallible authority on everything scientific. They realize that proof that there is an inner-plane on which personality functions after the dissolution of the material body, or proof that there are inner-plane energies that affect human life and destiny such as those which astrology implies, destroys the materialistic scheme of the universe which they have so painstakingly constructed, and upon which all the doctrines they teach, as well as their own prestige, rest.

The other of these groups embraces certain leaders of the orthodox churches. By them, it has been held to be the exclusive province of church dignitaries to report on that which is not physical. As these dignitaries are ignorant of inner-plane energies which influence human life, they are unwilling to jeopardize their reputation for infallibility by admitting such energies exist as those emanating from the planets. Furthermore, they have taught that life is of a certain kind and amid conditions determined by adherence or non-adherence to the code of their particular church. But extra-sensory perception, while confirming their teaching that conscious life persists after physical death, fails to confirm the conditions of that life as taught for many hundreds of years by such church dignitaries. And the fact that almost anyone who takes the pains can develop enough extra-sensory perception to learn first hand something, at least, of after-death conditions, attacks their Drive for Significance.

These two intolerant groups, whose position of supreme authority either in the field of science or in the field of religion, is attacked by the facts of astrology and the facts of extra-sensory perception, have at the present time succeeded in getting laws passed in some communities not merely prohibiting the practice of astrology but, in spite of our vaunted freedom of speech, prohibiting the teaching of astrology.

Also, they have succeeded in some communities, in spite of our supposed freedom of worship, in getting laws passed prohibiting any demonstration that those who have passed from the physical still persist and can communicate with those yet in the flesh.

Not only do the two mentioned intolerant groups strive cunningly to maintain their prestige, but the desire of others to seem important denied to Mohammedan women the possession of souls. And in the slavery days of the United States it was debated from the pulpit whether or not Negroes had souls. His ego causes man to wish to be unique. Your good churchman, right now, will claim to have a soul, but will deny his horse or his cow has one. He thinks, because he is ignorant of biology, that he is different in kind from the animals about him; when in truth he differs only in degree.

It is true that he possesses a type of intelligence— self-consciousness—not possessed in any measure by other physical creatures. It is true that he is the most highly developed creature occupying material form on the earth. But the soul is not a matter of brain power, for the brain disintegrates at death. The soul is the sum total of intelligence which resides in the finer bodies; that which is known to modern psychology as the unconscious mind.

Lesser Creatures Have Souls

—All life-forms possess an unconscious mind. The unconscious mind, or soul, directs all the activities and life processes not consciously determined by reason. And even where man is concerned, only a minute number of his total activities are determined by reason. Reason, however, does not comprise the soul, character, or unconscious mind. Reason is merely one type of intelligence displayed by the soul when it has reached a stage of development where it is able to build about it, and function through, the form of man. Souls lower in the scale of evolution display less developed forms of intelligence; but intelligence, nevertheless.

And such an intelligence, no matter what the level of its expression, is derived from the experiences of an entity. This entity, whether of the astral plane solely, or occupying and functioning through a physical form, because it expresses intelligence, is a soul. In fact, the sum total of the experiences it has had, which are retained as states of consciousness within its finer forms, not only constitutes the source of whatever intelligence it expresses, but constitutes its soul.

It will be a great shock to the colossal egotism of some to learn that even an amoebae has a soul. If it did not have a soul it could not move over, ingest and assimilate the bacteria which are its prey. I am not suggesting that the soul of an amoebae is as important as the soul of a man. But I am pointing out that biologically, psychologically, and as watched by clairvoyant vision, the difference is that of complexity and degree of development, rather than of kind.

Where intelligence finds expression, there you may find a soul; for intelligence is the manifestation of those states of consciousness which, whether numerous or few, nevertheless, constitute a soul.

The Ego

—Furthermore, once radiated from the Divine Mind, the scintillating sparks of potentiality, numerous as photons of light, which collect experiences and thus develop souls, never come to rest, never are blotted out, never cease their endeavors. Such a potentiality, that ever moves on collecting experiences, we term the ego.

Back of even the lowly soul of a single-celled amoebae is an ego. Back of the soul of every living cell in your body is a spark of Divinity, an ego. And these egos, like your own, are collecting experiences. They are moving forward in their own development paths, as you are moving in yours. They use your body for certain experiences they need, as you use their bodies to help you gain the experiences you need. But except for this temporary association of mutual advantage, you are independent of them and they of you.

I am not trying to convey the idea that souls are the same; for as a matter of fact, two souls not having had just the same experiences, cannot be just alike. Because the states of consciousness which constitute souls have been derived from widely diversified experiences, the souls themselves are widely different. The soul of an amoebae is a very simple one compared to the soul of a man. Yet they possess much in common: They express some degree of intelligence. This intelligence, which even on earth really resides in the astral counterpart, continues to live in the astral form after the dissolution of the physical. And whether on the physical or in the astral, the impulse of the Divine Mind which we call the ego continues to impel the soul to struggle for new experiences and greater perfection.

When man deflates himself enough to recognize that every life-form is an expression of intelligence, and that this intelligence implies a soul, which like his own may ultimately arrive at a state where it is immortal, he will have taken a long step in his mental liberation from conceptions forced upon the race by those completely ignorant of biology. After which, to complete his enfranchisement, he needs to realize, what accumulating evidence proves, that the physical realm is the bottom, and except as a starting point the least important region, of a universe which extends, inner-plane level upon inner-plane level even higher than the gaze of seer has seen.

When he has thus freed himself from traditional authority—a traditional authority which came into existence among those who believed the earth to be flat and the center of the universe, and who knew nothing of the processes of life within the human body, and looked upon other forms of life than man as insensate—let him look about him with the eyes of one interested in other than human creatures.

Problems Common to All Life-Forms

—He will find that their lives differ in degree, but not in kind, from his own. He will find the same variations in prosperity, the same variations in suffering, the same struggles, obstacles, problems, and vicissitudes which cause men's lives to differ one from another, in almost every species of plant and animal with which he becomes familiar.

Every species or individual of life upon the earth has its problems and its difficulties. The problem of securing adequate nourishment, of securing protection from enemies and protection from the inclemencies of the environment, the problem of finding a suitable mate, or suitable conditions for the propagation of the species, the problem of providing for the needs of the offspring, and all the other vital problems are shared alike by man, by beast, by insect, and by plant, and by every one of the multitudinous species of these. The problems which the various forms of life upon the earth must face vary in their details, but in their essentials they are the same for all. Man is not some vastly different creature.

Consider the microscopic diatoms, for instance, which in lesson No. 209, (Chapter 1) I mentioned as the source of the oil deposits in California. They are single-celled vegetables, floating on the water. But the food supply where one of them may live, due to salt water currents and the of a river, may be vastly superior to the food supply where another one floats about. One diatom spends its life surrounded by wealth, and another is so poverty stricken that it dies from mal-nourishment long before the common span of diatomic life has been encompassed.

Chemical elements in the water, and other environmental circumstances, may hasten, may retard, or even prevent, the propagation of its race. One diatom is successful, due to favorable conditions about it, in perpetuating its kind; while another diatom, differently situated, is compelled to be sterile. In its family relations one of these minute vegetables is a marked success and another is a dismal failure; and between these two extremes are other individual diatoms who have various degrees of success and various degrees of failure, where family life is concerned.

Diatoms, like other plants and like animals, may be healthy or may suffer illness. One may be robust and strong, and another sickly and weak. The names for the various types of illness may not number so many as in the human race, but there is similar latitude in the gradation of their complaints.

One diatom, through no effort of his own, lives to a hearty old age. His neighbor diatom, who seems to be quite as moral in his conduct, at least in so far as the present life is concerned, is gulped down by a minute passing crustacean. These diatoms form the basic food supply of the fishes in the sea, tiny fish eating the minute crustaceans which feed upon the diatoms, and larger fish preying upon the tiny ones.

Soon after birth some diatoms meet a tragic end, others live to middle life, and still others are devoured in old age. Yet, as the oil supply suggests, myriads of them here in California met no tragic end; and in the past of Virginia untold other millions died a natural death, as attested by the fact that the city of Richmond is built upon a fossiliferous bed of them which measures some twenty to eighty feet in depth and several miles in length.

Fish also are known to die of starvation. The waters where some abound have an abundant supply of smaller fry upon which they feed. But in other localities such smaller fry become exterminated through the over demand for them, or through many other causes. Some fish spend their lives amid abundance, some alternately are rich and poor, and others eke out a poverty stricken existence for a time and then die of starvation.

Watch the salmon at spawning time, or any other species of fish, and you will soon become convinced that some meet the problem of perpetuating the race successfully and that others do not. Of the hordes of salmon which fight their way upstream toward the gravelly shallows in the high mountains where they lay their eggs, and where the male must fertilize them, only a portion reach their destination. And of these, the eggs of one may be fertilized and nearly all bring forth young, while the eggs of another, except perhaps half a dozen, are devoured by hungry trout before they have opportunity to hatch. Some fish are successful in family life, and others are a failure.

Some fish live in good health and some suffer prolonged illness. Any angler will tell you of catching fish covered with sores, of fish that evidently were unhealthy, of those the prey of parasites. Were these ills the result of moral transgressions?

And the large trout that lives in the deep hole, where the shadow of the over-hanging ledge falls, and year after year has refused to take the angler's fly! Why has he so long outlived his tragic-fated brethren? Fish seem to continue growing as long as they live. But some come to an untimely end as food for the larger fishes, and others reach the frying pan before their prime, due to a vestigial trait of present-day man.

Man's Atavism

—For thousands of years, in order to survive, man strove for skill in fishing and in the chase. In a bygone day he either caught fish and killed game or went without food. And it was thus quite natural that he should develop a delight in the capture of that which kept him alive.

In a day still further gone, migratory birds took circuitous routes south to avoid mountains, and in other parts of their semi-annual journey followed the courses of streams. These ancient mountains have long since been worn to level plains, and these ancient water courses have long since dried up. But, although the need no longer exists, so strong is the force of a habit which has become instinctive, that present-day birds follow, greatly to their detriment, the path from north to south and from south to north that their ancestors did. They continue to dodge mountain ranges and to follow streams that have an existence only in their racial memory.

And the man now, who finds delight in fishing, in hunting, or in killing anything, is just as surely getting his pleasure through the exercises of tastes which no longer necessary, are an inheritance from savage ancestors. To delight in the suffering of any living thing is foreign to the tastes of true civilization. It is an atavistic trait, an instinct which throws back to stark savagery. And he who indulges it, even though his relation to his human associates seems kind and gentle, in this respect is expressing the bestiality of the tiger.

Birds sometimes die of starvation; although when food becomes so scarce that they are greatly weakened, and unable to preserve their usual alertness, they usually fall prey to other creatures before this slower process can bring about their demise. Some birds, due to the locality in which they live, even though they keep alive, must labor early and late for a mere subsistence. Yet in my back yard I keep a bird table, where other birds of the same species feed to repletion without effort, every day. That is, in the material things of life, some birds are poverty stricken and others are prosperous.

Most birds are successful in finding mates, but some fail in this and, perforce, must go through the breeding season without the joys of connubial association.

One year, two pairs of jays nested in my back yard. One pair nested in an arbor vitae and the other pair in a pepper tree. A prowling cat found and devoured all the young from the nest in the arbor vitae, and a few mornings later I found the feathers where this cat, or some other, had also killed one of the parent birds.

The pair which nested in the pepper tree raised three lusty youngsters; and became a great nuisance with their early morning ranting at stray cats, and the bawling out they customarily gave any human whom they spied. They fought other birds from the feeding table, and stuffed their babies with food. And ultimately, as the season advanced, the whole five flew away to some spot less adjacent to suspicious acting humans; much to the relief of the towhees, linnets and mocking birds.

In my wanderings through woods and field I have picked up birds which have died of disease, and in the marshes of Playa del Rey one can any day find sickly shore birds, which droop, and are not permitted to associate with others of their kind.

That some birds meet tragic ends early, and some at an advanced age, and that some do not, needs no illustration. But birds also, as well as many species of mammals, are sometimes subject to the persecution of their kind. I have witnessed, for instance, a willet which had a slight injury to its wing, try to join a flock of its fellows. But because it acted slightly different from them, they set upon it with wing and beak and mauled it almost into insensibility. In fact, among most gregarious birds it fares ill with any individual who departs markedly from the conventional standard of conduct.

The Morals of a Lilac

—One summer I spent my vacation in Lassen Volcanic National Park. During the days I wandered about the volcano, and at night slept on the ground amid the friendly yellow pines. I wanted no tent over me, because I wished to awaken at times and look up at the white stars and feel their nearness to me.

A little creek flowed down from the mountain past the spot where I camped. The underbrush on both sides of this little creek was chiefly a species of ceanothus, commonly called wild lilac. To the north of the creek this ceanothus was healthy and strong, and the little capsules containing the seeds were filled to plumpness. But, except for here and there a shrub which miraculously had escaped, the bushes to the south of the creek had almost completely been defoliated by a black caterpillar. Among acres and acres of it, hardly a dozen shrubs could be seen which had not been devastated. Whether these shrubs whose leaves had all provided forage for hungry caterpillars would die I do not know; but I do know, from investigation, that they were able to produce no seeds that year.

As I walked amid these wand-like branches bare of leaves, I speculated on why these should have been punished, and their brethren to the north of the little creek permitted to flourish. And I thought how like the time of Pharaoh, when he thwarted Moses and was visited by a plague of locusts; only I could not imagine just how the shrubs to the north of the creek had come into God's favor and how those to the south had gained his displeasure. But for that matter, after reading their history I never could perceive either, why God should have been so partial to the bloodthirsty Jews.¹

1 This refers to the fact that the Jewish Religion was born during the Age for Aries.

And I thought also of the dozen righteous bushes, still standing with full foliage of green-varnished leaves, amid the multitude of those in desolation. What had this dozen done, that they, of all the thousands of their fellows to the south of the little creek, should have been saved? I couldn't help thinking of the one-hundred and forty-four thousand who, according to Revelation and certain men of gospel knowledge, are to be saved, while the rest of us must perish. I couldn't see, from my shortsighted station of human life, that they had lived in greater righteousness than their fellows. Perhaps, however, they had lived exemplary lives in a previous incarnation. But whatever the explanation, luck was certainly with them.

Butterflies, reddish above with black markings, and like black velvet beneath, were everywhere. They had fed as caterpillars on the ceanothus leaves; had passed through the chrysalis stage, and now were migrating from the brush patch up the side of the mountain. There were countless thousands of them, and as I watched, a western chipping sparrow dropped from a low branch of a pine, captured one, daintily plucked off its wings and legs, and carried it off, no doubt to feed its young in a nest nearby.

But what sin had this particular butterfly committed, either in this life or in a past one, to merit having its limbs plucked from its body so ruthlessly? Why, of the countless thousands in sight, was it singled out to suffer such a terrible death?

Pondering this, I returned to the healthy shrubs to the north of the little stream, to observe their life more closely. And as I moved among them I found that some grew on loose and fertile ground, in a soil rich and nourishing; while in other spots the ground gave way to rock, and the little shrubs growing here had a terrific struggle against that universal foe of life, poverty.

Next day I climbed the mountain. And as I ascended, the vegetation grew smaller, hugging the ground. Up here, a great part of the year there were icy blasts of a ferocity to tear from its moorings any tree or shrub which dared to rear its head from the mountain slope. And for nine months, or more, a blanket of snow, yards in depth, bore down upon every growing thing. And I wondered why those struggling forms of life must put up with almost unendurable hardships, while members of the same species two thousand feet below live a life of comparative ease and luxury. And I compared them, in the meagerness of their advantages and the bleakness of their surroundings, to some of the fisher folk of New Foundland.

And right at the edge of the timberline I found a hemlock of greater size than his fellows. His trunk, hugging the ground to keep from being swept away, was some eight inches in diameter. At no point was any branch or twig more than three feet from the sloping ground. A rough estimate, judged by counting the rings of a smaller one lower down, where it had been cut by those who built the trail, placed its age at around a hundred years.

Down below, at the mountain's base, I could see its fellow hemlocks standing straight and proud, each protected by the others, and all a thriving prosperous colony, the finest hemlock forest in the United States, according to John Muir. But this fellow was a pioneer. Not only had he taken root higher than any of his compatriots, but he had held on for perhaps a hundred years. He had battled with the poverty of the soil. Valiantly he had resisted terrific winds. The long imprisonment by snow had not broken his spirit.

On almost every mountain high enough, such pioneers will be found. But in addition to these tremendous afflictions, time and again he had been scorched by the blasts of the volcano in eruption. He held fast on a patch of southern slope which in recent years had not been a crater and had not been blanketed with erupted material. Just around the corner to the left, so recently that no trees, but only shrubs have as yet taken root there, the west side of the mountain had been inundated by molten lava. And just around the corner to the right, in 1915, the whole east side of the mountain blew out, and the hot blast devastated a wide area, leaving acres of charred brush and trees along the edge of its complete destruction.

But this pioneer hemlock had persisted through this and other eruptions. Suffering greatly, it had escaped a killing heat. And I wondered why it should have been compelled to pass through travail such as other trees know nothing of.

And around that corner to the right, where hot blasts were followed by the mud formed by powdered rock mixing with almost instantly melting snow, there is a completely devastated area, some miles long and a few hundred yards to a mile in width, in which every living thing perished. Trees three feet in diameter were broken off like matches, or uprooted, and the country scoured as by a mighty sand blast.

When thousands of other trees perished, what karma, or what favoritism of Jehovah, prevented this hemlock, whose tribulations were far in excess of those experienced by Job, from passing to the next life?

Still pondering this, my inspection of the mountain's top completed I descended through the hemlocks to a lower elevation where dwell the lodgepole pines. And I observed that most of these were healthy, but that here and there one had become sickly, through an attack of borers. What sin, in this life or some other, had these borer-infested pines committed to deserve such punishment?

The Ways of Chipmunks

—Back at camp, I sat upon a log eating my evening meal. And at this particular spot, Manzanita Camp, there is an unusual abundance both of the little striped chipmunks and the larger golden-mantled ground squirrels. As many as seven or eight at a time, as a result of a few day's feeding, scampered about, expecting their customary bits of bread. The few days I had been there had permitted me to make good friends of all these little chaps. No longer were they afraid.

There was one golden-mantled ground squirrel, I always recognized him because of his pot-belly, I called my alderman. But he might better have represented a mayor, for he bossed the whole lot. When he wanted a certain bit of bread, no one disputed his right. When he came along, all the others stepped to one side. Plainly, he was the king-pin of the rodent community.

Then there was another of almost equal size, but lacking the pot-belly, who gave obeisance to the alderman, but who chased any of the others away from a coveted bit of food. I called him the lieutenant. Then there were other ground squirrels, sometimes more and sometimes fewer being present, but each well understanding he could boss some and had to be bossed by others.

Any chipmunk had to yield way to any ground squirrel, because the ground squirrels were almost twice as large. But one chipmunk was the major among them. He made the other chipmunks stand to one side, while they in turn drove weaker chipmunks from their path. And finally, there was a little mangy runt of a chipmunk that everyone picked on and browbeat. The only way he could retain a mouthful of food, even when I threw it directly beneath his nose, was to grab and flee for his life; for there was sure to be some larger fellow trying to make him drop it.

If you have ever been in a mining camp, a logging camp, or associated with a construction crew, you will recognize the type. There is always some poor devil, lacking in wit or backbone, who becomes the butt of all jokes, who is picked on by every bully, and who furnishes boisterous amusement for the others. His inferiority gives them, who resent being ordered about by their superiors, a certain feeling of compensation. Their self-esteem is somewhat raised by being able to compare themselves with this poor fellow.

And the big pot-bellied ground squirrel is another type we have with us in human form. Not only did he collect all the food he could eat, but after he was full he would drive the others off, to the extent he could, and gather up more, and hoard it away in a secret retreat. It is not likely that bread, due to its perishable nature when dampened, would keep even if stored in a better place than the hole he dug amid the pine needles. But, irrespective of its value to him, he was bound and determined that as little of it as possible should come into the possession of chipmunks and other ground squirrels.

In 1929 the world entered a period of great economic depression, brought about by humans who had the same conception of life as did this potbellied ground squirrel. Not content to accumulate what they can make use of, such people try their utmost to monopolize as much wealth as possible. They grab it and store it away. Such surplus is of no value to them, but it does deprive the other people of the world of that which is necessary for them to live. And the same spirit of greed which I observed in this big ground squirrel has been the cause of other depressions, and of many other human calamities.

Watching these chipmunks and these ground squirrels, and their attitude toward each other, the stronger always oppressing the weaker, gave me much to think about in reference to humanity.

That I recount, even in brief outline rather than in detail, my observations of Nature during one day, may seem strange to those anxious to gain occult knowledge. But I must impress upon you that no one can get any correct knowledge of occultism in its application to life, who so narrows his mind as to shut out the rest of Nature.

You cannot become a naturalist, which means one who studies Nature, without becoming convinced that man is simply a somewhat more complex expression of the same intelligence to be observed in plants and birds and mammals. To understand occult law, and at the same time to place mankind in some special air-tight compartment, is as impossible as it is to understand the nature of heat without some knowledge of chemistry. The same things, due allowance being made for degree, happen to plants, to animals, and to man. And the same occult laws, due allowance being made for degree, are applicable to plants, to animals, and to man.

Life Differs Only in Degree

—If you continue to believe that God took up a handful of clay and breathed the breath of life into it, and thus man was a special creation, you are wasting your energy in trying to comprehend occultism. But if you perceive that all life has a basic similarity, that it does not remain just as it now is, but is moving forward to greater and greater perfection, you have a sound foundation for spiritual studies.

With such a conception of things you cannot set man off from the rest of Nature. To any naturalist he is just a higher animal. But every type of animal has capacities that other animals do not have. And man possesses self-consciousness as his distinguishing trait.

Yet man is similar to all other physical organisms on earth in that they all have the same fundamental problems to meet: the problem of resisting illness and external foes, the problem of providing protection from the inclemencies of the environment, the problem of making a living, the problem of a successful family life, etc. Why, then, should we presume that man's success or failure to solve any one or all of these problems common to other life-forms on earth, is due to any other causes than those that determine the success or failure of these other kindred creatures to meet the same kind of problems?

The same kind of reasoning that denied the Mohammedan women any place in paradise, which in slavery days denied the Black Man a soul, and which causes men of one nation to consider men of another nation atrocious criminals when they do the things that their own nation sanctions, may draw the conclusion that creatures other than men do not suffer as he does.

No one who has entered into rapport with a robin or a meadowlark singing in the spring can deny that birds, for instance, feel joys and experience raptures keener than those that come to most men. No one who has felt with a mother quail, as she trailed her wing along the ground and feigned to be mortally wounded, while her young sought the cover of some leaf or clump of grass, will claim that the feeling of anxiety is alone the attribute of man. And the dog which starves on his master's grave, as a token of mourning for his loss, is the very exemplification of sorrow.

Birds and beasts, insects and fishes, fight to the death in the attempt to win and hold a mate. Are we to think, because they are not human, that those terrific combats are meaningless to them? Are we to believe that the failure to gain the object loved is less important to them than it is to some man who every two or three years sends a different wife to Reno to make legal their separation?

As for loyalty, either to mate or to young, the examples that can be taken from the lives of creatures other than man are so numerous that whole volumes might be filled with interesting accounts of them. It is the rule, rather than the exception, that the mother shall defend her young against great odds, that the male shall defend the female, and that the members of the gregarious species shall protect the common life and interests. Give a hornet's nest a poke, or try to invade the home of a swarm of bees, and of this you will immediately suffer conviction.

Many male birds bring the female food during the period the eggs are incubating. And many mammals, such as the kit fox of our California deserts, bring food to the mother while the young are helpless and she must nurse them. Such a fox, though gaunt with hunger, will carry the game he has caught, for miles to place it at the foot of the nursing mother.

Certain scorpion mothers, to provide a sure supply of food for the young, permit them to cling to her and suck the juices from her body. The young actually, though slowly, devour her, and in her devotion to their welfare she encourages this cannibalistic practice.

But why go on with other illustrations? To watch the creatures about us is to become convinced, not only that they feel the same basic emotions—anger, fear, joy, hope, and sorrow—that are common to the human race, but that they also live as rigidly close to the code of morals adopted by their race as does man.

The various types of men each have their own code of morals. The morals of a Hottentot, those of a Chinese farmer, those of a Negrito headhunter, those of an Eskimo, those of a native of Bengal, and those of a Caucasian of the Manhattan area of New York, vary as widely as the code of morals do which is observed among animals lower in the scale of life than man.

Those morals, while the priests may have led their followers to believe they were handed down from above, are mostly erected by the needs of a particular people, but given a twist by the most powerful among them, so that these would in some manner receive certain advantages and otherwise be unduly favored. They take their roots in survival needs. How much truth they contain depends upon the enlightenment of the people, and their freedom from powerful individuals who warp that truth to give them a selfish advantage.

And the morals of lesser creatures are likewise based upon survival needs. They may, or may not, be successful in providing for the survival of the race; but they sprang into existence in this attempt. Just so, the morals of certain people, based upon false assumptions, often hinder, rather than aid, survival. But the aim is to benefit the race.

As to suffering, if you will observe the frantic efforts of any creature to live, you cannot doubt that it suffers. I grant that a sensitive nervous system, such as man possesses, may bring to the mind more acute reports of pain than the blunt perceptions of many lower creatures will permit. Yet one who can enter into sympathetic rapport with one of the red-blooded animals, especially a bird or a mammal when it is being killed, or while it is in terror, or is being mistreated, or while it is ill, can have no illusions that man suffers supremely more than they.

And even where plants and more simply organized animals are concerned, the difference in suffering is that of degree and not that of kind. Other creatures suffer physical pain and experience mental anguish. They have joys and sorrows, hopes and fears, successes and failures. Man is like them, except he is at the top of the scale of complexity.

If, therefore, we believe that the sufferings of man are due to punishment by Jehovah for transgressions of moral laws, we must believe also that the sufferings of plants and animals must be due to their transgressions of their moral laws, and the offense they have thus given Jehovah. And if we are to believe the successes and joys of this life which man experiences are due to his conformity in a past life to whatever moral code his tribe holds, we must believe that the plants and animals which have success and joy in this life have lived in conformity to a plant or animal code of some kind in a past life. If we believe the suffering of man in this life is due to sins in a previous life, then we must believe that the suffering of animals and plants in this life is due to their transgressions in a previous life.

One Universal Law For All

—What I insist on as a naturalist, as a seer, and as a student of all things occult, is that man is not set apart from other living things, but that all forms of life come under one uniform and universal law.

Chapter 3

Serial No. 211
Original Copyright 1945
Elbert Benjamine

Copyright
August 2002
Church of Light

The Universal Law of Soul Progression

Chapter 3

The Universal Law of Soul Progression

A handwritten mathematical formula enclosed in a rectangular box. The formula is written in cursive and reads: "General Formula" on the left, followed by a large right-facing curly bracket. Inside the bracket, the terms are: "(Energy X Polarity)" with "(astro-signatures)" written above it; "+ Pain (3 0 2 1 2)"; and "+ Pleasure (2 X 2)". Below the bracket, the result is "= Soul Progression".

It was the limit of his vision, and the misinterpretation of what he did see, that caused man a few short centuries ago to consider each inanimate object to be a unique thing, specially created, and subject to a special law, applicable to it but inapplicable to other things. Newton released the mind of man from this orthodox conception when he demonstrated his law of gravitation, and proved that the same uniform and universal law operates alike upon every physical object in the cosmos. Then came Kepler, with his three laws of motion, and demonstrated how this law of gravitation operates in governing the movements of the planets and other bodies of our solar system.

What now must be done to release the minds of men from similar orthodox notions regarding the soul, is to prove and demonstrate that the intelligences manifesting through living organisms are not unique, not each specially created, and not subject to special laws which are different with different individuals. Instead, every intelligence in the universe, large or small, simple or complex, is subject to the same universal and uniform law, which we term the Law of Soul Progression.

In chemistry, the advance of science has made it certain that substances in their chemical reactions to each other are not governed by special laws applicable to each, but that all chemical action in the universe comes under the same uniform and universal chemical law.

Furthermore, in the realm of force where light, radiant heat and electricity are active, these various energies do not perform differently in different places, but are governed by uniform and universal laws. The application of these laws reveals to us what metals are present, for instance, in the gases about a distant star, how hot the interior of the sun must be, and the almost certain source of the cosmic rays which are now known to beat upon the earth.

Another great stride in freeing the human mind from bondage has been taken by Professor Albert Einstein. His work is not concerned with biology, and does not embrace the laws governing intellect. But observing there are laws governing gravitation, laws governing light, laws governing magnetism, and laws governing electricity, he set about finding the uniform and universal law which governs all these, until now, special performances of energy. And he expresses this single law to which light, gravitation and electricity conform in his Unified Field Theory as a single mathematical equation of eight characters.

Much experimental work has been done to confirm the conception that mass and energy are equivalent, and that what impresses our senses as matter is truly a great concentration of energy into a comparatively small space. Thus those regions in space where the field is extremely strong can be considered as matter, and those regions in space where the field is comparatively weak can be considered merely as field. Mass and energy are closely connected; for mass is energy and energy has mass; and instead of the old laws of the indestructibility of matter and the conservation of energy, only one law is now needed, the conservation law of mass-energy.

As at present mathematically formulated, Einstein's Unified Field Theory has not been entirely satisfactory, due to the Principle of Indeterminacy where the Quantum of Action of particles is involved. The reason of this, no doubt, is that these particles are too close to the border-line where they partake of astral properties. But Einstein's Special Theory of Relativity has now become almost universally accepted by physicists the world over, and has become the foundation of the physics as taught at present in our universities. And while it would seem there are factors yet to be discovered and included in the Unified Field Theory equation, it marks a long stride toward a clearer conception of existence. Experiments conducted relative to it, and relative to the Special Theory of Relativity, have contributed much to the advancement of knowledge; for they have demonstrated there are not fundamentally different kinds of inorganic energy.

Naturalists also have carried out a comprehensive line of research, which they sum up in the theory of organic evolution, showing that organic forms of the present day were developed—as explained in Course 12-1—through uniform and universal laws, from very simple forms of life that existed on the earth some billion years ago.

But orthodoxy, both east and west, is bitterly opposed to the idea that there is any such universal law governing the development of life-forms. The self-importance of the orthodox demands that for themselves there must be a special dispensation. And the power of inflated egos to bias judgment and ignore evidence was well demonstrated in 1925 at the Scopes Trial in Tennessee. There the court decided that it was illegal to teach the doctrine of evolution in public schools.

I trust by now I have made it clear, without going into further detail, that each important step which science has made has been accompanied by the perception that Nature operates uniformly and not according to special dispensations. And I hope quite as clearly to indicate, in this course, that intelligence is no exception to this rule, and that, instead of souls being subject to different dispensations, all the intelligences in the universe, from the amoebae to an archangel, likewise operate in conformity to a single uniform and universal law, known as the Law of Soul Progression.

Einstein has rather successfully, although as yet perhaps not perfectly, brought the various kinds of inorganic energy into a single formula. To do this he has had radically to change the orthodox conception of space. And in this course I hope to bring the intelligences occupying plants, animals, man and angels into a single formula. But to do this successfully I must depart from the orthodox conception of what constitutes an environment suitable to the expression of a living form.

A Unified Conception of Intelligence

—A unified conception of the law of soul progression demands that there should be recognized, as demonstrated by the performance of various types of psychic phenomena, various planes, on any one of which a life-form can function as actually and as vividly as it functions on earth.

It must be taken into consideration, of course, that the properties of these different planes are not the same. The properties of the physical plane, where velocities are low, are widely different than those of the astral plane where velocities are greater than that of light, and these, in turn, are quite at variance with the still more remarkable properties of the spiritual world, where velocities are tremendously higher than those of the astral world.

Within these inner worlds, for instance, there are innumerable levels of existence, on each of which life functions. But in general the properties of all the levels of each plane are similar, even as the properties of various regions in the sea are similar, the properties of various sections of the land surface of the earth are similar, and the properties of the air in various regions above the earth are similar. Not that the same conditions exist in diverse regions of the globe in any one of these three realms, but in general the properties of one of these is similar anywhere on the earth.

The properties of the sea where some animals live, however, and the properties of the land over which other creatures walk or crawl, and the properties of the air, through which other types of life fly, are not the same. In any of these three realms of the physical world a life-form is limited by the properties of its environment. And in a similar manner, creatures in any of the three realms—physical, astral and spiritual—are limited in their expression by the properties of that particular plane. But it is possible for life to live and function on any one of them, and on the various levels of the inner planes, just as it is possible for life to move in the water, over the land, and through the air, in various sections of the globe where the other environmental conditions are quite different.

Conceptions About Morals

—The greatest obstacle to the wide acceptance of a uniform and universal law of soul progression, applicable alike to every intelligence in the universe, is the orthodox tendency to consider any intelligence, outside a very narrow circle of intimates, as being vastly different, not merely in degree, but also in kind.

As society evolved, the family was at one time the social unit. And those within a family group considered themselves vastly different from the people belonging to other families. People outside their family were aliens, to be looked upon with suspicion. It was considered that these other families had different thoughts, were not subject to the same kinds of pleasure and pain, and were not under the protection of the same deities. The member of another family group was considered to be subject to different natural laws, and as different in soul from the members of the one family as nowadays most people conceive the soul of some lower animal to be.

Moral responsibility, consequently, was restricted to the family group. How an individual performed the family religious rituals, observed the family taboos, and treated the other members of the family, constituted his morality. A hen with a family of young has the same type of morality, so far as the treatment of other families are concerned.

Her responsibility is for her own brood, just as at present the responsibility of each government in the world seems to be only for its people. She willingly deprives herself of food for her family, she risks her life in defense of her young, she endures misery while hovering over them in a rain storm to keep them dry and warm. Where her own family is concerned she has a fine standard of morals.

But her conception of morality ends at the margin of her own brood. She is not conscience stricken at depriving other chicks, of a size with her own, of food, even though they die that her own may wax fat. She does not hesitate to peck such a chick from another family on the head when it comes near her, and if it dies she suffers no grief.

Nor in the morals of the early human family group was it a matter of concern to its members that other families perished when they stole their food. Those other people were a different kind of creature, and the family traditions, with religious sanction, taught them that any advantage gained at the expense of such aliens was honorable. It merited praise and a reward to the member who brought it about. For that matter, the diplomacy exercised at international conferences during the last quarter century has been merely an extension of this idea to national proportions.

Later on, for various mutual advantages, certain families amalgamated as tribes. When this amalgamation became completed, the code of morals was broadened to embrace the members of a tribe. But it extended no further than tribal boundaries. What a Blackfoot Indian did to another Blackfoot Indian was a matter of serious moral significance. But what a Blackfoot Indian did to a Crow Indian had no moral significance other than such as derived from the treatment a Blackfoot Indian gave to some wild animal. If, by deceit, by bravery, or by any means he could think of, a Blackfoot Indian could gain an advantage over a Grizzly Bear or over a member of any other Indian tribe, he was considered a hero. Instead of having any compassion at the suffering caused the member of another tribe, he gloried in being able to devise means to make such suffering terrible. The members of other tribes were different from the members of his own tribe, just as the wild animals differed from the members of his tribe. His code of morals was bounded by responsibility to his own tribe.

As society advanced, to gain still other advantages, chiefly the protection from mutual foes, tribes united to become a nation. Such a nation, and the expanding moral conception to embrace its members, is familiar to all through the account the Bible gives us of the ideas and morals of the Twelve Tribes of Israel.

Jehovah, who became the national deity, through Moses and some of the later prophets, laid down a rigorous system of taboos. There should be no eating of pork, there should be no work done on the Sabbath, touching certain things caused defilement for which definite rules of purification were established. The transgression of any of these taboos was a sin, and apt to bring punishment from Jehovah on the individual or the nation.

And, of course, because any person not an Israelite must be a very different kind of being, the people of Israel considered themselves the chosen of God. They had been chosen by Jehovah to rule the world, because they were a superior type of people. The Gentiles, who embraced all the other people in the world, were as different from the Israelites as were the cattle in the field.

Consequently, the code of morals of the Israelites applied to their relation to one another and to their relation with their special deity. The Ten Commandments did not apply to their treatment of people outside their own nation. Not only did they lie, steal, murder, and commit rape upon the women of other nations, but sometimes, as related in I Kings 2:42, their God reprimanded them for not being more severe.

Desiring the land of Canaan, which was already the property of another people, they had no compunction in practicing any conceivable manner of deceit and violence to obtain it and deprive its former inhabitants. No more so than during the year 1931 Japan, desiring Manchuria, had any conscientious scruples about moving in and taking it. Her only worry, like that of the Israelites, was as to her ability to keep the land she thus appropriated. But, of course, even as the Philistines were a different kind of people than the Israelites, and God had no interest in them, so the Japanese regard Manchurians.

Because all the other people in the world were so vastly different from the Israelites, God was always anxious that these other people should be destroyed if it would benefit the Israelites. And He helped the chosen people devise subterfuges, commanded that men and women be slain, ordered that women be violated, and helped in every conceivable crime. Only, because these other people were not Israelites no crime was involved, as what happened to these other people, who were so different, was of no consequence to Jehovah.

And even today I was handed a pamphlet, circulated by an orthodox organization, which pointed out that the various Swami's visiting Los Angeles have different skins and are totally unlike white men. This pamphlet pointed out that the Jews were once God's chosen, but that having disobeyed Him, the Gentiles of the White Race were now ordained to rule the world. It is therefore, according to the whole tenor of this pamphlet, the duty of White Men to keep all Swamis and those teaching other than Christian doctrines, from the shores of America, and to retain the White Man's God-ordained commercial and religious supremacy throughout the world.

In the town where I was reared there were three Christian denominations. And how well I remember, as a boy, hearing the discussions as to who would, and who would not, be saved. It seemed, from the various arguments, that the difference in whether a follower was plunged entirely under the water, or was merely sprinkled, was so vast that it determined whether he would sing hallelujah in heaven or roast in hell. Each of these denominations was positive that it alone was the favored one, and that the members of the other two denominations would have a terrible time of it shortly after death.

And right here I am led to wonder how large a percentage of my readers are willing to concede that a Negro in the Belgian Congo has a right to the same just consideration as does one's next door neighbor. How many of you think that a Chinese Coolie should be kept down, exploited, and given no chance to gain economic independence? Or do you think a Coolie is so different that God can have no such interest in him as He has in you?

Certainly the Pilgrim Fathers, burdened by the strictness and rigor of their piety as they were, felt that their moral responsibility did not extend to the Red Man. However honest they might be among themselves, they felt no twinge of remorse when they cheated an Indian out of pelts or land worth hundreds of dollars by trading him a tawdry string of beads. They were unable to expand their conception of the soul to include the aborigines, just as most men today cannot conceive that plants and animals, although possessing intelligence of a sort, can have souls.

Yet these same Pilgrim Fathers were convinced that both their present prosperity and their condition in the after-life, were determined by a strict adherence to the Word of God.

Whenever a calamity overtook the Jews, those Jews felt sure that it was due, in some manner, to disobeying the moral code set before them by Jehovah. This moral code called for the slaughter of many innocent animals. Bullocks must be slain on special occasions and offered as sacrifices. On other occasions a sheep must be killed. For lesser matters doves would do. But Jehovah demanded that animals be killed. The odor of reeking blood was pleasing to Him, and the aroma of scorching flesh. And it was a matter of morals that such killings be attended to without fail.

The god of the Aztecs, at a period of their history, demanded, instead of bullocks, sheep, asses and doves, human sacrifices. To please the God the victim must be placed upon the stone of sacrifice, and his quivering heart, after a quick incision of the knife, torn from his still living body. If this was not done the god became angry. It was a matter of morals that this rite should be performed.

In another part of the world Moloch must have his human victims; and even now, in spite of British soldiers stationed to prevent it, people in India throw themselves to be crushed beneath the wheels of the Car of Juggernaut. Widows in certain regions of the land feel that unless they burn alive upon their husband's funeral pyre that they have committed an unpardonable sin.

Right In One Locality Is Wrong In Another

—These things are related to show that morals, like everything else, are in a process of development. What is considered moral, whether it be considered child marriage in India or another marriage after divorce by a Protestant in America, is a matter of geography, of customs prescribed by racial needs, and the amount of information possessed regarding other creatures and people. And in most regions, the priests, or other religious teachers, dictate to all others what is, and what is not, moral.

When, then, we consider those doctrines held by the orthodox of the West that man's condition in the after-life is determined by his morality, and those doctrines held by the orthodox of the East that man's condition in this life is determined by his morality in past lives, the first thing we are called upon to do is to consider what is meant by morality. And we find that morality is held by the orthodox to be living in accordance with what one believes to be right. But what the individual believes to be right; among such orthodox people, is determined by what the priest, or other religious teacher, tells him is right.

Thus we might be led to the conclusion that what is right—such as an old man marrying a girl of three or four years of age—in one locality, is not right in another locality. To eat pork may seem moral for a Christian, but immoral for a Mohammedan or a Jew. To collect the heads of a dozen members of neighboring families may seem moral for a head-hunter, but immoral for an Eskimo. In India, to kill a cow which has been crippled, rather than to permit her to linger on for weeks infested by flesh-devouring insect larvae, is one of the greatest sins; but to kill such a cow in America, and thus end its suffering, is a moral act.

Following this doctrine to its logical conclusion, if I kill such a cow, I increase my chances of getting into heaven, or I establish good karma which will reward me in the next life. But if a Hindu kills such a cow he increases his chances of landing in hell, or he makes bad karma, and a fearful penalty awaits him when next he is born in the flesh. Into just such contradictory conceptions we are forced if we accept the orthodox view of things.

These contradictions, however, spring into being as the result of opposite conceptions of what is, and what is not, moral. And these opposite conceptions of what is, and what is not, moral, are derived from imperfect knowledge as to the nature of the soul, the processes of life, and the proper interrelations between entities. They are derived from a conception of things that considers one class or group or nation. It springs from a conception which is so narrow that it cannot perceive that all souls in the universe, including those of plants and animals, are governed by a single great law.

Man, in smaller or larger groups, has formulated standards to govern his relations with other members of his group. These standards constitute the yardstick of his morals. Other smaller or larger groups have each formulated standards to govern their relations; but because they live under different conditions, these yardsticks by which they measure their morals are vastly different.

As soon as a group has formulated certain standards of morals, by which it governs its relations, it immediately convinces itself, through its religious teachers, that God has decreed them. Whatever usages become established, whether torturing heretics, making slaves of other human beings, eating flesh in religious rituals, protecting a king who has oppressed his people, not working on Sunday, not eating certain things, taking a bath at prescribed times, and what not; such soon comes to be taught as divinely decreed institutions.

Furthermore, as soon as some practice comes to be believed to be commanded by divine law, the people believing this inevitably become convinced that the strict observance of the practice leads to reward, either in this life or in a future one, and that not to observe the practice is sure, sooner or later, in some life, to be followed by punishment.

There Is A Universal Moral Code

—Yet just as we have departed from the old orthodox notion that different groups of physical objects each perform according to a special dispensation, so also are we compelled, by an expanding knowledge of life, to depart from the orthodox notion that different groups of men are subject to special dispensations. In any country, and of any persuasion, a man may be given credit for doing what he believes to be right; but because he believes it to be right does not make it so. No more so than because he believes, as some people do, that a horsehair placed in water will in time become a worm, will actually make it so.

There are only two alternatives: Either all those acts, including all the bestial, hideous and cruel acts which are practiced by savage tribes and pagan peoples under the belief that they are being moral, are actually moral merely because those doing these things are convinced they are right; or there must be some universal standard of morality, which is independent of the limited needs and particular religious prejudices of some specific group of people.

Following in the footsteps of science, which has proved there is a single law which governs all falling bodies, whether on earth or in a distant globular starcluster; which has proved that chemical action, under the same conditions, must perform in a uniform manner anywhere in the universe; which shows conclusively that life-forms on earth have developed according to an orderly process; and that light, gravitation and electricity operate under one uniform law; I prefer to believe that in the real sense what is moral in America is moral in China. A principle which is right for one nation is right for all nations. All conditions being the same, an act which is honorable for one man is honorable for another man. In fact, I insist that there must be a code of morals uniformly applicable to every living thing in the universe.

But I admit that few of these living creatures on earth have sufficient information as yet even to approximately grasp this perfect moral code.

No man ignorant of how objects performed under different circumstances could have formulated the law of gravitation. No man without exhaustive experimentation with various chemicals could have formulated any one of the general laws of chemistry. No man who had not an intimate association with mathematics and physics could have given the world Einstein's Unified Field Theory. How then, as morals define the relations which should exist between different life-forms, can some one who knows almost nothing about himself, who has even less knowledge about the real nature of other people, and who is abysmally ignorant of other life-forms than man; how can such a person formulate a satisfactory system of morals?

I am quite willing to grant that those who live according to the laws of God are rewarded, and that those who violate the laws of God are punished. But I am not willing to permit someone who has no knowledge of what God does, even in his own back yard or within his own body, to tell me what God wants me to do. The most ignorant man you meet in the streets is usually most sure he knows just what God wants you to do.

Instead of following after this person's notion, or that person's notion, I think a better plan is to make some study of God's actions. If you wanted to know where a man was going, you might ask the first stranger you met about it. Probably the stranger would know less about it than you did. A better plan would be to follow the man and watch where he went.

Taking a leaf from the note-book of the scientific man, who when he wants to know anything, watches closely and performs experiments, rather than asks some one for an opinion, I think the best way to find out what God wants is to watch His actions. The best way to determine His probable destination is to observe carefully the direction in which He now is moving.

Because the Jews were a vengeful people, they believed Jehovah to be a God of vengeance. Because they came to believe in justice, Jehovah was considered a just God. And Christians, because they believe in mercy, worship a merciful and forgiving God.

What God Wants

—It is hard to conceive of a Supreme Mind Who is different in His motives and actions from what few consider He should be. First, we theorize what God should be like. Of course, He should have all the human virtues and none of the human vices. And He should run the universe as we would run it if we were God. It never seems to enter the ordinary human consciousness that God probably knows more about how to run His affairs than we do. We cannot successfully run our own bodies, but we presume to know how a cosmos should be managed.

A much safer way to proceed is to presume that God knows what He is about, and that, after all, He may have a superior way of handling universal affairs than any we have as yet conceived. Instead of thinking that God wants certain things because we would want them if we were God, let us abandon our colossal egotism, and actually observe what God does. The whole manifested universe is His handiwork, is directed in its activities by Him. Let us, therefore, instead of giving Him the narrow outlook of some human moral code, actually observe what He does, actually try to perceive, in the multitudinous activities of Nature, toward what end the whole is moving; how the various parts coordinate to this purpose, and in what manner the individual can contribute toward the attainment of it.

As comprehensive observations of life should be made as possible. And to the extent possible, life should be observed not merely in its various activities on the low-velocity plane of earth, but on the numerous vibratory levels of the inner planes where the high velocities give different properties to the environment.

Now, if we were creating a cosmos, our human sense of justice would dictate that every individual in it should fare about the same. That some life-forms should suffer less pain injures our yen for impartiality, unless the more injured one deserved punishment by reason of its sins. That some life-forms are given functions to perform that to our narrow minds seem more desirable than the functions of other life-forms does violence to our sense of democracy, unless they are allocated on a basis of what we consider virtue and sin.

Yet, as in some localities on earth we find almost any act affecting others that we might mention considered sinful, and in some other localities the same act considered virtuous, it is just possible that the Divine Mind may have a still different idea of virtue and sin than any of those commonly held by men.

And as to that human virtue which we call justice, is it measured in the Divine Mind by the same standards which are applied by man?

This human idea of justice derives from a state of competitive existence, such as is common to all life on the physical plane. As administered by man it is supposed to prevent the energetic and more highly endowed individuals from depriving the less energetic and less highly endowed of the things all desire. These desirable things while numerous, chiefly come under four categories: The things which pertain to health and length of life, the things which pertain to the family and affections, the things which pertain to wealth, and the things which pertain to honor. Justice, as meted out by man, and as commonly considered by man, is in terms of these things.

Therefore, either in the orthodox belief of the West, or the orthodox belief of the East, because man metes out justice by rewards of wealth, by rewards of things which favor health, by rewards of things which appease the emotions and by rewards of things which feed the self-esteem; and punishment by means of pain, by means of affectional deprivation, by means of loss of wealth and by means of loss of position; it is believed that God, or Karmic Law, provides rewards and punishments in the same terms.

Either in this life or some other life, the rewards of the holy are in terms of length of life or health, in terms of wealth, successful affectional relations, and honor. And the punishment of the wicked, either in this life or in some future life, is in terms of pain, in loss where the affections are concerned, in deprivation of wealth, and in lack of station. The Western belief is that these rewards and punishment are administered in heaven or hell. The Eastern belief is that they are administered under the law of karma, in a future life on earth.

Civilized Punishment

—The orthodox notion of the punishment of crime is that anyone who transgresses the moral laws should be made to suffer. Our penal institutions are based upon this idea, an idea held by the orthodox of both Occident and Orient. When some other individual has done you an injury; justice demands that he should suffer, and it is the duty of society to see to it that he does suffer. It is the application of the doctrine of “an eye for an eye, a tooth for a tooth.”

But there is another view, which in spite of orthodox opposition, is gaining ground. It holds that neither society nor the individual is warranted in demanding vengeance. Society is in error to feel antagonism and hatred of the criminal. An investigation of the lives of criminals shows that, due to a wide variety of circumstances, these individuals did not have a normal emotional development. They have weaknesses or kinks in character. What they need is such reeducation as will permit them to become, and to find high satisfaction in being, normal citizens.

Only a brutal society finds pleasure in the suffering of any individual. Only uncivilized people bring hardships upon others for the sake of getting even.

People are criminal, or do lesser wrongs, through weakness or ignorance, or both. No good end is served by causing them to suffer, unless that suffering conduces to their strength and wisdom. That is, the progressive view toward all criminals and all sinners, is not that they should pay a penalty, but that they should be reeducated. Society gains nothing and brutalizes itself in demanding that those who transgress shall pay a penalty. But it does gain when it is successful in reeducating a criminal to become a useful citizen.

If a criminal is dangerous to society, it may be necessary to restrain him in some institution. But such restraint should be to prevent him from injuring others, and not to cause him suffering for what has happened. To the extent that pain and misery actually assist in reeducating the criminal to become a useful citizen they may be employed. But those who know most about criminals find that brutal treatment causes them to become hard and vindictive. Pleasant rewards, also, to the extent they assist in the reeducation, are useful. But pain and pleasure should not be meted out as a matter of vengeance or favor, but only for the purpose, and to the extent necessary, to assist in establishing a healthy attitude toward others.

In spite of pain and hazard, the criminal is apt to remain a criminal until he perceives how he can be a respectable citizen, and comes to believe that being a respected citizen is a happier way to live than living a life of crime. If he is weak, either in health or character, it is the duty of society to afford him the means of gaining strength, rather than to cause him additional misery because it hates a weakling.

God should at least know as much about how a weak or ignorant person should be treated as the more progressive of our prison wardens. Yet these, along with a small, though growing, section of the public, are convinced that the whole conception of punishment should be replaced by a systematic study of the most effective way to reeducate those who sin against society, to the end, not merely of protecting society, but of permitting these misguided individuals to have happy and successful lives.

In the education of any living thing, pleasure and pain play an important part. As necessary to education they have a useful function. But aside from this educational function, to wish any creature pain indicates a lack of spirituality.

Pleasure is useful, not merely to man, but to all forms of life, as an attractive influence. That is, desire is in the direction of pleasure, and desire determines the line of action.

Pain is useful, not merely to man, but to all forms of life, as a repellent influence. That is, desire is in the direction away from pain, and desire determines the line of action.

Pleasure and pain, not merely to man, but to all forms of life on all planes, are thus the great avenues through which education is acquired. But neither in the Western orthodox conception that the wicked shall simmer in hell in the after-life, nor in the Eastern orthodox notion that the wicked shall suffer in a future incarnation, do I perceive that pain is used for education. Instead, it is used for the purpose of punishment; a use for pain that even man, as he becomes civilized, no longer employs.

According to the general orthodox conception of hell, the individual once there has no chance to get out. He is not being given pain to teach him how to live in a better manner, for he does not get another chance.

And according to the Eastern orthodox conception of karma, the individual who has had a hard lot in one life, and undergoes privation and pain, is not undergoing education; because he has no idea what it is he is being punished for. Thus he is just as apt to do the same thing over and over again, because he is unaware that his suffering arises from specific acts. Karma is just a projection of the orthodox penal system to determine the condition of a future life on earth.

Projections By Man Of How He Would Run A Cosmos

—The orthodox individual of both West and East projects his own idea of justice into his conception of God or of Karmic Law. He never stops to think that God may dispense justice in a more superior way. If this individual were running the cosmos he would see to it that those who lived according to whatever code of morals had been adopted in his particular community were rewarded by wealth, successful family life, health and honor. And he would see to it that those who departed from this arbitrary and conventional code should be punished by being deprived of health, by loss of wealth, by misery in the affectional life, and by disgrace. As he would handle affairs in this manner, he assumes that God is equally intelligent.

Yet as he looks about him, he is forced to admit that in the present life those who transgress the codes society has established often have better health, more wealth, less family trouble and more honor than other individuals who live a life of strict conformity to them. If some misfortune does overtake a wicked person, according to the conventional standards, he is quite willing to believe that God has thus punished him for his wickedness. But the cases of wickedness which seem to go unpunished, and the cases in which the righteous suffer ills, are so common that it is difficult to reconcile them with his preconceived idea about how God should administer justice.

But he is sure God must be intelligent enough to reward the conventionally good and punish the conventionally wicked. So he concludes that the rewards and punishments are largely meted out in a future life, and not in the one in which the virtue or the transgression takes place. In the West, he believes this future life where rewards and punishments are administered embraces heaven and hell. In the East, he believes it to embrace still further lives upon the earth.

And by so considering the matter, he can reconcile his belief that God acts in the same manner he would act if he were God, to the obvious fact that so far as his observations of this life go, God does not live up to his expectations. As he actually knows nothing about heaven or hell, and as he actually knows nothing about any future or past human life on earth, observations of realities do not intrude to upset his good opinion of God's methods.

Civilized Treatment Of Transgressions

—Yet there are men on earth today, in growing number, who have become civilized enough that, no matter what injury a criminal has done to society, no matter how vicious he is, they hope that he may become happy and prosperous. They believe that he is a criminal and vicious only because he is ignorant of the proper method of living to gain happiness. They find it quite laudable for any individual to seek happiness. But the vicious and criminal, because of lack of proper knowledge, think they can gain more joy through the course they follow than through living in a manner more beneficial to others. Therefore, because the malefactor's deeds are inspired by an erroneous conception of how to get happiness, these civilized men entertain no desire to punish him. They wish him every joy and happiness. If they restrain him, it is to protect others from his depredations, and not to cause him misery.

Instead of any desire to punish him, they desire to help him. But to help him they must change his ideas of how to live. Therefore, instead of punishing him, they set about the work of educating him to a point where he no longer will find pleasures in acts against society, but will find pleasure in living a life which, instead, is beneficial to society. For whenever he becomes thoroughly convinced that a constructive life brings more joy than a criminal life, and is sufficiently helped to overcome his weaknesses, he is glad to become a useful citizen.

In the reeducation of a criminal, or in the education of any person, or in the education of a plant, amoebae, bird or mammal, pain plays a part. Pleasure plays a part also. All living things experience both pleasure and pain, as has amply been proved by the scientist in his laboratory. The difference between the pain experienced by a plant and the pain experienced by a man is that of degree only. All other life-forms also have desires which are parallel to man's desires for health, for affectional happiness, for wealth and for honor. The difference is in degree only. Logically, we cannot single man out in relation to his experiences with these things as unique; for after all, their attainment and loss are but types of pleasures and pain.

If the pain which man experiences is in the nature of punishment, as all other life-forms in the universe experience pleasure and pain, the illness, the poverty, the failure in family life, and the unfavorable environmental situation in comparison to other members of the same species, of a plant, for instance, must be due to its sins.

Yet in our search for the Uniform and Universal Principle which constitutes the Law of Soul Progression, we will find that, instead of inflicting pain as a matter of vengeance, Nature uses it as an aid to education. Nature works to bring joy and happiness to all. But such joy and happiness are only possible to those properly educated to appreciate them.

The Four Terms of Our Formula

—And thus we will find, as we proceed, that pleasure, pain, energy and polarity are the four terms of the formula—applicable alike to any intelligence in the universe—which expresses the Law of Soul Progression.

Chapter 4

Serial No. 212
Original Copyright 1945
Elbert Benjamine

Copyright
August 2002
Church of Light

The Uses of Pleasure and Pain

Chapter 4

The Uses Of Pleasure And Pain

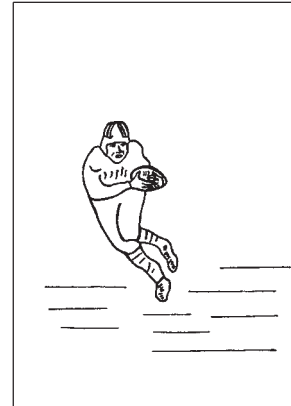

Of all the motives, those arising from the power urges are the most persistent and the most insistent, as lesson No. 159 (Course 14, *Occultism Applied*) explains in detail. These are the urges which ever impel intelligences to desire to be important, to be unique, to express individuality, and in man to gain and retain self-esteem. The power urges are at the base of all those human actions which have for object the attainment of honor. Honor heightens the self-esteem, because the individual feels important in having the admiration of others.

Within the present economic system the commonest rewards offered for excellence of service are money and honor. People exert themselves to the limit of their powers in the hope of increasing their earnings. But it is found that other people will exert themselves even more strenuously to obtain a position of honor than they will for the rewards of wealth. A public office, a name lettered on a company door followed by the word, President, is even more attractive than an increase in salary to many men. People like to feel important.

Self-esteem, however, may be heightened and maintained through other methods than gaining the approval of one's fellow man. Some men are far more interested in attaining self-approval than in gaining the approval of the multitude. They find satisfactory nourishment for their desire for importance through doing important things. Instead of being dependent upon what others think to gain satisfactory self-esteem, they depend upon what they do, regardless of the approval or disapproval of others. Many a man in public life does the thing which he knows will win the disapproval of the multitude in the assurance that what he does is really the right thing to do. He feels better doing the thing which wins his own self approval, than in doing the thing which loses his own self-approval even though it wins the acclaim of the crowd.

Recognizing the strength of the motive of self-approval, as well as that of the approval of others, certain economists have proposed a system of government in which people do not make greater effort for any material thing, but in which each individual contributes all he can to the common welfare for the same pay or physical reward. The theory is that people should work as hard for the good of others as they do for increased pay. These economists hold that the satisfaction men get from being important should weigh heavier than a fuller pay envelope.

Disregarding any discussion of whether mankind has evolved far enough to dispense with greater physical rewards for greater services rendered, it is undoubtedly true that the most important work in the world is accomplished by those who do it for the sake of self-satisfaction and not for the sake of wealth, domestic success, health, or the honors bestowed by others. The great discoveries, the great inventions, the great works of art, the great literary productions, the great examples of statesmanship, are not activated by the desire for any material gain, but by the joy the individual finds in his work and the satisfaction he feels in its superior performance.

The Most Satisfying Reward

—I am convinced that those who thus work for the joy of accomplishment and the self-importance derived from superior accomplishment find the satisfaction they thus experience as a result of such superior performance is a higher type of reward than any material thing could be. If, therefore, we were to judge even by human standards how God should reward those who live according to His Plan, and if we were to use the higher human standard, instead of the lower human standard, we would conceive such rewards to be in the nature of the joys of accomplishment and the subsequent self-satisfaction, rather than rewards in terms of health, money, position and domestic felicity.

I am sure that Michelangelo, who lay on his back through long day after long day painting the ceiling of St. Peter's, must have suffered terribly. Exacting work performed from such a position, almost incessant toil, being deprived in the meantime of the pleasures common to other men, must have induced many an ache and pain. Yet I am sure that Michelangelo, when his work was finished, counted all the unnumbered annoyances which hindered his work, and all the pain connected with its accomplishment, as naught in comparison with the satisfaction he experienced at the excellence of its completion.

Any accomplishment worth while, whether playing a piano, painting a picture, writing a book, or directing the policies of a nation, requires years of painful preparatory labor and training. It is common experience that to learn to do anything well enough to warrant a glow of self-satisfaction one must deprive oneself of the things one might enjoy during the time spent in training and go through an arduous education in which painful experiences are abundant. For, after all, grueling toil, forced application, and the emotional reaction to mistakes are painful.

Nature's Educator

—This brings us to a point where, instead of theorizing, we should observe life as it exists in its numerous forms on earth. For any place we observe any form of life we find it undergoing education at the hands of pleasure and pain. Pleasure and pain, in some degree, are common to all forms of life on all planes. And everywhere we observe their effect we find that they conduce to education.

Even to the child who is compelled by his parents to stay indoors and arduously practice some musical instrument while his playmates, free from such painful experiences, shout and frolic on a vacant lot close by, the pain he undergoes is not a punishment. It is a means to his education. And because his education, for his own ultimate satisfaction, requires more pain of this kind than his playmates get, does not signify that his parents are unjust, or that the society under which he lives is unjust. It simply signifies that the position he is ultimately to occupy requires in his education for it that he undergo this particular kind and quantity of pain.

Furthermore, if we observe the lives of plants and animals closely, we will observe that the pain they undergo, as well as the pleasure, is a necessary part of their education. A tree, for instance, if it is to withstand a gale when mature, finds it advantageous to be beset by winds while it is growing. Through these painful experiences early in life, which nearly uproot it, it learns how to build a root system that will anchor it securely and permit it to perform the functions of an adult tree without being torn from its moorings.

If you will trace any pleasurable or painful experience undergone by any life-form, you will find that it contributes to the education of the intelligence occupying that form. Such a life-form might complain it was unjustly treated because it had more pain than a neighbor, in the same way that a child who must practice on some instrument while his fellows romp and play might complain of the injustice of his parents. Such a life-form might conceive that this pain came to it in the manner of punishment, and the child might consider that his music lesson was due to the parents, desire to get even with him for something. But unless we can trace the pain to its ultimate effect, and discern how it adds to, or detracts from, the ability of the individual ultimately to do something that gives self-satisfaction, any such conclusion is unwarranted.

On the contrary, any worth while accomplishment, whether of man, of animal, or of plant, is the result of overcoming great obstacles. If there were no difficulties to be surmounted it would be an easy thing to do, and not a worth while accomplishment. If you will notice the lives of men, you will find that only those who have had much practice in overcoming difficulties, thus getting a thorough training, ever rise to a point of superior accomplishment. Superior accomplishment means overcoming obstacles; and man and other forms of life only learn to surmount difficulties through encounters with them.

Disregarding, for the moment, the question of justice and injustice, anyone can learn from observation that education is only acquired through pleasurable and painful experiences, and that every painful experience and every pleasurable experience contributes to the education of the intelligence experiencing them. That is, by observing living things you can prove for yourself that they are being educated by success and failure, by gain and loss, by wealth and poverty, and by the various other forms of pleasure and pain.

Whether or not pleasure and pain are dispensed by God as favors and punishment to those who conform to or depart from some conventional standard of morals, anyone through observation can at least be sure that pleasure and pain, in their various forms, such as those mentioned, are used to educate souls, and are the only means by which any soul can be educated to accomplish anything.

Evidence of the response to pain by both plants and animals is given in lesson No. 95 (Course 9, *Mental Alchemy*). Here, I shall not again present this evidence, but shall instead endeavor to indicate that wherever life exists pleasure and pain are responsible for the education which enables it to gain its objective.

Already, in lesson No. 155 (Course 14, *Occultism Applied*), I have gone into the details of the development of the human personality under the influence of agreeable and disagreeable stimuli as demonstrated by the experimental work of Mandel Sherman and Irene Case Sherman. This work indicates that the human infant is born with a few reflex activities: ability to swallow, closing the eyes when the cornea is irritated; sneezing and response to deep pressure. These reflexes are inherited, which means that they are abilities already learned by the soul, either through experiences before birth as a child, or through other experiences handed on to it by the heredity genes which transmit racial characteristics.

A new born infant is capable of random movements. When a disagreeable stimulus is applied, such as pricking it with a pin, it tenses and threshes about. When stroked or fed it relaxes. A plant or an amoebae performs similarly under the same conditions, except that a delicate instrument must be used to detect the magnetic shudder which the plant experiences when in pain, as it is incapable of violent physical movement. Any amoebae, or other animal, however, which possesses the power of movement, shrinks away from the painful object. But in the presence of pleasurable stimuli, both plants and animals relax.

As the child grows older, and has more experiences with painful stimuli, its activities grow more coordinated, and it gains in ability to move away from the painful thing. This withdrawing from a painful stimulus is accompanied by an emotion. And it soon learns to distinguish the thing which causes it pain and upon seeing it, or apprehending its presence through any of the other senses, to experience a disagreeable emotion. Such is the inception of the emotions which when further differentiated express as remorse, worry, sorrow, disappointment, fright, timidity and self-consciousness.

All other forms of life also learn to recognize painful conditions and respond to them by disagreeable emotions. Such disagreeable emotions vary in their complexity as the scale of life ascends. We can hardly say that a tree worries or expresses self-consciousness, but we can say that a tree feels an unpleasant emotion, for such responses have been mechanically recorded. Yet we need not hesitate to say that a hen which has hatched ducklings and these take to the nearest pond, experiences worry. And we need not hesitate to say that certain dogs experience embarrassment.

According to the experiments cited, when an infant is restrained so it cannot move away from the disagreeable condition, it ceases to try to do so, and instead tries to push the disagreeable thing away. If the restraint is continued it stiffens the whole body, slashes about freely with hands, legs and arms, and then the breath is held until the face turns blue. The fear reaction has vanished, and there has developed in its place an aggressive response which is accompanied by an emotion that is the commencement of anger. From this anger response later develops the emotions of courage, initiativeness, combativeness, and destructiveness.

And we find the same kind of response developing, only in different degrees of complexity, in all forms of life. An oak tree unable to run away from the insects which deposit eggs in its twigs or leaves, secretes substances, in the endeavor to resist invasion, which grow into oak galls. Roses bear thorns, nettles have bristles, cacti grow spines, and the amanita mushroom secretes poison, because they cannot run away, and do not supinely submit to being destroyed. Almost any animal, when cornered, will fight, because it cannot get away.

The Function of Change

—The great fight, however, of all life is against changing conditions. When the ponds dried up, certain algae, which had hitherto lived only in the water, not being able to run away from this disagreeable condition, struggled aggressively to prevent being destroyed. And this courageous struggle resulted in the first little roots in the world being formed. These followed the water down into the drying mud, and gave rise to something similar to present-day liverworts. Thus the first land plants developed in the world.

Environment is ceaselessly changing. The forward pulse of cosmic cycles brings ever new conditions. Because they are not adapted to these new conditions, forms of life already developed have a difficult time of it. Regions that were once arid become flooded with water. Regions that once were well watered become burning deserts. Where plains have been, mountain chains arise. Glacier sheets move down from the north. Cold regions, by reason of shifting ocean currents, become warm. Winds develop where before was comparative calm. Food supplies are diminished by a too rapidly developing population. New enemies appear. Throughout the existence of the earth, as recorded in the rocks, such changes have been taking place and forms of life have had to meet the changing conditions or perish.

How the chief forms of life on earth have met these disagreeable stimuli, and have conquered them, although other forms have suffered defeat, is set forth in ample detail in Course 12-1. The point I here wish to bring out is that, in order to survive, either individually or as a race, when conditions arise that would destroy it, a life-form must learn how to avoid or overcome the condition. It must run away or defeat the environmental menace, whatever it may be, or perish. Pain is the prod by which Nature compels life-forms to learn to accomplish tasks of greater and greater difficulty.

But we must not overlook pleasure. Instead of demanding the fight or flight reaction that is aroused by pain, the life-form learns to seek those things which are pleasurable and to relax in their companionship. At first the infant merely relaxes when petted or fed. Later this relaxation becomes a smile. And it soon learns to reach for those things which it has found give pleasure.

All the emotional reactions of an infant are conditioned by the pain or pleasure it experiences in association with various circumstances. What it likes and what it dislikes depends entirely upon its experiences with these things. Thus one person comes to like something that another person just as strongly dislikes. Because behavior is based upon such likes and dislikes, upon such emotional responses, the actions of people, as well as the actions of all other life-forms, depend upon their experiences with pleasure and pain as associated with definite things or situations.

In view of these considerations, instead of adopting the orthodox notion that pain has its origin in the desire of some deity or some law to punish the individual, let us ask the biologist what pain is and how it came to develop:

The Function of Pain

—He reveals to us that the normal function of pain is to inform an organism that it is failing in some measure fully to adapt itself to environment. If a life-form had no perception that it was being destroyed, it would take no measure to prevent destruction. If it had no feeling akin to hunger, for instance, it would not eat, and would consequently die. If it had no sensation to inform it that heat was burning its tissues, that enemies were eating into its vitals, that it needed moisture, that it was being destroyed in any manner, its life would probably be short. Unless some method were present by which it could become aware of the destructive forces that were depriving it of life, it would have neither the fight nor the flight reaction; it would neither combat its enemies nor run away.

Women who worked in watch factories during World War I, and since, where the dials were painted with radioactive paint, felt no pain. They had no knowledge that the radioactive substances they used were slowly burning up the tissues in vital parts of their bodies. Not until years afterward were they aware of this, when the destruction then contacted caused the death of some, and made invalids of others. Had their nervous systems been sensitive enough to have registered pain when their internal tissues were attacked by the invisible rays, they could have reacted to this menace either by flight or fight. That is, they either could have secured other jobs, or could have continued the work unharmed by using proper insulation.

Biologists tell us that pain is not due to punishment, but was developed, little by little, as organisms became more complex, for the sole purpose of informing them that they were being destroyed. As an organism advances, its sensitivity to pain increases; and this increased sensitivity to pain is one of the most valuable acquisitions, because it keeps the life-form well posted as to its success or failure to meet the requirements of life. And, because hesitancy, or great delay, in fighting or running away from a destructive condition, is apt to result in death, it was most valuable to a life-form that the consciousness of the presence of something destructive should be so energetic and insistent that it would compel the necessary action to preserve the life.

Had the algae, which, I mentioned, not had some kind of consciousness that it was being destroyed by being deprived of moisture, a consciousness of discord such as in higher life-forms we call pain, it would not have struggled to overcome this menace, and there would have been no land plants on earth. A still more definite type of pain informed the dinosaurs that they were being frozen, when the climate where they resided changed from warm to cold. Of course, they did not analyze the cause of their discomfort; but they felt it. And some of the little ones, more aggressive than the rest, not being able to run away, in the course of some generations converted their scales into fur, and others converted their scales into feathers. And thus it came about, because of pain, that creatures with fur and creatures with feathers now inhabit the earth.

The Function of Pleasure

—As to pleasure, the biologist tells us that it likewise was developed, little by little, as life-forms became more complex, from the consciousness that the life-form was being successful.

The babies, in the experiments of the Shermans, when they were fed, when they were petted, and when they were given harmless objects that they reached for, relaxed, and later on, learned to smile. It is valuable for a tree or bush, for a fish or mammal, to know when it is being successful. While it is prospering in all ways if it were not conscious of this condition it probably would attempt the equivalent of the fight or flight reaction, and thus deprive itself of the very things which otherwise would bring it health, wealth (in terms of food supply), family success, and honor (in terms of prominence among its fellows).

The lack of this consciousness of when they were well off, in 1929, caused some twenty million people in the United States to become investors, many of them bold speculators. This lack of a proper consciousness of well-being caused them to take actions that brought them financial loss, with its mental agony, and in millions of cases actual physical deprivation.

If a creature does not feel pleasant when it has been properly fed, it may continue to eat until it feels pain. Furthermore, just as the child learned to reach for its bottle, because of the pleasure it had on previous occasions derived from it, life-forms move toward, or at least are attracted to, the things which give them pleasure. Thus pleasure is a sensation which has developed, little by little, to inform the organism what things it should seek, and what things it should tolerate. And as the sensation of pain, in order to be effective in causing actions that would preserve the organism from destruction, became intense, so, in order to cause beneficial actions without too great delay, the sensation of pleasure also developed to a high degree of intensity.

One can take any living organism and show that the sensation of pain normally operates to inform it of those things which are discordant to it, of those things which are inimical to its welfare. Because the reaction of the organism either in terms of fight or flight was developed along with the sensation which informed it of the inimical condition, pain commonly results in such attempted activity. Also one can take any living organism and show that normally the sensation of pleasure operates to inform it of the things which are beneficial to it; and commonly pleasure is accompanied with an attempt to gain or retain this beneficial thing.

Conditioning Processes

—I say that pain normally discloses to the life-form the presence of discord, and that pleasure normally discloses the presence of harmony. Yet through the association of a beneficial thing with a painful experience, the organism may react to the beneficial thing as if it were a discord. And through the association of an inimical thing with a pleasant experience, the organism may react to the inimical thing as if it were beneficial.

This process, which is called conditioning a response, can be used to call out any type of emotion and action from a given condition. The method, and its use to enable the individual to learn to like something that he previously disliked, is explained in detail in lesson No. 155 (Course 14, *Occultism Applied*). It is merely the application of pleasure along with an experience that otherwise would be painful. And if this is repeated often enough, the mind associates the pleasure, which may not have been derived from the experience but from some association with it, with the experience. Thus the experience, itself, comes to be considered pleasant.

Then again, a lesser pain may be associated with a greater pleasure, and thus the whole experience seem pleasurable. The prize fighter, for instance, may suffer physical pain, but the pleasure he takes in trying to vanquish an opponent, or in the money he is to receive, may be so much greater than the physical pain, that he likes fighting. Or, to make a still more general application of this principle, work is painful. Yet, because of the things which become associated with work, such as honor, money and the satisfaction of accomplishment, people learn to love their work. So much so that it is the common thing for business men to work as strenuously at making money after all need of the money has ceased as they did in their younger days when money or the lack of it meant having or doing without both necessities and luxuries.

But these various results of associating painful and pleasurable experiences to build up a desired emotional response, and the occasional similar associations that take place in Nature, do not vitiate the general rule that pain warns of destruction and pleasure informs of well-being. On the contrary, all these conditioned responses depend upon this normal function of pleasure and pain.

According to biology, therefore, pain has just one function, and that is not punishment, but to inform the organism that something is present which is inimical to it. And according to biology, pleasure has just one function, and that is not to reward, but to inform the organism that something beneficial to it is present.

Furthermore, all sensations, in lesser or greater degree, are pleasurable or painful. That is, the organism has developed various sensations which inform it in different ways that things are harmful or beneficial. Some of these sensations are not very pronounced in yielding pleasure or pain, but every sensation is fundamentally a measure of harmony or discord in reference to the organism. Thus it will be seen that the soul is dependent for all its experiences upon the various gradations of pleasure and pain; all its knowledge is derived from contrasting and comparing different kinds of pleasure and pain which it has experienced.

The Ego

—Observation of living things will soon convince you that back of every organism is an energy which causes it to struggle for self-preservation. This energy, an emanation of the Divine Mind, it is customary to call the ego. Associated with every life-form is an intelligence, or soul, which is capable of recording pleasure and pain in certain gradations as experience. Yet back of the soul is the ego, which is a potentiality, or energy, that constantly drives the soul forward to gain and record experiences. Due to the energy imparted to it by the ego, the soul attracts about itself a form, molds this form as an expression of its present abilities, registers various gradations of pleasure and pain while associated with this form, and then repels the form; later to be attracted to and mold a more complex one.

Under those conditions which favor the life of the form it occupies, the reports received by the soul are those sensations and emotions which we call pleasure. The function of pleasure is to inform the soul that things are going well with the form it occupies. Health, wealth, domestic felicity and honor all favor the life-form, and normally register as pleasure.

When, however, as commonly happens, the environment changes in a manner which tends to destroy, or hamper the activities of, an organism, this condition is reported to the soul normally in terms of pain. Yet because the ego has given it the unquenchable impulse to live and press forward, the organism experiencing pain does not placidly permit the new condition to destroy it. Instead, the perception that discord is present is a signal for the life-form to run away from the destroying condition. But if it cannot run away, as illustrated by the baby experiments, and by the common observation that almost anything will fight when cornered, it does it utmost to overcome the destroying condition.

Pain has only one purpose; to inform the soul that a destructive condition is present. But the soul, thus informed, sets about, to the best of its ability, to avoid, destroy, or otherwise overcome, the menace to its organism.

Pleasure, likewise, has but one purpose; to inform the soul that a favorable condition is present. When, therefore, the soul has triumphed over the condition which threatened the life of its organism, it experiences pleasure.

How Ability Develops

—Now bear in mind that ability consists in the power to overcome difficulties. The man who performs some work that another person cannot is able to overcome the difficulties which the work presents, difficulties that block the other person's efforts. A man can reason, because he can exercise his mind in a particular way; but the difficulties of using the mind in this manner are too great to be overcome by a tree or a butterfly. A statesman is so considered because he can overcome difficulties that a savage cannot. Any accomplishment is merely the overcoming of certain difficulties; and the greater the difficulties overcome the greater the ability necessary.

Difficulties, however, are such conditions as normally occasion pain. When the water holes dried up, the fish that were in these water holes experienced pain. The difficulty that confronted them was to obtain an oxygen supply adequate to support life. The pain experienced informed the soul that a destructive condition was present; and as the organism could not run away, it struggled to overcome the destructive condition. And this struggle, upon the part of generations of fishes, in time bred creatures which could obtain oxygen from the air. The gills of a fish require water flowing over them to supply oxygen; but the fight to get oxygen when water was no longer present converted the swimming bladder into lungs, and resulted in amphibians, such as the frog, which can live out of water.

Trees the world over are beset by insects and endangered by fire. Insects boring into a tree constitute a destructive condition, and the consciousness of this discord by the intelligence of the tree registers as pain. Fires that periodically sweep through forests also cause trees to register pain. As trees cannot run away from insects and forest fires, they must often suffer destruction from such forces, or through their struggle against such destructive agents learn how to overcome them. Very few trees have learned how successfully to combat these two conditions. But our California redwood trees have. They have developed a sap which is inimical to insect life, and thus they are almost entirely free from insect pests. And they have developed a very thick, felt-like bark, which does not catch fire. It is only under exceptional conditions that a redwood tree is seriously injured by fire.

Now in obedience to cyclic law, the environment occupied by a life-form is subject, from time to time, to considerable change. The life-form has, perhaps, met the difficulties presented by the old condition in a successful manner. Within the old environment it has lived mostly in comfort and pleasure. But the change that now takes place threatens to destroy it. This destructive influence registers as pain. Aware, because of pain, that a destructive condition is present, it struggles to overcome the difficulties presented. If it succeeds in triumphing over them, the sense of well being following the triumph is recorded as pleasure. And the pleasure thus becomes associated with the process of overcoming the difficulty.

The experimental psychologist would say that it has become so conditioned to the difficulty that it experiences joy in meeting it and triumphing over it. The pleasure experienced in the triumph is greater than the pain experienced during the overcoming process, and therefore, it finds enjoyment in the exercise of this ability.

A few years ago the Tenth Olympiad was held in Los Angeles. Athletes from all over the world gathered here to compete in a wide variety of contests. They did not compete for money; because only amateurs were eligible. Yet these competitions called for tremendous endurance, effort, stress and activity. Some contestants fell unconscious at the finish, some were injured, and all made terrific calls upon vital reserves. Such exertion of itself is decidedly painful. Yet these athletes felt joy in entering the competitions, because the pleasure they experienced in the effort to triumph over the difficulties offered by opponents was greater than the pain of physical exertion.

Ability is Developed Only Through Effort to Overcome Difficulties

—Furthermore, each of the hundreds of athletes who entered the competitions had back of him long periods of grueling and painful training. Day after day he had been called upon to perfect his technique and to exert himself to the utmost. Terrific work and strain, which in itself was painful, but which, because associated in his mind with the hope of excelling, the hope of overcoming difficulties, registered chiefly in his consciousness as pleasure. The experimental psychologist would say that he had become conditioned to find joy in competition.

And whether in man or bird or plant, whenever there is ability to accomplish something you may be sure that ability has been developed through effort directed at overcoming difficulties. That is what ability consists of, the power to overcome difficulties. And only through experience in overcoming difficulties does ability develop.

A difficulty, however, is a painful condition. Even such a difficulty as successfully conducting an international conference is a painful condition; although the pain is mental rather than physical. When, however, a painful condition is overcome, either by destroying it or by running away from it, pleasure results. And through the association of the resulting pleasure with the process by which it was obtained it comes about that the activities which go into overcoming a difficulty in time themselves produce pleasure. Even though these activities at first are decidedly painful, because of the pleasure resulting from the triumph, or from the effort to triumph over them, they become pleasant.

Through this conditioning process people who engage in sports learn to enjoy them even when they are losers. Not merely conquering, but even the effort to beat an opponent, thus comes to afford greater pleasure than the pain occasioned. Although severely wounded in a fight, a dog usually shows in an unmistakable manner that he took pleasure in the fight. He feels pleased with himself that he had the courage to do battle. He feels exhilarated by the excitement of the struggle.

Due to the inevitability of changes in the environment, all life-forms at times are confronted by difficulties. These difficulties may threaten to destroy the life-form, or they may merely block the path to the realization of some desire. But in either case they are discords in the life of the organism; for the thwarting of a desire, as well as the destruction of the body, registers as pain.

Desire normally is in the direction of pleasure and away from pain. But due to the conditioning process, by which a thing painful of itself, through association with a thing which produces pleasure in time also produces pleasure, desire may be cultivated in any direction. But whatever desire is attracted to, that thing at the time registers as pleasure, and any blocking of its attainment registers as pain.

The blocking of desires gives rise to the emotions of anger, fear, worry, sadness, sorrow, grief and all other discordant emotions. And the attainment of desires or the hope of their attainment gives rise to the various harmonious emotions.

Difficulties, thus as threatening destruction, or as blocking the realization of desires, cause the soul to register pain; but when triumphed over and the threatened disaster averted, or the desire realized, they cause the soul to register pleasure. Or if the soul, through repeatedly overcoming difficulties has become conditioned to finding joy merely in the effort to triumph, as in the case of the sportsman who gets pleasure in competitions even when he loses, the mere attempt to overcome a difficulty causes the soul to register pleasure.

The only method by which any life-form learns to overcome difficulties is by encountering them and trying to triumph over them. That it frequently fails to overcome the obstacles in its path is to be expected. The athlete who finally makes a world record, in his early training fails, time after time, to give a remarkable performance. The child who becomes a good speller, at start makes many mistakes. Even the most successful business men very frequently have had drastic failures early in their lives. People or lesser life-forms only learn through effort.

Even though the physical form occupied by the soul perishes in the effort to overcome some difficulty, the educational value of the experience is not lost; for it is retained in the finer form. Difficulties lead to the effort to overcome them, prompted either by pain or pleasure. Pain, which is the consciousness of discord, drives the soul to effort; and pleasure, which is the consciousness of harmony, attracts the soul to effort.

The various efforts which a life-form makes to overcome difficulties may mostly arise from the consciousness of discord. It may thus be driven by pain. Or, if it has been so conditioned, its efforts to overcome difficulties may mostly arise from the consciousness of harmony. It may mostly be led by pleasure. And as explained in Course 9 (*Mental Alchemy*), and in Course 14 (*Occultism Applied*), this pleasure technique can be employed by man greatly to his advantage.

The Most Important Obstacle to Be Surmounted

—The most important difficulty every individual is called upon to overcome is that of getting his thought-cells to work for the things he desires rather than for the things they desire as shown by the birth-chart and progressed aspects of the planets mapping these thought-cells. Within the finer form of every individual are thought-cells which have been conditioned by the experiences which built them to feel disagreeable and thus to work from the inner plane to bring unfortunate events into the life. And when discordant progressed aspects form to the planets mapping these discordant thought-cells, and they thus gain the energy to do so, and the increased desire, these thought-cells will bring unfortunate events into the life unless they have been reconditioned to find pleasure in working to bring into the life events of their particular planetary type which are beneficial to the individual.

The thought-cells mapped by each planet have types of desires, and express in activities, which are characteristic of that planet. But belonging to each planetary type there are desires and activities which are detrimental to the individual, and other desires and activities which are beneficial to the individual. What the desires are of each planetary type of thought-cells, both beneficial and detrimental, are set forth in lesson No. 157 Course 14 (*Occultism Applied*). And in relation to the thought-cells mapped by each planet it is indicated that instead of expressing through certain characteristic activities which are detrimental to the individual, the desires of the thought-cells should be led into other definite channels, and habit-systems of expression cultivated that will permit their energy to express in a manner characteristic of the planetary family to which the thought-cells belong, but at the same time in activities which are beneficial to the individual.

We find, for instance, that while the Saturn thought-cells may express through greed, self-centeredness, worry, fear, sorrow, despondency, or envy, that the habit system should be cultivated of taking pleasure in order, system, organization, efficiency, persistence and the carrying of responsibility.

Energy which is spent in some work beneficial to the individual leaves that much less energy of that planetary type to be used by the thought-cells in attracting events which are detrimental to the individual. This is clear enough. The problem is, how to induce the thought-cells which otherwise would find pleasure in attracting unfortunate events to change their desires and find pleasure in attracting fortunate events and conditions. This is perhaps the greatest task confronting any person; for if he can induce his thought-cells to desire and work for what he wants, good fortune will be attracted.

The most effective method of changing the desires of the thought-cells is through employing the pleasure technique. The individual must cultivate and establish the habit-system of finding pleasure in the beneficial expression of the thought-cell energy. And he must provide ample opportunity that the energy of the thought-cells can express in the beneficial channel, and thus through being drained into this activity be afforded no opportunity to express through the old discordant activities.

But people cannot successfully simply will themselves to find so much pleasure in building something for instance, that their Mars thought-cells find no energy left to express as irritation, quarrelsomeness, anger, or in attracting accidents. Instead, they must make use of association, connecting up in their consciousness the activity to be cultivated with something else in which they already have conditioned themselves to find pleasure.

But whether in this most important of all accomplishments in so far as the personality is concerned, or in the accomplishments of a business, professional or public life, the ability to overcome difficulties can be gained only through experiences in overcoming them.

The people of the United States every four years are called upon to elect a president. In making the selection for so important an office they do not pick just any man. They pick an individual whom they believe has unusual ability. And they gauge this ability almost entirely upon the man's record in the past. If this record shows that he has successfully overcome many important difficulties in the past, it gives them confidence that he will be able to meet the even greater difficulties to be encountered in the presidential chair.

And the organic alchemist, observing that the cyclic changes inevitably place difficulties in the paths of all life-forms, observing that life-forms are educated by encountering these difficulties, and that ability is never developed anywhere except through practice in overcoming difficulties, concludes that the function of difficulties is to educate the soul and develop its abilities. And because to him man is not subject to some special dispensation, he concludes that all the obstacles which man encounter have this same function, the function of developing his abilities.

To the organic alchemist, who becomes familiar with as numerous types of life as possible, pain is not inflicted as punishment, but is the device which the soul has gradually developed to great perfection to inform it that a difficulty is present. Nor is pleasure a matter of reward, but the device which the soul has evolved to inform it that the difficulty has been surmounted. And if the soul, as it often does, can become so conditioned that the effort to overcome a difficulty gives greater pleasure than the pain occasioned by the difficulty, pleasure becomes more important in this education than pain.

Yet a soul, like an athlete, acquires ability not merely when it triumphs, but also when it fails to triumph. Life-forms learn by their mistakes as well as by their correctness. And unless we hold with the orthodox of both East and West that man is under some special dispensation, we are forced to the inevitable conclusion that the joys and sorrows, the triumphs and disasters, the gains and losses, the health and sickness, and all other events of life, serve the important purpose of developing the ability of the soul. Without such experiences it would never acquire the ability to do anything important in the realms of the future.

Chapter 5

Serial No. 213
Original Copyright 1945
Elbert Benjamine

Copyright
August 2002
Church of Light

The Universal Law of Compensation

Chapter 5

The Universal Law of Compensation

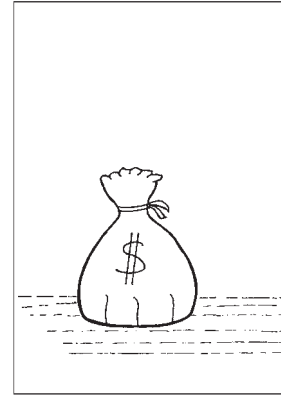

In our quest for the meaning of life, and in our effort to formulate the Law of Soul Progression, we have now arrived at certain definite conclusions. We have decided that any manifestation of intelligence implies a soul, and that back of the soul there is always an ego supplying it with the urge to struggle on. We have found that such souls are so numerous that whenever the conditions on earth permit the expression of a given type of intelligence there is always a soul of such degree of intelligence at hand ready to take charge. And all souls, due to the urge supplied by their egos, express successively in more complex forms; those that take charge and develop physical forms moving from simpler to more complex bodies in rather long steps, and never occupying the body of the same species twice.

But whether on earth or in the astral realm, the desire for continued life and individuality, by which the ego energizes the soul, is recurrently thwarted by constantly changing environmental conditions. To continue its life and individuality, the soul cannot just passively drift; for the new conditions that come upon it tend to the destruction of the form it occupies. It, therefore, struggles to retain the form through which it is manifesting, and when it loses this form it struggles to occupy another form. And these struggles to retain a form develop the ability to overcome obstacles, and thus in time, to handle a still more complex body.

That it may be aware of conditions which threaten the destruction of its form, the soul has developed a sensation which we call pain. And that it may be aware of conditions which favor the life and prosperity of its form, the soul has developed a sensation which we call pleasure.

The only possible means by which any soul learns to overcome obstacles, which alone constitutes accomplishment, is through encountering obstacles. It does not immediately know how to handle the affairs of a solar system; no more so than a child knows how to walk as soon as it is born.

The child desires to reach certain objects which seem pleasant. In its struggles to do this it learns to crawl. This method of locomotion, however, has its disadvantages, and before long the child tries to walk. At first it supports itself more or less erect by whatever it can touch. When it falls and bumps itself, as it does, it experiences pain. This pain, however, is not a matter of vengeance meted out by its parents. The pain informs it that something has gone wrong. It struggles not to fall, so as to avoid pain.

When it is successful in keeping erect it crows with pleasure. This pleasure is still further heightened when it finally succeeds in walking across the room and gaining something it desires in this more satisfactory manner. And this pleasure is an added inducement to encourage it to walk in the future.

Unless there had been an obstacle to the attainment of some desire, it would have made no effort to walk. It had not experienced pain when it failed to walk, or had not experienced pleasure when it did make a successful upright trip, it would have made no effort to keep from falling. And the naturalist, analyzing the performance of various individuals of any species, and analyzing the past and present performances of as many types of life as he can contact, is forced to the conclusion that this performance of the child is characteristic of life everywhere. It does progress, but the progression is made through overcoming obstacles. Pleasure and pain are states of consciousness which keep it informed when it should struggle and whether or not the struggle has led to success.

How Would You Manage a Universe?

—Now if you or I were managing a universe, our narrow sense of justice might induce us to endow each soul in the cosmos with just the same amount of energy, just the same attributes, and just the same functions. Such a universe, however, would not be an organic structure, but merely a homogeneous mass.

If every cell in the human body were just the same as every other cell, it would not be a human body, but just an unorganized mass of protoplasm. An organism implies division of labor, and division of labor implies specialization of parts. Thus if every individual connected with an industry performed just the same kind and same amount of work, it could produce only the most simple of articles.

In an industry in which every individual performed the same amount and same kind of labor, it would be logical to give each individual connected with it just the same preliminary training. But if the industry were to be handled according to even human standards of efficiency, different individuals would be required to perform different kinds of tasks. There would be those who would specialize in mechanical work, those who would specialize in management, those who would specialize in accountancy and those who would specialize in salesmanship. And we would not expect the accountant to be as capable in handling mechanical tools as the mechanic. Nor would we demand that the mechanic be an expert accountant.

Yet to develop mechanical ability requires a kind of training that is entirely different from the training necessary to educate an accountant. Salesmanship requires special training of another sort. And in like manner each specialist should have had experience in work that other specialists do not require.

Because even the division of labor required in modern civilization is so diverse, and requires so many types of specialists, the heaviest indictment that can be brought against our public school system is that all the children are trained for too many years as if they were to follow the same occupations. Too long is the special training each requires to develop to the utmost its specific faculties deferred. And because the different needs for individual training are thus so long neglected, our social system loses much of value that better methods in education would bring to it. It loses the high accomplishment that individuals would bring if their specialization had started earlier in life.

It needs to take a leaf from Nature's book of management. It needs to assay the natural aptitudes of the child soon after birth, and decide just what type of work it is best qualified to perform in the future. It is a decided loss to society for the child to spend years training to follow some occupation in which it will fail. Every failure is a loss to society; for the individual who fails could have been contributing something of value to the world. After failing in one type of work, he usually turns to something else. And if his natural aptitudes and the harmonies of his thought-cells, as revealed by his chart of birth, favor this something else, he probably will succeed in it. But both he and society have lost years in training and years, perhaps, in the effort to follow a calling for which he is unsuited.

Ultimately, when the function and value of astrology are widely enough recognized, no such waste of time and energy and materials will be tolerated. The planetary prominence which reveals each type of natural aptitude is now known through the statistical analysis of the birth charts of 100 people who have followed each of 30 different vocations. And the tendency to attract fortune or misfortune within the environment customary to each vocation is known.

These are set forth in detail in the reference book, HOW TO SELECT A VOCATION, which contains the result of 18 years research relative to vocational selection by The Brotherhood of Light Astrological Research Department.

With this information the type of work for which the individual is best qualified may be known from birth. And for efficiency his training from infancy on should be such that it will enable him to develop his natural aptitudes into abilities which will permit him to perform some specialized work in the world. This does not preclude a liberal education; for a liberal education may increase his value to society. But the object from birth should be to fit the individual for some particular type of function in the world's economy.

Usually with each combination of natural aptitudes which are shown by the chart of birth, there are alternate vocations, or alternate functions within a selected vocation, which may be followed. The choice of one of these may well be left to the child when he grows older. There should be no effort upon the part of adults to force the youngster to follow a definite vocation. Instead, the parents or society should see to it that he is given the type of education and vocational training which will develop his natural aptitudes into abilities, leaving the final choice of the particular field in which these abilities are to be used to the individual and the guidance offered him by his chart of birth.

If the youngster has not been forced, and thus associated pain with the use of his abilities, he will find great pleasure in using those in which he shows most excellence. His power to perform some function better than the average individual can perform it will appeal to his Drive For Significance. And a little encouragement and praise—instead of driving him against his desires—will condition him to gain a high degree of pleasure from the exercise of his special abilities and this pleasure in feeling superior because of accomplishment will cause him to exert himself strenuously to give even better performance thus developing his abilities still more.

When such a youth reaches maturity, whatever natural talents he has will be developed into abilities ready to be put to work both to benefit himself and to contribute to the welfare of society. He is then a specialized part in the world's industry, able to contribute his maximum to the general economy.

By watching the lives of those who have a thorough knowledge of astrology, and who apply induced emotion and directed thinking based on this knowledge, I am convinced that through astrological guidance and such application of induced emotion and directed thinking, the effectiveness of human life can be doubled. Merely the guidance in training for the most suitable vocation as above indicated results in great human gain. But if they were managing a universe, those who insist all children should be given the same training, instead of educating different souls to perform different types of work, probably would give to all souls the same experiences, so that each could perform the same function as the other. Yet a universe inhabited by souls thus incapable of any high degree of specialized labor would be a totally inefficient organization.

How the Divine Mind Runs the Universe

—But instead of deciding how many people would manage the development of a universal organization, it is more profitable to look about and try to discern how the Divine Mind, which actually does run the universe, handles such things.

And the most obvious thing of all is that life-forms are unlike and that they actually are undergoing different training; that is, their experiences are different.

It is said that no two grains of sand on the beach are exactly the same, and certain it is that no two undergo just the same experiences. No two plants of a certain species are the same, and no two undergo the same training.

One stalk of wheat is devoured before maturity by ground squirrels, while its neighboring stalk acquires a full head of grain. One fox is caught in a steel trap before it is a year old, endures untold agony for a day or two, is found and killed by the trapper, and its fur goes to adorn some lady who prides herself on her kindness and gentility. Another fox of the same litter escapes the trap and roams the hills for years. But why give further examples, when observing the life of any living thing cannot but bring the conviction that its experiences are different from the experiences of any other living thing?

If we permit the evidence of our eyes to have weight, instead of the theories as to how a cosmos should be run, we must soon be convinced that equality and sameness are not found in Nature. And we must also quickly become convinced that each life-form is undergoing a somewhat different training than any other life-form. These experiences, as I have pointed out in the previous lesson, are the only means by which the soul occupying a life-form can acquire ability. And, as we recognize even in the training of children, different kinds of training, which means different experiences, develop different types of ability.

If we permit Nature to speak for herself, she tells us in no uncertain terms that her object, instead of being a monotonous sameness, is to produce the utmost diversity. For nowhere, in any kingdom of life, do we find exactly the same conditions, exactly the same opportunities, or exactly the same fortunes. Instead, we are always confronted with diversity of form, diversity of opportunity, diversity of fortune, and the consequent development of diverse characters which have the ability to perform different and diverse functions.

Such observations, which anyone can make for himself, make it impossible to believe—unless we think of man as under some special dispensation not shared by other life-forms—that in some realm, past or future, all human souls will have the same opportunities, all undergo similar training, and all achieve the same end and function. The divergency between the abilities, opportunities and fortunes of men are the same types of divergencies that obtain among the members of any species of life. For man is not unique. He is merely the highest type of life as yet developed on the earth, differing from other types only in degree, but not in kind.

Therefore, for the moment disregarding the probable purpose of it, what we see daily on every hand are life-forms each undergoing experiences that are different than the experiences of other life-forms. All life-forms, due to changing conditions, are confronted with obstacles. But the difficulties experienced by one life-form are slightly or greatly different from those experienced by another life-form. Furthermore, because of difference in ability, what one life-form does when confronted by a difficulty may be different from what another life-form does when confronted by a somewhat similar difficulty.

Yet the difficulties met, and the struggles to overcome them, are the only sources of training by which a soul can develop its abilities. They are the only means by which a soul can test and develop its power. Even when the life-form is destroyed in its struggle to overcome a difficulty, it has learned something, just as a marksman, even when he misses the mark, learns something about shooting. People and other life-forms learn by their failures as well as by their successes.

But as the difficulties met and the way they are handled differ with different life-forms, they inevitably also develop different kinds of ability. Just as a watchmaker undergoes one kind of training and a locomotive engineer another kind, so all life-forms, as actually observed, are undergoing different kinds of training. And these different kinds of training must inevitably develop in them different kinds of ability.

Therefore, because we observe in nature the greatest diversity of form and the greatest diversity of fortune used to train these forms, we are forced to the conviction that among all these life-forms, either on the physical plane, or those on the inner plane, in so far as we can observe them either by physical sight or clairvoyant vision, they are being trained in a manner to produce the greatest diversity of ability.

Whatever theory we might develop to account for it, actual observation on any plane proves that souls have not the same abilities, and that the training they are now undergoing is such as to develop in each certain abilities that are not being developed by other souls.

Training For the Larger Organization

—While only the clairvoyant vision of one highly trained can perceive it, yet even to those familiar only with some degree of efficiency in organization as found on the earth, it is not difficult to conclude that this great diversity in ability fits them for performing specialized functions in an intelligently planned organization. And the seer whose vision is not blockaded by either the orthodox notions of the Occident or the orthodox notions of the Orient can actually contact such larger organizations of souls. He can perceive somewhat of their workings, and become convinced by first hand knowledge that in these organizations of souls who have developed their abilities on earth, but have long since graduated from the need of earthly experiences, there is high specialization and division of labor.

Some of the souls in these after-life organizations have had far more pain in their training than others, some have had more pleasures, and while on earth some had greater worldly success, some had greater worldly loss, some have had more extensive experiences with affectional relations. In fact, their training called for just those inequalities of experience that we today observe all around us. Pleasure and pain, success and failure, all have contributed to their training.

And to the orthodox of either East or West, this seems decidedly unfair. It seems like a misapplication of justice that one individual, except for moral turpitude, should experience more pain than another. Yet, as a matter of fact, just this does take place. And I am sure the exalted souls who now consciously perform important functions in a super-mundane organization, none of them feels he is unrepaid for the hardships of his training.

Lincoln, from the orthodox view, had a right to complain loudly, because few men of his time underwent the privations and handled the difficulties that he did. Had he not become, in early life, accustomed to painful burdens, he would not have been able to handle the still larger ones later in life. When Lincoln, as President of the United States, became the instrument through whom the slaves were freed, I imagine the joy and satisfaction of this accomplishment more than compensated him for all the disappointments and pains he had ever experienced. Even when he was assassinated I imagine he felt, not that he was an unfortunate creature, but that he was one highly favored that his life had been instrumental in accomplishing so much for his country and for the betterment of mankind.

The trials that most of us underwent while we were children in school, at that time seemed important. When we failed in a lesson, when we were punished, when we had conflicts with other children, when we were ridiculed for some mistake; all these things seemed momentous. But, even though there were real hardships, sicknesses, difficulties and pain, most of us now, looking back, have a healthy enough point of view to laugh at them.

From our present vantage point all the terrible vicissitudes which we then felt we were undergoing seem important only for one thing; they were experiences which contributed to our education. The thing that seems important now is not whether some other child was petted by the teacher, whether some other child had better health, won the class contests, or gave us a thrashing. These inequalities of that time now seem incidental. The thing that now looms large is, whether or not we developed such abilities as fitted us for adult life.

But because we refuse, in the face of observing how Nature does act, to accept the notions of orthodoxies which were formulated before anyone took the pains to observe what actually goes on about us, does not signify that there is not a still higher justice.

Not because it is a theory which coincides with how we think the cosmos should be run, but because actual observation of life-forms on earth and on other planes indicates it to be a fact, we must accept the belief that there is always compensation for effort. The effort of a life-form, whether on this plane or on some other plane, is never wasted. For effort expended, there is always adequate return.

The Law of Compensation

—But the rewards of effort are not necessarily in the direction of gaining pleasure and avoiding pain; nor in terms of health, wealth, affectional joys, or honor. The universal reward of effort is GREATER ABILITY.

There is the constant effort, upon the part of all life-forms, to triumph over the difficulties which inevitably confront them. The struggle that ensues may be accompanied by pain, or the life-form may become so conditioned that it is not conscious of pain, but experiences only pleasure in the struggle. And while the pain and pleasure experienced do influence the type of events attracted in the future, whether they shall be more severe or less severe, the pain and pleasure are not the important things connected with the struggle. The important thing about any effort to surmount an obstacle or weather a condition, in so far as the soul is concerned, is not whether the obstacle is surmounted or the condition mastered, not the pain and not the pleasure, but that to the extent it has tried to overcome the difficulty it has learned something.

To the body which it temporarily occupies, the success or the failure to adapt itself to a situation may be a matter of life or death. But to the soul occupying the body, life and death are important only as they furnish the experiences which develop the ability and character of the soul. The supremely important thing to the soul is not whether the body has three square meals a day, whether its followers give it due esteem, whether its affections are satisfied. To the soul the one really important thing is the amount of its advancement in that training which is preparing it for its own particular function in the universal organization.

Biologists are most insistent in this, that associated with every bit of protoplasm is something which remembers, and thus possesses the fundamental quality which makes learning possible. And any seer of experience is equally emphatic that all the life-forms he has contacted on the inner planes have a similar quality. This property of learning through experience is an essential quality of every soul, however simple or however complex. And the most significant thing observed in the various life-forms around us is that through experience they learn to do things.

The amount of progress, however, depends upon the strength of the effort. When they struggle to accomplish, either physically or mentally, people and other creatures learn faster than when they make less effort. Such effort, of course, varies in quality as well as in volume, but other things being equal, life-forms gain in ability fastest when they make the most effort to be successful in overcoming whatever difficulties may be present. The principle of justice, therefore, which we can actually observe in operation, and which applies to all life-forms, from the simplest to the most complex, on all planes of existence, is that the soul advances in the development of its own special abilities in proportion to the effort it makes. In soul-progression, this is the LAW OF COMPENSATION.

Efficiency

—Now, because of our familiarity with the class system of earth, in which one class, or one occupation, is considered to be more dignified, enjoyable, and yielding in material advantages, if you and I were to construct a universe, perhaps, we would permit each life-form in it ultimately to perform just the same work, in order that one life-form might not receive an unjust reward. From our viewpoint on earth, it is difficult to conceive of a society in which the reward for doing one kind of work is not superior to the reward for doing another kind of work; for we think of reward in terms of health, wealth, social success, and honor.

Yet even on earth, when the individual has found the particular work for which he is fitted, and consequently in which he excels, it is seldom he would relinquish it in favor of some other work which brings a higher reward in material things. Perhaps the athlete who wins a world record in the pole-vault is envious of the salary paid to some writer of fiction; but in terms of self satisfaction he feels that he has the superior reward. The painter may admire the orator, but if he has a real flair for painting, and makes an unusual success of it, he would far rather remain an artist than make speeches. And because being the president of a country is the place of highest material honor, it is usually spoken of as a position anyone would be glad to fill. Yet I doubt very much if the man who loves music, and is the best performer on some special instrument, would trade places with the President, even if he felt sure he could manage the job.

There is no other reward that can compare with the abiding sense of satisfaction felt by the individual who has found his work, and who believes he performs it better than any other human being. Such superior accomplishment, and the sense of importance it brings, appeal directly to the power urges, than which there is no stronger appeal.

Then there is the matter of the great and the small, and the more important and the less important, to be considered. What is the great?

In comparison to ourselves the earth seems large; but it is small compared with the sun. The sun seems large, but its place dwindles to minimum importance compared to our stellar galaxy. And this galaxy is but a single life-cell, a cosmic amoebae, as it were, among the million other known universes performing their life processes within the body of our cosmos. What grander organizations of physical substance are there, of which such a cosmos is but a cell?

As to intelligence, that of man is important in comparison to the intelligence of a cell within his body. But there are other intelligences which dwarf his puny mental faculties as completely as he dwarfs those of a single cell. What, then, is important? What is large and what is small?

Then consider the human body. In one sense the heart may be more important than the stomach, and the hand may be more important than the feet. The eye may be superior to the ear, and the lungs superior to the liver. Yet all are essential to the proper functioning of the body, and each is important in a way that the other is not. I can hardly believe that one organ of the body should feel it unjustly treated because it is not performing the functions of some other organ. Each in its own way is important, in that it is called upon to do something which it can do better than any other organ.

And so, from observing how life-forms act on the inner, as well as on the outer plane, I have come to the conclusion that large and small, important and unimportant, are rather misleading conceptions when applied to a soul. For when a soul is performing a work in the universe that it can perform better than any other soul, a work which is essential to the proper functioning of the universal organism, that soul is important. And when it becomes conscious that it can do this particular thing better than any other, and that doing it is important to the rest of creation, like the workman on earth who excels, it then experiences a deep and abiding satisfaction.

As to the great and the small, the soul is limited in advancement along the line of its own type of accomplishment only by the amount of effort it makes. For effort leads to soul progression.

Polarity

—I have previously intimated that the universal and uniform law which is applicable alike to every intelligence in the universe, which I call the Law of Soul Progression, that explains the performance of all souls on all planes of existence, when fully formulated must embrace four terms: energy, polarity, pleasure and pain.

And I have gone somewhat into detail to explain that pleasure is not something developed as a reward for the righteous, but is a sense which the soul has developed to inform it when it is successful. I have somewhat fully also explained that pain is not something developed as a punishment for the wicked, but is a sense which the soul has developed to inform it when it is being unsuccessful. And I have now indicated that energy devoted to the effort to overcome difficulties always brings a commensurate compensation. This compensation, however, which comes to the soul of a tuft of grass or to the soul occupying the body of a worm, as well as to the soul inhabiting the form of man, is not in terms of physical success or physical failure, nor in terms of pleasure and pain in some future life, but in terms of greater ability. All intelligences expand in their knowledge of how to accomplish things through making the effort to overcome difficulties. Nor does ability develop anywhere, to any soul, through any other means.

But I have not yet made any explanation of the part that polarity plays in the formula which expresses the way in which all souls perform. By polarity I mean the quality of exerting an attractive power in certain directions and of exerting a repellent power in other directions.

Now if all souls at the start of their differentiated existence had just the same polarity, just the same amount and type of attractive force, they would all tend to attract to themselves the same things, and would tend to have the same kinds of experiences; for experiences are attracted which correspond to the polarity of the soul. But as I have been at considerable pains to point out, so far as we can perceive, of all the life-forms in existence, no two seem to have just the same experiences. Observation of their lives forces us to conclude that, on the contrary, the experiences of life-forms, and therefore of the souls occupying them, are of the utmost diversity. And to account for this, unless we adopt the manifestly erroneous view that the only difference between one intelligence and another is that of age, we are compelled to believe that the attractive and repulsive force with which they were endowed when differentiated was different.

If we ask why one soul should be given one type of polarity, or attractive and repulsive power, and another soul a different type of polarity, it brings us back to what we observe. We observe that the universe is an organization in which, as in any efficient organization, there is specialization of parts and division of labor. Yet if all souls had the same polarity, and consequently underwent similar experiences, there could be no such efficient organization, because the abilities of all souls would be practically the same. Instead of being an organization capable of producing things of great complexity, it would be merely a homogeneous mass; as man's body would be if instead of there being cells and organs to perform the different functions, it was just a group of all-similar cells.

As the polarity of a soul accounts for the training it gets, through the type and amount of experiences it attracts, this polarity determines what kind of work it shall later be able to perform most effectively. That is, the kind of work that a soul shall be able to do in the cosmic scheme of things is determined at the moment of its differentiation. It is endowed, at the very start, with attractive and repellent qualities, and because of these, it attracts events that another soul does not attract, and it avoids types of events that another soul attracts.

It would be preposterous for any human being to assume what is in the Divine Mind, other than through turning in on as high an expression of it as possible and through observing its works. But judging from what we actually see, that souls are being fitted to do different things, and that even now, here on earth and in the astral spaces, souls do perform different functions which each add something to the welfare of universal society, we are justified in concluding that the reason souls are given different polarity at start is because they will be given different functions to perform in the universal scheme of things.

Viewing the cosmos as a vast living organism, in which angelic intelligences are mere cells, and intelligences such as man's are still in the early stages of training, comparable to the electrons within an atom of matter performing their movements as less than microscopic portions of a cell; from this view, we are justified in believing that egos are differentiated by the Divine Mind to develop souls to perform a given function. Souls are not developed just haphazard, catch-as-catch-can. But under the law of a supply being provided to meet a specific demand, each ego with its two souls is brought into differentiated existence for a definite purpose. There is a future need forming in the ever-expanding, ever-progressing organism of Divinity for souls which can do certain things. And to perform this function, this particular work, even as our large corporations on earth train their executives and all their other help, starting them with simple tasks, so a soul from its beginning is given a polarity which will attract to it those experiences which will train it most effectively for the performance of the needed work.

If we take this view, which logically follows the observation of what is actually going on about us, it gives us a very different conception of life and its purpose than that held by the orthodoxies of the West or the orthodoxies of the East.

Instead of considering the multitudinous intelligences which are all about us, both in physical life-forms and in astral life-forms, as under different laws and actuated by different principles, this more inclusive perspective enables us to perceive that all intelligences come into existence and perform their functions according to a single great law. Numerous as they are, rivaling in number the photons of light that are radiated by sun and stars, each and every one is brought into existence in answer to a definite demand arising in the cosmic organism.

The cosmos, like all those parts of it which we can observe, is in a process of development. It moves ever forward, constantly expanding, constantly becoming more complex, constantly increasing its capacities; a never ending progression. And this ceaseless expansion and development of abilities creates a continuous demand for intelligences which have the ability to perform those functions which the development within the cosmos makes necessary.

It is as if there were an industrial organization, or a chain-store organization, which was not static, but which was constantly increasing in size and constantly taking upon itself the performance of new and more complex duties. Older members, to the extent they exhibit sufficient ability, would be promoted to stations of more importance. And to take their place new help would be hired. Yet even though this new help were given simple tasks to perform at start, these tasks would be of such a nature as to train them for definite positions higher up.

Some would be engaged to develop into accountants, some to become sales managers having charge of a given territory, and others to be developed into heads of departments. And if, as in the case with the cosmos, the organization should continue to expand, new help would be hired right along, and old help of ability would be advanced to fill still more important positions. The continuous demand for intelligences to perform more complex functions would have to be met if the organization was to continue to make progress.

From what we see of life-forms, their number, and the way they behave, we are compelled to conclude that some such process as this is taking place in the cosmos. The expanding cosmic enterprise makes a demand for new intelligences. But these new intelligences are not just any kind of intelligences. The demands of the cosmic organization are for intelligences with ability to do specific needful things. Therefore, to meet this demand, new souls (for all intelligences are souls) are differentiated. But in their differentiation they are not given the same polarity. The polarity, which means attractive and repulsive power, with which each is endowed at the moment of its differentiation is such as to cause it to have a "flare" for the particular kind of work that the cosmic organization, in time, will have need of.

Just as the efficient president of a progressive corporation on earth looks ahead twenty years, and hires his new help with a view to their ability to develop talents which will enable them to perform complex duties at that future date, so cosmic intelligence brings souls into differentiated existence with a polarity determined by the future demand for special talent.

Even as people when born on earth have the ability to develop certain traits which fit them to perform specific kinds of work, and do not have the ability to develop into high grade workmen in other lines, so souls at their differentiation are given a polarity which enables them to develop certain talents and prevents them from developing other talents to any high degree. You may think this is unjust that all should not fare just alike in the distribution of talent; but from the broader point of view, it is a working of justice. For, after all, each soul is happiest and best satisfied when doing the things which it is fitted to do. A hand is a hand, and a foot is a foot, and neither should be envious of the other; for if it performs its own activities successfully it can gain as much satisfaction as can the other.

But when we think of souls which are brought into differentiated existence to perform a future function for which a demand is arising in the cosmic organization, we must not think merely of human souls, or even of those souls which will ultimately incarnate in human form, or which have in the past occupied a human form. We must consider that the intelligence occupying every cell of our body, the intelligence occupying every little plant, the intelligence of each elemental in the spaces, the intelligence of astral entities of all sorts which never incarnate in matter, spiritual intelligences, angelic intelligences, and those even greater, all have come into differentiated existence and developed in obedience to this law of cosmic demand and supply.

An intelligence implies a soul, and back of the soul an ego; and every soul in the universe, having come into differentiated existence in answer to cosmic demand, has a polarity which attracts to it events of one type and which repels from it events of another type. This attractive and repellent quality with which the soul is endowed at very start thus determines the kind of training it will receive.

The power which causes a soul ever to struggle onward, which does not permit it to cease its efforts and sink into oblivion, is furnished by its ego. In this sense the power urges, which developed in specific directions in human life become the most insistent of all mental factors, date back to the very beginning of the soul's existence. As yet it does not know the purpose of the struggle, for even arrived at the state of manhood few souls grasp the real significance of their existence, but the power urges, if we may call them this before consciousness has further developed, cause it to make an effort to move forward, to develop a form, and to have experiences. Like the newborn infant, it struggles without knowing why.

These struggles of the soul give it experience, and experience, recorded in its finer structure gives it added attractive and repulsive power by which it attracts a new form which is more complex. This process I have already considered in lesson No. 209 (Chapter 1), as applied to the evolution of souls through life-forms on earth. But the matter of polarity needs further attention. For each soul, at start having different attractive and repulsive powers, no two souls attract the same events, and thus no two have just the same training, and no two develop just the same abilities.

Harmony and Discord

—Due to the original polarity of a soul, some of the experiences it attracts are painful and some of them are pleasurable; which is just another way of stating that at times it is confronted with difficulties that tend to the destruction of its form or the blocking of its desires, and at other times it overcomes such difficulties as are present and gains satisfaction for its desires.

But every experience which is recorded in the finer form as a discord, as painful, has a property of attracting a discordant, or painful, event in the future. And every experience which is recorded in the finer form as a harmony, as a pleasure, has a property of attracting a harmonious event in the future. There is thus a tendency for a soul which has developed considerable harmony to attract only harmonious conditions, and one which has had many hardships to continue to attract them. But if a soul were always confronted with difficulties it could not surmount, that is only by painful conditions, its training would be unduly severe, and through always being defeated in its struggle it might tend to lose the incentive to struggle. And if the difficulties presented were insignificant, and always easily triumphed over, giving rise only to pleasure, the greatest efforts would not be called upon and the soul might not progress as rapidly as otherwise.

But in Nature we find a force constantly at work which tends to bring to the soul difficulties which alternately are easy to overcome and difficult to surmount. This force is the impact of astrological energies. That is, in addition to the attraction for painful events and the attraction for pleasurable events, the attraction for great difficulties and for those easily resulting in success, which are derived from its past experiences with pain and pleasure, there are astrological forces which periodically accentuate certain of these harmonies within the finer form, so that events exclusively of one type are not attracted.

How these astrological forces operate in human life is well understood through the study of progressed aspects. And similar astrological conditions have an influence over life-forms of all kinds and on all planes.

The types of events attracted to a soul at a given time are those which correspond to its need for experiences which will give it the proper training to fit it for its functions in the universal organization. But in addition to painful experiences and pleasurable experiences attracted through the original polarity of the soul, there is an additional factor, that of the impact of astrological forces, such as trines and squares, which modify this, and at times bring conditions leading to success, which is the triumphing over conditions, and at other times bring loss, which is failure to overcome difficulties. Yet such successes and failures are comparative. For even under astrological impact, the difficulties encountered in comparison to the ability to overcome them is chiefly determined by past experiences. Yet it is found that, when a soul learns how, though not escaping severe difficulties, but going forth to meet them instead, it is able to avoid the pain and get its training henceforth quite as speedily through the attractive power of pleasure. That is, arrived at a certain point of evolution, a soul can employ the pleasure technique instead of the pain technique in its further training, and advance even more rapidly and live even more effectively.

Chapter 6

Serial No. 214
Original Copyright 1945
Elbert Benjamine

Copyright
August 2002
Church of Light

The Universal Moral Code

Chapter 6

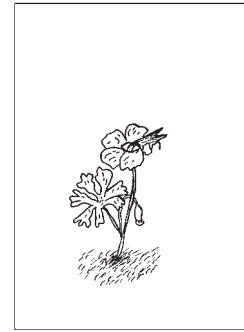

The Universal Moral Code

According to Einstein's Special Theory of Relativity, which has been sufficiently verified through observation and experiment that it is taught now in most universities, objects under the conditions which normally obtain on the earth behave in the manner commonly recognized, but if their speed is increased tremendously the commonly recognized properties vanish, and other properties are exhibited. If a bullet, for instance, could be made to travel 160,000 miles a second, by virtue of this speed alone it would shorten to about half its original length.

I mention this because in our attempt to bring all the intelligences in the universe, from bacteria to archangel, into a single formula, THE LAW OF SOUL PROGRESSION, we are confronted with something not entirely dissimilar. For up to a certain vibratory level life-forms perform in a certain way, but when their dominant vibratory rates are raised above this level they must perform in a different manner or sink back to the lower level of existence.

The most important factors thus changed when higher vibratory levels are reached are the moral code and the relation to pleasure and pain. But to avoid misconception, I must here affirm that a moral code and pleasure and pain exist on all levels of life, and influence all life-forms. It is not that they vanish when higher levels are reached, but that they there undergo a change of relations.

Below a certain vibratory level life-forms, in order to survive, not only must do constant battle with the inanimate environment, but are in constant conflict with other life-forms. It is not that they seek these conflicts, but that these conflicts are necessary to prevent their organisms being destroyed. I know of no life-forms on earth that are free from enemies. Either they must resist the encroachments of these enemies or die. And animal life, not having the power to live upon a mineral food supply, must use vegetables as food, either by eating vegetation, or by preying upon herbivorous creatures.

Organisms low in the scale of life have very limited intelligence, are conscious of pleasure and pain only in a minor degree, and have but a rudimentary moral code. But as the soul develops, gaining new experiences, it is able to contact the conditions that enable it to build about itself and function through a more complex organism. And this more complex organism is able to manifest the increased intelligence which the soul has gained through experience, the increased sensitiveness to pleasure and pain which the soul has developed through experience, and the more effective moral code, which also has been derived from experience. In fact, the only way that a more comprehensive intelligence, greater sensitivity, and a more effective moral code can be developed, if we are to credit what we observe, is through the effort to overcome obstacles. And this effort to overcome obstacles is the gist of experiences wherever encountered.

To get an understanding of this process we need not go far afield. Our California deserts afford numerous examples that I can observe by a few hours drive any day.

Vegetation, for instance, living in the arid regions mentioned, are beset with the problems common to most life-forms: the securing of adequate food, protection from enemies, and insurance that a new generation shall be brought forth and be given favorable opportunities for development. And in addition, desert life has the ever-present problem of providing itself with a water supply under quite adverse conditions. Also the intense heat is an environmental problem which must be met.

Man has considered himself intelligent for a long time, and preens himself upon his scientific attainments during the past hundred years. But our desert creatures have solved many problems that man is only beginning to understand.

Take the problem of heat, for instance. Not only do the rays from the summer sun tend to evaporate the moisture from plants, but the temperature so engendered in connection with the drying process, tends to cause leaves to curl up and burn. Two methods commonly are employed by our desert plants in their effort to overcome this difficulty.

Sunlight which is absorbed tends to raise the temperature more than sunlight which is reflected. From a varnished surface comparatively few of the rays are absorbed. Most of them are reflected. And thus many plants, imperiled by the summer sun, like the Joshua tree and the creosote bush, give their leaves a hard glossy finish.

Of the colors, black absorbs the most light and heat, and white absorbs the least and reflects the most. Other plants of the desert, learning this in the practical school of experience, coat the surface of their leaves with white. The white sage and the salt bushes, including the so-called desert holly, make use of this device. They appear white instead of green.

About a dozen years ago I noticed that the huge iron tanks in which the oil is stored after it is pumped from the ground in the California oil fields were no longer being painted black, but white. I have never verified the accuracy of the amount of temperature reduction effected, but I learned from those doing the painting that by using aluminum paint, instead of the black paint previously employed, the inside temperature of the tanks was lowered about ten degrees. Oil reservoirs in the same region where grow the white sage and various white salt bushes were confronted with the same problems as these plants. Increased temperature increased evaporation and created a fire hazard. And man has learned to meet the problem in the same way; by a coating of white which would reflect more of the light and heat of the rays of the sun.

The solution of a water supply adequate to sustain life has been solved in various ways by the plants of our arid regions. Some, like the mesquites, have an abnormally developed root system. Mesquite roots the diameter of a pencil may be seen forty feet from a tree or shrub of no great size where the sand of the dune on which it lives has blown away leaving them exposed. The roots gather such moisture as does fall, over a very wide area.

Other desert vegetation, like the cacti and agaves, and the sedums, thicken their stems or their leaves into reservoirs in which they store water, gathering it rapidly on the occasions when it is present in the soil.

Nearly all the plants of these regions take some means to prevent the rapid evaporation of such water as they do secure. The most common method employed is to make the leaf thick, with a hard surface. Even the oaks and the rhus of the adjacent hillsides have adopted this device. Still others, however, such as the smoke tree and ocotillo, bear leaves only a very short time, and then shed them, leaving only bare stems, for the hot portion of the year, through which little moisture can depart.

These plants, living where green food is at a tremendous premium most of the year, are in great danger from herbivorous animals. And to meet this, most of them have developed a defense. Not only the cacti, but many of the shrubs, such as the palo verde, catclaw, desert ironwood and mesquite, have cultivated an effective armament of spines or thorns.

Successfully solving the problem of securing and retaining water, and fighting off enemies until maturity, a new problem arises affecting the race rather than the individual member. And a problem which concerns others than the individual called upon to solve it has moral significance. Such is the problem of reproduction.

Mostly this is solved by the use of insects, although the most successful group of plants in the world, the grasses, have abandoned insects and have devised a method of compelling the wind to work for them. The ingenious methods adopted by flowers to attract insects to them and secure cross fertilization are amazing in their cleverness and their number. And some of these, after using insects for untold centuries, are now in the transition stage, gradually abandoning these carriers of their pollen in favor of currents of air or water. But, of course, our desert plants for this purpose do not make use of water.

After the young have been nourished for a certain time, the final problem of the parent is to provide a method by which they shall get a favorable start in life for themselves. If the seeds, which are young plants whose development has been arrested at a certain point, were to be merely dropped by the parent, the competition for food, water and light, due to crowding, would prove unfavorable. Therefore, our desert plants have devised many ingenious devices for seed dispersal.

Sand-burs, like cockle-burs of the less arid regions, make use of passing animals to carry the seeds to distant places and drop them there. Desert dandelions like the more common species of the city lawn, construct a silken parachute for each of their children, to waft them to distant parts. And the tumble-weed, as the seeds become ripe, weakens its stem where it joins the ground until a passing gust breaks it off. Then, propelled by the wind, perhaps for a mile before it is stopped by some shrub or rock, it bounds along, rolling and tumbling, and every time it strikes the ground acting as a salt-shaker does, jolting the numerous seeds from their tiny pods. It has brought these plant children into the world, it has provided each with sustenance enough to give it a good start by surrounding it with a layer of food, and now it has ingeniously contrived that they shall not be unduly crowded in their endeavor to live lives of their own. Thus it has fulfilled its moral obligations.

These plants I have thus briefly mentioned have been confronted with specific problems, and as individuals or as species, were compelled to solve them or perish. The efforts thus engendered have developed initiative and intelligence of a degree. The moral obligations of such life-forms are mostly confined to the preservation of themselves and their race although to do so many of them have been compelled to enter into a relationship with insects.

These insects do not work without pay. Unless they find nectar in the flower they refuse to visit it and proper fertilization is prevented. The insect has the selfish object of securing food for itself and its young, and the flower has the selfish object of providing for the perpetuation of its own species. Yet when some men desire certain work accomplished that benefits only themselves, and other men wish money with which to benefit only themselves and their families, a relation is established which may readily assume moral import. The whole question of Capital and Labor hinges on this relation; and according to common human standards each has a moral obligation to the other.

High degrees of cooperative effort by members of two species to secure a common advantage is not rare among creatures other than man. Lichen, for instance, such as are commonly seen growing on rocks and trees, are a long established and highly specialized partnership between algae and fungi. Fungi obtain food readily from organic matter, but have none of the green coloring material which enables green leaves to take food from the atmosphere. Fungi can attach roots and draw from soil or the bark of trees, and algae have abundant green leaves to feed upon the carbon in the atmosphere. Thus long ago these two species of life entered into a partnership that has become so close in the lichens of today that they are inseparable, and are considered as one organism.

Another type of cooperation is that of the tickbirds and the rhinoceroses in Africa. The tick-bird lives chiefly on the back of the mammal, getting its food supply from the insects with which his hide is infested. The rhino has poor eyes, and the tick-bird renders still another service by raising a commotion when some other creature seems to menace the big and truculent fellow with which it is associated.

Still another kind of cooperation is that to be observed in some of the ants here in California. From the scale insects with which citrus trees become infested the ant is able to get a drop of sweet fluid which he relishes. Consequently, when a tree has been cleansed of this pest, the ants carry new ones into the trees and establish them there. They use these insects, the scale, as men use cows. They treasure them and care for them, and see to it that they have a proper environment; much to the annoyance of the fruit men. Yet while the fruit man suffers through it, the partnership is beneficial to both ants and scales. Here we see the rudiments of a moral code as applied to a different species, in that the ants feel an obligation to secure the welfare of their domestic animals.

It is such a relationship as exists between man and various domestic animals such as the cow, horse, dog, sheep, pig, chickens and goat. Yet man, because these creatures are of a different species, and quite remote in attributes from himself, feels very little responsibility for them. His interest in these creatures is almost solely that of what he can gain from them. Because they are so different from him he feels no particular obligation to provide for their comfort. Only in very recent laws penalizing unnecessary cruelty to animals do we see even the beginning of a moral code which embraces other species of life than his own.

For that matter, mankind in the past has been so divided into classes that the responsibility of a favored class toward those less favored has been hardly more clearly defined. There have been, it is true, laws passed in recent centuries in the West preventing a member of the favored class from wantonly and directly taking the life of a member of the less favored class. Murder has come to be frowned upon even when committed by aristocracy upon a peasant. But in indirect ways, such as forcing him into needless wars and monopolizing the resources of the earth in such a manner as to prevent him making a living, the less favored class has been slain by the million with no great pang of conscience on the part of the more favored class.

I have no intention of delivering a diatribe against the economic conditions under which we live. I am interested here only on the moral side of the issue. And everyone who is familiar with conditions as they exist in most parts of the world knows that it has been the practice in the past for those possessing wealth to get as much from, and give as little to, those who labor for them as possible.

In many respects the sweat-shops of our cities, where child labor has been employed, have felt less responsibility for the human life employed by them than the farmer has felt for his horses. The farmer is too intelligent to stunt the growth of his colts by placing them in harness too young. And he is too intelligent also to give scant food or poor housing to any of his animals; for if they die of privation he has lost something of value. But those who have employed labor in mills and factories have felt no such responsibility for the comfort and health of those employed. If these died it was easy to get more. That society as a whole lost what these might have accomplished, or that there was a definite moral responsibility, seems to have seldom occurred to such employers.

In the past the moral responsibility of employer toward employee has been at least on no higher level than the responsibility of the ant toward his domestic insects. Those of wealth have looked upon those who labored as in some manner very different from themselves. The moral code adopted prevented an employer from killing an employee in an act of personal violence; but he could kill him through unsanitary conditions surrounding his work, kill him by subjecting him to unreasonable hazards of losing his life through accident, or kill him through depriving him of the necessities of life, without violating the then existing moral code.

These conditions are changing; and employers are more and more compelled by law—which is a reflection of the established moral code—to furnish sanitary conditions under which to work, and to be liable for the injury of those while so employed. And the moral code gradually is widening to embrace the responsibility of those of greater ability toward those of lesser ability. The living conditions of every man in a nation are coming to be recognized as a matter of concern to all, and the moral code gradually is moving to make it difficult for some to acquire so much of the resources of the world that others are unable to procure the bare necessities.

The Widening Moral Code

—Already, in lesson No. 211 (Chapter 3), I have traced how the moral codes of different groups have developed, and why the moral conceptions of different people are so diverse. It was there shown that as more individuals and groups were embraced in a single larger unit that the moral code expanded to embrace these various members. People who at one time considered their moral obligation ended with the actions which insured the welfare of their family later, as the tribe was formed, broadened their views to embrace actions beneficial to the tribe. Later still actions beneficial to the nation entered into the moral code. That is, the moral code was not limited to members of a single tribe, but embraced the relations to all members of the nation.

The expansion of the moral code is merely an extension of the principle which enables the tick-bird and rhinoceros to live together for mutual advantage, which causes ants and insect scales to cooperate, which gives the farmer and his horse mutual interests, and which we now see at work bringing about a readjustment between the relation of employer and employee. The principle everywhere is that of specialization of parts and division of labor for greater benefits. Moral codes are built, as pointed out in lesson No. 211 (Chapter 3), upon advantages to be derived by individuals from belonging to a larger unit, to a group which by virtue of its complexity is able to function more effectively for the benefit of all, or at least of a majority.

Yet as we have seen, the moral codes commonly in use in the world are widely different in different localities, and even the more embracive are moving forward to include still other relations between life-forms. The proper relation between employer and employee, or if these types are done away with between manager and physical worker, is still poorly defined. In time it will be worked out upon the basis of specialization of parts and division of labor so that each of these at present distinct classes of people will contribute most toward the richness of life of the nation as a whole.

But the moral code in its progress cannot stop with national boundaries. In time, studying the specialization of races and countries it must define what, according to division of labor, each shall contribute and each receive in the economic structure of the world. Nor can it stop merely with the human race for specialization of parts and division of labor is not confined to the human species. It eventually will be called upon to define the proper relation of man to other types of life-forms.

The only way man can determine what an individual in an industrial organization can best do to benefit the organization as a whole, that is, what particular work he should follow, is to study the man's abilities and study the requirements of the organization. The only way the proper relation between employee and employer can be correctly defined, is through a comprehensive study of the requirements of both groups. And the only way that mankind can define the particular function each nation should assume in world affairs is to study the abilities and resources of each nation in connection with a worldwide organization which shall be able to engage each in its most efficient capacity. Such a scheme calls for world-wide planning. It is probably some distance in the future. But it will in time be seen that such a world-wide economic scheme is the only thing which will prevent nations from destroying each other due to useless forms of competition.

The engineering skill at this moment is available to appraise properly the resources of the world and organize them most effectively. Raw materials are available, machinery is available, and the unskilled and skilled manpower are available—as production and distribution for World War II has amply demonstrated—to provide the comforts of life, and even many of the luxuries, to every man, woman and child on the face of the globe. But it will take some time to realize such world-wide freedom from want because every step in that direction will be resisted by those whose special privileges would be eliminated by such change.

Until the proper relation of man to man was discerned, every family was considered the enemy of every other family. Every tribe later was the potential enemy of every other tribe. But when man learned to cooperate, on the plan of specialization of parts and division of labor, destructive competition gave place to constructive competition in which the welfare of the larger group was considered paramount. And only when nations learn how to cooperate, each doing the thing for which it is best fitted in promoting the welfare of the whole world, will constructive competition such as is beneficial to world progress take the place of the destructive competition that now leads inevitably to war.

But when we have united all men in a moral code which defines the proper relation of nations as well as the relations of individuals, we have not yet arrived at a perfect moral code. A perfect moral code, of course, must be based upon a full comprehension of individual abilities and needs in relation to the needs of the larger organization of which the individual forms a part. And a perfect moral code which is applicable to all souls must embrace the abilities of these souls and the need for them in the cosmic organization. Such complete information is not at hand even in regard to the life of smaller groups. Yet as knowledge advances, it may be included in the moral code to make it progressively more perfect.

The Basis of a Perfect Moral Code

—At least we know the basis upon which a perfect moral code must rest. It must rest upon specialization of parts and division of labor. And as it embraces all souls in the universe it must consider the universal organization, the cosmic organization, as a complete unit, the welfare of which as a whole must insure the highest welfare of its component parts, just as the true welfare of a nation secures the highest welfare to the individual embraced within the nation.

There are many individuals within our nation who do not comprehend, and do not live up to, the generally accepted standard of morals. And, of course, below the intelligence of man we cannot expect life-forms to understand the advantage, or the significance, of working for the advancement of the whole cosmic organization. Even among men, at present it is the few rather than the many who perceive that world progress is of greater importance than the welfare of their own nation, or that national progress is more important than their own individual bank account. But the inability of more than a few to perceive its advantages and its truth does not prevent there being a uniform and universal code of morals applicable alike to all souls.

This code is very simple and may be stated thus: **A SOUL IS COMPLETELY MORAL WHEN IT IS CONTRIBUTING ITS UTMOST TO COSMIC WELFARE.**

All life-forms lower in the scale of intelligence than man are gradually developing toward a point where this perfect moral code will be accepted. And all the various conflicts, the terrific competition of individuals with individuals and of species with species, are a necessary preparatory training. For only through the various obstacles presented to it does any soul learn to overcome difficulties. And only through developing ability to overcome difficulties, to perform work of a high degree of complexity, is any soul able to contribute much of consequence to cosmic welfare.

Below a certain state of intelligence, which man should be able to attain, the knowledge of a soul is so narrow that it can embrace proper relations only to its own family, its own herd, its own tribe, or its own nation. Below the intelligence of man the soul believes that its own welfare and the welfare of its limited group is unrelated to other groups except as such other groups afford it temporary advantages or temporarily endanger its existence. Consequently, arrived at the estate of highly developed man, the moral code undergoes a marked change. Instead of being chiefly concerned with the welfare of a limited few, the code, and the actions which spring from it, demand that the welfare of all other souls in the universe shall be given due consideration.

Not How Much I Can Receive but How Much I Can Give

—This new code of morals, which is sponsored by the spiritual side of the planet Pluto, reverses the motive and the response from it, so that behind all action is the thought, not how much I can receive, but how much I can give. The more that can be given, if it truly aids cosmic progression, the higher the satisfaction.

This brings us to the consideration of pleasure and pain as necessary factors upon the higher vibratory level of existence which we are now considering.

As I have repeatedly pointed out in these lessons, the soul has gradually developed an awareness to such conditions as blocked its desires or destroyed the form it occupied. This awareness is called pain. And another state of awareness was developed by the soul to keep it informed when its desires were being obtained and its form was thriving. Movement, therefore, tends to be away from pain, or in the direction of pleasure. And action in a given direction may be either due to the effort to escape from pain or the effort to attain pleasure. But when the soul has arrived at a certain level of intelligence, instead of being driven by pain to the performance of those acts which are necessary to preserve its form, to attain its desires, and to develop its abilities to the highest degree, it can substitute the attractive power of pleasure to impel it to such efforts.

As a matter of fact, we see this principle of conditioning, by which an action that at one time caused pain becomes an action that is accompanied by pleasure, at work among the various life-forms of lower degree by which man is surrounded. They do not, however, apply the principle deliberately, with a view of cultivating appropriate emotional states to accompany beneficial activities. But man has the power, by thus intelligently using the conditioning process, to develop a keen sense of pleasure in any condition or activity which reflection indicates is beneficial. Through this process he develops to a state of consciousness, or vibratory level, in which he finds great pleasures in all those activities which assist the development of his own special abilities, and in those which he believes to contribute to cosmic welfare.

Creatures which hunt for a living are driven to this activity originally by the pangs of hunger. Pain of starvation causes them to exert themselves to become expert in the catching of their prey. The patience of a cat watching for a mouse certainly would be most painful to another creature. Yet because cats have found pleasure in eating the food thus captured, this pleasure has become associated with the process of watching a mouse hole. The activity which at one time reported distress to the soul of the cat, no longer reports distress, but instead reports pleasure. And while cats still hunt when driven by the pangs of hunger, most cats will also hunt when there is no necessity, just for the fun of it.

A hound, originally driven by the pain of hunger which threatened the destruction of its body through weakness, learned he could catch a hare by chasing it. Such terrific running called upon every reserve of nerve and muscle. It was a painful process, an awful strain upon the whole organic system. But in the end the hound caught the hare. A difficulty had been overcome through a painful process, but the pleasure which resulted from the defeat of the difficulty registered strongly. And as the feat was repeated, the sense of pain ceased to register, and in its stead the whole activity of the chase became strongly associated with the sensation of pleasure which its successful termination brought. Hounds do not feel it a hardship to run a hare; they feel it is an occasion for jubilation.

Conditioning to Pleasure

—While it is true that cats and hunting dogs have thus become conditioned through generations, so that the joy of the chase has become instinctive, yet both dogs and cats can be thus conditioned, and have been so conditioned in laboratory experiments, to find pleasure in activities which were quite foreign to any that were habitual to their ancestors. And did the necessity warrant giving such detail, I could indicate in the life of any plant or animal with which I am familiar, how certain activities that in earlier times were painful, have been conditioned through pleasure brought by the success resulting from them, so that now they may be classed as pleasurable.

These creatures, in regard to certain classes of obstacles which confront them, no longer need to be prodded by pain in order to be aware that they are in danger. They recognize the condition before it begins to destroy them, and they take the initiative to overcome it, not because of pain, but because they have become conditioned to finding pleasure in such activities. We perceive thus even among lower life-forms when the soul gains the power to recognize the obstacles which confront it, and to make the effort to surmount them without the prodding of pain, that the particular awareness of the soul which we call pain no longer becomes necessary. In such things as the soul has thus learned to recognize the proper relation of to itself, its activities are prompted by pleasure instead.

And this pleasure technique of meeting difficulties has the great advantage of attracting events, or difficulties, in the future which are not too great to be surmounted. That is, experiences which we now have that enter our consciousness as painful, combine with mental factors already in our mind in a discordant manner and tend to attract other painful experiences in the future. But other experiences of a pleasurable nature, or even the same experiences if they are conditioned properly to be considered pleasurable, enter the consciousness in such a manner as to combine with other mental elements in a harmonious manner. And this additional harmony within our finer body tends to attract fortunate events in the future. This is explained in detail in Course 9, *Mental Alchemy*.

If, instead of considering pain and pleasure as punishment for sin or as reward for virtue, as do the orthodoxies of both East and West, we consider them as types of awareness gradually developed by the soul to keep it informed as to how its form is faring, it will enable us to perceive the value of developing the pleasure technique. We will perceive that as consciousness of pain has developed to make a life-form aware of discord, that if the life-form can develop some other method of becoming aware of the discord and acting upon this knowledge, the sensation of pain loses its value.

And man has the ability thus to become aware of the difficulties which threaten his destruction, and the difficulties which lie along the road of his progress. Reaching this new vibratory level, he no longer needs pain to spur him on. His intellect and his intuition, informed of what is going on about him, keeps him posted as to dangers and possible advantages. Furthermore, he deliberately and gradually becomes conditioned to finding pleasure in all the activities which his intellect and his intuition inform him are beneficial to himself and to cosmic welfare.

This does not mean that man, arrived at the vibratory level of cosmic consciousness lives a life of leisure. Nor does it mean that he no longer attracts difficulties. On the contrary he lives a life of intense activity. And when difficulties vanish he ceases quickly to progress. Wherever in Nature you observe a life of ease, you witness the commencement of deterioration.

But when man arrives at the vibratory level of cosmic consciousness, or even approaches this level close enough to perceive that there is a uniform and universal code of morals which is applicable to all souls in the cosmos, he no longer needs to be driven forward to the development of his abilities by pain. Instead, he endeavors to learn in what direction the cosmos is expanding, and what abilities he possesses which still more highly developed will be valuable in aiding the cosmic organization in its further progress.

Whether he will or not, changing environment is sure to bring to him, as to all life, obstacles and difficulties. But instead of sensing these difficulties as painful things, or waiting until they do produce pain, he views them as opportunities. That is what they actually are; opportunities to develop ability. But viewed as opportunities, even though they are painful in the sense that the grueling training of an athlete is painful, yet because of the glow of pleasure experienced in the knowledge of developing abilities each and every one of them may become conditioned so as to yield only pleasure.

By dwelling on the advantages that such training gives as developing ability, and by dwelling on the joy of triumph in the end, any circumstance of life, no matter how distressing a similar circumstance may be to another, can be made to yield a high degree of pleasure. The individual, through keeping his mind centered upon the spiritual end to be attained becomes almost oblivious of the discordant elements, and the event as a whole is largely registered as a pleasurable experience. Even when there is a failure to attain the desired physical end, by cultivating the sporting attitude toward life, more joy may be had from the consciousness of having made a splendid effort than another would get from having made a physical success of the same thing.

Furthermore, because the cosmic organization needs as much ability in the individual members as possible, when this high vibratory level of consciousness is reached, the person does not just sit back and wait for difficulties to be presented. He realizes two things: That the only way his abilities will expand is through encountering obstacles, and that there are always things of importance that need to be done in the interests of cosmic progression. Consequently, he seeks difficulties upon which to practice. When affairs begin to run along so smoothly that they do not call for his utmost exertion, he looks up something else to add to his responsibilities. And this something else must be of a nature to contribute, as much as possible, to the advancement of cosmic society.

Such a person becomes actuated by a single dominant motive; to contribute as much as possible to universal welfare. And to do this he realizes that he must not only do what lies now within his power to accomplish, but that his contribution to cosmic welfare must also be of a nature to call for his most strenuous exertions, for only then is anyone able to develop ability of a high degree.

But in seeking work which will contribute to cosmic welfare as much as possible, and at the same time develop his power to overcome difficulties, he is cautious not to attempt more than he can do. Even though in attempting what it is impossible for him to accomplish he is developing his abilities, if he fails, especially if the failure is accompanied by his death, it may deprive society on the physical plane of what he otherwise could accomplish. And it is probable that his services at the time are more needed on earth than on the inner plane.

To one possessing strong sympathies, to observe what goes on around him is horrifying. Most people are so absorbed in their own affairs, or feel that other life-forms are so different from themselves, that they spend no time in contemplating the cruel struggle everywhere present. Of wild creatures, only a few die of old age; for as their powers begin to wane it is the common lot for them to be devoured by their enemies. Little fish prey upon the plankton of the sea, are eaten by fish still larger, and these in turn fall the victim of other enemies. Even man, although the larger life-forms other than members of his own species no longer cause him alarm, usually succumbs sooner or later to one or more of the minute species of life which finds its way into his organism and destroys it.

The Higher Code

—Except within the family, or within the herd or flock, the moral code of tooth and claw prevails below the vibratory level of man. It is a matter of kill or be killed, destroy others or perish, usually referred to as the survival of the fittest.

Yet without the training the souls occupying these life-forms get through the merciless struggle in a world filled with enemies, initiative, courage, alertness, intelligence, and most of the other attributes which are the pride of man, would never have been developed. The whole process of evolution as observed on earth, below the vibratory level of man, is toward enabling the life-form to survive in a world of redoubtable antagonists. And survival under such conditions calls for great ability to do things; that is, to overcome whatever obstacles bar the path of desire.

The school which Nature keeps is more admirable for the purpose of developing ability than any method of which we can think. And results speak for themselves; for life-forms have developed, and continue to develop, ability in high degree, as I have taken pains to describe in some detail. But we must not conclude that Nature goes no further in her teaching than to develop powers which are used to destroy. Each ability she has cultivated in a life-form can be used constructively as well; and when a constructive level of consciousness is reached it will be used to perform a constructive function.

The estate of man is the vibratory level where the powers and qualifications which have been developed in lower life-forms should become redirected, or more properly, made more embracive. Instead of being used merely to sustain the individual, increased intelligence points out that they should be used for the benefit of all the family. A further increase of intelligence shows that they should be used for the benefit, not merely of the family-for the animals do this -but for the benefit of the community and the nation. And as intelligence becomes still more comprehensive it is perceived that the abilities should be employed for the benefit of the whole world; and as cosmic needs are perceived, for the benefit of the whole cosmos.

Even as Einstein's Special Theory of Relativity and much observation indicates that objects with low velocities have the properties and perform in the manner characteristic of physical things, but that when they acquire velocities greater than that of light they acquire new properties and perform in a quite different manner, so if the soul is to acquire the characteristics common to spiritual vibratory levels, and to function on such more desirable levels, it must raise its own dominant vibratory rate to the frequencies of such higher conditions. This it cannot do while its motives are no more embracive than that of tooth and claw, of kill or be killed, destroy others or perish. Self-interest has so low a vibratory rate that to the extent an individual has that as his dominant motive he must be content to function on the levels where animal propensities are the chief characteristics.

But when he perceives the general outline of God's Great Plan, that each soul is being educated to perform a necessary work in the future, and that the progress of the whole depends upon such specialization and proper division of labor, this knowledge also should indicate to him that his own further advancement depends upon the redirection of his energies with the purpose of assisting as much as possible in the progress of the world.

If the world is to make proper progress, not just a few of its people must have opportunity to gain knowledge and develop abilities, but all must have such opportunities. The development of a few souls only is a sad waste of material. Instead, all the people of the earth should be given the opportunity to learn as much about Nature's laws as they can assimilate, all should be given the opportunity to develop whatever natural aptitudes are shown in their charts of birth, and all should be encouraged to develop as much spirituality as possible. These opportunities require that all people should have Freedom From Want, Freedom From Fear, Freedom of Expression and Freedom of Worship.

Relative to developing spirituality, THE LAW OF COMPENSATION demands that effort must be made in the proper direction if it is to be acquired. And for acquiring spirituality the most effective effort is that directed toward living the completely moral life, toward, that is, CONTRIBUTING THE UTMOST TO UNIVERSAL WELFARE.

Up the ladder of developing abilities each soul climbs. And the souls of all life-forms, as well as that of man, are in the process of making this ascent. Each is in the throes of developing such special kinds of ability as the cosmos will need. But when the estate of man is reached the training no longer requires those destructive activities which are quite proper in the brute world. And the intelligence he now has developed no longer requires that he return to earth for the further development of brutish characteristics.

Having arrived at the vibratory level of a somewhat spiritual man, his activities are all directed by the perfect moral code. Behind all his activities at all times is an intense desire to contribute as much as possible to cosmic progression and welfare. And because, at this level he perceives the necessity of seeking difficulties to train him for still greater tasks, and because he can become intellectually aware of difficulties and view them as opportunities rather than as occasions for distress, he practices organic alchemy by transmuting experiences that otherwise would be painful into such as give him the thrill of conquest and the joy of noble effort.

Chapter 7

Serial No. 215
Original Copyright 1945
Elbert Benjamine

Copyright
August 2002
Church of Light

Discerning God's Great Plan

Chapter 7

Discerning God's Great Plan

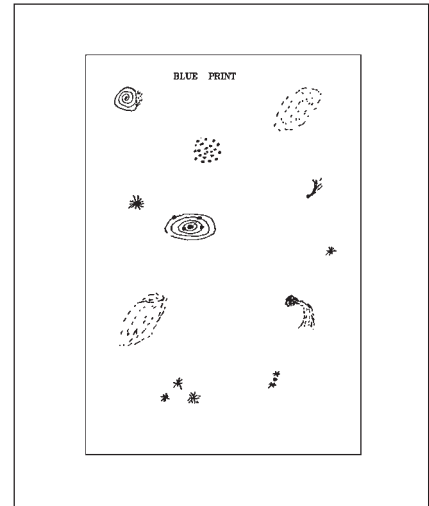

We have become familiar with the Hermetic Axiom, “As it is below, so it is above,” as witnessed in the construction of the material universe and in the relation of man to the stars, but few are familiar with the operation of this axiom as applied to all those intelligences which we designate as souls.

We recognize that the Solar System consists of planets revolving around a central nucleus, or Sun. Chemists offer proof that an atom of matter is built on a similar plan; due allowance being made for the vibratory level of the atom. It consists of a central nucleus of protons, around which revolve one or more electrons. That is, an atom is a miniature solar system. As is the large so is the small. And a galaxy, like the Milky Way, composed of perhaps two billion suns, also revolves.

There are more members in a galaxy than in a solar system or in an atom, yet these suns apparently move around a common center. Other such galaxies, seen at a distance, are known as spiral nebulae. Due allowance being made for plane of action, in this case rapidity of motion, a galaxy, or universe, performs much as does a solar system. And, no doubt, due allowance being made for the vibratory level, or speed, the universes, galaxies, or spiral nebulae, also revolve about some unknown center, comprising a stupendous atom in the cosmic anatomy.

We who study astrology have proof from day to day that the movements of the heavenly bodies correspond accurately to the movements of mental factors within the finer body of man. The whole science of astrology is based upon the correspondence between factors in the Grand Man and similar factors in the life of individual man.

Most occult students have recognized the foregoing; but all too few have recognized that intelligences of lesser magnitude, due allowance being made for plane of action, have a correspondence to intelligences of greater magnitude. But this is revealed through a study of organic alchemy.

Within the body of man are a wide variety of intelligences, all performing their individual functions, all evolving along the lines of their own development, and yet at the same time all contributing more or less to the welfare of the human form of which they are a part.

The single cells of the human body are not all alike in structure, nor do they all have the same type of intelligence, nor perform the same functions. They are specialists, some performing one work and some another. But they all belong to the intelligence-level, or vibratory rate, of single-cell life. That is, while there is specialization for the purpose of division of labor, there is great similarity between them.

But the intelligence which has dominion over some organ of the human body is not on the same intelligence-level. It had traveled a long way in its education, as compared with any single cell, before it gained the ability to move in from the astral and take charge of a developing organ. Pleasure and pain in connection with its experiences with obstacles to be overcome gradually developed it to a degree where it now governs some organ. It is a specialist. It knows how to govern some particular organ and knows very little about certain other organs.

Yet, due allowance being made for intelligence level, it corresponds in its activities to the intelligences occupying single cells. I do not mean that the intelligence directing the activity of an organ operates in exactly the same way that the intelligence does occupying a single cell; but that the correspondence is quite as close between these two types of intelligences as it is between the organization of an atom and the organization of a solar system.

Now all solar systems are not alike in size, in activity, nor in function. Within our galaxy they perform functions based upon the plan of division of labor. And the organs of the human body, and the intelligences occupying them, likewise are different, and perform various functions, all of which are essential to physical man. Yet the intelligences of these organs occupy a certain intelligence-level, which we might term the organ intelligence-level. And it is very easy, when the function of an organ is known, to perceive its correspondence to a certain group of people. The heart, for instance, corresponds to the dominant political groups, the brain to the scientists and thinkers, the stomach to the grocers and restaurant keepers, etc.

Of course, because people occupy a very different intelligence-level than do organs, they do not behave just the same as organs do. The ruling intelligence is not so superior in intelligence-level to the lesser intelligences ruled over or directed. But for that matter a galaxy does not perform in just the same way a solar system does; yet its behavior is of a similar pattern, due allowance being made for the speed of movement. And groups of people who perform a given function in the social economy, due allowance being made for intelligence-level, behave in a manner which corresponds to the actions of the organs of the human body.

People, in time, and usually on a higher plane than earth, evolve to a point where they unite with their soul-mate, as explained in detail in lesson No. 182 (Course 20, *The Next Life*), in a definite soul-mate system. By virtue of forming such a system, they have powers far surpassing any they could have hoped to reach as individuals. And each such soul-mate system becomes a part of a larger system, taking charge of its own department by virtue of the function it has been evolved to perform. At the intelligence-level which I am now considering, the soul-mate system can no longer be termed human, but has a right to be called Angel.

These Angels band together, upon the plan of specialization and division of labor, for the bringing forth of new universes. How this is done I have not the intelligence to hazard even a good guess. But I am confident that each Angel (highly evolved soul mate system) constitutes the directing authority of lesser intelligences banded together in a manner corresponding somewhat to the intelligences that are embraced within a single human organ. Yet even as the body of man has the soul of man in charge of the intelligence directing each organ; so in this larger Man, all the Angels, corresponding to organs, are under the leadership of an intelligence still higher than the Angels.

Such Angels do not perform exactly as do the groups in human society, but due allowance being made for vibratory level, their behavior corresponds as closely to social groups on earth as the performance of a galaxy corresponds to the performance of the larger organism of which it forms a part.

Beyond this I cannot go in detail, because my mind is too puny. But I do sense that there is a still larger organization of these exalted ones who direct the activities of a universe through Angels.

There are many types of intelligences within the cosmos of which as yet we have not the slightest notion, and there are intelligences, and physical functions too, for that matter, within our own bodies, about which as yet we have no information. But if we are to judge what is as yet unknown by what everywhere is apparent we must conclude that the cosmos is an interlocking organism, system within system, intelligence within the domain of intelligence; and that the whole scheme functions on the plan of specialization of parts and division of labor.

How the Cosmos is Managed

—Having discerned that the Hermetic Axiom, “As it is above, so it is below”, is as applicable to organizations of souls as it is to organizations of a more mechanical nature, we are in a position to learn considerable about the way the universe is directed by a study of the way man directs the activities of his body.

The intelligence, or soul, of man envisions some activity through which something is to be accomplished. The necessary orders are passed along to the various organs which should take part in these activities. These, in turn, direct activities of the cell-life within their dominion toward the end in view. And as a result the whole body of the man moves toward the accomplishment of the desired thing.

It is quite unlikely that the intelligence of a single cell within an organ is sufficiently developed to be able to discern that the man, for instance, is constructing a mechanical contrivance called a watch. Even the organs which take part in the work can hardly be expected to know how the mechanism works that goes into the construction of an intricate time-piece. Yet both the cell-life and the intelligence of the organs have sufficient intelligence to be able to discern, at least in a general way, what is required of them. That is, they are sufficiently aware of how the human body is run to feel that certain actions on their part are in the direction which the superior intelligence of the man is desirous of moving.

Not only so, but a single cell, or group of single cells, can become convincingly aware that some unusual activity on their part is needed. A man can talk to a certain group of cells within his body, and tell them just what to do. By repeatedly talking to them thus they are made to understand the kind of activity required. We say, commonly, that in this manner the unconscious mind of man is able to direct the activities of any group of cells, or any organ, within the body.

But in order to elicit the desired activity from the single cells, or from the organ which customarily directs them, it is necessary, through suggestion, affirmation, or talking to them, that the unconscious mind of the individual in on the unconscious mind of the cells or the unconscious mind of the organ. The unconscious mind of the individual is not the unconscious mind of the cells, nor the unconscious mind of the organ concerned. Each cell, and each organ, has its own unconscious mind, or intelligence; as much so as that each individual in the United States has a mind, and each city has a mayor, but all together they do not comprise the mind of the President of the country.

To arouse the activity of a cell or organ, in some manner its consciousness must be reached. But it is not to be supposed that because a cell or an organ responds to the thought or desire of the individual inhabiting the body, that it knows all about what the individual is trying to do. It can only perceive what the desire of the superior intelligence directing the body is in relation to its own activity and the activities of its associates. It does not know the exact meaning of the words given it by suggestion or affirmation, but it feels their general import, and as a result endeavors to carry out the activities that thus have penetrated into its consciousness.

Nor can we expect man, with the modicum of intelligence which he can attain on earth, to have any very comprehensive idea of what is to be accomplished by the universe in its movements. Our scientific men have now concluded that our cosmos is expanding, and that the outer spiral nebulae, or universes, are moving away from us at the rate of 12,500 miles a second. This is supposed to be a part of the expansion set up within the universe about ten billion years ago, that is, at about the time, according to Einstein, our earth was born.

They say also, that within the blood-stream of an average man there are 25 trillion red blood cells, which is a number probably greater than all the suns within our own galaxy, dark ones included.

Those blood cells, when a watchmaker moves his arms about, might be convinced by the way they feel, that there is an activity of magnitude going on about them in the larger structure which constitutes their universe. But they would be unable to comprehend the nature of the watchmaker's work, and would be as ignorant of the mechanical thing being devised as our scientists are of the ultimate object to be accomplished by the apparent expansion of the cosmos.

Yet these blood cells, being tuned in somewhat on the consciousness of the man thus working, would be conscious that something is required of them. They would feel that they should carry all the oxygen possible from the lungs to the tissues, as they journey about, and should carry as much carbon dioxide from the tissues to the lungs as possible. They would not know just what it is all about, in the larger scale of being, but they would be convinced of the nature of the work required of them to help it along.

Man on earth cannot be expected to know all about the ultimate purpose of the cosmos. But, through observation, the exercise of intelligence, and through tuning in on the consciousness of superior beings, he can get a very clear idea of just what is required in his own little corner of the universe, and how best he can aid in bringing to pass what is there required. After all, if he can clearly discern the direction in which action should be taken to aid the Plan of the Supreme Mind he has taken a decided step in the unfoldment of his own possibilities; for such intelligences as cooperate with the Divine Plan are cherished by still higher intelligences, and helped by them, because of their willingness and usefulness.

There are higher intelligences, existing on the inner planes, whose work it is to direct certain types of activities. Often times these are banded together as an organization on the inner plane that, because it performs a definite function in the scheme of things, may be compared to an organ in the human body. That is, there are intelligences of a degree vastly superior to man on earth, who band together, under a still higher head, to perform needed work on the inner planes. Some of these groups

are composed of those who once lived on earth but who have developed far beyond what can be attained on the physical plane. They are cosmic workmen of a definite order, cooperating to bring some needful thing about. For the cosmos does not just advance without effort. Its eternal progress depends upon the initiative and effort of the various individuals and groups who comprise it.

While we cannot know the details of how certain work on higher planes is performed, and while the ultimates of cosmic progression are too vast for our puny comprehension yet, if we will but depart from orthodox notions sufficiently to try to learn for ourselves something of universal law and purpose, it will not be difficult to discern, at least in a general way, the direction in which the cosmos is moving. And having discerned this, we can join our efforts to those of others, and become cooperative workmen in the Universal Plan.

How Perceptions Are Warped

—This universal plan, as I have taken some pains to make clear, requires the development of specialists to perform given functions. It contemplates the development, also, of initiative in a high degree. It has in view no stopping point, no place where of any individual shall it be said, thus far and no farther. What an individual does, and how far he travels, depend upon his own intelligence and developing ability.

Were it not for the power of the ideas already strongly entrenched in the mind to dominate all information received, and either to suppress them completely or to warp them into conformity with themselves, the best way to discern what God wants would be to tune in on the Universal Mind and try to get the information directly from Headquarters. But unfortunately for the common application of this method each factor already in the mind exercises a force of its own. And the amount of force exerted by an idea is dependent upon the energy contained in it, which in the case of dominant ideas has been supplied by their emotional associations.

Very few people have minds so evenly balanced that no particular ideas have undue enthusiasm that tends somewhat to warp the soundness of the judgment. And other people have some one idea, or some one group of ideas, thus so firmly entrenched through the emotions imparted to them, that they dominate the whole mentality. What happens in the external world is reported correctly, and appraised soundly, so long as it does not run counter to the dominating, or fixed, idea. But no matter how obvious to other people a fact may be, if it runs counter to the fixed idea of such persons the fact is considered to be a falsity.

When the mind is thus dominated by some thought which has the power to warp all happenings out of true proportion to make them conform to it, the person is said to be suffering from paranoia. And if the paranoia is severe enough it becomes necessary to restrain the liberty of such a person. He is called crazy.

But between those who suffer from an obsession, or from paranoia, and those having a finely balanced and adjusted mind, there are all degrees of gradation. Emotional disturbances that thus warp the true appreciation of the individual's relations to society, emotional disturbances that usually transpire in youth, because then the mind is more plastic to such impressions, are thought to be the cause of most juvenile delinquencies. And the most successful method yet devised for correcting juvenile incorrigibility of various kinds is based upon the effort to find the cause of the emotional maladjustment, and divert the energy, which has become too greatly centered about some thought, into other and more constructive channels.

Those who are crazy, and those who are incorrigible are, of course, extreme examples of the condition of which I speak. But the early experiences of most people have brought them into contact with ideas under circumstances that imparted to these energy out of all proportion to their importance. The religious doctrines which have been absorbed at the mother's knee, which later have been reenergized through evangelical meetings and conversion, and which finally have been hammered into the unconscious mind through the suggestion offered by rituals and services each Sunday; such doctrines often are so fed with energy that the evidence of the senses, reason, or any possible external circumstance, could not change them. They are fixations as strong as are those of a paranoiac; although, being based upon ideas not anti-social, they may lead to actions that benefit rather than injure society.

Also we must recognize that there are three classes of special privilege many of whose members, to retain these special privileges, resort to every measure within their power to foster various popular fixations. These embrace: 1. Academic materialists, who wish to maintain the fiction that they are the one infallible source of knowledge. 2. Religious bigots, who wish to maintain the fiction that they alone should have the privilege of interpreting the will of God. 3. Those who exploit others for unjust political or financial advantages.

The leaders of intolerant religious groups realize that to maintain their special privilege their followers must keep convinced that they alone should be permitted to interpret the will of Deity. Their followers look up to them as superior to ordinary human beings. And not only do the leaders of these intolerant religious groups try to suppress the teachings of astrology and extra-sensory perception, which would reveal their pretenses to be without foundation, but they struggle for a political power that will enable them eventually to suppress all religions but their own.

Whenever opportunity offers, these intolerant religious leaders follow the method which resulted in the death of the first Christian martyr. If we are to believe the sixth chapter of Acts, Stephen had helped a great many people, and the priests were jealous of him. But he had broken no law. Therefore, "they suborned men," and "set up false witnesses", and thus through lies they incited the populace to rush upon him and to kill him with stones.

Stephen threatened the special privileges of the priests of his time, and in so doing drew their wrath upon him. But today, in addition to intolerant religious authorities there are equally intolerant academic individuals. These atheistic materialists stand before the world as the final authority. Their special privilege is not that of wealth, but that of prestige. Whatever they say is true must not be disputed. If they say there is no inner plane, no one must produce proof that life survives after physical dissolution on such a plane. If they say the planets cannot influence people, no one must be permitted to present statistical studies proving they actually do influence human life. And these atheistic materialists will stop at nothing to discredit any who produce proof they are wrong. For to show them in error is to destroy their special privilege.

A correct appraisal of God's Great Plan shows that all the people of the world should have Freedom From Want. But the steps necessary to obtain such a desirable condition would deprive some of the means of profiteering, and others of their practice of exploiting backward peoples. Therefore those who thus would be deprived of their special privileges resort to many cunning devices, including the spreading of lies, to prevent people from learning facts which would lead to such economic freedom.

In early days the Christians thus threatened the profits of the traders and priests of the temple; for they worshipped neither image nor shrine. And, horrors upon horrors, if we are to believe Acts 4:34-35, "Neither was there any among them that lacked: for as many as were in possession of lands or houses sold them, and brought the prices of the things that were sold. And laid them down at the apostles' feet: and distribution was made unto every man according as he had need."

As such contempt for current financial practices jeopardized the economic system that yielded to a special privileged class great wealth, something had to be done about these Christians. Laws were passed against them, and they were persecuted.

The methods used by special privilege include the subtle use of suggestion, by which certain doctrines are so made to appeal to the emotions that they build up, even in adult life, such a bulwark of energy that they defy both fact and reason to route them. And some doctrines are even launched in a manner deliberately designed to reach and dominate those who are somewhat negative, or who tune in on the thought-waves of those radiating these thoughts. That is, just as the press is used to influence public opinion, often to gain support for a given political candidate regardless of his lack of worth, and as the radio is openly or subtly often used for the same purpose, so also thought-radio is quite extensively used to force the public to accept certain ideas that are to the advantage of the special privileged few.

Because there are apt to be some of these factors in the mind which have a certain power to warp what is received into conformity with them, it is not wise to place absolute reliance solely upon what is received when the attempt is made to tune in on the purpose of God. Nevertheless, with proper checks used, by which the accuracy of what is received can be tested, such tuning in is a valuable daily practice. If it is remembered that in the effort to tune in on the station radiating God's Plan that some other station may be tapped instead, much of value may be gained in this way.

It would be rather difficult, I presume, for an industrial magnate of the old school to bring anything through which would indicate that his wealth was held in trust for the use of all the people. Yet from our studies of the function of life-forms, and of the nature and attributes of the soul, it must be apparent to anyone that the cosmos is not being run for the benefit of just a limited few, but to give opportunity for the expression and development of all.

In this day and age of the world, when socialistic ideas have considerable popularity, it is not so difficult to cause the common man to believe that the world is not the property of a favored class, but that the development of God's Plan is in the direction of providing prosperity and the opportunity to develop his intellectual faculties and his spiritual attributes, by every man, woman and child in the world. Of course, to some such common men it is hard for them to realize that an Australian Bushman has a soul, and has need of the opportunity to develop his abilities and his spirituality. It is hard for such men to realize that a Bushman is not quite different in his essential nature; but at least, as an abstract theory, they offer no great antagonism to the conception.

The Rights of Less Developed Souls

—But when the thought is presented that every life-form on earth, and every life-form in the cosmos, both great and small, has certain inalienable rights, there is apt to be a mental rejection. What right has a wild animal, say, even a ferocious beast of prey? Well, what right has man, who as a killer has no rival in the brute world. The tiger has not the same privileges as man, because man has advanced further, and consequently is more useful to society. But neither has man the same privileges as an angel; for the angel is of more use in the universal organism than the man. The foreman of a department is of greater importance, and has certain privileges that those working under him have not, because he is more essential to the success of the organization.

Yet even the tiger is a developing soul, gaining experiences which, in time, will lead it to a position where it will do constructive work in the great scheme of things. The tiger, the mosquito, the invisible elemental that answers the impulse of our thought, these all are life-forms occupied by evolving souls. But what their privileges are, in reference to other life-forms, must be determined by considering various factors.

Nevertheless, all the souls occupying the innumerable forms in the cosmos, have some right to consideration. What this consideration is must be determined by the circumstances. It may even be, as in the case of the anopheles mosquito, that it is for cosmic advancement that this life-form be eradicated from the earth, that man may not have malaria. Yet in the wider sense, in which the welfare of the whole organization is considered the one thing of paramount importance, the true prosperity of every soul in the universe is a matter which should be of concern to everyone. An organization depends upon the ability, health and prosperity of the various individuals composing it; and to the extent the true welfare of any individual in the organization can be advanced, to that extent the whole organization is benefited. To the extent any soul in the cosmos is benefited, to that extent God's Great Plan is forwarded.

How the Cosmos is Managed

—I believe the clearest and most accurate conception of the cosmos that can be had is to consider it analogous to a huge corporation which not merely manufactures many products, but also handles them all the way from producing the raw material until they are used by the ultimate consumer. It is thus an organization which embraces all the functions.

Every single life-form in the universe is doing something in this complex organization. Some may not be doing anything constructive; because in a corporation of this size and complexity there are sure to be some loafers on the pay-roll, and also sure to be some individuals who are malicious, and who do not wish the concern to succeed. Yet whether doing something constructive, or something destructive, whether doing something important, or merely some routine necessity, every intelligence that has an existence is doing something in this huge corporation.

Now I am sure that the General Manager of the corporation, being a wise manager, does not wish harm to come to any of His employees. He needs every one of them, and He needs them constructively employed, and not destructively occupied. Yet novices in any firm usually make mistakes. Sometimes these mistakes are costly, but they cannot be avoided. They are just charged up to the cost of educating new employees.

It may be that the new employee needs a severe lesson, and that he must pay for his mistakes. But we cannot imagine so just an employer becoming angry and taking vengeance upon the unfortunate who through clumsy effort breaks some machine. In order to educate this particular employee he may be required to pay for the machine, or otherwise make amends; but all such is merely as an aid to the education of the employee, and not in the spirit of punishing him.

No Soul is Lost

—While there are teachings to the contrary, and some of them quite venerable with age, that souls who do certain things—especially those who practice black magic—are on that account really lost souls, I cannot concur in this opinion. I do not believe there is an unpardonable sin. I do not believe that a soul is ever so far lost, even in the lowest hells of the astral world, that the possibility of redemption is gone.

It is true that anything which can be built up can be torn down. And as the soul is something which has been built through experiences I have no doubt that a soul can be destroyed. Nor do I doubt that when the tides of astral life flow on, the soul which is unable to raise its vibration to a rate where it can function on the still higher-velocity spiritual plane is in a bad way. Survival, anywhere, anytime, depends upon the ability to adapt the form to the environment. And one who has never built a spiritual body, and has only an astral form, could scarcely be expected to survive after the astral forces had dissipated, and there was no longer an astral realm which was accessible to him in which to function.

Yet, as I perceive it, who have made some exploration in astral realms, the matter is not so different from the old orthodox conception of the ruined girl. Not so many years ago any girl who was known to have taken a single misstep was considered irrevocably lost to decent society. And it is true that so-called decent society shut its doors on such an unfortunate girl, and made it almost impossible for her ever to marry, ever to live any life except a life of prostitution. In those days, and even now in some localities, the mother of a child out of wedlock was not only considered forever lost, but every avenue toward regaining her self-esteem was closed upon her by an indignant society.

And it is true that, in those days at least, a girl who had taken a misstep, and it had been found out, was usually forced into a life of shame. It was the usual thing that she died in not many years from the life of prostitution into which she was forced. It is true, in this sense, that often such a girl was lost to the redeeming influence of a self-righteous society. Yet, even in those days, and even among such people, an occasional woman was found who did manage to live an upright life after taking such a false step and being found out.

As a matter of fact, when a man has become hardened as a criminal, has been a drunkard for years, or a woman has steeped herself in wanton dissipation, it is usually a heartrending task for such to win his way back to a more constructive type of life. Yet while it is difficult, who can say that it is impossible? On the physical plane, who can say with certainty that an individual has sunk so low that he cannot possibly regain control of himself and live a respectable life?

I believe on the physical plane the statement that a certain individual is lost to decent society is an unwarranted assertion. We are more and more learning the emotional reactions of such individuals, and how to set up emotions that will redeem them to normal and constructive lives. An individual who may be lost today may, because he contacts someone who has learned more about such problems, tomorrow become one who can be redeemed to normal avenues of endeavor.

And I believe the same principle holds true on the inner plane. Those who, through magic, entwine their lives with vicious elementals, sink very low in the after life. They exist in surroundings created by themselves, and have a terrible form of existence. And, in time, unless they do make an effort, and extricate themselves from their situation, I must admit that the soul itself is dissolved. But who shall say that such a soul, before dissolution, is beyond redemption?

Observing the creatures of the slums of earth it is easy to believe that they are lost to all that is good. But the facts remain that many fine and useful citizens have been resurrected from the denizens of such places. Who can, and who cannot, be brought to constructive citizenship depends upon the skill and knowledge of those doing missionary work in such regions. There is more knowledge and skill today, and more rescues.

Likewise, of those who sink to the astral hells, after living fiendishly on earth. They do not go there because of the desire of any being to punish them, but because they have built the conditions into their own souls. The soul, after death, gravitates to the basic vibratory level corresponding to its own dominant rate, and to the environment on that basic level corresponding to the vibratory combinations within itself. The soul goes to the place where its vibratory affinity attracts it; and if it undergoes pain, that pain serves the function of an educator. If there were no pain in the horrible situation where it finds itself, there would be no incentive to leave the place.

Whether or not a soul can ever be delivered from the depths to which evil magicians sometimes sink is not something to generalize about. With increasing knowledge on the part of the missionaries who visit these astral hells, new and better methods are being devised to stimulate these denizens to make the necessary effort by which they can escape to higher levels of existence, and gradually ascend the ladder of progress, down which, on earth, they slid.

Just as I do not believe there is a person on earth who has sunk so low that it can be said that he is irrevocably lost to decent endeavor, so also I believe that no soul in the after-life ever sinks so far that there is no hope left of his redemption. Probably souls are destroyed, just as we know that people on earth drink of life's dregs and destroy themselves. But while there is life on earth there is still hope. And while the soul still exists on the astral plane I believe also there is still hope of its redemption. In other words, I do not believe there is such a thing, in spite of much occult doctrine to the contrary, as a lost soul.

The Cosmic Plan

—The General Manager of a corporation, I am sure, would not be pleased to observe many of his workmen in sorrow and distress. If they could be educated only through experiences that brought these things, such suffering would not be done away with. But I am sure that the head of a huge corporation, such as we have been considering, would greatly prefer that his employees should get their education through the technique of joy and happiness rather than through the avenues of sorrow. And I am sure that the General Manager of the Universe does not want man to suffer grief and sorrow.

I am quite sure also that the intelligent manager of a corporation, starting an employee in running errands, and then advancing him, due to increasing ability, to a point where he was doing some more highly specialized work, would not then remove him from the higher type of work and start him running errands again, and repeat this over and over again. And I am equally confident that God does not cause a human soul to be born as an infant, learn to walk and talk, pass through the kindergarten and grade schools, out into business for himself, where ability of some consequence is acquired; and then when the business man dies, start him in as an infant, to go through the kindergarten, grade school, etc. all over again. God has need of ability among His employees, and when that ability has been developed, the individual possessing it is placed in a capacity where it will accomplish something.

Nor does God, as General Manager of cosmic affairs, seek blind obedience from those working under His directions. No workman is of the highest type who must be told everything that should be done, and who can do nothing without asking if it should be done, and how to do it. Any really good plant expects the more intelligent of its employees to do a lot of thinking on their own. A big corporation always needs men who can work out new and better ways of doing things. There must be, of course, the fullest cooperation with others, and all endeavors should be directed toward the ultimate advancement of the corporation. But ideas and initiative are the most valuable assets an organization can have; and I am sure that the General Manager of the cosmos does not wish to discourage independent thought and action.

Those who work in an organization can never know too much about the organization, about the personnel, about the plans and method of operation. And I am sure that God has no desire to discourage His employees in making the effort to learn all they can about the universe, about other life-forms, and about everything they can. The more accurate information His workmen possess, the better fitted they become to cooperate in bringing about the aims of the organization.

But in this cosmic organization, the workmen operate from different floors, or vibratory levels. The work on one plane, or level, compares with that performed on a lower floor, or level, but each higher station requires greater skill in workmanship, and the performance of more complex work. The work is thus of a finer, more intricate, nature.

And because God needs employees who are skilled in the quality of work they can perform, as well as workmen on lower planes, I am sure He does nothing to discourage the refinement of the thoughts, emotions, and actions of His employees, as through such refinement they are able to move to higher planes, or levels of production. Such refinement is spoken of as spirituality.

If, in the industrial corporation we have been considering, the general manager and his superintendents were known to exercise partiality and unjust favoritism, how do you think it would affect the morale of the various employees? And you may be sure, superficial appearances to the contrary, that God exercises no such favoritism.

Instead of such favoritism, the Cosmic Organization is run under the universal law of compensation. Under this law, every individual receives reward in proportion to the effort he makes. The reward is made in terms of increased ability, but implies also that, to the extent such increased abilities are used for the advancement of the whole organization, the individual is promoted to positions of increasing importance. To use whatever of energies and abilities one has for the advancement of the cosmic concern is always amply rewarded by the progress of the soul to new points of vantage. Real ability and effort are never overlooked in the cosmic organization.

Nor, in this cosmic industrial corporation, are there different codes of conduct laid down for various employees. The lowest in the line of production and ability cannot live up to the moral code, as can those of wider experience; but a single code of conduct, nevertheless, is a rule for all. This universal code, to which every life-form in the cosmos must subscribe is that **A SOUL IS COMPLETELY MORAL WHEN IT IS CONTRIBUTING ITS UTMOST TO COSMIC WELFARE.**

To the extent that you and I do not live up to this principle, we are violating the universal moral code, which is the one and, I believe, only important consideration by which God as General Manager of this vast going concern, passes judgment upon His various workmen.

This organization is so vast that there are types of workmen of which we have never heard, and there are departments so far removed, from where we labor that we are quite out of touch with them. With the intelligence we now possess, about all we can hope to do is to understand about our own department, the earth, and the realms immediately above it where we will perform more intricate work when we have gained enough refinement; that is, have gained enough spirituality that we are capable of working there.

But let us not forget that this cosmos is not just a mechanical contraption, not just an inanimate machine. Instead, it is an organization of intelligences, and the exercise of intelligence is the most important thing about it. For the performance of the best type of work it becomes necessary that the various intelligences cooperate, that they unify their aims and do not work in antagonism to each other. We hope that the time will

come when the people of the earth will no longer make war upon each other, and instead will cooperate to the end of providing the necessities and luxuries for all. Want need not stalk the earth if people would only thus cooperate. The earth can easily be made to produce amply for all. But at present we have not arrived at that stage of cooperation.

In this cosmic organization the same principle holds. To produce the highest type of condition it becomes necessary that the various intelligences within each department cooperate with each other, and that the various departments cooperate. As yet we have so little information about some of the distant departments that we hardly know how to start cooperating with them. And some of the life-forms right at hand are as yet mysterious to us. We do not yet know how to treat them for best results.

But in any large corporation just such difficulties arise, and year by year, studies are made how individuals and departments can better cooperate. And we, who are so far down the ladder of existence, yet at that are so far above others, we know so little. We can do this, however: We can study other life-forms, we can study our fellow-man, we can investigate other levels of existence, such as those of the astral and spiritual realms, and we can even work to gain some knowledge of departments far off in space and far off in their velocities.

Then, to the best of our knowledge, which we increase as we can, we can exert ourselves along the line of the universal moral code; which is to do that at all times which we believe will contribute most to the furtherance of God's Great Plan. And recognizing the universal law that all souls in the universe are in process of progression, we can feel sure that such effort, due to the universal law of compensation, will lead us, step by step, to the highest and best destiny which it is in the power of man to imagine he could attain.

Book 20

Copyright
Church of Light
August 2002

The Next Life

Chapter 1

Serial No. 173
Original Copyright 1942
Elbert Benjamine

Copyright
Church of Light
August 2002

Turning the Dial to Inner Planes

Chapter 1

Turning the Dial to Inner Planes

IF the span of physical existence were the sum total of an individual's life, he would be warranted in making all his adjustments in living on the basis that death is the end. But with an overwhelming, and constantly accumulating amount of positive proof at hand that there is a continuation of life and conscious personality after the dissolution of the physical, his adjustments in living should all be made, not on the foundation of this one experience in the chain of his existence, but with reference to the requirements of the whole scope of his living.

If the squirrels lived ever so successfully throughout the summer months, made the fruitful period of the year a time of joy, and yet neglected every preparation for approaching winter, they would excite our admiration far less than they do. We know, in spite of warmer days, that winter with its dearth of food will overtake them; and we know, quite as certainly, that the winter of physical dissolution will overtake every human being.

Squirrels of the year have had no experience with winter, yet they have an instinctive apprehension of its approach, and how to prepare to survive it. And humanity the world over, both past and present—as witnessed by the universal belief in a life after death—has an instinctive knowledge that man survives the tomb. The same type of intelligence displayed by young birds, when unerringly they set out ahead of the older ones on long migratory flights, also informs man that there is a future life. These birds have never traveled the route before, nor are leaders with them who have. But something within assures them that there is a fairer region across the trackless stretches to the south, and obeying this impulse they set out and reach that welcome land.

The squirrels store up food; the birds migrate to more hospitable climes. Some animals grow a luxurious coat of fur long before the weather becomes really cold. Still others provide their bodies with excess fat and go to sleep, that they may use but a minimum of fuel, until returning spring makes available other forms of food. Such creatures have not been educated by materialistic philosophy to neglect their futures. The use of reason, working with incomplete or prejudiced data, has not convinced them of the folly of preparing for something that the materialist deems is but wishful thinking to survive. A certain condition is ahead. Winter will come to these creatures, and so-called death will come to man. This we know. Many animals and countless

plants make adequate preparation to survive approaching cold. And the man who is so short sighted that he makes no preparations to adjust himself to other than the physical plane is just about on the level of intelligence of some houseflies who, because it is pleasant out of doors when they are born, fail to seek the warmth and shelter of an artificially heated room before the arrival of frost. For man is now no longer dependent upon instinct for a knowledge of the existence of a future life. Day by day proof accumulates as the result of the painstaking work of some of the world's greatest scientists. But it is no part of the present discussion to present that proof, some of which is set forth in Course 1, Laws of Occultism. Instead, the present work is devoted to describing the various conditions and circumstances of that life to come.

Sources Of Information

—Abundant and convincing proof can be offered that there is a realm in which the human soul survives after the passing of the physical body. And there is ample proof at hand that souls, when they pass to this region, maintain their familiar characteristics and identities. But, up to the present time, all our information concerning the environments in that land and the activities of the souls there residing, comes to most people as hearsay evidence, and consequently by them may not be considered incontrovertible proof.

Tests have been devised by which it is possible for a discarnate soul to reveal his identity with certainty. But up to the present no tests have been devised by which it can be proven that there are gardens and lakes in that after land; or that a beloved friend who has passed to that region continues to occupy his time by attending schools devoted to science and philosophy. Our knowledge that there is a life beyond so-called death, and that the personality survives, is positive. But the conditions and circumstances of that life to come must reach mankind through those who have developed, or naturally possess, one of the three forms of what science now calls extra-sensory perception.

Extension of consciousness on the astral plane may occur to any extent represented by a complete gradation from ordinary reasoning by objective consciousness to the awareness and thinking on the astral plane by entities no longer having physical bodies. In what is called the Third and Second State of astral travel the electromagnetic energy has been very largely withdrawn from the physical body and converted into energies with a velocity greater than that of light, and used to sustain the very completely withdrawn astral body in its journeys on the inner plane. In that state but a single elastic astral thread connects the individual with his physical body.

This is one form of Intellectual ESP. And those using it are able to visit, in person, the realms where those who have passed from the physical world now abide. They are able to talk with departed loved ones, are able to view the surroundings where these live, and to observe something, in their brief visits, of the laws and types of life that are there to be found.

To those able to do this, such experiences are convincing first hand evidence. But to the world at large they are only credible to the extent faith is placed in the genuineness of the experiences and the veracity of their narrator. And even when both are beyond suspicion, there must always be taken into account the bias of the objective mind, which ever tends to warp what passes through it into conformity with its preconceptions.

Then there are those far more numerous individuals who naturally, or by cultivating it, have the senses of their souls so active that they are able, without leaving the physical body, to see, smell, hear, taste and feel the things of the inner world. Some of these, who have had proper training, use Intellectual ESP to extend their consciousness. Instead of becoming a receiving set, the electrical energies of the nervous system radiate high-frequency vibrations which afford the senses and faculties of the unconscious mind the energies with which to perform this work. Feeling or hypersensitivity plays no more part in such examination of inner-plane conditions by the soul than it does in a similar examination on the physical plane, nor are the emotions more active.

Others who use ESP (extra-sensory perception) employ the Feeling type. They make use of the hypersensitivity of their nerves to tune in on the astral counterpart of the inner-plane person or environment to be examined. The nervous system, or some part of it, becomes a receiving set through which the electrical energies and astral energies closely associated with it pick up, radio fashion, the astral vibrations radiated by whatever is tuned in on. The individual then feels the condition of that which he has thus contacted.

Those who are thus able to use their Intellectual ESP or Feeling ESP to gain first hand evidence of inner-plane conditions find the evidence most convincing. But to the world at large such experiences are only credible to the extent faith is placed in the genuineness of the experiences and the veracity of their narrator. And even when both are beyond suspicion, in these experiences also there must always be taken into account the bias of the objective mind, which ever tends to warp what passes through it into conformity with its preconceptions.

The objective mind of the seer has a tendency to shut out the astral picture of what the soul perceives if that picture is contrary to its fixed opinions. And in bringing this picture through it may substitute in its stead something that to it is more acceptable. That is, even in clairvoyance, to some extent, the same process is at work which causes the puritanical individual in his dreams and reveries to substitute visions of a very different character for those which more adequately picture the fulfillment of his fundamental desires. Such a dreamer believes, until the psychoanalyst uncovers

the real cause of some illness through analyzing these images, that he has no such thoughts or desires. But it is only that the very firmly entrenched idea in his objective mind will not permit something contrary to it to come through. To get through at all it must assume a dress acceptable to the objective opinions. And thus also in the use of extra-sensory perception. The faculties of the soul may perceive accurately, and the soul may make a correct report: but if some religious or other notion is strongly entrenched in the objective mind, this report of the soul senses is not permitted to come through until it is dressed in a manner pleasing to this religious conviction or other notion.

Finally, there are descriptions of the next life and its environment that come through spirit mediums from those actually occupying that land. Those who have passed through the tomb and live in that world should know something about it. We must not expect, however, that as soon as they get there they shall know all about the region. If a man dropped in on us from Mars, any immediate description he might make of the earth would be quite inadequate. If he landed in a city he might describe the vehicles and the buildings. If he alighted in a forest his description would be quite different. And no matter where he sojourned, it would take him considerable time and effort to learn enough about the very complex relations that exist in this world to make any coherent report to his fellows still residing on the planet Mars. Also the objective mind, and the influence of the sitters, have the tendency already described in relation to the use either of Intellectual ESP or Feeling ESP, to exercise a censorship over such messages as are permitted to come through.

When we consider this tendency of the objective mind to suppress and distort such information arising from the unconscious mind as does violence to stalwart objective opinions, we cannot but be amazed that the reports of the great seers and mediums are so consistent with each other. Swedenborg, considering the period in which he lived, and the powerful bias of his objective mind toward Christianity, was one of these great seers. Andrew Jackson Davis, sometimes called the founder of modern spiritualism, was another. One who relied upon mediumship to get reports and descriptions, whose works appeared immediately following World War I, and should be classed as great, is Rev. G. Vale Owen. And now, with World War II under way, another series entitled to be called great, the Betty Books, is being issued by Stewart Edward White.

But these descriptions of the next life, by whomsoever given, are merely the narration of what someone in that realm, or in this one, has observed. They are not what the physicists demand as proof. Proof, such as laboratory experimenters demand as to the detailed correctness of these descriptions, is not yet at hand.

Yet the urgencies of the present demand a science of the after life. We know there is an after life, and we desire to live out adequately our present phase of existence in such a manner that we shall be able to meet the demands of that future condition. If certain mental qualifications developed here will aid us more quickly to enter into a condition of joy and greater usefulness over there, we wish to know about it. If certain traits of character common to this life shall act as inhibiting agents presently

in that newer land, we want to know about it now, so that we can take time by the forelock and substitute other and more beneficial traits and get them well established before the change is at hand. We want to know the details and requirements of the present life, and we want to know the details and the requirements of the future life, so that our daily effort may be directed toward a success that shall embrace something wider than this short earthly span.

And while the proof of all the details that the atheistic materialists demand is not yet at hand, I believe there is a body of personal experience now available that is of sufficient authenticity that it may be considered in its broader essentials quite reliable. That is, the reports of those who have traveled, while out of the physical, body, in the homes of the so-called dead; the reports of a multitude of accomplished seers; and the communications from departed ones through the purest type of spirit mediums; all agree so well in the fundamentals of their descriptions, that we are fully warranted in accepting them as a basis for life's endeavor.

In this course, therefore, I shall try to give a picture of the next life, making it as precise and accurate as I can. And I shall endeavor to indicate the qualifications and attributes which when developed enable an individual to function joyfully and abundantly on the next plane.

In this account I shall draw very widely on my own personal experience; but reinforced by the similar experiences of many others who are qualified to speak with authority in such matters. But because such experiences of others also constitute personal, or hear-say evidence, no point is to be gained by citing the various persons whose reports substantiate experiences of my own. Rather than citing specific experiences, what I am attempting is to give a precise account of the next life according to the Hermetic Teachings and the experiences of the Brethren of Light.

Yet in setting forth this account I am well aware that the time will ultimately arrive when all I have said will be subjected to laboratory tests to determine its truth. For while just at present such mechanical tests have not been contrived, not only are they possible, but somewhat later, I am convinced, they will be at hand.

I have seen the contrivances on the inner plane by which the velocities of the inner plane can be stepped down to transmit their vibratory rates to the slower velocity electromagnetic waves. Already, in radio, we possess instruments that step down electromagnetic waves with a velocity approximately that of light, so that they communicate their vibratory rates to that slow velocity physical substance we call air, and thus enable us to hear sounds made thousands of miles distant.

In other words, just as radio waves of high velocity are made to communicate the programs they carry by means of a receiving set to the slow velocity air, so will the time come when the much higher velocity inner-plane vibrations will be made to communicate the programs they carry by means of a receiving set to the much slower velocity electromagnetic waves used in radio reception. Thus received they will be projected on a television screen, and still further stepped down by a radio receiving set to affect the much slower velocity air, so that what is happening on the inner plane not only can be seen, but heard.

This apparatus utilizes the same principle to cause inner-plane vibratory rates to modulate the electromagnetic waves of radio, as radio waves now employ to vibrate the air in a loud speaker. The principle of the radio set is merely carried forward one more step. But until someone has sufficient ingenuity and interest in this problem actually to build such a super receiving set, all our information concerning the details of life after death, and of existence on the inner plane, must come to us through that group of faculties which scientists now embrace in the term extra-sensory perception, usually abbreviated merely ESP.

As these phases of the matter have been given thorough discussion elsewhere, it would be redundant to give instructions in this course on cultivating extrasensory perception. It should be pointed out, however, that there are three quite distinct methods of acquiring information from the inner plane. All three employ electromagnetic Boundary-Line energy to make the contact and bring the information through. All three at times give results which are quite reliable. But the dangers to the individual in using each are markedly different.

In mediumship, in which there is partial or complete control of the medium by some inner-plane entity, the dangers to the medium are so great that The Church of Light does not advise anyone to become a medium. The reasons for this attitude are given in Course 1, Laws of Occultism.

In Feeling ESP, in which hypersensitivity of the nervous system is cultivated to the end of picking up with the electrical energies flowing over it the vibratory rates radiated by people and things on the inner plane, or radiated by the astral vibrations of those yet occupying the physical plane, difficulty may arise from inability not to pick up vibrations and messages that are disagreeable. The Church of Light, for reasons more fully set forth in the Award MS., believes this method of psychic development should be approached with caution.

In Intellectual ESP, in which, instead of becoming a hypersensitive receiving set, the energies of the nervous system radiate high-frequency vibrations which afford the faculties of the soul the energies with which to perform their work, there is no danger. Such examination of inner-plane conditions, or such conversation with those of the inner plane, when handled through extension of consciousness—the technique of which is explained in full detail in the Award MS.—is no more dangerous than a similar examination of outer-plane conditions, or conversation with those of the

outer plane, by means of the eyes, ears and mouth. The Church of Light believes that the cultivation of Intellectual ESP is highly desirable, not only so that through it valuable information concerning the practical affairs of physical life may be obtained, but so that the individual may also gain first hand knowledge of the all-pervading presence of Deity, and of life beyond the tomb.

Inner-Plane Properties Are Consistent With Relativity

—Einstein's General Theory of Relativity, which he broadened into his Unified Field Theory, in which there is a single mathematical equation of eight characters for light, gravitation and electromagnetism has not worked out due to the Principle of Indeterminacy where the Quantum of Action of particles is involved. This, in turn, is due to the energies of these particles being too close to the borderline where they partake of astral properties. But Einstein's Special Theory of Relativity has now become almost universally accepted by physicists the world over and has become the foundation of the physics as taught at present in our universities.

To quote from an article by H. P. Robertson, Ph.D., Professor of Mathematical Physics, Princeton University, which appeared in the June, 1939, issue of Scientific American Magazine:

In view of these developments one may say that at present the special theory of relativity is one of the most thoroughly accepted and most firmly established doctrines of modern physics. It has permeated the field of mechanics, electromagnetism (including optics) and atomic physics; while it may appear desirable to have further direct checks on the validity of its mechanical aspects, a deviation from the predicted effects would constitute a most puzzling—and, at least temporarily distressing—jolt for modern physics.

The most essential conception of this special theory of relativity, which is now so widely employed to explain the behavior of high-velocity particles, is the interrelationship between velocity and time. It is held that there is no such thing as absolute time, but that as velocity increases, time slows down, until, at the velocity of light time comes to a standstill. Nor is this just a theory, as the experiments of Dr. Herbert E. Ives demonstrate. He reported that observing the Doppler shift in an incoming hydrogen beam, and at the same time the shift due to recession of the same beam, shows that, as relativity predicts, a moving clock keeps slower time than one standing still.

Now in the outer plane time is rapid and velocities are comparatively slow. But man's soul, or unconscious mind, at all times habitually lives in a realm where velocities are greater than the 186,284 miles (1942) per second which light, radiation and electromagnetic waves travel when unimpeded. This is the realm where the soul continues to dwell after the dissolution of the physical body. It is not a physical realm, because Einstein and the mathematicians hold that anything moving with the velocity of light no longer possesses length, has infinite mass and so is impervious to the pull of gravitation, and that for it time has come to a standstill.

The great difficulty in explaining and describing life after physical death lies in the fact that, due to the velocities of that region, there is a different order of distance, there is a different order of time, and there is a different order of gravitation. That is, ordinary time, ordinary distance, and ordinary gravitation do not there exist, but properties with which we on earth are not familiar take their place; which, to us on the physical plane makes the next life seem full of contradictions.

But these contradictions are no more perplexing to the layman than those of the Boundary-Line forces within the electromagnetic spectrum are to the physicist. How, for instance, can something be a particle and at the same time be a wave? To quote from the summary on the last page of *The Evolution of Physics* (1938) by Albert Einstein and Leopold Infeld: "Is light a wave or a shower of photons? Is a beam of electrons a shower of elementary particles or a wave? These fundamental questions are forced upon physics by experiment."

The significance of these questions as yet unanswered by science lies in the fact that light usually has been considered non-material; and the electrons, as a portion of each atom of matter, have usually been considered material. Yet with velocities high enough to approach those of the inner world they exhibit properties akin to both realms. They then are on the border-line between two worlds, and thus their behavior is paradoxical.

There Are Innumerable Levels Of The Inner-Plane World

—On the outer plane where velocities are slow the levels inhabited by life are few. The surface of the earth affords one level birds and men and insects which travel through the air are in another level and fishes and submarines below the surface of the sea occupy a third. But when even Boundary-Line velocities are reached the levels of activity, even if not actually occupied by life, vastly increase. Thus with your radio you can tune in on a large number of broadcasting stations, each operating on its own carrier wave. These stations do not so much differ one from another in the type of program it is possible for them to broadcast but they differ in the vibratory rate of the carrier wave that carries their program.

Now the inner-plane world has similar vibratory levels, a great many of them, on each of which life exists. And each level is characterized by its own basic vibratory rate, even as each radio station operates on its own carrier wave rate. Up and down on the physical earth are directions away from or toward the gravitational center of the earth. But up and down in a realm where gravitation no longer obtains is different. Even in radio waves, up is toward high-frequency, and down is toward low frequency, and not toward or away from the broadcasting station or the earth.

Everything has a dominant vibratory rate, that is, one rate which is more powerful than the others. And on the inner plane the principle of resonance—the principle that causes a piano string to vibrate when its tone is sounded by an instrument in some other part of the room—supersedes the law of gravitation. Instead of the attraction of gravitation there is the affinity of anything's dominant vibratory rate for the level of inner-plane existence whose basic vibratory rate is similar. Up, on the inner plane, is increasing the dominant vibratory rate and thus moving above the basic rate of a certain level, and down is decreasing the dominant vibratory rate and moving below the basic rate of that level. But whether the thing or individual is above or below the basic vibratory rate of the inner-plane level having its own dominant rate, it is pulled toward that level much as gravitation operates on earth. The apparent contradiction is that it is pulled up as readily as it is pulled down; although in fact people on opposite sides of the earth are pulled toward the same point physically by gravitation.

Now consciousness can be extended temporarily to a level not occupied by the individual, even as an individual can see distant mountain tops or distant ships at sea without actually going to the mountains or on the ocean. Such extensions of consciousness are exercises of the soul senses in what science now calls ESP. But whether merely the soul senses are involved, or the individual develops the dominant vibratory rate that enables him actually to occupy a certain inner-plane level, he utilizes the same general principle you use when you turn the dial of your radio to some station whose program you wish to hear.

Commonly the attention of the soul, or unconscious mind, is so completely chained to the affairs of the physical life that it has formed the habit of paying no attention to the conditions and happenings of the inner plane. In sleep, which is no-man's-land between consciousness of the external world and consciousness of the inner world, there often is some recognition of the reports of the soul senses. This recognition comes in the form of dreams; but most dreams are badly distorted by partial consciousness of the external world, by the thoughts which previous to sleep filled the mind, and by the desires. But from this no-man's-land of sleep, or near sleep, the consciousness can either move out to become fully aware of the outer-plane world, or in to become fully aware of the inner-plane world.

The dial of consciousness is turned either to the ordinary frequencies of everyday outer-plane life, or it is rotated to tune in on some level of the inner plane. What level depends upon the vibratory rate of consciousness at the time. But one does not need to hold the consciousness to the basic level first tuned in on, no more than one must listen to the program contacted when the radio is first turned on. If the frequencies first tuned in on happen to be those of the lower astral region, corresponding to our slums, or worse, the program received may be annoying or even terrifying. But if the dial of consciousness is rotated to a high-frequency program, the program will be both helpful and enjoyable.

It is true that some people do lose the power to turn the dial and determine what inner station-basic vibratory level-they will get. They delegate this function entirely to invisible entities. They are then merely instruments of transmission without choice as to the programs they transmit. Such are irresponsible mediums.

Sometimes, too, people get into trouble by rotating the dial of their consciousness habitually to frequencies other than those of the physical plane without at the same time taking pains to cultivate the ability to rotate it back when they so desire. This is the one danger in developing Feeling ESP. The dial may then get over a frequency that brings in an astral program that is objectionable, and the victim is unable to shut the harassing intrusion off.

If the ordinary radio of the physical plane were to be tuned in on frequencies over which were broadcast threats, vulgarities, and an ingenious collection of things picked for their ability to annoy; and one were compelled to listen to this without surcease, or even intermittently except when one were asleep, it would drive almost anyone to distraction. And occasionally we find an individual who in cultivating Feeling ESP does just this in regard to the astral world. But if through the advice of others he strives for directed thinking and the development of a high electrical potential, and resolutely turns his attention to physical things, he escapes the psychopathic ward. Otherwise he is in serious trouble.

As this is not the place to give instructions about such matters, let us consider that if we turn the dial of a radio receiving set to a particular carrier frequency we receive with distinctness whatever is being broadcast over that particular wave-length, and with diminishing clearness that which is being sent over wave-lengths of quite different frequency. When we turn the dial to a certain frequency we get what is coming over that and closely allied wave-lengths, and when we turn the dial elsewhere we no longer get these impressions. But that does not mean nothing is happening on the frequencies we no longer contact; merely that we no longer are able to perceive what is going on relative to this basic level, or carrier wave vibration.

Now the fact that we can tune in on electromagnetic waves with a radio and pick up a program being broadcast from a certain building in New York does not prove that people are not physically engaged in producing the program we hear. Nor does the fact that we can tune in on the astral counterparts of persons in New York, or on certain levels of the astral world, prove that people do not live on earth in physical bodies or prove that they do not live on the inner plane in astral bodies.

We cannot deny the reality of the physical universe just because it is possible to tune in on some other realm. Nor should we deny the reality of the astral universe because at the moment we are tuned in on some physical station. While we are receiving from KFI we are unconscious of KHJ and KNX; but that does not prove that KHJ and KNX are non-existent. Nor because we receive all our news at present through KHJ does it signify that KFI and KNX have ceased to broadcast. We can only know what these other stations are doing by turning the dial to their frequencies.

Because we are accustomed, through long experience, to observe objects behave in a certain way, it is quite disconcerting to observe them, at the high velocities of the astral world, behave in a manner quite contradicting our past experience. But nothing we witness in the astral world is more disconcerting than the accepted tenet of relativity that: "The velocity of light in empty space always has its standard value, independent of the motion of the source or receiver of light." This means that if a light signal is emitted from the center of a moving room, the light beams will reach the forward wall and the rear wall simultaneously for an observer on the inside of the room; but to an observer on the outside the beams will reach the escaping wall a little later than the approaching wall. That is, due to time-velocity relations, two observers moving at different velocities would give a contradictory report of the same event.

Even with radio and television it is difficult for us to believe a person can be here and yet a thousand miles away. In our ordinary distance conception he cannot; but distance on the inner plane is not measured in miles but in vibratory difference. How can Arthur Conan Doyle, for instance, be present and give messages from the inner plane in New York and in London at the same identical moment, seen and heard in both places? Your atheistic materialist says it is impossible. Yet about the same date this was reported, George Bernard Shaw was present in thousands of American and thousands of British homes at the same time while giving a radio address. You may say, of course, that his body was in London. Yes, but his personality was felt simultaneously throughout the United States and the British Isles.

When objects attain velocities greater than 186,284 miles per second they lose their physical properties and gain the characteristics of the astral plane. They are not different objects in the sense that they have lost their identities; but they have lost some properties and gained others. Because a man loses weight and gains a new suit of clothes and learns to speak also in a different language he does not also lose his identity. He has lost something, and he has gained something, but he is nevertheless essentially the same man. Thus also when an object or a man loses the physical body, new properties are made available, but the identity remains.

The physical properties with which we are familiar, such as impenetrability, temperature, permanence, weight, etc., are made possible by the low velocities of physical things. Other properties, some of which will be mentioned, are made possible by the higher velocities of the astral world which, unlike the physical world, has an extensive vertical range of life. Not vertical in the sense of three-dimensional space; but vertical in the sense of increasing vibratory rates.

Vegetable and animal life on the earth is limited to a region about five miles above and five miles below the earth's surface. But on the astral plane there are various strata, or spheres, of vibratory frequencies, in which life moves and has a conscious existence. And on all of these basic vibratory levels of the astral world, due to the similarity of velocities, the properties of existence are practically the same.

But when still higher velocities are reached than those of the astral world the astral properties give way to still others, to those of the spiritual world. Entrance into the spiritual velocities brings a loss of many characteristics of astral things, and the acquisition of other properties that endow things with as much additional freedom as was attained by moving from earth velocities to those of the astral region. But whether an entity remains in the velocities that chain it to the physical, moves into velocities that make it an astral entity, or gains those still higher which enable it to have the freedom of the spiritual spheres, even though the properties with which it is endowed are different in each of these three realms, it still retains its essential identity.

Astral Levels

—Because the lowest levels of the astral realm are commonly associated with loathsome creatures and disagreeable experiences it is not uncommon for people to refer to these lower levels as the astral world, and to refer to the levels inhabited by more highly endowed intelligences as the spiritual world. So prevalent is this terminology that it is almost unwise to use the term astral to embrace more than these lower levels of the astral realm. But after all, the so-called spiritual realm of those who use this common terminology, on the levels of which kindly disembodied human souls dwell, really has the properties that are present when velocities are greater than that of light, but not so great as those of the spiritual realm.

Psychics who report experiences on the etheric plane, the emotional plane, the astral plane, the mental plane and the spiritual plane, are correctly describing conditions they have contacted: but are using a terminology descriptive of certain common characteristics of the regions contacted, rather than differentiating between the essential characteristics of the regions. These essential characteristics derive from the velocities of the realms encountered, and are thus consistent with the principles of relativity.

Therefore when I explain about these regions I am not discounting the experiences of psychics who have given them a variety of labels; merely describing them from the point of view of their essential properties and characteristics, rather than from the point of view of their responsiveness to emotion or less emotionally charged mental activity.

About the earth is a dense belt of electromagnetic energy the vibrations of which have been set in motion by the feelings of animals, and the thoughts and feelings of men when they were prompted by animal propensities. The men who have set these vibrations in motion may have a much higher customary dominant vibratory rate, and when they pass to the next life will occupy a much higher level. But men's temporary bursts of anger, their moments of intense greed, their temporary periods of base selfishness, radiate electromagnetic waves of a correspondingly coarse vibratory rate.

And astral entities that permanently live, due to their habitual low dominant vibratory rates, on similar Lower-Pluto levels of the astral world where motives are still those of the beasts, find it easy to use the energies of this dense electromagnetic belt to influence those on earth whose morals are not high and who become negative. Some of the electromagnetic vibrations are much higher than those described. But the whole of this electromagnetic-lower-astral belt, where it is best not to tarry, is so responsive to those electrical discharges of the nervous system called emotion that there is little wonder some call it the emotional plane.

The higher astral levels are not so responsive to the grosser and more violent emotions. Even though action there is dependent on feeling or emotion, the emotion to which there is ready response on these higher astral levels is subtle and refined, and closely associated with directed thinking. While it is impossible to separate thought and feeling completely, the impression is easily gained that action on these levels is a response not to feeling—and certainly not to the violent and coarse feelings which are common in the lower levels—but to thought. And thus it is not surprising or unnatural to find many who have contacted these higher astral levels referring to them as the mental plane.

We have already seen that even in the Boundary-Line region of velocities things behave so differently that physicists cannot reconcile the apparently contradictory behavior. Distance, for instance, while not obliterated by radio waves as it is on the inner plane, is certainly abridged by them. Impenetrability also is attacked by radio programs which enter our houses through their walls. Identical light may be considered either as corpuscles or as waves; yet by ordinary physical standards it cannot at the same time be both. Yet this is only the Boundary-Line region; and when we move our consciousness to the astral plane we find still more amazing phenomena. We find, for instance, we can look down the world-lines of an object or a person and see not only its past but its probable future.

Unless you are actually on the astral plane your mind cannot grasp how certain forces and conditions can there obtain. The best that can be done is through observation to know that things happen there as they do. And if we have so much difficulty grasping the principles and phenomena of the astral world, of what value is it to try to understand those still more amazing of the spiritual world? Therefore in these lessons I shall have very little to say about the spiritual world. One needs to master the astral plane while living there to be ready to make much of a study of the spiritual plane. But in speaking of the astral it should be borne in mind that I use the term to embrace the higher astral levels which it is customary to refer to as the spiritual world.

In this astral world there are seven main spheres or vibratory regions; and each of these is divided into numerous vibratory levels. There is a vertical relation between these levels, one being above the other, not in three-dimensional space, but in vibratory rate. If you can turn the dial of your consciousness to the rates of some level of the astral world, inhibit cerebral thinking except to retain a spark of objective consciousness, and turn your attention to the level thus reached, you can get in touch with what is going on there.

Not only so but if, through withdrawing much of the electromagnetic energy of the body and converting it into the higher-velocity astral energies, you move out of the physical body and adjust the vibratory rates of your astral body to this level, you are at once actually in this realm and taking part in its happenings. You can then move about in this sphere and communicate with its denizens. It is an entire world, and so long as you hold this vibratory rate firmly you have no more consciousness of what is going on in other astral spheres, or on earth, than you now know what is being broadcast from other stations while your radio is dialed to some particular one.

The most important thing to keep clearly in mind in reference to these inner-plane levels of existence is that even as either a station broadcasting on a high-frequency carrier wave or one broadcasting on a low-frequency carrier wave can handle a wide variety of programs, so the diversity of conditions and the variety and number of life-forms on a certain level may far exceed anything known on earth; and that when a life-form tunes in on a certain basic level that life-form then lives and performs all its functions on that frequency level. Its existence in the low-velocity realm of earth is no more and no less real than its existence on any frequency level of the high-velocity inner plane; except that on the higher basic levels there is opportunity for more intense activity and more vivid consciousness. Even in radio high-frequencies permit a range of influence not open to low frequencies. But, after all, a program coming over a low-frequency carrier wave is just as real as one coming over a high-frequency carrier wave.

Moving Across the Planes

—Whatever your dominant vibratory rate may be, you customarily occupy the astral level having approximately this basic rate. Through extension of consciousness you can temporarily contact other levels, and enable entities on the levels thus temporarily contacted to get in touch with you. But if you develop the power, through mood control, not merely to dial your consciousness to another plane, but to adjust your dominant rate to desired frequencies, you can move from one plane to another. And regardless of the material locality of your physical body, the real you, the soul, or unconscious mind, will then be actually living on the astral level to which you have adjusted your dominant vibrations. How much consciousness you would then have of the level you inhabited would depend on the extent of your ESP.

There are certain highly developed discarnate individuals who have acquired the power thus to raise or lower their dominant vibratory rate at will. They are commonly called angels, or exalted spirits. Normally living on a level of high frequency—perhaps, let us say, in the seventh astral state, just on the boundary of the spiritual realm—for purposes of service they lower their dominant vibratory rate through mood control. They dial down from high frequency to low frequency, and as they do so they pass the various levels and enter successively the worlds corresponding to these levels. They are thus seen by those who permanently, or more temporarily, occupy these realms.

As such a one moves through a world with a basic vibratory level he is glimpsed, even as when you turn the radio dial past a certain carrier wave you for an instant pick up the program being broadcast over that frequency. Thus the angel disappears also because he moves out of vibratory range into a different one. And he has the power, through mood control, to stop on anyone of these levels and teach or minister to its inhabitants.

Conscious life is being lived on each and everyone of these numerous levels. On the lower ones the forms and processes are not very dissimilar in detail to those of the life-forms yet on earth. Yet even on these lower strata things have properties they do not possess on the physical plane. Gravitation, as already mentioned, is sup- planted by the pull of the basic level. People walk about, it is true; and their feet move over the ground of a level after the manner, seemingly, that people move in their travels here. Yet without moving their feet, if they think very intently and concentratedly about some environment, they move, as it were by aerial travel, into it.

Building also takes place in the astral world much after the manner it is performed here. Yet those properly trained can group around an area and erect an edifice by strongly visualizing it alone, and without the work of their hands. This responsiveness of materials on the inner plane to thought is as much a common property of astral objects as weight and volume are properties of objects on the physical plane.

And again, on the astral plane, there is eating, drinking, breathing, and the common activities of physical life. Yet as we rise to higher vibratory levels, such gross activities are supplanted by others that perform the same functions but with which in detail we are unfamiliar. And as there is no language available accurately to describe these conditions, we do the best we can by seeking something as nearly parallel as possible in the physical world with which to give at least a glimpse of the principle involved.

Chapter 2

Serial No. 174
Original Copyright 1942
Elbert Benjamine

Copyright
Church of Light
August 2002

Properties of Life on the Inner Plane

Chapter 2

Properties of Life on the Inner-Plane

IN considering the next life it should not be overlooked that we now, while still functioning on the low-velocity physical plane, have also the form in which we shall function immediately after so-called death. It is not that we are lacking an astral form that we know so little about the next interior plane; but because our attention is so persistently directed outward to enable our consciousness to register what is happening in the low-velocity physical universe.

And there are those, not necessarily vicious, but yet uninterested in anything higher than physical gratification of some kind, who have so fixed their attention by an intense and permanent desire for some physical thing or condition, that even after they have lost their physical bodies they can register only impressions associated with the physical plane. They perceive the astral forms of physical things without knowing they are not the actual physical forms. They do not even know they have died. They are called earth-bound souls.

Because our astral bodies, even while we still live on the physical plane, exist on the astral plane, entities, or spirits, as they are more commonly called, residing on the astral plane can see us if they can adjust to the same basic vibratory level. And, because thoughts are readily perceived on the astral plane, such spirits have no difficulty in knowing what we are thinking about. Just as on the physical plane all those within earshot can hear what we say, so on the astral plane all those within our vibratory vicinity, as it were, can feel what we think. Thought communion is as common a property of astral life as vocal communion is common to physical life.

To those who conceive life to be, not an opportunity for progression, but a residence first on the physical plane, where joy or sorrow may come either to the wicked or the just, and then a transition to another plane where the good enjoy perpetual happiness and the wicked suffer for their crimes, it is difficult to believe that many persons who have led rather self-centered yet really not wicked lives may be earth-bound for a century or two before being released from their self-induced hypnotic state. And it is difficult for them to conceive of some brave boy, whose body was blown to bits by a shell while in intense action in war, continuing his fight for a time without knowing that he had died.

But the wind bloweth alike upon the just and the unjust. Ignorance is punished on the physical plane, and no less so on the next. The laws of nature are inexorable, and if violated, even with no malice in the heart, they exact an unmitigated penalty.

When we apply ourselves strenuously to some routine task until somewhat exhausted, especially if this task requires the concentration of our mental energies; after ceasing it, if we shut our eyes, we have the vision before us of its performance. Then when we go to sleep that night, all night long perhaps, we roll and toss, and in our dreams do nothing but this task, over and over again. Through our preoccupation with it we have mentally attached ourselves to this task and its environment. We have created a thought-form in which we live. Our physical body has ceased the task, but our astral form, on the inner plane, is still performing it. A spirit, moving near us, would witness us still drearily and monotonously repeating the performance over and over.

Of course we are freed from this astral condition by the returning vitality and the new interests of the following day. But had we passed from the physical body while so dominated by a thought-form, it would probably have been longer than one day before we should have awakened to the reality of our new condition; and for a short time, at least, as a disembodied soul in the astral world, we should have known nothing of our surroundings except the performance of this task.

In that case, presently someone would have come along and seen what we were doing, and would quickly have awakened us to the new reality. Likewise the brave soldier who is snuffed out with a suddenness that gives no time for adjustment: He may go on fighting the fight, held by the emotional intensity of the thought-form he has created. After a time, if not contacted by some helper, he may wander over the forsaken battlefield until taken in charge by one of those on the inner plane whose work it is to waken such persons. Or, after some wandering about, he may fall asleep and awaken refreshed, and begin of his own accord to recognize where he is and the nature of his surroundings. Even a hypnotized person, if he is put to sleep without suggestions to the contrary, will in time sleep it off and awaken of his own accord.

Thought-Forms

—Just at this point it is very necessary to make plain one of the chief attributes of the inner plane, an attribute of astral existence that is quite as common a property of it as weight is of existence on the outer plane. For want of a better term we may call it the thought-form property.

On the physical plane the low-velocity particles tend to fill in a replica of the astral form of anything. This astral form may change with great rapidity, and unless there is an unusual amount of electromagnetic energy present to bring about an instantaneous change in the physical shape, the physical change lags behind the astral change, and before it has responded to this change, still another astral change takes place. Because outer-plane life has such low velocities it is far less sensitive than the high velocity inner-plane levels of existence.

But on the high-velocity levels, such as those of the astral and spiritual worlds, substance and form are vastly more sensitive and responsive. They change instantly under the impact of thought. Thus, to think a thing intently, is to build it up out of astral substance. It then exists on the astral plane for a period determined by the amount of vitality supplied to it in the thinking. When the energy expended in its creation ceases to hold it together as a definite form, it dissipates, leaving only the scar, or impression, of its presence as an astral record.

We possess astral bodies while still in the flesh, and we still possess astral bodies when we leave the world of flesh; and in both regions we formulate thoughts. And any such thought, if visualized strongly and vitalized with emotional energy, molds the astral substance into the image thus held. This is a thought-form; and its endurance and power to affect its environment depend upon the energy it contains and the directive force imparted to it by the thinker. But whether thought by someone on the physical plane, or by someone who no longer has a physical body, if it has been clearly formulated and energized it exists as an actuality on the astral plane, endowed with those properties thus given it. A house thus conceived is a real, substantial house on the astral; quite as solid, and perhaps even more durable, and as useful for home or office, as a similar building of wood or stone on the physical plane.

If I were called upon to mention the most striking difference between the world where we dwell after so-called death and the world where we now sojourn, I should unhesitatingly say that the thing which has made the most forceful impression on me is the immediate responsiveness of the next world to thought.

On the outer plane, we first think of a house, then think of placing each piece of building material in its proper position; this thinking being slowly and laboriously followed by appropriate physical action. And, if we so desire, immediately after death we can build a house in this same laborious fashion. But when we learn how to use our thoughts, because of the responsiveness of inner-plane substance to thought-power, we can visualize such a house, and bring it into existence in all its details.

It is said it took twenty years for 100,000 slaves to build the Great Pyramid. But with spur railroads, hoists, cranes, blasting powder and modern machinery a duplicate of this pyramid could be built in a few months by a smaller number of competent men. The result obtained might be practically the same, but the method employed and the time consumed would be very different. And things built on the inner plane by concentrated thought are quite as substantial as the same things built there by the slower process, and are quite as effective and lasting as similar things built on the outer plane by the more laborious method of thinking first and then acting mechanically.

Things that are built on the physical plane may be directly in line with human progress and assist Nature's changes, or they may be athwart the general plan of world progress. That is, they may be built in such a manner as to harmonize with the trend of events, or they may be built in such a manner as to resist inevitable movement.

Those who build on the ever-shifting sands are the subject of innumerable Sunday sermons. To build on the side of an active volcano is to court disaster. To endeavor to farm on lands inundated almost every spring by flood water is to invite crop failure. Even, I believe, as Gandhi with such good intentions is advising the population of India, to discard machinery and return to making everything by hand in a world where machinery has now come to stay, is to place oneself at a terrible disadvantage. Man on earth must keep step with world progress, and the soul on any plane must move with the tides of evolution, and not against them, if it is to survive.

There is a Deific plan, and the universe, the astral world as well as the physical world and the spiritual world, is all marching forward toward the realization of this plan. Whatever is of value in working out this plan, of utility in building this evolutionary structure thrives and is successful. But whatever opposes this plan is an obstacle toward greater perfection, and as of no value in the universal construction must perish. If it obstructs the highway leading the soul to universal perception and absolute consciousness, it is subject to condemnation proceedings. It is removed to give place to something more advantageous to cosmic society.

Thought-Built Regions

—And thus it is that on the astral plane there are thought-created environments that correspond to the universal constructive plan. That is, they represent truth, because they conform to nature. But also on the astral plane, especially on those levels which in basic vibratory rate are close to the vibratory levels common to the physical world, there are other thought-created environments that have a very real existence that do not correspond to truth as truth is perceived from a study of various higher levels. These thought-created environments are real in the sense that they have an actual

existence where they are located. Where they exist their buildings, their trees, their modes of locomotion, and the creatures other than human beings that inhabit them, are as solid and consistent as are the environments of earth. But if they do not conform to nature, do not fit in with how nature operates when viewed from a variety of other and higher levels, they must be considered as erroneous creations.

People living on the earth become tremendously earnest and emotional about some idea or condition. Thinking so strongly about it, and vitalizing it with emotional energy, they create this visualized thing on the astral plane. On the astral plane it possesses all the attributes they have given it. It is real, and in proportion to the energy given to it is influential and enduring. Anyone on the physical plane who can extend his consciousness to the level where it exists can see it and examine it. Anyone on the astral plane, who no longer has a physical body, who can tune to the frequency of its level, can perceive it and can influence it, or may be influenced by it. It has an actual existence. But it may not represent a true conception of things. It may be built entirely upon error. It is a thought-form creation; and a thought-form creation may represent truth or error, and in either case be real and tangible. But those who have advanced in their studies as well as in their emotional development and understand the laws and conditions that govern these inner levels, perceive a thought-form for what it is. They know it is but a creation that in time will dissipate and disappear.

The wisest of those yet on earth comprehend only a small portion of the facts regarding our physical world. New discoveries are made almost every day, some of which violently upset old notions. How foolish, therefore, to believe the moment one passes to the next interior phase of existence he must know all about that plane, and even about worlds still more interior. When one passes to the inner world, unless he has started his education concerning it while still in the physical and under competent guidance, he knows about as much regarding it as a babe does when first born into physical life. If he is wide awake, and desirous of doing so, he learns something each new short period; but it takes time and effort to learn much about this new life.

After a time, as he learns more and more, and advances spiritually, he gains the ability to move to higher basic vibratory levels. Later still, in the course of advancement, he is able to traverse across different levels and observe what is going on in each such different region. He gets a better idea of after-death life then; and learns how to distinguish between the thought constructions that coincide with nature and the universal purpose, and those thought-built regions that are as artificial as a stage play of physical life.

The stage play is real, as a play, and it may, or may not, accurately represent something in the world of affairs. People have had enough experience with affairs outside the theater not to think the theater play is outside experience. But if a visitor from another planet were to come to earth and enter a theater he most likely would take the stage play as the true condition of the world. So also those who arrive in the next world without having had experience enough with its different phases to discriminate. If they find themselves amid an environment of artificial thought-forms they consider, until later they are better informed, that this kind of an environment is the common one of the next life.

On the physical plane men now build mechanical robots that are capable of doing a marvelous variety of human work. They do just what they are constructed to do, but possess no other ability or intelligence. So, likewise, thought-forms are created by those still in the flesh, and are sent out by them with a definite object in view. They work to accomplish this particular purpose with all the semblance of intelligence. In fact, they have been endowed with intelligence regarding the accomplishment of the thing at hand. How such thought creations act to accomplish things on the physical plane, and how they may influence the course of human lives, is explained in detail in Course 18, Imponderable Forces.

The vital point I here wish to emphasize is that such a robot can be created by thought-power to possess a particular kind of intelligence and activity. And the concentrated thought of many people holding the same mental image can create on the astral plane a whole environment of any particular kind, peopled by such robots. These thought-form robots have no souls, no more so than have the mechanical robots of the physical plane. But they act with apparent intelligence and perform the functions with which they have been endowed by the imaginations of their creators.

Heaven and Hell

—Thus a complete heaven, according to the old Christian plan, with streets of gold, with precious jewels, with a great white throne, and angels around it playing on harps, and even Jehovah sitting on this magnificent chair as an earthly king might sit, can be created by the thought power of a group of devotees. And Jehovah, thus created, will talk like a human being, and render judgments such as this obsolete conception demands; and the angels will flap their wings as they fly, because they have been patterned in the mind somewhat after the manner of birds of flight. But these bird-like angels and this man—like Jehovah will be but robots, created by thought power, and carry out what they are expected to do as intelligently as a mechanical robot on earth does its work faithfully.

Also a complete hell, with its smell of sulphur, and its imps, and a devil with a pitchfork and spear-like tail working amid flames, can be created by the same means. If there is a body of people who believe in just such a region, and they visualize it frequently, and have strong feelings about it that vitalize it with emotional energy such a region in all its details and denizens becomes fashioned on the astral plane. By that thought-form property of the astral region the place is built up and given reality. It actually exists, as much as a similar place built of material substance by physical means on the physical plane and peopled with mechanical robots constructed to perform a definite function.

Not only do these regions and their robot population exist, but they continue to persist until the vitality imparted to them by thought processes and emotional attitudes dissipates. Then they dissolve and leave only their impression as an astral record.

But because such artificial and erroneous environments have been built does not make it necessary for people who are on the astral plane to live in them. If a person has held such an image in his mind with great faith, at the death of the physical body this faith is a force, acting through the law of affinity, to attract him to some astral, but artificially created environment of a nature corresponding to this faith, on the astral plane. Not only does the astral plane consist of a great number of strata of life and existence, each such basic level being separated from adjacent basic levels by a band of vibratory rates which sustain little life, but each such level as provides for abundant life through its vibratory strength is comparable to one of the vibratory frequencies commonly used by radio stations to act as the carrier waves for broadcasting their programs.

These carrier waves of a given number of kilocycles do not convey information or themselves produce intelligible sound when picked up by a receiving set. Yet using anyone of them as a carrier wave, a broadcasting station can transmit, through wave modulation, an infinite variety of programs. The same program, for instance, which is transmitted over a vibratory level of 550 kilocycles can also be transmitted with equal success over a vibratory level of 1500 kilocycles.

This means that on any single basic vibratory level the variety of radio programs is infinite, and that on a single basic vibratory level of the astral world an infinite number of conditions and life-forms can exist, including such artificially created environments as we are considering. These life-forms and environments also have their vibratory rates, even as the radio carrier wave is modulated by incidental vibrations. And as the factors of a radio program which is being received are not separated from each other by space, but by time intervals, so the distance between the various objects on a given level of the inner plane cannot be measured in terms of distance such as is used on the physical plane: for such space on the inner plane has no

significance. Nor do we, as a rule, while listening to a radio program, know how close or how distant in terms of space the performers are to one another. And on the inner plane the distance of things from each other on the same basic vibratory level is measured by difference in vibration, difference in modulation on that basic vibratory level.

This means that on any given level of the astral plane things having a similar modulating vibratory rate are close together, and things having dissimilar modulating rates are far apart. When an individual thinks concentratedly about a certain condition or person, this tends to adjust his incidental, or modulating rate, to the environment or person thought about, which means he moves to that vicinity. And if this vicinity about which he thinks so earnestly is a thought-built artificial environment, he nevertheless moves into it, even as he would move into a more natural environment if his preconceptions did not hold his consciousness so focused that he cannot perceive anything but what corresponds to them.

Thus if his faith is strongly that of the Mohammedans¹, the environment to which the law of affinity attracts him is that constructed by the thought-forms of Mohammed's followers. If he strongly enough expects to find the nirvana of Hindu belief, he will move into such a place of effortless lack of consciousness. Whatever his faith or belief, if strong, will attract him, due to its vibratory modulations, to such a region as most nearly corresponds to his ideals.

This is not the same thing as the earth-bound soul who cannot free himself from some strong desire of earth, nor is it the same as the soldier who for a time, until awakened, lives in his own mental images. It is not the same because there is greater freedom and a wider consciousness of conditions. Instead of being bound to a consciousness of some limited environment, or bound, for a time, to the thought-forms of his own creation, the individual realizes he has passed from the physical plane, and moves about freely within a region of the next-life plane. But, until someone, or something, is able to get information through to him that there are other regions quite different from the one in which he finds himself, he lives in, and is conscious of, only this environment which has been constructed by the thought-images of those who hold a belief similar to his own.

If a visitor from some other planet were to awaken in the center of some large office building he might move about in it for a long time without knowing anything about the traffic of the streets, about manufacturing plants, about parks and places of amusement, or about homes and gardens. If, at the same time, he had the fixed idea before he went to sleep that there could be nothing on earth except the inside of an office building, he no doubt would reject every attempt of others to tell him about different conditions.

The same person who can believe the earth was created in six calendar days and has been in existence only some 6,000 years, in spite of every evidence to the contrary; if he were as firmly convinced that the inside of an office building was the all of earth-life, could not be convinced by those contacted there that there was another kind of existence outside of this building. He would tell anyone mentioning the subject that such an idea was sheer nonsense.

So also those who pass to the next life with strong faith they will find a certain condition are limited to some such condition. Yet the environment they enter is real; for it has been built by the collective thought power of those of similar faith. But it is not the all of the next-life environment. It is as significant a section of the next plane as some single office building, or some single farm, is significant as compared to the whole world. Yet so long as the individual confines himself to this single environment all his reports to his friends left on earth will describe nothing more than is there found.

In time, short or long, depending on how fixed his faith is, someone from another region will be able to gain his attention sufficiently to explain to him that there are a vast number of other regions of an entirely different character. His views may be so narrow that he will deem this visitor some deceiving imp direct from hell attempting to lead him astray. Or he may become sufficiently interested to desire to investigate. He may take a short trip with this guide, to see what there is outside the domain where he now is living. Then begins his real education; and if he still sends reports to friends yet on earth they will perceive his views are changing, and that he describes the after-life as different than what he stated it to be at first.

Of course, not having traveled on the astral plane before physical death, his first trips of exploration, even augmented by explanations from his guide, give him no very extensive comprehension of what the next life is like. Ordinarily one must live some fifty years on the physical plane, and be very studious besides, to get a fairly comprehensive general knowledge of what is known about the physical world. And although the astral senses, and the facility of astral thinking, are much superior to their physical counterparts, yet the regions of the astral are so immense and varied in nature that any comprehensive, though but general, knowledge of it can only be gained at the expense of much time and energy. Therefore, without the advantages of a first-rate education after reaching the astral plane, we cannot expect an individual to make very accurate reports concerning it.

We who are yet in the physical body, with proper training also can explore the inner plane. There is more than one way that this can be done. The electromagnetic energies may so completely be withdrawn from the physical that there is no apparent life left in it, and the material form assume the cataleptic state while the consciousness is centered exclusively in the astral form as it travels about the astral world. But such astral travel, and extensive investigation through Feeling ESP, have rather serious drawbacks. And the information gained is no more comprehensive or reliable than can be acquired through extension of consciousness in the use of the safer Transition Technique of Intellectual ESP.

One should no more expect to be able to conduct such inner- plane explorations without special training than he should expect to be able to solve mathematical problems with no previous training in handling figures. For handling certain jobs on earth it is usually considered essential that the applicant shall have a high school education. And if he must undergo training for some 12 years on earth to fit himself to start special training for a profession, or before starting in business, or before applying for a job, he should not expect to be able to direct his consciousness and his energies effectively on the inner plane without considerable training also.

Yet the kind of training required for safe inner-plane exploration is not mysterious. Nor does it necessitate more arduous mental effort than is used in getting a high school education. And in it there are only five essential subjects.

While it is not necessary to withdraw the electromagnetic energies from the body, such as those do who travel astrally while in the cataleptic state or near cataleptic state, it is necessary that there shall be abundant electromagnetic energies present of a frequency suitable for supporting the extended consciousness. Even for cerebral thinking, suitable electrical energies must be present. But for extending consciousness on the inner plane there must be energies of higher frequency available to draw upon. Therefore there should be training in proper electrification.

The consciousness cannot concentrate on inner-plane things while the thoughts are engaged with a multitude of everyday problems, or is centered with what is going on in the outer world. To be able to hold the consciousness on the inner plane without distraction there should be training in inhibiting cerebral thinking.

Yet a person may inhibit cerebral thinking without gaining information about the inner plane. Most of us habitually do this when we go to sleep. But to gain information through the Transition Technique, consciousness is not completely lost. And to handle this phase of the matter there should be training in attaining inner-plane consciousness.

When some degree of inner-plane consciousness is recognized, if there is to be exploration, the consciousness must move to the region to be explored. And to do this with facility there should be training in inner-plane activity.

Information gained on the inner plane, or experiences undergone there, reside in the unconscious mind as memory, and may never be recognized by objective consciousness. To bring these memories of exploration on the inner plane through, there should be training in the objective recognition of inner-plane experiences.

In such explorations we may view natural conditions, or we may go through artificially constructed environment; for there are natural conditions on the astral just as on earth there remain a few environments that have not been changed by the hand of man. Our impression of this inner region will largely depend upon the particular place we visit. And these places are far more varied than those on earth because there is another dimension; that is, there are vertical layers, as well as surface extensions. There are vibratory levels, and each station, one above another in vibratory rate, corresponds to a new world of existence far vaster in expanse than that of the physical world, and with more details and contrasts.

We must also always take into consideration the censorship tendency of the objective mind through which such information comes. Yet most of the reports of those who travel in their astral bodies while still in the flesh, of those who visit the next plane through extension of consciousness while still occupying physical bodies, and of those who have left physical life and dwell on that plane, I believe are substantially correct as far as they go. That is, I consider most of these descriptions to be rather accurate recitals of what really exists on the astral plane. They may be descriptions of situations built up by erroneous thought-forms, they may be descriptions of situations built up by correct thought-forms, or they may be descriptions of situations as they naturally exist without being tampered with by the thought-building processes of man.

But, of course, any description of that region is limited. The descriptions of those who have visited but a single environment will be confined to it, and the descriptions of those who have made more extensive explorations will cover a vaster realm. Yet the description of one who has been in only one environment may quite contradict the description of someone else who has been only in another environment; as much so as the description of Coney Island on Sunday in summer differs from a description of a Klondike mining camp in winter. Nevertheless, both descriptions may be rather faithfully portrayed.

Influence of Desires

—I have already mentioned that all activities are tremendously heightened, and all sensitiveness immeasurably intensified, in life and existence on the astral plane. Yet even on the earth plane, where we go and what we do is the direct result of desire. We act in a certain way only because there are no desires, conscious or unconscious, that are stronger to move us in some other manner. Furthermore, because we have astral bodies also while occupying the flesh, the thought-cells within these astral bodies that have been organized by experiences and thoughts attract to us by their activities

in response to their desires, while still on earth, and again after we have left the earth plane, an environment corresponding in nature and in harmony or discord to these thought-cells. That is, whether on the physical plane or after so-called death, the organization of our finer form, which in expression becomes our character, attracts experiences to us that have a similar quality.

A desire, on either plane, strives to release energy. And if such energy release is sufficiently powerful the whole form may go into action. Because the astral form responds with much greater alacrity to the desire stimulation of thought, it is sometimes called the desire body. Any desire, or any change in the vibratory rates of the astral body, brings results more speedily and more pronounced in the astral world than it does in the physical world.

This quick response of the astral form is manifest in two distinct ways: Any pronounced change in the general vibratory rate of the finer body moves the body to a plane, or level, corresponding to this basic frequency. That is, the body of the individual moves vertically, as we may call it for want of a better word, to the basic astral or spiritual level corresponding to his dominant spirituality and refinement; for refinement and spirituality are a matter of higher vibratory rates as distinct from lower vibratory rates, of thought and form, and consequently of soul and character.

In this vertical movement there are certain gaps, chasms, or abysses, between vibratory rates where there is no clearly defined existence. Just as when turning the dial of the radio from one station to another, a region of wave-lengths may be crossed, over which nothing is broadcast; so in passing from one basic vibratory level to another in the next life, there may be a chasm in which there is no life, or such life is distorted and blurred.

In the lower regions where some souls find themselves soon after physical death, certain chasms not infrequently are bridged by those with knowledge of such construction, so that these slowly progressing souls may not have to wander in the darkness of these great gaps, but may be led across on secure footing. But where the basic vibratory rate is changed more abruptly, the individual simply moves from one plane to the next, the appearance being that of aerial travel. That is, the body seems to rise or sink into a new world. Yet whatever world he thus passes into, is as solid, tangible, real and vital as the physical world. Yes, it is more vital, because on the inner levels above the very lowest the activity and the throbbing, pulsating, insistent manifestations of life are far more vigorous and intense than anything with which we are familiar in this lethargic world of matter.

But in addition to this world-level which is determined by the dominant vibratory rate of the astral form as surely as turning the dial of a radio determines which broadcasting station is tuned in on, the desires of the individual move him with great rapidity, within whatever world to which his dominant rates assign him, to a region where they can find expression. That is, a strong desire on the earth may take a very long time to move the individual into the environment where it can satisfy itself. But on the inner levels of life, such a desire tends to find an environment suitable for its expression very quickly.

I do not mean that all one must do to be a great character, or to be very wise, or to perform some noble work, is merely to wish it strongly. But I do mean that wishing strongly to do the thing much more quickly brings the opportunity to try to do it. The environment more readily responds to the desires; and if one wishes strongly to be a great character, very soon opportunities are attracted that if grasped start one on the road to building a great character. Or if one desires ardently to be very wise, this desire, without much delay, attracts a teacher who is able to explain things, and a guide who is willing to act as pilot in journeys here and there by which the range of information can be extended. Or if one wishes to do a certain noble work; one is attracted to those who are making similar endeavor, and is aided to get started doing it.

But, of course, if the nature of one's desires are too low to find expression on this level, and they are maintained, they lower the dominant vibratory rate of the form, and the individual drops to a lower world. If they are vicious and evil enough, he may have to go into the so-called hells to be able to express them; but if they are higher than the level on which he resides, they raise the tone of his essential vibratory rate to a point that causes him to ascend to a higher world where such expression is possible.

It will be seen, therefore, that even as they are the most important things on the physical plane, so also are man's thoughts, desires and ambitions the determining factors of his condition both in the life immediately following physical dissolution, and in the life of still higher spiritual realms.

Although thought has so much building power, and the form and conditions are so responsive to it on these inner levels, these levels must not, in any sense, be considered vague or less real than the physical. If one travels to China, there are different conditions than obtain in America; but life there is no less real. Or if one takes a trip through the less known regions of Africa, conditions that seem most bizarre must be met; but even though strange, there is nothing vague about them to those who live there. Nor, outside of there being levels of existence to which things are attracted instead of gravitation, distance determined by resonance instead of by our earthly conception of space, a different order of time, ability to look down world-lines and witness the past and probable future of things as well as the present, and the amazing potency of thought all of which are consistent with the principle of relativity when higher-than-light velocities are reached does life seem strange to one passing from the physical to those after-death lands.

I am sure the five mentioned common properties of astral life are no more difficult to get used to, and on that plane no more difficult to understand, than many of the inventions that those of my generation have had to accustom themselves to on the physical plane. Either a markedly new device, or markedly new property of substance, such as the radiant energy of radium, makes necessary some effort of the human mind for a proper adjustment. Matter was mostly opaque until the X-ray and radium were discovered. These came as distinct shocks to our conception of things. Yet we now take them as a matter of course; just as a little later, in the next life, we will take thought-form construction and desire power transportation also as not unusual. And it will then seem strange that we could have once thought life was confined to a single level, instead of being composed of different levels of vibratory strata.

Scenery

—On each of these strata that are not distant from the earth we find scenery that in appearance differs little from that of the physical world. There we find mountains, and lakes, and waterfalls, and forests, and flowers, and birds and mammals, just as we find them here now.

To be sure, the colors are more brilliant, with that intensity of color and shade with which those are familiar who have made even a little progress through using colored discs in the development of clairvoyance. These colors, as anyone who has ever seen them even for a moment knows, are not merely the complementary colors of the one looked at. They are far more intense and beautiful than any shade possible to be seen with the physical eye. And very many people, at one time or another, have at least glimpsed these astral colors, or have heard the astral chimes. The notes of birds, and the music of the inner plane, as suggested by the quality of these astral chimes, is of a clearness and beauty of tone that is quite indescribable. So, in the sense that they may be far more beautiful and attractive, the colors and tones of the next life are different from those to which we are accustomed; but the difference is in quality, and we recognize them as otherwise the same as those with which in earth-life we are familiar.

Birds and trees and flowers exist on the levels closer to earth; and on levels high enough these are replaced by a vegetation and bright, starry-eyed creatures of pure quality, higher in intelligence, with greater spiritual affinity, that perform the functions on these more interior levels that birds and trees and flowers do in the more external worlds.

Some of the buildings, of course, are different in structure; and some of the mechanical devices are based on properties pertaining to the inner plane. But take it all in all, whether we descend to the hell-like regions below, where vice is the rampant feature and the general environment is hideous in every respect, or ascend to the higher regions, even as far as we are able to peer into the upper spiritual spheres, or as revealed to us by those who there dwell; in none of these regions do we find things or conditions so vastly remote from what we can experience on earth.

It is true that while on earth the population mixes rather freely together without regard to the innate viciousness of some and the essential spirituality of others; yet even on earth we do not visit night-clubs and gangster dens to find virtue, nor do we attend lectures on altruism in the hope of apprehending hoodlums and crooks. This contrast, caused by the segregation of those of similar basic vibratory rates and similar desires is, however, much more pronounced on the inner plane.

If we visit the hells, the only virtuous persons we find there are those with missionary intent. And if we ascend across the levels to a high region of spirituality, we find an entire absence of the base, wicked and self-centered. These cannot move to such a level because their vibratory rates are too coarse.

In the world where we live after passing from the physical, very quickly we shall feel at home. Some of those who looked older, we shall find now look rather young, and some of those who looked so young as to be immature we shall find had time to grow to adulthood. But if we knew them on earth we shall have no difficulty in recognizing them when we meet them on the next plane. Nor will their characters have changed except as people's characters also are wont to change through deterioration or growth in the physical world.

Our Loved Ones

—Those who loved us, will still love us; and those who opposed us on earth, unless they have gained in wisdom, will still have a tendency to oppose us. But if they belong to a different vibratory level than we, they will be unable to affect us; and in any event, if we are to advance in this realm, we will compose and adjust our differences in the work for a more important common cause. Loved ones, also, may occupy a different vibratory level; but if the love is strong and persistent, it finds a way for the one above to visit and encourage the one below, and for the one below to build such a character that he can move to the higher level.

To be sure, certain affectional tangles present peculiar problems in the after life. The wife who has had several husbands through the death of some, and the husband who has had several wives. And matters of injury to others, and of responsibility for leading some into downward paths. It takes time, and conferences, and the advice of wise teachers from still higher regions, to begin to straighten all these things out. But because, when more highly evolved, the affections by that evolvment readjust themselves on a truer basis, at a certain height of attainment each is united to his rightful mate.

Other ties of earth, also, carry their responsibilities into the next life. Those we contact and influence on the earth-plane may present a debt that calls for readjustment. We may feel that the best way to right a wrong is to do something helpful for the same individual in the after-life. That we may feel right within ourselves, of course we must pay our debts. The record of our lives is before us, and we act both as judge and jury. Often the best method of rectifying some mistake is directly through the person who suffered most by it. Such direct squaring of accounts, however, is not always possible. And in such cases they can be liquidated by the more indirect method of effort expended in helping any other person who in particular needs our assistance.

The next life is not some weird, strange place. With a few improvements, life is lived there very much as it is lived now on earth. Because they think more clearly and comprehensively, feel more intently, and act with greater speed, people there are much more alive than on this plane where everything is retarded by slow-moving matter. People in the next life know more than they do here, they do more than they do here without suffering fatigue, and they have greater delights and experience keener enjoyments.

A savage usually resists strenuously the effort to civilize him. But once civilized, and in a civilized community, he finds it far preferable to his former state. Those in the next life can do practically anything that those on earth can do, and many enjoyable things those on earth cannot do. Is it any wonder, then, that those who are above the lower levels of the astral life almost never express a desire to return to this rather sordid life of earth?

¹ Muslims

Chapter 3

Serial No. 175
Original Copyright 1942
Elbert Benjamine

Copyright
Church of Light
August 2002

Birth into the Next Life

Chapter 3

Birth Into the Next Life

THE circumstances attendant upon passing to the next life are quite as varied and lacking in uniformity as those attendant upon birth into this life. In fact, the death of the physical body is really the birth into that new existence.

Births upon the earth take place amid widely different surroundings, and birth into the after-life may be such that the individual awakens amid attractive conditions, attended by friends who minister to and welcome him; amid the harsh conditions of an isolated and rugged region, or in a hovel where all is dirt and squalor. Just vision the circumstances that attend births on the physical plane; those in the igloos of the arctic, those of the savage in the jungle, those of the journeying American Indian at the side of a trail, those of the tenement regions of our cities, those in the better class homes, and those, increasingly common, in lying-in hospitals where the surgical care and the appointments are of the best. Entry into the astral region has even more scope by reason of a wider range of environments.

Births on the physical plane, whatever the environmental circumstances, may, however, be broadly divided into natural deliveries, accidental deliveries, and surgical deliveries. Those into the next life do not run exactly parallel, perhaps, but they also may be classified into three broad and general categories that have certain points of correspondence with those mentioned as of earth.

Corresponding to the natural deliveries on earth, we have those passages to the next life in which there is continued consciousness during the transition and, perhaps, a will to go. Some of the northern Indian tribes are reputed commonly to die in this manner. When they get old they have an inner feeling that the time is at hand, and they set the day of their passing. On that date they merely lie down and pass consciously to the next plane. Among those advanced in occult knowledge such a method of going over, without losing consciousness, is far more frequent than people suppose. And by one who has practiced travel on the astral plane without losing consciousness while leaving and returning to the physical body, or who has used the Transition Technique of astral exploration, the passing at death is not accompanied by sleep. We may say then, not because it is the most common method of physical death, but because the natural evolution of the higher states of consciousness makes it spontaneous, that the passing to the next plane of existence in full consciousness is the natural method.

Then there is the accidental method. Physical death arrives, even as does child-birth at times, with no warning. It comes suddenly and with a great shock. An explosion may blow the body to atoms. A sudden stroke may sever the bond between the two bodies. Suicide, even though premeditated, may abruptly usher the individual into the next world in a sadly unprepared condition. And a variety of other circumstances, in which there has been no gradual separation of the astral consciousness from the physical, may come under the heading of the accidental method.

But, even as in this country it is far more common to have the attendance of a doctor or midwife at the birth of a child, so far more frequently the individual passes to the next plane through an illness of some duration, and is taken in charge immediately after his passing either by friends who have gone before him, or by those whose regular business it is to greet and take care of those newly arrived from the earth plane. Because of the presence there of those who help us to enter, and get adjusted to, this new world, let us call this the surgical method.

Now, from olden times down to Helen Willman and Harry Gaze, there have been those who preached immortality in the flesh. And I am confident that physical life should be, and can be greatly lengthened. Yet I can hardly imagine a more horrible penalty than being compelled to live forever on the earth. The spiritual man revolts at so gross an avenue of expression, and comes to long for a finer, higher region, where his developing potentialities can find a glorious freedom of action. Nor, out of all those who have taught immortality in the flesh, have any lived much beyond the customary limits of physical life. Therefore, both you and I, in a time that will seem unusually short, are sure to make this change, and it behooves us to learn something about it.

When we pass over, as we surely must at no far date it will be by means of one of the three methods mentioned: the accidental, the natural, or the surgical. But by whatever means we pass over, the circumstances in which we shall find ourselves on that plane depend entirely upon our knowledge of after-world conditions, our desires, and our spirituality.

The dominant vibratory rate at any given time determines the inner-plane level to which we gravitate. Although we may be un- aware of it objectively, and although our attention may be so focused on external life that we are almost completely unaware, even in our souls, of the inner-plane condition which surrounds us, nevertheless even while we occupy physical bodies, our astral forms exist upon the vibratory level of the inner plane whose basic rate is similar to our dominant rate. And while due to our preoccupation with external affairs we may be oblivious of such life-forms, our astral bodies can be seen by any inner-plane entities occupying the same basic vibratory level. And our thoughts may be perceived by inner-plane entities not belonging to the same basic level, but who are able to extend their consciousness temporarily to the vibratory level of these thoughts.

Within the finer form of man on earth often there are strong vibratory trends which would quickly become dominant were it not that the necessities of physical life so continuously chain the thoughts and feelings to the struggle for physical existence. We all know people who are in essence kind, who love refinement, who desire above all things to be helpful to others, who have love for their fellowman, and who spend some effort in relieving the distress of others with no thought of recompense; but on whose shoulders also falls the burden of providing the physical necessities for themselves and their families. There are powerful spiritual trends present. But the struggle for physical subsistence is so strenuous that most of their attention must be directed toward making a living, toward getting a job and keeping a job, toward preventing aggressive and unscrupulous persons from gaining undue business advantage, and the thousand and one other things that must be done to be physically successful in a world which is as yet far from altruistic.

Thus for most who have strong spiritual inclinations the intervals in which spiritual vibrations are dominant are intermittent and far more rare than the intervals in which the dominant vibration is determined by work for physical necessities and physical comforts. For most who have some aspiration for a spiritual life there are daily periods of devotion in which the vibratory rates are temporarily raised, there are intervals in which affection and tender love are dominant, and other intervals when the glow of some fine deed increases the rate. But in the longer intervals the vibration returns to that which is developed in the struggle for physical survival.

While living in the physical it is not expedient to ignore the physical necessities. But I am sure people in general would spend more time and energy in cultivating the more spiritual moods and acts if they realized that their souls exist now upon the astral plane, and that at any given time it functions on the particular astral level of the inner world which has approximately as its basic vibratory rate the dominant vibratory rate which the individual has at the time. Did they but realize this I am sure they would be more careful as much as possible to maintain a mood which would insure that the astral level thus contacted was one whose influence upon their lives would be physically, mentally and spiritually beneficial.

Merely to contact a given level sufficiently to get information from it through extra-sensory perception does not require that the dominant rate of the astral form as a whole shall be adjusted to that basic level, although it is easier to get the information when it is. If the consciousness centered in but a local area of the astral form is able to adjust its vibratory rate to the region, the level and locality on it may be reached merely through extension of consciousness, just as one on the physical plane can examine things at a distance without actually going to them through using sight and smell and hearing. But whatever the dominant rate of the astral form is, that is, the most powerful vibratory rate in it, determines the actual level on which that astral form resides.

Now a particular physical environment is not the cause of the vibratory rate of people residing in it; for under the same external circumstances the dominant vibratory rate, as well as the reactions in general of people differ. Under specific conditions of hardship some people become morose and bitter, some become mild and subdued, some become irritable and antagonistic, and some become kind and sympathetic. But we cannot ignore that the physical environment does have an influence upon the character, and therefore upon the dominant vibratory rate. It is most difficult, for instance, to maintain a harmonious mood of any kind amid clash and discord. It is difficult not to feel anger when attacked, and resentment at injustice. These are emotions which while they last powerfully influence the vibratory rate.

And thus it is that when most people are born into the next life their dominant vibratory rate for a time is powerfully influenced by their habit of meeting the demands of physical environment. Their thought processes for the term of their physical lives have been directed mostly to the things and conditions of the earth plane. And so long as their thoughts are chiefly of these things of earth to which they have become accustomed they tend to maintain the dominant rate which was customary on earth.

Thus in spite of being very good, very bad, or merely indifferent, people when they move out of their physical bodies permanently do not at once gravitate to the realm which later they will occupy. There is a transition period in which, as a rule, they remain rather close to the level corresponding to their previous struggle for physical necessities, and gradually become accustomed to their new condition.

But as they become accustomed to the fact they are no longer inhabiting the earth, and no longer compelled to struggle for physical survival, their desires may relinquish the attachments to physical things and permit those aspirations and yearnings which the physical struggle has held in abeyance to gain the dominance they have so often longed for. And as these vibratory rates become dominant they move up or down to levels of the astral realm having similar frequencies.

Desire is the mainspring of action, not only on the outer plane, but also on the inner; and people do not immediately change their desires when they pass to the next life. Instead, for a time their habitual interests and habitual desires remain, and these hold them from moving too far from the vibratory condition customary to them on earth. And these desires also often keep them for a short time sufficiently in contact with the electromagnetic Boundary-Line energy associated with the environments or people they knew on earth, or with the electromagnetic-astral belt surrounding the earth, to enable them to use it.

About the earth there is a dense belt of electromagnetic energy derived from the thoughts of people on earth and the feelings of both men and animals. And even as people in sleep can move from the no-man's-land of that condition out to perceive conditions on the slow-velocity material plane, or in to perceive conditions on the high-velocity inner plane, so the vibratory rate of physical necessity which people retain in varying degrees immediately after death, and their desires and habits of physical life, keep them somewhat in contact for a time with this electromagnetic-astral belt, which is referred to in the Bible and in ancient ritual as the River Jordan, or the River Styx.

When we think intently of a condition or region, this tends for a time to tune us to the vibratory rate of that region or condition. And, regardless of spirituality or lack of it, the habitual thoughts of earth things, and the habitual vibration of physical necessity, together with the habit of utilizing electromagnetic energies in thinking, keeps considerable contact with the electromagnetic astral belt about the earth. And thus it is, because they can so readily utilize the energies of this belt, and make the contact with other electromagnetic energies of earth, those who pass to the next life for a time after passing have no great difficulty in making their presence felt by those in whom they are interested who are yet in the flesh. But after that period of time has elapsed that permits adjustment, they move to their own level, and if this level is a highly spiritualized one, it becomes difficult for them to manifest their presence, except through those who utilize extra-sensory perception or are unusually mediumistic.

In his book, *At the Moment of Death*, Camille Flammarion has collected a large array of well authenticated instances of the power of those who are passing, or who have just passed, to manifest themselves to their loved ones who are at a distance from the body of the deceased.

Furthermore, if the attachment to some particular environment, or some material activity has built a thought-form so powerful as to be, at least for a time, obsessive in character, the power of this thought-form may be sufficient to hold the person bound to the physical environment, or performing in pantomime close to the earth, this particular activity. With suitable electromagnetic emanations at hand to draw upon, such an earth-bound soul may produce a haunting. In any case he will linger near the earth in a somewhat dazed condition, interested in the things that are related to the dominating thought-form.

Such a soul has lost his physical body, but he is unaware that he has passed from physical life. His thoughts are as yet so focused on some earth condition, or some idea of earthly purport, that he has not yet awakened to a consciousness of his present conditions and surroundings. Except he is approached through his interest in the absorbing idea that dominates him, neither those on the physical plane nor those on the inner plane can get intelligent conversation from him. He is more like one walking in his sleep, performing, perhaps, very difficult feats, but devoid of his normal awareness. While he has passed from the physical, he is still in the boundary realm, and has not as yet awakened into consciousness of the next life.

When such an earth-bound soul finally is born into the life of the inner plane, his method of birth, and his after surroundings, are precisely those common to other souls who pass from physical life into the next life almost immediately. In the one instance the birth is accomplished almost at once, and in the case of the earthbound soul the period of labor is greatly prolonged. But when birth finally comes, the circumstances by which the arrival is surrounded are determined precisely by the same laws that determine those of the more quickly born individual. Knowing this, we can treat all births as belonging to the three previously mentioned categories.

The Time of Next Life Birth

—Of course, viewing the matter in one way, the moment the umbilical cord is severed may be considered the time of birth into the physical world. And on the same ground, it might be considered that the time of birth into the astral world is the moment when the silver cord that connects the astral form to the physical form is severed. But astrologers have found that, in certain instances, it may be sometime after the severance of the umbilical cord before the child draws its first breath and utters its first cry. And they have further found that the chart erected for this first breath, for this first independent act, is, in such cases, the correct chart of birth. Therefore, while customarily the child has its birth when the umbilical cord is severed, the moment of true birth may be delayed until somewhat later. And in like manner, while the moment of birth into the next life might be considered the moment when the silver cord is snapped; in a stricter sense, it seems to me, it should be considered as the moment when the individual awakens to a consciousness of his new life.

Natural Birth

—When the individual passes to the next life in full consciousness by the natural method, the astral form merely moves out from the physical form in precisely the same manner it does when the individual leaves the physical body voluntarily to make a temporary visit on the astral plane. On such a visit there is always a cord of astral substance connecting the astral body with the physical. The further the astral moves from the physical the thinner this white astral line appears. But in the case of permanent transition to the inner plane, by the natural method of passing, the individual purposely severs this astral cord connecting him with the physical body.

If he is aged, or the physical body is feeble, or if he has carried the refining process to an advanced degree, this line is already quite frail. But whether frail or not, it must be severed to break the connection with the physical form. The advanced soul breaks this line merely by the determination to do so, that is, by thought-power. When desirable and necessary, help in this can be obtained from those attending the birth on the other side. .

Accidental Birth

—In the accidental method of birth into the life hereafter, the transition from the physical is apt to be more abrupt. A soldier running across noman's-land may be blown to bits by a bursting shell. He has had no pain and does not know he is physically dead. He keeps on running, reaches the enemy, perhaps, and seeing their astral forms, does not realize that these are not physical, and attacks them. Then he begins to wonder why his bayonet thrusts produce no apparent effect. Others may have passed over about the same time, and they also are unaware of the transition. They talk together, and act in concert against the enemy. They may be joined by a comrade or two who are not dead, but merely stunned, and while lost to physical consciousness are out of their bodies on the battle-field. Or even some pal who has been thinking intently of the battle, and desiring to participate in it, and has gone to sleep with this in his mind, may come along and recognize and talk to them.

Being so close, as yet, to the earth and the activities in which they have been participating, they can see both the astral forms of those I who have just passed from the physical and the astral forms of those yet in the physical. If a horse has just been killed, one of them may jump on its back and ride it, without knowing it has passed over. He sees it stumble and fall, and then arise. He cannot as yet realize that it is only the astral body of the horse that has arisen.

But when he tries to talk to those still in the flesh he will begin to realize that something is unusual. He does not realize that he sees merely the astral forms, which are duplicates of the physical, even to every item of equipment and clothing. But because the attention of these astral friends is focused on the low-velocity region of the external world, which he is unable to see, they neither perceive him nor hear his voice. Their attention is held to a region of which he is oblivious. Not knowing this he is puzzled.

Yet this condition, as a rule, is only of temporary duration. On the astral plane there are organizations of people who have once lived on earth who take an active part in Red Cross work from that side. One of the functions of this organization is, in time of war, to help those who have been shocked out of their bodies, but are not too badly maimed, and the silver cord remains yet unsevered, to get back into and animate their physical bodies. And another function is to help those who are wandering around, after the cord has been severed, dazed by their condition, to complete their births. And a third important function is to reconcile them to the fact that they have been cut off from all physical activity.

Suicides, and violent deaths occurring while the individual is participating in some revolting crime, commonly live for a more or less protracted period amid the distressing thought-forms they have created. The period of labor accompanying their birth into the after life is both prolonged and painful. But in the end some skillful physician of the astral cohorts is able to reach their consciousness and bring them through into a consciousness of where they are. So, in the long run they, as well as those more worthy, are awakened into a realization of their true condition and its environment.

Surgical Birth

—But before speaking further of the surroundings of this new birth, we should take some consideration of those who pass by means of the surgical method, that is, the more common method of so-called death.

No two deaths, of course, are exactly alike and, therefore, no two births on the inner plane. Ordinarily, however, the person who passes out by illness or old age lies in bed. Usually the astral form moves toward, and gradually out of, the top of the head. Thus, the feet and hands become cold first, and then the coldness moves upward to the knees. Then, as the astral body gradually moves out through the head the coldness extends to the stomach, chest and vital organs, and finally to the throat.

Because, in such separation of the astral from the physical, the last remnant of the connection between the two bodies is in the region of the brain, the brain may remain clear, to the end; or even when there has been unconsciousness, just before the complete departure of the last remnant, the person, now occupying the astral form which hovers over the physical, may vitalize the physical brain for a moment to permit one last glance in full consciousness at friends in the flesh, the saying of farewell to dear ones, or the delivery of some last message. Then the cord snaps, and the person is no longer a denizen of the flesh.

But so strong is habit that the one so released, while quite capable of moving from the room through the walls or through the ceiling and roof, not infrequently awaits the opening of a door through which he now passes to the outside world, where he is met, if they do not already accompany him, by those who guide him to a place of rest.

Concrete examples are usually better than generalizations. So I will relate very briefly, not the actual death, but a scene that occurred immediately following physical death, that I witnessed as a youngster.

A Lady Who Drowned

—A young man, with his fiancé and his fiancée's mother, went up river in a motor boat. The river was swollen with recent rains, the current very swift, and partly or wholly submerged trees were occasionally to be encountered, as they were carried down by the water. Along in the afternoon the motor boat struck one of these snags and upset, throwing all three into the water. Neither of the women could swim, but the young man was an excellent swimmer. Probably trying to be save the mother, both he and the mother were drowned, but the girl, in spite of being unable to swim, and without knowing exactly how, got ashore.

So exhausted was she, by the time she regained consciousness, night was at hand. And it was around nine o'clock before she, in her wandering search for help, reached a farmhouse about a mile from the accident. There they immediately telephoned to town for help, and a searching party was quickly organized.

It was decided, and subsequently verified, that the young man was lodged in an exceptionally deep hole close below the scene of the accident. And it was the opinion of those familiar with the river that the body of the lady was also there; that, in fact, he had been drawn down in the locked embrace of the drowning woman, other- wise so good a swimmer would have saved himself.

The leader of the searching party, who was the most experienced in river-work, had on previous occasions had some experience with my "hunches," as he called them. Therefore, when just about mid- night I informed them the body of the woman was half a mile below, lodged against a sand-bar, he asked no questions, but commanded two other men to follow in a rowboat, and in the only launch at our disposal, we set off to the designated sand-bar with every confidence we should find the body.

The body was at the designated spot, and by the light of the lanterns we carried, was easily located in the shallow water. It was then decided to put it in the skiff, and that one of us should row this skiff down to the village, some two and a half miles below; while the launch should return with the others and the lanterns to try to locate the young man's body. I was the one chosen to take the body to the village.

There was no moon, but the night was cloudless, and the stars shone clearly; so that I had no difficulty, without artificial light, in keeping the channel and locating the familiar landing. The body lay in the bottom of the skiff, but although the silver cord apparently was severed—at least I did not notice it—the astral form of the woman, standing erect as in life, floated immediately above her head. This astral body accompanied the skiff thus until after I had made the landing.

Although, in physical life, I had not known her well, yet we had been acquainted; and the young man who had also drowned had attended the same school while I was there. I also had a speaking acquaintance with the daughter, who thus had lost her mother and her sweetheart.

It was this daughter about whom the mother was now so concerned. She realized the nature of the accident, and she had the impression that the young man had drowned. This latter distressed her greatly; but the thing that was dominant in her mind was her daughter. She was as yet dazed by the occurrence, and had made no adjustment to her new condition. She feared that the daughter also had been drowned, and was worrying about this, because of the cutting short of the life of one so dear to her who had every bright prospect. And if the daughter had not drowned, the loss of mother and sweetheart, as she thought, would be too much for her to bear.

Feeling, rather than actually hearing, these thoughts, as they revolved over and over confusedly in her mind, I spent the time while we were moving down stream to the village in explaining the whole situation to her, as I understood it, and in reassuring her that everything possible was being done for her daughter, and that worrying over the occurrence would only help to distress her daughter, as well as make her own new condition harder.

I do not know whether or not there were others present from the astral plane, as I rowed down the stream through the night, talking to this astral form of a departed mother. But I do know that when I tied the boat at the landing and went into the village to find the undertaker, that two other faint forms were with her. To me then they seemed spirits from some higher world, come to guide this good woman to her celestial home. And through our conversations she apparently had become reconciled, so that she now also could perceive them. They were talking to her, and she was listening, and as I climbed the bank and left them, I had the impression that very quickly she would relinquish the attractions of the physical body and go whithersoever they should guide her.

I relate this very vivid experience of my youth, not because it is in any way remarkable; but because it illustrates two things very clearly. It indicates that those who have just passed from the flesh have an unusually strong power to impress those remaining behind. This woman showed me where her body was. It happened that I was the one most easy thus to impress. And it illustrates the confusion people may be under who pass out amid unusual circumstances, and how talking to them earnestly, by some one who can contact them, may relieve the worry and bring a speedy adjustment to the new condition.

Perhaps a still more recent experience will be useful in indicating these same principles, and also how those just passed over may still do things for those remaining in the flesh.

A Man Who Had Heart Failure

—This was following 1929, during a year of great financial depression and unusual lack of employment. The head of a family who are close neighbors of ours passed out suddenly in the night of heart failure.

This man, who had a wife and two children, was a carpenter. We knew that he had not had steady work, but as he had been working some, and the family always previously had seemed well-to-do, we had no thought that they might be very hard pressed for money.

Yet about four o'clock of the second morning after his passing, my wife was awakened out of a sound sleep. This man stood before her, and when she spoke to him he said, "I want you to do me a favor. I want you to see that M. _____ and the kids have money to eat on."

He not only seemed anxious, but worried. So my wife at once replied, "I will go over to your house the first thing in the morning, and we will see they do not want for anything."

Upon hearing this, he seemed both relieved and pleased, and without saying more, disappeared.

Next morning, as promised, she went over to his home. His wife, when informed of what had transpired said when he died they had only fifty cents; but that her father, receiving a telegram announcing the death had thought she might need funds, and had at once telegraphed her money, so that she was really not at all in need.

There is no doubt that this man's thoughts of the evening preceding his sudden passing were largely occupied by how, with the meager sum at his disposal, he was going to provide for his family's welfare. He awakened in the night, in distress, and passed out in his wife's arms before help could be summoned.

After passing, he continued to worry about the circumstances of his family. Evidently he had been unable to get close enough to his wife, perhaps because of her grief, to know she had received financial assistance from her father. He was quite unaware that the family had been provided for. And being acquainted with us, it was quite natural for him to seek our aid. He was well aware of our occult beliefs, and shared some of them. And it was quite characteristic that he should come to my wife rather than to me; for in any little borrowing of tools or utensils, such as occurs among friendly neighbors, he never disturbed me at my writing, but all such transactions were with my wife.

The Actual Astral Birth

—Yet the incidents here related cannot be considered actual births into the next life. As far as related, they were deliveries, but full birth was not accomplished until somewhat later. For commonly, except in the natural method where consciousness is retained throughout, the individual after passing from the physical body falls asleep. In the case of the earth-bound soul this sleep does not take place until after the binding condition has been broken. With some the sleep may be of long duration, and with others of short duration. It may be only a momentary loss of consciousness. But in any case the individual moves in his astral form to the level and place where his new birth is to take place. This is not his later level and environment, but a point somewhere toward it, in a transitional region somewhat influenced by physical necessity vibrations and his still strong physical desires.

The moment when he awakens into consciousness after this sleep, or if sleep has not intervened, the moment when as a result of a conscious realization of what has happened the vibratory rates of his astral form cease sympathetic response to physical conditions and adjust themselves to the astral world, is the moment of his birth into the new life.

This birth into the next life is under astrological law, quite as much so as the birth into physical life. He does not awaken into this consciousness of the new plane and does not accomplish that complete adjustment to it which constitutes this birth, until the astrological vibratory rates correspond in their quality, harmony and discord with the various energies of the astral form he has built in human life. That is, even as at birth into the physical form, the planets map by their positions the organizations of energy of his total previous experiences that constitute his character at physical birth, so also other astrological forces map quite as fully his character, as organized within his finer form, as it has been constructed up to the time of his physical demise. He will not be born completely into the new life until this astrological relationship obtains.

Now I do not wish to imply that a map of the heavens set up for the moment of the person's physical death tells anything about his condition in the after-life; for, in the first place, this moment is not, as a rule, the same as his birth on the inner plane. Nor do I wish to imply that the progressed aspects as calculated from physical birth still continue to influence the individual even after he has passed to the next life. Nor is the birth-chart of the next-life such as can be calculated using the surface of the earth as a center, and the revolution of the earth on its axis as the measure of progressions, as we do in calculating progressions as influencing us on the physical plane.

As soon as we get any considerable distance from the earth plane we are uninfluenced by the rotation of the earth, and while throughout nature there are alternate periods of activity and rest, day and night as known on earth do not there exist.

Astrological Energies

—What I mean is that astrological forces continue to influence us in the next life just about as they do here. Only those who are astrological students know anything about this on the levels close to earth, just as only astrological students know anything about it on the earth. Nevertheless, on the entrance to the next life, the astral form undergoes an adjustment in which whatever experiences and thoughts have been added to it since physical birth are more markedly discernible in that form.

The person, according to the thoughts he has held and the deeds he has performed may, immediately after his new birth appear much younger or much older, better proportioned or worse proportioned, more beautiful or more ugly, larger or smaller, nicely attired or merely wrapped in rags. These manifestations of his outward appearance represent his character as developed to date and are mapped by the astrological conditions at the time of his new birth.

Furthermore, because astrological energies carry the throb of cosmic forces urging all toward evolution and progress, other energies of an astrological nature that correspond in their affect to the influence of progressed aspects in a physical birth-chart, are operative as environmental forces, and thus influence his life on the inner plane quite as much as the more familiar progressed aspects do on the physical plane.

This does not mean that they bring to him events such as are brought to him by progressed aspects on earth. On the higher levels the discords do not manifest in the sordid way they do on earth. They do not bring the loss, illness and sorrow; because these conditions have been left behind. But they do exert a pressure at times that is discordant. It is one of the great lessons both here and there to learn how to transmute discords into harmony. Discords do not have the same affect on the inner plane; but throughout nature there are both harmonies and discords as alternating influences. Yet they manifest differently on different levels.

For instance, what corresponds to a very adverse progressed planetary aspect in the astral birth-chart of a rather highly evolved soul may cause him to consider it his duty to descend on missionary work into the hells that are even below the level of the ordinary earth plane. He does not permit his sympathies to cause him suffering; but nevertheless, he contacts, of his own free desire, sordid and to him repulsive conditions, that he may lift others to a happier state.

Conditions of Next Life Birth

—Nowadays it is very seldom a child is born into physical life without there being someone present besides the mother to give assistance. Nor is the next plane less well provided in this respect. There are those whose occupation it is to assist in the birth of those who pass into that life, and who also assist the newborn individual to get his proper bearings. There are large organizations for doing this work, with well developed resources. There are other individuals who are free-lance workers. And some there are who travel unfrequented paths, go into the slums or into the wilderness, and give aid to those who enter this life there. Because of these various ones who engage in this work, it is really less likely for anyone to be born into the next life without attendance than it is into this one.

And the environments in which such births take place are quite as varied as those possible to imagine on earth. Whether high or low in the vertical scale depends largely upon the dominant vibration of the individual; and the kind of environment is largely determined by the stronger thoughts and desires. Yet when, as in the case of some great disaster, many individuals of varied tastes and moral qualities pass to the next plane together, or in the case of a whole company of soldiers wiped out at once in a war; it sometimes happens that the hospital corps, or emergency relief, of the other side, is able to use the collective vibratory rates and energy of the whole group to keep them together for awhile and usher them all to certain quarters that are prepared for them.

In such a case, these quarters with their appointments are on a level close to that of physical necessity, which is usually referred to as being close to earth, and the group vibration sustains all in them until after their birth, and until after they have grown somewhat accustomed to the changed conditions. Then each gravitates to his own level and the environment where his thoughts take him. That is, he moves as guided by his desires.

But the birth of those of mean disposition may not be in a nicely furnished sanatorium with fine buildings and elegant grounds and everything provided for the relaxation, comfort and amusement of those becoming adjusted to the new life. Instead, it may take place in the corner of a hovel, on a pile of rags. It may even take place in a forest, or out on barren slopes of rock. Such environments have an affinity for certain types of sordid thoughts. The individual is not compelled by anyone to be born in such a place, he determines the place of his birth by his own character. This law of affinity and correspondences is apparent even on the physical plane, and is inexorable on the inner ones.

Furthermore, in obedience to this same law, his features, his form, and even the garb in which he is thus born, express his inward characteristics. If he has, on earth, developed miserly traits, he will probably be smaller and shriveled. If he has been very licentious, this will show in the hideous leer of his countenance. If he has been vicious enough, he may even be crippled. But if his character as developed on earth is fine, his body will appear beautifully proportioned and his face may have the radiance ascribed commonly to an angel. If his thoughts have been somewhat sour he may appear older than when last seen on earth, but if his thoughts have retained elasticity and enthusiastic expectancy, even though the physical body was aged, he will have the appearance of being much younger than when he passed out.

Children, when born into astral life, are of the same size and usually not much changed in appearance, as when on earth. But they grow to maturity after their astral birth, and then present a mature form which corresponds in its lineaments with the inward character. On the inner plane the character shines through the outward form in a way that is unmistakable.

But wherever and whenever the individual is born into astral life, it is but a short time usually until someone comes along, if not already there, who is willing to help him. Not that anyone can bear his burdens for him. Or make a vicarious spiritual progress. Each is the arbiter of his own destiny. But there are those on the inner plane who make it their business to act as guides and to give advice to the newly arrived. Usually such are present at the new birth to assist in it and in the subsequent adjustment.

The individual who thus awakens into astral life may, or may not, be willing to take the advice or even listen to, these guides. If he has a fixed idea that he is going to a heaven paved with gold, about as soon as he is born on the inner plane he moves in search of such a place and is quickly attracted to such a thought-form environment built by others of like faith. Here he may reside for a long time, if his faith is unwavering, before some missionary of the real truth is able to reach his consciousness and jar him into a realization that this is merely an artificially created erroneous environment. Then his real advancement begins.

Those without such fixed convictions of how things must be, start their progression sooner. But this progression, if they have been very wicked in the real sense of finding joy in the suffering of others, and being viciously selfish, must begin at a basic level even below the common level of earth, and in environments that are distressing, indeed.

After birth on the next plane and the transitory period of adjustment has been finished in a temporary realm, rest home, or other environment, the individual is pulled down by the grossness of his essential vibratory rates to a level below, or is lifted up by them to a spiritual level above. He finds his own real moral level as surely as the surface of water seeks its level on the face of the earth.

The strong thoughts and desires, further, attract him to an environment corresponding to their nature. If they are warlike, he is attracted to a place where there is strife. If they are greedy, he moves among greedy companions, where the weight of his body and possessions seem unbearable. The after-life is quite dissimilar to earth life in that those of like tastes herd together, and those of different inclinations do not intermingle.

Nothing other than his own inclinations keeps the individual on the level where he thus finds himself, or amid the surroundings. He is not ordered to go there by any person, or by any supernatural being. He goes there because of the law of affinity. And he can move himself to any environment that he can cultivate a strong enough desire for, that will offset the desires and thoughts already organized that hold him where he now is.

Nor does he have to remain on the level, or plane, where he now finds himself. But he cannot ascend to any level that has a vibratory rate higher than his own. If he would live on a spiritual level he must cultivate spiritual qualities, so that his dominant vibratory rates will be spiritual. And there are ministers, or teachers, who visit all realms, more than willing to instruct the inhabitants how to raise their vibratory rates, how to live better lives, and rise into better conditions.

But even as on earth, teachers of spiritual things cannot force their great truths down the unwilling throats of all they meet. They are ever ready to dispense wisdom; but they cannot compel others to accept it. Advancement in the astral realm after death of the physical body, even as here, depends upon willingness and effort.

Chapter 4

Serial No. 176
Original Copyright 1942
Elbert Benjamine

Copyright
Church of Light
August 2002

Astrological Influences in the Next Life

Chapter 4

Astrological Influences in the Next Life

AFTER birth on the next plane, and a certain preliminary experience of adjustment in some situation not too far removed from earth vibrations, the individual moves to the vibratory level that corresponds to his character, and assumes certain responsibilities. And just as in earth life his reactions to the events which he contacts form his character, and this character thus built attracts events of corresponding quality, so also in the next life, and with even greater rapidity, the thoughts, aspirations, and actions engendered by responses to conditions, through altering the character, attract the individual to conditions that in quality correspond to them.

On earth we are born with thought-cells already organized by our impersonal experiences in lower forms of life. These thought-cells, which are mapped by the planetary positions at our birth, are of certain families, or types, each possessing a different volume, and subject to either harmonious or discordant organization. The events of our physical life are those that have the same vibratory quality as these thought-cells. These events are attracted by the inner-plane work of the thought-cells within the finer forms that comprise the character; the sum total of all past experiences thus recorded in the finer forms, up to any particular time, being the soul.

But as events are attracted after physical birth, or as events are attracted after birth into the next life, the experiences with these events add their energy to the thought-cells within the finer bodies, altering thus both the soul and the finer bodies. And as a result of this change in character, other events are attracted having the same vibratory quality as this new character; that is, corresponding to the new state of development of the soul. The same law holds on all planes: We attract conditions that correspond to our inner vibratory rates.

The thought-cells within the finer forms that constitute his character, and therefore determine his new condition, when he is born into the next life, are derived from the sum total of an individual's experiences up to the time of his physical death.

His new birth-chart as calculated on the astral plane, but not represented accurately by any physical birthchart, may be much more fortunate, or much less fortunate, than the one with which he was born into physical life. This depends entirely upon what use he has made of his opportunities while on the material plane. And because there is here a higher velocity, the character qualities act far more quickly in determining his

condition than they do on earth. Yet in spite of terrific discords that attract tragic events, the individual may possess a dominant rate that is highly spiritual. These discords are not dissipated merely through passing to the next plane. But in this next life there is a vertical dimension and, taking both his harmonies and discords with him, the spiritual individual will rise to a high level of life, to a level of vibratory rates that corresponds in frequency to his spiritual nature.

Children are with increasing frequency born into physical life in hospitals especially prepared for their arrival. Here they remain some days, with their mothers, under special medical care and attended by nurses. So also on the inner plane, there are many kinds of places prepared for taking care of the new arrivals until they become adjusted to the new life. Some of these places are fitted so elaborately that long descriptions would be required to give even a slight idea of them. And they vary greatly in their appointments.

Immediately after passing over, not only is the individual apt to be a little confused, unless he has a very thorough understanding of the after-life before passing; but he may find himself somewhat weak.

First Adjustment to Next Life

—He may awaken from the sleep of passing on a fine grassy sward, in a balmy climate, surrounded by glorious beds of flowers, and with birds singing happily from the boughs overhead. This may be within grounds where are to be seen large buildings of magnificent architectural design, buildings which, as he grows stronger, he will visit museums where are displayed models of the things that exist on the levels of that inner life; and lecture halls where, if he desires, he can attend lectures.

He will find also dining rooms, and recreation grounds where he can engage in sport and, for the time being, follow almost any endeavor that he was interested in on earth. He can even go hunting, although the game he shoots will be merely dummies. And he can eat the things he was accustomed to eat on earth, except that what appears to be meat is not real flesh food, but an artificial preparation to simulate it. Such places, fitted up for the reception of new arrivals, are of great variety; but the chief end sought is to furnish the transient visitor with everything that will assist him to acclimate himself to the new condition without shock.

Nor must it be thought that all arrive on the next plane amid such luxurious conditions. Those who have lived low and vicious lives more frequently cannot be stopped in their vertical plunge to lower levels, even temporarily in such a hospitable realm. Instead, they drop through to another level below, where they are born and make the temporary adjustment; before losing the vibration of physical necessity to such an extent that they gravitate to a still lower plane that is of their own dominant vibratory rate.

But wherever the individual is born into the next life, either awaiting his arrival, or coming to him rather shortly after, there is sure to be someone who will help him in his readjustment if he will permit it. Furthermore, this place of birth, as a rule is merely a temporary place of residence; and as soon as the adjustment takes place he moves out of it, and goes to his own level, and to conditions such as are attracted by his habitual desires. He does not remain in the hospital and its surroundings where he had his birth. It has served its purpose, and he must strike out to accomplish his new destiny.

When he arrives in this next life, because his astral body is a duplicate of the physical, he has a heart, stomach, lungs, liver, and all the other organs which we associate with the physical life of man. And because of habit, he still requires food, and may even feel the need of sleep. Even when in the course of his development he moves to higher and higher levels, and finally out of the astral velocity realm into the spiritual higher velocity world, he does not lose the functions represented by these vital organs. Although the gross organs are no longer present in the more exalted body, nutrition, circulation, vitalization, continue to be performed even in that more exalted sphere of existence, but by means of spiritual functions that correspond to the physical organs of material existence.

Visiting Loved Ones On Earth

—During the period of adjustment right after birth into the new life there is not uncommonly felt a great longing to go back to visit the loved ones left on earth. The person, sometimes, will not accept the statement of the nurse in charge of him that he is physically dead. He still has hands and feet, still has a hearty appetite, still has all the desires of his previous life; and the things about him, while some seem strange, are nevertheless quite as solid to his touch, and quite as substantial when he moves them about, as such things on earth. So he retains a doubt that he has passed from physical life.

To enable him to realize his condition, and because his desires draw him in that direction so strongly, his nurse may go with him on a visit to his friends and relatives. He goes back to his old home, perhaps, and if his vibratory level as yet is not far removed from that of physical necessity, he may see his wife, his mother, or his sweetheart quite as plainly as he ever did. It is only when he speaks to such a loved one and no attention is paid to him, and when he touches someone and the other is unaware of his presence, and when he passes before the eyes of those there gathered and it is obvious that they do not see him, that he becomes completely convinced.

Sorrowing For Those Who Have Passed

—And this may be an exceedingly sorrowful experience to him, not merely because he cannot make his presence known: but because those who have been left behind may be grieving for him. They may weep and sorrow and, thinking thus strongly of him, their grief stricken thoughts reach him with full intensity. He feels, because he is actually being given a mental treatment with these thoughts, all that they feel while they think of him. Their sorrow causes him agonies of distress, yet try as he may, he cannot relieve it.

Even after he gives up in despair, and goes to take up the duties of his new life, their recurring thoughts of sorrow are able to penetrate to him because of the bond of sympathy. They are mental treatments—as much so as if given by a Christian Scientist Practitioner, a Metaphysical Healer, or a New Thought Demonstrator, to one still in the flesh—and they do their work. They not only cause him to feel all the distress experienced by the loved ones in the flesh who are in this manner thinking of him, but they disturb him in performing his work on the inner plane, and if there is sufficient responsiveness between himself and the ones on earth who cannot reconcile themselves to his passing, they may hold him so close to earth as effectually to retard his progress.

If people only knew it, when the thought of a loved one who has passed over flashes, apparently without cause, into the mind, they have the power to give that loved one assistance. In the sense that the loved one has tuned in temporarily on the same station that their astral body is tuned to, the loved one, when such thoughts thus come, is usually close at hand. Not close physically, because closeness in the next life is that of radio closeness. Thoughts at these times especially, and to a somewhat less extent always, about the loved one reach and influence him.

Grief over the physical death of a loved one usually is mostly the expression of self-pity. The one grieving seldom believes that the loved one has gone to a region where he is worse off. He thinks principally of the effect upon himself of the parting. He grieves mostly because he is apparently worse off, through the going of the one he loved, to a foreign land. Yet were the love both unselfish and intelligent he would not grieve at the departure of the loved one to a foreign country if he were convinced the loved one would have much greater advantages there.

And if the love were both unselfish and intelligent, instead of sending the loved one messages, one after another, that would be sure to depress, discourage, and hinder him in his important work in that new land, the one left behind would be as courageous as possible, forget the selfish sentiment of personal loss, and put forth some effort to make the departed one's life easier and brighter.

Help From Those Who Have Passed

—Friends and loved ones who go to the next phase of life frequently return, by way of across-level radio-like thought-transference, to give us hints of helpfulness. Thoughts which envisage a person, have a singular power to reach that person, even across the levels. The thought raises or lowers the rate of the outward projected message to the vibratory level of the person thought about unless there is too great a difference in the levels occupied by the persons. Of course, only as the thought attains the proper level, does it penetrate a given plane. But such temporary tuning of the mind is capable of wide latitude. Thus, we often receive as slight impressions, information and impulses from those interested in us that now sojourn in that other land.

Not only unconsciously do they thus help us; and in some instances hinder; but we, by our thoughts, can cheer and assist them. Instead of mourning their going, and casting the shadow of gloom over their afterlife existence, we can think of them as happy in their new estate. We can offer them encouragement wherever they are. While on this earth, whether we are conscious of it or not, we give our associates mental treatments. And when we think of those who have passed on, and are now taking up new duties in another land, let us realize that we are sending them potent mental messages. And let us drop self-pity and self-interest, at least for the moment, and send them buoyant wishes for joyous living, for uplifting ambition, and for spiritual success.

Those Who Await Us

—In this adjustment period immediately after birth into the next life, either because he has a strong desire to see them, or because the nurse thinks this is the most effectual way of causing him to realize that he has now left the physical plane, the new arrival not infrequently is taken into the presence of those of his acquaintance who have passed to this plane before him. Of course, some loved one often awaits his arrival. But even otherwise he may be guided by his nurse into the presence of someone of whom he was particularly fond. From this one he may be much more ready to receive an explanation of where he is and what his new surroundings are like.

A mother may be led to where her child, who has passed over ahead of her, now attends school. And the child may take great joy in telling his mother all about the new surroundings. Or a mother may await her child, and take up his training here. Or a wife or a husband may be led to the marriage partner who has preceded, and find his explanations and guidance a pleasant introduction into this new condition of existence. It is not so different, in many respects, from the immigrants who come to our shore, speaking, perhaps, almost no words of our language, yet met by relatives who have preceded them from their own country, and who take joy in showing them the sights and telling them all about this land of America.

Those We Have Favored Or Injured On Earth

—And right here is the appropriate place to explain that in the after life there is a tendency for us to be brought again into contact with those whose lives on the earth plane we have markedly influenced, or who have markedly influenced our lives. This is not simply that because our paths once have crossed they must cross again. It is because there remains within our mind a potent thought-image of such persons; and a thought-image which is potently associated with desire, has a power to draw us into contact with the thing or person thus visualized.

Even though some person has influenced our life greatly, or we theirs, either through injury or favor, it may be before leaving the earth plane both feel that the matter is satisfactorily adjusted. This adjustment may not be entirely personal; for one may have made effort to be helpful to society at large in such a measure as enables him to feel that his personal debt has been discharged. The experience resulting from the contact with the other person thus may be drained of its emotional elements. A balance has been struck, the account between these two individuals has been closed. And both feeling this, they may never meet each other after passing from earth life.

But where, due to injury while on earth, one holds an attitude of deep resentment toward the other; or where, because of unjust actions, one feels that he has deeply wronged another; the potency of the thought-image tends, sooner or later, to draw these two again together. Thus, not only love, but hate, remorse, great gratitude, or other strong emotion associated with the image of another, tends to cause the individual in that after life to come into the presence of the one so strongly thought about.

This is no new law. It is the operation of the same principle we constantly emphasize in regard to thinking on the earth. Whatever we think about strongly we tend to attract. If, near the edge of a cliff, we visualize strongly that we are falling over, we shall thus take the plunge. That is why some people feel an almost irresistible impulse to leap, when they find themselves on some very high place. It is because their imagination envisions the horror of falling.

Judgment Day

—But when we pass to the next life we stand before the judge, who is ourself. The records, not only of our actions, but our motives for these actions, are plainly before us. And they are plainly in view of others also. We cannot there hide our insincerity; for whatever goes on within is plain to be read by all who have made any degree of progress above the lowest levels. Yet others do not pass judgment upon us; it is we who pass judgment upon ourselves.

We perceive wherein we have erred, and why we have erred, and we realize that our progress, the level we are to occupy, and the environment we attract, depend upon the state of our character. And one way to remedy defects in character is through doing what we can to help those we have wronged. If they no longer need such help from us, we, at least, can balance the score by being helpful to someone who does need it.

It will be seen, therefore, that while it is not imperative that mistakes should be rectified through contact with those who suffered by them, yet because of the thought-image of the wronged individual lingering in the consciousness, or even because of revenge thoughts linked to such an image, rather frequently such individuals are again, in time, on some plane brought together.

There is nothing here to suggest an “eye for an eye, a tooth for a tooth,” doctrine. Nor is it parallel to the karma doctrine of some, by which one who suffers an injury from one person on earth, in another earth life is given the exquisite joy of committing the same injury against the first person, thus balancing scores.

On the other hand, if the one who was injured needs help, that help is given, providing it is within the power of the aggressor to give it. But in any case, if the injured one is to advance, he must lose all thought of revenge and desire for retaliation. He must feel that it is a privilege to forgive, and he must wish his injurer joy and happiness. He must help the one who injured him to discharge his obligation in such a way, and as quickly as possible, as will enable both to profit by the earlier error. The welfare and progress of the whole of creation is the motive behind all such balancing of accounts, and one who demands an “eye for an eye, and a tooth for a tooth,” must remain, because of the attractive power of such thoughts, within the dark foggy levels close to physical necessity until he gets a more enlightened and generous viewpoint.

Astral Light

—As we recede from earth, night and day, as we know it here, no longer have an existence. They are due to the rotation of the earth on its axis, and those not immediately associated with the material plane, are unaffected by it. Nor is there sunlight, which is a narrow band in the electromagnetic spectrum, because electromagnetism belongs to the Boundary-Line velocity region, between the velocities of the astral world and the velocities of the physical world.

In radio it is still customary to speak of ether waves as the carriers of the broadcasting energy. But there is a tendency on the part of scientists to consider such waves as properties of fields in space under certain conditions. There is no general agreement at present as to what electromagnetic waves, including those of light, are. We do now know that matter is energy concentrated in a certain manner, and that energy has mass. It appears, therefore, that as energy has mass, and mass is the common property which we think of as belonging to substance, even if we do away with the ether and think of electromagnetic waves as properties of space that develop under certain conditions, as these waves possess energy we are privileged to think of them as Boundary-Line substance.

But whether it is called substance or merely energy does not affect its observed properties; nor whether we speak of astral substance or call it astral energy, are the properties of the astral world changed, which derive from the higher-than-light velocities of that region. And the spiritual world possesses still other properties that are consistent with velocities which are still above the astral, whether we call it substance, or energy, or motions in space, or lines of force that constitute a field, or by some other designation derived from as yet to be developed conceptions of the nature of energy and form.

This astral light, which in some degree and color permeates the whole astral world, when not clouded with thought elements, is of a singular purity and beauty; soft, yet penetrating and brilliant, as anyone can testify who has seen it clairvoyantly. It is a pervasive light, but subject to an incredible amount of variation in shades of color. When unmodified it is a silvery white, somewhat like the light from the blue-white stars, except that it has no such quality of hardness.

Again Contacting The Earth

—Those who have passed to the next world and are accustomed to the astral light of a level even a little higher than that of physical necessity, when they re-enter the plane, or vibratory level, of the astral environment of physical necessity, and come in contact with the electromagnetic-astral belt of earth feel as if they were entering a mist or fog. The turmoil, strife, selfishness, ignorance, and general thought quality

immediately associated with our physical sphere creates an electromagnetic atmosphere that is almost like a dark miasmatic wall to spiritual entities who come here. It is difficult for them to penetrate it, and they find breathing, that is, their vitalizing process, obstructed. Except to contact someone on the physical plane who has within himself a spiritual quality, spiritual beings can only penetrate to the earth after undergoing special preparation.

Where, however, there is a person yet in the flesh who has made considerable real spiritual advancement, there is a spiritual light which penetrates the darkness by which he is otherwise surrounded. To the extent he has built up a spiritual body, through the processes which are described in the lessons on spiritual alchemy and cosmic alchemy, he affects spiritual substance. He thus radiates an energy of spiritual quality, and this is readily seen by those of the spiritual world. In spite, therefore, of the miasmatic fog of his earthly surroundings, spiritual beings perceive him clearly by the radiance of his own light, and they are able to come close to him, in the radio sense of tuning in on his vibratory rate.

Under-Spheres

—The physical necessity or earth level is by no means the lowest. There is no hell in the meaning of the word usually employed. There is no place where the wicked are condemned to spend an eternity in torture. But there are vibratory levels far below that commonly encountered on earth where by the inherent attractive power of their own viciousness those of especial depravity congregate. They descend to such regions because these regions have the same general quality as their thoughts and desires. Nor do they enjoy themselves there, no more so than people really enjoy themselves in great wickedness upon the earth. But they are not condemned to remain in these regions; for when their thoughts and desires turn toward better things they, by that token, begin the struggle upward.

In these lower levels even the ordinary astral light has little power to illuminate. They are cloudy, gloomy regions, lit in spots by the lurid flares artificially constructed by their benighted and sodden inhabitants. Such vegetation as exists seems to be obnoxious fungi. There are in some of these lands bleak stretches of smooth bare rock of a greenish-pink color. Other regions, in their desolation, look much like the pictures of shell-swept no-man's-land. And such animal life as here may be found is of the most repulsive nature.

But people are not compelled to live in these regions. If they do so it is because they refuse to be guided higher. They prefer to remain in a domain where brute strength and animal desires constitute the general law. If there is torture, it is the inhabitants of these regions who perform it, not some higher being or infernal devil. If they gloat in the torture of others, perhaps they also, at times, shall be the victims. No one can compel them to abandon their hellish existence. But if they desire something more spiritual than this indescribable existence, that desire, beginning the reconstruction of their character, starts them on the gradual climb toward brighter things.

Those who visit these lower regions, these hellworlds of the astral plane, must undergo training for such missionary work. They must learn how, by various devices, to overcome the difficulty of breathing and seeing in these regions, and how to prevent injury from the malicious creatures that there dwell. The first strong wish for better things in one who has fallen so low, sets up a vibration of higher frequency than the region where he dwells, and penetrates it as a more or less faint light. These missionaries are ever alert to discern such lights that they may give helpful advice to those who would work their way out of these sordid lands.

But whether it is these lowly creatures of the under-spheres, or an exalted spirit of the higher astral realm, whenever he tries to move to a level above his own dominant vibratory rate, he experiences a peculiar difficulty. There may even be a bridge thrown across the vibratory chasm by those living on the higher plane to make his approach easy and gradual. Yet when he begins to get into a vibratory atmosphere too high for him he commences to feel faint. It is as if he could not get sufficient oxygen. He feels very much like the mountain climber does who reaches an altitude above his lung-power. Exertion, even in a small way, causes exhaustion. He feels dizzy. And if he gets too high he may lose consciousness.

By training, and through artificial means, one can visit temporarily a level either far above or far below one's own vibratory rate. But to sustain life there any length of time is altogether too difficult. Automatically, when one's forces are spent in such an effort, one drops back to one's own basic level.

Remember that these levels are each as concrete, hard, real, and vivid as the low-velocity region now experienced on earth. In fact many are so much more so that one who has had experiences only on the physical plane cannot imagine it. Yet they are like radio programs each belonging to its own wave-length and frequency. The individual gets the program to which his dominant rate is tuned. Unless he can turn the dial of his consciousness to other basic rates he knows nothing of what is going on there. And unless he can tune up, or down, his own character rate, so that his body vibrates also to the higher or lower rate, he cannot move about and have his existence on such levels.

I have spoken here of a disagreeable side of the next life. This disagreeable side is minute in extent compared with the beautiful and pleasant side. Nor have I spoken of it to put the fear of hell into the mind of anyone. On the contrary, there is no hell except that created by the individual's own character. If he is a devil right now, merely passing to the next plane does not change him into an angel. If he is a devil in his character, desires and disposition, no one can compel him to become anything different. When he passes to the next life he merely moves to a region suitable to the expression of the qualities which he has developed.

On earth he may be a devil, yet consort with those of angelic disposition. But not so on the next plane. Those of like character, like ambitions and desires, are attracted to a similar environment, and have the pleasure of each other's company. There is no hell lower, more cruel, or more vicious than the thought-quality of those who inhabit it. Such a lower region is not created by God or by the devil. It is created by the thought-building power of those who move into it. And if they do not like it, they have the privilege of moving out by the expedient of building characters that fit them for a different realm.

Character Attracts Environment

—While we are upon the earth, if we have within us powerful discordant thought-cells that attract us to a similar environment, no amount of information will enable us to escape misery and perhaps disaster. Men of the highest intelligence and ability are overtaken by fire, by flood, by financial panics, by accidents and a variety of other misfortunes. Information alone if they enter environments that correspond to discords within themselves, is not sufficient to prevent catastrophe. Yet the intelligent man, who has abundant information about the place, or business, or industry wherein he finds himself, has a great advantage over one who is ignorant of the first principles of such phases of life.

If, in a man's birth-chart are found violent aspects such as indicate violent thought-cells built within himself, he may not escape severe accident on a hazardous trip of exploration into the arctic even though he is unusually well informed on the conditions he must meet. But he certainly will get along better than another who has no knowledge of arctic conditions and how to meet them. Whatever foreign land we expect to travel in, we will get along far better if we have as complete information as possible about the climate, the laws, and the customs of the people of that land.

Nor will information about the land where man dwells after physical death prevent anyone from gravitating to the level corresponding to his dominant vibratory rate.

Nor will it prevent him from being attracted to environmental conditions in that world that correspond to his strong thoughts and desires. Furthermore, in spite of any amount of information he may have, his appearance to others will portray his true character. Even

the clothing he wears, strange as it may seem, has a correspondence to his thoughts. In fact, it is really built by his thoughts.

People do not go about nude in the after life. At first they wear clothing very much the same as that worn on earth. But the person of vulgar tendencies will find himself vulgarly dressed. The one who is miserly and hard will find himself in shabby, even tattered, attire. And the licentious individual will be seen clad in soiled apparel. On the contrary, those of more kindly thought attract about them finer garments. Robes of dazzling beauty clothe those of spiritual worth, or their raiments are of different modes, blending colors and designs in the most exquisite way. Even here on earth the tastes of people are somewhat displayed in their choice of garments; and on the inner plane both the calling and the inner character are thus rather clearly symbolized.

Information about the conditions apt to be met on the inner planes will not change the astral environment in which one finds himself: but it does help him vastly to adjust himself to those conditions. If he finds himself in a place, or on a plane, that he does not like, he will have some idea of why he is there and how to get where he wants to go. Either high or low, it is a decided advantage to him to know before he reaches that land, what the inhabitants are like, and how he should treat them. If he knows beforehand that wherever he finds himself is due to his own inward character, he will not wander about in a daze because the place he finds himself is so different from the orthodox teachings. Nor is he apt to remain content long within the tepid thought-built regions of an artificial heaven. He will realize quickly, because his previous teachings have emphasized the necessity of the use of discrimination on every plane, that certain things he sees are artificial, and that others are in the path of natural progression.

Information Gives An Advantage

—One who passes to the next life with a rather clear idea of the conditions there to be encountered is fitted to take up his life there; but one who goes over without such knowledge must begin with the very kindergarten; and the most difficult task of all with some is to unlearn what they thought they knew. On that side, even as on this, if a person is determined to believe black is white, no one can compel him to alter his opinion. There are those on both sides who narrow their minds to some fixed idea, and then, instead of perceiving reality as normal individuals do, will see nothing that fails to conform fully to this idea.

We should understand, both in this life and in the next, that the conditions by which we are surrounded are due to the work of the thought-cells within our finer body which have been thus organized by our past experiences. These organizations of energy are changed by our thoughts and desires, and as they are thus changed attract to us new and corresponding events. The same law runs through the physical existence, the astral existence, and the spiritual existence as an unbroken chain of action and reaction. Right now we are living under that law and we will still live in obedience to it in realms far above our present power to imagine.

Astrological Influences

—And in the next life, as well as in this one, an ever changing part of our environment are astrological forces. Even after we have left the earth, tides of finer energy will beat against our new form, stimulating it to certain types of feeling and consequent action. There will be influxes of force that correspond to the oppositions and squares of our earthly progressed horoscope, and there will be at other times, influences that correspond to the sextiles and trines.

These astrological forces afford nature the assurance that there shall be no stagnation. They sweep the universe along in the direction contemplated in the divine plan. They are the expression of the deific will and the deific intelligence. They are not compelling forces. They are expressions of the tides of the omnipotent mind that reach poor lowly mortals struggling here on earth as planetary progressions, and reach angelic hierarchies in realms far above any spiritual state we can conceive, as signals of ineffable love and wisdom.

The squares and oppositions, and their corresponding influences in the next life, are testing forces that properly used enable us to build strength, initiative, resistance, determination and faith. Instead of permitting us to slumber peacefully wherever we may be, they bring a pressure to bear that arouses an inner thought-cell disturbance. Such thought-cell disturbance engenders a desire and determination to do something. We resolve to escape from the condition the discords within ourselves, thus stimulated, have attracted. Some pain may be necessary before we arouse to struggle; and even though we struggle, so long as the discords within last, it is unlikely we will much better our environment.

Yet even when pelted with discord from without by our own thoughts we have a power to engender harmony from within. And to the extent we are able to do this we will surely attract more pleasant conditions from without. Also, in spite of discords, by our attitudes toward events, as explained in spiritual alchemy, we can build within ourselves, either in earthly life or after physical death, more spiritual vibratory rates which will lift us to higher planes of existence.

Trines and Sextiles

—All life, however, is not a continuation of receiving harsh astrological influences. There comes a period when there are sextiles or trines here, or their equivalent in the life to come. These are the times when we move forward rapidly, not in the development of strength of character, but in using whatever strength, initiative, determination, and resistance we have developed in times of stress to take advantage of favorable opportunities. Under these influxes the harmonies which we have added to our characters are stimulated and intensified by similar influxes of energy from without. This attracts to us conditions that are unusually advantageous for accomplishing something in the world outside of ourselves. For effort expended, and for a given amount of character, the external results at such times compensate in full measure.

Oppositions and Squares

—The times of squares and oppositions of this life, and the similar influences in the next, are the times when, through the struggles they impose to hold one's own physically, mentally, and spiritually, the greatest inward development may be had. When there is discord without, it is fine training to try to maintain harmony within. When all goes wrong, it is the best of discipline to endeavor strenuously to retain courage. When losses take place, there is opportunity to test one's ability to carry on. Such buffets of fate are like the severe grillings given a training athlete. Without them the character tends to remain soft and weak.

But when the sextiles and trines come into this life, and the similar influences in the next, the environment outside oneself is more easily made to yield. Responsibilities are attracted that can be carried. There is a character development here also, but it is developed to a greater extent through outside accomplishment. The athlete who has undergone severe training now enters upon his more public performance. The grinding strain of his training may have been a far greater accomplishment to him; but as it affects the outside world, the environment where he now is, on this plane or some other, what he can do under these sextiles and trines seems more important. Where before he apparently stood still, now he moves forward in a manner to be marked by all.

Astrological harmonies and astrological discords influence the life of man in this life and the life of man in the next. Their somewhat alternate occurrence is some insurance against stagnation. They stimulate trains of thought; and these eventuate as action, and attract corresponding environments.

The Road to Progress

—Thus not only on earth, but in the next life, astrology, to one who knows what planetary positions map, and how they operate, affords the best possible road map to progress. But to be most effectively used there must be an understanding of just what the astrological positions indicate and what they do not indicate. As has been amply proven in reference to life on earth by the Brotherhood of Light Astrological Research Department in the analysis of Case Histories of Identical Twins, Natural Twins and Astrological Twins having almost identical birth-charts, and what happened in their lives under practically identical progressed aspects, astrological positions in the birth-chart do not map specific events. They do, however, map predispositions toward the types of conditions and events which will affect each of the twelve departments of the individual's life. And this is what the positions in the chart of birth into the next life also map.

These Case History Studies also prove that progressed aspects do not map specific events. Instead they-and those astrological influxes on the inner plane that correspond in that region to progressed aspects on earth-map energy releases of definite types during limited periods of time which can be predetermined. These energies, during such periods of release, expend themselves in the work of bringing into the life conditions and events of their particular type, harmony or discord, and relating to one or more of the departments of life with which they are associated as revealed by the houses ruled by the planets mapping the energies released.

What the thought-cells bring into the life when they receive additional energy from a progressed aspect, or what corresponds in the next life to a progressed aspect depends on the evolutionary level of the individual, the way the thought-cells have been conditioned to act previous to birth as revealed by the birth-chart, other planetary energies received at the time from progressed aspects, the additional conditioning the thought-cells have received since birth, and the environment of the individual at the time.

In the next life, and in the earth life, astrological energies are only a part of the environment. They are environmental influences that, at definite times which can be predetermined, add energy to given groups of thought-cells within the soul. But what these thought-cells try to do when they get this additional energy is not determined by the planetary energies, but primarily by the way these thought-cells have been conditioned. If they have been trained, through the individual's proper attitude toward the events which happen to him, only to work for those events which are beneficial to the individual and forward his plans, no amount of discordant planetary energy added to them will change this habit.

Now on earth we consider that under a progressed aspect to any planet the life is sure to be affected in some measure by at least three things characteristic of that planet. Also that the department of life affected by the thought-cell activity is sure to be indicated by a house which one of the planets involved in the aspect rules.

But beyond this our Case History studies show that what happens is determined not merely by the thought-cell organization mapped in the birth-chart, but by this birth-chart organization as modified by events and attitudes subsequent to birth, and as finding opportunity to express in the physical environment. That is, the same child raised under different conditions will have a markedly different fortune. And the same adult, in this life or the next, if he deliberately trains his thought-cells to find pleasure in certain actions and to have a distaste for other actions, will have a markedly different fortune.

Furthermore, the same individual, if he deliberately selects a different environment, even though the thought-cells have not been changed in their desires, will have quite different events than if he had remained in the original environment; for the events that happen are due not exclusively to the activity of the thought-cells, but to these thought-cell activities operating upon the external environment. If the environment resists one kind of event and facilitates another kind, especially if both are of the general type related to the thought-cells then active, the event that occurs will be much more likely to be the one for which the environment affords special facilities.

The thought-cell activity mapped either in the birthchart or by progressed aspects, in this life and in the next, influences the behavior through stimulating trains of thought which are characteristic of the planets involved, and it influences the events which are attracted through environmental factors which also are characteristic of the planets involved. But the individual who has the knowledge and intelligence to plan his life most effectively, can cultivate trains of thought related to each such group of thought-cells that will tend to give these thought-cells ample opportunity to express, but at the same time give them the desire to express their energy in attracting events which are beneficial to the individual. And to assist these thought-cells thus to express in beneficial events instead of those detrimental, an environment may be selected which will afford special facilities for such beneficial events, and offer great resistance to events of the same planetary type which are detrimental.

On any plane the effective road to progress demands that the individual from a study of his chart shall learn what are his natural aptitudes, and how they may be utilized to get what he wants from life, not only to advance his own interests, but to contribute his utmost to society. And to accomplish what he wishes, he must integrate the various groups of thought-cells within his finer form so that all the factors work, not at diverse purposes, but harmoniously together to bring about the things he has set his heart upon.

And to get these thought-cell groups, some of which contend with other groups and have desires at variance with his own, to work together for the purposes he desires, he must make them feel differently. This he accomplishes, whether he is still on earth or has passed to the next life, by cultivating, relative to the things they are associated with, harmonious emotions. Progressed aspects, of whatever nature, afford opportunity to determine how successful he has been in giving his thought-cells the desires he has decided they should have.

Chapter 5

Serial No. 177
Original Copyright 1942
Elbert Benjamine

Copyright
Church of Light
August 2002

Occupations of the Next Life

Chapter 5

Occupations of the Next Life

WHEN you pass to the next life, as you surely will at the appointed time, it will be greatly to your advantage to have a clear conception of what is there required to enable you to lead a successful and happy existence. With such information arranged in orderly fashion in your mind before the day of passing, you will not go about, for some time, in the next state in a muddled condition. A certain amount of preliminary education is necessary before you can take up active duties in a world which, while in so many respects resembling the physical, due to its high velocities possesses a different order of time and is unaffected by gravitation, in which distances are measured by vibratory frequency, where thought is a chief source of power, and where money has no value. And it facilitates adjustment to that world if that preliminary education is acquired before leaving the physical realm.

Although you will find people, and houses, and trees, and animals much the same in that after-world as you find them here; you will find many customs that are distinctly different. And you should be informed about these customs, so that you will not make things difficult for yourself by disregarding them.

Currency In the Next Life

—The first of these customs I should discuss, because life on earth as now lived is so inseparably bound up with it, is the use of money. There are regions, to be sure, in the after life, where money exists. But not in the realms where you will desire to go. It exists only in those lower realms where the miserly and greedy gravitate, and even there it possesses no real value. On the contrary, it merely binds these poor souls, who are dominated by the image of it, to those dull and dreary nether worlds. So long as they are unable to perceive the value of motives other than profit, they are chained by their own desires to this astral gold. They fight and scramble and struggle among themselves, in what might be termed financial hells, for possessions that have no real purchasing power whatever.

Therefore, one of the first things to realize about the after-life is that money has no power to buy anything there, and the next thing of importance is to realize that any action prompted solely by a selfish motive is not rewarded by real gain. Because the profit motive is so customary in the transactions of life on earth, it may be a little difficult to realize that the interchanges of the next life, except in the lower regions where the grossly selfish move, are entirely separated from this motive of profit and personal gain.

People are just as ambitious after they pass to the new existence as they were while on earth, but that ambition, except in the darker spheres, is not to gain something at the expense of another. They still desire to “be somebody,” still desire, and quite as strongly, to do something worth while. Noteworthy performance is not, by any manner of means, frowned upon. But the only kind of performance that gains honor is doing something that benefits, in some real manner, someone else. There is only one kind of currency that is good in the next life, and that is the currency of constructive service.

In this, also, the conditions differ from those that obtain in earth life; because, due to transparency of motives and visibility of thoughts, people are not evaluated falsely. On earth, to be sure, an individual while working for a secret selfish motive, can hoodwink the public into the belief he is a great and public-minded man. But not so over there. Every motive is in plain view of everyone who contacts him; and his mental and spiritual development are apparent in the plane he occupies, in his countenance, and in the structure of his form. Both what he is and what he has done go with him as a part of himself for all who desire to do so to read.

Yet because money has no value it should not be supposed that all one needs to do is merely to wish for something and, presto, it happens. On the contrary, the truly desirable things of the next life must be paid for quite as dearly as the things men most desire must be paid for dearly in this one. The difference is not that there is no payment; but that the currency is different. The only currency that will purchase you anything wanted in the after-life, so far as I have been able to ascertain, is the currency of constructive service.

Such a statement sounds like an abstraction, but in reality it is very concrete. The things you will desire most in the next life, just as most of the things of this life, must come to you through the aid of others. Over here, the farmer raises what you eat, the textile industry furnishes you with clothes, the building trades erect your house and office, the electrician brings you light, and someone else affords you fuel. But you do not get these things merely by asking for them. You are required to pay.

And there are a multitude of services that may be performed for your benefit on the other side by people. Not furnishing material food, fuel, or clothing, of course, but other services that are quite as essential for your higher welfare, that correspond to these material functions. But these functions are not rendered unless you pay for them. And to get them you must pay in terms of constructive service to others.

It is not that people over there are unwilling to render you a service without compensating pay; it is because you are unable to receive it. The individual who renders the service receives nothing and wants nothing from you. He is glad to render you all the assistance you are capable of receiving. But unless through your own efforts you try to be of assistance to others you have not opened the channel to receiving help.

So long as you are self-centered, you radiate no light that attracts those more advanced, and you effectually encase yourself against their help. They cannot reach you. But when you do something that is an aid to someone else, and do it without thought of recompense, you radiate a different vibration. And to the extent that you show the ability and desire to use whatever you receive for the good of others less fortunate, those who can aid you will feel attracted to you, and strengthened in their desire to give you help.

Attracting Assistance

—This currency of constructive service obtains also with those yet in the flesh, in so far as help and assistance from the inner plane are concerned. Higher intelligences from the inner plane are attracted by the use of ability for the common good. But even though attracted by zealous service rendered others, they are powerless, on any plane, to impart knowledge and instructions above the capacity of the person to receive.

Yet you may be sure that whosoever, even on the earth, uses whatever powers are within his command for the benefit of his fellowman, attracts helpful intelligences from the inner plane. And he will be given, by them, whatever assistance, little or much, he is capable of receiving and assimilating. These helpful ones from the other side often are not able to change some grossly erroneous notion, because such ideas become too strongly entrenched to be displaced by any subtle impression wafted from the inner plane. But they will send the individual such help as he can receive; as is well illustrated in the lives of a great many ardent humanitarians who have accomplished wonders in the face of seemingly insuperable obstacles.

Bearing this in mind, that the only currency that will get you anything after you pass from the physical life is constructive service, when you reach that after land, instead of expecting to be babied, pampered, and taken care of forever, you will, as soon as somewhat adjusted, set out to see what you can do that will benefit others.

And just to get into the right habit, it might be well to do a little practicing beforehand. You cannot, of course, renounce the money of the physical plane while you are still in physical life. But you can do a little something for somebody every day without considering what you are paid for it.

So essential do we consider this habit to all who seek spiritual progress that we made it obligatory on those who join The Church of Light that they take a pledge to devote some time and energy to the assistance of others without thought of recompense. Thus if they are true to their pledge they accustom themselves, before passing, to the use of the only currency that is legal tender in the land where they shall next reside.

Something For Nothing

—One of the things of which you should permanently disabuse your mind is the desire to receive something for nothing, or that, on the next plane you will get something worth while without effort. Effort is the mainspring of individual existence and the power behind all progression. Life does not come to a standstill so soon as it passes to the next plane. It moves on, and the amount of this movement is in proportion to intelligently directed effort

Either on the physical plane or on the inner plane, life is like a bank. If we accept the loan of opportunities to develop spirituality, we are expected to pay back that loan by using the spirituality developed for the advancement of all. And whatever talents we have, as indicated by our charts of birth, we are not supposed to permit them to lie idle, but to put them to use in such a manner that not only ourselves, but others, will be benefitted.

I know, to be sure, that the very idea of work is obnoxious to many. They are “fed up” with it here, and desire to go some place where there is nothing to do but rest. Yet these very over-worked individuals when they are given a forced vacation find doing nothing, after a time, worse than doing disagreeable work. Soon they find idleness intolerable, and become active in seeking pleasures, in sport, in travel, or in something that appeals to their fancy. Their distaste for work was really a distaste for some particular kind of work, or with too much activity. They imagined they wished to do nothing, when in reality their desire was to cease doing the things they were compelled to do, that they might do the things they desired to do.

The climate endured by a considerable of the population of India is such as to make physical activity a great strain on their vital forces. Such activity, therefore, in certain regions is greatly loathed. And from this loathing of effort, due to temperament and climate, has arisen, I believe, that particular conception of Nirvana that regards it as a state either of complete rest, or as annihilation. To an ill-nourished people, in a terrifically hot and humid climate, nothing seems more inviting than just to be able to rest forever.

But even these people, when once their vitality has been recuperated, would find the lack of something to do boring. Activity is life, and lack of it is death, to any organism on any plane. And activity is only disagreeable on any plane when we are compelled to do something contrary to our desires, or in excess of our easily available strength. Except for the purpose of recuperating his energies, no one finds any real joy in doing nothing. The only pleasure to be had from lack of activity comes from the feeling of recapturing energy for new activity. In this life our pleasures come from amusement, from sport, from certain types of achievement, all of which imply considerable mental, emotional or physical activity. The joys on any plane arise from activities.

Talents Must Be Used To Avoid Atrophy

—We find little inherent joy, however, in performing functions on any plane for which we are ill-fitted. People are temperamentally adapted to certain pursuits. Their experiences in lower life-forms before human birth, as well as their experiences after birth into human form, give them certain abilities which they find joy in exercising, and also lack of ability in certain other lines which make these lines distasteful.

It is possible, of course, to cultivate a liking for anything that life demands us to do, whether we have ability for it or not. And the incidental circumstances sometimes cultivate a repugnance for something we have natural ability to do. That is, artificial associations cause us to become conditioned toward some activity in a way diametrically opposite to the tendency that otherwise would have developed. These, however, are mere artificially created exceptions to the rule that we like to do what we can do best.

Back of this ability is the cosmic need for it. Each soul starts its cyclic journey to develop the ability to perform a specific function in the cosmic scheme of things. Its experiences, which are different from the experiences of any other soul, and may be quite unlike the experiences of most other souls, are all undergone to give it the education and ability ultimately to perform this work. And, because of this, when a soul is performing its proper function in the cosmic scheme, is doing the kind of work it is best fitted for and most likes to do, it experiences a joy and happiness in this work that can be obtained in no other way.

As a small boy whenever I heard the sermon based on the 25th chapter of Matthew, I reflected that the master in the parable of the talents was an unreasonably harsh fellow. The story goes, as you will recollect, that this master traveled to a far country, and on leaving delivered to his servants his goods, each according to his ability. To one he gave five talents, to another two talents, and to the third but one talent. The fellow who had been given five talents went into business and made five more. The two-talent man likewise doubled his money. But the poor one-talent man merely hid what had been given him.

When the master returned for a reckoning, because they had used their talents for the master's benefit, the five-talent man and the two-talent man were highly commended. But when the one-talent man revealed that he had let this talent lie idle, it was taken from him and given to the servant who had already acquired five additional talents. To me that seemed harsh enough; but in addition his master had the unused-talent man cast into outer darkness.

Later in life, when I became a naturalist, I found this parable verified by Nature. A talent or organ not used is taken away. It atrophies. Fish living in Mammoth Cave where they cannot use their eyes, have lost their sight. Whales and porpoises through being constantly in the water have lost such legs as once enabled their ancestors to walk about the land. And man has lost many an organ which still is discernible as a vestigial structure, the most troublesome one being the vermiform appendix, the rudiments of an extra chamber to the stomach which enabled his non-human forebears to digest cellulose.

In these losses of talents through disuse there is no hint of being cast into outer darkness; but in parasites, both vegetable and animal, there is; for the loss of functions through disuse is commonly so great that when their host dies, or gets rid of them, they are quite unable to provide for themselves and perish.

Now it is true, as in the parable, that each person is given custody of something. It is also true that talents are not equally distributed. The birth-chart of this life or of the next life of one person may indicate he was born with five talents, or as we commonly call them, natural aptitudes. The birth-chart of another may show he was born with two talents. And the birth-chart of a third may reveal he has but one outstanding talent. Everyone, however, has at least one natural aptitude, in the use of which he can accomplish more than in trying to employ others which he does not possess.

Divine Providence, the master of the parable, does not demand that the man possessing only one natural aptitude should employ five in contributing to universal welfare. Divine Providence requires only that the individual should use such aptitudes as he has. But should he fail to use these, whether they be one, two, or five, they will be taken away, they will atrophy; and because the individual thus fails to meet the demands of Nature, fails to evolve and develop according to the Progressive Plan, he is left behind. In a progressing cosmos which depends for its advancement on the contributions made by its specializing parts, whether on the outer plane or the inner plane the lot of the parasite is hard.

The talents which the individual is given by Nature are the result of the soul's experiences. These experiences are of ten different types, each associated with one of the twelve departments of life. The intensity and volume of a given type of experience is mapped by the prominence of its corresponding planet in the chart of birth. The department of life with which it is associated is mapped by the houses ruled by this planet in the chart of birth. And the harmony or discord of the given type of experience is mapped by this planet's aspects. Thus does the chart of birth into this life or into the next life correctly map the talents with which a person there is born.

The thought-cells built by prehuman experiences are correctly mapped by the birth-chart of the human form on earth, and these determine whether the individual is a five-talent, a two-talent or a one-talent person. The experiences thus indicated were of the Mars type, the Saturn type, or of some other planetary type, and they were brought together in certain intensities of harmony or discord, and relate to definite departments of life. But they have not been human experiences. They have not been experiences in bookkeeping, in financing, in trading, in conventional relations, in driving automobiles, in cooking, in studying books, in writing, lecturing or science.

To be of value in human life, these natural aptitudes, like the talents of the parable, must be given specialized activity. The Mars experiences may have been such that given a proper human environment they are easily developed into mechanical ability, or ability as a surgeon or a soldier. The Saturn experiences may be such that given a proper human environment, they readily give aptitude in organizing and buying. The Jupiter experiences may have been such that given a proper human environment they develop salesmanship ability. But until they are thus conditioned by exercise amid an appropriate environment they remain like the talent hidden away; not abilities ready for exercise, but merely natural aptitudes.

In like manner, all experiences up to the time of making the transition to the next life, including those of using specialized abilities on earth, afford the natural aptitudes with which people are born on the inner plane. But before they are of real value on this inner plane, they usually must be adapted to inner-plane existence through developing them for the specialized activities which there are in demand.

In prehuman life-forms the soul has had experiences in caring for the young, and the Domestic thought-cells thus organized provide one of the natural aptitudes required in human life to become a successful store clerk. In like manner experience as a store clerk in human life provides the still more complex organization of the Domestic thought-cells which gives the natural aptitude for a valuable function in the inner-plane life. But store clerks do not function as store clerks in the next life, no more than the plants and birds which in the care of their young on earth so strongly exhibit the thought-cell activity mapped by the Moon, when human life is reached depend on the whims of the wind to carry their offspring to a proper environment, or feed them with insects. It is not feasible to explain the details of functions exercised in the high-velocity region of the inner plane, because certain properties of existence there are so at variance with those on the outer plane. But we can speak of the work done there in terms of those physical activities which provide the aptitudes for similar inner-plane jobs.

And in doing so we can draw still another important inference from the parable of the talents. For whether in outer-plane life or inner-plane life, we may assume that had the servants increased their talents as two of them did, but used the gain merely for brutal and selfish purposes such as materialism encourages, that the master would not have been pleased. Natural abilities, which the birth-chart maps, not only should be developed to do such work as they best fit the individual to perform, but they should be used in such a manner that they benefit both the individual and the society of which he forms a part. For the true measure of a life is how much it contributes to universal welfare.

Next Life Economic System

—One of the points in the Nine-Point Plan For the New Civilization sponsored by The Church of Light is that men should have Freedom of Expression. This does not mean merely freedom to express honest convictions, but also that they should be given opportunity to develop whatever natural aptitudes their birth-charts show they possess, and use them to the advantage not only of themselves, but also to the advantage of society as a whole.

Such conditions already exist on the inner plane. People do not work for money in the next life; therefore, there is no compulsion for them to follow a trade for which ill-fitted and which to them is distasteful. On the contrary, the economic system there encourages them to find and take up the work for which they have been fitted by education and inclination.

I do not wish to convey the idea that so soon as you get on the other side that you will never be required to do anything that seems disagreeable. If you have not found your cosmic work while still on the physical plane—which you can do if you make proper effort—there may be considerable education and adjustment required before you finally get into it. Furthermore, aside from this work, there may be certain obligations to be met, incurred through error and wrong-doing in earth-life, that for the time will not be pleasant. The record of your earth-doings must be faced, and you, yourself, will pass judgment and pronounce sentence. And aside from this, the unlearning of preconceived ideas, and getting yourself properly adjusted to the new life, may not be unaccompanied by some disagreeable circumstances; or, according to your own life, they may be free from them. But when you get into your own work on the inner plane you will experience nothing but joy in doing it. Blessed is he, on either plane, who has found his real work.

You can, if you make proper effort, find this cosmic work while still in the flesh. But while still in the flesh, because there is no financial demand for it, you may be able to follow it only as an avocation, and may be compelled to make your living doing something else. But you may be assured that the economic system of the inner planes is not so inefficient and wasteful as to demand of you that you do something else. Every encouragement and assistance will be rendered you, by those more advanced there, to enable you to find and follow your own work. And in it you will experience a great joy.

And now let us consider some of the inner-plane jobs, bearing in mind that in this incomplete description no attempt is made to show how these employments are there influenced by the different time order, or other freedoms from restrictions commonly encountered on the outer plane.

Doctors and Nurses

—If you have read the literature of spiritualism, and the reports of others who have traveled on short trips into the astral region and returned to their physical bodies, the impression may have been received that in the next life everyone worthwhile is engaged in one of two occupations; they are either missionaries lending assistance to those who are making an effort to rise to higher planes, or they are members of the medical profession, doctors and nurses, spending their time assisting at the birth and adjustment of those from the earth-plane who enter this new life.

That by far the majority of recitals of the next life have to do with accounts of these two professional activities is to be expected. People when they first pass over need doctors and nurses, even as they need them when first born into physical life. Hence, about the first impression of the new arrival is that of these activities. And so soon as the nurses feel that the late arrival is sufficiently adjusted to the new world that they can relinquish their care of him, he usually is turned over to a guide, or missionary, who instructs him, in so far as he is willing to receive it, on the conditions of the new life, and how he should live to make upward progress.

Nor are the activities of doctors and nurses confined to these regions immediately surrounding the earth. So high, at least, as any I have information about, they still perform a useful function. Man still possesses a form, not only on the astral levels, but on those spiritual. And this form, for the individual to perform at highest efficiency, must be kept in proper condition. I do not mean that it is subject to such illnesses as we have on earth; but that the coordination of its vibratory organization to give the highest results requires that care be given it.

Astrological discords, excessive endeavors in some single direction, and other conditions may upset the harmonious relation between the functions of this higher form, depleting the vital reservoir, or disturbing the inner coordination. The doctors and nurses specialize in helping those who need such help on every plane. They make a study of the thought requirements of individuals following various occupations, and how to restore through thought-treatments, any who have exhausted themselves in their endeavors. And on the higher astral levels they specialize not so much in correcting discords, as in how those who there work can acquire and use the vital forces necessary to carry out their self-imposed tasks.

On the spiritual plane, too, they perform a useful function. After passing from the astral, although this passing is usually not so abrupt as the passing from the physical to the astral, people are born into the spiritual world. To be finally and completely born into the spiritual world requires the construction, through such processes as are considered in detail in Course 3 and Course 17, of a spiritual form in which there to function. Every person who lives in the physical world possesses an astral body, and when he passes from physical life he spontaneously functions in this astral body. But not everyone who has a physical body, or who functions on the astral plane in an astral body, has a spiritual body. The spiritual body must be built.

But before there is complete birth into the spiritual world, every shred of the astral body must be discarded. This sloughing off of the astral body is a rather gradual process of refinement. But in the final change from the velocities of the astral world to permanent residence in a world of still higher velocities, the last vestiges of the astral must be left behind. And the doctors and nurses of the spiritual world are fitted to advise and help in this. They also, in that higher velocity region, perform a further useful function, which because it pertains to high velocity properties, it is useless to try to explain in any detail.

Those who have special ability to lead people into a higher life perform the duties of missionaries, or guides. These guides do a great variety of work. They take the newly arrived person about, explaining to him as much about the new conditions in which he finds himself as he is able to receive. They endeavor to inspire him with the desire to live a more spiritual life, quickly to atone for the mistakes made on earth, and to rise to a position of constructive usefulness.

Devotional Exercises

—Not only are some missionaries, but some also who have special powers of oratory, through thought-broadcasting, talk regularly to large congregations. Devotional exercises are not confined to earth, but are a part of the life also of higher levels. People who follow various other occupations gather together at given times to listen to those of special spiritual understanding expound their knowledge of the higher truths.

Sometimes these devotional exercises are held in immense cathedrals of wondrous architecture; and sometimes they are held in the open, the chief speaker delivering his thought-message from some grassy eminence. At such gatherings there is music of a rapturous nature far surpassing anything known to earth. On earth we are moved by music; but in these interior regions the finer body is far more responsive, and the exquisite harmonies pervade it in a most ecstatic manner. Tones are heard that physical sound can scarcely suggest, and the finer senses of this inner world give a keener thrill of responsive pleasure.

At these meetings, especially at some of the open-air meetings, where there are trees and flowers and soft murmuring brooks; those gathered rather commonly expect, in addition to the music and the discourse, to witness some manifestation from regions above. These more spiritual manifestations are made possible by the soul upliftment of the gathered congregation. Their vibrations are raised and intensified, temporarily, through the music and the devotional exercises; and thus can be used to enable great beings from still higher spheres to descend amid spiritual splendors into their midst.

A group from some higher hierarchy may thus descend upon the hill around which the congregation is assembled; and the main speaker, or preacher, may step to one side to permit one of these exalted guests to address them. Or the descending great ones may bring with them some tremendous musical composition which is rendered before the awe-inspired audience. Or they may bring with them a miniature life-like and moving representation of the conditions that obtain in the higher sphere from whence they come; something like a moving picture, except that it appears to have all the dimensions of actual life. Or the manifestation may be that of building and dissolving scenery of most magnificent contour and gorgeous colors.

Just what takes place at these devotional gatherings depends upon various conditions; but it is always uplifting and inspiring. And if visitors from higher realms have taken part, at the close of the meeting, these ascend, are lost to view, and return to their own higher estate.

Guides and Missionaries

—But the more familiar form of ministry is that of the missionaries. Not that all of them consider themselves by this term, but it seems to express the nearest approach to their kind of work that we have on earth. Welfare work might be nearly as good a term for their endeavors. But it is a kind of work that not only applies to the slums of the lower astral, but is carried out, with such variations as is required by planal level, on every level, as high as I have any knowledge.

It cannot be considered mere teaching, because the instructions given are mostly confined to soul-advancement, and not the imparting of technical information about any single occupation. And, more often than not, the missionary descends from a plane higher than the one occupied by the person to whom he ministers. He has studied the process of moving across the planes, and has developed at least some slight ability to enter a lower plane than he normally occupies and reside there temporarily, while he encourages those who need such encouragement, and imparts to them counsel as to what they should do as the next step in their progress.

Because in the region close to the earth there is so great a need of such missionaries to put those who have passed from the earth with minds full of misconceptions on the right path, and because such missionaries are rather prominently in evidence in the regions where those who visit the astral realms temporarily travel, the impression might get abroad that the next life is a place where no one does much of anything but explain to someone else how to live a better life. But this would be erroneous; because life's activities are quite as varied over there as on the earth.

Yet this work of spiritual instruction is well organized in the astral slums. Yes, there are brave souls who, after special training and preparation, descend into the very lowest regions, that wherever a single spark of light can be seen, manifesting even the faintest desire toward betterment, specific instructions may be given that will enable the proper step to be taken by the aspiring one. To do such missionary work requires a knowledge of the broad principles of spiritual progress, and a sympathetic understanding of the disposition, nature, and needs of those approached.

Even on the highest levels of astral life, the knowledge of the spiritual existence, and how the individual best can reach it, is brought by missionaries from that realm, who have been able to communicate with those needing such encouragement or information. For while it is a law of spiritual progress that everyone should give all the aid he can to his fellows, some can be of much greater aid in other ways. Thus only those who are especially adapted to this kind of work are missionaries. Yet in the sense that it is their business to give direct aid to those seeking spiritual advancement, showing them how to direct their energies for that purpose, these missionaries, or ministers, have a valuable function on all planes.

Astrologers

—But I can assure you from my own personal experience that astrologers also have a very important work to perform in the next life. As they ascend higher the work they perform becomes more difficult, in conformity with their expanding powers.

Those not too far from earth continue their researches into the astrological conditions that affect the lives of people still on earth. Whatever of astrological knowledge I may possess has first been shown me in the astral realms. Not that because I saw it in the astral realms I accepted it. But because I saw it in the astral realms I started out in my search for it on earth, and after finding it on earth more or less complete in theory then devised means to check its accuracy. Such was the process with the Hermetic System of Astrology.

I have waded through immense books, books probably with leaves larger than any astrological book on earth, where huge page after huge page was devoted to charts, with explanations of them. I have watched the astrologers of the inner plane make calculations, and followed their processes. Then I also have tried to make such calculations, and whenever I made an error was corrected.

Nor have I found all the astrologers over there infallible, either in method or in prediction. Some of them still hold to notions that I think are fantastic. Some of them delight in intricate mathematical processes which seem to me too much involved for practical use. But, also, I have observed the computations of certain others, of those who gave me information and methods that I have amply proved. And these I have followed in their work, finding it accurate and provable as far as I could go; but quickly reaching a point beyond which my puny mind could not grasp what to them seemed so plain and simple.

I refer here merely to the calculation of astrological problems affecting the physical earth and its inhabitants. To calculations that gave them information about what was going to happen, and when it was going to happen, which was verified subsequently; but which, because of insufficient brain power I was unable fully to follow.

Nor is this all; for I have witnessed them working with the problems, and charting the forces operating in higher velocity realms, such as exert their influence on the lives and destinies of those in the next life. Their charts were not plain surfaces; nor was their zodiac round, but more like a transparent sphere, with the lines inside as well as outside of it. And it seemed to me that the astrological forces were calculated as coming from the inside, from the center, as well as the outside. I did not understand how this could be; nor did I understand anything about the process they were following, but I enjoyed it immensely.

People come to our astrological classes in Los Angeles for the first time, and sit through the meeting without knowing even the meaning of the simplest astrological term we use. They say that they are not bored because at least we seem to get fun out of it. And thus I have attended astrological meetings on the astral plane, where they talked about things quite incomprehensible to me, and had a lively time of it discussing how certain astrological influences would operate upon certain people or

groups in the astral world; also about which I knew nothing. But in spite of my ignorance, I felt they knew what they were talking about, and it certainly was astrological, and the atmosphere of the place and those in it made me feel that it was important. So, in spite of my lack of comprehension, the mere feeling that something astrologically important was being discussed gave me pleasure and interest.

Halls of Learning

—And I might take up, at some length, a description of the halls of learning, in which discourses are held on other occult subjects. But it is enough to say that many still on earth who are deeply interested in occult studies rather regularly visit these astral schools during sleep. The person conversant with the occult forces of nature, as well as the person conversant with astrology, has an important function to play in the life after physical death.

Farmers and Miners

—But do not think that the occupations so far mentioned are the only useful ones. Even the person who has cultivated the ability to be a successful farmer, or a successful miner, has a vital part to play in the after-life economy.

Basic materials and energies are equally necessary for construction and for activity on the inner planes as they are here. In the regions not remote from earth there are forests, and gardens of flowers. Even these do not assume their pleasing distribution and forms without intelligent supervision. And while thought intensely held brings things into form, thought consumes energy, and the astral substance used may be of grades and qualities.

From the universal substance of the level occupied, those with aptitude for it furnish the proper quality of energy and substance to be used in thought-construction, even as our miners and farmers here furnish the basic commodities of life. I shall not attempt to explain this process. Farming and mining as we know it here do not exist after leaving the region close to the earth. But the abilities of those who specialize in such work here are not lost. They perform a useful function, and an interesting one, changing the materials used as higher levels are reached, yet continuing active all the way up the ascending scale of existence.

Teachers and Writers

—I suppose I hardly need to mention the function of teachers, writers, publishers, and accountants in the realms above, because these are people frequently contacted by those yet of earth. They install the various systems of communication with the earth plane that are in vogue; including the supervision of seances where messages and information are given as well as those higher class systems of communication between the planes by means of voluntary thought- transference. But seances devoted to materialization are commonly presided over by chemists, and those where physical force is the chief manifestation usually require the presence of a physicist.

But either teaching those on the earth-plane, or establishing communications between loved ones on different planes, is the work of but certain groups. Teaching, and the dissemination of information, is quite as important a function in the inner realms as on the outer plane. Children who pass through the portal of physical death, of course, must take up their schooling on the inner plane. And adults require technical training to become more proficient with the particular line they have chosen to follow. I have already mentioned astrological and occult schools; but there are also schools devoted to every variety of technical education, and other places where lectures are delivered on subjects of more general interest.

I have already made mention of books in connection with astrology. These books give way, as the earth recedes, to records of a more direct character kept in the archives of astral substance. But to be available with facility to a wide public these records need to be clear cut thought impressions. And it is the function of publishers to see to it that such are made, and that the vibratory avenues are kept open, so that anyone desiring any particular information can tune in on it instantly.

Mechanics and Engineers

—This universe is not such a self-starting, unalterable, predestined concern as materialists conceive it to be. A few years ago five great scientists met to discuss their divergent views. Jeans maintained that the universe is running down. Millikan believed that the cosmic rays indicate that it is being wound up as fast as it runs down. Eddington thought in time it is bound to explode. The papers did not say what Milne and Lodge thought; but the latter, no doubt, took a more spiritual view.

As seen from the inner levels the physical orbs are machines just as the materialists conceive them, except that back of them is an intelligent driving power. That is, they are machines built and operated by vast intelligences occupying the inner realms of being. And even as a machine once built and started by a human on earth must operate according to its plan, so the physical orbs and manifestations run according to the laws imparted to them by their designers.

This is not an attempt to explain how the material universe came into existence. It is merely a hint that inventors and machinists and engineers need not despair of finding something upon which to use their skill and utmost ingenuity, not only in the astral but also in the highest spheres of spiritual being.

Artists

—Entertainment, through the drama, through fiction, and by means of music and dancing, finds a place in the after-life. It is not a region of all work, or of all play. It has its variety of interests. And the beautiful, approached through every avenue, plays a most important part.

If I had the gift of transcendent description I should try to give a pen-picture of the beautiful creations you will see in that future realm. But such is entirely beyond my power. Yet the work of the artist in that realm, whatever the medium of his expression, is only partly expressed in the external creations of his music, his painting, his sculpture, his dancing, his fiction, or whatever he uses to give form to his work. The important thing to him, and to others, is the direct way in which he conveys the sense of beauty to the very interior nature of others. Operating with high-velocities, through the avenue of thought-forms he imparts to others and cultivates in them his own joyous appreciation of the symmetrical, the harmonious, the beautiful, and all that seems most elevating in life.

Leaders

—In higher realms there is quite as much need of competent organization and a capable centralized authority as there is here. People strive in the after life to be leaders, that is, those whose abilities fit them for such service. But they do not, in higher realms, strive to be leaders while incapable of efficient work. Instead, because the ability of people, as well as their motives, stand out clearly for all to see, they strive for ability, well knowing that when they are sufficiently fitted they will be called upon to act in executive capacity.

In this we have something that is truly democratic and yet has the seeming of autocratic government. Leaders are given autocratic authority and full responsibility. They gain their leadership, not through popular vote in which appearances often count more than real ability, but because those working under them, as well as those working over them, perceive their special fitness for the post they occupy. Their authority is exercised, not through compulsion against rebellious subjects, but through a common recognition of their ability thus to serve in maximum degree.

Chapter 6

Serial No. 178
Original Copyright 1942
Elbert Benjamine

Copyright
Church of Light
August 2002

Education and Progress in the Next Life

Chapter 6

Education and Progress in the Next Life

AS SOON as you were born into physical life your education as to physical requirements was commenced, and as soon as you are born into the next life your education as to the requirements there will be taken up. Whether you desire it or not, you must have some education on the plane where you dwell. In early childhood you reach for something, and by getting it, or failing, you begin to acquire some knowledge of distance. Or you reach for a bee, and get stung, and find that some things are harmful and other things are beneficial. One thing is sure, whether you desire it or not, when you enter any plane of existence, education there immediately confronts you.

And on any plane—physical, astral or spiritual—to the extent that you are able to acquire correct information and then apply it to the adjustment of your life and the attainment of your ambitions, do you make satisfactory headway.

Yet even though the requirements of any new plane demand additional education, it is not impossible to acquire a large measure of it before transference to that plane. We do not enter physical life destitute of education. For the total of our past evolutionary experiences in lower forms are stored in our finer body. The new-born child knows how to breathe, requires no instruction in the assimilation of the food given it, and moves at the prick of a pin or the shock of a violent noise. It Comes into this world, not endowed with all the animal instincts, but a graduate from them; for their continued and insistent presence would hamper the higher faculty it now develops; the power of reason.

Thus also, when we pass to the next life, which we no doubt shall do in the exceedingly short space of the next century, there will be the necessity of education. Yet, because practically all the requirements of the next life can be practiced here, as well as grasped theoretically, we need not await our passing to acquire a proper education for the next plane. I do not mean that life is so similar that the common requirements of the physical plane are sufficient for progress over there; for they are not. But I mean that the requirements of life and progress in the next life may be put into daily application while here, in spite of physical requirements and limitations.

Now real education on any plane is something quite different from mere schooling. It implies something more even than a theoretical knowledge of a subject. Education, to be truly such, must rest upon a working knowledge, and this, in turn, usually embraces some practical experience. People not only learn by thinking, but they also learn by doing. And in this broader sense of the word, education goes hand in hand with progress.

Three Phases of Education

—But progress in the next life is not made by acquiring vast stores of money, nor by climbing rough-shod over those of superior ability into a position of prominence and leadership. Instead, it has three chief divisions, all uniting, of course, to promote the one thing of paramount importance; which is the cosmic welfare. That is, while the one and only yard-stick with which values are measured in the next life is the amount an individual contributes to the welfare of others, yet there are three separate phases of individual development and education that assist him to render high service.

Because, on the inner planes, we can no longer speak of things as being physical, I shall call these three separate, yet inter-blending lines of education upon which progress depends, the mental, the emotional, and the spiritual. Yet these must be understood to be quite relative terms, as that which we call spiritual has both a mental and an emotional basis; that which is emotional is associated with thought and has a determining effect upon the spiritual; and that which is mental is not free from emotional elements and an influence over the spiritual qualities. Mental, emotional and spiritual are not entities existing apart from one another. They are different ways which, for simplicity's sake, we seek to view a single reality.

Mental Education

—That which I here call mental refers specifically to the amount of information at the individual's command, and his ability to use it for some worthy end. If his experiences have been harmoniously organized, or reorganized, there is no doubt that, through this his power to assist others is increased. But under the heading of mental progress I prefer to disregard these elements of harmony and discord and consider the availability of information and the person's ability.

But before taking up adult education, a word about the children is not out of place. Those who pass out in infancy or childhood do not remain in that state of undevelopment. On the contrary they grow, very much as they grow on the physical plane, to the adult form. And, according to their capacity to receive it, they are given an education. There are schools on the astral plane, many of them of surpassing beauty, where children are instructed. And these schools, in most respects, are far superior to those on earth.

At least I have never witnessed the harshness there that is sometimes attendant on schooling in earth-life. And the teachers all seem to be so very fond of children, and so patient with them, and always so considerate and kind. Nor are these youngsters of the astral plane just little angels without wings. They are as full of fun and mischief as the youngsters who attend school on the physical plane. But I do believe those who have them in charge are selected for special ability to handle children and impart information to them. One does not see there, at least I never have, some sour old person who should have been running a factory, or giving legal advice, trying to teach school. The teachers there gravitate to this work because they have special ability, and because there is no other line of endeavor they like nearly so much.

Nor are all the youngsters crammed with the same instructions, and given the same amount of it. The object is to provide for each the special education which will permit him to get the fullest measure out of life. The child's experiences in earth-life, which have added to the experiences in prehuman life-forms, have organized thought-cells in its finer form. The degree of activity, harmony or discord, and the department of life with which these thought-cells are associated, are the seat of the child's natural aptitudes and luck-attracting ability. And even as in human life, the prominence of certain planets, their aspects, and the houses they rule, indicate to those familiar with astrology just what activities it should engage in to be most happy in its work, and to contribute most to its own welfare and the welfare of others.

Even as at the commencement of human life on earth, the natural aptitudes with which a child or an adult is born into the next life, to be of value there, must be given special activity. The Mars experiences of earth life, or the Saturn experiences, or the Jupiter experiences, if properly trained may be made to express through channels highly beneficial to all on the inner plane. But until they are thus given special training they have a very limited usefulness.

It is recognized by those who are in charge of instructions on the higher levels of the inner plane that the universe is one great evolving organism in which each soul has its own particular work to do, and that to the extent it performs this work is it able to participate in the progress of the whole. Therefore they make an appraisal, through astrology and other means of the function the individual has natural aptitudes best to perform; and they select the kind of training that is best suited, not merely to give him a liberal education, but also to develop the special abilities needed in the cosmic work he later is to do. They recognize that on all planes there is but one yard-stick for the measure of the value and fullness of life. That measure is how much it contributes to universal welfare.

Thus in the training of youngsters more latitude is permitted individual requirements, individual capacities, and individual leanings. It is not a namby-pamby system of education; but throughout no pains seem to be spared, either in environment or in method of presentation, to create a strong desire to learn. Everything is done to cause the children to desire to attend school, and to desire to learn. There is very little forcing of any kind.

One of the things which struck me most forcibly is that so much of the instruction is imparted either through field excursions or through avenues of play. The children are called upon to do things in their games that give them practical experience with the things they are being taught. Those who are backward, and those who are specializing in something unusual, are assigned a special teacher, who studies the child's individual requirements carefully, and acts in something of the capacity of a private tutor.

These astral schools for children are efficient, and while not entirely without their problems in handling refractory youths, they do not make the many mistakes commonly made in the schooling of youngsters on earth.

Those Who Die Young

—Yet in one respect the failure to grow to maturity and experience the vicissitudes of adult life on earth is apparently quite a handicap. For the impression is persistent that almost no amount of astral training alone can give the stability, the rigid resistance to forces, and the power to endure adversity, that is gained by more extensive experience in earth-life. No doubt, the cosmic requirements do not demand that those qualities be so strongly developed in some. I suppose, therefore, those who pass to the next plane in infancy are being educated for some sphere of activity in the cosmic scheme which does not call for a certain ruggedness. At least, in such progress as follows the more strenuous lines in the next life, those who have had plenty of experience on earth seem to have a decided advantage.

But whether child or adult, there is an effort made to fit each individual for the particular kind of work to which he is best suited, and in which, consequently, he will find the most joy. Not that people as soon as they pass to the next life start looking for a job, or start training for some occupation; because many of them have no idea that effort is necessary. They think when the earth is left behind that everything they need will just come to them. They have no more inclination to work, and no more idea of what they are fitted to do, than they had before passing.

But idleness becomes just as much of a bore on the inner planes as on the one external. So, after a period given over to adjustment, and another period devoted to sightseeing, the desire becomes insistent to do something. In the slums of the astral region there are hoodlums who resist any idea of constructive effort, and they will continue to occupy the slums until, stirred by a discontent with their lot, they aspire to a better form of existence. When so moved, their thoughts for something better is noted by missionaries who regularly visit such regions, and who give them advice on what to do next to set their feet moving in the right direction.

And in the astral hells there are criminals who have no desire to do anything except live and satisfy base desires at the expense of others. I do not mean that merely because an individual has been convicted of some crime on earth that he descends to such a region. I refer here to those who sometimes are looked up to and respected while on earth, yet who are dominated by cold and cruel selfishness to such an extent that sympathy and kindness have been blotted out in the determination to live and thrive through the efforts of others. Such individuals do not change in their intent or their inclination at physical death, and still try to prey upon others. And, when they can establish some measure of communication with someone yet on earth whose temporary vibratory frequency rate of thought tunes in to their dominant vibratory rate, they not infrequently endeavor to gain a vicarious gratification for their criminal wishes through influencing this individual to such evil acts as are prompted by their desires. Through vibratory sympathy with the individual on earth they are able to share his feelings and experiences.

Such vicious people have no desire to accomplish anything for the betterment of others; and until they are awakened to realize the necessity of unselfish service they have no chance of rising to higher planes or of bettering their condition very much where they are. It is the function of the missionaries, as I call them, to give what aid they can to these individuals in arousing them to the desire for a better kind of life. And, after they have made sufficient progress to enable them to realize what kind of work they are best fitted to do, and will, therefore, when accustomed to it, most like; they are taken in hand by teachers who give them proper instructions.

Finding His Occupation

—More people than might be imagined find the kind of work, while they still reside on earth, that they are best fitted to perform. They may, due to financial necessity, be able to follow it only as a hobby, or they may be so fortunately situated as to make it the main occupation of their earthly existence. But at least they have a pretty fair idea of what they want to do, in so far as it can be arranged.

And when they pass to the next life, and become somewhat adjusted to it, they will find that this same line of work is open to them there. As they ascend from lower to higher levels, the conditions regulating the performance of it, and the demands made by planal-level, will necessitate alterations in both material and technique; but it will be the same type of work in its general function, and consequently in the interest it arouses. When practically all is known about some work on one plane, there is still plenty to learn about its performance on the next higher plane. Work, thus, like everything imperishable, is eternally progressive; one step leading to another, ascending throughout infinity.

As I have implied, many need no particular guidance in finding their cosmic work. But there are others on both planes who have at least made progress enough to feel the desire to contribute to the social welfare, who blunder about without anything definite in view. In fact, either in this life or the next, the individual who does not feel impelled to undertake something that will benefit others has made no discernible spiritual progress. He is still in the state where the teachings he most needs are not technical, but those making plain the meaning and object of life. He is in need of missionary help. And he can hope to make no progress in the next life, and may expect a rather hard and dreary time of it, until he gets a different attitude, no matter how learned he may be in other ways.

But when the desire is felt strongly to enter upon the cosmic work, and the individual does not know what he should do, it is the function of the astrologer to indicate it to him. It is much better, of course, if the person can find his real work while still on the earth-plane, and make some headway with it. But if this is denied him, he will have the opportunity of finding it in the next life; the first essential of locating it being a strong desire to be of highest possible service.

Technical Training

—With it finally clear in his consciousness what it is in general that he wants to do, even though only the first step is marked out in detail, he quite naturally moves into association with those of similar aspirations, interests and desires for knowledge. Even on the physical plane it is the common thing for those of similar interests to arrange places of congregation where they have opportunity to exchange ideas. We have various trade associations, clubs, fraternities and study groups; and in the next life there are corresponding organizations.

And in addition to gatherings where ideas are exchanged, there are formal schools devoted to every conceivable type of technical and general teaching. Chemists have their laboratories, with competent instructors in charge. There are machine-shops in the region close to earth where machinery is designed and built, that later on will find its way to earthly construction through the impression of its thought-form filtering into the consciousness of some machinist on earth. And there are machine-shops in worlds of high spiritual level, where models are constructed and displayed, not merely of physical planetary systems, but of systems of existence that if created, or when created, in full proportions, would permit the development of still other sentient, throbbing life.

I have already made some mention of occult schools and astrological colleges existing on the inner planes, so I will say no more about them here. Nor will I go into further detail about the various technical schools of which I have been informed, but which I have never seen. Whatever time one spends in the inner worlds is apt to be spent, except for excursions of sight-seeing and exploration, mostly amid those things that are of deep personal interest. Naturally, therefore, I know more about the schools and processes devoted to teaching astrology, occultism, and nature subjects.

Methods In Teaching

—I should, perhaps, before passing from the subject, try to explain a very common method used in teaching natural science. It is to cause the process, whatever it is, to take place in miniature, yet in detail, before the eyes of the class. It is like a moving picture, except that the thing is represented as a working model. If it is something, like a flower or an animal, that possesses life, it appears for the time being to have that life. If it is something that undergoes a change, those changes all take place in plain view. Changes in vegetation or in animal development or in geological formations, that have taken ages, are reproduced and speeded up so as to be witnessed in a comparatively short space of time. And things that naturally move with great speed are slowed down so that they may be observed at some length.

I am reminded of the moving pictures of flowers as they came into bud, opened and closed, that Mr. Pillsbury took many years ago in Yosemite National Park. He has since greatly perfected the process.

The movements of these flowers during several days were reproduced on the screen in a few minutes of time. But in the process of which I speak, the things in miniature are there, and may be examined. Their inside workings are quite as visible to the consciousness of the observer as the outside. And the process can be applied to showing the development of a civilization, the cause of the fall of an empire, and to other vast subjects. One can witness the people, in miniature, rushing about the streets of ancient Rome, and feel the general mental atmosphere they at that time radiated.

And such processes can be projected of the future. A political system, showing its chief executives in miniature, and depicting the effect of the system upon the minds and activities of the people, may be made to run its course, to develop to its highest peak and then fall into decline, before the eyes of students. But, of course, having no actual astral records of the past to draw upon to give absolute accuracy, such projections into the future are only as precise as the power of the teachers running this kind of a show are to perceive, by their superior astral senses, what is going to happen. That is, they portray, by this method of thought-form evolution, their idea of what has taken place in the past, what will take place in the future, and what would happen if influences were brought to bear in some certain way.

Thus, because the movement of such thought-form representations may be stopped at any point for thorough examination, in this super-visual-education, all the senses can be appealed to in making clear technical processes or more general information. And similar methods are used in some of the schools devoted specifically to educating the emotional reactions. For, as lending itself not merely to the happiness of the individual, but as giving them also greater power to do something valuable for others, those who would make rapid advancement must undergo a training of their emotional nature.

Emotional Education

—No less than here, discords within the finer body there attract misfortune in the environment. At the time of a person's birth into physical life the degree of thought-cell activity of each of the ten different types is indicated by the prominence of the corresponding planet, the degree and kind of harmony or discord of the thought-cells is shown by the aspects of the planets, and the departments of life which they influence are plotted by the houses which the planets rule, in the birth-chart. But the special channels through which these thought-cells have been conditioned to express their energies after birth, and the degree in which they have been conditioned by experiences after human birth or after inner-plane birth to be more harmonious or more discordant, are not indicated by the chart of birth; nor are just what specific events these thought-cells will desire and work for at a given time fully shown by the progressed aspects that give them energy.

It is true that the thought-cells, either while the individual occupies the physical plane or after he passes to the next life, work for the things they desire, and that what they desire is influenced not merely by the experiences of the past which formed them, but also by the planetary energy they at the time receive. And it is true that the events that come into the individual's life either while on earth or after he has passed to the higher-velocity plane, are chiefly determined by these thought-cells using such extra physical power as they can acquire to exert pressure upon the environment. But this does not imply predestination, because it is within the power of each individual to alter both the degree of activity of any group of thought-cells and their desires, and to select an environment which will offer either less or more resistance to the pressure they exert in trying to bring the events they desire to pass.

It is the organization of thought-cells which we call the soul, or character, or unconscious mind, which survives the tomb and persists on successive innerplane levels, and may persist on various successively higher-velocity inner planes. And whatever harmonies or discords have been built into it by attitudes toward experiences determine within broad environmental limitations, not only the fortune or misfortune experienced on earth, but also the fortune or misfortune after passing to the inner plane.

On no plane is Nature a respecter of persons. Even as our bodies are injured by chemical imbalances when on earth we permit discordant emotions, so even in more profound degree on any plane are our finer bodies affected by such emotions, and groups of thought-cells are given both the energy and the desire to bring unfortunate events into our lives. You can create as much good karma as you can imagine, and you can live absolutely free from what is commonly known as sin; but if you permit yourself to harbor discordant emotions you will suffer through the events which later will come into your life.

Yet even if you know this, and make up your mind to cultivate only those thoughts and feelings that will build harmony into the soul, there is still the item of how. And it is one of the functions of the Religion of the Stars on earth, and of those who instruct in emotional education on the inner plane, not only to point out the certain results that follow given thoughts and feelings, but how to cultivate the recommended thoughts and feelings.

Astrology will aid in the selection of the thoughts and emotions that should be cultivated. They should be selected for the express purpose of rearranging the thought-elements harmoniously within the discordant thought-cells which tend to become active, or to supply these thought-cells with other mental elements which give them harmony.

The object sought, either on the physical plane or in the next life, is to give the thought-cells that otherwise would work to bring misfortune into the life, the desire for events which are fortunate. Therefore when it is observed that a certain type of discordant thinking tends to intrude into the consciousness, it should be classified according to its planetary rulership so that both the destructive and constructive thoughts which express the desires of the group of thought-cells responsible for these thoughts can be recognized.

When the constructive thoughts which are always to be substituted for the discordant ones have been selected, to give them the power to remain in consciousness and displace the unwanted thoughts, they should at start be associated with as many pleasant thoughts and experiences as possible.

The thoughts thus harmoniously substituted for those discordant will combine with the thought-elements within the discordant thought-cells in the finer body and give them the desire to work for those things which are beneficial to the individual. And because he has better fortune from that time on in his undertakings, he can contribute that much more to universal welfare.

This is the principle of the thing, but those on the inner plane who know how can make a miniature model of any individual, in which the lines of extra physical power are all shown reaching out from the different groups of thought-cells and attracting the particular circumstance or event. And to explain the operation of the principle of reconditioning, as above roughly outlined, they can show by animating this puppet just how a certain kind of thinking modifies the thought-cell activity and harmony or discord within, and thus changes the direction and power of the extra physical lines, so that they then exert an influence to attract events of a very different nature.

Thus is it illustrated by temporarily animated figures how, on all planes of being, the events attracted to the individual are due to the organization of his thought-cells, how these thought-cells were organized by experiences, and how they can be reconditioned to give a different fortune. And this study is carried forward by introducing thoughts of a predetermined type, to show just what effect a certain line of habitual thinking would produce in the finer organization, and the consequent destiny of individuals variously organized. The thought-cell organization of those present is then examined, and by means of these puppets, or experimental miniatures, which can be constructed closely to duplicate the thought-cell organization of any individual, it can be shown, by laboratory methods, what the influence would be upon any individual of certain types of experience when met by a given mental attitude.

It is recognized that an individual cannot render his maximum services to society if he continually attracts to himself misfortune in what he undertakes, or if he is miserable and unhappy. Unfortunately for the effect upon society, it very frequently occurs that greater ability is organized in association with discords derived from hardships. This does not detract from the talent, but does detract from its useful application.

A man may be greater as an inventive genius, for instance, who has the Sun in opposition to Uranus in his birth-chart, than one who has the Sun trine Uranus. But the discord within himself, mapped by the opposition in his birth-chart, may attract to him so many catastrophes and separations that his energies are consumed by them, and he is unable to bring forth into usefulness the many things he has the ability to conceive. The man with Sun trine Uranus, even though usually it indicates less ability, will attract less turmoil and disruption, and because his energies, such as they are, can be directed into productive channels, he may be a much greater benefactor to the race.

Now this same principle holds in regard to all ability. Yet in his cosmic work the individual follows the line in which he has the most ability, rather than the line where most harmony is indicated. His education in lower life-forms, as well as his human experiences, fit him for the performance of a certain type of work. And he expands this ability by further technical and general instructions after he reaches the astral plane.

But just because one passes to the next life the organization of the finer body is not markedly altered. The birth-chart there shows, not the same organization with which one was born into physical life, but whatever modifications, due to the experiences in human form, have taken place. Whatever discords are within the thought-cells at the time of physical death, either as unmodified from the time of physical birth, or as acquired by attitudes toward experiences during human life, are still present. They do not, in the next life, detract from the ability; but in much the same way as they do here, they detract from the useful exercise of ability.

These discords are not the essentials of ability, they are merely incidentals of its development. Yet before the abilities can be exercised to the greatest efficiency, these discords must be changed into concords. And in these astral schools devoted to emotional education the individual is shown just what kind of experiences he should seek, and what mental attitude he should take toward them, in order to reorganize his finer body so that he will not only be free from irritation and discontent, but also so he can exercise his particular gifts to full advantage.

In his technical training, and in the exercise of his abilities, the individual may be called upon to do things that, due to incidental conditioning in the past, he finds disagreeable. But in these laboratories of emotional education he is taught how to develop a liking for everything that the requirements of his progress demand him to do. He thus works to reorganize, through induced emotion, his finer body to a state where all its essential vibratory rates are harmonious, and he also works to maintain this completely harmonious organization.

Yet it should not be thought that the next life, even on the highest planes, is free from discords. Discords are present, and necessary, on every plane of being. They are necessary to the progress of life even as they are necessary to music. Either life or music free from any hint of dissonance would be tepid. It is not the entire absence of harsh notes that is desired, but that all dissonances should be resolved into final concord.

In the next life astrological forces play upon the finer bodies of people in a manner not entirely dissimilar to the way they do here. On that plane are certain astro-influences that well correspond to the progressed positions in the birth-charts of those on earth. And these astro-influxes, in order, it seems, to give the kinds of pressure that impel both individuals and stellar systems to struggle and evolve are, like those we experience here, sometimes harmonious and at other times discordant.

In the next life these also stimulate thought-cell activity within the finer form of man of corresponding nature. When discordant, they tend to set up discordant thought-cell activity, and this in turn, if permitted, attracts discordant events. But do not think of these discordant events as sickness, poverty, and crime; for as we know them here, these have no existence in the higher realms.

Yet in the emotional education it is taught how these thought-cell discords can be reconditioned by induced emotion and how they can be diverted into harmonious channels of expression. We attain to strength and ability only by meeting obstacles, only by overcoming difficulties, only by solving problems. Discords, while they persist within our finer form, by the very disagreeable, and often tragical, nature of the circumstances they bring us, compel us to struggle and find solutions for these problems of life. And in so far as we make intelligent effort to overcome these circumstances, we are strengthened and grow in power.

But, for progress and advancement, after a comprehension of the nature and function of discordant events is attained, there is no necessity for discords within. The problem of directing the life and destiny is the problem of reconditioning thought-cell discord and converting it into thought-cell harmony. With a re-educated emotional nature, and harmoniously reconditioned thought-cells, conditions and events are attracted of one's own choosing. This is true either on the physical or on the astral plane.

However, because the individual now perceives his function in the cosmic scheme of things, and because of his own desire to fulfill his mission, to make the utmost progress, and to render the greatest service possible, he does not avoid obstacles and difficult problems. Instead, he goes forth to meet them. They are not difficulties forced upon him by the attractive powers within himself. They are conditions existing on whatever plane he finds himself, that he enters of his own volition, and for the purpose of doing some specific work of value to others, or of gaining some information.

Events and circumstances, on any plane, do not bring us mental discords. It is only our attitude toward them that determines whether they will add energies that are harmonious or discordant to our thought-cells. Even the discordant influx of energies either due to progressed aspects of the planets in earth life or to corresponding astrological influences in the next life, that reach the finer body of man, need not be permitted to stir up discords within. By his own mental attitude, resulting from the emotional training to find some angle of pleasure with which to transform them into harmonies, he can prevent any such environmental forces from building discords into himself.

Of course, should he stagnate, environmental forces quickly would overwhelm him to the extent of building into him new discords. But if, instead of being shoved about by the forces and conditions of evolving nature, he takes the initiative as a co-operator in the evolutionary processes, he has no need of discords within himself, and can avoid their forming. The difficulties he meets, from thence forth, are those that lie in the path of accomplishing a greater and greater work and of higher and higher progress. They are all of his own choosing. He studies and works, not because he is compelled to, but because he likes to. Instead of doing disagreeable things, he

engages in those things which are of keenest interest, and therefore, afford the greatest pleasure. The strengthening element of meeting problems and overcoming obstacles is afforded by his effort to accomplish more and more, in his chosen line of work, for the benefit of others, and by his effort to rise to higher and more useful planes.

Emotional education, as carried out in the next life, does not make all difficulties vanish; for these are naturally present, and are influenced by astrological forces, on every plane. But it enables the individual to go about his affairs in the joyous spirit that this new life is a fine game to be played; and it gives him the power to choose a game to his liking; that is, a line of endeavor suited to his temperament.

Spiritual Education

—One may exercise intelligence and acquire a fund of information while a resident of any plane. Mere information, as such, has no power to change the vibratory-level of an individual's existence. Nor does the emotional reconditioning of the thought-cells of his finer body of necessity convey the individual to a higher plane; although on the lower levels, the slums and hells close to and below the physical level, one of the chief characteristics is discord. No doubt, in these terrible regions, the development of harmonious thought-cells within the astral form would automatically raise its dominant rate to that of a higher level. But broadly considered, the harmonies and discords within the finer body determine the kind of events and conditions attracted on the plane where the individual dwells. They may, and as indicated undoubtedly do, contribute something to the development of the dominant vibratory rate of the form; but their chief characteristic is their power to attract harmonious or inharmonious events.

Yet any real progress of importance carries the individual to a higher plane of expression, to become the inhabitant of a new world. Each of these worlds, which the individual occupies only by virtue of his dominant vibratory rates being tuned to it, has its own schools, industries, and other conditions of existence. They all correspond in their functions to, but differ in details from, the activities of the earth. But, as higher levels, or worlds, are reached, these functions become more complex, and of greater importance in the universal scheme of things. And only as an individual becomes fitted by developing greater spirituality is he able to perform these more important pre-requisites, and experience the more intense life and superior enjoyments of these higher regions.

Progress from level to level is the result of increasing spirituality. Certain types of experience tend to give the finer body a more intense vibratory rate. Certain mental attitudes tend toward refinement of the astral form. Thoughts, purified and combined in proper proportions, raise the general vibratory rate. Desires to give relief to others, and aspirations for a more noble existence, tend to refine the form and raise the

dominant rate. And when the dominant vibratory rate is sufficiently raised, the old level seems stuffy, and a place where it is hard to breathe. The individual then, usually accompanied by a missionary, or guide, ascends to the next higher level, and there finds an atmosphere, so to speak, adapted to his powers, and greater freedom for the development and exercise of his faculties.

Right close to the earth-plane he will find very few actual schools devoted to teaching spiritual development. And below the earth-level he will find none. In these regions the spiritual education is conducted almost exclusively by missionaries and by preachers. Not that these are orthodox missionaries and preachers. They convey their doctrines of spiritual progress, not after the manner of schools and colleges, but by private conversations or by public discourses in which the advantage of a better life is pointed out and the individual exhorted to endeavor to rise higher.

Even on the highest planes there are missionaries and preachers, although they there do not resort to exhortation and the cruder methods of stimulating the aspirations that are more prevalent at and below earth-level. Instead, on the higher levels they act more in the capacity of kindly and benevolent advisers; the missionaries acting as private guides and helpers, and those I call preachers, for want of a better name, delivering inspiring talks about spiritual things to public gatherings.

But in addition to these, as higher planes are reached there will be found also schools that devote their energy to imparting correct information about spiritual things, and instructing individuals how they can make the greatest spiritual progress. These schools are somewhat after the plan of those devoted to emotional education, except that their chief aim is to explain the influence of thoughts, acts and environment in reference to refining the organism and raising its dominant rate.

Here effigies of people may be found, to which have been imparted thought-rates of a certain wave-length and frequency. Above and below these miniature representations of people are what appear to be horizontal screens, each separated from the next screen above or below, by a space of considerable extent. And above these many horizontal screens is another space in which there are no screens; but what appears to be other horizontal levels of some luminous force. This upper region is to represent the still higher velocity, or spiritual, realm.

Then to these effigies are imparted, as the instruction requires, thought-vibrations of a particular kind. To one may be given the thought-vibration arising from a desire for vengeance; and after sufficient treatment with this thought-energy, because the whole vibratory rate has been lowered, the effigy sinks to a lower screen. That is, its coarsened rates permit it to drop through the screen which previously held it. Then, perhaps, the rate of thought-energy engendered by mother-love is applied to it; and as these energies are made visible, the mother-love energy can be seen mixing with the vengeance energy, acting as a natural antidote, and raising the vibratory rate to what it was before, the effigy now ascending, to stop at the screen where it was at first.

In this manner, by means of laboratory demonstrations, it is taught to those interested in these matters, just what effect thoughts, feelings, desires, and aspirations of any particular quality and in any combination, have toward increasing or decreasing the dominant vibratory rate of the form. The student is able to witness experiments that show just how and just why an individual moves from one level of existence to another. And he has no illusions, after viewing these experiments, that other levels are less real than the one on which he now temporarily resides. He knows that any world is real and tangible to those who vibrate to its frequencies.

I do not here wish to imply that all who make progress from one plane to another higher plane in the next life attend such schools. I merely point out that such schools exist, and that those so inclined can attend them, and through the aid of the superior information and help there gained make better headway than they otherwise could. Others, however, not so studiously inclined, depend on the missionaries and preachers for instructions on how to live, what to think, and what to do to make spiritual progress. And they, too, when aspiring, and energetic in the application of the advice they receive, make quite satisfactory progress.

In the schools devoted to spiritual education the matter is gone into with great thoroughness and with attention to details. Yet the advice and instructions promulgated by the missionaries, in their broad outlines, follow the same essential principles. In all spiritual instruction, wherever given, emphasis is placed upon the desire to be helpful to others, upon the refinement of the desires and emotions, and upon the necessity of building a more perfect character which when sufficiently developed will enable the individual to function in a realm still above the astral.

The preachers and missionaries are content to pass out the general idea, and to give concrete advice to individuals as applied to their particular problems in reference to such advancement. But in the spiritual schools I have mentioned, the effigies, as well as a variety of other means, are employed to give those interested in such matters a thorough understanding of the whole process.

A great amount of ingenuity is employed to teach those interested just how it is, and why it is, when the individual refines himself sufficiently, and increases his vibratory rates through building a superior character, that he moves entirely free from the various levels of the astral world, and henceforth lives, functions, and enjoys, the glorious privileges of the spiritual realm.

Chapter 7

Serial No. 179
Original Copyright 1943
Elbert Benjamine

Copyright
Church of Light
August 2002

Earth-Bound Souls and the Astral Hells

Chapter 7

Earth- Bound Souls and the Astral Hells

MY OWN impression of the next life, and the reports of practically all those who have visited the next-life planes, as well as the teachings emanating from those inner worlds, is that the next life is a joyous, glorious, exhilarating improvement over this one. The landscapes surpass in beauty, by far, anything seen or known upon the earth. The economic system, meaning here the system under which people serve one another, has done away completely with various features which make life so hard for some on earth. Social relations, while not to be considered perfect on any of the astral levels, are intensely more enjoyable. And even marriage offers exquisite pleasures of a transcendent nature only imperfectly shadowed by its grosser counterpart on earth.

It is true that in that after realm there is a small region where things are not so blessed. It is microscopically small when compared to the illimitable vastness of the next-life realms. But because it is so intimately associated with the earth, and the region just adjacent to, but below, the earth level, I feel I should give it attention and space all out of proportion to its actual size and cosmic importance. A mote is a very small thing compared to the size and importance of man, yet if it gets in his eye he may find it advantageous to give it considerable attention. And so also, this sordid region close to earth, although small and unimportant in comparison to the unmeasured realms of the blest, because it is right in the line of vision of many residing yet. on earth, should be given plenty of consideration.

I trust that because in earlier lessons of this course I have repeatedly mentioned earth-bound souls, and also those who reside in the slums and astral hells, and here again go further into the details of their life and the conditions that have brought them to this pass, that no one will think that any considerable part of life after death is confined to such existences. Yet because some people now on earth are, through their obsessive attachment to earthly things, becoming earth-bound, I feel that I should point out the principles more in detail; and should offer some suggestions as to how those still on earth sometimes are able to help break the earth-bound condition of those who have passed to the other plane in that deplorable state.

Because considerable vice and crime on the earth is prompted by intelligences of the inner plane endeavoring vicariously to gratify their evil desires, some mention of their activities also should be made. And because it is sometimes possible to help them better their condition through ceasing their debasing activities and redirecting their desires, this phase of the matter likewise should be presented. They deserve attention, just as habitual criminals, although comprising only a small percentage of the population of this country, also need to have their problems carefully and intelligently studied.

Earth-Bound Souls

—So first we will discuss the condition of those who are earth-bound. Why are they earth-bound? Because, through long and intense thinking about something, through the persistent application of desire to some object, or through emotional shock, they suffer from a mental fixation upon something of the earth.

On the earth plane we have the mental aberration called paranoia; which is defined as systematic delusion. This delusion usually arises from some idea becoming so dominant that it cannot be displaced by reality. That is, every condition that is met, is made by the mind of the person to conform to this fixed idea. Impact from environment, or the persuasion of people, has no effect in dislodging the fixed idea. As in hypnosis, some idea is accepted, and all other ideas, experiences and conditions, are made to conform to this conception.

Now on earth very few people have their ideas so properly endowed with emotional energy that each has the comparative strength it should have. In practically all of us, due to emotional experiences or unduly stimulated desires, some ideas have a certain power to warp other ideas somewhat into conformity with them. But it is only when this warping power of an idea, or group of ideas, becomes so pronounced as noticeably to unfit the individual for the tasks and responsibilities of physical life that the individual is considered a paranoiac.

Earth-bound souls are really those who, however normal in adjusting themselves to earth life, in the region where they now find themselves are suffering from paranoia. Others, who are not earth-bound, also suffer from paranoia on the astral plane. This paranoia may give them fixed ideas about things as they should exist in the after life, and thus attract them into an artificial environment where things, thought built, appear as they deem they must be. But earthbound souls are suffering from a paranoia in which something yet on the earth plane assumes an importance it in nowise deserves. It is a condition in which something of earth so dominates the mind that all the experiences of astral life, all the conversations, perhaps, with others of the astral plane, are powerless to dislodge this fixed idea associated with the earth plane.

Paranoia on earth is often difficult to cure. But if the patient by some means is made to realize the true significance of the idea which dominates him, and comes to give it a proper place in his scheme of things, he is no longer a paranoiac; that is, he is no longer insane. When his mental conceptions are thus readjusted, he is quite fit to perform the functions of life and carry the responsibilities of the physical plane. And likewise, when the earth-bound soul is made to realize the proper significance of the event or condition that holds him to earth, and thus comes to see the proper relative importance of the conditions that obtain in the plane where he now lives, he is no longer earth bound. His mental readjustment to conditions as they are in reality enables him to carry out the responsibilities of life on whatever plane he occupies.

Ideas of whatever character that become so powerfully emotionalized as to become fixed and obsessive in nature are inimical to the individual's welfare, no matter what they are. But only ideas thus emotionalized in association with something of the physical plane bind the soul to earth until a mental readjustment is made.

It may perform a useful service to mention some of the commonest forms of earth-binding conditions: People sometimes become so attached to their home, or place of business, while on earth that this attachment assumes a dominative character. When they pass to the next life they are unable to adjust themselves to the fact that they have lost their physical possession. Everything of the astral life by which they are surrounded that does not fit in with continued possession of the home or business is warped to fit this notion. Under this, or similar mental fixation, two of the outstanding laws of the inner plane operate to cause them actually to continue to inhabit the environment to which they were so attached while on earth.

The first of these laws, which we have already considered in some detail in chapter 3, is that the dominant vibratory rate at any given time determines the inner-plane level to which the soul gravitates. I use the word gravitate advisedly; for this principle of dominant vibratory frequency supplants gravitation in those realms where high-velocity no longer permits gravitation to operate. An individual, therefore, who through his thoughts and emotions, holds himself in the dominant vibration of a certain level, remains on that level, even when it is the level of his previous physical home or business.

The second of these laws relates also to the power of desire; but in this case not merely to influence the dominant vibratory rate and consequently the level on which a soul functions, but to take the soul to the particular place on the level contacted that is strongly thought about. As distance is determined by resonance instead of by our earthly conception of space, when an individual thinks strongly about a place on the level he occupies, this causes him to move into its environment. Thus does a fixation in thought and emotion on some earthly condition not only hold the individual to the planal level of that condition, but it also keeps him in the actual environment on which his thoughts are focused.

Thus is it that people who have passed from physical life are known still to move about the halls of European castles and manors. But it is not so commonly recognized that the streets and office buildings of our congested cities also still hold some of those whose dominant passion was business.

Not that business is inimical to spiritual welfare and progress. But it may so absorb the life and energies that there is room for little else in the thoughts and desires except to conduct business at the same old stand. With no conception of an after-life, with no belief other than that when we pass out we are a long time dead, and a fanatical attachment to some place, or to some occupation, that has been conducted for years and years in a given locality, the individual may readily become earth-bound.

The greed for gold may become obsessive, and bind the soul to earth. In fact, it would be difficult to catalogue the various attachments which may become intense enough to develop, through their emotional intensity, a fixation which holds the soul to earth. Great grief and distress may become, when sufficiently brooded over, strong enough mental factors to hold the soul to the earthly region which was the scene of such suffering. Or some great shock may fix an image in the mind that holds the individual to the earthly region where the shock was experienced. Thus murder of peculiar revolting character, or where the individual passing out is obsessed with the desire to tell someone something that to him seemed of great importance, sometimes holds the individual earth-bound.

Such earth-bound conditions are not normal, no more so than insanity is a normal condition of physical life. But due to the prevalence of great attachments formed for physical things, they are far more common than might be supposed. That is one reason why people should be better informed than they are about the conditions of the next life. Knowing that they will live in the after-realm, and develop proper interests there, they will not become obsessed with the importance of some particular thing of earth. While on earth they will devote their energies to such interests as they think best; but when they pass to the next life they will be prepared to relinquish earthly things, and ready to find something on the new plane that will interest them quite as keenly.

We accomplish little worth while without strong desires and intense interests. But even in earthly life too strong attachments to things that are transient are fatal to success. There are still a few who use horses to haul freight long distances, who still travel with horse and buggy, who still use hand methods of manufacture in preference to modern machinery. They have been unable to relinquish the old. But for success on this plane or any other, it is essential to be able to break with past attachments and form new ones. Industrial development lags to keep step with no man's antiquated notions, and the life-wave permits the individual only a limited span on any plane. The universe is progressive, and any life-form to persist indefinitely must keep pace with it.

I think it is a great mistake for people to cling too tenaciously to thoughts of earth life. I believe it hinders their progress noticeably if they pass to the next plane with the strong desire and determination to return to earth. We should desire to remain on earth so long as we can be useful here; for on earth we develop qualities which are much more difficult to cultivate after passing to the next plane. But once our time has arrived for passing, I believe it is a great error to continue the attachment to earth. It hinders adjustment to the next plane of living.

Even those who believe in human reincarnation, I am sure would do better to think very little about coming back to earth to reincarnate, and look forward to adjusting themselves to the new plane of life. If, as they believe, it is Nature's law that they shall return repeatedly to go through earth life in human form, Nature will attend to that in her own time. For a period, at least, they will live in another realm, and this other realm has requirements. Their struggles to return and reincarnate merely keep them earthbound, or earth-attached, and serves no good purpose.

This desire to reincarnate often holds people to earth, and unfits them for the duties of life in the next realm. They are attracted, by this obsessive passion to reincarnate, to any condition that offers them hope of its fulfillment. With no evil intent, they stimulate those with whom they can form sympathetic rapport, to enter into such relations as they hope will enable them to be born again into the flesh. It is not a happy condition for themselves, and is not conducive to the spiritual development of those still on earth whom they are able to impress and influence. If, therefore, there is a conviction that human reincarnation is true, it is much better for the individual to direct his mind to spiritual progress, and let Nature bring him back to earth to reincarnate at the proper time. For if he gets so that he talks and thinks about little else, he is very apt to be completely earth-bound by this determination and desire.

Releasing the Earth-Bound

—When, for any of the causes mentioned, a soul becomes earth-bound, it may at times be seen by clairvoyant vision at the place where it lingers or visits. And if, due to the presence of a person of mediumistic qualifications, or due to other special conditions, there is a sufficient supply of electromagnetic energy available, the earth-bound soul may become visible to those not clairvoyant. That is, it may, under those circumstances, draw about itself an electromagnetic material form quite visible to any person present.

It is very rare that such ghosts or spooks are dangerous to human beings. If they pass out of the body dominated by the thought to guard some treasure, or dominated by the idea to harm anyone who comes to the place, then, providing there is sufficient electromagnetic energy at their command to enable them to produce material effects, they may become exceedingly dangerous. Such hauntings are rare, but not entirely

unknown. But ordinarily, even though the individual was vicious in physical life, he is so dominated by the idea that binds him to earth that he takes no notice of anything not directly associated with it. Thus most earth-bound souls are quite harmless to those on earth except when through some sympathetic relation they are able to impress those still in the flesh to action.

Because they are so dominated by an idea they often are as hard to get conversation out of as is one who is walking in his sleep. The easiest method of getting their attention is through something relating to the dominant idea. They are more willing to discuss whatever it is that holds them to earth than anything else. And from this, leading by gradual steps to their present condition, it is possible sometimes to talk them into realizing that they are earth-bound, and that they are perpetrating a grave mistake. If they can once realize this, the binding condition is broken, and they are born into the new life and take up their natural course of progression.

Although missionaries from the inner plane are constantly working to free earth-bound souls, those still in the flesh can often do quite as much in this as the missionaries can. In such work, those who have developed clairvoyance, and those who in sleep have accustomed themselves to work on the astral plane, have an advantage. But any person who has enough extra-sensory perception to feel the presence of someone from the inner plane and feel the condition that holds this presence to earth can render valuable service.

If such a presence is felt customarily in a certain vicinity, those who feel it, even though the astral person is not seen, should talk to it pleasantly and convincingly whenever it is felt to be present. No dramatics need enter into this, and nothing heroic. Talk to the invisible presence reasonably and forcefully, yet sympathetically, just as if it were someone in the flesh who had a wrong conception of things and needed kindly help to straighten him out and get him started on the right track. But when thus conversing with any aberrant entity, it is best all the time to keep the mind alert and positive. You are selling him the idea, and should not permit him opportunity, through your own negativeness, to sell his convictions to you, or in any way influence you. You would not, I am sure, permit even a harmless paranoiac on the physical plane to get you under his control; although you would probably be willing to talk to him and offer kindly advice if you thought it would help.

It should be understood that an earth-bound soul is suffering from a delusion that he still inhabits the earth. As a result of this delusion he has never been completely born into the next life. His forces are still incompletely polarized to the inner plane, and he has consequently never adjusted himself to the requirements of his new environment. But if he can be awakened to a realization of where he is, and that his old attachment to earth is folly, he quickly completes his birth into the new realm and can take up his duties there.

Up to this point I have discussed earth-bound souls as if they invariably were quite unconscious of their transition to, and environment on, the astral plane. But even as paranoia on earth may be very complete, or in varying degrees affect the sanity either more or less, so earth-bound souls are bound in varying degrees. Some of them are only bound to earth environment to a small extent, and are pretty much aware of their astral condition, even though clinging stoutly to something in physical life. Such individuals, when communicated with, express considerable intelligence in regard to a variety of things that now affect them. Thus, while there are those who are completely earthbound, there are others who are only partially earthbound. But so long as they are even partially earthbound they have never been completely born into the next life. And only when completely born can they make the adjustments necessary for progression.

Earth-Attracted Souls

—But in addition to these, there are others who have been completely born into the next life, who still, whenever they can make the proper contact, like to hang around the earth. They are quite aware that they have passed to the next life, and they have taken some steps to adjust themselves to it. It is not because they are ignorant of the relation between the earth and the plane they now occupy that they desire to make earth contacts, but because they know that through such means they can find some satisfaction for carnal desires.

These individuals are much more numerous than those earth-bound. Their desires while on earth were sufficiently diversified that they suffered no fixation; but these desires were of a character that gave them a dominant vibratory rate no higher, and perhaps much lower, than the average of the earth-plane. They possess a vibratory frequency similar to that associated with the grosser endeavors of those yet on earth. And they are glad enough to find any opportunity by which they can re-experience the old earthly sensations.

In the next life they have gravitated to levels, and to environments, corresponding to their dominant vibratory rate and their strongest desires. They have not forgotten their experiences of earth, and they have not changed their tendencies and desires. But without forming a sympathetic vibratory exchange with someone on earth, they are completely cut off from this earth life, and exert no influence upon it.

When, however, they are able to form the contact with some very negative person, they may be able to form a rapport with him, through which they are able to experience all that he does. And because of their own vicious tendencies, they may be able to impress him to do things that of his own initiative he would never think of doing.

Those in the flesh and those out of it can turn the dial of their consciousness to rates either higher or lower. In this manner aspirations may place them in touch with entities higher in the scale of life, and base desires may tune them in, temporarily, on a phase of existence far below their habitual level, and permit them to be impressed by the intelligences of a lower region.

When, however, an entity of a lower region turns the dial of his consciousness to a higher vibration, he has an influence upon the higher level only so long as he keeps the temporary vibratory rate of his thoughts tuned up to the rate of this higher plane. Should he, therefore, experience a desire more gross, or a thought more malicious than that customary to the level he has tuned in on, such desire or thought, because of a lower rate than this level, would cut him off from the level. An entity of a lower level cannot exert a detrimental influence upon entities of a higher level, except the entities of the higher level, through some artificial process of mediumship, or through tuning in on the lower level, establish the conditions that permit it.

But those of a higher level can turn the dial of their consciousness to a lower frequency-rate, and thus tune in on a lower level. And while tuned in on the lower level, because the way is open for an exchange of energies, not only can the higher entities influence those of this lower level, but those of this lower level are placed in a position to influence the higher entity. In the understanding of how one level can affect another it is very important clearly to comprehend that a low-vibration entity cannot exert any evil influence on a high-vibration entity so long as the high-vibration entity keeps his vibrations high. For instance, purity and high aspirations are a complete barrier against every inimical and low influence. This is true of those yet in the flesh, and it is true of those who have passed to the next life. Spirituality, either on earth or in the invisible world, keeps the vibrations on a level that evil forces cannot reach. If they tune up to reach this level, their forces are no longer evil; and if after tuning up, they begin to think evil thoughts, it cuts them off from the higher level and they no longer exert an influence there.

But an individual on a higher level can lower his dominant vibratory rate to an extent that enables him actually to live on some lower level. And while he is on this lower level he can influence those of this level, and he is subject to the influence of those on this level.

If he is not to be injured while on this lower level, he must have sufficient force at his command to resist those who dwell there. Missionaries who work in the lower regions undergo rigid training in the use of their mental forces. While working in these lower regions they are in actual danger; because the denizens of such regions strive to get them in their power. The fact that they are missionaries does not make them immune from harm. Such immunity as they have, which is not always complete, comes from the superior strength that has resulted from their special training.

Yet without lowering the dominant vibratory rate, and thus actually living on a lower level, an individual on one level can, by the directive power of his thoughts, tune his consciousness in on a lower level. He remains on his own level, but sees, hears, and feels temporarily, certain things of the lower level. During such partial contact he tunes in, perhaps, on the thoughts of certain persons of this lower level. And so long as his mind is positive, and directed to the accomplishments of some definite thing, he does most of the influencing. That is, he is the broadcasting station, and those of the lower level are the receiving set.

But, while his thoughts are of this level, if he becomes negative, or even puzzled for a solution of the ways and means to realize some desire that is of a quality corresponding to this lower level, this mental passivity enables someone on the lower level who is more positive to become the broadcaster, and the higher entity, for the moment, becomes the receiving set.

This principle of sending and receiving is not confined to a communication with the lower entities; it is applicable to all planes. A desire of a certain quality, if strong, tends to tune the consciousness in on the level and locality of corresponding quality. And, the mind becoming meditative and receptive while seeking a solution to the problem presented by the desire, some person of this level can then become the broadcaster, and send information that will be received by the unconscious mind of the person having the desire. People's thoughts are not nearly as independent of the influence of other minds as they generally suppose.

Influencing Those On Earth

—I do not here wish to convey the idea that most people are merely puppets moved about by entities on the astral plane. People who habitually direct their energies to the task at hand, who direct their minds resolutely to the problems with which they are confronted, who are not naturally hypersensitive or unduly negative, move about their physical lives quite unconscious of those of the inner plane. And while, in seeking the solution of their problems, and in forming opinions, they do unconsciously pick up, and are influenced by, ideas emanating from those of the inner plane, yet their lives are not unduly affected through such channels. Their minds are too actively engaged in broadcasting to become very receptive receiving sets.

But in the lower levels of human society, where depravity is the rule, and impulse, desire and passion supplant reason and intelligence, the broadcasting is intermittent and spasmodic. These people habitually are swayed by feelings engendered by slight suggestions coming from without. Instead of having characters built by long resistance to detrimental forces, and instead of commonly turning inimical desires into constructive channels of expression, they are used to being swayed by the slightest thought of base gratification.

Among such people the power of those on the inner plane to influence their actions is often very great. Accustomed to exercise very little self-control, it requires no very strong influence to deflect them from any predetermined path. Recurrent desires of a gross nature turn the dial of their consciousness to the lower rates of astral slums and dens of iniquity. The depraved individuals of such regions thus are made aware of their existence, and one of them may be able, over the wave of transmission thus organized, to establish enough rapport to be able both to influence the actions of the person on earth, and to share in the resulting experiences.

Such contacts may also be formed through the artificial process of developing the disintegrative form of mediumship, by a person who has no evil desires. In a seance room there may be those of the flesh present who have vicious desires that tune them in on the lower regions of the astral world. These may be positive enough not to be markedly influenced by anyone of the unseen realm. But the medium, or some person present who becomes very negative, may have the vibratory rates of the consciousness lowered by this person's thoughts, desires, or basic rate, to a point where contact is established with invisible entities of similar quality.

There are people who are carriers of typhoid and certain other diseases, although they themselves are not stricken. And there are those who may be contacted in a seance room who are not much influenced by those of the inner realm, but who, because of their own baseness, enable vicious individuals of the lower astral to form contacts with others present who are more negative. Purity and high aspirations are an effective bar against such low contacts; but this barrier can be destroyed through negativeness and passivity while in the presence of some evil minded person on the physical plane.

After rapport is established between two entities, whether of the same plane or of different planes, the one developing the higher voltage is the one which does the influencing. That is, traffic is not compelled to travel only one way. Which way the energy moves, who does the influencing and who is influenced, is determined by the contact potential.

And this also is the principle which permits an individual emanating a powerful electromagnetic force in a seance room to polarize the weaker electromagnetic force of some other person present, even though it is done unconsciously, so that this less powerful person, electromagnetically, temporarily has the dominant rate, or some part of his finer form is given the vibratory rate, of the other person. His own electromagnetic vibrations are forced to accommodate themselves temporarily to the vibrations of the more powerful person, because both are occupying the same electromagnetic field. And this may enable an inner-plane entity to make a contact that later is difficult to sever.

After the entity has once made the contact through the assistance of the electromagnetic energies of a medium or other person with powerful emanations, it is easier again for this same entity, through the lines of force established, to make the contact again.

But when contact has thus, or through voluntarily tuning to the dominant mood of those occupying a certain level, been established, who does the major part of the influencing is determined by the same principle that Volta discovered relative to different metals when placed in contact, but otherwise insulated. That is, tuning in and establishing rapport is analogous to placing two different, but otherwise insulated, metals in contact. There is then a potential difference, which varies between different metals, and between different individuals. And the energy flow, which in the case of individuals means the influencing power, always moves from the higher potential to the lower.

Yet positiveness and negativeness are relative. A metal which is positive to another metal, itself usually is negative to still some other metal. And a person who is positive to one person, may be negative to another. The so-called positive individual, whether he occupies the physical plane or the inner plane, is merely one who customarily has so high a potential that he strongly resists control by any outside energy, and the so-called negative individual is merely one who customarily has so low a potential that he easily is controlled by energies from without.

Thus for an individual on the physical plane to develop more resistance to the influence of inner-plane entities, in addition to cultivating those moods which tune his dominant vibratory rate to levels whose occupants are spiritual, he needs to cultivate a higher electrical potential. For so long as he has a physical body his electromagnetic frequencies impart their rates to his astral form.

Some of the astral regions occupied by those of little spirituality are fair duplicates of the cities of earth. Strife, bargaining, and cunning attempts to gain unfair advantage over others, occupy much of the time of their inhabitants. Such regions attract those who on earth were engrossed in business, and neglected to cultivate sympathy for their fellows. They are not compelled to remain in these uninviting conditions. But here they will remain until, through the desire for something better, they develop at least the rudiments of spirituality.

Criminal Promptings

—In a region still lower, are duplications, with inversive improvements, of the slums of earth. Sin and wickedness are here rampant. And whenever the denizens of this region can do so they form contacts with those yet on earth, that they may gratify their base desires more fully through the flesh. Much of the ingenuity of criminals on earth, and untold crimes of impulse, are prompted by those in the astral slums.

And still lower are those of a cold and vindictive wickedness. They have built for themselves, by their thoughts and desires, a region of darkness in what may be described as the astral hells. These are not people of impulse, but of premeditated and coolly calculated wickedness of the most cruel type. And in this region, devoid of all light except such as they can supply by artificial means, they practice their cruelty upon one another.

The Astral Hells

—In the astral hells force alone is the law of its denizens. The shrewdest and most unscrupulous reign supreme. They scoff at the existence of God, and look upon all religion as a sop fit only for weaklings. The surroundings are bleak rock in some localities, and swampy land given over to something resembling noxious fungi, which emits a dreadful odor, in others. The clothing of the inhabitants is merely rags and tatters, and their housing not better than the dens of wild beasts.

People on earth are not compelled to live in mosquito-breeding swamps, but some do so. Nor are these, who once inhabited earth, compelled to live in these awful regions. They go here because their dominant vibratory rate is of this level, and because their thoughts and desires are of a nature to attract them to a bleak or noxious surrounding. And in these regions are other than human forms of life; creatures of some intelligence, even as animals on earth have some intelligence, but more repulsive than our animals.

Into such realms, even to the very lowest, go specially trained missionaries. They talk to the denizens of these gloomy lands, tell them of better conditions on higher planes and explain how those higher planes can be reached. For their pains they are jeered, heckled and booed. They are told that they are mere dreamers, that no higher land exists, that God is a myth fit only for children, that might is the only right, and that they are trying to influence people merely from some selfish motive unusually well concealed.

Such missionaries are set upon by crowds in the astral hells, and must know how to protect themselves from such assault, and how to get away when the attack becomes too strong. This is important as part of their work. And they must be quick to recognize the faint light that results from the response of any individual to their teachings.

When thus they perceive that someone has faith in their doctrines and begins to long for the higher life they describe, they go quickly to him and give him personal instructions. In this they often are thwarted by others of the region in which they work, who take pains to advance to the aspiring one every reason and inducement for remaining just where he is. And when such a one begins to gain a little spiritual understanding, and attempts to leave the region, these others set upon him like wild beasts, bent on bringing him down. Sometimes he is successful in getting away, with the assistance of the missionary; and sometimes the onset is so strong that he is pulled back too discouraged for further effort.

Those who have reported their visits to these infernal regions have given vivid descriptions of their horrors. They have painted word pictures of human depravity, and they have made known the existence of creatures quite terrifying, recognized commonly as elementals. But this need cause no person an extra shudder; for in reality, on a slumming expedition, one may contact things almost as hideous and revolting. There is this difference, however, that in slumming on the physical plane one commonly does not see the desires, evil thought, and cruel selfishness. One only sees people. But in the astral slums and hells the thoughts, desires, and passions are represented in the quality and kind of environment, and in the creatures other than human that inhabit it.

No one needs to quail at thought of such regions. They are the result of ignorance and moral disease. But the human soul should have the courage to face any condition that exists, on any plane, knowing that it has the power to triumph over it. Fear is a deadly enemy to the human soul; and should be allowed to have no participation in our lives. On the streets of the physical world we pass vicious characters, and there are sometimes poisonous spiders, like the black widow, about our homes. We do not fear these, and we need not fear any condition or intelligence of the inner world. We can face the fact that such conditions exist, that effort should be made to correct them; and beyond such knowledge and rendering such aid as we can, we need think no further about them.

Obsessing Entities

—People on earth sometimes suffer from obsession by an idea. But some also become obsessed by discarnate persons, such as belong to some of the lower levels just partially described. The obsessive influence may be intermittent, and only manifest when the individual becomes unduly excited about some particular thing so that his mind tunes in on the level of the obsessing person. Or the obsession may become a permanent thing; the person losing mastery of himself to such an extent that the invisible entity has complete control of his thoughts and actions. Our insane asylums house many who are afflicted in this way.

Many who become hopelessly obsessed could prevent it if they but had a little knowledge and made the effort in time. They could free themselves from any such influence by the same means that the missionaries use to get away from the denizens of lower regions who attempt to drag them down. The missionaries turn their thoughts resolutely to something of a higher level. They ignore their present surroundings, and the higher thought-vibration lifts them out of the lower level to a higher level where grosser creatures cannot follow. Their special training enables them to do this, and also makes them aware when, through prolonged contact with a lower level, their energy is weakened to a point of danger, that is, to a point that makes it difficult to develop a high potential and to focus their minds sufficiently on the things of higher levels.

Some who are yet in the flesh do quite valuable work talking to those in the lower astral regions, instructing them, and trying to arouse in them an incentive for life on a higher level. And almost anyone can talk to an earth-bound soul, and if his attention can be gained, render him aid in realizing his condition and how to remedy it. But it is not advisable for the ordinary person, who has had no special training in such matters, to try to help those of the slums and hells of the astral world. It is altogether too dangerous.

It is made more dangerous because elementals and those depraved who no longer have physical bodies may still be in contact with the dense belt of electromagnetic energy surrounding the earth, and be able through its energies to exert considerable force, provided the individual on earth develops the conditions which establish contact. Such contact between entities on different planes strengthens with repetition. And once the thoughts form the habit of tuning in on a certain level, it is increasingly hard to keep them from this particular level. As in the approach to narcotics and opiates, the first experiences may be difficult; yet with repetitions there is a stronger and stronger attraction. And the danger lies in the possibility of some entity of such a lower level getting the individual of the earth-plane into his power.

Thought and feeling, including the consciousness and feeling of animals as well as of men, of those on earth radiates both electromagnetic energy and astral energy; and thus about the earth is a belt of energy formed of both electromagnetic and astral vibrations. And the electromagnetic boundary-line energies of this belt can be used by entities of the inner plane, once contact is established, to exert force on those of the outer plane.

High and noble aspirations provide energy which those on the higher levels of the astral plane can use to impress those on the outer plane with valuable ideas. But so much of this purgatorial belt has the vibrations of the brute level that it is specially adapted to the use of creatures on the inner plane whose propensities are those of the animals.

Even on the lower astral levels whose denizens are still closely in contact with this electromagnetic belt, because on the astral plane space, time and gravitation do not limit as on earth, those who dwell there may be able through extra-sensory perception to gain information of value relating to conditions and the affairs of earth. But those residing on such lower levels, even though their contact with the electromagnetic belt makes it easy for them to influence people on earth, are not to be trusted. Those on any such level, if they find it to their advantage, are too apt to deceive, and try to use the earth-plane individual for their own selfish ends.

Except through excessive negativeness while in the presence of some person on the physical plane whose thoughts are evil, people do not tune in on such low levels of the inner plane except through thinking the thoughts characteristic of such levels. Yet if, once having made the contact with a person on another plane, one thinks persistently of this person, it automatically tends to raise or lower the consciousness to his basic level, thus reestablishing the connection.

On the physical plane there are racketeers. And once an individual becomes a racketeer, the laws of gangdom never willingly permit him to leave the racket. Every effort is made by gangsters to prevent any of their members going straight. And when they get some victim in their clutch, they strive to keep him a victim, and to use him for their own purposes.

People on the physical plane who dabble unintelligently with things of the astral realm sometimes more or less voluntarily come in contact with the denizens of the astral slums or hells. And others, through poorly supervised public seance rooms, or through psychic development coupled with dominant base desires, sometimes contact people of the next life who are depraved. And these depraved individuals of the inner realm use just such means as we expect modern gangsters to use in holding their victims. They resort to threats, to curses, to abuse, and to anything that tends to arouse fear.

They really cannot harm the person in the flesh, except through his fear and his acceptance of their suggestions. And the person in the flesh can get rid of them for good by developing a high electrical potential and keeping his thoughts so busy with something else that any thought of them does not intrude into his consciousness.

But those who in the next life live in these slums and hells cannot turn to some other vibratory rate so easily; for it is their dominant vibratory rate. When the desire comes for a more unselfish kind of life, their vibratory rate rises, and they gradually acquire the power to move across the thought-built bridge to a higher realm. But when their associates perceive what they are trying to do, they clutch at them and do all in their power to hold them back. They leave only after a struggle. Even with the missionaries' help, not infrequently they are drawn back by their fellows who set upon them like a pack of wolves. Yet if they continue to aspire, and do not give way to discouragement, in the end they will win.

And when they win to a higher level, what joy is there for all. Exhausted by the struggle, they are taken by guides to a place of rest. And after their vitality has been restored they are shown about this new and glorious land. The minute corner of the universe from which they have emerged was very real to them, however unimportant in the universal scheme. But now they have before them, as the result of their own efforts, a life of an intensity, interest, and enjoyment such as previously they could hardly have imagined.

Chapter 8

Serial No. 180
Original Copyright 1943
Elbert Benjamine

Copyright
Church of Light
August 2002

Domestic Relations of the Next Life

Chapter 8

Domestic Relations of the Next Life

AFTER your birth, and a period of adjustment, into the next life, you will not find yourself an inhabitant of the astral slums, and unless you are a very exceptional individual, a true saint or adept, you will not pass immediately to the still higher velocity spiritual spheres. The ordinary person, who is neither a saint nor a devil, starts the duties of his new existence on some of the astral levels not too remote from earth.

The habitual criminal and the insane must be considered in any comprehensive account of human society on the earth. And in like manner it has seemed necessary to describe something of the abode and life of the gross and really wicked in the after-life. But these people and their habits are not the normal conditions of the next-life lands. No more so than hospitals, prisons and insane asylums are normal for the general run of humanity on earth. And the usual condition in which the vast run of people find themselves not long after passing to the next realm is superior in many respects to their condition while on earth.

Not that everything straightens out just to one's satisfaction merely by passing to the next life; but that many things which cause difficulty on earth are there handled in a far superior manner. No one, through an imperfect economic system, for instance, is deprived of the privilege of work, or denied sustenance. Such hunger as is experienced in the afterlife is for greater knowledge, for greater ability to serve, and for the spiritual attainments that enable the individual to rise to more glorious spheres of life.

You have been accustomed to eating about ever so often, and when you emerge from the period of adjustment to conditions there, this habit may still be rather strong. You do not need to eat food to sustain vitality, because the energy you require can be gained, and on the higher levels is gained, more directly by transpiration. But so long as you still crave solid food, that food can easily be supplied. No flesh can be had, but very acceptable substitutes may be secured, until the habit of using this kind of substance has vanished.

But you do not buy your food. Instead, you make it. At first you will be unable to do this, and others will help you make what you want, and will instruct you how to do this work for yourself. Yet when you have had some experience, by means of thought-power, you will be able to coagulate the astral substance of your surroundings into any form and substance that you can clearly visualize. And in this manner you can supply yourself with any kind of food you desire.

You might think that in a land where there is no rain, little wind, no great extremes of heat and cold, that shelter would be unnecessary. There are regions which you probably will not visit in which there are conditions resembling the storms and weather inclemencies of earth. But where most people go the climate is quite serene. Yet in spite of this, homes, laboratory houses, and public buildings are found to be advantageous.

The Need of Shelter

—They are so constructed as to afford a certain amount of insulation from the influence of various kinds of vibratory rates from the outside. Vibrations that correspond to those we on earth apprehend by means of sight and sound have great range and freedom of movement on the astral plane, and annoyance from them is prevented by the sheltering walls of one's dwelling or of the building where one works.

Astrological influences also set up various vortices of force that sweep over the astral terrain with tremendous power. I do not here refer to those astrological influences that work in the lives of individuals; for these are internal releases of energy that operate much as do progressed aspects on earth, and therefore cannot be cut off or prevented from expression by any kind of astral house. Instead I mean that astrological conditions corresponding somewhat to those caused by the current positions of the planets in relation to each other, as shown from day to day in the ephemeris, set up, at times, astrological storms that resemble somewhat the electrical storms of earth. These astrological pressures would tend to deflect the population of a region from their predetermined course. And thus houses are constructed to insulate those within from this class of astrological influences; permitting them to direct their energies to other things without the necessity of resisting such pressures or storms.

Not only are the buildings of the astral plane so constructed as to insulate their inhabitants from outside interference, but they provide another function not common to houses on earth. They afford a means of concentrating the energies of those occupying them. The thoughts, by means of the insulating walls, are prevented from wasteful dissipation of their power. By means of specially constructed transmitters these thoughts may be either broadcast or sent as a beam in special directions. And by means of condensers they are able, there, to receive thought messages even from far distant levels.

For their curative effect, or for their use in special kinds of work, it is possible to build the walls and roof of a substance that will shut out all but certain astrological rays. The windows still permit the entrance of the astral light, which is rather constant in its luminosity at any particular point; but only the astrological influence needed finds its way into the house. The general principle is that which is utilized on earth when glass is used to permit only blue light, or only red light, or only yellow light, to enter. Substances are used which permit the passage of only one or more astrological ray.

On earth we have as yet found no means, other than using the human nervous system, of collecting in concentrated volume and intensity the energy of a given planet and directing it into the body, and specifically to the organ where it is needed, to correct some discord that in human life manifests as disease.

On either plane the events attracted into the life, including the diseases that develop in the physical body on the outer plane, are due to the activity of certain groups of thought-cells exerting extra-physical power upon the environment then occupied by the individual. If, through any means, either the intensity of the activity, or the desires, of a given group of thought-cells is changed, the events attracted also will be changed. This means in physical life that if the discordant activity of a group of thought-cells which is responsible for a disease is changed into harmonious activity, the disease will disappear. In a broader sense, as explained in detail in Course 16, Stellar Diagnosis and Stellar Healing, unfortunate events of all kinds, as well as those affecting the health, are diseases, that is, they are conditions attracted by inharmonious, or unbalanced, thought-cell activity.

And in Course 16 is explained how a Stellar Healer who has trained his nervous system so that he can tune in on the vibrations of any particular planet, can pick up, radio fashion, the astral vibrations of that planet, and using the electromagnetic energy generated by his nerves as conductors, can direct it harmoniously and in concentrated volume, to the thought-cell group within a patient that needs this particular energy either to recondition it, or to give it greater activity. Such treatment with planetary energies was first given great attention by, and widely used during the reign of, Akhenaten in Egypt over 3,000 years ago. When properly applied by one duly qualified, it is most successful not merely in healing the ills of the mind and body, but in healing the ills of the pocketbook, the domestic existence, and those of all the other twelve departments of life.

To be sure, not everyone can apply this method, and its technique is open to much improvement. But other than using thought to change the volume of thought-cell activity and the desires of the thought-cells, it is the only manner of healing that goes directly to, and changes the chief cause of a disease. Environment may give facilities for a given disease or given misfortune, but the disease or misfortune only comes into the life when the thought-cell activity especially favors it. The thought-cell activity is thus the chief cause of any disease. And by properly changing the thought-cell activity, either through a specially selected type of thinking and feeling, or through feeding the thought-cells planetary energies that cause them to have different desires, the basic cause is reached, and the disease prevented or cured.

And while not needed to prevent or cure bodily illness on the astral plane, properly changing the thought-cell activity so that unfortunate events will not be attracted, and so that fortunate events will come into the life, is just as important on the inner plane as on the outer. But there they have produced substances that permit only the planetary ray needed to enter a room, and shuts out the others. And by thought power, even as the Stellar Healer on earth also must use thought-power for the same purpose, this planetary energy is directed specifically to the thought-cells which need it to correct their discord or to give them greater activity.

There is no day and no night on the astral plane, but as one moves to levels higher than the earth-plane there is plenty of light. This light is of a diffusive nature, and differs in intensity on different levels, and in tint of color in different places. Every variety of color on earth is present in the astral realm in more vivid tone, and there are other ranges of tints with which earth is quite unfamiliar. Due to the astrological rulership of localities, which also determines the kind of work done there, the light of each locality tends to take on at least a faint tint of corresponding color. Thus, from the intensity and tint of the light in a region alone, much can be learned about the development and activities of its inhabitants.

Home

—All this is preliminary explanation to pointing out that when you become adjusted to the next life you will have a home. Home in the spiritual world contains certain treasures, built of your longings, aspirations and spiritual triumphs. But home on the astral plane, where you probably will sojourn for a while, if you have made some reasonable advancement before leaving the physical plane and are ready to take up your work in the new realm, will be of your own choosing.

You are not compelled to live in any particular kind of house; not so much so as on earth where the pocketbook has so much influence. And, while you may do so if you desire, you are not compelled to build your own domicile. If you have not advanced far enough to be anxious to perform your own function in this new commonwealth it may be difficult to secure the assistance of others. But I am assuming that you are ready and anxious to render assistance to others to the extent of your training and ability. And in this case, if you do not know just what kind of a house you want, or how it should be arranged there are those who specialize in architecture, and those who specialize in home construction, who will gladly either advise you or build your home. Nor will they ask for compensation. Your own work for the good of others is their sufficient reward.

Clothing

—When you arrive in the next life you will not be without clothing. This may be largely due to your habit of wearing clothing in the earth-life, but the custom is continued in the astral world for still another reason. This clothing with which you enter the new plane bears, in its texture and completion, a direct correspondence to your character. Those of the astral slums have little or no power to dress themselves in garments other than those corresponding to their dissipated estate. And even on the highest astral levels, far above the middle region we are now discussing, the radiance of the garb unerringly proclaims the spiritual state of development of its owner. Nor do we find, as on earth, a really shabby character covered with rich apparel.

But on the plane where you will probably find yourself, you will have a wide choice of garments. There are materials of many grades, and of ingenious textures that not yet, but some day, will be reproduced on earth. The colors that may be had are all that earth affords, and whole ranges of other tints and hues of wondrously pleasing effect that cannot be duplicated here. The brilliancy and quality alone are restricted by the plane you occupy; for you cannot wear the material of a higher level. And before you can have any choice in your garments, some progress must be made. This progress, resulting from your desire and effort to do something constructive and beneficial for others, widens your freedom in this and in many other respects.

The clothing, which may be selected for its effect of stimulating certain thoughts and energies, or for its power to insulate you from certain vibratory influences that seem unfavorable, as well as for its appearance, may be had in an amazing variety of color combinations and designs. It is thought-built, as is most astral construction; but is not less firm, and may be even more durable, than the clothing of earth. If you prefer, after you learn how, you can make your own garments. Or if you do not care to do this, there are others who specialize in such work, who can fit you becomingly. Your own contribution to cosmic progress will be all the reward they expect or desire.

You will find the astral world, I am sure, a very different place from the orthodox heaven in which there is almost no variety or change. You will not have the same weather changes that you have on earth, but there are differences in astrological influx that give climatic variations of sufficient breadth and intensity that one, if he leaves the insulation of buildings, need never complain of its sameness. In the architecture of the buildings, and the design and arrangement of homes, there is far greater latitude, and a higher development of line, form, and arrangement than is known on earth. Even the landscaping about the buildings and homes, the arrangement of flower plots and gardens, and the murmuring brooks and tinkling fountains, offer a richness of composition to anyone on this astral plane far surpassing that possible even to the potentates of earth.

Nor is it surprising that beauty should be apparent in the garb; for the appreciation of the beautiful refines the tastes and through cultivation of higher emotional responses builds up the spiritual qualities. Dress, therefore, is selected not merely as appropriate to the character, and as contributing to, or protecting from, vibratory elements, but also for its esthetic value. And the artistic effects that are thus produced, in the land where you probably will a little later dwell, are far more pleasing and of far greater variety than anything you have ever experienced on earth.

Jokes

—Yet beauty and utility comprise but a part of the variety to be found in the next life; for there are all the pleasant relations of human companionship, and even more opportunities for the exchange of thought than here. It is not a region of continuous seriousness; for merry-making also performs its part. Jokes and quips, you will find, are still appreciated over there.

As illustrative of this, I will relate the experience of a friend who dropped into our classroom for a little chat just at the time this lesson was first being written. She is very fond of all work pertaining to healing, and in addition to her activities on the physical plane, spends a part of her time out of the body doing similar work in the astral world. This is mentioned not to comment on the inadvisability of this kind of work for all except those specially qualified, but merely to explain why she was out of her body and why she happened to be at a hospital where people are born into the next life.

She said she went to this particular hospital to see how they handled patients that came from the earthplane in a badly mangled condition. And among others to be brought, while she was there, was an Irishman who accidentally had been run over by a locomotive, so that his physical body was not much more than scrap-meat. He was unconscious when brought in, and his awakening to consciousness in this hospital constituted his birth into the next life.

At his bed-side, anxiously awaiting his birth that she might welcome him with open arms and loving kindness was his wife, who had passed over some years before. He had been aware that the engine had struck him, but had then quickly lapsed into sleep. And now, as he regained consciousness, he was quite aware that he had passed over. But as he saw his wife tenderly bending over him he could not resist a bit of fun, and as he arose with a glad smile to embrace her he remarked, "It's all just like it used to be. I thought I was hit by a railroad train, and when I come to, I find you standing over me."

Domestic Ties

—These domestic, and other emotional ties of earth, are not severed at the moment of death. They persist as influences in the life until there has been some more adequate adjustment. Of this, however, you may be assured, there are no ties of compulsion. No one is forced to live with, or remain in the company of, anyone who is distasteful.

Where one person has injured another, or where there is a debt of gratitude that seems to require it, the two may be drawn together by a mutual desire to rectify the mistake or make payment possible. Faced by the records of their motives and deeds, as recorded in the astral light, one may feel that the best way to remedy a condition established on earth is to seek out the other person; and the other person, desirous that the one person should not find the avenue of progress closed, may acquiesce in this. But people on the astral plane, at least in the realm where you are apt to find yourself, cannot force their unwelcome company on others.

No one is forced into marriage on the astral plane; but companionship between man and woman is the rule rather than the exception. It is the foundation of home life there, even as it is here. The offspring of such unions, however, are thought creations, and not children; although, to the extent there are strong common interests and emotional ties, the children of earth may live close to their physical parents; several generations sometimes constituting such a group.

On earth, certain physical considerations often play an important part in marriage; but these physical considerations have no weight in the next life. There people are attracted to each other, and unions are formed, on the basis of complementary affinity.

This is not merely planetary attraction, such as sometimes causes people of earth to experience a wild infatuation for each other, only to bum out after a time. Infatuations are due to one or more groups of thought-cells in the astral body of each finding exceptional facilities for energy exchange with a group of thought-cells in the astral form of the other. If such exchanges are due to dynamic thought-cell structures mapped in the birth-chart, the attraction may be permanent; but if due only to thought-cell activity stimulated by progressed planetary positions, they are temporary, and later both persons may wonder why they ever were attracted to the other.

But the complementary affinity, of which I here speak, is a fuller measure of attraction which is afforded by the harmonious relation of the finer forms based upon similarity of fitness in the cosmic scheme of things. That is, each individual is being fitted by all his experiences to fill a definite position in the cosmic work. And this work, as it is to be performed in celestial realms, requires the united efforts of man and woman who have attained to those exalted states. They each, therefore, in the lower spheres, are developing certain characteristics which fit them to perform this identical cosmic work, each to act as the inspiration and complementary helpmate of the other.

This does not mean that those who are perfect complements of each other commonly meet in the astral world. But those who, by virtue of developing qualities that more nearly fit them for performing the same function, because of the complementary nature of the vibratory rates constituting their characters, are strongly drawn toward each other.

Man and woman, in the higher spheres, each form one-half of a unit that performs a definite function in cosmic society. In the performance of this particular function both contribute, but the type of their contribution is characteristic of the sex. Their development, consequently, to perform this function, is not identical, but complementary. And to the extent they thus have characteristics that enable them together to perform this same function, even though they are not the perfect complements of each other, are there those similar and complementary vibratory rates within the forms they now occupy that are attractive and give them pleasure in each other's company.

In the after-life love and affection play quite as important a part as they do on earth. And because the form is finer and more sensitive to vibrations, and the senses more keenly alive, the enjoyments resulting from such human relations are more intense and rapturous than any that can be experienced in the gross body of earth. Yet because of this increased responsiveness, the attractions of the new life are much less haphazard than those commonly observed on earth. And those that draw man and woman together as domestic companions and helpmates are kindred tastes, identical aspirations, harmony of vibration and the complementary characteristics which enable them together to perform some useful work.

The creative energies of man and wife on the astral plane are as important to the production of creative work there as they are on earth in the generation of children. Creative work, on any plane, consumes creative energy. Even on the physical plane the new things are brought forth only by those with surplus creative energy. Great artists, poets, inventors, and writers cannot be deficient in virility. And this creative dynamo is best maintained at productive level through the responsive vibrations of pure love and high affection between man and his mate.

Thus the relation of marriage, although on the higher astral levels devoid of its grosser aspects, is not confined to earth, but represents sacred functions in the highest heaven.

Yet just because two people were married while on earth does not compel them to eternal companionship in the spheres of the future, nor does it preclude such companionship. Neither is there any compulsion in regard to entering into domestic partnership on the astral plane. Until such time as the emotional education of the individual engenders the desire for matrimony he is quite free to go his way alone. In all such matters much less pressure is brought to bear than is customary on earth, and there is much more opportunity to exercise liberty of choice and liberty of action. Partnerships in the next life are formed only when the attractions and desires are mutual.

The emotional ties that were formed on earth are not severed when one passes to the next plane. The love between husband and wife, and between parents and children, persists. Yet, even on earth, we find normally six successive levels of affectional development. In infancy there is the “narcissus” emotional level. The infant next transfers his love nature from himself to his parents. At a later stage, there is the hero-worship level. The fourth stage of emotional development is the transference of the affection to the one who later becomes the husband or wife. In the fifth step the affections for the partner should not be less, but there is a broadening of the emotions to include children. And then, after the children are reared and gone from home, there is the regenerate level. Even this level often is not reached because people all too frequently never emotionally mature. This whole subject is treated in detail in lesson number 160.

The seventh emotional stage of development, that of the spiritual union of soul-mates, is seldom reached on earth. And it is not the common thing in the astral region, where most live shortly after physical death, for men and women to find their true soul-mates. But this seventh emotional stage, nevertheless, is the basis for affectional adjustments in the next life.

At each of the six levels in the normal development of man’s emotional life he forms attachments that he deems at the time could never be broken or transferred without rending his heart. The school girl who has a “crush” on her lady teacher, or on some other girl, just cannot imagine herself ever relinquishing this love and substituting in its stead the love of some young man. Yet in the normal development of her love-life she does just this. And the mother, while her children are young, cannot bear even to think of their ever leaving her. Yet if she is wise, when they are of proper age, she no longer holds them, but encourages them to go out into life and establish homes of their own.

Normal emotional development requires, at different stages of the life, affectional readjustments. And in the affectional readjustments of the next life, the seventh affectional level may be a continuance or a transfer, of the affections, as the case may be. To the extent that man and wife on earth are really suited to each other, not merely because of habit but because of being close complements of each other, their companionship in the next life is apt to prove enduring. And to the extent they are really unsuited to each other, in spite of their marriage on earth, the companionship is likely to be severed at the time of passing, or shortly after entrance into the next world.

Because the real source of one-sided attractions can so readily be perceived and analyzed, the emotional re-education that is acquired with any marked progress in the next life provides for a healthy transfer of interest to a proper affectional object. I do not mean that one-sided love affairs are non-existent on the inner planes; but that they persist only among those who have made little progress; for as soon as some progress is made there is a reconditioning toward affectional objects. This leads to proper responses that displace any object of unrequited love. Love, on the more advanced astral levels, is always reciprocal.

This reciprocal love, however, does not imply true soul-mates. It merely implies a more or less complete degree of vibratory blending that is generated by characters that find in each other more or less complete complements. On the astral plane it is possible for perfect marriages to take place, and such are consummated far more frequently there than on the earth-plane. But such perfect conditions are not the general rule.

Instead, the degree of perfection that is possible to the development and evolutionary requirements of the individual must be substituted. Perfection, even in this matter of affectional relations, is not reached at a single step, or without effort. At first the ties of earth, if they are pleasant, dominate the affections. And if they are based upon something more enduring than the temporary needs of physical life, they will not be severed, at least until progress has been made to a point where they are no longer useful and pleasurable. But as time passes, one meets many others in this new sphere where one now sojourns.

Then come problems arising from new contacts, and from those previously established on earth. But there are learned astrologers, and those who specialize in affectional readjustments, to offer advice and to help in finding a solution satisfactory to everyone. Yet often, before this readjustment can be made, all parties concerned must take a course in emotional re-education.

Several Husbands Or Wives

—When several husbands who were married at different times to the same wife on earth, all try to claim her in the next life, there are complications present that cannot satisfactorily be solved except by making plain the true basis of affectional relations as they now obtain. It may be that none of these husbands of earth is really the most suitable companion for her, or it may be that one of them is quite satisfactory. In the latter case this suitability is felt as the strongest attraction. Or if some other, who can be located or who already has been contacted, is more suitable, these two, when brought into each other's presence, experience the strongest attraction.

And it is the function of certain astrologers of that plane to search out and bring together those who are particularly suited to each other. The disconsolate partners of earth who are less suited are taken in hand by those specializing in emotional re-education. They are shown how foolish it is to have a "fixation" on an individual who is really far less suited to be the domestic partner than some other. This is not merely an appeal to reason; but is carried out under the laws governing the proper reconditioning of the emotions. And in due course of time, through the efforts of these astrologers, or by virtue of their constructive work on the plane they now occupy, they are brought into touch with some other who is far more suitable, and toward whom they can feel much deeper affection than they ever did, or could, feel for the previous partner of earth.

As progress is made from one level of the astral world to another, it may, or may not, as the result of marked development, usually extending over long periods of time, make desirable still other affectional adjustments. When the sixth state of the spiritual world is reached, merely as the result of having reached this exalted condition, true soul-mates attract and recognize each other. This is one of the natural results of high spiritual development. But on any level of the spiritual world less advanced than this, and on any astral level whatever, due to many factors, it may, or may not, be possible to contact the true soul-mate. But when there is need and desire for a domestic companion, a mate is attracted that more or less approximates the true ideal.

But these affectional attachments, which take the place of marriage on earth, are not permanent until the true soul-mate has been found. They serve a purpose, often a very good and valuable purpose, on the level where they occur. But the more speedy advancement of one or the other may later make separation desirable. One may be ready to pass to a new level of endeavor long before the other. This may make advisable new affectional adjustments. If, however, the complementary affinity is pronounced, even the passing of one to an entirely different plane—from earth-plane to astral plane, or from the astral to the spiritual plane—does not weaken the affectional relationship. They continue to work for a common end, remaining in communication, by their thoughts, across the planes.

Separations

—Yet where it is found that the usefulness of a particular domestic partnership has been outlived, it can be dissolved in favor of one more suitable to all parties concerned. And because a recognition of emotional states as important factors in spiritual development is common to any astral level much above the earth-plane, such readjustments of this kind as seem necessary are free from jealousy, envy, or animus of any sort. I cannot say they are always free from the sense of loss; but they are looked upon as experiences necessary for proper spiritual growth.

This matter of the passing of one partner in marriage to a new plane—passing from earth-life to inner-plane life, for instance—frequently poses a problem requiring the most serious thought to solve. The partner left on earth, if the bond of affection has been strong, not only continues to experience the sense of loss, but may grieve over a long period of time. These thoughts of grief not only build discords into his own thought-cells but they also reach the one who has passed to the inner plane, and through the mental treatment which moves over the lines of the rapport that has been established through their past relationship, discordantly affects the one on the inner plane who, unless he builds up a high potential and exerts himself to the utmost to prevent it, feels all the emotions of the one on earth.

Yet even those who realize they should not thus think of the loved one who has passed while holding discordant emotions, often do not know what line of conduct to pursue. They feel that to forget the one who has passed and turn their attention to other things is to be disloyal. Because of their sense of loyalty they take pains that no new affectional interest shall enter their lives. They feel they should continue to be as true to the one who has passed as if that one were still with them on earth.

Each of such problems is somewhat different from others, and each therefore must be solved on its own merits. And the one sure criterion, as it also must be the criterion of all other actions, is the comparative amount each course of conduct will contribute to universal welfare.

There certainly are instances where the bond of love is so strong and so high that it should not permit the physical death of one, or anything else, to sever it. Under such conditions the thought of the other proves an inspiration to each, and provides an incentive for greater and greater effort to render higher and more abundant service, and to progress spiritually.

But in many other instances the one on earth continuing to keep the other strongly in the consciousness, holds and disturbs the one on the inner plane sufficiently that he cannot properly attend to his duties there. And the one on earth thus consumes so much energy and attention thinking about the one who has passed on that he is unable to do as much as he otherwise would. Neither is making the progress, and neither is contributing as much to universal welfare, as if each had turned his attention to the things of the plane he occupies, and started living there to his fullest.

Under such circumstances, instead of both remaining static, and much less useful than they should be, if affection is essential to happiness, progress and efficiency, it is much better for both to find a new affectional interest, and the one on the physical plane to marry again.

Parents, on earth, usually experience some feeling of loss when their children grow up and depart from home. But if they are wise parents they do not hinder this departure at the proper time. To do so is to thwart the life of the children and to incase themselves in a shell of narrow selfishness. And in the next life, the desire to have the interest of society as a whole advanced as rapidly as possible outweighs any temporary feeling of loneliness. And furthermore, such steps usually are not taken without the counsel of astrologers, and experts in emotional matters, who give advice and practical aid to make the affectional readjustments satisfactory and beneficial to everyone concerned.

It may seem strange to the visitor from earth that those once married and now no longer so, remain the best of friends. If the marriage was merely that of earth, and marked by brutalities and discords, you may be sure it is not resumed in the next life. But if there are elements of harmony sufficient to carryover into the life after physical death, or if it is a domestic partnership entered into after passing from the physical plane, it is looked upon by both persons as a happy even though perhaps only temporary, relationship of benefit to both. The fact that this relationship has outgrown its usefulness, and that progress has brought new affectional contacts, does not make them enemies. On the contrary, each has a kindly regard for the other, and a special interest in doing everything that in any way will assist the other to happiness, to the successful performance of his work, and to spiritual progress.

And while I have been compelled, in order to give any adequate description of domestic affairs in the next life, to speak of these affectional readjustments, I trust no one will conclude the next world is a place given over to swapping partners. How fast an individual moves from one astral level to another depends entirely upon himself, and it may be very swift or very slow. But following the initial adjustment to domestic affairs after passing from earth, even in those cases where such changes become desirable, it is unlikely a subsequent affectional readjustment would take place within a period of time comparable to the ordinary length of life of man upon the earth.

Reality Is Faced

—On earth a great many desires and activities are glossed over and made to appear very different from what they really are. But in the next life, as soon as there has been even a very little progress, everything about oneself and others is faced for what it really is. Selfishness and carnality cannot be hidden from others if it is present, nor given every appearance of beauty by bestowing upon it an euphonious name. Every thought and motive is viewed in all its stark reality.

Yet on the other hand, no shame is attached to the exercise of any natural function. The companionship and domestic life of man and woman are accepted as beautiful expressions of love. It serves a manifold purpose. The emotions it engenders in each tend to refine them and thus raise their spirituality. The love-thought of each going out to the other is a healing balm, and the thought-image each holds of the other in loving helpfulness becomes the ideal into which this other tends to develop and grow. It is a potent force and treatment aiding in his advancement. And the energy generated by their mutual attraction is a mighty reservoir upon which they can draw for the performance of their selected work.

Transforming Energy

—You must realize that on any plane accomplishment consumes energy, and that the energy supply that can be effectively used by any individual, or group of individuals, is restricted by individual limitations. On the physical plane some of the energy we use in our activities is derived from the consumption of fuels within the body. A considerable portion of this fuel supply is furnished by breathing. And on the astral plane a process somewhat analogous to breathing is the chief means of supplying the energies used in the activities there. This breathing, of course, is not of air, but of the energy-charged atmosphere of the plane occupied.

The form, on any plane, does not create energy, but merely acts as a transformer of energy. People on earth have energy in varying amounts and grades because they have different ability to transform it and turn it into paths of their own choosing. And when they pass to the next life they do not suddenly develop the power to divert an unlimited amount of energy and convert it to their own use. Thinking and all other activities of the next life consume energy, and this energy must be provided from some source. Mere breathing does not yield an unlimited supply, no more so than a man may gain unlimited strength on the physical plane merely by eating an enormous quantity of food. The power to transform energy depends upon the individual.

One of the greatest problems that confronts every person, not merely on earth and in the astral world but also in the highest conceivable states, is how to increase the quality and quantity of energy that- can be used. The quality of energy received and transmitted depends upon the refinement of the organism through which it passes. To refine the thoughts, emotions and form is to gain ability to use a higher-frequency energy. And because of its higher frequency, the more spiritual the energy thus handled, the more real power.

Yet quality of energy is only part of the problem; for to accomplish anything worthwhile on the plane where this energy is used it must be utilized in volume. And this is where the intensity of the thoughts, desires and aspirations play their part. For it is through mental and emotional intensity that large volumes of energy are taken from the atmosphere in the process analogous to breathing.

Man and woman, therefore, when the love attraction between them is pure, strong and unwavering, as when such domestic life as I have described obtains, constitute a natural dynamo for the generation of energy on the plane where they work. Their love-life enables them to accomplish tasks of magnitude without undue fatigue.

In this region, which is not close to earth, there is no night and day, but there are periods of activity and repose. And fatigue also is present as the result of prolonged or strenuous activity. It is not due, as on earth, largely to the presence of lactic acid in the blood, but to lack of sufficient energy to keep up the desired activity. Before activities are resumed there must be a recharging of the psychic batteries, as it were. Harmonious domestic life, recreations of various kinds, rest, relaxation, and music, all contribute to this revitalization.

It would be pleasant reading to some if I could say that in the next life there were no troubles, no obstacles, no difficulties, no disappointments no sorrows, no pain, no fatigue, and nothing distasteful.

I find, however, that in the slums and hells there is even something very much resembling physical pain. And there are still anxieties, until one has progressed to a point, through the practice of spiritual alchemy in which one refuses to be anxious. These anxieties on the level where you will probably find yourself, will not be concerning yourself, but concerning the possible happenings and conditions to be faced by loved ones remaining on earth.

Fear can be experienced in that after realm quite as vividly as on earth. But the progressive person soon realizes what he should comprehend before leaving earth, that fear has no useful part to play in the life of any enlightened man, and merely tends to attract the condition feared. Nothing, without your permission, can injure your immortal soul. Anxiety and fear are obstacles in your path that now or later you must rise above. Before you have made much progress in the next life they must be left behind.

I have already mentioned that sorrows may arise over separations that take place among those in the after-life. Sorrow may also arise over failure; for even in the next life people do not always attain at once their aims. But the most common source of sorrow is the thoughts of loved ones still on earth that carry even to the rather interior levels. Those left on earth often grieve for years, and their thoughts reaching loved ones in the next life may cause much sorrow.

Yet as progress is made to higher levels, all grief and sorrow is left behind. Not because there are no more separations, nor because the loved ones on earth have been forgotten, nor because those on higher levels always are successful in their endeavors. Sorrow is left behind because there has been sufficient emotional and spiritual advancement to realize it is better for all concerned to raise a barrier against the thoughts of grieving ones on earth. And because it is realized that separations, disappointments, and failures, by a proper attitude toward them, can be made spiritual assets of great value. As one moves from lower to higher astral levels one observes less and less of sorrow and more and more the prevalence of radiant Joy.

The universe moves forward in its ever more perfect development through the labors of its co-operative intelligent parts. Never is there reached a point where nothing remains to be accomplished. And those in the next life can always find something worth doing that, no matter how much energy they command, enables them, in a good cause, to become fatigued. The progressive plan of things always provides still other obstacles when some have been overcome.

The next life is not a tepid region of inaction. But the people in the advanced levels do not have the troubles of those on earth. This is largely because, through their advancement, they know how to live constructively. They do have the advantage of a better system of human relations, and they are not faced by some of the stringent necessities that beset those on earth. But of still more importance than this, they have learned more about how to live to be happy. And if we would be guided by their wisdom we also could learn and practice this art before leaving earth.

Chapter 9

Serial No. 181
Original Copyright 1943
Elbert Benjamine

Copyright
Church of Light
August 2002

Social Contacts and Amusements in the Next Life

Chapter 9

Social Contacts and Amusements in the Next Life

IF YOU have made some mental and spiritual progress while here, you will find yourself, not long after passing over, amid conditions that in many respects resemble those left on earth. The objects you contact will possess certain new and rather startling properties by virtue of the greater-than-light velocity of this realm. But there will be administration buildings, laboratory buildings, industrial buildings, and houses that are used as homes. There will be plants and flowers that resemble those of earth, and others with which you are unfamiliar. Animal life is abundant on the levels close to earth, but as you reach higher levels you will find other bright creatures of considerable intelligence that have no earthly counterpart. And there will be people representing a wide variation in race and color.

If you are of the incurious, stay-at-home type, the races of people you normally will contact in the duties of your new existence will be quite numerous enough to be satisfying. But if you have a temperament that delights in exploration and in unusual discoveries, this tendency can find full and thrilling scope for operation. And in the journeys you can take, accompanied at first by a competent guide, you will be able, if you desire, to contact people who have had their evolution on other planets than the earth; not merely on other planets of the solar system, but on planets belonging to other systems.

I do not wish to imply that the only highly developed beings that are evolved within this galaxy we call the Milky Way are of the human form. In fact, from what I have seen, I am confident there are orders of beings and intelligences of which man has scarcely dreamed, and of whose functions his intellect is too puny even to guess. But I do have reason to believe that the human form is evolved on other planets of our system, and on other planets belonging to other systems. And when you pass to the next life, if you are sufficiently interested in adventure and travel, you can pay a visit to the astral regions that form the abode of certain of these other planetary-system people.

Origin Of The Human Form

—If you take such a trip you will encounter many quaint customs. And you will be struck by many minor divergences from our habits of life. But even more you will be surprised to find how closely all these people are to the well recognized human form. Their proportions are sometimes markedly different; but they are real human beings, and not distorted caricatures. The queer antenna, bird-like feet, and beetle-like head, so attractive to the writers of the Sunday Supplement of the daily newspapers in picturing the denizens of other planets, are noticeable only by their absence. These people may be tall or short, slim or chunky, with long limbs or those more moderate, with rather large heads or rather small heads, but, in so far as I am aware, they are all distinctly and emphatically human.

The explanation given to me was that this human form is the natural product of evolution in the planetary streams of systems resembling our own. What other kinds of systems bring forth, at the present time I have not the slightest idea. But it seems that our solar system is a definite type that, with some variation, occurs elsewhere in the stellar galaxy. And in all systems of this type the astrological energies beat upon the finer bodies of organisms there evolved very much in the same way. That is, they all have a similar astral environment.

It is generally believed by naturalists on earth that the linear form, which is the common characteristic of fish that live in swift streams, was developed through the pressure of the water of such streams on organisms that previously were neither linear nor flexible. This particular form was developed because it offered less resistance to the current by which it was surrounded. If the fish were to live in swift-running water, they were compelled to develop a form which would offer as little resistance as possible to water movement. This subject is considered in more detail in Course 12-1, Evolution of Life, Chapter 4.

As it was explained to me, a thought-cell form in which every section and function of the universe is present in miniature offers less resistance to the astral currents by which it is surrounded than any other possible form. As life evolves on the earth, or on other planets, the pressure of these astrological currents make thought-cell expression easier the more closely the form approaches that of normal man. Because man, of all the creatures, is a complete microcosm, or miniature duplicate of the universe, there is less resistance to his mental activities than to those of any other creature. He is man not just because his remote ancestors learned to walk on their hind legs, but because, as man, his thought-cell form can move through the in-visible currents with a mental freedom that would be impossible to some other form.

It is not for me to say what forms may, or may not, be assumed by those now human in the illimitable future; but in so far as I have been able to peer, the human form, although much perfected in detail, continues to persist. At least the human shape is that common to man in all levels of both the astral and the spiritual worlds. And it is the shape of those you will meet even in distant travel.

Exploration

—I cannot say, because I do not know, how many and how extensive are the territories it is possible to visit after you pass to the next life. I do know that the opportunities for exploration are immensely greater than those limited by the sphere called earth. There are depths of space into which no one with whom I have talked has ever gone, or even knows anything definitely about. Within the familiar limits of the astral levels where most people continue to live, life moves forward serenely and with little hazard. But off, apparently beyond the boundaries of the inhabited regions, perhaps even beyond the edge of our own stellar galaxy, are other, and unexplored regions.

No one is compelled to take trips beyond the region where dwell his own kind of people. But if you are adventurously inclined, and demand action and hazard, you will find plenty of opportunity to test your ability and courage. If you seek them out, there are real dangers to be encountered in exploring the boundary lands.

And although in the next life you pass beyond the influence of the physical world, and therefore beyond the rotation of the earth, there are still directions which correspond to north, south, east and west. The sun does not rise and set, but, except in the hells, there is always light of some degree of intensity. This light apparently is diffusive, but a little attention indicates that the vibratory waves thus manifesting as light have a direction of travel. That is, instead of beating down from above, they move across the country, and the general direction of movement, although not perceptible unless attention is closely directed to it, can be sensed.

The direction from which this light comes corresponds to east, and if you face this direction, north will be at your left hand, south at your right hand, and west at your back. This is not altogether an accurate description of the directions in the after-realm; but it is as close as I can give it in slower-than-light velocity terms. In reality you do not analyze as I have done, you just have a sense of direction.

I suppose that our ancestors of several hundred years ago, if they had been told about the modern automobile and airplane, would have jumped at once to the conclusion that a people possessed of these conveniences of travel would never deign to move about on foot. Yet about our streets, as well as on health-developing trips into the country or through the mountains, it is still customary to meet pedestrians. In spite of possessing other methods of locomotion, people still find it advantageous to do some walking.

Thus in the next life, while for long trips from one region to another, and for movement between the levels, aerial travel is the customary method of transport, you will find that walking is no less popular there for going on short excursions, and about the everyday affairs, than it is here. People walk about the gardens and parks, walk through the buildings, and take walks through the country, very much as they do on earth. But when there is a demand for a quicker mode of travel, they can generate a thought-power such as we call extra-physical power, that carries them almost instantly to their destination.

One cannot speak of chance meetings and be entirely accurate. The contacts with other people that we form in the present life, and in the next one, are not brought about by chance, but because we have within our finer form thought-cells that attract to us, when they are given additional activity by thought or by astrological releases, people that have an influence similar to their desires. Yet just such meetings as on earth we commonly term chance meetings also occur on the inner planes. And in that life, also, people so met may exert a profound influence upon our lives.

Acquaintances

—I need not here go into the detail of how, in the next life, we can attract others to us; because the method there is precisely the same as the method here, as explained in Course 14, Occultism Applied, Chapters 5, 6 and 10. The only thing that needs to be added is that in the next life as well as in this one, if there is a strong, persistent and devout desire to accomplish some definite thing for the benefit of humanity this desire radiates an energy which is felt, consciously or unconsciously, by those who are best fitted to give instructions and assistance in this work. Such aspiration is a powerful force to attract both people and things into the life that can aid in its realization.

But it is not merely those who help us who have an influence on our lives. There are others whom we meet here, and some whom we meet in the after-life, who are not attracted through our desire to accomplish some constructive work. Yet if the contact is once made and if some degree of association results, it carries with it also some degree of responsibility. It is a responsibility that requires the finest powers of discrimination properly to fulfill. We should never permit these people to detract from our larger usefulness to society through their demands upon our time, sympathy, and energy, nor cause us to deviate from the high path of spirituality we have outlined for ourselves. Yet on the other hand, every person closely contacted in this life and in the next affords a possible opportunity for real helpfulness; and to the extent we can give real assistance to each without detracting from our larger usefulness to society as a whole, are we called upon to render this assistance.

I mention this rather obvious doctrine here because the lines of association we form while still on earth often are instrumental in bringing the same people into our lives again in the next world. Not only our relatives, but others whose lives in some manner we have contacted and influenced here, are very apt, through the memory images retained in our minds, to be again contacted on the inner plane. Yet if it can be seen clearly that no constructive purpose would be served by such a renewal of acquaintance, it can be avoided.

If an injustice has been done, however, the memory of it in the mind of one or both usually has enough power, sooner or later to bring the two together, and then a proper adjustment can be made. And even when no injustice has transpired, if one has through personal contact exerted considerable influence in the life of another, this commonly brings -them together again. I do not mean they necessarily have a further influence over each other's lives; but that, even as people from the same village, after they have taken up residence in some large city, have annual picnics where they once more meet and discuss old-time acquaintanceship, so in the after-life people are apt to look up their earth-time acquaintances. And these renewed contacts not infrequently offer the opportunity for much helpful service.

People, when they pass to the next life, take up their own particular work; but they do not become so engrossed in it and in their own progress that they forget their old friends. Even when they pass to much higher planes they retain an interest in loved ones in worlds below, and as opportunity offers communicate with them.

The most approved method by which those of considerable spiritual advancement communicate with their loved ones on earth, or with those who have made the thought contact with them through kindred interests is by extra-sensory impression. Voluntary and directed thought transference, when the one on earth is sufficiently trained in intellectual extra-sensory perception, is also to be commended. But, unfortunately, not all of those who pass to the next plane are very wise. And even among those wise, it may, under certain circumstances, be deemed expedient to use various other methods, simply because there is the necessity to get a message through, and other avenues are closed.

Regarding the destructive and disintegrative forms of medium-ship, I have had much to say in the last three lessons of Course 1, Laws of Occultism. It is quite natural that those who pass to the next plane should wish to give assurance of their welfare to the loved ones still on earth. They are still quite as eager to be of help as they were while here. But up to the present time the lines of communication between the two worlds have not reached as high a degree of perfection as might be desired.

When a message is being given through the channels of a public medium it is often possible for some other entity to cut in on the line, or due to other reasons, for the message to come through in garbled form. But, unable to impress them more directly, those wishing to communicate with loved ones here use whatever means they can best command.

It must not be thought that there is but a single method of inter-world communication. There are many engineers and signal experts who, on the inner planes, are devoting their time exclusively to perfecting various means of communication. We cannot say what discoveries in this field may not be made in the near future. And in chapter 1, I have already mentioned a strictly mechanical device that I feel confident, in time, will come into use to make communication with the earth easy, accurate, and fully reliable.

Stations For Communicating With The Earth

—But at the present time there are many well organized stations in the astral world, with skilled operators in charge, where people who have passed on may go and undertake to communicate with those left in the flesh. These stations do not all operate on the same plan, as different methods are constantly being experimented with. At some of the more popular ones there is always a crowd of people, each awaiting his turn to try to get a message through to some loved one on the earth.

And aside from these well established stations, there are numerous ingenious individuals living on various levels, and in various sections of each level, who delight in experiments of their own. They construct devices, and tryout many plans by which they hope to get into contact with those of earth. The work of some of these amateurs is highly gratifying, and is making communication with those of the next life increasingly popular.

Quite aside from this public aspect of communication between the planes is the more satisfying thought-transference method of spirit communion. This requires that the one on earth, or lower level, shall have a keenly developed sense of awareness to words and images having their origin in the mind of another.

If you practice this sort of sending and receiving messages, you first visualize as clearly as possible the image of the person on the other plane you wish to contact. This puts in the call, and if the thought has the proper quality and force to reach him, he feels it as a force coming from you. He then thinks as clearly as possible of your image, and attempts to modulate his thoughts to the same vibratory frequency as those coming from you. He does not need to leave the level where he resides. The two of you merely try to tune in on the same wavelength. And if you are successful in this, both of you feel it as a sense of nearness. In your consciousness it will feel as if he were right by your side, just as the voice from your radio seems to come right from the room where the receiving set is located.

Spirit communion as here described is accomplished through what is now termed Intellectual Extra-Sensory Perception. The unconscious mind of an individual on earth continually resides on the astral plane and has faculties which, given sufficient energy with which to work, and the right kind of impetus, can on this inner plane communicate with the intelligences dwelling there. In such communicating mediumship or control plays no more part than it does when one individual exchanges information with another on the physical plane. Nor in such work, if worthy of being called spirit communion, does hypersensitivity play more of an important part than it does in the exchange of information between two persons talking to each other both of whom are in the flesh.

What happens is that the unconscious mind, or soul, is given instructions by the objective mind what information or question it is to convey to the inner-plane person tuned in on, and that it is to bring back the answer. The soul conveys the image or message to the inner-plane person and brings back the reply. The interval between visualizing the message and thus getting the answer may be so short as to seem instantaneous, and the inner-plane individual, whatever level he may occupy, may seem present in person.

The reason the images or words received are perceived in your own mind, even though you are aware they come from the other person, is that in reality they first are recognized by your unconscious mind, and it projects them up into the region of your objective consciousness. Also, the thoughts that are transferred to the inner-plane person exist first in your objective mind, then are forced down into the unconscious mind, and on the plane it normally occupies are delivered by it to the mind of the inner-plane person.

This process when carried out between two persons both of whom occupy the physical plane is called telepathy, but when carried out between persons occupying different planes is called spirit communion. For either the successful use of telepathy or spirit communion there must be suitable electromagnetic energy present to give energy to the soul, to direct its activities, and to enable it after it has acquired the thought of the other person to project the thought into the objective mind with sufficient force and clarity that it is able to overcome competing trains of thought, and register there.

Volume of electrical energy is not all that is required for quick and effective thinking. While all objective thinking is carried out through electrical processes within the brain, to be effective there must be generated by the nervous system wavelengths suitable for this purpose. Nor is volume of electrical energy all that is required to furnish energy for telepathy or spirit communion. The electrical energy must be of a high-frequency suitable for such work. Breathing and tensing exercises may be used to generate such electrical energy; and even as most persons are aware when they are in fit shape to do good thinking, so with a little practice one may learn to recognize when electrical conditions are present suitable for spirit communion.

However much suitable electrical energy is present, if highly charged thoughts about everyday problems and worries keep flocking through the brain the unconscious mind is unable to use it to make an impression on the brain vivid enough to be objectively recognized. Therefore those who strive for spirit communion must cultivate the ability to inhibit cerebral thinking.

The actual tuning in is done through mood control and holding the image in the mind of the one to be reached with the thoughts. And with some practice it is possible to recognize when the soul is sufficiently giving its attention to inner-plane things and has made the contact with the person with whom it is instructed to communicate.

Usually it takes long and persistent practice deliberately to move one's consciousness and thought-processes out on the inner plane. But when you have thus moved your consciousness to the inner plane, it only takes practice in directing the desires to learn to hold spirit communion, or to do a variety of work there. The recognition of what the soul is doing is similar to that of knowing when one musical instrument is in tune with another musical instrument. To gain this ability the musician undergoes practice in discriminating the similarities and dissimilarities between tones. And even as after a time he quickly recognizes the slightest difference in tones, so the individual who applies himself can learn to discriminate between his inner vibrations sufficiently to recognize whether or not his soul is active, what it is doing, and whether it has made the contact it has been sent to establish.

All inner-plane experiences, including those involved in spirit communion, must exist first in the soul as a memory before they are recognized by objective consciousness. And when raised, at once or after some delay, into the region of objective consciousness, there is the problem of recognizing them. Due to the electrical energies which move through the brain having established easy channels of flow, the habitual movement of these energies and the thoughts they charge may so seriously compete with the weak electrical charges with which the soul can endow the information it has received that no recognizable impression is made on the brain.

This difficulty is partly overcome through cultivating the ability to inhibit cerebral thinking. But even after some progress has been made in this, some training in discrimination may be necessary to sort out the images and impressions which the unconscious mind, or soul, brings from the inner-plane person, and not confuse them, or mix them, with one's own thoughts given energy by thought-cell activity, which may gain considerable power through the energy fed the thought-cells by the progressed aspects of the planets.

Prayer

—This tuning in on higher planes brings us to the subject of prayer. Prayer, of its own dynamic force, due to the images formulated by desire and vitalized with emotional energy, has extra-sensory power to bring its own answer. Prayers, however, are of various grades and categories. Some are pure and quite unselfish, wishing for the welfare of all mankind. Others, equally unselfish, ask help for certain individuals. Still others which in essence are really prayers, are not so considered by those who feel them.

All, however, are either vague or clear cut thoughts that have been endowed with emotional quality. This emotional quality gives them a certain vitality; but more frequently than not the motive is somewhat mixed, and has vibratory elements of several levels. Thus it is that prayers frequently can be seen as thought-forms on several different levels. The grosser elements affect only the substance of the levels closer to earth, but the more spiritual elements reach and can be seen even in the levels above the astral, in the spiritual world. That is, prayer, or thought vitalized by emotional elements can reach and have an influence only on levels that are of no higher frequency than the highest frequency embraced within the thought.

But in this connection there is a factor of sufficient importance that it should be noted. It is that by visualizing a person, that is, having his image in the mind, the range of accommodation to thought-frequencies is considerably increased. The image affords a definite tone to which the thought-frequency attempts to reach. Even should no actual person be represented by this image, if the image as held in the mind is of a character indicating a very exalted level, the thoughts tend to tune up, as nearly as possible, to this frequency-level. Those, therefore, who have lifted their souls in prayers to saints and angels, as well as to Omnific Deity, have reached a level with their thoughts, and there builded somewhat, which otherwise to them would have been entirely impossible.

Those who have ascended in their progress entirely above the astral world can have no direct communication with those on earth, except with those who have already in some measure built for themselves a spiritual form. Everyone on earth has an astral form and, therefore, under proper conditions can reach, and be reached by, those who have passed to the next life who are not too highly advanced in the astral realms. But man is not born with a spiritual form. It is built up through thoughts, emotions and experiences which are refined enough to affect the substance of the spiritual world. Thus only the most advanced of those on earth have developed a spiritual form of sufficient texture that it affords a means of contact with those exalted beings of the real high-frequency spiritual world.

Nor, if we have not developed a spiritual form while on earth, do we immediately get one when we pass to the next life. If it is not built up here, it must be built up through effort and long training in the after-life. And in this after-life, until we have built up something of a spiritual body, those in the spiritual world cannot contact us directly. Of course, while in the flesh or after passing to the astral plane, if we can turn the dial of our consciousness even temporarily to the frequencies of the still higher velocity realm of spirit we can see the events of that world and converse with those who there dwell. But unless one has made some spiritual development he will find it hard to tune in on the high-frequencies with sufficient persistence to receive messages from such sources clearly. Answers to prayers for guidance, however, sometimes come from these exalted spheres.

This does not mean that information from the spiritual spheres seldom reaches the earth. On the contrary, accepted neophytes who have been given some specific work to do on earth, and who already have built up spiritual bodies of considerable strength, are frequently instructed and advised directly by those in the spiritual world. And much more of information and instruction is conveyed to the physical world through the relay system. The communication is given from those in the spiritual levels to someone in the astral world who has succeeded in building up a spiritual body of sufficient density to make it easy for him to contact spiritual frequencies. Then this individual of the astral world makes whatever contact he can with someone in the flesh, and thus the message finds its way into the physical world.

You will understand this from your radio set, which may not be able to pick up the high-frequency waves used to transmit a program from England to Los Angeles. The National Broadcasting System, however, has a receiving set that registers this program, and as it comes from the loud speaker it goes into another microphone and is re-broadcast on some other frequency that is easily registered by your set.

This is analogous to the common method by which information from the spiritual levels is relayed to earth. But when the mechanical devices which I mentioned in chapter 1 are perfected and brought into use on the earth, re-broadcasting will be unnecessary. In this process of the future there is a transformer, or a series of them which steps the velocities down, so that a message or program broadcast on any level of either the spiritual world or astral world can be made to set up vibrations of similar significance on any particular level in a lower-velocity realm, reproducing themselves perfectly in lower octaves in the slower moving substance of the realm contacted, and thus be made recognizable even on earth.

The relay principle is also brought into play when some manifestation of substance takes place. A person of high astral level can so change his vibratory rates as to pass down to any lower astral level and there perform some work or service. To do this, of course, requires special training. But an astral entity cannot move physical substance unless some physical organic life is present to furnish the electromagnetic energy to

be used in the physical manifestation. Nor can someone in the spiritual world move the substance of any of the astral levels, or do any work there, except someone of the astral or physical world who has already developed something of a spiritual form is present. But those of the spiritual levels, through the aid of a spiritual person there located, can manifest themselves, and do so, in the worlds of lower velocities.

Yet I should not state positively what can and what cannot be done. Rather, I should say that up to the present time certain things have apparently not been done. Because, either on the astral levels, or on those spiritual, things are not fixed and stationary. Progress is constantly striven after. On all planes there is a continued and energetic search for new things and for new ways of doing old things.

Forty years ago we might have said that man cannot fly; yet today he does fly. So what I have said about communication between the worlds is merely an observation on what seems at present customary. Some discovery of tomorrow may entirely upset this; for one of the things those on the inner levels are seeking is to find a method by which the life of the different worlds and different levels of each world may better be coordinated. In the spiritual world and in the astral world inter-planal communication has been developed to a rather high degree of efficiency. But much is yet to be desired in the facility and completeness of communication between the spiritual world levels and the astral world levels, and between the astral world levels and the realm of physical life on other planets and the earth.

Not only is there a very complete system of communication between the various levels of the astral world, by which those who voluntarily descend from upper levels to work on those lower keep in touch with the level to which they belong, but definite programs are arranged by those on higher levels, which are sent to lower levels, where they are witnessed and heard by multitudes.

But do not think that these programs are all in the nature of lectures, sermons, and profound discourses. Instead, more of them are devoted to music, art, the drama, and other types of entertainment. That such entertainments have an inspiring quality is not to be wondered, as even on earth any entertainment that has not some uplifting quality is popularly frowned upon. Yet I suppose to many it will seem surprising that so much time in the next life is devoted to entertainment.

Entertainment

—From what I have seen, and the reports of others, it would seem that entertainment is given more importance there than here. With some twenty million people attending the movies in the U. S. every day, in addition to football games, baseball games, and the consumption of radio music, it might be rash to say that more time is given to entertainment there than here, although even that seems to be the case. But at least the entertainments seem to be somewhat better organized, and quite as well attended.

Occasionally we hear it asserted by someone who has a little knowledge of the astral plane that not only are people bound to earth by their pleasures, but that even after passing to the next life they may become entangled in the joys of the "Summerland." And it is true that an absorption in the grosser pleasures, either on earth or in the next life, may develop a callous selfishness and coarsen the character, and thus make progress impossible.

But we must realize, from our studies of psychology, that man voluntarily moves only in the direction of his pleasures. He moves away from pain. When he does something it is because doing it is more pleasurable to him than not doing it, or less painful to him than not doing it. He may have conditioned himself to find pleasure in things that most people find painful; but whenever there is a struggle between doing and not doing, the movement is always in the direction of the strongest image in the mind, and this, unless he is dominated against his will, is away from pain and toward pleasure.

In the next life, and in this one, one may cultivate pleasure in anti-social acts, in gross conduct, and in vileness of various kinds. Thus it is possible to become entangled in the grosser pleasures of the "Summerland." But this is no indictment of pleasure or of joy; it merely indicates that the wrong kinds of pleasure are degrading.

On the other hand, either on earth or in the next life, the strongest force for progress, in fact, almost the only force, is that derived from finding pleasure in experiences that are beneficial to others, that refine the form, and that lift the soul in aspiration to more noble endeavors. It is probably due to a recognition of this principle that we find music, pageants, glorious displays of lights and colors, thought-built scenic grandeurs, dramatic presentations, and splendid tableaux so common on all these higher astral levels.

In these higher levels we find people planning their activities so as to get the utmost from their lives. And the common method of doing this is to divide the activities into four separate phases: Work, study, domestic life and rest, and amusement. The proportionate amount of time spent in anyone of these phases in relation to the amount spent in each of the other three is not constant, but varies with the individual, and also with the same individual's requirements at different stages of his advancement. Yet, through the counsel of those who specialize in such research, and through personal observation, it is more common than otherwise to find people in these higher levels dividing their time among those four interests after a manner that will give the greatest all around value to their lives.

Work And Play

—Some types of work require much reading, attending lectures, and personal instruction for the highest effectiveness. Other types require very little of such methods, and that which should be learned is derived largely from doing it and through conversations with others who are following the same line. Thus just how much time and energy are allotted to gaining information is determined by individual needs.

No one, however, is considered too old, or too wise, to require further education, so that while book knowledge and formal schooling may play a very small part in the lives of some, everyone seems to recognize that any degree of progress calls for an effort to increase his knowledge. Some educational effort, therefore, is common to the life of practically everyone. In addition to other avenues of gaining information, there are vast public libraries to which all have access. And I may add, in passing, that these libraries are not totally inaccessible to those yet on earth.

When I speak of domestic life I do not mean that everyone is married and has a separate and individual home, although this is more common than otherwise. Yet everyone, after a period of strenuous activity, feels the need of rest, relaxation and revitalization. On earth, people eat and sleep to recuperate their strength. In the higher astral levels eating as we know it is not practiced, nor sleep. Yet periods of rest and revitalization are required and, while some live in more congested quarters and in conformity to their temperamental leanings, domestic ties and a home seem to find favor with most as the ideal means to this end.

Because most of the accounts of the next life come to us through those especially concerned with communicating with someone on earth, the impression might easily be gained that the chief concern of those on the inner plane is the earth and what happens to its people. After many years in a metropolis, one writing, or telephoning, to the old home town might just as readily convey the impression that the most important thing in life was what was happening in the village of his birth. But in reality he might be living a varied and quite intense life in his present surroundings and gives thought to the village only on special occasions. And in reality those of the next life, while not forgetful of earth ties, are so actively engaged in their after-life affairs that what happens on earth assumes no great importance.

Among these activities, and at least far better organized than on earth, are the amusements. There are public pageants of vast splendor, which are presented at times when the astrological forces correspond to the purpose of the pageant. In fact, the periods not only devoted to amusement, but also to serious work, are coordinated with astrological forces, and thus greater effectiveness for energy expended is

secured. Building activities, for instance, are timed to periods when the astrological influences correspond to those represented by our planet Mars; activities involving special leadership to influences which correspond to those represented by our Sun, etc. The pageants, likewise, and other types of public amusement, are set for periods that have a corresponding astrological quality.

The gorgeousness of these displays cannot be conceived by one who has never left the earth. Not infrequently those of higher levels are in charge of affairs. Thought-molded substances are shaped into amazing and beautiful designs. Colors of infinite harmony are blended to produce most exquisite effects. And as these artistic arrays move forward like vehicles, various lights from a distance are played upon them in such a manner as to produce a symphony of color combinations. Visual music, as well as that auditory, thus lends an added enchantment.

In such pageants, people in splendid costumes take part; and along with them, and trained to their part, are other bright creatures, pert and intelligent, with grace of movement, beauty and charm, which have no counterpart on earth. They are not fairies, for they seem to have developed in the realm where they now are; but they exceed in their delightfulness even the wee folk of earthly forest glens.

Then there are festivals and various ceremonial occasions. These also occur under special astrological influences and, as any high class entertainment should, they carry a message of importance. The intellectual aspect, however, is quite subordinate, and the chief end sought seems to be the arousing of beneficial emotional responses. And the most striking thing about such affairs, to one who has had no previous contact with these higher astral levels, is the number of people who attend them.

If there were no other types of amusement this would not seem so surprising, but there are public exhibitions of art, public musical recitals, public exhibitions of dancing, public initiation ceremonies, and public reception, with appropriate music, color and tableau, of those who have made enough progress on the next lower astral level to be ready to take up their life permanently on this particular one.

Initiation Ceremonies

—When a large group is brought to a level, from some other and lower region, the whole community seems to turn out to greet them. Banners fly, colored lights play visual melodies, music resounds a welcome, and everyone makes it an occasion for being both happy and gay. There are speeches of congratulation, and ceremonies of initiation, all in full public view. Afterwards there is more music and dancing and places where various kinds of dramatic entertainments may be witnessed.

In such public initiations, which are not to be confused with the initiations given by certain fraternities and orders, on occasions there is someone from earth, out of the body during sleep, who has succeeded permanently in raising the dominant vibration of his astral form to the plane level where the ceremony is taking place. Thus, because he has made the same advancement as the others who are now just taking up their existence on this particular astral level, he joins them and forms a part of their group.

Even though everyone recognizes that he still has a physical body on the earth, he is quite as welcome as the others. He is conducted through the same ceremony, and cheered quite as royally.

When he awakens in his physical body he may remember considerable of the ceremony, or only a very little of it; but usually he is at least conscious that he has been away, has passed certain tests, and has been formally initiated somewhere. And he may even remember that he was rather clumsy in this other environment; for those fresh from earth show their ineptitude, and what they do often excites hilarious though friendly merriment from the crowd. They laugh at his little blunders, and he takes it all in good part and laughs with them, but they also make it plain that they esteem him highly for, while still hampered with a physical body, making such marked advancement.

Brotherhoods and societies of importance on the earth have their counterparts in the next life. And it is not uncommon to find a brother who yet resides on earth attending the meetings of his fraternity on the astral plane.

Of necessity, I have had to treat of the amusements and social activities of the next life as if they were identical on all levels. As a matter of fact, the work of certain lodges, for instance, is not just the same on different astral levels, but grows in complexity as the levels are ascended. Nor is the type of amusement entirely similar as found on various levels. I have, however, tried to give an accurate impression—as an accurate description is beyond the written word—of conditions as you will encounter them after you move your residence from physical earth to the astral world.

If I have conveyed the impression that things are just stereotyped over there, that it is a place of monotonous routine, and that every- thing is accepted with a serious countenance, I have failed. But if I have conveyed to you that life there is brilliantly and pleasingly active, that interests are varied and thrilling, that there is more real romance in the after-life than has ever been thought of on earth, that social relations are given plenty of attention, and that amusement and entertainment, instead of being considered a waste of time, are deemed important in every well regulated life, I have not failed. And if, in addition, you can feel that this next life is going to be intensely more alluring, happy and vital than this one, I will consider this discourse a success.

Chapter 10

Serial No. 182
Original Copyright 1943
Elbert Benjamine

Copyright
Church of Light
August 2002

Through Astral and Spiritual to Celestial

Chapter 10

Through Astral and Spiritual to Celestial

ANY description of the next life, to be even moderately adequate, should not be confined to the conditions that obtain merely on the various astral levels. It should contain also some details of the still higher velocity spiritual world, and those ranges of velocity above the spiritual called the celestial world. Because the velocities in these worlds are so high as to impart additional properties to all objects and persons of such realms, they are more intense, more conscious, and more real worlds than either the astral or the physical.

But even in a description of the higher astral levels we might exhaust all the pleasant adjectives of the English language and yet fail to convey any idea of the majesty, glory, beauty, and exquisite joys. How, then, is it possible to impart even a meagerly correct impression of the still higher realms that await the human soul?

Realizing that such an undertaking is beyond my power, I shall not attempt it. Instead, I shall mention the chief functions of these worlds in human progress, point out, in broad outline, the steps that lead up to acquiring these new functions, and signify that the various activities of the astral world modified in form to suit the conditions there found are continued in still higher worlds.

It seems to be the chief function of the animal kingdom to confer Simple Consciousness, and the chief function of life in the physical human form to confer Self-Consciousness. Man may also, while on earth in the physical body, through cultivating extra-sensory perception, acquire Cosmic Consciousness and Divine Consciousness. But more commonly he gains Cosmic Consciousness only after he passes to the next life, and acquires Divine Consciousness as a permanent asset only after he moves above the astral levels and discards all remnants of the astral form to function solely in a spiritual body in the still higher velocity spiritual world.

Let us suppose, therefore, that you are an ordinary citizen of the physical world, that you have not lived a life devoid of unselfish acts, but at the same time have made no very great effort to build up your spirituality, and that you have made enough study of occultism that you can readily adapt yourself to the conditions on the astral plane. Perhaps as a result of extra-sensory perception you have had at least flashes of Cosmic Consciousness. And it is to be assumed that at least in rare intervals, you have had extrasensory experiences that have brought to you convincing proof of

inner-plane forces, that conscious life persists beyond the tomb, that the universe is an organic whole dependent upon the co-operation of its parts for progress, and that in other rare instances you have made convincing personal contacts with the all-pervading intelligence of Deity. In other words, suppose you are in enlightenment and spirituality about the average of the present twenty thousand students who read The Brotherhood of Light lessons. What can you expect when you pass to the next life?

Due to the fact that you have a fairly clear conception of what the next life is like, the sleep transition between the physical plane and the astral world will probably be of very short duration. You will awaken after possibly only a few moments loss of consciousness. You will find yourself amid very pleasant surroundings and will be greeted by welcoming friends. Not unlikely someone you have loved on earth who has passed before will be apprised of your coming and condition himself temporarily to the region close to earth where you have your astral birth so that he can explain to you your new surroundings and help you to become thoroughly adjusted.

This period of adjustment for you, because you already know about what to expect, will not take long. Very shortly, feeling vigorous and fully recovered from the strain of transition, you will go, probably guided by a companion, to an astral level above the one into which you were born. Because your own dominant vibratory frequencies are the same as those of this level, you will feel quite comfortable in its atmosphere. Should you later descend toward earth, the atmosphere there will feel thick and foggy and the light dim. But should you attempt to move into a higher level, the light appears dazzling and the atmosphere too rarefied to sustain your existence.

A Preliminary Survey

—In this land where you now find yourself you will wish to take an active part. Before going here you already knew that what you get out of this new life, and the advancement you make toward the more desirable life of the higher levels, depends entirely upon yourself.

You will have arrived with a certain equipment, and you will wish to know how these qualities you possess may be used to the greatest advantage. This equipment, in terms of natural aptitudes and luck-attracting ability amid each type of environment, will be quite accurately mapped in the chart of your birth into this new life. Perhaps, through a study of your aptitudes and luck-attracting ability while on earth, as mapped in the chart of your physical birth, you already while on earth had come to realize the nature of your cosmic work. Or you may as yet be in some doubt as to just in what your function in cosmic affairs consists. If you do not know, you at once will seek the advice of those who specialize in such matters. And in either case, so soon as you have traveled around the level on which you now find yourself enough to have some general idea of the conditions there, you will enter upon this particular line of work.

While making your preliminary survey of conditions, you probably will be accompanied by a friend or at least by some guide who will see to it that you have proper accommodations for the periods of rest. But so soon as you have decided upon your work, and where it will be conducted, you will probably wish to establish yourself in a home. You can, of course, find quarters for yourself in some large building where others also have suites who at present do not care for a separate home and a more complex form of domestic life. But if you desire it, you can either build or secure a home of beauty and convenience that will give you domestic privacy.

You may have on this plane a loved one awaiting your coming, to share with you the bliss of domestic partnership. You may have someone on earth, or on some level above or below, to whom your heart belongs; and thus decide to have no intimate domestic partnership until such a time as you both can reside on the same vibratory level. You may decide that your best work for the present, and your greatest happiness, does not require the forming of marriage ties. Or, in this new realm, you may meet someone of the opposite sex and complementary affinity, the mutual attraction resulting in a happy marriage. But at least so soon as you have decided how to proceed with your work you will wish to make some arrangement, even though of a temporary nature, for periods of rest, and perhaps also for the establishment of a separate residence, suitable as a home for yourself and your domestic partner.

Your Work

—If you have not already, while on earth, learned this, you will soon be shown that this work, which you are being fitted to perform, and which, because of your aptitude in it, you find most Joy in doing, is not confined to anyone plane or to anyone level. To be sure, it is not performed in just the same way, nor under the same conditions, on different levels; but even above the astral, in spiritual and celestial realms, it has the same general functions. Your training in lower life-forms before birth into a human body, your experiences in human form while on earth, and your work on the level of the astral where you now reside, all contribute to your ability to perform this special function in cosmic society.

Vocational astrology is highly important; for make no mistake about this, the most important thing about your existence is your ability to contribute your own work to cosmic welfare. This is true on every level of your life. But the amount you can contribute to cosmic welfare depends, not merely upon the ability you have developed on some particular level, but more particularly upon the level where you function. The higher the level on which a function is performed, the more it contributes to universal good.

Furthermore, each succeeding higher level of the after-life possesses certain definite advantages over the next lower. The higher life progresses the more free does it become, the more power does it exercise, the broader the range of its consciousness, the more ecstatic its joys, and the more exhilarating does it find existence.

On earth it is common to refer to standards of living. The slums represent one standard, and the surroundings and conveniences of those who are refined in tastes, have more than the average education, and some wealth, represent another standard. It is generally believed that a higher living standard for people everywhere is to be desired. And while much that is artificial may enter into the standards of earth, each higher level of the next life represents a very real, and very desirable, higher standard of living.

Therefore, when you become adjusted to your work and domestic existence in the next life, you will not desire to remain forever on the level where you find yourself. Instead, you will wish to move forward, to perfect your knowledge and abilities, and to qualify yourself as soon as possible to move up into the next inhabitable range of vibratory frequencies.

Advancement In The Next Life

—Mere knowledge will not permit you to advance to a new level, although additional knowledge will enable you to increase the range of your usefulness. Not only will it assist you to do your work better where you are, but also, through lending a wider and more accurate comprehension of the meaning of life and the requirements for adequate living, it will enable you the more readily to develop those characteristics which alone will enable you to function on the next higher level. As a consequence, you will probably decide to spend a certain amount of time and energy gaining mental education.

On this level where you start your life work you will find that within yourself are the same old discords. Your finer form now embraces the thought-cells and thought structures with which you were born into physical existence as these have been added to and reorganized by the experiences you had on the physical plane. Those with whom you associate on this new plane also have discords yet within their astral forms. You are essentially no different than you were while on earth. And your discords still attract to you certain experiences that seem disagreeable.

Developing Harmony Within

—But on the higher astral levels, to which later you hope to move, these internal discords are considered to indicate emotional immaturity. If they are quite pronounced they may even inhibit the raising of the dominant vibratory rate to any higher level. But at least their continued existence, through attracting obstacles, hindrances and misfortune, detracts from what otherwise might be accomplished for the common good. And as the amount of accomplishment for the common good is the only measure of value in the next life, those who have the spirituality to move to higher levels undergo whatever of training and experience is necessary harmoniously to reorganize the thought-cells of their finer forms.

In order to acquire the knowledge of how this is done you may, or may not, need some instruction. But the actual work of reorganizing your astral form will be done through various experiences in connection with your work, through the social contacts you make in recreation periods, and through your domestic relationship.

When your emotional progress is sufficiently advanced, your response to all the various contacts of life will be pleasurable. You will have outgrown at any time the feeling of irritation, anger, disgust, anxiety, fear, sorrow, or any other disagreeable emotion. Or if, for a few fleeting moments, sorrow or anxiety in connection with some loved one is felt, it will be recognized as a weakness and some other interest substituted which will serve as an antidote to annul the discord thus registered. To be of great value to the society where you now find yourself you must feel only harmonies and refrain from experiencing discords. And among other things, your effort thus to benefit others is a determining factor in establishing a dominant vibratory rate that will permit you to pass to a still higher level.

Harmonies and discords, of course, obtain on every level and in every world. But the residents of higher levels, as a result of their training to work in these realms of high frequency, persistently cultivate and practice the ability to maintain complete inward harmony in the face of any and every impact from their environment. By virtue of this ability they produce results of amazing magnitude. Instead of being buffeted about by the tremendous forces of these high-frequency regions, they are able to direct them into constructive channels of their own choosing.

But in spite of reorganizing your astral body into a more harmonious whole, and thus increasing your usefulness to others and greatly increasing your own happiness, you will not move to a higher plane except through acquiring a higher dominant vibratory rate; that is, through a definite gain in spirituality. Various factors may contribute to this gain.

The desire and the effort to contribute to the welfare of others in the greatest degree is perhaps the most important and efficacious means of gaining spirituality. You will find opportunity for this in your work.

Yet by a proper attitude toward any event of life it may be purified. Then by combining it with another experience which provides a natural flux, and using it constructively for universal progression, its vibratory rate may be raised, even to the frequency where it imparts its energy to the still higher-velocity substance of the spiritual world. Your social contacts, your domestic experiences, and all your other activities of the next life, through such character cultivation, can be made to assist in raising your dominant vibratory rate.

Still another means that you will probably employ is the refinement of your emotional responses through cultivation of a keener appreciation of that which is beautiful and elevating. The need for this is recognized on all levels above the sordid, and the splendid pageants, light symphonies, musical productions, public exhibitions of dramatic art, dancing and suitable literature, all afford opportunity in this direction.

Thus it is that when you pass to the next life you may expect to take up some definite work that will be of value to others. You will establish yourself in a home very much to your liking. You will resume, or form, domestic ties according to inclination and the circumstances of your previous and your present life. Social contacts will probably be rather numerous. And, quite likely, you will find that amusements are so significant as not to be neglected. Your activities, no doubt, will be quite varied, but the whole pattern of your life will tend to merge into a combination that will rather quickly prepare you to move to the next higher astral level.

It may be, when you have reached this stage of development, that you will have a domestic partner who, hand in hand, will make the transition with you. One or the other may even linger somewhat, to help the other reach a point where the transition is feasible. But whether alone, or with someone, whether you go with a whole group or only as an individual, the time will arrive for you to move to a higher sphere.

Then you will bid old friends good-bye. Some, perhaps, will meet to see you off. By learning how temporarily to lower your dominant vibratory rate you will be able, occasionally, to visit them in the future. And, by means of across the planes thought-transference and other means you will still be able to keep somewhat in touch with them. But your chief activities from now on will be in a new land and amid other acquaintances.

If you make the transition to the new level with a group led by a guide, it may be that those of the land where you now go will make it a gala occasion, and welcome you with a joyous ceremony. Or, you may prefer not to await such an occasion, and without a guide, by means of aerial travel, make the journey alone without publicity.

Arriving in this new land, where the light seems brighter and all activities more intense, you may require a little time to adjust your- self to its conditions. The people you meet will be courteous, and even though you are a stranger, will be desirous of helping you in every way. And very shortly you will find where your services are needed in your particular kind of work. Thus will you take up your work on this higher level, establish yourself in a home here, enter into the social life, perhaps, of this level, and accustom yourself to its enjoyments.

Here, as on the lower level from which you came you will endeavor, through increasing your mental and emotional education, to make of yourself a more effective person. You will continue to cultivate more refined emotions and in general build up your spirituality. And in due time, as a result of your effort, you will be ready to move to a still more advanced level.

But, because the general process of advancement hinges on effort to promote the general welfare, on proper mental attitudes toward all events, and on the refinement of the emotions, you must not think that it is just a monotonous repetition of the same thing, over and over, on different levels.

Instead, the conditions, problems, and adjustments of different levels give all the variety that could be desired. Entertainments are entertainments, of course. But the methods and the quality of the effect are subject to infinite variation. The people contacted from time to time are tremendously interesting. Some of them do such amazing things, and others have been to such strange places. And even domestic life fails to pall, because expression of pure affection, and the interchange of thought, are given so much wider range than when hampered and restricted by the dense material form.

Interest in one's work is never lacking; for there are always new difficulties to overcome and new obstacles to be removed. These are not such as are attracted by internal discords; but are simply the natural resistance one encounters when endeavoring progressively to accomplish greater and more important tasks. One never reaches the point where there are no still larger jobs to tackle. One thing successfully accomplished prepares and trains the individual for better and more complex work.

And while those on the upper astral levels carefully cultivate the ability to resist any disagreeable thought or feeling that would tend to create an inward discord, they are not free from the impact of environmental forces and conditions that test the power of their resistance. Even as on earth, they sometimes undertake tasks that are beyond their ability, and consequently, at least for the time, fail. Separations from those dearly loved are sometimes necessary. The sorrowing thoughts of dear ones left on earth rise to them with disturbing insistence. A loved one may await them on a higher level, and the long spiritual development necessary to rise to this level may engender irritation.

People must realize in the next life what they should recognize on earth, that never, in the whole span of eternity, will the soul reach a point where there is nothing left to struggle for. At any stage of its journey, when it has done the best its intelligence and energy permit, however unsatisfactory the temporary condition may be, it has no cause for anxiety or perturbation. Those on the higher astral levels do not maintain harmony within themselves because there is nothing left for them intensely to desire, but because they have learned what people on earth should learn, that feeling disagreeable detracts from such ability as they have.

The astrological forces, even as those that reach the earth, are at times harmonious and at other times discordant. But on the higher astral levels the inharmonious astrological forces are neutralized or harmoniously transformed by the person as they reach his astral form. They are not permitted to engender discords within his body.

Yet because of their influence upon the whole environment, they nevertheless aid or hinder the progress of the work in hand. The discords make it imperative that certain things be done. Carrying forward the plan of universal progression meets then with the opposition of the tremendous untamed forces of Nature. When one frontier has been reached and conquered, always there is another beyond. Always something yet to be accomplished in the work of cosmic construction that requires still higher intelligence and ability. Thus it is that while your work will always perform the same general function, with every new level that you reach in your progress you will find the demands of that work more exacting. As your powers expand, more will be expected of you. And as you advance from level to level the joys derived from the other departments of your life also will correspondingly increase.

As your body becomes more refined, you thus progress from one astral level to another. Gradually you are building a spiritual body. But while you are still on earth, or after you pass to the next life until you leave the astral world, you do not function in this spiritual body. It is, nevertheless, being built by your high aspirations, by your mental attitudes, and by your desire to benefit others. You gradually eliminate the coarser astral particles of your body. And with every higher level you reach in the astral world you increase your dominant vibratory rate.

Because of this higher rate of vibration, a person from a higher level usually appears very bright. This brightness may be so great as to dazzle, even when the person has modified his dominant vibration enough to visit and be seen on some lower level.

This astral world, through the various levels of which you will gradually ascend, is not permanent and immutable. Life on its levels can continue over vast stretches of time, but at last must end. There is no immortality in the astral world. Immortality requires adjustments to still higher conditions. And thus it is, in due course of time, you will leave the astral entirely to live in the realm of the still higher-velocity spiritual world.

Birth Into the Spiritual World

—At the present time the realization of Cosmic Consciousness, which enables the individual to realize his specific function in the whole and his proper relation to other entities in the universe, is not a common thing while people yet occupy physical bodies on earth. And still more uncommon is the attainment while yet on earth of Divine Consciousness, which is similar to Cosmic Consciousness, except that instead of functioning on the astral plane, its scope and properties are vastly increased through the consciousness gaining its realization on the still higher-velocity spiritual plane.

There is nothing about occupying a physical form which compels the soul to confine its activities, and therefore its consciousness, to any plane, or to any level of a plane. If it can refine its feelings sufficiently and give these high velocity rates sufficient intensity, it can function on and be conscious of, not merely the astral plane, where Cosmic Consciousness more commonly is attained, but the spiritual plane, where Divine Consciousness must be acquired before transition to the realm of the celestial.

These higher states of consciousness, however, cannot be attained merely through reason or other cerebral processes. They can be acquired only through those faculties which science now recognizes under the name of extra-sensory perception. It is only through extra-sensory perception that man can gain for himself first-hand proof of the survival of the personality on inner planes of existence, or that he can attain Cosmic Consciousness in which he realizes, through his oneness with it, that the universe is an organic whole dependent for its progress upon the intelligent co-operation of its parts, and just what his work is in this co-operative endeavor. If you fail to gain such realization while on earth, you will develop it in your ascent through the astral levels. But if you intelligently work for it, you can gain this state of progress while still on earth in a physical body. One of the reasons it is not common for people to gain this advancement while on earth is because the use of extra-sensory perception has been discouraged, and so few have any idea that such consciousness is even a possibility.

Nor is there any impassable barrier to your attaining Divine Consciousness while still occupying a physical body. But to do so, your extra-sensory faculties must function not merely on the astral plane, but be able to function on the still higher-velocity spiritual plane. And you will not be able thus to use your spiritual extra-sensory powers until, through correct living, feeling and thinking, you have built up for yourself more than a fragmentary spiritual body. Because it operates from this interior plane where the powers of the soul are so vastly superior, Divine Consciousness goes beyond Cosmic Consciousness and brings a more perfect

conception of God's Great Plan, and what the individual can do at any given time most to further its realization. And it brings other knowledge of significance which is obtainable only by those, whether they still occupy a physical body or have passed to the inner plane, whose extra-sensory perceptions function on the high-velocity spiritual plane.

The all-pervading intelligence of Deity can be contacted and realized on any plane or any level, but it cannot be thus realized by rational consciousness. It can only be apprehended by the extra-sensory faculties.

Thus to enable people to contact Deity, to prove for themselves the continuation of self-conscious life on inner planes, and to make it possible for them to gain cosmic consciousness and perhaps even Divine Consciousness while still occupying their physical bodies, one of the chief objectives of The Church of Light is to get people familiar with the facts of extrasensory perception, and to find the most effective way by which people can develop and use it.

Of course, the attainment of a state of consciousness, even if it is a high state which commonly develops on upper levels of the inner plane, of itself does not advance the individual much. It only gives him the knowledge of the functions of his soul and what he should strive for. The other chief objective of The Church of Light, therefore, is to furnish people with the information that will enable them thus to progress and contribute their utmost to universal welfare. But whether or not you attain the higher states of development while on earth, you will have Cosmic Consciousness before you leave the astral plane. And on that plane at last there will come the so-called second death. But to you, because you have built for yourself a spiritual body, it will not be a death, or even a sleep, but a conscious transition to a new order of being.

You will slough off the remnants of your astral form. Never again will you possess an astral body; for it is left behind, even though eliminated more gradually, as completely as was your physical form. Henceforth you are a bright and radiant being whom those of the astral world and earth may well regard as an angel.

In this new world you will find that existence has properties that are quite amazing. Things that seem impossible to one familiar only with the astral levels are here taken as a matter of course. The speed of movement here is such that a new series of relations, a new set of natural laws, obtain. And because you have tuned in-not merely your consciousness, and not merely as a visitor, but your whole form permanently-to the frequencies of this world, your first task is to become familiar with all these new conditions.

Many strange things might be related of this bright and beautiful world. You have a home here. It already has been built by you, perhaps unconsciously, while you were yet on lower planes. And in this home are treasures and precious jewels, real treasures and real jewels, not the baubles for which men of earth strive with one another. They are the result and tokens of your spiritual achievements. They are yours, and await to be shared by you and your soul's companion.

But all this, and anything else I might say of the conditions you will meet in this high-velocity world, sounds at best like poetic fancy and at worst like irresponsible ravings. How can I, or anyone, describe that which is so different and immeasurably more blessed than anything experienced by man on earth. I shall not try.

Responsibilities are increased in this spiritual world. The guidance, supervision, and government of lower regions is managed. Your work is there, too, but in a form superior to what you now can imagine. Loved ones, social contacts, amusements, education, variety to life, and ecstatic enjoyment, along with serious but intensely interesting work, will occupy your time.

And as in the astral world, due to your own effort, you will rise from one level to another, continuing to refine yourself and to gain in ability to serve the universal cause. And finally you will arrive at the boundary of the sixth and seventh state of the spiritual world. I do not mean that there are only seven distinct levels, because each state contains a number of distinct frequency-levels, each of which is a complete habitat of life. But the spiritual world, like the astral world, has seven broad divisions. And the boundary of the sixth and seventh state of the spiritual world is peculiarly significant, for it is here the permanent and indissoluble union of soul-mates takes place.

It is customary to speak of this permanent union of soul-mates as the fusion of their forms into a single body occupied by both souls. But it should not be thought that this implies the loss of identity, or restricts the freedom of movement of either. Each still possesses a distinctive form; but the two, vitalized by the same ego, are never separate in the sense that the exchange of energy between them ceases. The permanent lines of force over which energy is exchanged unite the two separate bodies and the central ego into a definite system which has a form, moves as a whole, and possesses definite potencies that were impossible to either separate soul.

The Soul-Mate System

—An atom of matter now is known to be a central positive electrical nucleus, about which revolves one or more electrons. Each of these electrons has its own form and individuality.

The atom of matter with two electrons revolving around the central nucleus possesses definite properties. Neither of the two electrons possesses these properties. What this atom can do easily, could not be done by any number of separate electrons, nor by any number of separate central nuclei, or protons. Because the two electrons have united in a definite, and, under ordinary circumstances, quite permanent, union about a common center, a miniature two-planet solar system is formed. And the properties of the atom, and what it can do, are determined not merely by the electrons and protons, but by their union in this definite system.

Each electron still maintains its own individuality and its own form. But no one would be so foolish as to say that while each electron has a form, the atom which contains them has not also a form. Furthermore, because each planet in our solar system has its own individuality and form, we should not be inclined to say that the solar system, as such, has no form. As a matter of fact, the solar system has a form, and produces results quite impossible to planets not thus permanently joined into a system.

The planets in our solar system are sometimes farther from the sun than at other times. Yet the solar system maintains its identity and its peculiar potencies.

Man and wife, upon the earth, blend in loving affection. Each can distinctly feel the exchange of magnetism. And even while separated and each going about his daily duties, so long as the minds of both remain on the vibratory level wherein this blend of energies took place, each continues to feel the nearness of the other, and the continuation of the energy exchange. Between those who are ardently in love, this feeling of nearness and exchange may continue for days and weeks, even though they are far distant in space, until some call upon the attention polarizes the forces of one or the other to a different vibratory frequency and breaks the magnetic connection.

The rapport between them thus broken, to establish the magnetic response again may require that they meet and exchange caresses, it may require an exchange of letters, or even only that each think of the other intently. Yet when man and wife are truly lovers, the periodic establishment of such energy exchange, which usually is not maintained permanently due to the intrusion of conditions which break the rapport, is common experience. And at such times as this rapport is thus complete, they together form a definite system.

One with clairvoyance enough to see finer energies can discern the lines of force extending between them, binding them for the time being into a single magnetic field. This fusion is maintained regardless of the distance from each other that they may travel. And because it is not dependent upon the close proximity of physical bodies, it is called regenerate union.

Durability Of The Fusion

—The completeness of such magnetic fusions between husband and wife, and the permanence of the periods during which their affections bind them together into a single unit, depends upon many things. But in proportion as they approach true complementary affinities it is easier to establish and maintain this complete fusion. Which is just another way of saying that some people are more suited to each other in marriage than they might be suited to certain others. But however suited for each other they may be, if they encourage brutality or sensuality it shatters the magnetic field so constructed. The higher the level on which the rapport is formed, the more enduring it is apt to prove.

Thus it is that on the higher astral levels affectional relations more and more bind husband and wife into a co-operative unit with powers quite impossible for either or both to exercise without such co-operation.

On the levels of the spiritual world this complementary unity becomes even more perfect the higher they move.

People Who Think They Are Soul-Mates

—While true soul-mates may meet on earth, because this relation can only be perceived from the spiritual plane, only those who have advanced far enough to perceive things as they exist on this spiritual plane can be sure that such a relation exists. Most of those on earth who think they are soul-mates merely experience a strong magnetic attraction. They have not advanced far enough to have any clear conception of what a spiritual attraction would be like.

But when you reach the spiritual world, as the natural result of your upward progress you will possess Divine Consciousness. Or, if you build up a sound and vigorous spiritual body, you can acquire this state of consciousness while you are still on earth.

Among other things, this brings the awareness of the existence and whereabouts of the soul-mate. And when you pass from the sixth to the seventh state of the spiritual world, as a natural result of having reached this advanced spiritual region, there will be a complete and permanent blending of your energies.

From thence onward you will progress together as a complete system. This system is composed of a male soul, a female soul, and a single ego. The ego corresponds to the nucleus of an atom, and each soul to one of two electrons. Each soul retains both its own form and its own identity. Nor is each limited in its action by the other, except as domestic partners customarily and voluntarily are when striving for accomplishment of some common work. Even here on earth, husband and wife may travel a thousand miles apart without breaking the fusion of their finer forces. In fact, distance in space seems to have no power to dissolve such a system.

A New Form And New Powers

—Nevertheless, even though each retains liberty of action, a distinct form, and its own identity, both have merged into another and more complex permanent body, or form. Instead of being more or less separate factors, the ego and the two souls now make up a definitely organized group. And just as an atom has a distinct form, or a solar system has a distinct form, this system that has now come into existence also has a definite form.

Furthermore, just as a solar system can accomplish that which would be impossible to its members if these were not thus united, and just as an atom can exhibit qualities impossible to ununited electrons and protons, no matter how numerous, so the Angel thus formed by the permanent union of soul-mates has abilities infinitely superior to those of souls before they were thus permanently united.

Immortality

—Most souls inherit immortality by virtue of being human. But, because the astral body in the course of time, even though that time be long, must dissolve, immortality cannot be completely assured until the spiritual world has been reached.

I do not mean that when the spiritual world is reached that you will remain eternally on some of its levels. On the contrary, there is no place in the universe of which it can be said, you reach this height and no higher. Progression continues, and without end.

But when, while in the flesh or after you reach the astral world, you have built for yourself a spiritual body in which you can function in the spiritual world, your immortality becomes assured. Passing then, from the physical or astral levels to the spiritual world, it is a function of that world to confer Divine Consciousness. The result of this state of consciousness insures that your life and activities at all times are directed by Divine Guidance.

You will not, therefore, remain eternally in the spiritual body with which you now find yourself. But because you have reached the stage where you have such a spiritual form is assurance that you will not be overtaken by any force of Nature that can dissolve this body before you have increased its vibrations sufficiently to function on a still higher level. In this sense, and in this sense alone, can the spiritual body be considered imperishable and immortal.

Into The Celestial

—The possession of such a spiritual form, and the Divine Consciousness conferred by it, will in reality lead to your progress up to the seventh state of the spiritual world. Here the permanent union with your soul-mate will take place, and as a result of this, after a period of adjustment to the new condition thus engendered, you will pass as an Angel quite beyond the spiritual world into the celestial. With this transition you will also pass beyond what it is possible for embodied man clearly to comprehend.

The universe as we know it moves largely through mechanical principles. But behind these principles, and behind the arrangement of the various external and interior worlds, is intelligent direction and guidance.

I have no desire to bolster up the popular superstition that beings higher than man continually meddle with the operation of natural law. But the directive power of mind, even when exercised from the spiritual plane of being, conforms to natural law. And those of the higher spiritual levels exercise a governing function in the progress and development of life within our universe that can only be hinted here.

But what we call natural law, after all, is merely a description of how, under various circumstances, substance and intelligence act. Because, in the universe to which we are accustomed, substance and intelligence act according to a certain sequence, does not prove that in some other universe they may not act in a very different way. It is quite possible that other types of universes, with which we as yet are unfamiliar, and which develop life for entirely different functions in the cosmic economy, may have very different natural laws.

You will readily understand that an Angel, as a definite system generating a field of force that embraces two souls and their ego, has potentialities beyond anything that can be conceived of as merely human. The function of such a unit is not merely guarding and directing that which has already been created, but also of creating.

I am not attempting to tell you how new universes are brought into existence; but I believe they are brought forth by groups of Angels. To such a group you will ultimately belong. Each soul-mate system, by virtue of the function it has been created to perform, takes charge of its own department in this creation, under the leadership of an intelligence still higher than such Angels.

And the existence of such an intelligence indicates that eventually you will move to a world even above the celestial. But even as an Angel you will assist in determining the laws that govern some future universe, and will contribute toward bringing it into existence.

Farther than this I cannot see. And even this is beyond what embodied man can clearly comprehend. But all that which can be seen and comprehended shows the next life to be a progressive series of steps, ever ascending in intelligence, in glory, in ability, and in capacity for enjoyment. It is unutterably stupendous and blessed to be a human soul.

But thus in the contemplation of the glories and joys of future states of existence let us not minimize the importance or the opportunities of present existence. All effort expended on earth for spiritual advancement yields many fold the degree of progress that a similar effort would if delayed until physical life is past. Nor are the opportunities presented to us today different in kind than they will be in the future. Refinement of organism and thought and emotion, and working for the welfare of all, are as available to us now as they will be in any time to come.

Let us recognize also that the road-map of life which will guide our efforts on inner planes, astrology, is now available. And for following the best path of life to which it guides us we have the same tools we must use to advance ourselves in the after-life. Those tools by which the destiny can be changed in the direction extra-sensory perception and astrology show to be most advantageous, are the facts of induced emotion and the facts of directed thinking. Therefore, let us be on our way, rapidly, while still occupying the physical form, toward those glorious angelic and celestial levels of whose rapturous qualities as yet we have had but a fleeting glimpse.

Book 21

Copyright
August 2002
Church of Light

Personal Alchemy

Chapter 1

Serial No. 216
Original Copyright 1949
Elbert Benjamin

Copyright
August 2002
Church of Light

Three Things Every Neophyte Should Know

Chapter 1

Three Things Every Neophyte Should Know

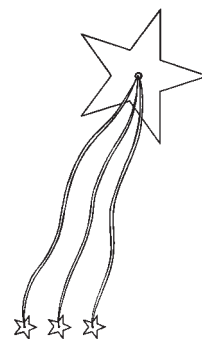

PERSONAL alchemy embraces the various changes which the devotee of The Religion of the Stars must make in his manner of living as he ascends the spiral ladder in his effort to become that crowning glory of earth, the perfect man, or adept.

The most important function of a religion is to instruct people how best to live. Such instruction as is given must necessarily be based upon the kind and amount of information possessed by the religion. And its ability actually to help those who embrace it depends even to a greater extent upon the reliability of the information upon which its doctrines are founded. If the information it possesses is largely false, to that extent, instead of being helpful to its devotees, it is a hindrance to their true adjustment to life and its problems.

A vast amount of research has indicated that inner-plane energies have as much influence over human life as do outer-plane energies. Thus in The Religion of the Stars in addition to facts relating to the material plane, and teaching each individual and each group how to live to the maximum of cooperative helpfulness, to the most certain happiness, and to the utmost spirituality, important facts are taught about the inner-plane and its energies. The history, nature and future possibilities of the human soul are explained. The power of thought as a factor in human and other types of life is emphasized over and over again. The vibratory emanations of objects are classified. And the effect, use and cultivation of the emotions are given detailed consideration.

Yet not one of these things, nor any other factor of human life, can be completely understood in all its significance unless it is linked, either by correspondence or by its relation to a given birth-chart, with astrological energies. Therefore, even though we avail ourselves of every important finding of material science, go far deeper into psychology than the most erudite materialists, and leave no stone unturned to gather information in this world and from the realms of the after life; because the adequate interpretation of any of it, in so far as the human soul is concerned, is impossible without the aid of astrology, and because astrology affords the best possible road-map for guidance to the most effective and highest type of life, we call our religion The Religion of the Stars.

It is a popular conception, and one still held by backward astrologers, that astrology is mere fortune-telling.

According to this popular conception of fortune telling by means of astrology, by the psychic faculties, or by some method of divination, a properly qualified individual is able to discern what will take place in the future. This future he reveals to his client, who then knows what is going to happen, but is powerless to do anything about it.

This conception is both erroneous and inadequate. It fails to take into consideration either the nature of astrological energies or the power of the individual. In lesson No. 140 it is explained in detail that astrology only maps inner-plane weather conditions, that with our present knowledge we are powerless to change either the outer-plane weather or this inner-plane weather, but that with equal facility we can take precautionary actions, when the impending weather is foreknown, that usually will enable us to escape disaster from bad weather and which will enable us to take greater advantage of favorable weather.

Once at Johnstown, Pennsylvania, and once in San Francisquito Canyon near Los Angeles, due to unusually heavy rains the dam of a huge reservoir broke and brought loss of life and huge property damage. In either case it was quite impossible for those living in the path of the surging flood to prevent its approach, or to cause the rain which was responsible to cease before the dam broke, or even to prevent their homes being washed away. Yet those who received warning in time were able to make their way to safety before the water reached them, and were able to induce their friends also to seek proper refuge. Those not so warned met an ugly death.

It is unlikely that those in authority would have paid any heed to an astrologer, or to a seer, who had told them the dam would break. In fact, it would have been unusually difficult to have brought sufficient pressure upon those in authority to have caused them to take the steps necessary to prevent either disaster. Neither the astrologer nor the individual living below the dam could have altered the situation that the dam would break, even though they foresaw that it would do so, and had ascertained about the date when the flood would occur. But those living below the dam who were convinced that the astrologer, or the seer, had accurate information about it, could have moved their personal belongings and themselves from the path of the water to come, and could have warned their acquaintances to do likewise.

In regard to the San Francisquito disaster I do not need merely to suppose such a case, because there were families who believed in such warnings, and who as a result of them moved out a few days before the dam broke.

But I am not relating this to cite an instance in which astrology, through its warning, saved the lives of those who believed in it. I use this actual instance to illustrate something that every Stellarian should make a part of his religion. It is that, so far as the individual is concerned, his reaction to a condition is never irrevocably predetermined. Perceiving a condition approaching, no matter whether it is

presignified by astrology, by extrasensory perception, or by some method of divination, he always retains the power, up to the moment he acts, of acting differently. Even though clairvoyantly he is seen acting in a certain way in the future, up to the time he acts he has the power within himself to act differently than was perceived in the clairvoyant vision.

There are both outer-plane and inner-plane weather conditions that are so drastic that in spite of forewarning the individual cannot escape disaster. In early 1949 there were blizzards with cold and such snow over the Great Plains area of the United States that even though they had known how severe the weather would be, many people would have perished and thousands of their cattle would have starved and frozen. Other people so warned could have found refuge, could have driven their cattle to more sheltered areas adjacent to food, and thus been spared disaster. And in like manner, under most conditions, if the individual is aware in advance what the astrological weather will be during a certain period he can take steps which will enable him to escape what otherwise would be disaster, and to take greater advantage of favorable conditions when they arrive.

The First Thing a Neophyte Should Know is that He Has the Power to Direct His Own Destiny

—The neophyte striving for adeptship can never hope to attain that exalted state, or even to make much progress toward it, so long as he supinely waits for the misfortunes shown by the stars to overtake him, or languorously looks forward to such benefits as are shown to be showered into his lap. There is not one misfortune that comes into his life that, foreseen, cannot be made less severe in its effect upon him, and not one blessing that cannot in some measure be made more bounteous by the proper use of intelligence and initiative. Chief among the objectives of The Religion of the Stars is to enable the individual to attain optimum living. And to attain optimum living, to the greatest extent possible he must enfranchise his soul. Astrology and the various other arts and sciences explained in Brotherhood of Light lessons are not to be studied merely to learn what is going to happen to the individual, but chiefly to give him information as to what he can and should do about every condition that arises or is foreshown. His interest in what is going to happen should be, to the extent of his power, to make it happen in the way he desires, or at least so to adjust his life that it will not affect him adversely.

Every one of the 210 lessons in the 21 courses contains information which can be used in some manner to give the individual a surer mastery of his own destiny. The soul, hampered with a physical body here on earth, must function in an environment which constantly influences its physical form and its astral form. It cannot be free from the actions of people, it cannot be free from the impacts of physical objects, nor the influence of the foods it eats, and it cannot be free from the influence of heat, cold, wind and moisture. Nor can it be free from the equally powerful influence of people's thoughts, the character vibrations of objects, and the inner-plane weather which crowds against its finer form.

Nevertheless, with an understanding of both the outer-plane and the inner-plane environmental forces and how they work, it can bring its own energies to bear in a manner which will enable it to expand its own possibilities and move persistently in the direction of spiritual unfoldment.

What is seen in the future, whether by astrology, or by some psychic means, is the relation of the physical environment or the inner-plane environment, or both, to the individual. It cannot be foreseen what the individual will do when so environed or influenced. From a knowledge of the individual's character, and a knowledge of the type and power of the energies influencing him, it can be foretold with reasonable accuracy what he is likely to do. But the final decision is up to him. If, foreseeing the condition before it arrives he decides to act differently, he has the power to do so. Initiative and intelligence form the lever and the fulcrum by which the soul can lift itself from its slavery to any force or condition.

The birthchart, mapping as it does the organization of the individual's experiences up to the moment of birth in human form, does indicate both the natural aptitudes and the predispositions. But it does not irrevocably determine an individual's thoughts, emotions, or his reactions to environment. The predispositions, if he uses initiative guided by intelligence, may never develop into the events or conditions indicated.

You may be sure that person with Mars conjunction the Asc. has a predisposition to be fiery, combative, and easily aroused to antagonism. Yet I know people with this position who are calm, mild spoken, and almost never show anger.

They invariably admit that in early life they had a violent temper. This temper and undue aggressiveness may have brought them serious trouble. Then they may have taken up occult studies which revealed how unwise permitting outbreaks of temper is, or the change may have been merely because they realized how disagreeable they were in the sight of others. But for some reason these individuals had determined to overcome a tendency with which they were born, and which an astrologer would immediately recognize in their birth-charts. They had resolved not to pass through life with the character with which they were born. And by dint of persistently cultivating other habits they had actually, and beneficially, changed the personality shown by their birth-chart.

I could tell of other acquaintances I have made during the almost fifty years of looking at birthcharts who were born with Saturn so prominent and afflicted that they were personifications of grasping selfishness. And I could speak of their coming into a higher conception of life, perhaps embracing The Religion of the Stars, and from thence on gradually changing the personality so that they came to be recognized far and wide for their charitable impulses and generosity in helping philanthropic enterprises.

But I do not need to draw my personal acquaintances into this discussion to illustrate the truth that the individual has it within his power to change the character with which he was born, and which the birth-chart indicates. For history is replete with the lives of great men who, in spite of early character defects and blemishes, changed their lives gradually until they were more noble, more powerful, and more useful to mankind than this early character and birthchart might commonly indicate.

Therefore, the neophyte endeavoring to realize the power of his soul to direct its own destiny should recognize that character and ability undergo a process of continuous change. They are not static, not something poured into an unchanging mold; but moving forward or retrogressing from day to day, from week to week, and from year to year. You do not possess the same character, the same abilities, the same power to attract opportunities, that you had a year ago, or that you will have a year hence. You do not possess the same character with which you were born, or which you had in astral life a few years before you were ushered into human form.

The birth-chart does very accurately map your character, opportunities, harmonies and discords as they existed at birth. You may have lived up to the expectations there shown, or have fallen far behind what ordinarily should be expected. But that is not too significant for the future. What you want to do now is to start at your present stage of development and move forward in the development of knowledge, ability, inner-plane organization and spirituality as fast as possible.

To do this you must really know yourself. You should become thoroughly familiar with your own birth-chart and what it indicates. From it you should find out what particular aptitudes you possess, and then decide how these best can be developed into abilities which will benefit society. You should ascertain within what kind of an environment such abilities as you expect to develop can be used with most good fortune, as indicated by your chart. And then you should develop these abilities, and use them to the advantage of universal welfare.

From your chart you should find out toward what diseases and unfortunate events you are predisposed, and then take the necessary precautionary actions to prevent them developing or coming to pass.

You should get a good perspective of the fortune or misfortune your chart indicates for each of the twelve departments of life, and should take advantage of those which tend toward good fortune, and take precautionary actions relative to those that indicate misfortune.

And you should cultivate the type of thinking which is the natural antidote of the planetary energies in your chart which are discordant and thus tend to attract misfortune. One of the biggest jobs you have, and one which you should work at daily, is to reorganize more harmoniously the thought-cell organization of your finer form. Not only the events you attract in this life, but those you will attract in the next life, are due to the psychokinetic activity of these thought-cells so they will desire, and work for, more harmonious events.

But such a knowledge of your inner-plane organization, or character, as mapped by the chart of birth is not enough. You must also be aware in advance of the inner-plane weather conditions which will influence you and tend to attract into your life events of a certain type at indicated periods. Unless you know when a certain type of inner-plane weather is going to arrive, and what kind of events it commonly brings with it, you are almost sure to experience these events. But if you know what the inner-plane weather will be before it arrives, and take the proper precautionary actions, the events will be more favorable, and often you will be able entirely to avoid those which are unfortunate.

In order thus to take advantage of foreknowledge of inner-plane weather conditions you must know in advance the progressed aspects which map the inner-plane weather. And you should learn, from a study of Course 9, Course 10 and Course 16, just what precautionary actions to take to handle any given set of inner-plane weather conditions to best advantage.

The neophyte should calculate and set down in chronological order all his major progressed aspects for several years ahead. He should at all times have them thus calculated several years ahead and set down where he can conveniently consult them, and he should thus keep aware of the kind of inner-plane weather and what it is likely to bring several years in advance. He should know just when each such major progressed aspect gets within the one degree of effective orb. And he should keep aware several months in advance when each sub-major progressed aspect gets within its one degree of effective orb, and when it moves beyond the one-degree of effective orb. Thus will he know when a certain kind of inner-plane weather will start and when it will cease.

To keep thus informed by being able to see all of the major progressed aspects at a glance, and to discern the period during which each is within the effective one degree of perfect, there is nothing better than to have a Church of Light Aspectograph hanging on a wall, with the lines drawn showing all the major progressed aspects covering 12 years.

During the period when each important major progressed aspect is within the one degree of effective orb—which can be ascertained by a glance at the Aspectograph—the neophyte should also keep informed a month or two ahead of just when minor progressed aspects forming to one of the four terminals of the major progressed aspect will reinforce its power and make it more likely at that time to attract an event of the character of the major progressed aspect.

To keep thus informed by being able to see both the major progressed aspects and the minor progressed aspects reinforcing them, nothing is better than to have a Church of Light Aspectograph hanging on a wall, with the lines drawn on it showing all the major progressed aspects and the minor progressed aspects for 12 months in advance.

The Aspectograph not only shows when each aspect is perfect, but shows at a glance when each minor progressed aspect, which may have reinforcing power, is within the effective one degree of orb to any birth-chart or major progressed position.

However, it is not important whether the neophyte draws his progressed aspects on an Aspectograph, or whether he merely tabulates them in a note book which he keeps handy and consults at frequent intervals. The important thing is that at all times he should keep aware of major progressed aspects and when they will be reinforced by minor progressed aspects before they are actually present, and that he take the proper precautionary actions relative to each. If he does this, he will have much better fortune in all departments of his life, and will be able to make progress twice as fast as if he had ignored them. And if he ignores them he may meet obstacles that are too difficult for him to overcome.

The Second Thing Every Neophyte Should Know is that He Should Be Cosmic Minded

—I do not mean that every person who believes in The Religion of the Stars, and who, perhaps, becomes somewhat proficient in some branch of occult science, will become cosmic minded. I refer here to the earnest neophyte who has determined to live The Religion of the Stars, as well as believe in it, and who is determined to approach as closely as possible the state of actual adeptship. Such a determination implies great devotion.

Real devotion to The Religion of the Stars, such as the neophyte will find absolutely essential before he reaches adeptship, requires a complete readjustment of the mind, and consequently of the life, from the conceptions and actions which are common to non-religious men. It requires an absolute and unconditional surrender of the life to a religious principle. But this surrender, and the actions which spring from it, are far different than those of any orthodox faith. The only resemblance to orthodox devotion is the completeness with which the devotee delivers his life into the keeping of the Divine Mind.

He is led to this surrender of his personal ambitions, not through blind faith, but because, in some manner he has become conscious that the cosmos is an organization of minor intelligences of various degrees, presided over, and permeated by, an Infinite Intelligence. Just how this conviction first will be borne home to him depends upon a variety of circumstances. He may at first become convinced merely by observing what goes on in nature, and thinking about it. Or he may become

convinced through observing how accurately the Hermetic Axiom, ‘As it is below, so it is above; as on the earth, so in the sky,,,’ works. Or he may gain this vision through a flash of illumination. Or, again, it may seep into his consciousness as gently as the frozen clods of earth are warmed and caressed by the northing sun at the first advance of spring.

The easiest way for the neophyte to gain cosmic mindedness is through using The Church of Light Mantram. It should be repeated every night at least once after getting into bed and before going to sleep, and every morning after waking and before arising.

It should be made as much a habit as undressing at night and dressing in the morning.

Such an ideal as this, based upon Truth, held in the mind and vivified by The Church of Light Mantram given below, will produce a mental and spiritual state in which the individual will tune in on the all-pervading Super-Intelligence of the universe at a high vibratory level. And, in the course of time, it will be spiritually assimilated and then will evolve outward and become the dominant idea of Truth, which will result in Spiritual Power.

“1. My Soul is One with the Universe, and my Spirit is an emanation from Deity.

“2. I am commissioned by the Infinite One to assist in the scheme of His Creation.

“3. I am assisting in the progressive evolution of creation, and in so doing my soul and its infinite possibilities are progressing in proportion to my desire to use all my powers and possibilities in Spirit and in Truth.

“4. My physical organism is my natural universe, over which I alone will rule. It is my material cloak, or garment, through which I will manifest the powers of my Divine Nature.

“5. I am progressing rapidly toward the subjugation of matter and the complete lordship over all sub-mundane atoms of life, which exist only by my permission, as peaceful and obedient servants within the lower animal realms of my dominion.

“6. They exist by virtue of their functions in the work of creation, which I am now assisting; but they are, and ever must be, subservient to the higher realms of Spirit to which I by right belong.

“7. I am eternal Spirit. My Soul is Immortal. No power in this infinite universe can alter my immortal nature, nor control my Soul’s glorious destiny of eternal progression; because My Soul is One with the Universe and My Spirit is an emanation from Deity.”

Whether it comes from the use of this mantram, or through some other channel, you may be sure that long before any individual reaches real adeptship he will have adopted the cosmic method of life set forth in this Church of Light Mantram.

This method of life, at all times, and in all ways, subjugates the desires of the devotee, and the actions resulting therefrom, to the principle of cosmic welfare.

Every day problems arise. Sometimes these problems are not important, and at other times their proper solution may mean the difference between success and failure, or even between life and death. That is one of the chief functions of all life-forms, to try to handle the situations with which the life-form is confronted in the best possible manner. Only those life-forms which have successfully solved the problems with which they have been confronted have survived. The others became extinct. All progress depends upon learning how to handle conditions to better advantage, how to overcome difficulties.

The neophyte, therefore, should develop the habit of thinking carefully about his daily life, as well as about more important problems, to discern if he is handling all his affairs in the best possible manner. He should at all times be on the alert to try to handle every situation with which he is confronted or to which he has already become accustomed, in the best possible manner.

And in thinking each problem through, little or large, he should base his decision as to the best manner of handling it on the premise that each should be handled in the manner that will contribute most to universal welfare.

Thus to the true devotee of The Religion of the Stars there is but one type of counterweight to be used in the scales when weighing any decision. That counterweight is the extent to which the thought, feeling or action being weighed will contribute something beneficial to universal society.

Some of us are fairly familiar with the idea of The Surrendered Life through the attitudes of devotees of other religions. Such devotees seek to submerge their individualities, to become automatons directed by the guiding force of some religious conception. Some, for instance, renounce material possessions, take no thought of their physical well being, and spend their time in prayer. Others, especially in the Orient, make a pronounced effort to suppress every desire and to destroy the individuality, or to bring about a blend of the individual with the principles of nature in such a way that physical effort and physical life hold no attraction. There is a subjugation of Self which leads to passive acceptance of things as they are, and spurs the devotee on to no greater effort to change conditions about him.

But the surrender of his life to the Divine Will, as made by the devotee of The Religion of the Stars, both in conception and in result, is almost the direct opposite of this.

The devotee of The Religion of the Stars—and every neophyte who seeks true adeptship must ultimately become such a devotee—recognizes, through his countless contacts with other life-forms, and through even more direct contact with the Super-Intelligence, that there is a Supreme Mind Whom most call God, Who permeates and actively directs the whole universal manifestations on all its planes. And because, through his observations and studies he has become convinced that this Supreme Mind is amply fit and capable of managing the cosmos, he accepts God as his highest superior in this universal organization of which he forms a minute, though essential part.

Having faith that God knows how to run the universe far better than does man, he looks to God for instructions regarding what he can do to benefit the universal organization. And his studies give him a good general idea of what God is trying to accomplish and how He is trying to accomplish it. Perceiving this, instead of doing the things his unenlightened desires would lead him to do, or doing things according to the narrow viewpoint of materialism or orthodoxy, he undertakes to do the things God would have him do. God is the General Manager of the cosmos, and he is a workman taking orders from the General Manager, or from those appointed over him by the General Manager.

Even in the industrial plants of earth, the workmen do not run about and do just as the impulse moves them. If they did, the organization would fail, and they would themselves shortly experience hardship. Instead, each individual finds something to do, or is directed to it, and works, not just as his inclinations move him, but with the single aim in view of furthering the chief objectives of the whole organization.

And the devotee of The Religion of the Stars, in a like manner, strives continuously, not to satisfy his own passing whims, but to do those things which he is convinced will aid the purposes of the whole cosmic organization. His study of the 21 courses of Brotherhood of Light lessons is for the purpose of finding out what the General Manager of the cosmos is trying to do, and how he, a workman in the cosmic plant, can do that which will help most toward the realization of the Divine Plan.

He completely surrenders his own whims and passing desires to the furtherance of the Divine Plan. He realizes that the good of society as a whole is far more important than the good of any single individual, like himself. Consequently, in every action, every day of his life, he considers the effect upon cosmic society, and upon this Progressive Universal Plan which the Divine Mind has so competently formulated, and which he has somewhat discerned in his study of The Religion of the Stars.

But this surrender of his life to the fulfillment of the Divine Will is just the opposite of the negative attitude of those of certain orthodox faiths who surrender their lives to religion. These individuals, for the most part, strive to withdraw from the world and its affairs. They seek a holy life in which the active work of the world, and the active work of the after-life, are performed by less holy individuals. They fail to realize that if the universe is to advance to a better condition, intelligence and initiative must actively be used in making it better.

They are like a certain class of potential voters in our national life. These, because they do not like the way political conditions and economic affairs are handled, refuse to meddle in politics, and do not even take the trouble to cast a vote. They seem to believe that somehow things will get better due to the efforts of others. They might just as well think when their auto breaks down on the road all they need to do is to sit in the car until someone comes along and repairs it. It may be that, with no initiative or activity on their own part, no telephoning some repair garage, some kind-hearted person will come along, stop, and repair their car or call a repair garage. But they thus merely shift to others the work they should do.

Yet when a car stalls, instead of hoping someone will come along who will stop and fix it, the intelligent man does whatever he can to remedy the trouble. And if he cannot fix it himself he calls a repair man to come and do the work. And when those who do not like the way our government is run, who feel our economic system is unjust, exercise as much intelligence and initiative in remedying conditions as those do who now determine how these affairs are handled, we shall have a new and better political and economic era.

Likewise, when holy men, instead of merely dreaming of a more perfect type of life, either here or hereafter, in which everything will be provided for them without effort on their part, and in which they will escape distasteful contact with worldly turmoil; when these men realize that the condition of the world and the condition of the after-life depend upon the intelligent effort men make to change conditions for the better, then progress will become more swift, both below and above.

But the devotee of The Religion of the Stars recognizes that things are not just going to be done for him, and are not just going to be done for the universe. The progress of the cosmic organization depends upon the intelligence and initiative thrown into it by the various individuals who compose it. Do not think that God, the General Manager of the concern, is going to do all the work of the whole organization. The work to be done has been efficiently planned by Him, and the end to be accomplished through that work made apparent. He gives instructions as to the methods to be employed. But the actual work to be accomplished, the actual progress of the cosmos, is in the hands of subordinate intelligences.

Some of these subordinate intelligences have vast powers, enabling them to direct the construction and development of a universe. But they, in turn, are dependent for what is accomplished upon lesser intelligences working under them. And so on down the scale of organization, man on earth being a type of workman who has it within his power to grasp the overall scheme of things in a general way, to discern what he can do as a workman, and also possessing considerable power to direct the energies of intelligences less advanced than himself into proper channels.

The devotee of The Religion of the Stars thus arrives at a state where he perceives his responsibility to universal society. He realizes he is a factor in the scheme of things, and that he can at all times do something to help realize the Divine Plan. He does not expect the universe to run itself, any more than he expects an automobile to run itself. He is not afflicted with the idea that the whole organization would collapse if he should shirk on the job; but he does know that what he can do really helps things along. And because he recognizes these things he exerts his energies and his intelligence and his initiative to the utmost in furthering the realization of the Divine Plan.

And to do this with the utmost efficiency of which he is capable, he forgets himself except as this self is a factor in the furtherance of realizing the cosmic scheme. Yet this is not in the direction of destroying his individuality, his initiative, or his ingenuity. Instead of discouraging individual initiative and ingenuity, the good manager of any concern does all he can to encourage his employees to do independent thinking, to devise better ways of performing work, to suggest superior ways of handling departments, and to think of any and everything that will make for a more successful organization. To surrender the life to the Divine Mind as taught by The Religion of the Stars, requires that the individuality should be built and strengthened, that the intelligence should constantly be used, that abilities should be increased, and that knowledge should be accumulated, instead of any or all of these being subdued.

In reference to the way to handle things in the manner best for universal welfare, the constructive attitude should be cultivated. This attitude is given detailed discussion in lesson No. 152. It means, among other things, that the character must be so changed that whatever situation arises, pleasure is felt in the attempt to meet it in the best possible way. Not that this attitude will always result in overcoming the difficulty. But viewing whatever transpires as a new problem which gives opportunity to devise the best way to meet it, and taking pleasure in meeting it in the manner devised, not only increases efficiency, but it permits no inharmonious vibrations to be built by the thoughts into the finer body. This completely constructive life, based upon the problem attitude toward events, is one of the marks of adeptship; and any neophyte who succeeds in building it into his character as a permanent habit-system may be assured he is well along the path toward becoming an adept.

As to what will best assist in the furtherance of the realization of the Divine Plan, almost every thought and action can, through adopting the constructive attitude, be made, at least in some small degree, to operate in this direction. But for a general overall picture of those things which assist such progress, and which we should at all times work to see realized, this will become clear when we recognize from our observation of nature that all life-forms are striving to realize in greater degree the

drive for significance, the drive for nutrition and the drive for reproduction. Nutrition in its expanded form embraces all those things which give the life-form health and continued existence. And reproduction in its expanded form embraces not merely physical progeny, but also mental progeny. New and original ideas are offspring resulting from the reproductive desire.

If people are to have food, clothing, shelter and the comforts of life with which to satisfy the nutritive drive, they must have adequate information, and they must not be curtailed by the greed for power or material things by those of special privilege. Activities which assist people to have freedom from want further the realization of the Divine Plan. And as fear arises from anticipation of want or of injury, anticipation that the nutritive drive or the reproductive drive will not be realized, activities which assist people to be free from fear also further the realization of the Divine Plan. And freedom from fear can only be had when there is adequate information.

Religion merely strives to employ nonphysical means to continue to realize the drive for significance, the drive for nutrition and the drive for reproduction after the death of the physical body. And if it is to perform a sound service, people must have as much information as possible about both planes. Thus is it also dependent upon freedom of information.

Any activity, therefore, which will assist people to have freedom from want, freedom from fear, freedom of religion, and particularly that freedom of expression which constantly seeks and disseminates as widely as possible new information, is in the direction of assisting in the realization of the Divine Plan.

The Third Thing Every Neophyte Should Know is that to Use Occult Knowledge or Psychic Power to Take Advantage of Another is Disastrous

—Merely from the moral point of view, it is no greater wrong to enslave another, to take money away from him unjustly, or to influence him to conduct detrimental to himself, through the use of occult powers and knowledge than it is to use a gun or a club to gain the same ends. The individual doing any of these things has not grounded his personality in The Religion of the Stars. He still belongs to the stratum of humanity which has evolved in intelligence above the brutes, but which as yet is moved and activated by the motives and impulses of the brute world.

Of course, whatever method is employed to gain an unjust advantage over another, reacts unfavorably upon the character. One builds into his character the mental states which correspond to his thoughts, feelings and actions; and when these are selfish and antisocial they lower the dominant vibratory rate of the individual. He sinks to a lower spiritual level.

But in the practice of the occult sciences and the application of occult knowledge, an additional factor is always present. This additional, and very important factor, which can be avoided by no one who makes extensive use of occult knowledge or occult powers, is that by the very nature of occultism its study and practice tunes the individual in on entities of a similar vibratory rate and similar desires in the unseen world.

Such tuning in may be, and often is unconscious. But the intelligences thus contacted, nevertheless, assist him in his investigations and in his endeavors. They are attracted by his desires, which are of similar quality and basic vibratory level as their own.

Thus the moment he begins to use his occult knowledge to take advantage of his fellow man, and the moment he begins to use occult powers to the detriment of others and the benefit of himself, this mental attitude tunes him in on and attracts to him a swarm of invisible life of the lower astral levels. Unknown to himself, perhaps, he has tuned in on a realm of iniquity; and the entities of these realms, some of which are of the racketeer and gangster type, and some of which are elementals, strive by every cunning means to get him under their power. And you may be sure, if he continues to use occultism as an unfair means to gain advantages, or to injure others, that every such operation on his part places him more and more in the power of invisible forces which delight in the slavery they force upon him.

That this is the case need deter no well-intentioned person from occult pursuits. Occultism is no more dangerous than other scientific knowledge. Hardly a discovery of material science—the latest important one at this writing being atomic energy—is made that does not open the way for the foolish to destroy themselves through it. Every step in human enlightenment opens up new fields for foolishness, new fields by which the greedy may exploit the unwary, and new hazards commensurate with its advantages.

To the individual who remains not on the plane of real humanity, but sinks back to the brute level in his morals, occultism offers tremendous dangers, both to himself and to his victims. It is not something for one less than human to meddle with. And if he does tamper with it, from the plane of brute life, he will come upon an awful reckoning. The life and suicide of Adolf Hitler (chart in Lesson No. 2) is but one of numerous examples that might be cited.

Yet to such persons as have attained the normal vibratory level of humanity, the occult sciences, which merely explain inner-plane facts, offer no such dangers. Such individuals will not shoot a man in the back to rob him, and they will not use occult powers to rob him. Such individuals will not embezzle the money of widows and orphans behind the cloak of the law; neither will they use astrology to find the weaknesses of victims whom they can traduce. To the man of average morals, occultism offers no more perils than does material science.

But this the neophyte, seeking adeptship, should realize at start; that with every gain of knowledge and power comes the opportunity to use them either for selfish and unworthy advantage or for the benefit of cosmic welfare. And his own soul's weal depends upon his using such powers as he comes into possession of for the good of all. Yet, because his ability to help others in large measure depends upon his own welfare, in pursuing the practice of The Religion of the Stars, in which every decision, every thought, every action and every emotion is determined upon the basis of HOW MUCH IT CONTRIBUTES TO UNIVERSAL WELFARE, he will usually find that his own affairs prosper amazingly.

Chapter 2

Serial No. 217
Original Copyright 1949
Elbert Benjamine

Copyright
August 2002
Church of Light

The First Three Habits A Neophyte Should Adopt

Chapter 2

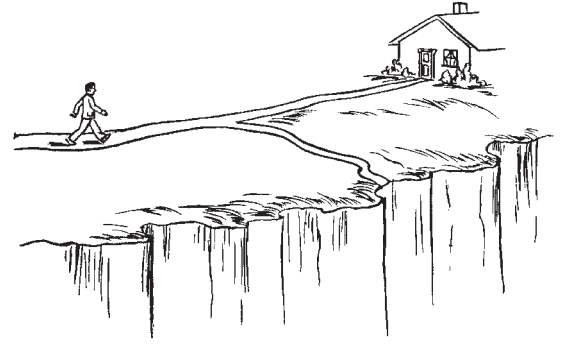

The First Three Habits A Neophyte Should Adopt

THROUGHOUT our studies of the occult the thing we find stressed most is the importance of character. The character and I the soul are assumed to be identical. And it is recognized that in the presence of a given inner-plane weather, in the presence of a certain influence radiated by an object, in the presence of a specific thought, or in the presence of the same external circumstances, an individual possessing one kind of character will behave in a very different manner than will an individual possessing another type of character. The effect either an outer-plane environment or an inner-plane environment will have upon an individual is determined by his character. And occult training as well as religious precepts mostly have for their aim the development of a superior type of character.

Now what is this thing we call character?

This question can be answered by stating that it is the sum total of all the states of consciousness the soul has experienced as these are organized within the finer form of the individual. But in addition to such a bare statement of fact, in order to make the matter clear, there should be added information both as to how the character was formed, and how it manifests.

It was formed, as is so often repeated in various B. of L. lessons, by the sum total of all the soul's experiences registering in consciousness and entering, according to the manner thus registered, into the mental organization, where such registered experiences persist, either as they were registered or as modified by later experience.

Thus persisting in the finer bodies as an organization of mental factors, the character determines all the acts of the individual in the presence of whatever environment he contacts. The character manifests as behavior, and the type of behavior depends upon the kind of character. In the same kind of environment, if the character is changed, the behavior also is changed. What we accomplish, therefore, and what we fail to accomplish, is determined by character. And if we wish to pursue the matter still

further, taking into consideration the psychokinetic power of the internal harmonies and internal discords organized as thought-cells and thought structures, to bring conditions into the life, we find that not only is behavior in the presence of environment determined by character, but that the kind of environment attracted to the individual also is determined by his- type of character.

Character determines both the external conditions which call for decision and action, and the kind of decision and action resulting from the condition thus attracted. Both to the individual, and to society which tolerates or benefits by the individual, character is the one thing of paramount importance.

In its manifestation, character is the manner in which we habitually think, feel and act. And whenever we arrive at a stage where we think, feel and act habitually in a manner different than we have previously thought, felt and acted, we have clear evidence that our character, by that much, has changed.

And this is the object of Personal Alchemy; to change the character in such a manner that the individual lives better than previously, and to keep making changes in the character, one after another, that will enable him to advance step by step up the ladder of spiritual attainment until the state of adeptship. the state of the perfect man, is reached.

As the manifestations of character are the habits of life, the proper method to follow in thus changing the character beneficially is resolutely to set about the elimination of such habits as are not conducive to the high spiritual state one wishes to attain, and as resolutely to set about forming all those habits which are in the direction of adeptship. For whenever the proper habits have been formed and have been exercised over a sufficient period of time, they prove that the internal character also has changed to a corresponding extent. In fact, not only are the habits of life an accurate index of the character within, but the habits of life also act as forces by which the internal character is altered.

It will thus be seen that the neophyte who, let us say, has lived much as the world about him, can hope to make a rapid ascent to a higher type of life only by markedly changing his habits. If his habits remain as they were, his life will make only such progress as is customarily made by other people who have similar habits. Yet he is not content just to drift along, just to gain a little intellectual comprehension of the truth. He is ambitious to make swift progress. And he can only do this through adopting a manner of living which, while not making him conspicuous in eccentricity, nevertheless is really markedly different from the life of the majority of those by whom he is surrounded.

There is no occasion that I can see for the one who aspires to the state of adeptship to withdraw from contact with his fellowman, to shirk the responsibility of making a living, or to refrain from taking an active part in the management of the affairs of the community in which he lives. An adept is not one who goes off alone and meditates, and thereby gains some wonderful power for himself which he never uses to benefit mankind. On the contrary, an adept is a man or woman who has developed a very high degree of spirituality, and who has gained both power and knowledge for the purpose of using them to benefit humanity, and who does so use them to benefit as many as possible.

In one's own home, or during the lunch hour of a business day, one can go into the silence, one can meditate, and one can do other things which are desirable in the matter of developing occult powers. Powers develop fastest when used. And among people there are always opportunities to use such abilities as develop for some constructive purpose. In reference to learning, as I have pointed out elsewhere, it is commonly recognized that quicker progress in knowledge of any subject is made in the effort to teach it. Undertake to explain something to another, and not only do you find out whether or not, and how much, you know, but in the process of explanation you tune in on the source of such knowledge and are surprised at the additional information, about which otherwise you never would have thought, which comes streaming into your consciousness. When teaching, especially in teaching any occult subject, new examples and additional material customarily present themselves to the mind.

Of course, to do much studying and original research there must be time devoted to them; but adeptship, which we are now considering, is not merely a matter of intellectual attainment. It is even more the development of character, a progress from a less spiritual to a more spiritual state. And the circumstances of everyday life afford far more opportunity for the development of spirituality and real soul power than is afforded by a monastery or a wilderness. Everyday life affords just those obstacles by which we are able best to test whether or not, and how much, we are advancing.

If an individual is capable of living a perfectly spiritual life, such as an adept lives, he can live it in any environment where he finds himself. If he can only live the perfect spiritual life when apart from his family and friends and business associates, it is not a perfect spiritual life he is living, but merely an artificial life which, like a hot-house plant, seems beautiful only while under special care and protection.

Do not think the real adept lives apart in the mountain fastness. The real spiritual giants live and work among men, contributing their energies and powers to alleviate human ignorance and suffering, and in all ways possible aiding in the realization of God's Great Plan.

To become such a spiritual giant the neophyte must make a small beginning and gradually, one step at a time, change his habit-systems until, as a matter of steady growth he has those habits of life which distinguish the adept. The adept, or perfect man, must, of course, master all the 21 branches of occult science. He must be an individual marked for his wisdom. And in the course of his development he must attain to certain occult powers. Furthermore, his efforts lead him to a refinement of thoughts, emotions and actions, so that he is a being of superior appreciations and perceptions. But above all, and at all times, the mark of the adept is his strong adherence to the perfect moral code: A SOUL IS COMPLETELY MORAL WHEN IT IS CONTRIBUTING ITS UTMOST TO UNIVERSAL WELFARE.

The real adept has arrived at the state of adeptship, not through any selfish desire to be superior to other men, and not through a desire to exercise uncommon powers. Instead, he has arrived at this exalted goal because, as a neophyte, he has realized that in the attainment of a higher type of spirituality, by the attainment of unusual powers and abilities, and through the use of more comprehensive knowledge, he could do more to assist in the furtherance of God's Great Plan. He has arrived at adeptship not through any "holier than thou", motive, but through his earnest desire and endeavor to contribute the most possible to cosmic welfare, and perceiving that ability, wisdom and increasing power would lead him to this objective.

Therefore, the sooner the neophyte adopts this universal and perfect moral code as the one dominant motive and guiding power in his life the more speedily will he advance toward adeptship. And never, in this life or in any other, will he attain adeptship until he does thus become completely moral in this universal sense.

The First Habit to Adopt is to Make All Thoughts, Feelings and Actions Conform to the Universal Moral Code

—The neophyte should make a permanent habit of analyzing every habit and process of life as it now exists in the light of his present understanding with a view of perceiving how much each contributes, in the long run, toward assisting or hindering universal welfare. Then let him start making the changes in his life that will enable him to contribute more to, and hinder less, cosmic progress.

Unless the neophyte has had wide experience, and has had the opportunity to observe the results obtained by many people in their application of theories, he will almost surely believe certain habits and practices are in the direction of contributing to universal welfare that his actual experience in time will cause him to abandon. The literature of the time is redundant with theories on gaining knowledge, with theories on how tremendous occult powers can be developed, and with theories on what constitutes spirituality. And it is hardly to be expected that the neophyte at start will escape being attracted to some of the many highly embellished theories that in practice do not work.

And the neophyte who expects to get actual results from some practice, and diligently follows instructions all to no avail, is apt to feel discouraged. He is led to expect something that does not happen, and thus feels there must be something wrong with himself because his expectations are not realized. But far more frequently than might be supposed he is on a sounder basis of fact and reality than those who propounded the theory; and the reason he does not get the expected results is really because he is so sound of nerve and brain that he does not readily yield to suggestion and suffer delusion.

In saying this I certainly do not wish to disparage the independent development of the psychic faculties; for their cultivation and the development of the higher states of consciousness are not abnormal. They are in the direction evolution is moving. They can be cultivated on as sound a basis as one can cultivate a taste for high class music. But the awakening of the kundalini, the amazing results to be had by certain postures and rhythmic breathing, and various types of psychic phenomena, other than the exercise of extrasensory perception and entering into the higher phases of consciousness, are not apt to yield the neophyte all that is claimed for them by their enthusiasts; and they have associated with them some very real dangers.

Unless the neophyte is over zealous and enthusiastic, he usually is aware when things are not going right for him; and thus is warned before meeting danger or actual difficulty. And, because the temperaments of people vary so widely, it is hardly wise to draw the rules too tightly as to what should and what should not be attempted, and as to what may or may not be expected from following a given practice. What is most helpful to one often is of no help to another, and what is dangerous to one may hold no peril to someone else.

About the best general rule that can be laid down is for the neophyte to be constantly alert and observing, and to note carefully the effect of his practices and his habits as affecting his life and usefulness. The thing that is best for him is the thing that works best in practice, whether or not it follows the rules laid down in someone's book. After trying something out conscientiously for a time, usually some result, either positive or negative, can be discerned; and this can be used as a gauge of the value of the exercise or habit which has been adopted.

I have more to say in the next lesson about the development of the psychic senses and the higher states of consciousness. I merely mention them here to point out that beginners often get discouraged through not obtaining the results they are led to expect. Perhaps they need to change the method they are using; perhaps they need to give the matter careful thought and analysis; but they should not permit themselves to be discouraged; for the feeling of discouragement is pernicious and a hindrance to the neophyte's main purpose.

The Second Habit to Adopt is to Feel Pleased When You Have Done Your Best

—As I have taken much pains to point out in lesson No. 212, the soul is educated through pleasure and pain. The sensation of pain has been developed by the soul to enable it to become aware of those conditions which threaten the destruction of its organism or in other ways tend to thwart its desires. And pleasure has been developed by the soul to enable it to be aware when it has triumphed over the condition which threatened its form or its desires and thus is being successful.

Now, however, if we continue to register pain, in this instance the pain of discontent and discouragement, when we do the very best of which we are capable under the circumstances, the soul reacting in the normal manner from pain loses incentive to further similar effort. When one has done the very best he can under existing conditions, no amount of painful prodding will cause the soul to do more. When a horse is doing its best to pull a heavy load, further prodding will cause him to cease effort. Most balky horses at some time in their past have been educated, by some incompetent driver, in this manner to become balky. And the individual who continues to prod and annoy himself when in reality he is doing his utmost is quite as apt to become disheartened and cease making as much effort as he previously did.

If you beat a dog when he gives a good performance as well as when he makes a mistake, in a very short time the dog will no longer give a good performance. And the best animal trainers find that the less they use the whip on occasions of error, and the more they rely upon kindness and reward for good performance, the more success they have with their charges. This means that they have ceased to employ the pain technique and in its stead have adopted the more superior pleasure technique in the education of the creatures under their instruction.

If you have the narrow viewpoint that men have souls and that dogs have not, you may object to illustrating the education of the human soul by referring to the most successful practice of animal trainers. But in truth your soul and my soul are different than the souls of animals thus trained not in kind, but only in degree. And experimental psychology illustrates that the same basic principles of training are equally effective when applied to any living thing; plant, animal and man included.

Therefore in your effort to become a master, one of the first things you should do is to make a careful appraisal of yourself as to what, at any given time, you should expect of yourself. You may have either an inferiority or a superiority complex which will warp your judgment. Your contacts with life may be such as to cause you habitually to expect far more from yourself than you have ability to accomplish, or to expect far too little of yourself. Your temporary standards may be either too high or too low, and need readjusting.

I do not mean that the state of adeptship is too high for you. It is not too high for any earnest person; although those of marked deficiency may not be able to reach it completely until after they have passed to the next plane of existence. But it is very easy to expect to do more or less than is possible toward this ultimate end in a given interval of time. Failures there are bound to be. But a failure to accomplish as much as hoped for, so far as personal advancement is concerned, is infinitely better than not trying. We often learn as much by our failures as by our successes. Every failure should leave us in possession of greater ability for the next attempt.

Because pain, such as discontent and dissatisfaction with oneself, builds discordant thought-cells within the finer form, and these use their psychokinetic energy to bring into the life unfortunate events, I do not advocate that when one has not lived up to what he normally should expect of himself that he should permit any such discord to persist. Instead, the energies should be centered on the next attempt, and a confidence built up that the next attempt will be more successful. Instead of dwelling on the failure, it is far better to picture the success of the next attempt, and to picture with this success a glow of happiness, and as many other pleasant feelings and emotions in connection with it as possible.

In this manner, while not permitting the soul to lag in effort toward accomplishment; it is possible to build up a high degree of satisfaction in the consciousness that, regardless of temporary results, one is doing the very best he can. And this is the objective which early in the neophyte's training should earnestly be sought; to build as many, and as pleasurable, associations around the effort to do one's utmost regardless of apparent failure and adversity. This habit of feeling thus should become so ingrained in the essential nature that however difficult external environment becomes, there will be a finer and stronger satisfaction felt in meeting each situation and problem as it arises in the best manner, and that this satisfaction will outweigh in pleasure the pain and discomfort caused by the things which, in spite of these efforts, remain beyond control.

The Third Habit to Adopt is that of an Invincible Will

—It goes without saying that to accomplish anything really worth while requires the exercise of considerable will-power. And because, in his endeavor to become an adept, the neophyte must master his own mental processes and a number of studies, as well as develop his character so that it is superior in nature to the characters of the mass of mankind by whom he is surrounded, it is essential, to be able to carry out such an ambitious program, that he should possess a strong and vigorous will.

Occult training in all lands and during all periods has stressed the importance of developing will-power. And in the Orient are to be found a large variety of artificial systems which have been devised through which the neophyte can thus gradually, though effectively, develop his will.

Although these Eastern systems of will culture undoubtedly do develop will-power, an analysis of what comprises will-power reveals that, to one who will take the trouble to avail himself of the opportunities offered, everyday life can be made to develop will-power quite as rapidly and quite as effectively as can any Oriental or Occidental artificial system of will culture. And the utilization of everyday life for this purpose has two additional advantages. It does not crush the soul or stun the finer emotions, and in the process of its development there is constantly something constructive accomplished for the benefit of society.

An invincible will, when reduced to its simplest terms, is merely the habit of carrying out to its completion whatever one sets out to do. And a vigorous will, when thus reduced to simple terms, is the ability to direct a strong volume of energy steadily into the accomplishment of predetermined purposes.

A strong and vigorous will implies the ability to direct the energies into some chosen channel of accomplishment, and the ability not to be deterred from accomplishing the purpose thus selected. And the only way by which any individual ever learns thus to direct energy and learns not to be swerved from his purpose is through the gradual development of a habit-system in which energy is directed strongly to accomplishment, and in which obstacles which might be permitted to swerve him from his purpose are battered down, overcome, or circumvented.

I repeat, the only way by which any life-form, man included, gains a powerful will is through its gradual development in overcoming obstacles and not being swerved from the predetermined course by difficulties. And I am sure that no one, with all the things that need to be accomplished in the world, is required to invent artificial obstacles, such as holding one's arm aloft until it shrivels, or sitting on sharp spikes, to find difficulties on which to practice. These devices, of course, are not employed by the more enlightened devotees even in the Orient. But everyday life affords even better opportunities for the culture of willpower than the other and less painful artificial devices offered either by East or West.

The essential thing in the culture of will is to make up your mind what you are going to do, then do it energetically, and let no difficulty nor obstacle deter you until it has been finished. Each and every time you do this you have increased your will-power. And if, one time after another, you thus accomplish what you set out to do, you will gradually develop a powerful will. Other life-forms than man develop their will-power in the same manner. Will-power is developed by accomplishing whatever has been determined upon, and it is developed in no other way.

But when man, or any other life-form, determines resolutely to accomplish something, to do something, and permits himself to be deflected from his objective, his will-power is weakened. And every time he determines to do something and fails to do it, or starts something which he expects to finish and fails to accomplish it, he weakens his will. And if he continues to make resolutions and breaks them, in time his will becomes so flabby that he is considered by others, and looks upon himself, as a person of weak character.

You will now perceive that the development of will is merely a conditioning process by which the habit is developed of reacting to a decision in a particular way. The powerful will has gradually conditioned itself to react to a decision by always accomplishing the thing decided upon, and the weak will has gradually conditioned itself to react to a decision by seldom accomplishing the thing decided upon. Will-power is merely a habit-system which has been strongly conditioned to act in a given way.

Additional information as to the conditioning process is contained in lessons No. 155 and No. 212. Chiefly it consists of associating as many pleasurable elements as possible with the thing which is to determine the direction of desire and action in the future. In the matter of will culture, as many and as strong pleasurable thoughts and emotions as possible should be associated with the accomplishment of each thing which is attempted.

Perhaps the greatest obstacle to the proper development of will is the tendency of the neophyte, moved by the desire to accomplish great things, to undertake more at one time than he can reasonably expect to carry out. It is quite natural, suffused with enthusiasm, that he should wish to become a full fledged adept in the short space of twelve months. He outlines for himself a systematic course of study, certain hours to be devoted to concentration and other mental practices, and sets for himself high standards of conduct. The trouble-is that for as many years as he has been alive in human form he has been cultivating different habits of thought and action. And mere resolution is insufficient to displace these old habits. They come in and in a short time he finds that he has fallen deplorably behind what he hoped to accomplish.

To develop the will from a none too vigorous state, the very first thing is to form a habit of not making a definite decision to do a thing until all its possibilities and probable obstacles have been fully weighed. It is much better to decide to do less than later is actually accomplished than to decide to do much in a given space of time and then fall far below the mark. For every time you do the thing you set out to do your will is strengthened, and you have a right to have more confidence in yourself in the future. But every time you fall short of what you set out to accomplish your confidence in yourself is weakened. Therefore, at start, the greatest caution should be exercised not to make a definite decision to do something unless it is something you are sure you can do and are willing to make sufficient sacrifice to do.

Start in with the little things. Make no definite decision about other things, except that sometime, as soon as possible, you will master all the occult sciences, all the soul senses and states of consciousness, and arrive at the state of perfect man, the exalted adept. This you can safely do, because you have set no time limit. And it is good to have some ideal or objective toward which the whole life and energies are directed. It leads to the most effectual progress.

But whatever little thing you decide to do, place the decision in writing, state it publicly, or in some way set it apart from the various desires and wishes that are half decisions but have not yet reached a state in which you have decided irrevocably that you will do them. The thing of importance in this respect is always to have it clear in your own mind, and not subject to hedging, that you actually have decided to do the thing. And having decided, always keep faith with yourself and do it. That is really what it amounts to; it is keeping faith with yourself, it is keeping your own credit good.

Your soul knows how many times you have promised to do something and then have failed of performance. Would your grocer, if you had as often failed to pay him as promised, still consider your credit good? Your decision is your promise to pay, given to your soul. Your soul, having trusted or mistrusted you since birth, has an opinion as to your ability to keep your pledges to it, and these opinions are based upon your past performances.

If your financial credit was poor at the various merchants in your community, how would you go about it to make that credit good? Would you do it by starting to pay cash for every purchase? If you always paid cash no one would ever know whether or not your credit is good. People who always pay cash for purchases seldom can borrow much without furnishing collateral. It is the man who borrows money or owes bills, and who always pays when he promises to pay, who has the highest credit rating. The fact that, over a number of years, he has always met every obligation squarely induces a confidence that he will meet all obligations squarely in the future. And your soul knows whether you have kept your promises to it or not.

To establish the confidence of your own soul that you will do what you decide to do, what virtually you promised it you will do, it is essential that your soul should have frequent experiences in which both you make promises, and at the appointed time and in the appointed manner, honor them. Just as you would establish credit in the purchase of merchandise, you start in with very small promises. The essential thing is that you do not make decisions, or promises, and then break them. For every decision not carried out decreases the faith of your soul that you will fulfill your obligations to it. Therefore, it is essential that matters of formal decision, matters which your soul regards as a compact with it, should be very easily carried out at first, so that there may be no slip in the matter of fulfillment.

Every time you make a bargain with your soul and that bargain is carried out to the letter the soul gains faith in you, that is, in its own power to do what it sets out to do. But if you promise to do some big thing, something entirely beyond your power of accomplishment, the inevitable result is non-fulfillment and loss of faith, which means loss of willpower. Yet by beginning with small things, with promises to your soul that are easy of accomplishment, and gradually increasing the difficulties which you promise to overcome, being careful always not to take on something which you

are not willing and able to carry through to the finish, your credit with yourself may be increased. And in time, because you have thus formed the habit of paying your bills to yourself, your soul will have faith that you can do anything that you, after analyzing its feasibility, decide upon doing. You will then be in possession of an invincible will.

And that you may be energetic, as well as inflexible, the habit-system should be formed of concentrating energy in volume and intensity upon the thing which is to be accomplished. When you have promised your own soul you will do something, made a formal decision to do it, instead of permitting the matter to drift along and drag in accomplishment, pour enough energy and intensity into it to do it with proper expedition. Even though it requires energy drawn from other important things, if you have formally decided to do something, marshal sufficient energy toward its accomplishment that it can be put through in a reasonable amount of time. Do this with everything, small or great, if there has been a formal decision regarding it. Make it a part of your payment, a part of what your soul always may expect of you when you have made a promise.

A powerful and energetic will is an essential to great accomplishment, and it should be the endeavor of every neophyte to cultivate such will-power. And anyone can develop a powerful and energetic will who will persist in conditioning himself through the processes just outlined.

Procrastination Weakens and Defeats the Will

— Procrastination is a habit-system which may be developed from a number of different factors. It may be just the habit of not doing the thing that should be done because there is not energy enough, or because of inertia, or in other words laziness. But more often the habit-system is developed through deciding to do more things than can possibly be accomplished with the customary energy and time at the individual's command. It arises from lack of proper management of the time and energy factors available.

Therefore, the things that one desires to do should be analyzed to find out which are most important. And the decision should be made to do only those most important. With the will-power already strengthened through applying it to lesser matters, it should, after careful consideration of all factors, be decided also when the start will be made to do some important thing, and adequate time should be set aside in which to accomplish the important thing. Then, faithfully following the pattern of the decision thus made, the time that has thus been decided to use for the accomplishment of this particular thing should be so used until the job, whatever it is, is finished. This often requires setting aside some given period of each day in which to study, or work, or practice, until the desired end is reached.

Because there are so many things in life that seem to call for doing, some, of necessity must be neglected. But certainly you should not neglect the things which are really vital to you, merely that you may give attention to other things which are of little consequence. The first step, thus, in overcoming a habit-system of procrastination, is to form a habit of, at intervals, analyzing the things that seem to call for doing, with a view of finding out which are really the most important.

Then to start the new habit-system, select one of the most important things that needs doing, and for the time being neglect the other things. But be sure to do the one important thing at the time scheduled. Do not undertake too much at this initial attempt. Yet do it without fail..

After this select another important thing to be done—say, fifteen minutes, study of B. of L. lessons at a certain time each day—and do it on schedule. Permit nothing to block the performance of the job you have decided to do at the time decided on. You will find satisfaction in this, and the feeling of satisfaction experienced will aid you further in building the new habit-system. Do not, however, undertake to make too many changes in your life, or in your work, at one time. Make an easy start. Do the thing to be done at the time decided upon. Then step at a time add other important things.

Life should not be all work and no play. But if you will think about your friends you will, I am sure, agree with me that most people spend too much time and energy on trivial things, to the neglect of those things which are most important if they are to attain optimum living.

The Way to Form a Wanted Habit

—Although in lessons No. 155, 156, and 157, I have gone rather thoroughly into the details of how habits may be formed, just a few words on this vitally important subject will be said because every change in character which is contemplated in personal alchemy depends upon the elimination of certain habits and the adoption of new ones in their stead. In the first lesson of this course (No. 116) I outlined what I believe to be the three most important things every neophyte should know. And in this lesson I point out the three habits which I believe are most essential to any neophyte who sets his feet upon the pathway leading to adeptship.

The first of these is habitually to reflect upon your various thoughts, feelings and actions, day by day, with a view of determining whether or not they may be changed in some way that will increase your power to benefit society. That is, they are scanned to determine if you are living up to the perfect moral code, if you are Contributing Your Utmost, under the conditions and circumstances that obtain, toward the welfare and progress of society. And if not you should take such steps as are necessary thus to live up to that code. The second is the habit of feeling pleased and self-satisfied whenever such an analysis reveals that you have done your utmost,

even though the results are different from those expected and desired. It is the habit of experiencing a high degree of pleasure in every thought, act and feeling which is prompted by the effort to aid cosmic welfare. The third is the habit of exercising an energetic and inflexible will; for without will-power nothing worth while can be accomplished, either for yourself or for others.

You will perceive that we first considered things a neophyte should know. This is the proper sequence. For action should be based upon knowledge. First we should know what to do; and then we should do it. And these habit-systems here advocated first to be adopted are based upon knowledge. But they are more than knowledge, for they require definite and predetermined actions. And to be sure that these actions are not neglected or postponed unduly, they should be built into the personality as permanent habits.

We have on the shelves of our class-room in Los Angeles, something over 2,000 occult books of different titles. And there are individuals who have read the greater part of these books, yet who have made practically no advancement in the practice of occultism, nor received appreciable benefit from such reading. They can tell what almost any book teaches; but they have never made any of these teachings an integral part of their lives. For over a quarter of a century to my knowledge, they have been reading such books; but in that time there has been no change apparent in their characters. They possess a great mass of information, which can hardly be called knowledge because it has never been digested. But this information has merely meant entertainment to them. It has never influenced their conduct.

We must have knowledge, to be sure, and the more knowledge the better. But knowledge, valuable as it is, accomplishes nothing except when used in action. The mere studying of the 21 courses of occult science issued under the auspices of The Brotherhood of Light, or even the passing of examinations on all of them and becoming a Hermetician, results in no accomplishment unless this knowledge is put into practice. It is only when we build some great truth into our characters that the truth becomes of much benefit to us. The information supplied in these 21 courses is such that it can be, and should be, applied to the problems of life as they arise. And the way to be sure that the more vital attitudes and acts of life are not neglected in the hustle and bustle of competitive existence is firmly to establish them as habit-systems.

As the neophyte progresses, he will find there are many thoughts, feelings and actions, some of which will be mentioned later in this course which, to insure they are not neglected, should be made permanent habits. But it is a great mistake to undertake many such changes all at one time. You may be able, in a friendly contest, to throw any man in a village in a wrestling match. It is doubtful if you can throw any two men engaged at one time. And no matter if you are a champion wrestler, you cannot hope to throw all the men in a village if they are all engaged at once.

Any new habit adopted really means vanquishing some habit that has already been established, even if that habit is only the habit of inertia regarding the thing at hand. And you will do well to route the old habit by displacing it with the new one, if you take them on one at a time. But if you take on the whole crew of old habits at once you are vanquished even before you get well started.

Keep in mind that every new habit adopted routes some old habit, and that the one effective way to break some old habit is to adopt some other habit which, when entrenched, makes the old habit powerless to operate. The thinking about or paying attention to any old habit gives it additional energy and makes it that much harder to overcome.

When lapses occur, feelings of remorse, discouragement, sorrow, or other disagreeable emotions lend their energy to the very thing which is to be dispossessed. Therefore it is essential, no matter how much difficulty is caused by the lapse, that as little attention be paid to it as possible. It should be ignored, and the energies be mustered for, and the attention given to, the habit which it is desired should shoulder the old one out.

And right in line with this policy, be sure to give the new habit plenty of attention. When it is successful in manifesting in place of the old one be sure that you give as much play as possible to pleasant emotions. The new habit feeds upon attention, and upon pleasant feelings. Strengthen it through the pleasure technique.

By all means do not lightly decide to adopt a new habit. All that was said in regard to the development of will-power applies with full force here. Weigh the matter thoroughly to perceive if you really are prepared to undertake this particular struggle at this time. For the adoption of any new habit is always a struggle. It is a struggle between the old habit which resists displacement and the new one which shoulders in. One who issues a challenge to a formidable antagonist while quite unprepared for such a contest is commonly considered lacking in wit. And I am sure one who, without weighing the chance for victory, enters upon the struggle to adopt some new, even though highly beneficial habit, is lacking in wisdom.

The entering of a contest should be preceded by a careful weighing of the factors both for and against possible victory. Then, having decided there is a reasonable hope of success, a plan of campaign should be outlined. Strategy should be developed and the various assets collected for the struggle.

One of the most powerful weapons of the antagonist in such a contest is neglect and forgetfulness. If the fact slips from the mind that such a struggle is in progress, the old habit easily gains the victory. Therefore, some method should be devised which, whenever the conditions are such that the new habit should manifest, will surely draw the attention to this fact. And a carefully thought out campaign will then insure that sufficient energy, particularly pleasurable feelings and emotions, is associated with the new habit to carry it over the top to success.

As I have pointed out, the finer details of developing habit-systems are set forth in lessons Nos. 155, 156 and 157. Here I have merely attempted to show that the adoption of any new and desirable habit follows precisely the lines laid down for the successful culture of the will. For will-power is merely the habit of accomplishing what one sets out to do. And other habit-systems, a number of which the neophyte will adopt, one at a time, on the upward road to attainment, are merely thinking, feeling and acting customarily in a certain manner under certain circumstances. That is, they are the habitual accomplishment of definite thinking, feeling and acting which have been decided upon. They are thus, when decided upon, specific exercises of will-power, and as such come under the same general rule for cultivation as will-power itself.

And the sum total of such habit-systems, as they exist at a given time, is a clear index of how far the neophyte has then advanced; for they express his character as it is constituted at that time.

Chapter 3

Serial No. 218
Original Copyright 1949
Elbert Benjamine

Copyright
August 2002
Church of Light

Avenues To Illumination

Chapter 3

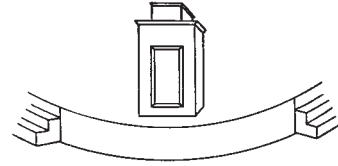

Avenues to Illumination

OCCULT and mystical literature of all ages abounds with references to a state of inner knowledge, often mentioned as a state of absolute knowledge, in which the soul seems to identify itself with the object on which the mind dwells, or with the information sought, and from this mystical blend an undeniable conviction floods the consciousness as to facts, conditions and relations. As actually experienced it varies in degree of intensity. But in true illumination there is a flooding of the consciousness with new information which the individual, without analyzing it or reasoning about it, is unalterably convinced is the truth.

Long ago I was struck by two things relative to the literature about this interior knowledge. I was struck by the almost unbelievable number of books that have been written about it, and equally struck by the poverty of concrete information contained in the whole of them. This is not said in criticism of the authors of these books; Christian mystics, writers on ancient alchemy, yogis and modern orientalists. The vast literature they have issued has been prompted by personal experience with a certain form of knowledge. And they have felt that such experiences were so vital in their lives, and if experienced by others might be so helpful that, often at great sacrifice to themselves, they have written-down, and tried to explain the reason of their experiences in the hope that others might through following their admonitions have and benefit by similar experiences.

Not only the mystical books of medieval times, and those early in the present century, have presented an account of this interior knowledge, but the latest and apparently most popular books among mystical students, as this is being written, are devoted to accounts of such higher states of consciousness and how they may be attained. And as is usual, while certain practices are advocated, and exaggerated claims are made as to the infallibility of the knowledge apprehended in this absolute identification with the essence of knowledge, these books are mostly words without much which is concrete and tangible for the student to grasp.

Nor should this be a source of wonder. All knowledge not gained through the physical senses or reason is now classified as extrasensory perception. And no one, thus far, has been able to employ extrasensory perception at will on all occasions when he desired to use it. It occurs spontaneously rather frequently. And there are methods of training which enable the individual to bring it into effective use much

more frequently than had he not undergone such training. The Church of Light ESP Research Department since it was established in 1937 (chart in lesson No. 18), has learned considerable about how it operates, and is vigorously trying to find a way by which people can use it effectively on all desired occasions. But it is still quite elusive.

Extrasensory perception, as set forth in lesson No. 18, operates in three distinct ways. One is through mediumship, in which there is partial or complete control of the medium by some intelligence other than his own. The Church of Light does not advocate that anyone shall become a medium. One is through feeling ESP in which there is hypersensitivity of the nervous system which enables the individual to tune in on the astral counterpart of the object, person or thought about which information is desired. The nervous system, or some part of it, becomes a receiving set through which the electrical energies and astral energies associated with it pick up, radio fashion, the astral vibrations radiated by whatever is tuned in on. The individual then feels the condition of that which is contacted.

While the use of feeling extrasensory perception has its dangers and should be approached with caution, it has frequently been used by mystics in various lands. There is no objective reasoning or thought about the thing. In fact, if reason intrudes its processes it effectively prevents the interior knowledge from being experienced. The recognition of any particular process is a distraction and hindrance to it; for it is a feeling. The individual FEELS that he has identified himself with the knowledge. He feels it within himself. When one's body comes in contact with a rough surface, one is not conscious of reasoning about it. One feels that the surface is rough. And in a similar way one feels, without reason, but with absolute conviction, that one has contacted a certain truth or fact.

Through this process of interior feeling the mystics of various lands and ages have claimed to contact God. Meditation, prayer, fasting, and discipline were the means employed by many to aid them to develop this interior feeling. The yogis advocate postures, meditation, concentration on the nerve centers, rhythmic breathing, saying mantras and an ascetic life in the effort to evoke the same union with God. And in this effort, both West and East, on occasions the consciousness is flooded, as by a light, with the conviction of some truth.

The third way in which extrasensory perception operates is through extension of consciousness. On the inner plane distance, time and gravitation are of a very different order than they are on the outer plane. The unconscious mind, or soul, is not limited in the same way the physical body is limited. It can acquire knowledge in the way such things are accomplished on the inner plane about anything it contacts. Examine is not the right word for this process, for what really happens is that as soon as the soul contacts anything on the inner plane it knows all about it. By identifying itself with the object or condition, as mystics of old phrased it, all significant facts about it are immediately recognized.

I could here relate a dozen different explanations given for their extrasensory experiences by as many different sects, mystic orders, yogi teachers, and advocates of certain religions. Some say that they have communicated directly with God. Some claim that the voice of the soul has spoken. Others that truth in the abstract has been contacted. But in reality all have employed one or more of the three mentioned methods of extrasensory perception, and except in degree all illumination is the same in that there is the flooding of consciousness with the conviction that something is irrefutably true.

Truth

—Yet truth is not an object floating about in space waiting to be grasped. Truth is merely some phase of the cosmos which in the past, present or future performs in a given way. Truth is a relation between some mind and something in nature. If the mind conceives some section of nature correctly, we say that is truth. If the mind conceives some section of nature incorrectly, that is error. Truth is a correct mental relation to some energy, law, or condition. It is the conformity of cognition to reality. It is, therefore, impossible to tune in on truth in the abstract; for truth is a correct perception of the relations existing between certain factors in nature. It is a relation also between the mind and these factors in nature. But it is entirely possible to tune in on these factors in nature. And if this tuning in reveals correct information to the mind, that is truth.

When through any mystical or occult process an individual becomes convinced he has tuned in on truth, or has identified himself with it, as the condition usually is expressed, what he has done is to tune in on some relation existing in nature in such a way that he correctly perceives the relevant facts about it. Because, interiorly, he has thus grasped the knowledge he is apt to feel he has grasped truth. And as a matter of fact, because he does correctly realize certain relations that exist, he has a right to feel that, in so much, he possesses the truth. The only truth, however, which he can possess, is a correct conception of something, or some relation, in nature.

I think it is important to know this, because there are so many nonsensical ideas afloat about the matter. And if the neophyte fails to realize it, and persists in his effort to tune in on abstractions and misconceptions, he may become negative through the confusion set up by such fruitless endeavor. A clearly defined conception about something has a positive force to repel unwanted invasion. But a confused medley of notions, or a train of fleeting abstractions that have no definite significance, leaves the mind in a condition where it is unusually susceptible to having pernicious misconceptions injected into it by those of one plane or the other who hope to profit in some way by broadcasting such errors.

Tuning In

—When we analyze the matter we perceive that all physical objects are merely energies which have been organized in definite relations. And it is recognized that thought is energy. Thus a given thought, or conception, is also energies which have been organized in definite relations. Thoughts, simple and complex, and objects on the inner plane, are energies which have been given definite organizations. But these energies are of the high-velocity which gives them inner-plane characteristics.

One of the outstanding inner-plane characteristics is that distance is measured not in terms of three-dimensional space, but in difference of vibratory frequency. Things quite different in vibratory frequency are far apart. Things of similar vibratory frequency are close together. And things having the same vibratory frequency are in actual contact with each other. This applies not only to inner-plane objects, but also to thoughts and factors of the unconscious mind.

On the physical plane one does not have to contact all of a house to be in contact with the house. One may lean against a door and be in contact with the house, although the amount of information gained from such a position may not be as great as if one walked into different rooms and thus contacted the house in various areas. And one may contact a person, or an object or a thought on the inner plane through a vibratory rate that is identical with some part of the person, or object or thought. But if the vibratory synchronization is more completely that of the person, object or thought, the contact will be more complete and it will be easier to learn more about the person, object or thought.

While there are other senses, such as those of taste, smell and hearing with which it is possible to learn something about physical objects, the two senses most used in such investigations are sight and feeling. Of course, sight, as are all the other physical senses, is also a type of feeling, but it does not require that the object examined must give a physical impact to the person examining it. To examine an object by the sense of sight a particular kind of contact must be made with it, a contact effected by light. But to examine an object by the sense of feeling, physical contact must be established.

There are also two common ways of learning about a person, an object or a thought on the inner plane. In either one contact must first be established through a vibratory rate similar to that, or similar to some section, of the person, object or thought to be examined. But in making the examination by Feeling ESP the nervous system is tuned to the vibratory rate of that which is examined, and picks up the inner-plane vibrations of that which is tuned in on. The individual thus FEELS that which he contacts, and often feels its vibrations so completely that he identifies himself with it temporarily.

By the other method he merely focuses his unconscious mind on the person, object or thought to be contacted until the observing section of his unconscious mind tunes in on the proper vibration to enable it to make contact. To contact the person, object or thought, the unconscious mind, or some section of it, must synchronize its vibrations to that which is to be examined. But when the contact is made it does not examine through feeling. Instead it examines it through a process analogous to sight. Not that it employs rays of light to gain the information, for velocities on the inner plane are greater than that of the light with which we are familiar on the outer plane. But the mind can examine and as thoroughly identify itself temporarily with that which is thus contacted as if feeling were used, and because free from strong feeling it often can gain more information, even as by looking at an object on the physical plane we often can learn more about it than merely by feeling it.

In this Intellectual ESP the individual gains information about a person, object or thought by contacting it mentally on the inner plane. He extends—adjusts the vibratory rate of—his consciousness to that about which information is sought. But he has no more feeling relative to that which is contacted, nor is his nervous system more influenced by it, than it is when by the sense of sight he examines something on the physical plane. or reads about it in a book.

Objects and thoughts can easily be distinguished from each other on the inner plane. But their difference is far less than on the physical plane. People and other entities having intelligence, objects and thought-forms, on the inner plane are not as unrelated to each other as they appear to be on the physical plane. Instead, they are related to each other very much as are the various factors in an individual's mind. In our mind the thoughts we have had persist and enter into combination with other thoughts with which they have been associated. Some of these thoughts that have been organized into the unconscious mind seem to have almost no relation with other thoughts there residing. And it may be almost impossible to bring them again into objective consciousness. But by proper application of the LAW OF ASSOCIATION they can once more be brought into objective consciousness.

One of the most powerful associations by Resemblance is that of identical or similar resonance. Thus as already pointed out, thoughts and things having the same vibrations are together on the inner plane, and when the mind has the same vibration as a thought or thing, it is in contact with that thought or thing. Furthermore, if it is free from other matters which distract its attention, it is then in a condition where it can gain knowledge about that which is thus contacted through Intellectual ESP.

This means that any intelligence or any object, past, present or future, or any conception that has ever been thought in the past or will even be thought in the future, and thus any possible information, can be contacted through Intellectual ESP if the mind can sufficiently synchronize its vibrations with it to make the contact.

In thus using extrasensory perception, whether of the feeling or the intellectual type, there are three difficulties to be overcome. The first is that of making contact with the desired target. There are so many more intelligences and objects on the inner plane that can be contacted, because distance is no barrier, and in addition there are thoughts also. Furthermore, any of these may be contacted not only in the present, but also at any date in past or future. Therefore, unless that about which information is desired has points of familiarity, it may be difficult to tune in on it. In endeavoring to do so one may tune in on something else.

Only occasionally does the soul, or unconscious mind, employ the arbitrary language with which the individual customarily does his objective thinking. It usually uses a different type of symbolism, based on ASSOCIATION, to convey the information it has acquired to objective consciousness. Furthermore, often there are factors within the unconscious mind with much power gained from emotional experiences, that block the delivery of the information gained by the soul to objective consciousness, or warp it from its true significance.

The third difficulty to be overcome is that of giving the correct interpretation by cerebral processes of the image or account of what was perceived. Not only must symbolism often be interpreted, and due allowance made for the cunning way in which strongly energized factors within the unconscious exercise censorship over certain facts, or permit them to reach objective consciousness only through subterfuge in which they adopt some symbolical disguise, but unless the brain has sufficient training to grasp the import of the information its true significance is lost. Genius must be able not only to tune in on the information sought, but must be able also to understand it when it comes filtering through into objective consciousness.

Exhaustive experiments made by Whatley Carington, the Cambridge psychologist, brought out two important points which the experiments of others tend to confirm. His experiments were chiefly conducted with drawings. And he found that it made no great difference to the ability of the distant percipient whether the drawing was actually drawn or not provided it was clearly impressed on the mind of some person who was connected with the experiment. The point thus brought out is that it seems equally easy to see an object clairvoyantly or to see the thought of the object telepathically.

The experimenters at Duke University had conclusively proved clairvoyance, post-cognitive clairvoyance and precognitive clairvoyance. Post-cognitive clairvoyance is when something in the past is perceived by clairvoyance. Precognitive clairvoyance is when something that has not yet happened, but will happen in the future, is perceived by clairvoyance.

And Whatley Carington demonstrated that it seems as easy to use post-cognitive telepathy and precognitive telepathy, as to use post-cognitive clairvoyance or precognitive clairvoyance. This means that through extrasensory perception not only the conceptions now being thought can be perceived telepathically, but that which was thought in the past, and that which has not yet been thought, but will be thought in the future, also can be perceived telepathically.

Thus so far as now known there is no possible information that is beyond the reach of extrasensory perception, provided it, and the brain using it, have sufficient ability.

As on the outer plane, information may be obtained on the inner plane in three different ways. On the outer plane we may investigate the relation in nature for ourselves. And on the inner plane we also may contact the relation in nature and learn that which we are seeking to know. On the outer plane we may witness moving picture portrayal, see the matter explained by television, or by pictures and the printed page. We thus get the information from the record left by some person or persons. And we may also on the inner plane contact telepathically the record left by the thoughts of people about the information sought, or we may contact the thoughts in some person's mind.

The third way of getting information on the outer plane is through listening to some person explain it over the radio, in a lecture hall, or through less formal conversation in which the seeker asks questions which are answered by the person having the information. On the inner plane it is also possible for one still in the flesh to listen to lectures and to carry on conversation by asking questions of an inner-plane person and receiving his answers, and bringing those answers up into the region of objective consciousness. Such spiritual communion, however, should not be confused with mediumship; for in it neither intelligence controls the other. There is the same freedom in exchange of ideas, and freedom of domination of one by the other, as there is between two students of the same subject, one perhaps being more advanced than the other, who discuss with each other some matter of scientific interest.

Either on the outer plane or the inner plane, those of similar interests are attracted to each other. Even more so on the inner plane because the similarity of vibration of their mental interests automatically brings their minds into contact. And those more experienced on either plane usually find pleasure in imparting information about their common interest to others who also are deeply interested in the same subject.

But to contact information on the inner plane it is not necessary to seek some person possessing that information. Which of the three methods the unconscious mind employs to acquire the desired information is not important. The important thing is that it get correct information about the matter in which there is interest. And commonly it is better to permit the soul, or unconscious mind, to select the one of the three methods without giving it commands or otherwise interfering with its choice.

The first essential in thus acquiring information from the inner plane is that there shall be an intense interest in it, and a strong desire to get it. This desire must be not merely of objective consciousness. It must in some manner be imparted to the soul. And the soul must have sufficient energy at its command to get it.

The energy which the brain uses in acquiring information is electrical in nature, and while the soul is attached to a physical body the energy by which it is directed, and which it must transform into astral energy to do extrasensory or psychokinetic work, is electrical in nature. As explained in lesson No. 153 this electrical energy is liberated by the oxidation of the nitrogen fraction of the bodily cells, and furnishes electromagnetic wavelengths which vary with the purpose for which they are used. Rhythmic breathing increases the electrical energy generated by the nervous system, which is the most potent source of such energy, and the type of feeling engendered by the thoughts determines whether the electromagnetic wavelengths which result are of the type which are used in brain work (Mercury), in giving vitality (Sun) to the body, in mediumship (Moon), in affectional (Venus) matters, in inspiration (Uranus), in feeling extrasensory perception (Neptune), or for inner-plane (Pluto) work.

Consciousness does not successfully focus on both planes at once. When there is considerable cerebral activity, the electrical energies there active keep the attention of the soul largely occupied, and it does very little on the inner plane. But when the consciousness largely withdraws from cerebral activity and the attention is not held to such activities or to something in the outer world, the soul may get information from, or do work on, the inner plane.

However, just because there is almost no cerebral activity and no attention given any external thing no more signifies that the soul is trying to get inner-plane information than it signifies that the individual so mentally inactive is trying to get information from the outer world. People often wish they had some information that can be acquired in the outer world, but do nothing about it. And they may equally wish to get some information from the inner plane and do nothing about it. To get information from either plane, unless it happens to arrive spontaneously, as it occasionally does, the mind must work to get it. Because of lack of conditioning, lack of having used the mind on the inner plane, it is usually more difficult to get it there active than it is to get it to use the brain, which has had schooling for many years. to work for outer-plane information.

But if there is an intense desire for some information, and the consciousness is withdrawn from the external world largely to the inner world, which means that cerebral thinking must practically cease but that inner attention must be active, this may bring the soul in contact with the information. The concentration of the inner attention on the information sought tends to give the soul the vibration of the information sought and tune it in on it. But if it contacts the right target, instead of something else, the inner attention must not wander.

Not only must the soul have sufficient energy to contact the information sought on the inner plane, but if this information is to be brought into objective consciousness, it must have energy enough to compete with any other energies which tend to come into objective consciousness from the outer world, from the unconscious mind, or from the inner plane. To give it the required energy, rhythmic breathing may be used.

Ordinary cerebral thinking competes in utilizing the electrical energies necessary to impress objective consciousness, with the information which, through extension of consciousness, the soul has thus acquired. Therefore, either to extend the consciousness to the information sought or to bring it through, cerebral thinking must cease, or be brought to a minimum. Furthermore, the information imparted to objective consciousness by the soul, or unconscious mind, seldom comes through in words and sentences. Form, color, feeling, emotion and concepts are more readily conveyed from inner consciousness to outer consciousness. Thus, more often than not, either the idea flashes into consciousness, or it is presented to consciousness as a symbol. Furthermore, unless it is merely the answer to a question that may be answered briefly, the information usually comes through piecemeal, one fragment after another. Often one significant factor of an idea comes into the consciousness, then another, and so on until the whole is made clear. It is difficult for the soul to mobilize sufficient electrical energy to compete with other thoughts and bring up into objective consciousness too much at one time.

In tuning in on information, the soul must raise or lower its vibration to the inner-plane level where the information is to be found. The information most seek is on a basic vibratory level not difficult for them to tune in on. But exalted spiritual ideas may be on a level far above that which an individual can tune in on. He may be quite unable to raise his vibrations high enough.

Basic inner-plane levels are comparable to carrier waves in radio. To pick up a radio program you have to tune in on the proper carrier wave; so many kilocycles. But once tuned in on the inner-plane basic level where the information may be found, to contact the information sought is to adjust the consciousness, by thinking about the matter, much as to carry a program the carrier waves in radio are modulated.

Meditation

—Without being aware of how it gets its ideas, all genius taps inner-plane information. The genius enthusiastically wants to know how to do something or wants some information. His mind is on the matter during his waking moments, and his soul impelled by strong desire extends his consciousness during sleep to get it. In his insistent pondering on the matter the soul, which during sleep, or while he is meditating on the matter while awake with his attention withdrawn from the external world, has acquired the information. Then at moments when his cerebral activity is not interfering too much, it projects up into his consciousness some idea of value. He ponders on this, or tries to put it into practice. And then his soul finds opportunity to inject another idea of value into objective consciousness.

Sometimes a whole complex idea will strive for days to move from the unconscious into objective consciousness, and at last, finding an opportune time when it can mobilize enough electrical energy to overcome competition for objective attention, it is able to make the whole matter clear to the objective mind. The whole thing comes through in a flash of illumination.

Proper meditation is one of the best ways to get illumination. There must be an intense interest in something. The interest must be more than merely intellectual; it must be energized with enough desire to impress the soul, or unconscious mind, also with an eagerness to get the desired information, or to make the desired inner-plane contact.

In proper meditation the body is as completely relaxed as possible. Sitting in an easy chair, or lying down, assists thus to relax nerve and muscle tension. That which there is an intense desire to know is clearly formulated in the mind. The objective consciousness thinks about the subject. Then it narrows its attention so that unrelated thoughts are not present in the consciousness. As usually stated, there is concentration on the matter. Concentration is the bringing the mind to a focus and keeping it intently occupied with a given subject to the exclusion of unrelated subjects. Thus the subject meditated about is the center of attention. And in the outer-plane type of meditation, from this center the mind radiates out, gathering as many valuable thoughts about the subject as it can. Meditation does not require that any sentence shall be repeated over and over again. It requires merely that the thing be given concentrated thought, the deeper the better.

But for the type of meditation that brings illumination, after the subject has thus been given concentrated thought, and unrelated ideas excluded, the consciousness is shoved down and away from the brain. A good place to move it is behind the heart, and then out onto the inner plane. If the consciousness is concentrated in the brain area it is very difficult to inhibit cerebral thinking; for electrical energies tend to move to any spot in the body on which attention is centered. Thus by withdrawing the consciousness from the brain to a region back of the heart, and then moving it out on the inner plane, there is aid in withdrawing electrical energies from the brain which stimulate objective thinking.

Just sufficient consciousness should be left in the brain to be able at all times to keep aware of impressions that come into it from the activities of the soul. The individual should not go to sleep. He should inwardly keep intensely aware, and hold his inward attention on that which the meditation is about. So absorbed should he become in the inward recognition of facts about the subject of meditation, that external visual and auditory impressions are unnoticed. His reverie should be so deep that he is oblivious of the outside world. Memory images also should be shut out. And the inner alertness should be so intense that dream images do not intrude, as they often do in the close approach to sleep. These can be recognized by the way they combine to form a coherent dream-like picture. They are image associations of the unconscious on the

fantasy level. This is a level influenced by thoughts which have impressed the electromagnetic boundary-line region, or by suggestions from the outer-plane. And to get correct information the consciousness must get clear of both these regions. It must tune in on the astral realm, or if the information desired is still beyond that, on the still higher velocity spiritual realm.

While not going to sleep, and by rhythmic breathing supplying energy with which to keep awake and at the same time withdraw his consciousness almost completely from both the outer-plane and the electromagnetic boundary-line region, he should extend his consciousness tune in on—that about which information is desired.

In this state, at least occasionally, it is likely his objective consciousness will be flooded as if by a light which is coincident with undeniable knowledge which comes from identifying himself with the object on which his mind dwells. At other times information about it will flash into his objective consciousness piece at a time without the light or the enthusiasm that accompanies the more complete illumination. But even when the light and feeling of exaltation are absent, if the information that comes through is correct, it is the same process, but operating in a less degree of intensity and completeness.

Whatever the manner in which during meditation, or projection of consciousness on the inner plane, the information comes through, only enough awareness should be maintained to get it registered on objective consciousness. There should be no reasoning about it. It should as it comes through merely be observed. If any type of objective thinking about it starts, the cerebral activity thus inaugurated makes of the brain not a receiving set, but a broadcasting set. And the energies of such broadcasting usually have enough potential that they take over the activities of the brain and prevent the soul from being able to use electrical energies in competition with them strong enough to register the information it is trying to convey.

But immediately after the illumination, or the fragmentary knowledge has registered, and it seems that the period of illumination is at an end, a record should be made of any impressions or conceptions that have thus been received. With the brain in the required state of cerebral inhibition, the memory of what has been received departs quickly, even as the memory of most dreams is fleeting.

Then after the period of proper meditation is over, and its impressions and ideas recorded, they should be thought about intensely by objective consciousness in the effort to perceive their true significance.

Inspiration

—There are those who contact and bring through information from the inner plane quite apart from any deliberate attempt to do so. They are intensely interested in some subject. And they think about it objectively. The intense interest in the matter stimulates their soul to make inner-plane contact with significant information. Perhaps while taking a walk and thinking about the matter, or sitting at a typewriter

writing about it, the objective consciousness automatically at short intervals sinks into a sort of reverie in which the positive cerebral activity ceases long enough for one flash after another of information which the soul has gained to be projected by it up into the region of objective consciousness. The wave-lengths of electromagnetism which are of the Uranus type are conducive to getting information through this method. When it comes through, as it often does, in this manner, it is called inspiration.

Subjects for Meditation

—Although this is mentioned elsewhere, it should be pointed out that the best way to get a thorough knowledge of a subject is to teach it. In teaching a subject one must be able to explain it to others so that they understand it. And only when one can do this—as often one cannot do who thinks he knows a subject—does he have a thorough knowledge of it.

Every one of the 210 Brotherhood of Light lessons contains material that can to advantage be expanded through meditation. The rule is that those who go through them the second time get more than the first time over, even though they pass the examinations. And that the third time over they get still more than the first and second time. But in addition to the explanations given in each lesson, if the individual meditates on the subject matter it will lead his mind to other significant information of value. Thus each Brotherhood of Light lesson provides a subject for meditation. And if one is teaching it, such ideas are valuable aids in keeping a class interested.

Each of the 22 Major Arcana of the tarot also provides a fertile subject for meditation. What has been said about it in the Brotherhood of Light lessons has necessarily been condensed to the utmost. And by meditation new information can be ascertained about the principle represented symbolically by each. As the tarot is a synthesis of all knowledge, the extent to which this acquiring additional information through meditating upon its symbolism can be carried is limited only by the capacity of the individual's mind to understand that which it thus contacts on the inner plane.

However, there is probably no better subjects for meditation, because they are a collection of spiritual truths of paramount import, than the Spiritual Texts of Astrology. These Spiritual Texts are not just random statements, nor are they just casually observed facts, such as are most of the subjects for meditation given in current periodicals. Instead, they embrace the wisdom of the ages in regard to the proper conduct for a soul. They are a summary of what the wise ones since the earth began have found of most importance to the individual who desired to live a spiritual life. And because they are thus boiled down, they afford the greatest facilities for meditation; for in meditation of this type a single thought or idea is selected and then, in the deep inner-plane concentration of the mind, all its meanings, bearings, and lines of relation are traced to the fullest possible extent.

These Spiritual Texts are the ideas which generation after generation of specialists in spiritual research found were the most important things the neophyte should know. The spiritual giants of the past who discovered these facts, and selected these particular ones as the most important, placed them as universal symbols in the sky. These texts and the universal symbolism by which they are portrayed in the sky, not only are the best known subjects for meditation, but each should be expanded into a sermon and delivered to an audience whenever this is possible.

Affirmations and Mantrams

—When a mantram, or any other affirmation is successfully used, the idea in time becomes firmly grasped by the unconscious mind as a part of reality. The soul accepts the idea as fact, and gradually the internal life, and finally the external life, become governed on the basis of this idea being a fact. As stated in lesson No. 216, in the course of time the idea will be assimilated and evolve into the outward form and constitute the dominant idea of Truth, which will result in Spiritual Power.

But if the affirmation is not a truth, but is an error, it nevertheless will produce a mental and spiritual state into which the idea will involve. It will become a part of the internal nature. But being an error, it will result in actions based upon this error.

It is quite true that simultaneous concentrated thinking by people scattered over a wide area lends force to the thought-form thus launched upon the sensitive fields of the astral. Therefore, if the thought is about something that really should occur, such as World Peace, or World Prosperity, such united thinking has an influence to bring about better conditions. And, where no doubt can be entertained as to the advisability of the thing thus formulated by many minds, such simultaneous thinking of a given thought has its merits.

But there is also another angle which the student should always take into consideration. I have gone more thoroughly into the principle of the matter in lesson No. 187, but nevertheless here it should be pointed out that when, at a set time of day you make the same affirmation, or meditate on the same sentence such as those published for the purpose in some periodicals—you are tuning in on the same thought-frequency that many others are tuned in on. The effect, in principle, is not dissimilar to that obtained in a “developing circle,, in which those present at a seance join hands and sing a hymn. A thought current is set up which tends to circulate from one participating individual to another.

No particular harm is accomplished by this. But actual observation of results leads me to believe that many of those who thus participate in group affirmation or group meditation, tend to become somewhat negative at times during the period. And if one becomes negative while tuned in on the same vibratory rate that hundreds of other minds are tuned in on, it is very easy to pick up other thoughts and tendencies which are also radiated by other minds. That is, some of them, at the time they are making

the affirmation, or during the meditation, may permit their minds to wander from the subject and to think strongly and positively of other, and less desirable things. And such undesirable thoughts may then be carried along by the strong thought current set up by the united thoughts of all participants, and seep into the minds of such as are not too positive to receive them.

The thought-stream becomes like a stream of water fed by many brooks. It carries some clear water and some muddy water, and also whatever filth is poured into it by any dirty rivulet that has access to it. And because all participants are tuned in on this major stream, thus fed by minor creeks, the stream carries whatever it contains to all minds entering into the effort. And unless a mind is radiating too strongly to absorb thoughts thus reaching it, there are opportunities present for pernicious thoughts to enter the mind and defile it, that would never find harbor there except through some such artificial contamination.

In addition to this, on the principle followed in the seance room, such united tuning in on a common thought-vibration affords opportunity for entities to dominate the thinking of the entire group. A strong mind, either on the outer plane or on the inner plane, who is aware of the time and thought set for such affirmation or meditation, can take this time to launch some thought of his own, in association with the thought set for affirmation or meditation in such a way that it will ride the thought current and become the dominant influence in it. That is, a powerful thinker can launch some thought, along with the one chosen by others as the subject of affirmation or meditation, and the thought thus launched, being stronger than other individual thoughts, will draw to itself the combined thought-energy of the whole. Thus the whole force of the united thinking, at times becomes utilized, not to carry forward the idea thought about, but to give force to some other thought in the endeavor to dominate the whole group by the new thought, or even to compel society at large to accept it, regardless of its merits.

Again I must repeat that any power or principle that can be used for good can also be used for evil, and the higher potency it has for good when rightly used the more power it has for evil when used destructively. We need experience no surprise, then, that this principle is present in the use of affirmations and subjects of meditation.

An affirmation properly used, as explained in lesson No. 63, is one of the most potent agents in the development of spiritual power, and the neophyte is urged to learn how to apply them, and to use some affirmation daily. For general use The Church of Light mantram given in lesson No. 216, has been found to be the best of all. Next in practical results obtained has been the use of the Tarot mantram, given in lesson No. 23. But in addition to these two tried and proven mantrams, it seems preferable for the aspirant for adeptship who does not care to become the victim of mass psychology, to select for himself and use only affirmations particularly suited to his own need, rather than join at set times in repeating statements in unison with others.

Chapter 4

Serial No. 219
Original Copyright 1949
Elbert Benjamine

Copyright
August 2002
Church of Light

Spiritual Hindrance By Family And Friends

Chapter 4

Spiritual Hindrance By Family And Friends

MUCH observation indicates there is a principle, operating largely through psychokinesis, that strongly resists the effort of the individual to step from the path to which his feet have long been accustomed. Almost as soon as the neophyte resolves to do some particular thing, or not to do something which to him is customary, he finds this resolution challenged in no uncertain terms. And this challenge, if what he contemplates is something different than his associates do, not infrequently comes from friends or members of his own family.

Nothing is to be gained by insisting that any marked effort to lead a spiritual life is nearly always met by severe opposition. Nor is any good end served by citing examples, which are multitudinous in number, that have come to notice where a neophyte has decided to take some step on the path toward adeptship sometimes an important step, and sometimes an insignificant one—only to find his plan thwarted by fierce and unexpected opposition. But a discussion of how to handle such situations has value, because they are of such frequent occurrence.

It is an instinct older than the human race for the herd to demand that all its members shall live as the majority of the herd do. We witness the same rigid curtailment of liberty of individual initiative among gregarious birds and mammals. It is the conservative element which ever exerts its influence as a brake upon progress. The person who dresses differently, who eats differently, who lives in any manner differently than his fellows, is marked for disapproval.

Likewise, the invisible intellectual forces which surround our planet are chiefly conservative. We witness on earth various political systems in which some advocate progress but others with a more numerous following are determined that government and its agencies shall be run in the future just as they have been run in the past. Things have been organized in our industrial life, in our economic life, in our political life and in our religious life here on earth; and those who are willing to struggle and fight to maintain the conditions that have existed in the past most of the time are more numerous than those who are willing to permit some beneficial change. And the inner-plane realm about our planet, the immediate astral environment, is just as completely filled with reactionary intelligences as the surface of the earth itself.

How Opposition Develops

—Consequently, when the neophyte decides to break away from his old and established methods of living, no matter how unsatisfactory they have been, he is apt to stir up these reactionary forces both on earth and immediately adjacent to the earth. I am not talking about black magic, or things of that nature; for such are of rare occurrence. Instead, I am referring to backward intelligences who feel that what was good enough for them while on earth is good enough for anyone. What they did and what they knew is the measure of their opinion of what those now on earth should think and do.

On the high-velocity inner plane where the mind at all times dwells one intelligence is not separated from another intelligence by three-dimensional distance. Nor does one intelligence have to express its thoughts verbally or in writing to make them known to another. The method of communicating thoughts on the inner plane is through the extrasensory faculty of telepathy.

Inner-plane intelligences—and the mind of man on earth is an inner-plane intelligence attached to and manifesting through a physical body by means of psychokinesis—are related to each other as the thought-cells of an individual's finer form are related to each other. They are related to each other through the psychological Law of Association, which is explained in lesson No. 57. This means that intelligences having similar thoughts or similar desires through the energy of these thoughts or desires tune in on each other. They are thus, through synchronization of vibratory rates, as close to each other in so far as ability to communicate is concerned as are two people on the physical plane occupying the same room.

Two people in the same room on the physical plane may, or may not, communicate their thoughts to each other, and they may, or may not, try to influence each other's point of view. But they have facilities for doing both. And those on the physical plane and those on the inner plane who have had similar thoughts and held similar views, through these points of Mental Association, have facilities for communicating thoughts to one another and for influencing each other's views.

I am not here assuming that any great number of those who set their feet upon the exalted path will meet with serious opposition from unseen intelligences which they have previously contacted who wish to prevent them from thinking and doing differently than they did in the past. Yet the neophyte should be aware of the source of such opposition should it appear. Minds influence other minds far more importantly and far more often than is generally recognized. And such influence does not necessarily confine itself merely to presenting arguments in favor of some view.

Psychokinesis may be brought into play as a coercive force the impact of which may be considerable. And while he need not contact them, the neophyte should understand that on the inner plane there are gangsters and racketeers and selfish and crafty individuals who, even as such on earth, are opposed to all progress either by the individual or by the community.

In addition to unseen intelligences, and the influence of family and friends, there is a third hindrance always present to proper progress. It is the thoughts built into the thought-cells of the unconscious mind. The thought-cells have become conditioned to do certain things and not to do other things. Often they are energized by strong emotions, and thus are able strongly to resist any innovations. Old habits of thought, old habits of feeling, and old habits of action vigorously resist being displaced by new and better ones.

Furthermore, thought-cells which have been highly vitalized with emotion, or by receiving energy of a progressed aspect, are able to use psychokinetic power to bring into the life the things they desire, which may be conditions and events which tend to thwart the change the neophyte has decided upon.

A resolution to change something about our personal life has to meet and overcome, or reconcile, other factors within the unconscious mind. It is a thought about some situation or condition. And as the mind is centered on this situation or condition the psychokinetic energy of the thought-cells is directed toward the particular situation or condition thus thought about. And the stronger the feeling about the situation or condition the more psychokinetic energy is generated to attract it, and therefore the surer and quicker is the situation or condition attracted.

But whether it is due to inner-plane entities, due to the influence of family or friends, or to the psychokinetic power of factors within the unconscious mind, whenever he resolves to change something about his life in some rather marked manner, some opposition is almost sure to develop, and usually it will develop at once. Whenever he makes a decision to take any upward step, that decision sets forces in motion that bring to him a situation which tests the genuineness and power of his decision.

The severity of the obstacles imposed to the fulfillment of the new manner of doing something which has been decided upon depends upon the harmony or discord which has been built into the finer form by the thoughts and experiences with the circumstance, and the energy of the old habit-system to be replaced. But I am sure the neophyte will not have long to wait, if he will be observant, to be convinced that the resolution to live in a manner differently, or to do something in a markedly different manner when the situation again arises, quickly attracts into the life the opportunity, if not the necessity of either carrying out what he had decided or failing to do so. The thought about the matter attracts the situation, and thus soon is the strength of the resolution tested.

Carrying Out a Resolution

—Because a resolve to take a definite upward step is so soon brought to test, and because failing to live up to the resolve is so weakening to the will, it behooves the neophyte always to weigh all possibilities before deciding upon such a change, and having once decided, to stick resolutely to it.

Invisible opposition has already been rather thoroughly treated in Course 18, and the opposition of the unconscious mind can be handled by the proper formation of new habit-systems as detailed in lessons No. 155, No. 156 and No. 157. But just how to handle friends who have one's welfare at heart, and in particular just what one's attitude should be in this respect toward the immediate members of one's family, are often problems of great intricacy which tax the powers of discrimination to the utmost.

As a broad and general proposition it may be stated that no other person has the right to interfere with one's spiritual progress. The Constitution of the United States recognizes this broad principle in granting religious liberty to the people of this country. This country was settled extensively by people seeking freedom to worship according to the dictates of their conscience. Religious tolerance has remained a cardinal principle, cherished by the American people, and upheld by law.

On the other hand, in religious fanaticism we cannot completely disregard the material obligations which we owe to those who, perhaps, have made great sacrifices for us. A husband or wife has some obligation to the matrimonial partner, children owe some deference to their elders, and the sensibilities of close friends are not to be wounded with impunity. We cannot be callous to the desires and feelings of those close to us without exhibiting selfishness.

Of course the true solution of this all too frequent home problem is to invoke the perfect moral code. Of all the ways of handling the difficulty, which will, in the long run, CONTRIBUTE MOST TO UNIVERSAL WELFARE? If you make your decision correctly with this universal moral code as the basis of your judgment, you will always decide upon the best possible course open to you. The real difficulty, especially when pulled and hauled by contrary emotions, is to decide what course of action will thus yield the most in terms of universal progression. All too often the decision is really based upon selfish desire to do as one pleases, or upon the other equally fatuous extreme, the willingness to sacrifice one's own aims and desires, even if they are to the best interest of all, to the less considerate desires of some other person.

To apply the universal moral code the desires and whims, both of ourselves and of others, must not weigh in the scales of decision. The whole matter must be weighed with a long vision to future developments, rather than on a basis of immediate effects. The ultimate result of each course of action open should be thoroughly considered, peering into the future probabilities as keenly as possible. The probable ultimate effect upon ourselves, and upon each person influenced, should be taken into account with a view of determining, in the sum total of all effects, how much would be contributed by each course of action to the detriment and welfare of society as a whole.

Needless Antagonism

—Viewing the matter thus, one of the most frequent errors made by those who for the first time come in contact with The Religion of the Stars and other lines of advanced thinking, is to stir up needless antagonism. Carried away by enthusiasm for their new perception of truth, they not merely energetically and forcefully enter upon new manners of thinking and living, but they start a veritable crusade to convince their family and friends that their own views are far superior, and to induce others, who in reality may not be ready for so drastic a step, markedly to change their manner of living.

Let us always remember that man is merely a highly evolved animal. He is not a finished product, but still in the process of development. And his past experiences, the state to which he has at present reached, may or may not, as the case may be, fit him to discern and live by a more advanced moral code. He may still be in a state where the worn platitudes and sophistries of orthodoxy are as much as his soul can assimilate. Even if he is a member of our immediate family does not, by virtue of that fact, raise him to an evolutionary level where he can comprehend the higher, more spiritual aspects of existence.

Furthermore, it has been demonstrated thousands of times that new ideas and conceptions of how man should live cannot successfully be forced down the throats of people. People are not convinced by aggressive arguments. There is a right way in which to get an idea over to someone, and a wrong way in which to try to do so. Aggressive and combative tactics are the wrong way. The right way is set forth in detail in lesson No. 220. It embraces four distinct principles which should be understood and applied.

We are all of us responsible for having a better manner of living and a higher type of religion easily accessible to anyone who has reached a point where his old beliefs and old manner of living no longer satisfy. It is our job to see to it that all the people of the world are familiar with the chief tenets of The Religion of the Stars. These tenets should be so widely disseminated that they will attract those ready for them. And the details should be so readily accessible that no person will have much difficulty in gaining them.

But it is not our responsibility to compel anyone to accept these teachings. It is only our duty to see that they are brought to his attention and that he has facilities for learning them. When we can give another an advanced thought in a constructive and harmonious way we should take advantage of the opportunity to do so. And we should not condone the shams and obvious errors of other religions. But the neophyte who sets out by means of argument and destructive criticism to convert all and sundry to his way of thinking is not apt to do much that helps universal progression. Tolerance of thoughts, opinions, state of development and viewpoint of others is a prime requisite of the neophyte who is to arrive at adeptship.

The easiest way, in so far as it is feasible, to overcome the hindrance of family and friends to one's spiritual progress is not to draw their attention particularly to what one is trying to do, if there is likely to be antagonism.

There has been even a court ruling that so long as speech and action are proper, a husband or a wife has a right to think and feel, not merely about religious matters, but also in regard to personal matters, as he pleases. Whatever may be the opinion as to the completeness of freedom of speech and freedom of press as granted by the constitution, as yet there has been no encroachment, at least, upon freedom to think. And only those who do much thinking on their own, instead of accepting it ready made, will ever arrive at adeptship.

I am not here suggesting even the slightest hypocrisy. Hypocrisy, and any form of untruth, are to be sedulously avoided by the neophyte; as deceit tends to attract to one entities which favor deceit. Candor and truth should mark all the neophyte's utterances. But all of us think many things we do not say. We may, for instance, think that our neighbor is a liar; but we do not take pains needlessly to tell him so. Even should someone ask our opinion of our neighbor, we are quite justified, in the interest of neighborly harmony, in saying that we prefer not to talk about that particular person. Just because we think someone is the meanest person we have ever known does not signify that we must publish such an opinion, or even express it if asked. We have many thoughts which we do not talk about, because to mention them would stir up strife that would be harmful, and would accomplish no good purpose whatsoever.

So where husband or wife, father or mother, or close friends are quite sure to be antagonistic to our religious beliefs, to our knowledge that there is a life after death from which we on earth can, under certain circumstances, receive communications, to our knowledge that the inner-plane weather mapped by astrology has a profound influence over human life, to our knowledge that proper thought through psychokinetic power can markedly improve the conditions and events attracted into our lives, it may prove of greater benefit to the cause of universal welfare not to parade our ideas and beliefs before them. Seed should be planted, to be sure, in even spot in which there is any chance of it taking root. Initiative and ingenuity should be used to find ways of disseminating The Religion of the Stars. But where it is sure to arouse nothing but antagonism it is better not to sow the seed, not to mention the Stellarian religion. There is a time and a place and a proper manner of approach for such work.

Religious Prejudice

—From observing the lives of many thousands who have set their feet upon the upward path, I find the commonest cause of antagonism from family and friends to be religious prejudice. We have had husbands and we have had wives, who here in Los Angeles have told their marital partner that if he, or she, took up the study of astrology, if he, or she, attended The Church of Light classes, if he, or she, read certain books, that action would be taken to get a divorce. And from students scattered all over the world have occasionally come reports that the domestic partner has threatened such a course if they took up the study of astrology, psychology, or the study of The Brotherhood of Light lessons.

The problem presented by such an attitude of the marital partner is, indeed, serious. Marriage is not a condition lightly to be assumed or lightly to be ended. And in some of the instances of which we have had knowledge, the one who wished to take up advanced lines of study was not entirely free from blame. His enthusiasm and zeal for the new line of thought and life was so energetic, and consequently made such a marked change in his life, that it is little to be wondered that the marital partner thought that he was becoming unbalanced.

People who take up any fad are apt to go to extremes. Fasting, diet, health exercises, and even bridge, as well as various religions and metaphysical cults, gain advocates who carry their ideas to such a length that conservative people are justified in thinking them cranks. And the husband or wife of such an extremist, or the father and mother, or the close friends, can hardly be blamed for trying to bring considerable pressure to bear in the effort to restore sanity.

But the student of The Religion of the Stars who has progressed far enough to realize what the teachings of this religion are, if he puts them into practice, is apt to impress no one as a fanatic or extremist. And if he is associated closely with a family, or with friends, who have strong prejudices, he should be unusually careful not merely to avoid giving the impression that he is going off at a tangent, but he should also take pains that others shall observe that his life is more well ordered and that his character is more admirable than before taking up the new line of thought and endeavor.

The Religion of the Stars teaches that each individual should be tolerant and kind to others, that each individual should be considerate of family and associates, and that each individual should be a good citizen. And if those who arouse antagonism would at start take pains to air their views less radically, and to show that the Stellarian teachings are conducive to a kinder disposition and a better ordered life, much of the antagonism would never develop.

Certain it is that no one should hastily create a cause for discord in the home, and that no one should lightly consider the possibility of separation or divorce. Usually certain concessions can be devised by each such antagonistic element, by which neither feels he is relinquishing his right to spiritual progress, or his right to domestic concord. That is, instead of a dogmatic, unbending attitude, usually there can be found a means by which the difference can be composed without either feeling that he has been deprived of just rights.

The Sex Problem

—It is not permissible to discuss the problem of sex which often, due to changing views, is a cause of difficulty between married people when one or the other takes up some line of metaphysics. Any number of totally erroneous and misleading ideas are taught in certain occult circles regarding this subject. One can hardly blame the partner who is uninterested in occult matters for feeling highly aggrieved when his mate changes the affectional attitude toward him markedly as the result of some teaching. He feels, and usually he (or she) is right, that the other has become imbued with much nonsense due to such studies. He feels that this nonsense is breaking up his home, and he feels justified in trying to stop it.

Many instances have come to my personal notice of the gross selfishness of one type of person who thinks and claims he is seeking to be spiritual. There are various cults which teach celibacy. And if an individual is convinced he must be celibate to be spiritual, that is for him to decide. But to expect a marital partner who definitely does not believe in celibacy, and married on the assumption celibacy would not be forced upon him, to continue financially to support a spouse who has turned celibate and spurns affection, and demands that he shall not seek affection elsewhere, is something I have witnessed on various occasions. To such self-centered people it seems never to occur that fair play and a square deal are related to spirituality. They seem to have no concern as to what happens to the other person so long as they get what they want. Pretending to themselves they are being spiritual, in reality they are merely being callous and selfish.

However, there are many people who have never heard of occultism who are abysmally ignorant of the problems presented by marriage, although public libraries now contain books elucidating such matters. And in Los Angeles, and perhaps in other cities, there is a Marriage Clinic which attempts to educate people who have erroneous notions about marriage when these notions threaten to bring separation and divorce. The report on the first three years of the existence of this Marriage Clinic shows that, as a result of such education, 5,000 couples who were ready for separation and divorce were reunited, with a very much better chance for domestic harmony than they had before.

Among those who get notions from the many metaphysical and occult books that cause them radically to change their attitude toward sex and marriage, and thus stir up trouble, by far the majority, after a year or two find, from personal experience, that the results they expect from the new manner of life are not forthcoming. Consequently they decide that the way they were living before is really more sane than the method which, in their enthusiasm, they adopted and thrust upon their partner in the home. They conclude that, after all, the life they previously lived, in this respect is preferable. And fortunate they are if the husband or wife has not been completely estranged in the meantime.

This is said in no effort to condone discord in marriage. It is said in the hope it will induce earnest neophytes to come to decisions on such important matters without haste, and only after they are fully convinced they understand the matter in all its aspects. Selfishness, and a cold disregard of the needs of the other, is as apt to manifest among those who make a study of occult forces as among those more matter of fact. Yet kindness and consideration of others, including those within the domestic circle, are requisites to true spiritual progress.

Opposition to Study

—As to how much we should permit those associated with us in the home to dictate what we shall study and what we shall do must, of course, be determined by a full consideration of how much society will be served by permitting such dictation, and how much society will be served or injured if we make a stand for greater independence. We are not warranted, in the home or out of it, in causing society to suffer merely for lack of firmness and backbone on our part. Firmness, however, can always be coupled with kindness, and with a full consideration of the viewpoint and the feelings of others. Domestic problems arising from divergent views could be solved, far more often than they are, by the exercise of kindness, tact, and understanding the needs and viewpoint of the other.

Emotions are among our most valuable possessions, but they are a great hindrance to clear and unbiased thinking. When there has been a spat with another over something, it is almost impossible to form an unbiased opinion about the matter until enough time has elapsed that the emotions have entirely subsided. And if, when you think about a situation you feel emotion about it, or feel hurt that someone has taken a given attitude, you will find that your judgment is distorted accordingly. Therefore, before deciding the right or wrong of a domestic issue, or before trying to decide what is the best thing to do about it, await such a time and place as will insure freedom from feeling and emotion.

Then set about understanding the matter by putting yourself in the other person's place. Take into consideration his educational and emotional background. Endeavor to perceive just why it is that he opposes your thinking and doing as you desire. You must try to discern what he feels and why he feels it, about the matter. And very often, with a clear comprehension of this, it will be possible to devise a method by which your own progress will not be impeded, and yet overcome his objection to your course of action.

But if such a plan cannot be devised by which the contending elements can be harmoniously composed, think of just what it means to him (or her) and how it will influence his life, if you continue your contemplated plans. Try to think the whole matter through, to discern how his life, and through it still other lives, will be affected. Will the course of action you have in mind retard him? Will it, through his reaction to it, have a detrimental effect upon others; and how many others will it influence in a derogatory manner?

Then consider the influence of the course of action upon yourself. Think of just what may be expected through it, and whether or not, and to what extent, this course of action will benefit others. Will it place you in a position where you will be able to be of greater service to others? Will the amount of service to others more than compensate for the detrimental influence that such action will have upon those in your home? Will the effect upon those in the home life lead them to actions that will influence still others, and if so will this influence be as great a hindrance to the forward movement of society as your new efforts are an aid to it?

It is, indeed, difficult to get a clear and unbiased picture of all possible effects when the question of liberty to live one's own life is involved. Perhaps it is true, as is so often stated, that any person should have the right to live his own life in the manner he sees fit, provided in so doing he injures no one but himself. The trouble with this attitude is that no person can live to himself. Almost any thought or action on his part is sure to influence, directly or indirectly, the lives of others. And before making any important decision in regard to his life, he should consider how various persons will be influenced by the decision; and then act according to the perfect moral code, taking the course that will yield the most benefit to society as a whole.

On the other hand, we have those who are narrowly selfish, yet think they are the world's elect who, regardless of the effect upon others, or whose feelings they hurt, smash ahead to live their lives just as they conceive it. That such a course may crush other lives weighs little in their plan of things. Then also, and quite as pernicious to human welfare, are those who, perceiving how they might be of great assistance in the upward swing of universal life, permit narrow minded relatives to work upon their sympathies and dissuade them from it. In the attempt to be kind to a handful of relatives they are truly unkind to thousands who might benefit by their wider usefulness.

The surgeon dislikes to cause his patient pain; yet if the removal of some part is beneficial to the whole organism he can neither consider the pain of the patient nor the desire of the organ to remain intact. And the individual who has the ability to serve in a wider field than is afforded by his immediate relatives should, in the interest of the whole of humanity, be permitted to exercise his talents. But, certainly, before any decision is made which causes pain to another, there should be absolute conviction, carefully arrived at that, in some way this decision is in the direction of increased usefulness. It is far too easy to permit desire to rationalize the actions into a semblance of greater usefulness, or to permit sympathy with others to rationalize the actions into an effect upon them that in reality would not exist.

Commonly those who wish to study advanced things can find opportunity to do so, at least during short intervals, at times when it is not likely to stir up opposition. It is much better to do a little reading and much thinking about what has been read, than to do much reading and only a little thinking about it. Most people can find at least fifteen minutes a day for reading without creating a disturbance. And if this system were followed with regularity, and what was then read were thought over carefully at other intervals during the 24 hours, the individual would make better progress in his studies than most students actually do.

On this much publicized plan of fifteen minutes of reading a day, he could finish one of The Brotherhood of Light lessons in four days. As in the complete system of 21 courses covering all branches of occult science there are 210 regular lessons, the complete set of 21 courses could thus be read in less than two and one-half years. I am assuming here that time is taken each day to assimilate and understand what has been read. An hour while yet in bed before rising in the morning, an hour before going to sleep at night, half an hour at lunch time for such thinking by the office girl. Very few people are so situated that others can control their thinking 24 hours of each day. And people cannot object to one's thinking if they do not know what one is thinking about.

In addition to the reading for fifteen minutes a day for two and one-half years to cover the 210 regular lessons, there would be the Award MSS. to read, and there would be some extra time that should be devoted to astrological practice. You will understand that I am not implying the fifteen minutes a day reading is all that is required; for this fifteen minutes must be supplemented by plenty of thinking about what has been read. This thinking can be done while engaged in routine work at home, in the office, on the way to work, before retiring, and at various intervals whenever the mind is sufficiently free from necessary application to other things. But if the reading for fifteen minutes a day were thus supplemented by thought at those times when such thinking can be done without disturbing the life or neglecting the ordinary duties, I feel safe in saying that the average individual in three years of such application could successfully complete the whole of the 21 Brotherhood of Light courses of study, including the becoming of a fairly good astrologer.

Opposition to Extrasensory Unfoldment

—Because the reading of a book, or of one of the Brotherhood of Light booklet lessons is apt to attract attention if done in the presence of others, the opportunity for such reading is more difficult in the home where interest in progressive lines is apt to be opposed than is the opportunity for practice in extrasensory perception and psychokinesis.

A daily exercise in concentration, meditation, or extrasensory perception should seldom last over half an hour at a time, and fifteen minutes is long enough if properly utilized. And one can thus exercise the mind or extrasensory perception almost anywhere and almost at any time without attracting attention. Of course, deep meditation or the use of the transition technique of extrasensory perception are not suited to practice on a street car or motor bus or at the dinner table. But, if one is not too tired when one goes to bed, he can awaken in the night when refreshed, and carry out the desired mental exercise or inner-plane extension of consciousness without arising or disturbing anyone, and then go back to sleep. Many busy people have found this the most successful time to develop the inner-plane faculties.

Opposition to Spiritual Development

—But study and the development of extrasensory perception and psychokinesis will not of themselves lead to real spiritual progress. Spirituality is a method of life rather than an intellectual or psychic attainment. Spirituality implies the raising of the dominant vibratory rate through living a richer life. And because there are so many erroneous notions as to the nature of spirituality, the neophyte, ever so often, should review what is said about the subject in lessons No. 170, No. 171 and No. 172.

One can hardly imagine an environment in which the neophyte struggling to develop spirituality—which is measured by the dominant vibratory rate— would be prevented from being helpful to others. The truly spiritual life is the life devoted at all times to such thoughts, feelings and actions as will most help others. This is not a life of self abnegation. On the contrary, it is the exact opposite; for no person who permits the unworthy desires of those in his environment to dominate his existence can do much to help people. And while there are other ways of raising the dominant vibratory rate, the effort to contribute one's utmost to universal welfare is the most successful method.

To permit one's family always to have their own way about everything is ruinous to their character. It is not in the direction of helpfulness. To permit a child, or other associate, always to take, without giving something adequate in return, is to foster and develop selfishness. In our effort to be unselfish, we must be careful that we do not cultivate ungenerous habits in others, or an attitude of dependence which will thwart the development of sturdy attributes.

Not only, in living the spiritual life, must we realize how important our attitude toward members of our own family is in the development of their characters, and that character development is far more valuable to them than the gratification of physical desires, but we must also keep in mind that our own progress and development, in many ways, is not to be considered as a selfish ambition, but as necessary steps toward the wider usefulness we thus can attain.

Domestic Discord

—It is only the rare home in which any serious opposition will develop to the neophyte adopting The Religion of the Stars as the religion by which he lives, in which much opposition will develop toward the study of the occult sciences, or toward sane and sound development of extrasensory perception. But in many, many homes, and in many circles of acquaintances, there is the ever-present problem of discord.

Such discord arising from close association with others, and which if not properly handled may hinder spiritual progress, chiefly manifests through three different channels.

There may be some one whose character vibrations are so antagonistic, aside from any particular thing that is said or done, that it causes a sense of irritation or almost nausea. Companionship between people who thus affect each other adversely, or when one of them is made uncomfortable by the presence of the other, is a disadvantage. Like a slow poison, it decreases efficiency and hinders progress.

People who thus affect each other should not be compelled to live together under the same roof or in the same office. But economic necessity or other circumstances often compel such distasteful associations. And when such an individual cannot be avoided, one plan is to build an impervious wall around oneself. There should be no antagonism felt, no radiation. Just an armor of protection which will not permit the radiations of the other, or the thoughts of the other, to reach the finer body. This process, and the details of even a more desirable technique are explained in lesson No. 184.

But there is a second kind of poison which may have an adverse influence, that may be administered by one toward whom there is deepest affection. The fact that there is a deep sympathy aids it somewhat in its destructive work. I refer to gossip in which the character of someone is blackened, to stories of a decidedly spicy content, and to lewd and vulgar jokes. Members of the family, or friends who in all other ways are admirable and lovable, may have the pernicious habit of wallowing thus in mental filth, and of smearing this mental refuse on all other minds they contact.

Prudishness is merely an ignorant refusal to face and recognize the facts of existence. Prudishness is not in the direction of the perfect moral code. It is not that we should refuse to recognize that other people live in filth of mind and filth of body, but that no good end is served by contacting that filth. Because refuse and moral garbage exist in certain sections of our community does not make it necessary for us to hunt it up and soil our minds with it. Smutty stories, salacious gossip, and other mental filth should be shut resolutely from our minds. Spirituality is a high dominant vibration which for its sustenance requires refinement and richness of life; and mental corruption, such as we have been considering, is a corrosive influence that not only pollutes the objective consciousness, but poisons the soul and lowers the dominant vibratory rate.

One may be so situated that it is impossible not to overhear conversation of the nature here described. Economic necessity, or even one's cosmic work, may take one among people who are coarse and vulgar in their mental tastes. Some otherwise very dear people are gossip addicts. But it does lie within our power, and usually we can do it without giving offense or arousing antagonism, to pay no attention to such conversation. When heard, such conversation can "go in one ear and out the other.,, There are always many fine things to think about, and one never need dwell on the festering themes of degrading conversation.

The third kind of mental poison, and the most prevalent type, is that of mental conflict between associates. People, especially those close to us affectionally, have many traits, such as argumentativeness, or as chronically opposing what we wish to do, or continually finding fault and criticizing, or raising a row ever so often, that stirs up within us discordant emotions. The jealousy, hate, spitefulness, irritability, crossness, and other mental traits of those in the home, may be such as to tend to arouse in us also retaliatory emotional states.

Discordant thoughts and emotions are not spiritual and not in the direction of the perfect moral code, because they poison the body and build within us discords which cause the thought-cells so influenced to use their psychokinetic power to bring into the life unfortunate events. Unfortunate events detract from our efficiency to benefit ourselves and to benefit society. Therefore the neophyte should persistently and energetically adopt a plan in which he recognizes each stimulation toward an emotional discord as a definite problem which he is called upon to overcome. Knowing, from association with family and friends, the kind of occurrences which are apt to arise to cause him discord, he should plan a definite attitude which he will always assume under each of these circumstances.

Action is always toward the image which at the moment gains most attention. It is the function of directed thinking to hold in the mind, especially while under stress, the image of the predetermined course of conduct. Due to conditioning, the unconscious mind presents certain thoughts to the attention and releases certain emotional energies, under definite types of circumstances. But instead of thus being the slave of

habit, we should learn to hold before attention the predetermined image. This image is that of the attitude we have decided to maintain. And to insure that it is not displaced by the previously conditioned one, it should be reinforced with as much pleasure as possible, according to the principles and instructions set forth in lesson No. 59.

No matter what someone else does or says, by resolute practice the neophyte can develop the ability always to remain calm and well poised. When we depart from the completely constructive attitude, and permit mental or emotional discords to develop within ourselves, we should recognize the real fault does not lie with some other annoying person, but with ourselves. We are annoyed, or otherwise emotionally disturbed, because we permit it.

Because the emotions are so closely tied up with those in the domestic life, the hardest tests of the permanently constructive attitude commonly occurs within the precincts of the home. But anyone who remains harmonious within himself, in spite of what others say or do, is sure to gain their respect. Under no circumstances can either thought or action function to better advantage while stimulated by a discordant emotion. Nothing is gained by it, and much is lost.

As a matter of observation, the situations which develop in domestic life afford the best of all training for a wider field of constructive endeavor. Cheerfulness and harmony in the face of such contending factions as often develop where a number of persons must live together in close association, indicate that the neophyte has made marked advance on the spiritual path and, due to this acquired spirituality and ability, is ready for larger undertakings.

Chapter 5

Serial No. 220
Original Copyright 1949
Elbert Benjamine

Copyright
August 2002
Church of Light

Spiritual Trends In Personal Conduct

Chapter 5

Spiritual Trends In Personal Conduct

DOUBTLESS you have walked down Broadway during the busy hour, or at least you have been in an auto at a time when there was great congestion of traffic. And under such circumstances you found that you had no great difficulty so long as you kept step with the procession. So long as you walked no faster nor slower than those about you, or so long as your car went no faster nor slower than the other cars on the street, there was no great cause for discomfort. But if you slacked your pace you were jabbed by elbows and shoved in the back, or if in an auto, there were loud honkings and harsh words from those you thus impeded. And if you tried to move faster than the crowd, the angry glances, the words of those you passed, and the general remonstrance increased in direct ratio to your hurried efforts.

Life, also, is like that. So long as the neophyte keeps in mental step with those around him, no opposition is likely to develop. But the more backward individual is always shoved and buffeted about. And when the neophyte begins to step out mentally and spiritually, when he begins to move faster in his progress than those about him, he is apt to arouse a storm of disapproval.

If the person hurrying down crowded Broadway stops to argue with every person who makes it plain he believes such speed is uncalled for, he is apt to spend so much time and effort in verbal combat that he really makes no more headway than the crowd. Instead of this, if he meets displeased glances with a smile, he is neither delayed nor so greatly impeded. And this is true also in the neophyte's efforts to make the greatest progress. It is seldom that violent arguments convince anyone, and they are all too apt merely to increase antagonism and arouse discordant emotions.

After all, people think as they do because of their experiences. And they have a right to a hearing as to their views if you are trying to convince them of something. In fact, unless you do permit them thus to present all their objections to your ideas, they will feel that you are unaware of these objections, and that you believe as you do because you are ignorant of them. Furthermore, in addition to making it plain to the individual that you thoroughly understand each of his points as he presents them to you, you

should make him feel that you are friendly disposed. Certainly, one of the surest indexes to smallness of character is the inability to be friendly with someone with whom you disagree on some matter of politics or religion. You can be friendly, and make the other individual feel that you continue to be friendly, even though you do not agree with all he says.

Debates Do Not Convince

—The neophyte can hardly contribute his utmost to universal welfare unless he tries to make this a better world, and tries to help people gain optimum living both while on earth and after they have passed to the inner plane, through getting as many as possible to become familiar with and accept The Religion of the Stars. As with everything else that should be done, there is a poor way to go about it, and a right way. The poor way is to try to cram your opinions down the other fellow's throat by aggressive argument.

No matter how sound your argument may be, or how weak his, you will never convince him unless you can keep him in a friendly and non-combative mood. Any attempt to overcome his opposition by arguments forcefully delivered, hoping to overpower and route those he presents, will give his ego the feeling that if he admits you are right it will concede to you a superiority and to him an inferiority. His ego, because the power urges are the strongest of all mental factors, will never permit the development of such a feeling of inferiority; and no matter how sound your arguments may be they will only succeed in stimulating him into seeking additional reasons to disagree with you.

Public debates, for this reason, seldom convert anyone to a different opinion. Those who attend such debates have their minds made up before they go, and thus identify themselves with the speaker, or speakers, who express their views. It is thus a matter of combat, in which their ego will not permit them to admit defeat by a change of views, because to do so would result in a feeling of inferiority. What they attend the debate for is to see their opponent defeated. Nor will either side admit such defeat. All go away with the same opinions, strengthened by the heat of conflict.

In making converts to The Religion of the Stars there are four principles that should be understood and as often as possible applied.

1. You should be thoroughly familiar with the truths you are trying to get the other person to accept.

2. The interchange of thoughts should remain at all times friendly. Whatever doctrine of The Religion of the Stars you are trying to get some other person to accept, the next requisite to understanding it yourself is to bring the matter up between you on terms of friendly interchange of thought, and not as something you are attempting to thrust upon him. And it is essential to see to it that this friendly feeling of interchanging views is maintained throughout; for should it develop even in a small degree into a contest, that implication will cause him to reject arguments no matter how plausible they may be. Even though verbally he admits them to be reasonable, his ego will continue to reject them to maintain its own self-esteem.

3. It must be recognized that the human mind is not so constituted that it can readily accept a number of new viewpoints at once clearly. Therefore, when the time arrives when you are permitted to present your own views on the subject, always select only one or two of the most important and convincing points.

4. Be sure you have his attention, and then present the point or points you have selected as most significant positively and forcefully, but in a friendly manner. If your friend interrupts you with new argument while you are clearly presenting your views, you may be sure he is thinking of means to combat, rather than to understand, what you are saying. With the utmost friendliness insist that he hear your side of the matter. And without antagonizing, see that he understands it. Repeat it positively until you are sure it has registered. But present only the most important of your material.

Your acquaintance on the street car, for instance, voices disapproval of astrology. Find out what he knows about it. Ask him questions to get his views, and show him by further questions that you understand his arguments. Do not, however, start to refute him; for this will place him on the defensive against an aggressor. Then, after he has told you all he really knows about it, tell him convincingly that the professors who scoff at planetary influence have never seriously investigated the subject, do not know how to erect and progress a chart of birth, and have no real evidence on which to base their opinion.

Then cite concrete examples of birth-chart portrayal of character traits, natural aptitudes and predispositions toward types of events and types of disease, and cases in which the event or disease indicated by its progressed constants have actually taken place or developed at the time the progressed constants were present. In a friendly manner keep on relating authentic facts that afford concrete proof that astrology actually works. Do not scatter about, trying to answer all his previous arguments, but get him to see the central idea you are endeavoring to present, in this case the actual proof that astrology does the things you claim for it. And if you have not aroused antagonism you will thus have made as strong an impression as possible toward getting him to accept your views.

Or suppose he sneers at the possibility of those who have passed from physical life communicating with those still in the flesh. Get him to tell you about his unsatisfactory experiences with mediums. And where you can agree with him, so agree; and where you cannot agree, for a time let him talk. Then in a friendly manner get hold of his attention long enough to explain first, that numerous universities have, under test conditions, demonstrated that telepathy, the nonphysical communication of mind with mind, is a fact. Then tell him of the painstaking manner in which various outstanding scientists have investigated this matter and have come to the conclusion that the personality survives the tomb and sometimes communicates with those yet in the physical. Then go on to tell him of experiences of your own, or other persons, experiences, that tend to substantiate these scientific findings. See that he gets this central idea clearly, and that telepathy is now accepted by science, as forcefully as they can be given without arousing antagonism, and you will have done all you can to give him a better understanding of the relation between those on the two planes of life.

This method of convincing another follows strictly the laws of psychology. But it must not be supposed that every person one meets is in a state of development where such convincing is possible. The emotional elements, built by childhood religious training, often are too strong to be overcome even by first hand and irrefutable experience. Neither facts nor logic can get past a sufficiently powerful emotional block.

Yet at least one part of the sound psychological formula can be retained, even when people violently antagonize your views and your progress. You can still smile and still give them to understand that you feel friendly toward them. Their antagonism and their efforts to hinder will be lessened by a friendly manner, and under no circumstances will the opposite course aid in converting them to your views.

However, I am not suggesting that there should be any backwardness or hesitancy, when it will serve a constructive purpose, in presenting facts which will aid mankind to a better understanding of life and its problems. The withholding of information which will help others is cowardice or gross selfishness. I am not merely suggesting that there is a right time, but also that there is a right place and a right manner for their presentation. Untimely effort, or effort directed athwart sound psychological laws, is not only wasted, but often stirs up strife that prejudices against the later acceptance of progressive views.

As illustrated by the hindrance to your movements when you try to travel a crowded street swiftly, you will find that the faster you attempt to travel spiritually the more opposition to your progress you will meet. And there is a wrong way and a right way to handle such hindrances. The wrong way is to feel irritated, to incite antagonism, and to engage in heated arguments. The right way is to be well informed, and to plan carefully how you can do the thing which spirituality requires with the least conflict with others. If real spirituality, if righteousness, demands conflict, there should be no hesitancy about taking a firm and aggressive stand. But as a rule firmness can be combined with kindness in such a way that conflict will not prove necessary.

Yet for Stellarians, spirituality does demand where ever it is possible that seed shall be sown that will grow into interest in The Religion of the Stars. Every opportunity to get people familiar with Stellarian teachings should be grasped. But the seed thus sown should be watered with kindness and tolerance so that it will grow.

Thus to be able to plant the seeds of interest, and to stimulate their growth into a serious desire to learn the doctrines of The Religion of the Stars, each Stellarian should not only be familiar with the general ideas set forth in Brotherhood of Light lessons, but he should at all times have at his ready command both the questions and the answers that are most significant in the tenets of The Religion of the Stars. So that he may at any time explain these facts to others, and thus give them an accurate overall picture of The Religion of the Stars, and so that he can use any one of them convincingly in getting others to accept the Stellarian viewpoint, each Stellarian should learn to use the following questions and answers with facility.

The Stellarian Questionnaire

—As in The Church of Light there are 50 degrees of initiation leading to absolute human perfection on the earth plane, the endeavor has been to formulate 50 of the most important questions and their answers, the last one, of course, crowning all, as does the united sun and moon at the apex of The Church of Light emblem, indicating exactly how every Stellarian should try at all times to live.

The Roman numeral following the answer indicates the Brotherhood of Light course, and the Arabic numerals indicate the pages in that course, where a more complete explanation may be found. The booklet lessons, as well as the cloth-bound books, of each course may be referred to with facility according to the pages indicated; for each booklet contains exactly 32 pages, and their consecutive place in the course is indicated by a letter on the upper right hand margin of the cover. Also by consulting a Lesson List the serial number and the consecutive place of each lesson in a course may be ascertained. Its serial number is located on the upper left-hand margin of the cover of each booklet. *[The arabic numbers refer to pages from the hardbound, black with gold lettering edition of the courses. This format has been replaced and these arabic numbers no longer apply.]*

1. What is the ego? Its ego is the indestructible spark, or emanation, from Deity which is the potentiality activating every soul. II. 103-105; V. 9-16.
2. What is the soul? The soul, or character, or unconscious mind, is the inner-plane organization of the ego's total experiences up to the present time. II. 105-122; V. 5-27.
3. What is the purpose for which the soul is brought into existence? The soul is brought into existence and undergoes such experiences as are necessary to train it to become a constructive workman in the realization of God's Great Evolutionary Plan. V. 9-16; XIV. 8-24; XIX. 135-138.

4. What are the three drives which the soul, both while it has a physical body and after the dissolution of the physical form, at all times strives to realize? The drive for significance, the drive for nutrition, and the drive for reproduction. V. 135-137; XII-II. 5-8.
5. How is the soul attached to the physical form it occupies? By psychokinesis. XII-II. 238.
6. What determines the species of life-form to which the soul is attached? Its ability gained through experience while attached to less complex life-forms. XIX. 18-24.
7. What enables the soul after the dissolution of one physical form to attach itself to, and have experiences through, the form of a higher species of life? Its increased ability gained through experiences in the form it left. XIX. 14-26.
8. What are the functions of pleasure and pain? Pain has but one function; to inform the soul that a destructive condition is present. Pleasure has but one function; to inform the soul that a favorable condition is present. The purpose of pleasure is not to reward, and the purpose of pain is not to punish.
9. What is the universal law of compensation? The universal reward of effort is greater ability XIX. 143-149.
10. What part has freedom in the evolution of the soul? Every step in evolution is toward greater freedom. XII-II. 237-245.
11. Why, after occupying and gaining experience in the form of man, must evolution and still more complex experiences be had, not on earth, but on the higher-velocity inner plane? The chief function of life in the human form on earth is to confer self consciousness. Physical life has its limitations. The experiences necessary in training the soul to become a constructive workman in God's Great Evolutionary Plan cannot all be had on earth. They require conditions that can be had only on a higher-velocity plane than that of earth. XX. 307-312.
12. What evidence is there of an inner plane on which life continues? Extrasensory perception and psychokinesis operate according to nonphysical laws, and thus imply the existence of an inner plane. I. 45-47.
13. What evidence is there of extrasensory perception, telepathy and psychokinesis? Millions of trials conducted by university scientists prove that such psi phenomena take place. XII-I. 46-47; XII-I. 204-212; XII-II. 201-214.
14. What evidence is there the personality survives the tomb? Many of the world's greatest scientists have investigated psychical phenomena and have concluded the phenomena prove such survival. I. 176-179.

15. If good karma and bad karma are responsible for man's condition in the present life, as creatures lower in the evolutionary scale have no sense of morals, what determined the condition of a life-form at its first incarnation as a human? The soul's past experiences, which are neither moral nor immoral, in lower forms of life. And these, together with its human experiences, determine its condition when it passes to the next plane. II. 217-222; X-I. 71-72.

16. What actually determines the birth-chart of an individual, and therefore the condition and events toward which he is predisposed? He is born at the time the inner-plane (astrological) weather corresponds to the thought-cell organization which constitutes the character of the individual then born. I. 116; X-I.72-73.

17. How can the individual best find out if the inner-plane weather conditions mapped by astrology actually and profoundly influence his life? He should erect the birth-charts and work the progressed aspects of himself and his friends, and check on character traits, and the events that have happened in the past, and observe the type of events progressed aspects indicate for the future. VIII; X-I; X-II.

18. Does the outer-plane environment or the inner-plane environment have more influence over man's life while he is still on earth? Their influence is about equal. XII-II. 214-219; XII-II. 229-236.

19. What are the three types of inner-plane energies that have an influence over man both while he is still on earth and after he has passed to the next life? The character vibrations of objects, the thoughts of other people and entities, and the inner-plane (astrological) weather. XII-II. 215.

20. Do progressed aspects indicate inevitable physical conditions or events? No, they only indicate the influence of inner-plane weather of a particular type and harmony or discord. XII-II. 230-235.

21. Is there a god of whim and prejudice such as the Old Testament pictures? No. But there is an all-pervading Super-Intelligence Who operates through undeviating law. XVII. 136; XII-II. 221-222.

22. Why is vicarious atonement impossible? No one can gain knowledge, ability, character or spirituality for another. XII-II. 190-191.

23. What are the only four possessions an individual can take with him when he loses his physical body? Knowledge he has acquired, ability he has acquired, the organization of his finer form (character), and his dominant vibratory rate (spirituality). XII-II. 191.

24. Is there a static heaven and hell? No. XX. 46-52.

25. What determines the spiritual level on which the individual functions both while he occupies a physical body and after life on earth is done? His dominant vibratory rate. XX. 18-32.

26. Should one's religion be based merely upon belief? People have found in other than the religious affairs of life that if they believe what they are told without demanding proof they will be exploited and cheated. XII-II. 12-19.

27. Why is the Stellarian Religion called The Religion of the Stars? Because astrology affords the best possible road-map for guidance to the most effective and highest type of life. XII-II. 229.

28. Why is materialism on its way out? Because irrefutable evidence has been obtained by widespread university experiments that man's mind does not operate in accordance with physical laws. XII-II. 229.

29. Why is orthodoxy on its way out? Because evidence is fast accumulating that man's life on the inner plane is not as orthodoxy has pictured it. XX; XII-II. 199-206.

30. Why should research be conducted to bring extrasensory perception under control? Because it can benefit man by enabling him to acquire valuable information he otherwise could not get. XII-II. 206-212.

31. Why should research be conducted to bring psychokinesis under control? Because psychokinesis can heal the sick and assist man to have freedom from want. XII-II. 212-214.

32. Just what does religion strive to do? Religion consists of the effort to employ nonphysical means to find on earth more ample satisfaction for the drive for nutrition, the drive for reproduction and the drive for significance, and to continue to find satisfaction for these three drives for as long a period as possible on the inner plane. XII-II. 8.

33. How does knowledge of astrology assist in developing moral attributes both in children and in adults? It indicates toward which specific weaknesses they have a predisposition, and the means to overcome these specific weaknesses. XII-II. 227-248.

34. How does knowledge of progressed aspects assist the individual to live according to the tenets of his religion? It indicates the periods in which temptation will be strong, and what precautionary actions to take not to succumb to it. XII-II. 248.

35. How does knowledge of astrology enable the individual to select the vocation in which he can most benefit himself and most benefit society? It indicates his natural aptitudes and the environment in which he can employ them most fortunately. XII-II. 249-250.

36. How does knowledge of astrology enable the individual to remain in good health? It indicates the diseases toward which he has a predisposition, the periods when each is apt to develop, and the precautionary actions to take to prevent them developing XII-II. 250-252.

37 How does knowledge of astrology assist the individual to avoid unfortunate events and to attract events which are more fortunate? It indicates toward which unfortunate, and toward which fortunate, events there is a predisposition, and the periods when a certain type of event is likely to occur. And it indicates the precautionary actions to take to avoid or mitigate the unfortunate events and to take the utmost advantage of those which are fortunate. XII-II. 253-254.

38. How does knowledge of astrology assist individuals and nations to live together in peace and harmony? It gives them a clear understanding of each other, and of the periods when they are apt to behave in a certain manner due to the impact of inner-plane weather. XII-II. 255.

39. Is it more sensible to judge what God wants by his actions, as observed in nature, or to judge what he wants by some person's opinion who is ignorant of nature? It is better to judge by observing what takes place in nature. XII-II. 255-256.

40. What has been the means orthodoxy has employed to enslave the people of the West? It has taught reward in heaven for doing as the priesthood dictated, and punishment in hell for those who did not do as the priesthood dictated. XII-II. 188-192.

41. What has been the means orthodoxy has employed to enslave the people of the East? It has taught reward in a future life on earth for doing as the priesthood dictated, and punishment in a future life on earth for not doing as the priesthood dictated. XII-II. 156-160.

42. What is the difference between the means orthodoxy has employed in the West and the means orthodoxy has employed in the East to keep people enslaved? The reward for obeying priestly commands and the punishment for not obeying priestly commands in the West has been promised for a future life on the inner plane, and in the East has been promised for a future life on earth. XII-II. 160.

43. Why is freedom of information and freedom publicly to discuss any and all facts essential for the progress of the world? Because only thus can people learn the truth, and only when they learn the truth and act upon it can they make satisfactory progress.

44. What is the Universal Moral Code? A soul is completely moral when it is contributing its utmost to universal welfare. XIX. 179-180.

45. Why must religion never remain static? Because it should be based upon as many outer-plane facts and inner-plane facts as possible, and thus include new facts as fast as they are discovered. XII-II. 11.

46. Why is The Religion of the Stars the world religion of the future? It is because as fast as they are discovered and properly verified, each new significant outer-plane fact and each new significant inner plane fact is added to it in its proper relation to all facts already known. XII-II. 204.

47. Why can truth alone make men free? Only when they have the truth and act upon it, instead of upon error, can men be free from want, free from fear, have freedom of expression and have freedom of religion. XII-II. 12-22.

48. Why are those who permit their emotions, thus conditioned in childhood, to determine their religion, like European lemmings? Both instead of following the dictates of reason based on facts, permit emotion to guide them into disaster. XII-II. 12-14.

49. Why is it so important properly to recondition the emotions? Because they are the tools man must use to get what he wants, and if they are not reconditioned they will get him what he does not want. XII-II. 15.

50. In what way does the Stellarian try to handle each and every problem with which he is confronted? He tries to handle it in the manner that will contribute as much as possible to universal welfare. XXI; lesson No. 116.

Think Kindly

—The Religion of the Stars demands of its neophytes that they do their utmost to help the life-forms by which they are surrounded. Working as efficiently as possible for universal welfare is a fundamental creed. Yet no one can do his utmost for others if he feels irritated or antagonistic towards them. Feelings radiate energy that impinge on the finer forms of others and have a harmonious or discordant influence upon them. One need not be sympathetic in the sense of feeling the other person's affliction; and it is better not thus to take on the afflictions of others. But to do most to assist others one must feel kindly toward them.

The neophyte, therefore, who aspires to reach the exalted height of adeptship, should commence to establish the feeling of kindness towards all persons and all other creatures as a permanent habit-system. Whenever he begins to feel irritated or antagonistic he should commence to think about some phase of the other person's life, or about something which is admirable which can, directly or indirectly, be associated with the person causing irritation. One can have on tap certain thoughts for such occasions which will lead the mind and emotions to feelings of kindness and well wishing. There is always something that can be brought to mind that will present a kindly angle where another is concerned, and which can be substituted for discordant thoughts.

The habit of thinking kindly toward every other person and creature you contact will not be developed in a moment, nor even in a year. There are almost sure to be lapses in which the old feeling of irritation comes to the surface. But, with persistent effort and proper determination, you can arrive at this very definite state of spiritual development. Even a slight degree of success in this cultivation of kindness is eminently worth while. And when you reach a state in which, not mere tolerance, but an active kindness is felt toward every living thing at all times, you can be assured you have reached a very important level in your upward climb.

Be Eager to Learn

—Still another habit-system which every neophyte should acquire is an eternal eagerness to learn something more. The adept, although he is the perfect man, never thinks he knows all there is to know. The man who thinks he knows it all invariably is an ignoramus. The adept realizes, although his horizon is vastly wider than that of most men on earth, in relation to the vastness of the universe and its multiple planes, and to other types of universes in the cosmos, that what he knows is minute. No matter how advanced in knowledge he becomes, he continues to have an insatiable thirst for more.

The effort to acquire still further and more accurate information should become so built into the character that it is a permanent habit-system. Alertness to acquire new perspectives, a keenness for facts that have a bearing on the problems of existence, and some time regularly spent in study are not merely the marks of a neophyte, they likewise are traits which distinguish the most advanced men. And the neophyte who acquires early in his progress these tendencies, and so thoroughly ingrains them into his makeup that they are essential ingredients of his character, has taken a long step in the right direction. He is actually following a practice now that he will never have to discard; for he has made his own a trait which he will continue to employ after he attains adeptship.

The Habit-Systems of Energy

—There are so many erroneous notions afloat about the kind of life led by a Master that I should once again point out that a Master does not lead a life of ease, but a life in which work of importance and magnitude is done for the benefit of his fellow man. No one who is lazy can become an adept. To scale the spiritual height requires ceaseless effort.

Some people are sluggish, and with difficulty can prod themselves to make a moderate amount of effort. Other people are so high-strung that their over-activity repeatedly impairs their health.

While mental or physical work uses up either electrical or physical energy, commonly, due to tensions, the exhaustion that results is out of all proportion to the work actually accomplished. Few people know how properly to relax. To make a speech in public, to write a letter on the typewriter, to drive a car, to go shopping, to cook meals, or to do most of the work that needs to be done nowadays requires very little muscular tension. Yet most people who do these things are muscularly tense. And it is this unnecessary muscular tension that wears them out rather than the work they do.

A tense muscle is an indication of nerve tension. And nerve tension indicates that electrical energy is being used. Muscular activity requires that certain muscles be shortened. But when muscles are thus shortened at times when there is no need for their activity it uses up energy needlessly. But most people have developed a habit-system of tensing muscles when they think certain thoughts, and of tensing muscles that are not required to be active in the work they are doing, and thus unnecessarily wear themselves out.

A ball player or other athlete who keeps his muscles in a constant state of tension is never a success, and ends up by being muscle bound. To throw a ball with facility and accuracy, to drive a car through bad traffic without danger, to type with speed and accuracy, or to think clearly and with facility, the muscles should be relaxed as much as possible before being called on for whatever work, if any, it is necessary for them to do.

To be able to work with speed and accuracy, and without unnecessary fatigue, the individual should learn to relax completely at intervals and to call upon his muscles for action only as such action is needed. People can even wear themselves out sitting in a chair if they keep tense, and if the tension continues after they go to bed they may be unable to sleep. When the body is completely relaxed there is no difficulty in going to sleep.

Practice in relaxation often is quite as necessary as practice in doing the work required. Thus to relax, lie on your back in such a position that there is no strain on any muscle of the body. Then give attention to one set of muscles after another, letting the muscles under consideration go as limp as possible and talking to them mentally, giving them the suggestion, "let go, relax, let go, relax, relax still more...". Start with the toes and work up, devoting several minutes to each set of muscles: the calves of the legs, the thighs, the abdomen, the hands, the arms, the shoulders, the neck, the face, and finally the eyelids. And keep giving them the suggestion to let go, and feel them thus go limp.

Then when you go about your work, as much as possible keep the muscles relaxed. And as any discordant thought or painful emotion tends to tense the muscles and otherwise use up electrical energy, take what happens in your stride and harbor only pleasant thoughts. In this way you will be able to accomplish vastly more, and will avoid nerve difficulties.

One becomes accustomed to living at a certain speed to which the body and energy generated gradually adapt themselves. If this speed is acquired at the expense of tension and nervousness, it is wearing and decreases the efficiency. And if it cultivates habitual sluggishness and a dread of effort, it affords neither pleasure nor adequate output. But if tension is avoided the speed of activity can with practice be accelerated and maintained throughout each day with maximum output.

To the neophyte who would become an adept there is no escape from much work. Attainment is ever at the cost of persevering effort. But handled without unnecessary tension the amount of work involved in arriving at this exalted state, or that involved in the active, useful life of a Master, need not seriously deter any earnest aspirant; for as progress is made, the ability to work long and with more speed without fatigue gradually develops. The relaxed body not only becomes accustomed to maintaining swift activity, but there is an increasing joy and satisfaction felt in such activities.

Utilizing the Occupation

—Even among those who set their feet resolutely upon the path leading to adeptship, all too often the occupation is regarded as a necessary evil, endured in order to make a living. In many cases this attitude is due to the circumstance that the individual cannot make a living at the things he is best fitted to do. That is, the occupation which economic conditions force upon him is not the one for which he is really fitted. It is not along the line of his real cosmic work.

Yet almost every occupation which men are forced to follow offers constant opportunities for character development and for the expression of the spiritual side of the nature.

The neophyte will find it excellent discipline for a higher type of work to leave no stone unturned to discover the advantages and pleasures which can be associated with the occupation. This does not signify that he should not try to find an occupation more suited to his ability and temperament; but that, so long as conditions make it advisable to follow a certain occupation, this circumstance offers him a training school for developing the pleasure technique.

And in any such occupation there is always opportunity to develop self-expression. Even in routine work, which appears to be but drudgery, one can exercise ingenuity to perform it in ways which, more and more completely, will give expression to the soul's desire to accomplish what it does in the best possible manner.

A little more skill can be developed, lost motion can be avoided, just the proper amount of energy applied to get the best results. Almost nothing is done in the best possible manner, and the effort to improve the methods and manner of work builds factors into the character which, even in the after life, will prove advantageous; for our attitude towards conditions in the future is determined by our attitude towards the circumstances we meet before we reach the future.

Furthermore, in addition to using one's occupation to practice developing a permanent pleasure technique, which may be used in meeting obstacles of the future, and in developing a constructive and progressive attitude, which will become an integral part of the character, the occupation also presents the opportunity to develop refinement, and this means acquiring spirituality.

Almost anything can be handled in not merely a way which gives better practical results, but also in a way that in some manner calls forth the finer emotional nature. A flower on an office desk adds an element of taste. An extra polish on a machine appeals to the sense of sight and touch pleasantly. Clean cut work, just the proper amount of embellishment, the development of harmony among those with whom one must work, all lend themselves to a richer type of existence. There are few lives but that could be lent an element of grace and beauty. Anything that removes the sordid and replaces monotony with constructive pleasure is in the direction of the spiritual. And the neophyte can grasp the opportunities thus presented and use them for his spiritual gain.

Think Only the Truth

—One of the most disastrous habits is that which psychologists term rationalizing. It is not, as at first might be thought, the applying of reason to discern the full and unvarnished truth; but is the process of finding a plausible reason for believing that to be true which one desires to be true.

It has become an axiom among those who apply themselves to the exactitudes of material science that the reports of a researcher along some particular line can usually be accepted unless the results of his research in some manner have a bearing upon his personal life. When the personal habits and desires, such as the religious beliefs, customs in eating, personal liberty, or the hobby of the scientific man is in any way affected by his findings, other scientific men feel at once called upon to challenge his findings. If you wish an example of this unconscious warping of facts, read the carefully compiled, yet completely contradictory, reports of the medical profession on the effects of tobacco and alcohol on the health.

Your college professor may stoutly affirm that astrology is an “exploded science,, even though he has never set up a birth-chart and does not know how to do so, because he feels that astrology, in some manner deprives him of free-will. He does not wish to think that his life is all mapped out for him at birth, and that he has no power to determine his own future. And while astrology really only maps inner-plane weather, and makes no such claims, yet the popular idea of it, which the professor has imbibed, is that it signifies fatality. Consequently he thinks he rejects it because other scientific men have investigated it, but in reality he rejects it because he has a strong aversion to being shoved about like a machine by the stars, and he thinks astrology teaches just that.

Of the many things that come to mind which are thus rationalized I shall, by way of illustration, call attention to but one other. It appeals to the most powerful of all urges within the human constitution, the power urges; to those urges which express self esteem, or when exaggerated, express colossal egotism.

The desire to be important is not destructive. It is a fine impulse. But the desire should be to be really important through accomplishment for the good of all, and not to wallow sentimentally in an unearned and unreal sense of importance.

The very highest position in the cosmos is occupied by the Super-Intelligence directing it Whom we term God. Therefore the highest flattery an individual can imagine is to believe himself to be God. And the highest tribute to his colossal egotism others can give him is to pretend to believe he is God. Kings of old demanded such homage from their subjects; and through mantrams and affirmations and the rationalizing of philosophy, certain present-day individuals come to believe themselves to be God.

The affirmation, or mantram, “Be Still and Know That I Am God...” may be construed by the use of a comma as merely drawing the attention of God to the individual. But many persons interpret it, and come to believe, that they are God. And what could please their egotism more than to believe that they are the rulers of the cosmos. The ego of man has divine potentialities. Through the development of its twin souls it may evolve and control, in the illimitable future, a whole universe. But, even so, there will be other universes. And over all, directing all, still will be the Super-Intelligence Whom we call God. Man is not God, and will never become God.

However, God has a Great Plan which is in the process of development, and the soul of man has the power of uniting itself with the intelligence directing this Great Plan. To the extent that the soul can thus enter into the consciousness of the cosmic intelligence it can unite itself in consciousness, and in effort, with God. It does not thus become God, but it unites itself with God through tuning in on the highest level of spiritual intelligence it can reach. And it does participate in divine powers and attributes through tapping such an exalted reservoir. This truth is good enough.

Any falsehood accepted by the unconscious mind impedes progress; because before the soul can make proper adjustments it must have a clear conception of the real conditions. And the real truth, when the neophyte digs down beneath the rubbish of appearances, will be found amply satisfying. He will find also that it is a bad thing to lie to anyone; but quite disastrous to lie to himself.

At all times, and under all circumstances, let him seek the raw truth. His desires, his previous learnings, his emotional reactions, all will from time to time try to varnish and sugar-coat the real facts. But as he can act to best advantage only when guided by the unembellished truth, he should ever seek to discern it as it actually is.

Chapter 6

Serial No. 221
Original Copyright 1949
Elbert Benjamine

Copyright
August 2002
Church of Light

How To Keep Mentally And Physically Fit

Good Food Sources of Essential Vitamins

Vitamin A: butter, eggs, cheese, green leaf vegetables, carrots, sweet potatoes, apricots, fish liver oils, yellow corn, green peas, parsley, okra, green peppers, tomatoes, string beans, celery, watercress, yellow squash, avocado, mangoes, papayas, peaches, oranges and pineapple.

Vitamin B-1: yeast, wheat germ, rice bran, rice polishings, whole milk, whole grain bread, whole grain cereals, peas, beans, eggs, nuts and soy beans.

Vitamin B-2: milk, cheese, eggs, peanuts, peas, kale, mustard greens, turnip greens, rice polishings, wheat germ, whole grain, buttermilk, molasses, kale, beet greens, soy beans and yeast.

Vitamin C: lemons, oranges, limes, grape-fruit, tangerines, tomatoes, tomato juice, raw cabbage, watercress, strawberries, peppers, broccoli, radishes and cauliflower.

Vitamin D: expose the skin to sunlight or ultra-violet radiation.

Vitamin E: wheat germ, other grain seeds, seed germ oil, green leaf vegetables, milk, eggs, butter and cheese.

Chapter 6

How To Keep Mentally And Physically Fit

ANY job can be done more effectively if the tools which must be used in doing it are in good shape than if those tools are defective. And this applies to machine tools quite as much as to hand tools. On earth each individual has certain functions to perform. And the machine tools he must employ in doing whatever his work may be are his mind and his body. He can do his work to best advantage only if his mind and body are kept in first rate condition.

His mind resides on the inner plane. It consists of all his past experiences, including those before he was born into human form. It not only embraces whatever knowledge he may possess—and upon this knowledge depends his ability—but also the way past experiences have been organized as harmonious or discordant thought-cells, and the dominant vibratory rate which determines the inner-plane level on which it functions and thus his spirituality.

The physical body, including the brain, resides on the outer plane. It embraces various types of physical tissue, various organs, and the way they are related to each other which determines their degree of coordination. And while some things are accomplished by the psychokinetic and non-physical power of the mind, the accomplishment of each person on earth in large measure depends upon the thoughts which through the brain reach objective consciousness, and that which the body does, which is termed behavior.

The mind, which is one machine tool, and resides on the high-velocity inner plane, is attached to, and functions through the other machine tool, the body, by psychokinesis. This ability to function through such a complex form by means of the non-physical power of the mind has required the long training of evolution, during which the mind has, step by step, through being attached successively to higher lifeforms, developed the necessary knowledge and psychokinetic power.

Neither of the machine tools, on which each individual must depend for both accomplishment and the events which enter his life, is perfect at his birth. He has to learn physical coordination in order to walk, in order to talk, and in order to do more complex physical things. And in addition, the physical tool must be given proper foods and a congenial environment if it is to be kept healthy, and thus able to do effective work.

And to direct his physical machine properly, he must gain knowledge and store it for future use in his inner-plane tool, the mind. Furthermore, this inner-plane tool, to be properly effective, must also receive training and proper foods. The discords in it, the thought-cells which use their psychokinetic power to attract misfortune, must be trained to have different desires. To that end they must be reconditioned. As the food of the mind are mental states, and as the health of the body and the events which come into the life are profoundly influenced by the health of the mind, or soul, it is fully as important that the mind shall be given proper thought nourishment as that the body shall be given proper physical nourishment.

Certain factors of the outer-plane environment, such as heat and cold and the outer-plane weather in general, affect the physical health. And certain factors of the inner-plane environment, such as the inner-plane weather mapped by astrology, affect the mental health. One needs different physical food when the outer-plane temperature is below zero than when it is 100° in the shade. And one needs different mental food when cold Saturn dominates the inner-plane weather than when Mars raises the temperature of the inner-plane weather so high that anger tends to burst into flame on the slightest provocation.

As the condition of the outer-plane machine markedly affects the condition of the inner-plane machine, and as the condition of the inner-plane machine markedly affects the condition of the outer-plane machine, it is important that each be given the particular foods which are indicated by the birthchart as most needed, and that each be given the foods that during specific periods the outer-plane weather and the inner-plane weather indicate are needed to put these two machine tools, which the soul must use, in as good running condition as possible.

Because the individual is not born until the inner-plane weather corresponds in general to his inner-plane, or thought-cell organization, his birthchart indicates along broad lines the types of mental food needed to put his mental machine in good running order, and the types of physical foods needed to assist the mental machine put his physical machine in good running order.

While some of the physical foods that agree or disagree with him must be learned through experience, in the following four lessons are pointed out certain physical foods and certain mental foods that are especially and urgently needed if in his chart a given planet is heavily afflicted. The chart of birth shows the PREDISPOSITION toward diseases of a particular type. The most powerful and most discordant planet in the chart of birth shows the type of disease toward which he has the strongest predisposition. The next most powerful and discordant planet in the chart of birth shows the type of disease toward which his predisposition is next strong, and so on.

The birthchart constants of 160 different diseases are given, as statistically ascertained from the analysis of the birthcharts of those who have experienced the disease, in course XVI, Stellar Healing. It is well to become familiar with these constants so that the diseases toward which one has a predisposition can be known, and precautionary actions taken that will prevent these diseases from ever developing. These precautionary actions in particular embrace both the physical and the mental diet advocated in the following lessons when the planets which are the constants of the disease are afflicted.

But in addition to knowing the birthchart constants of the diseases toward which he has a predisposition, each neophyte should know what progressed aspects always coincide with the development of the diseases toward which he has a predisposition. These are set forth in relation to each of the 160 different diseases considered in Course XVI, Stellar Healing. And before these progressed constants are within one degree of perfect, and during the time they are within the effective orb of one degree of perfect, he should take special pains to follow both the mental and the physical diet advocated in the following lessons for afflictions of each planet involved.

Furthermore, even though a planet heavily afflicted by progressed aspect is not a constant for a disease toward which he has a predisposition, while the progressed affliction is within the one degree of effective orb, he should use both the mental and the physical diet indicated. In that way he will not only do much to prevent the progressed affliction from decreasing the efficiency of his two machine tools, but he will mitigate the severity of the events that otherwise are likely to come into his life during this period.

Thus to use the mental and physical diets best suited to keep both machines in good running order, he must not only be familiar with his birthchart, but must keep on file for frequent consultation the record of all major progressed aspects for some time in the future. And if he also notes the shorter periods when his major progressed afflictions are reinforced by minor progressed aspects to one of their four terminals, and released by transit aspects to one of their four terminals, he will be in a position to be especially careful to have the proper mental and physical diets, and to use other precautionary actions during the shorter spells when they are most needed.

In addition to keeping aware in advance of the inner-plane weather conditions he will encounter, as revealed by his progressed aspects, and the specific mental and physical foods needed for those adverse, as set forth in the following four lessons, he should also make himself familiar with the general principles of a healthy diet, the function of each of the various types of food, the vitamins, and the importance of a proper alkali-acid balance as set forth in Lesson No. 153, Diet and Breathing.

Relative to the acid condition of the blood so frequently mentioned in lesson No. 153, and in Course 16, Stellar Healing, it is not implied that over fatigue, the eating of non-alkaline foods, a common cold, or even the toxins of contagious diseases cause the blood stream to develop true acidosis. Acidosis is a serious disease, and the individual having it is quite ill. It is given consideration in lesson No. 203.

But muscular exertion causes lactic acid to be liberated in the blood, tissue metabolism adds other acids to the blood, the toxins of the waste material of the life processes of invading organisms, when these are present, add still further acids to the blood. For the individual to remain healthy the blood stream must constantly remain slightly alkaline. Adrenaline, cortin and thyroxin by chemical combination with them neutralize these acids of the blood, and it is the function of the kidneys to filter such acids out of the blood stream. The alkali residue of non-acid producing foods neutralizes the acids in the blood, and thus takes much of the burden, which may otherwise become too great, of neutralizing the acids off adrenaline, cortin and thyroxin, and also relieves the kidneys of too great work.

Not only are fruit juices and vegetables juices excellent sources of vitamins and minerals, but they should be used in colds, fevers and contagious diseases to neutralize the acids of the blood. Often the adrenaline, cortin and thyroxin supply in such cases and the filtering ability of the kidneys, are unable effectively to handle the acids unless they receive assistance from alkaline producing foods. And until the acids of the blood are thus neutralized or eliminated the illness remain serious.

A glass of citrus juice 30 minutes before breakfast, under normal health conditions, is good to assist the assimilation of calcium from the breakfast. and as a laxative. But it should be remembered that the juice should be squeezed fresh from the fruit just prior to drinking, as experiments have demonstrated that the vitamins and minerals of juiced fruits are destroyed by oxidation within half an hour by exposure to the air.

Chlorophyll

—Green leaf vegetables, such as asparagus, lettuce, broccoli, endive, mustard greens, water cress, parsley, and turnip greens, as well as green peas, green string beans and green lima beans, contain the green coloring substance called chlorophyll. Without chlorophyll neither plants nor animals could live on earth, for by photosynthesis it is able, in the presence of light to convert the carbon dioxide of the atmosphere and the water of the soil into the carbohydrates. These form the chief substance of plants, and animals and plants possessing no chlorophyll must depend on the chlorophyll possessing plants to manufacture the carbohydrates for them; for these are the chief fuel foods, and neither plants nor animals can live without them.

In addition to its unique function of manufacturing the carbohydrates (starches and sugars, ruled by Venus), chlorophyll is a good source of vitamin A, vitamin B, and the blood-clotting vitamin K. And chlorophyll possessing vegetables eaten daily—preferably some raw in a green salad, plus one cooked—give more abundant energy than can be obtained from non-green vegetables plus synthetic vitamins. According to Dr. Boris Berkman, in a statement before the 13th annual meeting of the National Farm Chemurgic Council at Omaha, Nebraska, on March 13, 1948, in addition to possessing the power of photosynthesis, chlorophyll is a most powerful oxidation catalyst. He believes it increases the oxidation of the cells of the body and thus gives them additional life. Said he further:

“As the ravages of old age are due mostly to decreased capacity of the cells and a slowing down of the metabolism process, this introduction of the most powerful natural oxidation catalyst would benefit humans by slowing down the degenerative changes occurring with age.

Fresh green salads in which sliced avocados or unpared sliced green cucumbers may be added to the other green vegetables and sliced ripe tomatoes, are good for vitality and to assist proper elimination.

Cooking

—There is a tendency on the part of most to overcook foods. Vitamin B-1, a nerve necessity, is destroyed by long exposure to heat. Roast beef and beef which is stewed an hour or more thus loses more than one-half its vitamin B. All 12 of the factors embraced in vitamin B Complex, including B-1 and B-2, as well as vitamin C, are water soluble. Therefore, in addition to the destruction caused by heat, when they are boiled in considerable water over some time the vitamins are removed from the vegetables by the water. Then, when the water in which the vegetables are cooked is thrown away, these vitamins and the mineral salts which also are essential to health and have been removed in the water, are lost.

Vegetables should be selected for their freshness and quality. They should be prepared in a manner that will preserve not only the vitamins and minerals, and as much of their electromagnetic energy as possible, but also their natural delicate flavor. To do this, fresh vegetables should never be soaked in cold water before cooking, and tuber vegetables and fruits should be cooked in their skins, and thus served; as both vitamins and minerals are most abundant next to the skin.

The cooking time must vary with the vegetable. The more cellulose it contains the longer it needs to be cooked, but most can be cooked properly within 4 to 12 minutes. Fresh vegetables should be cooked in from one-fourth to one-half cup of boiling water. To prevent the minerals and vitamins being leached out, drop the vegetable in boiling water. Cook no longer than necessary, and thus preserve the minerals, vitamins, the electromagnetic energy, and the appearance and flavor which makes it unusually appetizing. Any salt for seasoning should be added after the vegetable has reached the table.

Vitamin A, vitamin D, vitamin E and vitamin K are fat soluble. And their value is impaired if the fat, such as butter or fish liver oil, becomes rancid.

Influence of the Foods Upon the Emotions

— To recondition the thought-cell organization of the finer form it is necessary to be able to induce appropriate emotions; for it is the feeling which accompanies thoughts which determines whether they build harmonious or discordant thought-cells with their thought-elements. And it is the psychokinetic activity of thought-cells that brings most events of consequence into the life.

When the nerves are lacking in calcium, or the parathyrin supply is so low that little calcium is handled, the individual tends to be highly sensitive to the slightest discord or hindrance. In spite of all his efforts he may be highly irritable. And when there is an over abundant release of adrenaline, he may be unreasonably aggressive, abrupt and quarrelsome.

When there is insufficient cortin secreted, he may become so fearful that he is unable to keep from being a coward. And when the pineal hormone secretion is excessive in proportion to adrenaline and cortin, he may be negative and effeminate in his reactions to the conditions which arise. And each of these glandular conditions which result in undesirable emotional reactions is influenced not merely by the inner-plane weather mapped by astrology, and by the individual's efforts to direct his thinking, but also by the physical foods he eats.

In lesson No. 222 we give an illustration of the effect of foods on the emotions in the life of Gandhi. But it should be recognized that, due to the different body chemistry as revealed by their charts of birth, people react quite differently emotionally, intellectually and physically to the same type of diet.

Relative to intellectual reactions the charts and lives of two men, George Bernard Shaw and Herbert Spencer, both of whom have accomplished a tremendous amount of mental work, may be cited. Shaw (chart in lesson No. 106), who at this writing (1949) is 92 years of age and still turning out good literary work, has been a strict vegetarian. He has a brilliant wit, is a dramatist and an idealist. His plays have been immensely successful. Neptune, which stimulates the pineal secretion which makes the handling of proteins, and especially meat, very difficult, is unusually powerful. It is elevated, semi-square Pluto, sextile Moon and Uranus, square Asc., trine Mercury, and sesqui-square Sun and Venus. Also Mars, the planet of meat, is in his house of illness (sixth).

Herbert Spencer (chart in lesson No. 220) turned out an equally tremendous amount of mental work. He wrote a synthetic philosophy embracing the findings of science in all its various branches. Although he had Neptune trine Sun and sextile Moon, which with Uranus rising made him so sensitive that he had a sound proof room built in which to write, and which induced him to try to live on a vegetarian diet, in this he was unsuccessful. Mars in the seventh square Sun, and the Moon in the Mars sign Scorpio, opposition Sun, made it impossible for him to generate enough energy to do good work on a vegetable diet. He gave it a thorough trial for a year, but was compelled to destroy and rewrite all he had written while living without meat, because it lacked clearness and the customary vigor.

Vitamin B Complex

—B Complex is now known to consist of at least 12 separate factors, 10 of which have been obtained in crystalline form. As some of these factors are highly important, and have been discovered only recently, it seems well here to discuss them briefly and thus bring the knowledge of vitamins up to date.

Thiamin hydrochloride, commonly known as B-1, is a white crystalline substance readily soluble in water. In the dry form it is quite stable and is not readily destroyed by oxidation. But its activity is readily destroyed by sulfite, which probably explains its loss during the sulphuring of fruit. It also is rapidly destroyed in dehydrated meats and vegetables, when the moisture is about 5 per cent. Beriberi is primarily due to an insufficient supply of thiamin. It is essential for nerves and brain.

Riboflavin, once called vitamin G, but now called vitamin B-2, is a practically odorless orange-yellow crystalline compound which is water soluble. It is rather heat stable, but deteriorates rapidly when exposed to light. Its deficiency results in pellagra. It is essential to the thymus gland and the proper production of lymphatic cells.

Nicotinic acid, once called vitamin P-P, occurs as white needle-like crystals. Due to the similarity in sound to nicotine, the acid is commonly referred to as niacin and the amide as niacin amide. Its deficiency gives rise to pellagra. Corn meal and patent flour contain from 1 to 1.5 mg. per 100 Gm. of this vitamin, and to meet minimum requirements one would have to consume 1,000 Gm. which is impossible, and indicates why those living on such food develop pellagra. By way of contrast, wheat contains 5 to 7 mg. per 100 Gm. and is a reliable source of this vitamin. But in milling ordinary white flour 80 to 90 percent is removed. One serving of liver will supply the daily allowance, and one serving of lean meat will supply over half the daily requirements.

Pyridoxine hydrochloride, once known as vitamin B-6, is a white crystalline powder, odorless and slightly bitter to the taste. Its deficiency leads to acrodynia and retarded growth in rats, and to hypochromic anemia in dogs.

Pantothenic Acid, is fairly stable when subjected to moist heat, but is destroyed by prolonged dry heat.

Its deficiency in chicks leads to a typical dermatitis, in rats to poor growth, necrosis of the adrenal cortex and graying of the hair, in dogs to sudden collapse associated with changes in the blood content.

Choline, is a colorless, viscous fluid. Its function has to do with the mobilization of fatty acids in the body. Young rats on low choline diets develop renal hemorrhagic degeneration and deposition of fat in the liver.

Biotin, apparently functions in making certain chemical changes in the body, but little is yet definitely known about it.

Inositol, is a crystalline substance with a sweet taste. That it is essential in animal nutrition has been established, but beyond that little is yet known.

Para-Aminobenzoic Acid, seems important in metabolism, but nothing about it is as yet definitely known.

Folic Acid, is a yellow compound sparingly soluble in water. It has been used with great success in the treatment of anemia and pernicious anemia.

B-10 and B-11, are so closely related to folic acid that new techniques must be developed to determine their functions.

B-12, is a crystalline compound which has been isolated from livers. It is highly active in patients with Addisonian pernicious anemia. But its function and possible value must await experimental work.

The High Mortality Diseases

—In the United States more people die of heart disease than from any other, next in number are those who die from cancer, third those who die of kidney disease, and fourth those who die from cerebral hemorrhage.

Cancer needs to be considered separately, as its relation to these other three diseases is not plain. It is given detailed discussion based upon the statistical analysis of the birthcharts of 100 people who had cancer, in the reference book *Body Disease And Its Stellar Treatment*. It is evident that diet may increase the predisposition toward the development of cancer, and that negative thinking precedes its development. There are cancer clinics now in the larger cities, and people should understand that if they go to such a clinic early enough that cancer can definitely be cured.

While at first glance it might seem that each of the other three diseases had little bearing on the other, a little closer scrutiny reveals that the underlying cause of each may be quite similar and that the disease which finally results in death in many instances may be due to which is the weaker, the heart, the kidneys or the blood vessels.

As in time, with our present knowledge, no matter how well an individual regulates his physical diet, his mental diet, and the other circumstances of his life, an individual finally loses his physical body, and as these three diseases tend to develop with age when the physical machine begins to wear out, in order to prolong health and life on earth and thus add to one's usefulness, it seems well to know why so many people as they advance in years succumb to one of these three diseases, and what are the best precautionary actions to take relative to each of them.

According to the American Heart Assn. Inc., three times as many people die from heart trouble as from cancer, and eleven times as many as die from tuberculosis. In 1948 it stated 3,700,000 Americans were victims of heart disease, and the same number suffered from arteriosclerosis (hardening of the arteries) and high blood pressure (hypertension). These two difficulties together also cause more chronic illness than any other single disease. Hypertension not only contributes to heart difficulties, but as will be explained, it contributes markedly also to kidney trouble and cerebral hemorrhage. As a common contributing factor to three of the four most common causes of death, it needs careful consideration.

Kidney Trouble

—Starting with kidney difficulties, let us try to get a general picture of why so many people die from heart disease, kidney trouble or cerebral hemorrhage. The upper part of the kidneys is ruled by Venus and the lower part is ruled by Mars. The tissues of the body are bathed in fluid. The life processes of the body call not merely for a constant burning of fuel through combination with oxygen, but also a gradual destruction and replacement of tissue cells.

The by-products of these processes are picked up by the blood stream. Most of the carbon finds its way into the open air through the mucous membrane of the lungs. But the other toxins, especially the acids, irritate the mucous membranes. The pores of the skin allow some of them to be eliminated, but the kidneys must remain chiefly responsible for filtering these toxins and acids from the blood stream. And the blood stream must get rid of them; for if its normal chemical composition is changed in any marked degree the individual becomes seriously ill. Thyroxin, adrenaline and cortin all act to neutralize the acids in the blood stream so that it can retain its normal chemical composition without placing too great strain on the filtering power of the kidneys.

Under ordinary circumstances one healthy kidney can filter the toxins from the blood stream with sufficient efficiency to keep the individual in fair health; but if both are removed or incapacitated the individual cannot get rid of the poisons which gather in the blood stream and he soon dies.

It takes cortin properly to handle the proteins; and when there is too much protein in the foods it places too great a strain on the cortin supply and on the kidneys. Alcohol is very hard on the kidneys. Some, with unusually strong kidneys, drink to excess all their lives and live to a ripe old age. But it is far more common to find kidney trouble developing in those who have drunk heavily and steadily over the years. This applies in less degree to those who go on periodical drunks, and do not touch liquor in between sprees, than to those who never are drunk, but consume alcohol daily just up to the point where it noticeably affects their behavior. A system thus saturated with alcohol must have unusual kidneys not to deteriorate when they are constantly called upon to filter so much alcohol and its by-products.

Some people also can apparently handle an almost unlimited amount of the uric acid of red meat; but other people, with weaker kidneys, find either much red meat or much alcohol places too much strain on their kidneys, and if they continue to indulge in either kidney trouble develops.

The thyroid gland responds immediately either to Sun thinking or to Venus thinking. Under discordant Sun emotions or discordant Venus emotions thyroxin is poured into the blood stream. This tends to cause contraction of the arterial blood vessels, hindering blood flow, especially the flow to the kidneys. Thus do emotions which cause the release of considerable thyroxin contribute to kidney trouble and heart trouble; for without an ample blood supply the kidneys become depleted, and with arteries contracted the heart must work harder to force the blood through them.

The arterial system is composed of miles of elastic hose from about an inch in diameter to one-twenty-five-thousandth of an inch in diameter, reaching every tissue and every particle of skin in the body. The heart must pump blood continuously through these miles of elastic hose. They should expand to permit an easier flow. The pressure depends upon the power with which the blood is pumped(Sun) and the resistance offered by the elastic hose. The hormone of the thyroid gland stimulates the heart and contracts the blood vessels, and the hormone of the gonad glands does likewise through its action upon adrenaline.

Cortin, which responds directly to Mars thoughts, and adrenaline, which is secreted by thoughts of anger, irritation, the feeling of rush, worry, anxiety or fear, contract the arterial blood vessels and raise the blood pressure even more violently than does thyroxin. Then, after the kidneys have been debilitated through depriving them of blood, the person who chronically holds the attitude of emotional excitement uses up his thyroxin, and the person who keeps in a dither of irritation or anger uses up his adrenaline and cortin, and the person who gives way chronically to worry or fear uses up his adrenaline.

These are the three chemicals he must depend on to fight infection and to neutralize the toxins of the blood stream. The kidneys already have become impaired; but now they are called upon to filter out stronger acids. When such acids become too concentrated they attack the tissues of the kidneys, causing a sloughing of the membranes and their general disintegration.

The weaker the kidneys are the more quickly they thus disintegrate when called upon to filter too much acid. The region of the kidneys is mapped by Libra and Scorpio, Libra mapping the upper part and Scorpio the lower. Venus rules the upper part of the kidneys and Mars rules the lower part. Thus we find through statistical analysis of the charts of those who have had kidney trouble that its birthchart constants are a planet severely afflicted in Libra or Scorpio, or Venus or Mars severely afflicted.

To the extent such afflictions are shown in the birthchart are the individual's kidneys weak and predisposed to disease.

The progressed constants of kidney trouble are an aspect, usually an affliction, involving the planet in Libra or Scorpio, or involving Venus or Mars. One predisposed to kidney trouble, therefore, should take special precaution to keep his blood stream slightly alkaline, and to avoid emotional excitement, as well as to use the proper harmonious thoughts to neutralize the influence of the planet afflicted by progression, during periods when the progressed constants of kidney trouble are present.

High Blood Pressure

—Pituitrin from the back pituitary, secreted over abundantly in emotional disturbances affecting family life (Moon) also contracts the blood vessels, except those of the kidneys. And an acid blood stream irritates the lining of the vessels causing them to constrict. With age chemical imbalances may cause their walls to become coated with calcium and other deposits, making them brittle and raising the blood pressure.

It is now also believed that a high fat diet is related to hardening of the arteries. Both the arteries and fat are ruled by Jupiter. Recent investigation has shown that those suffering from hardening of the arteries (arteriosclerosis) have these hardened arteries coated with minute globules of fat which deprives them of elasticity. And it has been shown that arterial hardening is more common in fat, over nourished people than in lean under nourished people. Peoples who eat low fat, or almost fat-free diets, such as the Chinese and Okinawans, seldom have arterial hardening, and in Germany during the fat-shortage years following World War I, it decreased markedly.

The birthchart constants of hardening of the arteries are Jupiter and the upper-octave planets prominent and usually afflicted. Anyone with these constants in his chart of birth should keep his diet free from too much fat and other rich foods, so as not to develop the ketosis type of acid blood stream, which seems to make minute fat deposits on the arterial walls. And he should see that he has plenty of calcium, vitamin B-1, and vitamin D in his food so that he handles the calcium properly.

Hardening of the arteries, through reducing their elasticity raises the blood pressure. And, of course, emotional disturbances which release either thyroxin, adrenaline or cortin, cause the heart to beat more rapidly and the blood pressure to rise.

Relative to blood pressure, there are two, the systolic pressure created by the pumping force of the heart, and the diastolic pressure when the heart is at rest. The systolic pressure is the high one, and the one people with high blood pressure usually worry about. Under such pressure the brittle or weakened walls of the blood vessels may break, and if the break is in those of the brain there is a stroke, or apoplexy, resulting from cerebral hemorrhage. Such high pressure may also overwork the heart and bring about its enlargement and wear it down.

But high diastolic pressure is also important, for it seems often associated with degeneration of the tiny arterioles and damage to the kidneys.

Cerebral Hemorrhage

—The birthchart constants of this disease, which is fourth in the number of lives it takes, are Uranus prominent, usually an afflicted Mars, and commonly an afflicted planet in Aries. The afflicted planet in Aries, when it is present, maps thought-cell activities in the region of the head which gives a predisposition to diseases affecting this region in preference to some other. As Mars is the ruler of Aries, in less degree the afflicted Mars indicates the same predisposition. But the afflicted Mars also indicates that at times the cortin and adrenaline supply are either over active or deficient. As the progressed constants are an aspect involving Uranus, and an aspect involving Mars, it is the tendency of the thought-cells these two planets map that needs special attention.

Aspects involving Uranus are coincident with a type of electrification which gives the highest nerve tension of all. The electrical energies flowing over the nerves not only give a high degree of nervous excitement, but they are subject to abrupt and erratic changes. Under the influence of the Uranus thought-cells people often become unreasonably enthusiastic, or unusually emphatic, about conditions and events that other people take more matter of factly, for Uranus is the planet of extremes.

The danger from cerebral hemorrhage increases with age, because commonly the blood vessels are more brittle, or are weaker, due to age. And if they have been weakened by acids in the blood stream, or if they have become brittle through insufficient parathyrin to handle calcium, or if they have become inelastic through coatings of minute globules of fat, even a little sudden increase in the circulation may cause their rupture. If the rupture is in the brain, the pressure on the brain where it occurs usually results in a stroke in which some section of the body is paralyzed.

The precautionary action where such predisposition is indicated is through the diet to strengthen the walls of the blood vessels by not too much fat and rich foods, and by sufficient alkali residue foods. And to see to it that the calcium is properly handled through supplying it in the food along with vitamin D. Nor should B-1 be neglected, which is essential when Uranus is involved to keep the nerves stable. If the nerves become irritated it is more difficult to keep from high tension nervous states, and from experiencing emotion.

Excitement of any kind should be avoided, and undue strain, for thyroxin, adrenaline or cortin released into the blood stream increases the circulation and raises the blood pressure; and under excitement or strain one or more of these are thus released. And in addition the thoughts should be cultivated which are the antidotes of Uranus and Mars; harmonious Jupiter thoughts for Uranus, and harmonious Moon thoughts for Mars.

Heart Trouble

—Heart trouble is of various kinds, but for all of them three birthchart and three progressed constants are present; an aspect involving the Sun, an aspect involving Mars, and an aspect involving Venus. In some types of heart disease other constants are present. In coronary thrombosis, for instance, both in the birthchart and by progression, either Neptune or Pluto, and often Jupiter, is involved. And in valvular trouble resulting from rheumatic fever, Saturn is involved at the time the fever develops.

The Sun rules the heart, therefore it is not surprising the thought-cells it maps are always involved in heart difficulty. And the thyroid gland responds to either Sun thought-cell activity or to Venus thought-cell activity. It is the gland of energy production, and has a direct effect upon the speed of metabolism. The more of its secretion, thyroxin, there is in the blood, the more fuel is consumed and the faster one lives. And the faster one lives the more work the heart must do. Through their power to release thyroxin, and thus affect the amount of work the heart must do, both the Sun and Venus have a direct relation to heart difficulties.

Mars rules the muscles, and as the heart is the most important muscle of the body, it is influenced by Mars. But also two other hormones of energy production are released by Mars thought-cell activity; adrenaline, the hormone of emergency energy, and cortin, the hormone of courage. These not only speed up the heart action, but they also contract the blood vessels and thus contribute to the most common form of heart trouble, that which accompanies hypertension (high blood pressure).

Coronary occlusion, or thrombosis, is another form of heart trouble. A clot forms on an artery in the heart, or moves there from some other region, and increases in size until it blocks the flow of blood. 20% of the people to whom this happens die within a few hours. In other instances the clot moves on, but usually scar tissue forms which decreases the efficiency of the heart.

Rheumatic heart, which so often leaves a murmur, is due to this infection of the heart muscle by the organism which causes rheumatic fever. It attacks the heart, destroying considerable muscle and injuring the valves. With defective valves, the heart has to work too hard to keep the circulation normal, and may wear out and collapse.

Hardening of the arteries causes them to become smaller and less elastic. Unless the blood pressure is raised to compensate for the smaller aperture through which the blood must move, not only other organs, but the heart also, receives too little nourishment. Thus starved, scar tissue forms in the heart and cuts down its effectiveness.

I suppose I should also mention the common term angina pectoris. This consists of stabbing pains which indicate the heart is not getting enough blood. But instead of itself being a specific disease, it is a symptom which makes known a condition of the heart which may result from any of the four heart diseases mentioned. About half a million Americans die of heart trouble each year. In those cases where Neptune, Pluto, Saturn or Jupiter is a constant, both the mental and the physical diets should also be used which are the precautionary measures for afflictions involving these planets. But for heart trouble in general, it is clear enough that the physical diet should be such as to keep the blood stream properly alkaline—for acids in the blood cause the blood vessels to contract—and that it should not contain too rich foods or too much fat to coat the blood vessels with small globules and thus harden them. The blood vessels should be kept elastic, so the heart will not be overworked in forcing the blood through them.

The diet should contain the Sun requirements; iodine for the thyroid, and manganese, vitamin B Complex and vitamin A. It should contain the Mars requirements, to keep the muscle healthy and to keep it from being undernourished through impoverished blood. These requirements are vitamin A, vitamin B-1, vitamin C, iron, and not too much protein, but ample variety of protein. And it should contain the Venus requirements; vitamin A, iodine for the thyroid, copper for the blood, and vitamin E.

As this is written there is a big controversy in the medical profession as to the effectiveness of vitamin E in restoring heart patients to health. But in nearly all the functions in which either Mars or Venus takes part the other in some manner cooperates. Vitamin E is the most important Venus vitamin. It is believed to exercise control of oxidation of the tissues. And as both Venus and Mars are constants of heart trouble, it seems the part of wisdom for those with a predisposition to heart difficulty, and those suffering from it, to see to it that they get abundant vitamin E.

Of course, physical foods are only the minor half of the problem of preventing heart disease. The major half of the problem lies with the inner-plane, or thought foods.

As emotional excitement of any kind tends to release one or more of the hormones into the blood which contracts the blood vessels and thus causes the heart to overwork, calm and harmonious thoughts should be cultivated to replace worry, fear, anger, irritation, sorrow, and any thoughts which tend toward excitement. Domestic problems should not be permitted to cause discordant thoughts.

Not only should the thoughts and feelings be kept such that no excessive amount of pituitrin, thyroxin, adrenaline, or cortin will be released into the blood to increase the circulation or contract the blood vessels; but harmonious Sun thoughts should be cultivated. Instead of disappointment and dissatisfaction with the significance attained, and placing oneself under pressure to gain more significance, when one has done his best, and without too much strain, he should cultivate a feeling of satisfaction in it. This will recondition the Sun thought-cells to seek more harmonious expression.

For the Mars thought-cells, whenever anger, irritation, lust, the feeling of antagonism or the tendency to strife, undue haste, or undue expenditure of energy begins to be felt, the individual should turn his thoughts pleasantly to some project having to do with the comfort of his family, or which contributes to the welfare of the aged or young or those otherwise helpless. This will divert their psychokinetic power into more healthful channels.

For the Venus thought-cells which tend to cause undue emotion; when emotions start to develop, harmonious Saturn thoughts should be brought into the mind to displace them. For this purpose there can be used thoughts of caution, of system and forethought; the recognition that permitting emotion of any intensity or excitement of any kind is unwise, and quite unnecessary to live a long and happy life. Such thoughts thus applied will modify the Venus thought-cells and cause them to work for health and other beneficial things.

Chapter 7

Serial No. 222
Original Copyright 1949
Elbert Benjamine

Copyright
August 2002
Church of Light

What To Eat When Mercury Or Uranus Is Afflicted

Best Sources Vitamin B-1.

Approximate International Units per oz. of Fresh Food

Whole Wheat Bread 325	Fresh Soy Beans 50
Rice Polishings 300	Dry Lima Beans 50
Wheat Germs 300	Brown Rice 45
Brewer's Yeast 190	Graham Flour 42
Dry Soy Beans 140	Rye 42
Pork 110	English Walnuts 42
Smoked Ham 110	Green Peas 40
Pecans 110	Dry Navy Beans 40
Dried Cowpeas 90	Baker's Yeast 35
Peanuts 75	Egg Yolk 35
Beef Heart 65	Black Walnut 32
Hazelnuts 65	Dried Skim Milk 30
Oatmeal 65	White Corn Meal 30
Dry Lentils 55	Green Lima Beans 30

Best Sources of Calcium in Foods In Percentage of the Edible Portion

Hard Cheese930	Pecans089
Mustard492	Walnuts089
Outer Cabbage Leaves429	Dandelion084
Turnip Tops347	Cottage Cheese082
Hazelnuts287	Celery078
Broccoli Leaves262	Dried Peas077
Molasses258	Okra072
Almonds252	Dried Lima Beans . . .072
Soybean Flour216	Dates070
Collards202	Loose Leaf Lettuce . .069
Kale181	Peanuts067
Dried Figs161	Brown Rice065
Watercress157	Eggs063
Dried Beans148	Entire Rye061
Egg Yolk135	Parsnips060
Clams123	Raisins060
Olives122	Dried Coconut059
Cauliflower122	Dried Prunes058
Cow's Milk118	Leeks058
Maple Syrup107	Turnips056
Dry Lentils102	Limes055
Beet Greens094	String Beans055
Chocolate091	Whole Wheat053

Chapter 7

What To Eat When Mercury Or Uranus Is Afflicted

**MERCURY OR
URANUS
AFFLICTED**

CALLS FOR

**CALCIUM,
VITAMIN B-1,
AND VITAMIN D
OR SUNLIGHT**

MAN is a two-plane organism whose outer plane body is composed of physical cells and structures and whose inner-plane body is composed of thought-cells and thought-structures. He is influenced about equally by his outer-plane environment and by his inner-plane environment. Heat and cold, rain and wind, food and people and inanimate objects affect his physical body; and his states of consciousness coincident with such physical responses in turn add energy to and somewhat change the thought-cell organization of his finer form.

A great deal of carefully checked observation indicates that the inner-plane weather mapped by progressed aspects affects him as much, and probably more, than the outer-plane weather. The thoughts of people and of inner-plane entities, and the inner-plane radiations from objects also add their energies to certain groups of thought-cells within his finer form, giving them greater activity than usual, and thus enable them through his electromagnetism profoundly to influence his physical body.

One of the means through which the chemistry of the physical body is so quickly altered by such thought-cell activity is the system of endocrine glands, ruled by the Sun. These are the glands of internal secretion. They manufacture complex compounds called hormones from materials, chiefly the proteins, which they get from the blood and lymph. Each endocrine gland manufactures its own hormone or hormones, which differs in chemistry and function from the hormones manufactured by the other glands. These hormones are not emptied into a duct which carries them to the region to be influenced, but instead are liberated directly into the blood stream. That the hormones may thus find easy access to the blood stream, and through the blood stream to the region to be affected, the endocrine glands usually have a rich supply of blood vessels.

Now the activity of any endocrine gland may be stimulated by a thought or emotion, by the thought-cell activity within the soul accelerated by the energy of a progressed planetary aspect, or by the hormones of other endocrine glands. Their ready response to conscious thought, or to unconscious thought-cell activity inaugurated by a progressed planetary aspect, is accomplished by nerves which carry electrical impulses to the glands. Yet it has only been since 1936 that nerve currents have been recognized by science to be electrical, and only since 1922 that science knew anything about the control the endocrines exert over the body.

When, influenced by thought, emotion or thought-cell activity the hormone of a gland enters the blood, it is carried along in the general circulation and distributed to all parts of the body. All the cells and tissues are bathed in the fluid carrying it, and some cells and organs and other glands respond to it in a marked way, even though distantly located in the body.

Among other things these glands—each of which is delicately responsive to the thought-cell activity inaugurated by the energies of one or more specific planet—determine the size, shape and texture of the body; make for intelligence or its lack; give courage or cowardice; imbue with ambition or saturate with laziness; prompt to moral actions or to those immoral; and in general force the given outlook upon life. And they determine the chemistry of the body at a given time, and therefore just what foods are needed to keep or restore health.

I do not wish to be understood as implying that progressed aspects alone are instrumental in accelerating specific glandular secretions. Thought-cell activity such as is ruled by any planet can be increased by appropriate conscious thinking. Conscious thinking is boundary-line thinking, imparting some of its energy to corresponding thought-cells within the soul, and some of its energy more directly by means of nerve currents to the glands. Also heat or cold, and the foods taken into the system, act from the outer plane to increase or depress glandular activities. What I do wish to state is that, regardless of the cause of glandular activity, the hormones they secrete chiefly determine the chemistry of the body and therefore what it needs at a given time in the way of food.

Not only so, but because each endocrine gland is so responsive to thought-cell activity of the type ruled by specific planets, its tendency to be influenced from normal at times which can be predetermined is mapped by the progressed aspects of the planets which have energy of the type to which it responds. And because the prominence and aspects of the planets in the birthchart map the relative amount of thought-cell activity of the various kinds at birth, the general predisposition of the individual to over or under activity of certain glands may be ascertained from the chart of birth.

Not only do some of the endocrine glands secrete more than one hormone, or chemical messenger, but several of them respond with almost equal alacrity to types of thought-cell activity ruled by more than one planet. Not all of the hormones of these glands have as yet been isolated, and the front pituitary which a few years ago was considered to secrete only one hormone, is now known to manufacture not less than twelve; even as vitamin B also in the meantime has been found to comprise many vitamins, twelve of which have now been discovered, the whole of which are now known as vitamin B complex. Long and close observation by The Church of Light Astrological Research Department relative to the effect of progressed aspects and birthchart prominence on hormone activity has established that each of the planets through birthchart prominence and by progressed aspect finds ready response from the endocrine glands as follows:

SUN: influences two of the hormones of the front pituitary gland, one of which stimulates the thyroid gland and otherwise contributes to the transformation of energy necessary for sustained effort; and the other stimulates the adrenal cortex and thus with that gland determines the presence of courage.

And it influences the secretion of thyroxin, the hormone of energy production. These three hormones respond either to thought-cell activity stimulated by progressed aspects involving the Sun, or to conscious thinking of the Power type.

MOON: influences the two hormones of the back pituitary, the thymus hormone, and the hormones of the alimentary tract. One back pituitary hormone regulates woman's periodic functions. Pituitrin, the other back pituitary hormone, causes water to be retained in the body and the contraction of all the arteries except those of the kidneys. It causes the contraction of the plain muscles of the bowels, the bladder, the womb and other organs. It is sometimes used in childbirth to contract the womb. It also has something to do with the metabolism of the carbohydrates. Its deficiency leads to obesity. The thymus hormone tends to retard attaining maturity. These hormones respond either to thought-cell activity stimulated by progressed aspects involving the Moon, or to conscious thinking of the Domestic type.

MERCURY: influences the hormone of the parathyroid glands and one of the hormones of the front pituitary. Parathyrin, the hormone of the parathyroid glands, controls the calcium metabolism of the body, and in combination with other hormones ruled by Mercury, Uranus, Neptune and Pluto, controls the type of electrification. The front pituitary hormone which responds to Mercury influences cerebral activity. These two hormones respond to thought-cell activity stimulated by progressed aspects involving Mercury, or to conscious thinking of the Intellectual type.

VENUS: influences the hormone of the thyroid gland and the hormones of the gonad glands. Testosterone is the male sex hormone of the testes. Alphaestradiol has been found to be the active principle of estrone, the female hormone of the ovaries. It is now commonly referred to as the estrogenic hormone. These gonad hormones contribute to virility and rejuvenation. The corpus luteum hormone, progesterin, the hormone of pregnancy, also responds to Venus. The thyroid secretion, thyroxin, is the hormone of energy production. These hormones respond either to thought-cell activity stimulated by progressed aspects involving Venus, or to conscious thinking of the Social type.

MARS: influences the hormones of the adrenal glands, and the hormones of the gonad glands. Testosterone, the male sex hormone, secreted by the testes, has been given great publicity as a generator of male virility and as a rejuvenator of the whole body. The adrenal glands secrete two hormones. Adrenaline, secreted by the adrenal medulla, is the hormone of emergency energy. Cortisol, secreted by the adrenal cortex, is the hormone of courage. Both adrenal hormones neutralize toxicity of the blood and are the chief chemicals used by the body to fight infection. These sex hormones and adrenal hormones respond either to thought-cell activity stimulated by progressed aspects involving Mars, or to conscious thinking of the Aggressive type.

JUPITER: influences the hormone of the pancreas, insulin. Sugar and starch can only be used as fuel by the body, or as the kindling necessary to burn fat, when insulin is present. The liver is the central banking system of the body where reserve fuel is stored in the form of animal starch, or glycogen. Such storing depends upon the supply of insulin. This hormone responds either to thought-cell activity stimulated by progressed aspects involving Jupiter, or to conscious thinking of the Religious type.

SATURN: influences one hormone of the front pituitary gland. This hormone governs the growth of the skeleton and supporting tissues. Saturn, equally with Mars also influences one secretion of the adrenal glands, adrenaline, the hormone of the medulla. This is the hormone of emergency energy. These two hormones respond either to thought-cell activity stimulated by progressed aspects involving Saturn, or to conscious thinking of the Safety type.

URANUS: influences one hormone of the front pituitary—the one related to original thinking—and it influences the secretion of the parathyroid glands. Parathyroid hormone, the hormone of these glands, controls the calcium metabolism of the body, and in combination with other hormones ruled by Mercury, Uranus, Neptune and Pluto, controls the type of electrification. These Uranus hormones respond either to thought-cell activity stimulated by progressed aspects involving Uranus, or to conscious thinking of the Individualistic type.

NEPTUNE: influences the hormone of the pineal gland, and the hormone of the parathyroid glands. The hormone of the pineal gland prevents precocious maturity, and it neutralizes and depresses the secretion of adrenaline and cortin. Parathyrin, the hormone of the parathyroid glands, controls the calcium metabolism of the body, and in combination with other hormones ruled by Mercury, Uranus, Neptune and Pluto, controls the type of electrification. These Neptune hormones respond either to thought-cell activity stimulated by progressed aspects involving Neptune, or to conscious thinking of the Utopian type.

PLUTO: influences the hormone of the pineal gland, one hormone of the front pituitary—the one related to cooperative effort—the cortin hormone of the adrenal cortex, and the secretion of the parathyroid glands. The hormone of the pineal gland prevents precocious maturity, and it neutralizes and depresses the secretion of adrenaline and cortin. Cortin is the hormone of courage, neutralizes toxicity of the blood, and is one of the chief chemicals used by the body to fight infection. Parathyrin, the hormone of the parathyroid glands, controls the calcium metabolism of the body, and in combination with other hormones ruled by Mercury, Uranus, Neptune and Pluto, controls the type of electrification. These Pluto hormones respond either to thought-cell activity stimulated by progressed aspects involving Pluto, or to conscious thinking of the Universal Welfare type.

Not only do the hormones of the endocrine glands chiefly determine the chemistry of the body at any given time, but through their system of checks and balances it is their function to keep the chemical composition of the body constant within narrow limits. In addition to the central nervous system man possesses an autonomic nervous system, which itself is divided into two sections called the sympathetic nervous system and the parasympathetic nervous system. The action of the parasympathetic nervous system tends to counteract, and affords a check and balance against, the action of the sympathetic nervous system. And in a similar manner certain hormones of the endocrine system afford checks and balances against other hormones which cooperate to produce activities of an opposite character.

Thus does the parathyroid secretion, parathyrin, tend to counteract the action of other hormones and other conditions which tend to irritate or give undue sensitivity to the nerves. This it does chiefly through increasing ability to handle that great stabilizer of bodily chemistry, calcium. Thus also does the secretion of the pineal gland counteract the ability of adrenaline and cortin to overcome the acidity of the blood stream and to fight infection.

Calcium

—Calcium, which is ruled by Saturn, constitutes a larger proportion of the body weight than does any other of the mineral elements. Even as Saturn rules those traits which stabilizes the character, and the skeleton which stabilizes the body, so does calcium exercise a stabilizing effect upon the chemistry of the blood stream and nerves. To be more specific, there are a number of mineral salts which play an

important part in the physical body, due in great part to their electrical properties. Potassium, sodium, magnesium, iron, copper, manganese and calcium are important for proper nutrition combined as phosphates, carbonates, chlorides, etc. Unless properly controlled the intake of some of these minerals tends to develop chemical imbalances. And it is the special function of calcium to correct such inorganic lack of equilibriums in the body, in whatever direction they may occur. For instance, any unusual condition produced by excesses of sodium or potassium is corrected by an increase of calcium; too much magnesium induces a general state of relaxation, and this may be overcome by additional calcium; and a proper balance between calcium and phosphorus is essential for the proper functioning of nerves and brain.

This regulating the amount of calcium in the blood and the way it functions in the tissues is carried out by four little glands, each about the size of a grain of rice, distributed about the thyroid gland. These are the parathyroid glands. Insufficient of their hormone, called parathyrin, causes the bones to soften, the nails to become brittle, the teeth to fail, and the person to become excessively nervous and excitable. Calcium neutralizes the influence of sodium and other elements in their tendency to irritate the nerves and make them unduly sensitive. Depletion of parathyrin—which responds to the thought-cell activity inaugurated by Mercury, Uranus, Neptune or Pluto—results in inability to handle calcium, resulting in nervousness.

People who are sensitive are those with Mercury, Uranus, Neptune or Pluto thought-cells so active that they tend to deplete their supply of parathyrin. Such thought-cell activity tending to parathyrin depletion may be mapped by birthchart or progressed afflictions to one of these four planets, or it may be due to conscious thinking of the type ruled by one of them. Ordinarily, however, the thought-cell activity within the soul is reflected in the trend of the conscious thinking. Frictions or conflicts of any kind within the mind, or over mental activity, tend to disturb the proper action of the parathyroids, and induce a neurotic state. The removal of the parathyroid glands results in a nervous disorder called tetany.

While Mercury, Uranus, Neptune and Pluto thought-cell activity seem equally effective in their influence over the parathyroid secretion, each of these types of thought-cell activity affects also a different endocrine secretion. This, in turn, encourages the corresponding type of thinking—intellectual, original, utopian, universal welfare, according to whether the energy is from Mercury, Uranus, Neptune or Pluto—and has a direct effect upon the frequency of electromagnetic radiations generated in the nervous system.

The cells of the body are miniature batteries which generate electricity and radiate the high-frequency energy of the lightning which fixed the nitrogen that plant life took from the soil. This is in accordance with Einstein's Law of Equivalence; that the energy of an atom is given out in the same quanta as those received by the atom. And of the cells of the human body, those of the nervous system are best adapted to the production of short-wave radiations, as well as to carrying electricity. But

thought-cell activity determines, through the action of the hormones of the endocrine glands, the frequency of the wave lengths radiated at a given time. And this thought-cell activity, in turn, may arise chiefly from the stimulation of factors within the soul by the energies of a progressed aspect, or by a consciously selected mood and trend of thought.

But if the dominant thought-cell activity at the time is of the Mercury type, the electrical energies generated by the nervous system tend to be of the particular frequencies adapted for use in cerebral thinking. This particular range of frequencies is encouraged by the front pituitary hormone which responds to Mercury, in cooperation with parathyrin. Such intellectual effort as that which commonly goes by the name of objective thinking, including problem solving, worry and ordinary fantasy thinking consumes electrical energy which radiates these electromagnetic wave-lengths. And when they are called upon excessively it depletes the parathyrin supply, leading to nervous exhaustion, and consuming electrical energies that otherwise would generate the Sun frequencies and contribute to physical vitality.

If the dominant thought-cell activity at the time is of the Uranus type, the electrical energies generated by the nervous system tend to be of the particular frequencies adapted for use in original thinking and in inspirational extrasensory perception. This particular range of frequencies is encouraged by the front pituitary hormone ruled by Uranus, in cooperation with parathyrin. Such intellectual ESP is practiced unconsciously by most writers and inventors, and by many business men who, when confronted with a difficult problem, put it from their minds and spend the afternoon on a golf course, confident that before the day is done the proper step to take will pop into their consciousness.

These electromagnetic energies of the Uranus frequencies when generated in excess, not only rob the vitality of the electrical energies needed, but create a high nervous tension which in extreme instances gives rise to uncontrolled muscular twitching, St. Vitus's dance or paralysis.

If the dominant thought-cell activity at the time is of the Neptune type, the electrical energies generated by the nervous system tend to be of the particular frequencies adapted for use in dramatic work, imagination and feeling extrasensory perception. This particular range of frequencies is encouraged by the pineal hormone influenced by Neptune, in cooperation with parathyrin. It gives a hypersensitivity of the nervous system which tends to make of it and the electrical energies flowing over it, a receiving set for picking up the astral radiations of the person or object which is tuned in on. These wave lengths seem particularly adapted also to permit whatever vibrations are thus picked up to cause their source to be seen, heard, tasted, smelled or felt by objective consciousness. When generated in excess, not only do they rob the vitality and intellect of needed energies, but the individual becomes so sensitive that he suffers acutely merely from the discordant thoughts of people.

If the dominant thought-cell activity at the time is of the Pluto type, the electrical energies generated by the nervous system tend to be of the particular frequencies adapted for cooperative activities and inner-plane work. This particular range of frequencies is encouraged both by the pineal hormone influenced by Pluto and the front pituitary hormone ruled by Pluto, in cooperation with parathyrin. To the extent the pineal hormone is active do the electrical energies seem to work on the negative phase, and to the extent the front pituitary hormone and cortin (also influenced by Pluto) are active do they work on the positive phase. Thus they may be used to pick up energies as a receiving set, or to send messages as a transmitting set, and to do work on the inner plane. When generated in excess they lead to over sensitiveness, and rob the vitality of energy it needs.

The best way of determining the power of a planet is to calculate its astrodynes, as explained in Course XVI, Stellar Healing. This method shows that a planet receiving powerful aspects has much power. But for the statistical analysis of large numbers of charts calculating the astrodynes is too much labor. Therefore, for such volume statistical analysis, on January 1, 1948, we adopted the following rule: Any planet aspecting another planet by zodiacal longitude within one degree of the perfect aspect, or in an angle, or aspecting Sun, Mercury or the Moon is considered prominent. This rule eliminates any nonmathematical opinion on the prominence of a planet. While it may not be as precise as might be desired, it gives uniformity in the statistical analysis of charts.

To the extent a planet is prominent in the chart of birth are the type of thought-cells it rules generally active throughout the life. And if at the same time the planet is heavily afflicted, will such activity as they have generally, or temporarily through energy added to the thought-cells by a progressed aspect, be of a character unduly to affect the secretion of the hormone or hormones which in particular is influenced by them.

When, therefore, Mercury, Uranus, Neptune or Pluto is of outstanding prominence in the birthchart, or more than one of them, we may by that token expect considerable strain on the parathyroid glands, and if the planet is heavily afflicted the strain will be more pronounced. Birthchart positions, however, chiefly indicate predispositions which only become serious afflictions when there is a progressed aspect involving the planet indicating the predisposition. That is, the thought-cell activity which manifests as discord has only a certain power on the average. But when a progressed aspect forms to the planet mapping it, the thought-cells gain a tremendous amount of new energy and become proportionally more active, and influence the things they rule markedly. And if the progressed aspect is discordant, the tendency will be to affect adversely the endocrine secretions which are responsive to the planets involved.

Thus does a progressed aspect involving Mercury, Uranus, Neptune or Pluto tend to develop parathyrin deficiency, and the nerve tension or nerve hypersensitivity which results. Yet if the parathyrin which is present has ample material at hand for stabilizing the nerves and manufacturing healthy nervous tissue, the strain on it will be less because it has so much less work to do; and these same materials also will assist in the production of a normal supply of parathyrin.

Supply More Vitamin B-1

—For building healthy nerve tissue vitamin B-1 is essential. And as the necessity to build or repair nervous tissue is greater when Mercury, Uranus, Neptune or Pluto is afflicted, so should the intake of vitamin B-1 then increase. And it should be remembered that if the water in which foods are boiled is thrown away, the vitamin B-1 may be lost. Also that long exposure to heat destroys it.

Stabilize With More Calcium

—Phosphorus in ample amounts must be present for bone replacement and for healthy action of brain and nerves. Recent studies of the nervous system of various animals show that as the brain and nervous system become more complex there is an increase in them of compounds of oxygen-poor fats with phosphoric acids. It would seem, then, that even as Saturn rules the calcium in the human system, so phosphorus is ruled by Mercury. Although the idea that phosphorus is a brain food for a time fell into disrepute, late chemical studies verify this conclusion. Brain workers do need foods containing phosphorus, and people need phosphorus when Mercury or Uranus is afflicted.

Yet I emphasize calcium rather than phosphorus because as a rule the foods high in calcium content are also high in phosphorus, and if the individual eats enough of such foods to acquire adequate calcium, he at the same time obtains adequate phosphorus. The bones and teeth, which contain over 99 per cent of the calcium of the body, also contain about 70 per cent of the phosphorus, and there is about two-thirds as much phosphorus in the body as there is calcium.

The phosphorus needed by the body may be obtained from unmilled wheat and oatmeal, Brazil nuts, almonds, bechnuts, beans, lean meat, milk, eggs and cheese. These are all good sources of phosphorus. And, because their presence is so continuously essential, a reserve supply of both calcium and phosphorus is stored in the bones, to be drawn upon as needed, even as a reserve of immediately available fuel in the form of glycogen is stored in the liver.

The bones and nerves must have both calcium and phosphorus, and both are handled by parathyrin. But especial attention must be given calcium because its deficiency is so common and because when there is an affliction of Mercury, Uranus, Neptune or Pluto there is a tendency to inadequate parathyroid secretion, leading not only to lack of calcium-phosphorus balance, but to an increase in the proportion of sodium in the blood and nerves. Such lack of calcium in proportion to sodium quickly affects the nerves and brain.

The effect is to increase the sensitivity of the nerves, to develop high nervous tension, to impair self-control, to speed up and make irregular the mental activity, and to beget the excitability and irritability which are characteristic of neurosis and the tendency to nervous prostration. There is no doubt that effort will enable the individual to increase his self-control, but in spite of any thinking he may do, or any exercise of will power, his nerves will continue highly sensitive and irritable until they are furnished with sufficient calcium to counteract the chemical attack on them of the excess sodium.

Proper thinking may attract the individual to a calcium supply, but when due to thought-cell activity stimulated by a progressed aspect involving Mercury, Uranus, Neptune or Pluto, reserves of calcium have been drawn from the bones until such supplies are no longer adequate, the only way nervous control can be re-established is through furnishing them with a better supply of calcium. Thinking alone will not do it; no more than thinking will prevent hydrochloric acid from burning the hand when some of it is accidentally spilled on it.

I am not here attempting to outline a complete diet plan for the individual who is under a progressed affliction involving some planet. I could not do this because not less than a thousand chemical compounds have already been found in the human body, and the diet of the individual should be determined by the proportions in which these compounds exist in his body at the particular time. And this, in turn, is influenced not by one birthchart or progressed aspect alone, but by all of them and by the conditions in his physical environment. By environment I mean not only the available foods but such factors as whether it is winter or summer, and whether he is in the arctic regions or in the tropics.

But I am pointing out that when he is under a progressed affliction involving Mercury, Uranus, Neptune or Pluto, there is special need for vitamin B-1 with which to build healthy nerve tissue, and for calcium with which to facilitate the neutralizing of excess sodium and other elements in the blood stream. And the most effective way to obtain either vitamin B-1 or calcium is to eat foods which abundantly contain it. The tables here published show the best sources of both. White flour and polished rice have been deprived of much of their calcium, and cereals in general, oatmeal in particular, tend to prevent the absorption of calcium by the system.

To Benefit, the Calcium Must Be Assimilated

— The calcium in some foods is easily assimilated, while in others is only partly assimilated. For instance, spinach contains .078 per cent calcium, and thus is richer in this mineral than peanuts, brown rice, eggs, etc. But the system seems to be unable to assimilate calcium from spinach. Not only so, but spinach eaten at the same meal with other calcium containing foods decrease the amount of calcium assimilated from them.

Cereals taken with a meal tend to prevent calcium assimilation; but if they are irradiated with ultraviolet light, this effect is not present. Nor do they hinder calcium assimilation when at the same meal lettuce, liver or eggs are eaten.

On the other hand, it is found that an acid condition of the intestinal tract produced by drinking orange juice gives remarkable ability to assimilate the calcium foods. And in addition, orange juice before the commencement of a meal tends to decrease and overcome the acidity of the body; for the fruit acid is burned to give a residue of alkaline carbonates and bicarbonates. The juice of other citrus fruits in like manner tends to increase the ability of the intestines to handle calcium. The source of calcium commonly recommended is milk. And to people with whom milk agrees this is an excellent source, because milk may be consumed in such large amounts. But the calcium is not equally available- in all types of milk. It has been found, for instance, that milk quickly boiled gives a retention of calcium three times as great as the slowly heated pasteurized milk, or as dried milk; and that the calcium of sweetened condensed milk can but little be assimilated. On the other hand, evaporated milk, which is recognized as good for babies, has its calcium easily available; and raw milk is best of all. The drawbacks to using raw milk are that it does not keep so well as that pasteurized, and that unless the cows furnishing it are tested with the utmost care the milk may carry the germs of tuberculosis.

Vitamin D Must Be Present to Handle the Calcium

—In the skin of man there is a substance which absorbs the ultra-violet rays of sunlight. Other sterols, notably ergosterol, exist in various forms of living things. These sterols are provitamins which, when irradiated, yield vitamin D. Thus ergosterol, which is the provitamin in yeast, when irradiated becomes calciferol. Irradiated 7-dehydrocholesterol is the form in which vitamin D is found in cod liver oil and halibut liver oil and in the human skin. And this vitamin D, obtained by exposing the skin to sunlight or artificial ultra-violet light, or from foods, is absolutely essential in the maintenance of the calcium-phosphorus balance, and for the bones and nerves to utilize calcium and phosphorus.

When there is insufficient vitamin D or exposure to sunlight the system fails to assimilate calcium and phosphorus, and the parathyroid hormone draws upon the balance in the bones, weakening them, and after a time upsetting the proper balance between calcium and phosphorus, and between calcium and sodium. This not only affects the bones, but also affects the nerves and brain; for both bones and brain are dependent upon the handling of calcium and phosphorus, and nerve stability on proper neutralization of sodium and other elements by calcium.

Deficiency in vitamin D gives rise to rickets in infants; and to nervous difficulties in adults. Gould's Medical Dictionary defines rickets thus:

“A constitutional disease of infancy, characterized by impaired nutrition and changes in the bones, the symptoms being a diffuse soreness of the body, slight fever, and profuse sweating about the head and neck, and changes in the osseous system, consisting in a thickening of the epiphyseal cartilages and periosteum and a softening of the bones.”

Where there is lack of sunlight, such as occurs in winter where the sun cannot penetrate the smoke in cities, rickets affect many children, and the adult population suffer nerve depletion. These conditions can be cured, however, by ultra-violet light or by vitamin D, provided calcium and phosphorus are present in ample amounts in the food.

Certain fish have the ability to store vitamin D. Cod liver oil has been used thus for decades in the cure of rickets. Other fish livers have the same properties but usually in less degree. Mackerel liver oil and halibut liver oil contain about half the vitamin D, white sea bass liver oil about one-third the vitamin D, and salmon liver oil about one-fiftieth the vitamin D, that is contained in cod liver oil; while the puffer fish elaborates an oil fifteen times as strong in this respect as cod.

Because the influence of the thought-cells ruled by Mercury, Uranus, Neptune and Pluto when too active or discordant—as mapped by these planets in the birthchart, and at those times when progressed aspects, especially discordant progressed aspects, form involving one or more of these planets—is to weaken the secretion of parathyrin; when these planets are afflicted there is a definite need for vitamin D to enable such parathyrin as is present to handle calcium.

But vitamin D is not harmless when taken into the system in too great amounts. Excessive sunburn produces a toxic condition chiefly due to release of proteins of the tissue, but which may also be due to excessive vitamin D; and while there is no danger of getting too much vitamin D in ordinary foods, excessive dosing with vitamin D should not be encouraged. as overdoses are decidedly injurious to the health.

Use Jupiter Thoughts to Neutralize Discordant Mercury or Uranus Thought-Cell-Activity

—While it is true that you cannot think vitamin B-1, vitamin 1), or calcium into the body for parathyrin and other hormones to use in building healthy nerves and stabilizing their electromagnetic radiations, it is equally true that no matter how much, or what kind of materials you furnish the body to work with, permanently healthy nerves and stabilization of their electromagnetic radiations will not be present while the thought-cell activity mapped by Mercury, Uranus, Neptune or Pluto is too intense and discordant. Even though these thought trains are chiefly in the region of the unconscious mind, their influence will find response in the parathyroid glands and the other gland or glands which the planet mapping them rules.

All that can be done with food is to afford the optimum facilities of work for the glands and other functions. And that is a big aid; for then they will not need to work so hard to produce beneficial results. But if at the same time they are continually distressed by discordant thought-cell activity, they will find it difficult or impossible to maintain health in spite of any physical assistance that may be afforded.

Man is a two-plane organism, and for completely satisfactory results proper adjustments must be made on both planes. In addition to the foods especially needed at the time, he should provide also for beneficial thought-cell activity. And because they act as natural antidotes there is nothing better to counteract too active or discordant Uranus or Mercury thought-cell activity, and their tendency to deplete the parathyroids, than to cultivate the Jupiter attitude, placing faith in the beneficence of Divine Providence, looking confidentially to a higher than human source to oversee matters beyond control, and keeping cheerful and jovial.

Whenever the tendency to over cerebral activity is noticed, or the feeling of high tension and nervousness, a deliberate effort should be made to get into the mood of trust and faith and optimism and genial good will to all, which is characteristic of Jupiter thought-cell activity.

Because employed for this definite purpose, this will add the energy of the Jupiter thoughts directly to the thought-cells responsible for the cerebral activity, tension or nervousness. The resulting thought-element combination is harmonious and to the extent it is thus formed will the resulting thought-cell activity relieve parathyroid strain and nerve tension and work for a healthy condition.

Influence of the Foods Upon the Disposition

—I can think of no greater contrast in physiques and ideals than that between the founder of modern Germany, Bismark, the man of blood and iron, and Gandhi, the spiritual leader, who taught nonviolence and freed India's teeming millions.

Bismark (chart in lesson No. 220) is representative in type of the American political boss, of the coarse brutality which takes no consideration of the welfare of others so long as the end is gained, and which has no sympathy for suffering. He had Leo on the Asc., Moon in Capricorn, and Sun in Aries opposition Jupiter, square Moon, sextile Mars and Saturn, and trine Uranus. In contrast to the small emaciated Gandhi, Bismark at the age of 68 weighed 247 pounds.

He was a glutton who indulged in immense amounts of highly stimulating foods all his life. Undoubtedly he indulged in food and drink to excess, and that a more moderate life would have been beneficial. But it is equally certain that a man with so high a metabolism, that is, with ability to burn so much fuel, could not have lived upon the Gandhi diet.

Gandhi (chart in lesson No. 177) had Libra on the Asc., Moon in Leo, Sun in Libra opposition Neptune, Mercury conjunction Asc., and Venus conjunction Mars in the first house, and both opposition Jupiter. In his book, "My Experiments with Truth." Gandhi relates his experiments with food. In 1906, under progressed Sun opposition Jupiter p, he decided to become a Brahmachari which, according to the custom, required a vow of chastity in order to devote himself to a life of service to his fellowman. To keep this vow he commenced to experiment with diet in the attempt to find foods which would not excite what he terms carnal passion.

The Indian cuisine includes spices and condiments. And the general tendency of a progressed aspect involving Jupiter is to incline toward rich and highly seasoned foods. But these interfered with Gandhi's plans to control his emotions.

After six years of experimenting he found he could attain "immunity to passion", on a diet of nuts and fruits, especially when fresh, and interlarded with days of fasting during which he took only water. Uranus is the research planet, and when progressed Sun came to the luck (trine) aspect with Uranus r, he solved his diet problem.

However, he was unable to live on this, from his point of view, most highly desirable food. He could not retain his strength upon it. Therefore, that there might be enough protein for building muscle, and thus keep him from wasting away, he had to resume drinking milk. From his standpoint, in which sexual interest was taboo, this was not desirable; for he relates that this caused a certain amount of sexual excitability and interest. As he says, "I have not the least doubt that milk diet makes the Brahmacharya (chastity) vow difficult to observe.

Gandhi was 37 years old at the commencement of his diet experiments and 43 years old when he solved the problem, not to his satisfaction, but by a compromise between his emotional ideal and the practical requirements of life. But because Gandhi found the animal propensities even of goat's milk to be sexually stimulating, we cannot infer that some other individual would find it so. To understand the effect of food upon the individual we must know the birthchart and progressed aspects.

The very energy which made Gandhi's life so successful, which gave him the tremendous psychokinetic power which he possessed, was the sex energy against which he was struggling at 37 years of age.

Not only did he have Sun in the sign of marriage, Libra, and this sign on the Asc., but he had the two gonad stimulating planets, Mars and Venus, and also Mercury in the sex sign Scorpio in the house of his personality (first), Venus and Mars being in close conjunction and powerfully aspected by other planets. With thought-cells such as these positions map, even at 43 and after six years of experimenting, he found even goat milk stimulated sex interest. But some other person, with Saturn in the first house, and Mars and Venus having few astrodynes, might eat almost anything and remain free from sexual desire.

Furthermore, when Gandhi in 1906 had difficulty with his desires, he had not only Sun opposition Jupiter p, inclining him to religion; but Sun conjunction Venus r, a gonad stimulating aspect. Therefore, if in his life, there was ever a need for exercising proper control over the passions, it was during the following three years while the Sun by progression made the conjunction of Venus and then Mars in his birthchart. With such aspects he required so little protein in his diet that if he had no more protein at some other period he would have found it quite inadequate.

Not to quell sexual desires perhaps, but to bring undesirable factors in our dispositions under better control, all of us are faced with the general problem which Gandhi solved by compromise. Some foods tend to increase and others decrease, the traits of disposition toward which the thought-cells at birth predispose us. And when these traits are given further stimulation by progressed aspects forming which are their constants, by food selection and other environmental factors we need to make it as hard as possible for the disagreeable thought-cells to find facilities for expression. For instance, when we tend to become high tension and irritable due to a progressed aspect involving Mercury or one of the upper-octave planets, we should take particular pains that we get an abundant supply of vitamin B-1, vitamin D, and calcium.

Chapter 8

Serial No. 223
Original Copyright 1949
Elbert Benjamine

Copyright
August 2002
Church of Light

What To Eat When Sun,
Moon Or Pluto
Is Afflicted

Best Sources of Vitamin B-2 (riboflavin)
Approximate micrograms Per oz. of fresh food.

Beef Liver	1,000	Kale	175
Calf Liver	1,000	Almonds	175
Lamb Liver.	800	Mustard Greens	125
Pork Liver	800	Lean Beef	105
Veal Kidney	700	Turnip Greens	100
Lamb Kidney.	600	Eggs	100
Beef Kidney	600	Peanuts	85
Whole Evp. Milk.	425	Dry Lentils	85
Dry Navy Beans	375	Dried Cowpeas.	85
Dried Prunes	375	Watercress	80
Dry Soy Beans	260	Beef Brains	70
Dry Lima Beans	260	Dark Chicken Meat	70
Green Lima Beans	260	Milk	65
Beef Heart	225	Dandelion Greens	65
Cheddar Cheese	220	Salmon Fish.	65
Wheat Germ	220		

Best Sources of
Manganese
Milligrams per 100 calories of
food.

Huckleberries	6.43
Lettuce	5.34
Peas	2.74
Chestnuts	1.50
Beets	1.42
Oatmeal	1.34
Whole Wheat Flour	1.20
Kale	1.17
Dates	1.12
Cucumbers	1.04
Onions86
Green Peppers86
Rhubarb85
Celery80
Tomatoes79
String Beans79
Raspberries76
Bananas65

Chapter 8

What To Eat When Sun, Moon Or Pluto Is Afflicted

THE human body is an engine which is kept running by the burning of fuel. Yet other things besides fuel are necessary to keep it moving properly, just as an automobile requires lubricating oil, water for cooling, grease for the working parts, and an electrical ignition system. When the electrical ignition system (Uranus) goes wrong either in a human body or in an automobile the engine does not work properly. And oxygen (Mercury), both for the body and an auto is part of the fuel consumed. But in addition to oxygen and the three different types of fuel, the human body also requires water (Moon), the various vitamins (Sun) and the twelve minerals (Saturn): sodium, potassium, calcium, magnesium, iron, manganese, copper, chlorine, iodine, fluorine, phosphorus and sulphur.

Of the fuels there are three different types; the glucose of sugars and starches (Venus), the fatty acids of fat (Jupiter), simple and phosphorized, and the 20 amino acids of proteins (Mars).

SUN AFFLICTED

CALLS FOR

**IODINE,
MANGANESE,
VITAMIN B
COMPLEX AND
VITAMIN A**

MOON AFFLICTED

CALLS FOR

**PROPER
WATER-SALT
BALANCE AND
VITAMIN B-2**

PLUTO AFFLICTED

CALLS FOR

**PROTEIN, IRON,
CALCIUM, VITAMIN
A, VITAMIN C,
VITAMIN D, AND
VITAMIN B
COMPLEX**

Physical energy depends upon the ability to burn fuel. And this ability is governed by the Sun through not merely one gland but several. The speed with which fuel is burned, and hence the general speed of energy production, and of life itself, is controlled by the thyroid gland, which secretes the hormone known as thyroxin. But the maintenance of fuel ignition which gives endurance is largely controlled by the front pituitary gland.

Still other glands influence the mobilization of the fuels for burning, and stimulate or depress the thyroid and pituitary glands. Thus the adrenal glands produce the hormone which mobilizes fuel and electrical energy for emergency purposes. And in some way the disturbance of almost any of the other important endocrine glands reacts upon the pituitary and thyroid in such a way as to influence their regulation of fuel consumption.

The Pituitary Gland

—The pituitary is about the size of a pea, located a little behind the nose in a small bony case at the base of the brain. It is not one gland, but two, the front pituitary and the back pituitary. And each of these two glands secretes more than one hormone having a different function. Consequently the influence of different planets finds a ready response from these hormones. The front pituitary gland often is called the “master gland,” because it secretes twelve different hormones that are now known, and may secrete others.

Two of them find ready response from the Sun thought-cells, one from the Saturn thought-cells, one from the Mercury thought-cells, one from the Uranus thought-cells, and one from the Pluto thought-cells.

The growth hormone of the front pituitary, which responds to Saturn, controls the development of the skeleton and supporting tissues. Its over activity gives rise to gigantism. Tadpoles and rats stimulated artificially by this hormone grow to huge size. In normal human beings this growth hormone which gives length to the long bones, decreases at puberty, and a gonad stimulating hormone—the pituitary hormone which responds to Pluto—increases in activity.

When this fails to take place in an adolescent boy he becomes excessively fat with folds of tissue around his girdle and with prominent breasts. His sexual organs remain infantile. But when treated with injections of this hormone made from the pituitary glands of cattle the fat quickly disappears, his voice deepens, and he soon has normal development of his sexual organs. Yet in females and males, as important as this sex (Pluto) stimulating hormone is, it is only effective in the presence of functioning ovaries (Venus) or testes (Mars).

Here we are interested in the pituitary hormones that respond to Sun, Moon and Pluto. In this respect the front pituitary bears the same relation to the back pituitary as the Sun bears to the Moon. The front pituitary is decidedly masculine in all the tendencies its secretions stimulate, and the back pituitary is as decidedly feminine in the influence of its secretions. The front pituitary secretions make for control, for aggressiveness, and for the use of reason. The back pituitary secretions make for emotion, for love of children, and for sympathy. Yet the pituitary secretions must have the hormones of the sex glands to support them.

The truly feminine women are those in whom the back pituitary is more active than the front pituitary, and in whom the gonads are active enough to sustain proper gonad-pituitary balance. If, instead, the front pituitary is more active than the back pituitary, and there is proper gonad-pituitary balance, the woman is of the masculine type. Instead of finding her great pleasure in domestic responsibilities, she desires to go out into the world and compete for leadership.

The truly masculine men are those in whom the front pituitary is more active than the back pituitary, and in whom the gonads are active enough to sustain the proper gonad-pituitary balance. If, instead, the back pituitary is more active than the front pituitary, and there is proper gonad-pituitary balance, the man is feminine. He is not merely more delicate in physique, but he is decidedly emotional and lacking in aggression. Certain poets and musicians represent this combination. But for creative work in any line there must be good support from the hormones of the gonads, that is, from Venus and Mars.

Now a birthchart affliction involving the Sun indicates some disturbance of the front pituitary gland, and a progressed affliction involving the Sun gives additional and more discordant activity to the thought-cells affecting the front pituitary gland. Probably all the secretions of this “master gland,” are to some extent influenced by a progressed aspect involving the Sun, but two of them in particular respond to such a progressed aspect with alacrity; one which stimulates the secretion of thyroxin by the thyroid gland and also more directly contributes to sustaining energy and giving endurance, and one which stimulates the secretion of cortin by the adrenal cortex and also more directly contributes to courage. These two front pituitary hormones respond to the activity of the Power thought-cells within the soul.

The Moon and the Back Pituitary Gland

—One back pituitary hormone regulates woman’s periodic functions. When a woman becomes pregnant this hormone is no longer needed, and lack of its presence, according to the Aschheim-Zondek test, is supposed to be 98% or 99% accurate as a test for pregnancy. But the back pituitary hormone about which more is known, called pituitrin, is the one with which we here are chiefly concerned; for with cortin it exercises control over the water-salt balance which is so necessary for health.

Pituitrin, which responds with alacrity to the activity of the Domestic thought-cells mapped in the birthchart by the Moon, controls imagination, sympathy, tenderness and the maternal instincts. Its excessive secretion leads to delusion. It also controls the tone of the intestines and causes contraction of all the arteries except those of the kidneys. It causes the contraction of the plain muscles of the bowels, the bladder, the womb and other organs. It is sometimes used in childbirth to contract the womb. It also has something to do with the metabolism of the carbohydrates, ruled by Venus, and its deficiency leads to obesity.

Its responsiveness to the Moon is indicated by the readiness with which people with an unstable back pituitary take on and lose weight through variation in water retention. It is also believed that the type of mental restlessness and inability to sleep which is experienced by many people near full moon is due to the stimulating effect of water on the brain cells, more water being retained at the time of such mental activity due to more pituitrin being secreted by the back pituitary gland.

Lack of water gives rise to a craving called thirst, which if prolonged leads to delirium. But, because thirst is a sensation arising from imbalance between water and salt, when there is too much salt in the system thirst develops quite as readily as when there is too little water. What is really required by the body is salt water.

Pituitrin, the hormone of the back pituitary, causes water to be retained in the body. An over-active back pituitary means a water-bloated individual; and a back pituitary which fluctuates in activity tends to rapid weight variation due to water content. Such activity is chiefly influenced by the thought-cells mapped by the Moon.

Astrologers often speak of the Moon as having a magnetic influence. And the salt in the body dissolved in water or protoplasm does break up into positively charged sodium and negatively charged chlorine. That is, salt taken into the system as a mineral is decomposed into elements which possess electric or magnetic fields, and these electric or magnetic molecules travel through the blood and cells to be finally excreted through the kidneys as sodium and chlorine. And while the cells themselves generate electrical energy and high-frequency radiations, the magnetic tone of the body is profoundly influenced by the water-salt balance of the body.

But water retention is also influenced by cortin and thyroxin, both of which respond with alacrity to hormones of the front pituitary stimulated by activity of the thought-cells mapped by the Sun. That is, the thyroxin and cortin responding to activity of the thought-cells ruled by the Sun, have exactly the opposite effect on the amount of water retained in the body from that of the hormone stimulated by the Moon. It should be here noted also that under emergency the thought-cells ruled by Mars also have a similar and more violent effect, and that Pluto thought-cell activity also may affect the water-salt balance. For cortin responds somewhat to Pluto and quite directly to Mars, and adrenaline, which Mars thought-cells release in emergency, stimulates the flow of thyroxin. And a desiccated body, lacking power to

retain water, may develop either from a weak back pituitary or an over active thyroid. It is the balance between them; the balance of the Sun to dry, and some influence of Pluto in the same direction, Mars being quite violent in this respect in emergencies, and the Moon to retain moisture, so to speak, that determines the water content of the body.

Thus it is that even as sugar cannot be retained in the system without insulin, and as calcium cannot be retained without parathyrin, so water cannot be retained without pituitrin. The disease resulting from this inability to retain water for use is called diabetes insipidus, that resulting from inability to store sugar for use is called diabetes mellitus. Water depends upon the balance between pituitrin and thyroxin (and cortin), and when this balance tips in the direction of pituitrin there is need of less water, but when it tips in the direction of thyroxin (and cortin) there is need of more water. Thus it is that the individual requirements for water are as different as are the prominence of Sun and Moon in various birthcharts; and in the life of the same individual they are much different during those periods when the Sun is powerfully afflicted by progressed aspect than they are when the Moon is powerfully afflicted by progressed aspect. It is easily possible to drink either too much water, or too little.

Of course, other things (especially the glandular secretions) being equal, the more water taken into the system the more salt is needed to keep the solution approximately that of sea water.

The ancestors of all land animals originally came out of the sea. Sea creatures are bathed in water containing various salts, and incorporate this solution in their bodies. Their blood stream, as it developed, had the general composition of the sea water in which they lived. And the animals which moved out of the sea onto the land and continued their development there, brought with them their sea water blood stream. So even today, among the higher animals, including man, health is impossible unless the cells of the body are bathed in fluids having about the same composition as the sea had when our ancestors left the ocean for dry land.

The percentage of sodium, chlorine, potassium, calcium and iodine in the human blood stream is that of the present day sea water. But the magnesium of the human blood is less than that of present-day sea water; from which it is logical to infer that the magnesium of the ocean has undergone a considerable increase since that early day when man's first land ancestors moved out of it. Shortly I will indicate the importance of preventing the iodine content of the blood stream from getting much lower than that of sea water, but at the moment let us consider not merely the amount of salt, but also its relation to the amount of potassium in the diet.

There is normally a small amount of potassium in the blood, but any excess enters into a compound with sodium chloride (salt), and the new compound thus formed is promptly carried out of the body. Thus it is that the higher the diet in potassium in proportion to sodium, the more salt is required to keep the proper amount of salt in the system. There must be additional salt to neutralize the potassium. Now flesh foods have about the same proportion of sodium and potassium in them that are present in

the human system. Carnivorous beasts, therefore, need no additional salt with their food. But nearly all edible plants, tubers, fruits and vegetables (with the exception of rice) have an excess of potassium. Horses, cows and sheep must be given salt to neutralize this excess of potassium, and wild herbivorous animals risk great dangers to reach salt-licks to restore the salt depletion of their bodies. And among primitive tribes, especially where a vegetable diet is the mainstay of life, salt is bartered for even at great sacrifice.

There can be either too much salt or too little in the food. Meat eaters do not need to acquire so much salt as vegetarians; for the latter must have an extra supply to replenish the depletion due to combination with potassium. A reasonable amount of common table salt will thus often be found advantageous to them. Excessive salting of foods, and thus too much salt in the blood stream, tends to harden the tissues and prevent the nutrient fluids reaching the cells as they should. The amount of salt actually needed, and salt should not be present in excess of this, is enough to neutralize the potassium present and to bring the blood stream to a salinity about that of sea water. The less water and the less potassium present the less salt is needed; the more water and the more potassium present, the more salt is needed.

In general, heavy progressed aspects involving the Sun or Mars (for Mars increases the flow of cortin directly, and of thyroxin through the additional adrenaline hormone), and to a less degree Pluto, tend to drive the water from the body, and thus more water is needed, with sufficient extra salt to hold the water-salt balance. And in general, heavy progressed aspects involving the Moon tend to retention of the water in the body, and thus less water is needed and less salt to hold the water-salt balance.

However, no blanket rule in this respect can apply, not only because the body chemistries of people vary according to their birthcharts, but because, according to this birthchart chemistry and previous progressed aspects, the point at which a given glandular secretion becomes exhausted when placed under the strain of a heavy progressed affliction involving the planet to which it readily responds, varies. So long as the back pituitary gland can respond to the thought-cell activity mapped by the Moon by secreting additional pituitrin, water will tend to be retained, and less water and less salt will be required. But when due to strain, insufficient pituitrin is secreted, the action of thyroxin will tend to overbalance this tendency, and water will be driven from the body. And as water which thus is excreted either by the kidneys or the perspiration glands is salt, not only more water is then required, but more salt.

This we can say with much confidence; that afflictions involving the Moon in the birthchart, and progressed afflictions involving the Moon during the time they are within one degree of perfect, tend to upset the water-salt balance, and thus this factor should then be given careful attention. If the individual under such aspects tends to take on weight, and especially if tendencies to water bloat are indicated, it shows an over supply of pituitrin, and that less water and salt are needed. But if the individual under such aspects loses weight, especially if there are signs of drying out, it indicates that the pituitrin supply has become so depleted under the strain that more water, and sufficient salt to give it the proper salinity, are needed.

The Moon and the Thymus Gland

—But the back pituitary is not the only gland which readily responds to thought-cells made active by aspects involving the Moon. The thymus gland is situated in the chest astride the windpipe and covering the upper portion of the heart. It prevents too early maturity in children, and when overly active the adult continues childish in his attitude toward life, seeking the line of least resistance, and resorting to day dreams instead of facing the hard realities. Its dominance also affects the differentiation of sex, tending to produce feminine expressions in the male and masculine expressions in the female. The individual thus has a fixation at the emotional level of development commonly just preceding puberty, finding greater pleasure in those of the same sex than in the company of the opposite sex.

Such retardation of emotional development, of course, is due to a marked imbalance of the hormones of this gland in relation to the hormones of the gonads. And the thymus does have an important function in adult life. There is a close relation between it and nutrition and growth, for it has a direct action upon the lymphatic cells.

Lymph cells take part in the absorption of food, particularly of fat, from the intestines. These cells are migratory, moving throughout the body, some of them, the phagocytes, being called the police cells, because they protect the body from infection. These attack and devour bacteria and other invading forms of life. They are not confined to the blood and lymph, but make their way by their own movement through most of the soft tissues of the body. In the blood stream lymph cells become the white corpuscles.

The thymus gland is composed of a network of reticular cells, supporting lymph cells; and these lymph cells are quickly depleted by malnutrition or starvation. Together with the fat of the body, they serve as a reserve supply of food. And not only does the thymus quickly shrink in size when there is lack of food, but the lymph cells also disappear from the blood stream. But in addition to food, there must be present the internal secretion of the thymus if the Lymph cells are to remain in normal quantity and do their appointed work.

Yet in spite of other foods, and in spite of any kind of thinking, the thymus cannot continue active without vitamin B-2. It has been experimentally shown that vitamin B-2 deprivation, both in animals and in man, produces a shrinkage of the thymus with a corresponding depletion of lymphatic cells and a lowering of the nutrition.

Use Harmonious Mars Thoughts to Neutralize Discordant Moon Thought-Cell Activity

—When the Moon is afflicted care should be exercised that the food contains plenty of vitamin B-2, and care should be exercised to provide for a proper water-salt balance. But such care can only give the thought-cells of the soul optimum facilities for maintaining health; and if the thought-cells themselves remain sufficiently active and discordant they will not permit the production of proper chemical balance in spite of these facilities.

With an over stimulation of the back pituitary, due to such discords, the feeling for others in distress may become overmastering, and thus result in inability to afford practical help. And with an undeveloped back pituitary, there is a tendency to be cruel and to brook no interference from sentiment of any kind.

In addition to care with the water-salt balance, and furnishing abundant vitamin B-2, there is need to provide for beneficial Moon thought-cell activity. And because they act as natural antidotes, there is nothing better for this purpose than harmonious Mars thoughts. Mars expresses discordantly as anger, belligerency, harshness, destructiveness, undue haste and over expenditure of energy. Such Mars expressions offer little help to discordant Moon thought-cells. Anger and irritation bring responses from the emergency hormone, adrenaline.

But Mars expresses harmoniously as courage, constructive activity, and in protecting the weak and helpless. These Mars expressions bring a response from cortin, which tends to counteract pituitrin secretion. And—especially aggressive yet harmonious thoughts relative to protecting the weak and helpless and providing for those unable to care for themselves—these harmonious Mars thoughts added to the discordant Moon thought-cells result in a thought-element combination which gives thought-cell activity of a kind which helps establish proper water-salt balance, emotional stability, food digestion and assimilation, and the proper development of lymphatic cells.

The Sun and the Thyroid Gland

—United by a connecting strip, the thyroid gland consists of two masses of glandular tissue close to the larynx, lying either side of the neck above the windpipe. Its enlargement is known as goiter. Its glandular principal, thyroxin, which controls the rate of metabolism and energy production, is about 60% iodine. Iodine is one of the minerals present in sea water, and lack of this element in the blood stream prevents the manufacture of thyroxin. The thyroid gland responds not merely to the thought-cell activities mapped by the Sun, but also to those mapped by Venus. Thus too much emotional excitement, or too great a proportion of proteins and fats in the food places a strain on thyroxin production. But in spite of regulating those other foods, and in spite of any amount of right thinking, the absence of iodine in the foods will result in serious thyroid disturbances.

Some soils, especially those formed from sea deposits, contain iodine. Water filtering through such ground contains iodine, which is acquired by drinking the water, and vegetables and fruits grown on such soils contain iodine. Even milk from cows drinking the water and eating the vegetation from such ground contains iodine. But other soils made from igneous rocks where there has been no sea deposit, lack iodine, and people living in these regions commonly develop goiter.

For instance, in Yellowstone River Valley millions of dollars' worth of calves, colts, lambs and pigs were lost each year due to thyroid deficiency because of lack of iodine in the soil. Thyroid strain is readily handed on from mother to unborn offspring. And in this region the loss of young animals due to this cause has been overcome by giving small doses of iodized salt to the mother while carrying the young.

In the United States certain areas are goiter regions, due to iodine deficiency, especially in the states about the Great Lakes and the St. Lawrence River, Colorado, Utah and the Pacific Northwest. The region of the Alps in Europe, embracing Switzerland, parts of the Balkan States, Italy, France and Germany are also thus affected. And in Asia we find the Himalayan Mountains of Mongolia to be iodine deficient, with goiter prevalent.

This relation of maintaining a blood stream with a mineral content similar to sea water is not confined to land animals; for fish hatcheries were faced with the same problem, especially when the young, as was customary, were fed on liver, a food which requires more iodine for proper handling. Both salmon and trout thus raised developed goiter; but the goiter disappeared when a trace of iodine was added to the fresh water in which they were being raised.

Children with thyroid deficiency fail to grow. Except the skull, the bones and cartilage fail to develop; the temperature is low, the hair thin, the nose flattened, and the hands and feet are broad and clumsy. Such dwarfish children are known as cretins. They are always mentally deficient. Many such a moron has been made into an intelligent citizen by building up his supply of thyroxin, the hormone of the thyroid gland.

While goiter is a definite indication of a disturbance of the thyroid gland, all thyroid disturbances do not manifest as goiter. But as might be expected from the knowledge that the thyroid controls the speed of energy production—the rate of fuel combustion—an over active thyroid tends to too great a consumption of fuel, with a corresponding restlessness and increased activity, while a deficient thyroid activity tends to low consumption of fuel, subnormal temperature, and mental and physical sluggishness.

The individual with an over active thyroid is the live wire high-pressure individual who works early and late, who sleeps unsoundly because he is anxious to do something the next day, and who never takes on weight no matter how much he eats. Such an individual tends to a fair or ruddy complexion. Aspects of Mars to the Sun, in particular, tend in this direction; the increased flow of adrenaline from the adrenal medulla assisting in the mobilizing of fuel.

Unless the front pituitary secretions that respond to the Sun are at the same time strong, to give endurance, such an individual tends periodically to break under the strain. If, however, the other glands are active enough to support the thyroid intensity, especially the adrenals, the pituitary and the parathyroids, he becomes the type of individual who drives himself and controls others through possessing more endurance, initiative, energy and mental activity than his fellowman. Leaders in industry and politics who, commencing at the bottom, by their own efforts work to the top, have such a glandular combination as this.

In contrast to these are the people who, permanently as shown by heavy afflictions involving Sun and Venus in the birthchart, or temporarily while there are heavy progressed afflictions involving afflicted birthchart Sun or Venus, have subnormal thyroid activity. There is a tendency to dry hair, to sallow complexion, to irregular teeth, to dry rough skin, to cold bluish extremities, to chilblains, to obesity, and either to dullness of intellect or, if the pituitary is active, to a good intellect but with not enough energy to enable it to do much work. This particular type, because the fuel of the food cannot be burned, becomes clumsy in action and tends to take on weight in spite of careful dieting.

The endocrine glands constitute an interlocking system, and anything affecting the secreting of hormones by one gland in some measure affects all the other glands, and the thyroid is thus especially sensitive to the action of the hormones of the other glands, as might be expected from the fact that the aspects of any planet to the Sun are so significant in affecting the vitality. And, as its responsiveness to Venus would suggest, the thyroid is also sensitive to the slightest change in the emotions.

After all, the amount of energy needed at a particular time, and the amount of heart (Sun) action are indicated by the emotions (Venus). Some emotions slow down the bodily activity, some accelerate it, some give it harmonious tone and some place it in a condition to meet disagreeable situations. Invasion of the body by bacteria or viruses and the disposition of their products is also a problem to be met. And it is common knowledge that when the vitality is high there is little danger of infection. Thyroxin from the thyroid glands is an antidote to toxins and poisons, and resists infection of any kind.

Fuel combustion and vitality are closely related. It is not strange, therefore, that the gland which regulates the speed of fuel consumption should respond with facility to the planet ruling the most readily available fuel, the carbohydrates (Venus), and to the planet controlling (Sun) and regulating the fuel combustion. This control over the activity of the thyroid gland exercised by the Sun is chiefly carried out by means of one of the hormones of the front pituitary gland.

The Sun and the Front Pituitary Gland

—The endocrine system as a whole, including the various hormones of the front pituitary gland, is ruled by the Sun. And of the foods, the vitamins are ruled by the Sun. These chemical substances, some manufactured in the human body, and some taken into the body in the form of food, are minute in quantity, but they exercise profound control over the general chemistry and functions of the human organism.

The Sun is the ruler of the vitality. The thought-cells mapped by it in the chart of birth determine the amount of ability the individual has to recover from disease or injury; and the physical agents of such ability are largely the endocrine secretions and the vitamins. To maintain vitality, therefore, when the Sun is heavily afflicted, especial attention should be paid to providing the system with all the vitamins and, through the thoughts and emotions, to keeping proper endocrine balance.

In addition to its general rule over the endocrine glands and the vitamins, however, not only the thyroid gland, but two hormones of the front pituitary gland respond with alacrity to the thought-cell activity mapped by the Sun. And it has now become known that three things in particular are needed in the food if these front pituitary hormones are to be manufactured in normal quantity. One of these is a supply of manganese. Just as there must be sufficient copper and iron for the blood, and sufficient calcium for the parathyroid glands to keep the nerves steady, so it is now found that a deficiency of manganese prevents the proper regulation of fuel by the front pituitary. The table on page 227 indicates the best food sources of this mineral.

The other two known essentials for proper functioning of the front pituitary gland are vitamin A and vitamin B Complex. The fat-soluble pigment called carotene, because it gives the yellow color to carrots, is converted into vitamin A in the liver. Certain fish liver oils contains it in a high state of concentration, and it is abundantly present in dairy products and green leaf vegetables. A table showing the best food sources is given on page 290 of lesson No. 225. An afflicted Mars or an afflicted Venus, as well as an afflicted Sun, calls for abundant vitamin A.

Vitamin B Complex, which is so essential in the food if the front pituitary gland is to function normally, was the first vitamin to be described and experimentally demonstrated. It was originally called simply vitamin B. Later it was found to be two vitamins, one of which retained the name vitamin B and the other was called vitamin G, using the initial letter of the name of Goldberger, who did considerable work isolating it. Still later the original vitamin B was found to comprise many different vitamins, twelve of which have now been positively identified, with other factors evident which have not as yet been isolated. With the discovery of various vitamins in what was originally called vitamin B, the various components have been renamed. They are discussed in lesson No. 221.

In 1884 beriberi, which is denoted by swelling, inflammation of the nerves, loss of coordination between the muscles and a gradual paralysis of the limbs, was epidemic in the Japanese Navy. Admiral Takaki had come to the conclusion that this condition was due to the diet of the sailors, which consisted chiefly of rice and other starch foods, and very little protein. By way of experiment, on a nine month cruise, one training ship of 276 men was given the usual rice diet. 169 came down with beriberi, and of these 25 died.

Then he sent another training ship over the same route with about the same number of men for ten months. On this occasion the rice was reduced and replaced by other types of food. During this trip only fourteen cases of beriberi were evident, and all of these had refused the new diet and continued with rice.

Some twelve years later Dr. Eijkman, a Dutch physician working in Java, observed an epidemic among his fowl which were fed on unused cooked rice. And by experimenting he found that he could induce beriberi in the fowl by a diet of polished rice, but that the disease could be prevented, or cured, by unmilled rice or rice polishings. He concluded that something contained in the brown, or unpolished rice, was absent in the white, or polished rice, and that it was essential to health.

The publication of his observations in 1897 led British and American workers in the Orient to give systematic attention to the nutritional aspect of beriberi; but it was not until after the turn of the century that the aneuritic constituent of foods, the absence of which gave rise to beriberi, was shown to be an organic substance more stable in acid than in alkaline solution, and was named vitamin B. Now that vitamin B has been divided into various constituents it has been found that beriberi is primarily due to an insufficient supply of thiamine, which is also called vitamin B-1. A table showing the best food sources of vitamin B-1 is given in lesson No. 222. A table giving the best food sources of riboflavin, which is also called vitamin ES-2, and used to be called vitamin G, is given on page 226. As the other factors of vitamin B Complex are so commonly associated with these two B vitamins, there is little likelihood that the person who includes vitamin B-1 and vitamin B-2 abundantly in his diet will lack in any of the other factors of the vitamin B Complex.

Use More Harmonious Thoughts of Vitality and Power to Recondition Discordant Sun Thought-Cell Activity

—To facilitate the healthful work of the Sun thought-cells when the Sun is afflicted, the diet should contain iodine, manganese, vitamin B Complex and vitamin A. But these foods can only supply the materials which make the work easy; of themselves they cannot do the work. And if the Sun thought-cell activity remains sufficiently discordant, the vitality will be lowered in spite of any foods which may be eaten. What happens in the body is not due to influences from but one plane, but from two. And to maintain vitality and health when the Sun is afflicted, particularly while there is a heavy progressed affliction involving it, requires that the thought-cells it maps be given a more normal and harmonious activity.

It is not considered that the Power thoughts ruled by the Sun have, or need, any antidote. They combine readily with other thought-elements. The compound so formed is beneficial or detrimental, not so much due to the other thought-element entering into it as due to the harmony or discord accompanying the combination.

There cannot be too much of the Power thought-elements in the soul; and a great deal of failure and lack of vitality in the lives of most people is due not so much to the discord in these thought-cells mapped by the Sun as to their lack of energy. Thoughts, efforts and other experiences relating to significance have been too few and lacking in intensity in the soul's past to build up these thought-cells and enable them to have activity enough for outstanding accomplishment.

Nevertheless, with such energy as they possess, these thought-cells when given a new supply of discordant energy by a progressed affliction involving the Sun tend to upset the health and lower the vitality through their action on the thyroid and front pituitary glands. What they need is reconditioning through which the same thought-elements are reorganized into a harmonious combination.

Either undue pride or shame should be perceived as the useless thing it is, inferiority complexes and superiority complexes should be dissolved in the knowledge that the individual is important in the cosmic scheme of things, neither more nor less so than others, and that he is warranted in a feeling of self satisfaction whenever he does his best, be that little or much.

Joy should be cultivated in attaining significance through efforts that benefit others. Almost any person can find something to do which will secure the esteem of others, or at least, through benefiting others will heighten his own opinion of himself. Working to unselfish ends with joy in the accomplishment adds harmonious thought-elements to the thought-cells mapped by the Sun in such a manner that they tend to recondition these thought-cells so that their activities are harmonious. Harmonious Sun thought-cells, to the extent they have proper foods with which to work, give healthful activity to the thyroid and front pituitary glands and otherwise contribute to the vitality.

Pluto and Adrenal Cortex Activity

—Pluto is a planet of opposites. It may be either as negative as the Moon or as positive as Mars. Its thought-cells in the soul find ready response from four different endocrine glands, and hence the foods when Pluto is afflicted should be numerous enough to give these glands the materials in abundance which they must have if they are to keep in good working order.

The secretion of the pineal gland, which also responds with alacrity to the Neptune thought-cells, together with parathyrin, induces a negative sensitiveness. This negative sensitiveness greatly facilitates Feeling extrasensory perception. The pineal secretion also depressed the manufacture of, and tends to neutralize, both cortin and adrenaline, the chief chemicals (thyroxin also in less degree does this) with which the body fights invasion and makes harmless the toxins left in the blood by invading organisms. Pineal secretion, while it has a useful function, makes the body more susceptible to infection and poisoning.

When under the activity of the Pluto thought-cells the pineal secretion and the parathyroid secretion are more powerful than the front pituitary hormone ruled by Pluto, and cortin, which Pluto influences, the resulting condition is very similar to that produced by Neptune. And if the aspect giving rise to the Pluto thought-cell activity is discordant, the health suffers much as it would under an affliction involving Neptune.

On the other hand, if the cortin supply, due to its stimulation by Pluto, and the hormone of the front pituitary gland which responds to Pluto, are more powerful than the pineal hormone released, the electromagnetic condition produced is positive, and the extrasensory perception which is readily developed is of the inner-plane Intellectual type. And under these conditions—the balance seemingly being determined by the Pluto front pituitary hormone—if the aspect giving rise to the Pluto thought-cell activity is discordant, the health suffers more in the manner it would if under a Mars affliction.

As Scorpio rules the lower part of the kidneys, as well as the sexual organs, the kidneys may be affected by an aspect involving Pluto, as well as by an aspect involving Venus or Mars. And this Scorpio affinity is still further manifested by the power of the front pituitary hormone which responds to Pluto to stimulate the gonad glands, which respond more directly to the thought-cell activity of Venus or Mars.

The negativeness induced by afflictions involving Pluto, in addition to producing a feeling of sensitiveness similar to that influenced by Neptune, tends also to the purely mediumistic type which is associated with the Moon. And those who become controlled by some inner-plane entity against their wills, in contrast to those who sit for development and seek a controlling guide, seem always to have this Pluto type of negativeness which invites coercion.

While even in its positive expression Pluto when discordant can do much damage, one of the things that should be sought under an affliction of Pluto is to prevent a development of negativeness. As the parathyroid glands are influenced by Pluto thought-cell activity, calcium and vitamin D with which to handle it, are requisites. And to enable the front pituitary hormone which responds to it, and which stimulates cortin and the gonads, to be secreted in ample amounts, it is as essential that the food contain vitamin B Complex as if there were a progressed affliction involving the Sun. A table showing the best food sources of vitamin B-1 is given in lesson No. 222. And on page 226 of this lesson is given a table of the best food sources of vitamin B-2.

For the adrenal cortex to perform its function normally it must be provided with those substances which are also required when Mars is afflicted; for cortin, the hormone which must be depended upon to keep positive when Pluto is afflicted, while it responds to Pluto, is more directly under the influence of Mars. These foods are low protein and variety of protein; iron, vitamin C, vitamin A, and vitamin B-1.

A table giving the best sources of iron is given on page 291 of lesson No. 225, a table giving the best sources of vitamin A is given on page 290 of lesson No. 225, and a table showing the best sources of vitamin C is given on page 258 of lesson No. 224.

Use Harmonious Mars Thoughts to Neutralize Discordant Pluto Thought-Cell Activity

—On its positive side Pluto in many respects resembles Mars, and if this positive energy can be evoked and made to express harmoniously it is constructive and cooperative, and may be made highly spiritual. Yet Pluto also has many qualities resembling the Moon. And the best thought antidote for discordant Pluto thought-cell activity is the same as that for discordant Moon thought-cells.

To add these Mars thought-elements to the thought-cells mapped by Pluto, not only should pleasure be cultivated in keeping positive and aggressive in the interest of Universal Welfare, but activities should be deliberately undertaken which call for initiative, courage and even combat, to defend the rights of people, to relieve oppression, and to further the cause of universal progress.

These activities should not be permitted to cause feelings of discord. They should be cultivated in a spirit of joy in being helpful. The thoughts thus added to the Pluto thought-cells will cause these cells to conduct their activities more positively and more harmoniously. They will, if proper foods are provided, cause ample secretion of cortin to prevent negativeness, and normal secretions by the parathyroid glands, the front pituitary which responds to Pluto, and the pineal gland. And should the individual so desire, they will assist in generating those highest-frequency electromagnetic radiations of the nervous system which enable him to extend his consciousness on the inner plane.

Chapter 9

Serial No. 224
Original Copyright 1949
Elbert Benjamine

Copyright
August 2002
Church of Light

What To Eat When Jupiter,
Saturn Or Neptune Is
Afflicted

Best Sources of Vitamin C
Approximate International Units per oz. of fresh food

Red Peppers	1300	Fresh Soy Beans
240		
Mustard	950	Dandelion Greens
240		
Green Peppers	800	Lime Juice
215		
Kale	700	Beef Liver
215		
Parsley	575	Lamb Liver
215		
Spinach	435	Beet Greens
200		
Cauliflower	435	Tangerine
200		
Broccoli	435	Asparagus
200		
Lemon Juice	340	Calf Liver
185		
Mustard Greens	340	Cantaloupe

Best Sources of Sulphur
Percentage of edible food.

Mustard	1.230	Entire Wheat181
Dry Lentils277	White Flour177
Hard Cheese263	Dried Lima Beans175
Dried Beans240	Macaroni172
Lean Beef230	Walnuts172
Clams224	Entire Rye170
Peanuts224	Dried Sweet
Corn .167			
Dried Peas219	Watercress.167
Egg White214	Almonds160
Egg Yolk208	Entire Barley153
Cocoa203	Corn151

Chapter 9

What To Eat When Jupiter, Saturn Or Neptune Is Afflicted

TO keep the human engine running there must be present a fuel supply which can be burned. If the fuel supply becomes exhausted the engine stops running; the person dies of starvation. To prevent this catastrophe people commonly supply the body with fuel by eating several times a day. But as such an intake of suitable food is not always possible, the body has provided for shorter and longer periods during which no food may be had, or during which the food to be had may be poor in fuel values. Provision has been made for fuel storage. And even as Jupiter rules both finances and bankers who take care of people's money reserves, so Jupiter also rules both the chief fuel reserve, fat, and the hormone which stores the more readily available form of fuel.

Venus, through its natural second house rulership, has some significance relative to cash; and Venus rules the carbohydrates—the sugars and starches— which are the most economical and readily used fuels. These carbohydrates become simple sugar, monosaccharides, chiefly glucose, in the process of digestion. As such they are soluble and carried in the blood to the tissues to be burned as fuel. Being soluble they cannot be stored as simple sugars, but any not immediately used, if not converted into some other non-soluble substance, is carried out of the body in the urine. The blood, to remain healthy, must contain about 1 part in 1,000 of the simple sugars.

**JUPITER
AFFLICTED**

CALLS FOR

**SULPHUR AND CARE
WITH SUGAR AND
FAT**

**SATURN
AFFLICTED**

CALLS FOR

**VARIETY IN
MINERAL SALTS,
VITAMINS AND
PROTEINS**

**NEPTUNE
AFFLICTED**

CALLS FOR

**ENERGY FOODS,
CALCIUM, VITAMIN
D, VITAMIN B-1, AND
LESS PROTEIN**

Under the influence of the Jupiter hormone, insulin, normally some of the simple sugar in the blood is converted into animal starch, called glycogen, and stored in small amounts in the muscles and other active tissues, and specifically in the liver, ruled by Jupiter, that is the emergency bank. The amount of deposits which the emergency bank can handle is limited, and for more permanent, but less available reserve, some of the sugar of the blood combines with fatty acids to produce fat.

Fat also is ruled by Jupiter, and when the fat of foods is digested the fatty acids and glycerol into which it has been split, shortly re-combine to form tiny globules of fat which are carried by the blood stream to various parts of the body where together with the fat particles manufactured from the simple sugars, they enter into the formation of the regular reserve fuel supply by becoming fatty tissue.

Jupiter and the Pancreas Gland

—The pancreas, which in animals usually is called sweetbreads, is an elongated gland having a head, a neck, a body and a tail. The head is tucked into the loop formed by the duodenum, while the body stretches across the abdomen in front of the aorta and behind the stomach, so that the tail come into contact with the spleen. Most of the tissue of this gland has the function of manufacturing the pancreatic juice which is so essential to digestion. It has a main duct which pours the pancreatic juice into the bowels. We here, however, are not concerned with the function of this duct, but with a little collection of cells throughout the pancreatic tissue, known as the islets of Langerhans. It is the function of these islands to produce the Jupiter hormone, called insulin, which is necessary not merely to store sugar up as glycogen, but also to burn it as fuel.

Protein, the non-fatty tissue of the body, affords a third and final fuel reserve which can be used, but its extensive use for fuel is both costly and unsatisfactory. And even fat cannot be burned without clogging the blood stream unless there is sugar to burn with it, and some insulin to assist the sugar and fat combustion. And as the immediate intake of sugars and starches may not be sufficient to provide for this, they are converted into glycogen through the action of insulin.

Because sugar is the most economical fuel supply, in regard to its ready conversion into energy, it might be thought that a high sugar consumption is to be recommended to all and sundry. People, however, vary markedly, according to the thought-cell activity mapped in their birthcharts and their corresponding body chemistry, in their ability to handle sugar. Cane sugar, which is the common refined variety is sucrose, a disaccharide which to be handled properly in the blood stream must be converted into the monosaccharides glucose and fructose. Neither saliva nor the gastric juice is capable of this conversion. It must be done by the hydrochloric acid of the stomach, or by the sucrose of the intestinal juice. And if Venus is heavily afflicted, with the thyroxin supply adversely afflicted, this conversion may be incomplete, and place an unusual strain upon the insulin in the endeavor to handle.

Those who thus have difficulty in the proper conversion of cane sugar and pastries, often find they can partake of ample sweet in the form of fructose, the sugar of fruits and honey. Fructose constitutes about half the solid matter of honey. The sugar of milk is a disaccharide, which must be converted into galactose in the process of digestion; but some stomachs do this readily which do not handle starch and cane sugar so well. Galactose is a monosaccharide which is readily utilized for the production of glycogen. And glucose—dextrose, grape sugar, corn sugar, starch sugar, diabetic sugar—is most easily handled and readily converted into glycogen through the action of insulin.

Insulin is the hormone which handles the sugar of the system. It acts as the teller of the bank, storing it up when there is an excess, and returning it to circulation on the demand of the other glands. Sugar and fat are the standard currencies of the body, protein being subject to very limited use. And blood sugar, or glucose, from the carbohydrates, is the kind of currency easily available. The more sugar is taken in the diet the more insulin there must be to handle it properly. And the more fat there is in the diet the more insulin there should be, because it requires sugar to burn fat and because insulin helps in the combustion of both. This means that the consumption of too rich foods places an undue strain upon the body banking system.

The glands which chiefly govern currency withdrawals are the thyroid gland and the adrenals. Under optimal conditions there is a very nice balance between thyroxin, secreted by the thyroid gland and responding to the thought-cell activity mapped by Sun and Venus, and insulin, secreted by the pancreas and responding to the thought-cells mapped by Jupiter. Also a very fine balance between adrenaline, secreted by the adrenal glands, and responding to the thought-cell activity mapped by Mars and Saturn, and insulin. Heavy afflictions to any of these planets in the chart of birth may indicate sufficiently discordant thought-cell activity that the over or under production of one of these three hormones tends to upset this balance. In this manner a PREDISPOSITION is indicated. Then when a progressed aspect involving one of these planets occurs, adding energy to the thought-cells to which one of these three glands respond, the production of its hormone may be sufficiently influenced that the health is pronouncedly affected. If, for instance, under a progressed affliction involving the Sun or Venus and Mars or Uranus the thyroid becomes too active, the excessive secretion of thyroxin, which tends to counteract the storing action of insulin, may cause an excessive consumption of fuel and tend to wear down the insulin supply. Such an over active thyroid uses up the reserve supply of glycogen in the bank, and permits insulin to make no new deposits in the liver. This leads to a shortage of cash with which to carry on the business of the body.

On the other hand, under a progressed affliction involving the Sun or Venus with Saturn or Neptune the thyroid may become sluggish while the insulin secreting gland continues active. In such an instance, glycogen is stored in the liver and tissues, and fat accumulated, resulting in obesity. The bank then becomes an institution devoted to hoarding, where cash is deposited but cannot be withdrawn. Such fats as are

withdrawn fail to oxidize completely, fail to become satisfactory legal tender, because the sugar necessary to burn with them is not available. This causes excess acidity of the blood, and the individual, if the case is extreme, yawns and sighs and appears bored and lazy and stupid; because the fuels within his body are merely smoldering.

A somewhat similar condition, with low resistance to infection, may arise from inactive, weak, or worn-out adrenal glands. Adrenaline assists in the quick mobilization of sugar for emergency purposes. That is, it overcomes the action of insulin and causes the liver to release it. And it promotes rapid combustion of the sugar thus released. When there is not enough adrenaline to counteract the hoarding tendency of insulin, the person is easily fatigued, has no reserve power, is mentally unstable, and tends to be nervous.

Yet, under the influence of too active and discordant Mars or Saturn thought-cells, or the emotions ruled by either Mars or Saturn, if the adrenaline secreted becomes excessive, it wears down the resistance of insulin to the withdrawal of funds. The individual then becomes weakened, not because he

has an excess of fuel which he cannot use, but because he has become a spendthrift and does not retain enough fuel in his system to produce the required energy. The sugars, especially, are neither stored nor retained in the blood. Instead of being converted, through the action of Jupiterian insulin, into glycogen, or transformed into fat, they remain simple sugar, which is soluble, and passes from the body before there has been opportunity to burn it.

Because the thought-cell activities of so many planets are involved in maintaining a proper balance between thyroxin and adrenaline on the one hand and insulin on the other, no widely applicable rules can be laid down as to the amount and kind of carbohydrates (sugars and starches, ruled by Venus) which should be contained in the food in proportion to the amount of fats. Some people, with a well aspected and not too prominent Jupiter, have a strong enough insulin supply that they can handle even large quantities of white cane sugar and pastries made with it. Other people, especially those with Jupiter prominent and severely afflicted, find even the sugars contained in fruits and vegetables hard to handle, and that a diet high in fat, with just enough of the sugar producing foods to burn the fat, is more satisfactory. Some fat, either from animal or vegetable sources, is a necessity in every diet. But certain people handle fat poorly, and find the sugar producing foods more satisfactory. Those with a tendency to psoriasis, in which unsightly and itching scales form on the body, may have to reduce the fat in their food to the minimum. And it should not be lost sight of that when the tissues are supplied with more fats than they can burn, that this fat is stored. Furthermore, there is good evidence that a high-fat diet is related to hardening of the arteries.

Were there not several glands and a number of planets involved—Venus and the thyroid, and an upper-octave planet and the parathyroids, in the production of eczema, for instance, which is responsive to such foods—it might be possible to indicate from the chart of birth and progressed aspects the relative proportion of starch and sugar foods to fats that the individual diet should contain. As it is, taking planetary positions as indicating tendencies to glandular activities of a certain kind, we also need to gain information from experience. Experience commonly tells people about how well they handle sugar, how well they handle certain starch foods, and how well they handle fats and oils. Yet in addition to such experience it should be borne in mind that whenever there is a progressed aspect afflicting the planet Jupiter a tendency is present to upset the balance between insulin, which it rules, and other hormones. Consequently, irrespective of past experience, during such a period, that this imbalance may not be aggravated, but that proper balance may be restored, the sugar and fat content of the diet should be carefully watched.

A prominent Jupiter in the birthchart, especially if afflicted, tends toward eating too much food or too rich foods. And a progressed affliction involving Jupiter increases this tendency. Yet even when the diet is rather restricted as to the quantity, there may be an over supply of sugar, or an over supply of fats. The liver, which is the chief storehouse of glycogen, may easily be overworked at such a time, or fats may become too abundant, with a tendency to take on undue weight and develop the Jupiter type of acidosis.

In lesson No. 153—Diet and Breathing—I have pointed out that for health it is necessary that the blood stream should be kept slightly alkaline, and on pages 66 and 67 of that lesson tables are given indicating which of the foods tend to give the blood stream an acid reaction, and which, through the alkaline residue they leave tend to overcome the acid condition and restore the favorable alkaline balance. The mineral salts in the foods which tend to neutralize the acid forming elements in other foods and the acid toxins are ruled by Saturn. When Saturn is afflicted the usual tendency is toward a deficiency of these mineral salts in the food and the formation of what may be called a deficiency acidosis.

It should be apparent, however, that regardless of the amount of alkali-forming mineral salts in the food, if the blood stream contains enough of the acid-forming elements it will continue acid. When the acidosis is the result not of alkali-forming salts, but of too great abundance of the acid-forming elements, we can call it repletion acidosis.

The eating of too rich foods and too much fat tends to load the blood stream with such excess, and when not enough sugar is burned in the combustion of fat as fuel, the fat is not completely burned, and the diacetic and other fatty acids are liberated in the blood stream. Such repletion acidosis is called ketosis, and is the type which tends to develop under the activity of the Jupiter thought-cells when this planet is prominent and afflicted.

To the extent active and discordant Jupiter thought-cells influence the health adversely, the difficulty is chiefly caused by too great an abundance of food or food too rich or greasy for the system to handle, or by an imbalance between insulin and the other hormones, or by all of these. As Jupiter rules the arterial blood, an impure blood stream may result; and as it rules the liver, there may be difficulty with the liver or the pancreatic gland and the secretion of insulin.

When insulin, ruled by Jupiter, is no longer produced, sugar and starch cannot be used as fuel by the body, and diabetes results. Before the hormone insulin was isolated from animal pancreas in 1922, diabetic patients were doomed to coma or starvation. Now commercially prepared insulin obtained from animal pancreas enables 300,000 diabetics in the United States to lead lives not far from normal.

For the liver to perform its functions normally, and for the proper production of insulin by the islets of Langerhans, there must be sufficient sulphur. When Jupiter is afflicted, and particularly during the time there is also a progressed affliction involving Jupiter, the food should contain an abundance of sulphur. The table on page 259 indicates the best food sources of sulphur.

Use Harmonious Mercury Thoughts to Neutralize Discordant Jupiter Thought-Cell Activity

—When Jupiter is afflicted the diet should be rich in sulphur, the individual should abstain from rich food and from eating too much, and care should be used as to the amount and proportion of sugar and fat in the diet. But all that can be done with food is to afford optimum facilities of work for the glands and other functions. No amount of thinking will precipitate sulphur. It must be present in the food. But no amount of sulphur, no lack of rich foods, and no care with sugar and fat will maintain health when Jupiter is heavily afflicted by progression if the Jupiter thought-cell activity remains vigorously discordant.

Just as there is nothing better to counteract too active or discordant Uranus or Mercury thought-cell activity than harmonious Jupiter thinking, so there is nothing better to counteract discordant Jupiter thought-cell activity than harmonious Mercury thoughts. They are the natural antidotes. To apply them thus, pleasure should be cultivated in an intellectual appraisal of events and conditions, as opposed to an emotional or impulsive reaction. Pleasure should be cultivated in learning the best diet requirements, and in resisting the appetite for other foods. Pleasure should be cultivated in discrimination in all affairs of life, and in resisting impulse. The thought-elements thus created will, because they are deliberately cultivated to offset the discords of Jupiter thought-cell activity, enter into combination with the Jupiter thought-elements to create more harmonious thought-cells. And these in turn will tend toward normal secretion of insulin.

Insulin exhaustion, while aided by discordant Jupiter thought-cell activity, is usually due also to the action of discordant Saturn thought-cells or discordant Mars thought-cells, which causes excessive secretion of adrenaline, or to the action of discordant Sun thought-cells or discordant Venus thought-cells which induces excessive secretion of thyroxin. These hormones, which respond to emotions or exhaustion, counteract the power of insulin, and if too freely present in the blood stream, especially if an afflicted Jupiter gives weak insulin secreting power, may wear out this insulin secreting power of the islets of Langerhans.

Saturn and Mars and the Adrenal Glands

—All organisms on earth since the first life on this planet have been subject to attempted invasion by foes. Every life-form that survives in a physical body has developed some means by which it gets away from its enemies or by which it defeats them. The fleetness of the hare and the spines of the cactus have been developed thus. Even the human infant, only a day or two old, exhibits both of these traits. When restrained in its movements at first it tries to get away, but not succeeding in this, it shows unmistakable signs of anger. And its early success in one of these endeavors often conditions its after life, whether it will try to overcome, or will run away from, the difficulties it meets.

I point out this close relation between running away and fighting because the running away impulse is ruled by Saturn and the fighting impulse is ruled by Mars, and at first thought it would seem that they were functions that must be controlled by entirely different processes of the body. And so they are; for whether the habitual reaction is to be combat or flight is determined by the strength of the cortin supply ruled by Mars and in less degree by Pluto, and the front pituitary hormone ruled by the Sun.

Yet either to run away successfully or to fight successfully requires energy and coordination. The amount of energy that can at once be mobilized into running away, when the enemy is too powerful to be destroyed, determines the chance of survival. But if the enemy is to be destroyed, the amount of energy that can be mobilized for combat determines the chances of survival. Thus both the thought-cell activity mapped by Saturn and the thought-cell activity mapped by Mars require similar abundant energies to carry out their purpose. And to control this mobilization of emergency energy the adrenal glands have been developed.

The adrenal glands are two small bodies, each of which sits like a cocked hat astride one of the kidneys. Each also is double, consisting of a cortex, or outside covering, and a medulla. Cortin, the secretion of the cortex, also responds to the activity of the Mars thought-cells, and somewhat to the activity of the Pluto thought-cells. But it is with adrenaline, the secretion of the medulla, or inner portion, that we are here concerned, because it most violently opposes the action of insulin.

Before fuel can be released it first must be stored through the action of insulin. Under the hum-drum conditions of everyday life, and even under the influence of affection and the less strenuous activities, sufficient release is afforded by thyroxin, the hormone of energy production from the thyroid gland. But in situations of peril there is need for great quantities of immediately available fuel for fighting or for flight, or when the stress of pain or intense or prolonged exertion must be met. For this purpose adrenaline is released in response to fear, anger, powerful emotional excitement, intense pain and prolonged and strenuous exertion. Mars is the planet of fight, and Saturn is the planet of flight. Both Mars and Saturn are involved in prolonged strenuous exertion, and one or both in the stress of pain. And adrenaline, which is the hormone of emergency energy, is released by the thought-cell activity of either Mars or Saturn.

When adrenaline enters the blood stream it causes the liver to discharge its stored sugar into the blood and the activities of the alimentary canal to cease. This means that people who worry tend to impair digestion and assimilation; for worry is a mild but chronic state of fear which releases at least small amounts of adrenaline. And it means that people who are recurrently irritated tend to impair digestion and assimilation; for irritation is a mild state of anger which releases at least a small amount of adrenaline. Adrenaline draws the blood and electrical energy away from the digestive and assimilative functions to be used for emergency purposes; and food cannot be properly handled while the blood and electrical energy are thus diverted.

Intense pain, overwork, or emotional excitement of any kind releases adrenaline; and as a consequence people in much pain, people who overwork, and people who are in a recurrent state of emotional excitement of any kind tend to have difficulty with digestion and assimilation, because the blood and electrical energy required for the proper handling of food has been moved to other parts of the body for the purpose of meeting real or imaginary emergency. Adrenal glands take it for granted the brain knows when there is an emergency, and they do not question whether the emotion to which they respond is based on fact or fiction.

Other than drawing great quantities of sugar into the blood and causing the activities of the alimentary canal to cease, adrenaline causes the skin to become moist and greasy, the hair to stand on end, the pupils to dilate, and more blood to be squeezed from the blood lakes of the liver and spleen. These reactions helped our evolutionary ancestors when they fought, or when they sought to escape from a too powerful foe. And to mitigate the danger arising from wounds inflicted in struggle, adrenaline neutralizes toxins in the blood and causes the blood to clot more readily. Either an animal or a person wounded while in a passion or under stress of excitement has a much better chance of recovery than if accidentally wounded when not so aroused.

From the action of adrenaline also comes the athlete's second wind by which, after he has reached a state of exhaustion, he suddenly becomes refreshed and apparently possessed of more energy than he had at the start. Exhaustion brought on by great exertion is an emergency, and to meet the demand for more energy adrenaline releases a new supply of fuel from the liver into the blood. This restores the original tone of the nerves and muscles, and reinforces the activity of the brain. The adrenaline also operates to neutralize the lactic acid released into the blood during exertion, and the other toxins which contribute to fatigue. Thus is the whole system refueled and refreshed.

The adrenal glands have been conditioned to give their characteristic response when the mind thinks certain thoughts. It is the function of the mind to perceive whether or not there is an emergency; for the glands are unable to analyze the situation. It is their function to respond in a certain way whenever the impulse comes through from the objective consciousness or from the unconscious mind that a "fight or flight," situation is present.

When Mars is afflicted in the birthchart, and especially during such periods as there is a progressed aspect involving Mars giving new energy to the thought-cells mapped by Mars, there is a strong tendency toward anger, irritation and a feeling of haste which not only places a strain on the adrenal glands but on the insulin secreting powers which adrenaline tends to neutralize. A jazz environment, and emotional excitement tend to call out emergency fuel in much the same way and thus weaken the insulin secreting powers through increasing the supply of thyroxin in the blood stream.

Work that can be done at all usually can be done better without prolonged strain, even as the athlete permits his muscles to be quite relaxed until the moment they are called into use. And a prodigious amount of work, either physical or mental, may be accomplished every day, one day after another, without impairing the health if there is freedom from the mental states which cause excessive secretion of the hormones.

When Saturn is afflicted in the birthchart, and especially during such periods as there is a progressed aspect involving Saturn giving new energy to the thought-cells mapped by Saturn, not only are there tendencies to overwork, but tendencies toward anxiety and worry. These are fear emotions. They are the fear that some situation will not be adequately met. That is, some situation is actually present and, because there is a fear that it will not be handled in just the proper way, or that it will cause defeat, the mind dwells on it, and over and over again goes over the detail of it. Such a problem, of course, should be thought all the way through to the best possible solution. But when the mind having thus thought it over cannot release the thought of it there is indicated a lack of confidence and consequently a fear element. Such worry tends to secrete adrenaline into the blood.

People even get into the mental condition under discordant thought-cell activity that they are in a state of anxiety when confronted by no serious problem. Such chronic anxiety, which is fear that some situation is going to appear which they cannot adequately handle, causes a constant small drain upon the adrenaline supply.

When through worry and anxiety in response to discordant Saturn thought-cell activity, or through irritation and the feeling of being rushed in response to discordant Mars thought-cell activity, and excessive strain is placed upon the adrenal glands, this may lead to exhaustion of the adrenaline supply with a consequent lowering of the ability to resist infection. Or, especially if Jupiter is heavily afflicted, the adrenaline supply may hold out longer than the insulin supply which it tends to overcome. In this case the liver is unable to retain or store sugar, and diabetes results.

Of the many charts in The Church of Light files of those who have had diabetes, not only is Jupiter prominent and afflicted, but Saturn also. And at the time the disease developed there was a progressed aspect involving either Jupiter or Saturn, and frequently a progressed aspect involving each. This means that worry or strain, causing adrenaline to be secreted, is the more common immediate condition which enables the weakness of the islets of Langerhans indicated by the afflicted Jupiter to create difficulty.

Saturn and Deficiency

—Yet not only may insulin depletion result from either weak islets of Langerhans, as indicated by afflictions involving Jupiter, or too copious adrenaline secretion, as indicated by afflictions involving Saturn or Mars, but acidosis may be either of the Jupiter type or the Saturn type.

The afflictions due to discordant Jupiter thought-cell activity are always accomplished through overabundance of something. The over-abundance of incompletely burned fuels in the blood stream gives rise to repletion acidosis, called ketosis. The afflictions due to discordant Saturn thought-cell activity are always accomplished through lack of something. The lack of mineral salts with which to neutralize the lactic acid and acid toxins in the blood stream gives rise to the deficiency type of acidosis.

In lesson No. 153 I have stressed the importance of keeping the blood stream slightly alkaline through providing ample of the mineral salts in the foods; and that when Saturn is afflicted the usual tendency is toward their deficiency. But in addition to preventing the deficiency type of acidosis, the mineral salts perform other important functions in the body's economy, and all the essential ones should be provided in the food.

The vitality and the vitamins are ruled by the Sun. And the tendency of discordant Saturn thought-cell activity is to lower the vitality through depriving the system of some of the vitamins. In this manner they oppose the harmonious functioning of the Sun thought-cells. When Saturn is afflicted, therefore, special attention should be paid to acquiring not one, but all the essential vitamins in the food.

The red corpuscles of the blood, the muscles, and the cortin hormone which promotes daring and courage are ruled by Mars. The tendency of discordant Saturn thought-cell activity is to weaken the action of these through depriving them of sufficient variety of the proteins. The proteins which form the structural material of all the cells are built up of some 20 amino acids in various combinations. But the human body is not capable of building the various necessary proteins out of certain protein foods. To perform its essential protein building the foods must contain four different amino acids; and all of them are seldom present in any single protein food. Thus when Saturn is afflicted attention should be paid to acquiring a wide variety of proteins.

The influence of discordant Saturn thought-cells is not necessarily toward a diet too frugal in quantity, but toward a diet too narrow to supply the vitamins, the mineral salts and the proteins necessary for vitality, strength and health. When Saturn is afflicted, especially during the time there is a discordant progressed aspect involving Saturn, the individual should seek balance and variety in his foods, thus insuring that none of the vitamins, mineral salts or essential proteins are lacking in his diet.

Use Harmonious Sun Thoughts and Harmonious Venus Thoughts to Neutralize Discordant Saturn Thought-Cell Activity

—Saturn thoughts are heavy and laborious, and their natural antidotes are the light, artistic, social and cheerful thoughts ruled by Venus. Pleasant social contacts, musical entertainment, or artistic trends should be cultivated with the object of getting as much cheer, amusement and pleasant emotion as possible out of them. And if they are cultivated for the definite purpose of neutralizing the discords of the Saturn thought-cells, these Venus thoughts will be added by this mental association to those thought-cells and enter into a more harmonious compound with the Saturn thought-elements. The resulting thought-cell activity will then prove more fortunate.

However, Venus thoughts are not vigorous and positive, but tend to be negative; and one of the chief difficulties arising from Saturn thoughts is due to their encouraging negative tendencies. To overcome the negativeness not only due to Saturn thought-cell activity, but which is common also when the Moon thought-cells, Venus thought-cells, Neptune thought-cells or Pluto thought-cells become too active, it is necessary to insure that the energies flow outwardly, instead of permitting the outside condition to cause the flow to be in upon the self. When the Moon

thought-cells are involved, or those of Pluto, the best thoughts for this purpose are those ruled by Mars. But for Venus, Saturn and Neptune negativeness it is better to employ the Sun thoughts and maintain a feeling that the energies of the mind and body are slightly pressing outward while holding thoughts of power, vitality and self-respect.

The brain cells generate electrical charges which make it positive to the rest of the body; the liver being the opposite pole, carrying the strongest negative charges. Fear, worry, grief or other negative thoughts decrease this electrical difference between the brain and liver, which means they lower the vitality; for vitality depends upon the electrical difference.

The attitude of confidence that any situation which may arise will be competently handled, that there is power to overcome any difficulty that may be present through constructive effort, and that one is significant in the general scheme of things, when deliberately cultivated to neutralize discordant Saturn thought-cell activity tends to overcome negative tendencies which otherwise they encourage.

It is well enough to advise others not to harbor fear, not to worry, not to permit anxiety or thoughts of grief, sorrow or despondency. And it is well enough to say that whenever these thoughts or emotions begin to intrude they should be displaced with thoughts of gaiety, with music, and with thoughts of courage and self-esteem, and with actions in which significance is attained through being of service to the community.

But actually to do this requires that the thoughts and emotions it is desirable to entertain shall be furnished with a higher electrical potential than the negative thoughts they are to displace. And this requires not only the cultivation of new thought habit systems, but the maintenance of an electrical potential at the command of the brain high enough to overcome competing electrical currents. When the body is exhausted this is difficult, and may be impossible.

Too strenuous physical work may result in such exhaustion, or too much mental work even of a constructive kind. Too intense or prolonged an emotional state brings electrical exhaustion, even if it is the most pleasurable of emotions; and worry, fear, anger and other discordant emotions quickly use up electrical energies, as does shock of any kind, pain, or loss of sleep, or undue exposure to heat or cold. Such depletion should be avoided as much as possible during periods when Saturn is heavily afflicted by progressed aspects.

Thoughts of discouragement, grief, pity for oneself, or the feeling of inadequacy, inferiority or want also lower the electrical potential; and should not be permitted entrance to the mind. Should one of these undesirables sneak into the mind, as soon as its presence is recognized it should be violently ousted by turning the attention vigorously to some buoyant and constructive thought, particularly of the Venus or Sun type. And whether exhausted or not, to gain the potential to oust the invader and

hold the desired thought, the nerves should be slightly tensed, and the person should become a little more alert and determined to raise the potential, holding the feeling of radiating slightly and acquiring the necessary electrical power. Such instant and effective command of an electrical potential sufficient to repel undesired thoughts usually comes only with considerable practice.

Neptune and the Pineal Gland

—If there is a special extrasensory gland it is the small cone-shaped one located in a tiny cave at the base of the brain, behind and above the large pituitary. This pineal gland is the remnant of a third eye, which was an important organ in certain animal ancestors, and still exists with but a transparent scale over it in our common horned lizard.

Its secretion seems to respond with equal alacrity to the thought-cell activity mapped by either Neptune or Pluto; but as the Pluto thought-cells may also influence a front pituitary hormone which stimulates the gonads and the secretion of cortin, the condition induced by Pluto may be either similar to that induced by Neptune in its negative sensitiveness, or if cortin is secreted it may be decidedly positive. And in any case, due to the other hormones in some measure involved, the electrical condition induced by Pluto gives off radiations of shorter wavelengths and vastly more power.

The action of the pineal hormone is similar to that of the thymus hormone in that it prevents precocious maturity, and when overly active the adult continues childish in his attitude toward life, seeking the line of least resistance, and resorting to day dreams instead of facing the hard realities. It operates to counteract and suppress the action of both adrenaline and cortin, the latter keeping the individual positive and aggressive, and it greatly stimulates the imagination. When too active the individual finds difficulty in distinguishing between the facts of outer-plane life and wishful thinking, and unconsciously distorts the facts to conform to such wishful thinking or to other less desirable thoughts which have gained a foothold in his mind.

The other hormone influenced by Neptune thought-cell activity is parathyrin of the parathyroid glands. This controls the calcium metabolism of the body, and in combination with other hormones ruled by Mercury, Uranus, Neptune and Pluto, controls the type of electrification. The influence of Neptune thought-cells upon the secretion of parathyrin together with the negative pineal hormone is to develop a condition in the nerves and the electrical currents they generate which gives rise to great hypersensitivity. Objective consciousness may remain quite alert and exercising control, and the wavelengths of the electrical energies radiated are shorter than any others except those induced by the activity of the Pluto thought-cells. But they operate on the negative phase, which means that they are especially adapted to making of the nervous system and the electrical energies which flow over it a receiving set for picking up the astral radiations of any person or object which is tuned in on.

They permit so easy a flux of feeling that the nerves acting as a receiving set easily tune in on what ever is thought about, or even pick up the vibrations of things which are accidentally tuned in on. These wavelengths seem particularly well adapted also to permit whatever vibrations are thus picked up to cause their source to be seen, heard, tasted, smelled or felt by objective consciousness. The one heavy drawback to such hypersensitivity, whether cultivated or merely induced through the thought-cell activity mapped by powerful aspects involving Neptune, is that it makes it difficult to keep from feeling keenly many disagreeable conditions, not only of the physical plane, but also of the inner plane. Intellectual ESP avoids this difficulty, and is equally as effective in gaining information.

The health difficulties which discordant Neptune thought-cells attract are due to negativeness, to hypersensitivity, or to poisons. They depress and neutralize both adrenaline and cortin, and thus commonly when an individual is ill from infection or from a contagious disease, in addition to an aspect involving Mars there is also one involving Neptune. To counteract the hypersensitivity the diet should contain ample calcium, vitamin D and vitamin B-1.

But in addition to foods designed to stabilize and strengthen the nerves, there are two other factors that should be given attention. One is the tendency to negativeness, and the other is the tendency to become poisoned. When the adrenal glands are removed from an animal it exhibits all the symptoms of poisoning because adrenaline and cortin are not present to neutralize the toxins.

Of all the foods, meat is by far the most toxic, and requires the most cortin to handle. Thus it is, as Neptune depresses such secretion, that many people with Neptune unusually prominent in their birthcharts, and a corresponding weak cortin supply, find their health depends upon a meatless diet. And at such times as Neptune is afflicted by progressed aspect, care should be taken not to overload the system with proteins, even of vegetable origin.

It is well recognized in astrological practice that a severely afflicted Neptune may incline to the use of drugs and narcotics. These, of course, are extreme instances. But under a progressed affliction involving Neptune, a narcotizing effect may develop through the excess eating of protein foods, especially meat. That is, due to low output of cortin the in complete metabolism of the proteins may poison the body.

On the other hand, the aversion to proteins which the system may be unable to handle may easily lead to a diet deficient in energy production. Negativeness and lack of aggressive energy are far more frequently observed when Neptune is afflicted than is toxic poisoning. Proteins, to the extent they-can be properly handled, are stimulating. Being ruled by Mars, they are difficult for Neptune to handle; but to the extent they can be used without difficulty, they tend to offset the negativeness of an affliction involving Neptune. Only experience will indicate the exact extent to which they are beneficial.

Yet irrespective of the amount of protein that can be used, there is always a necessity present when Neptune is severely afflicted to maintain a high energy production. And for this purpose the diet should be varied and well balanced. The tendency is for a diet to be attracted which is deficient in fuel values, or one which is decidedly unbalanced. The system to develop the electrical potential to overcome the tendency to negativeness must have a nourishing and well-balanced diet.

Use Harmonious Sun Thoughts and Harmonious Saturn Thoughts to Neutralize Discordant Neptune Thought-Cell Activity

—Neptune thoughts are fanciful and visionary, with a tendency to find escape from the harsh restraining walls of reality in a mental realm devoid of hardship. Thus their natural antidotes are the practical, laborious, painstaking Saturn thoughts which face hardship and work and the harsh realities of life as a matter of course.

To apply these Saturn thoughts the habit should be formed of giving the attention to the practical problems of life, and whenever ideas involving projects of great magnitude, or impressions that seem of much importance enter the consciousness, to displace these by careful and logical thinking about what is, and what is not, practical in the light of past experience. Such thoughts cultivated for the definite purpose of neutralizing the discords of the Neptune thought-cells will enter into combination with the Neptune thought-elements, and the resulting thought-cell activity will then prove more fortunate.

Yet as Neptune thoughts are essentially negative, it is quite as essential, or more so, to insure that the energies flow outwardly, instead of permitting the outside condition to cause the flow to be in upon the self. And for this purpose Sun thoughts and maintaining a feeling that the energies of the mind and body are slightly pressing outward while holding thoughts of power, vitality and self respect are best. As the use of harmonious Sun thoughts to overcome the tendency to negativeness was explained in detail in reference to neutralizing discordant Saturn thought-cells, there is no need to repeat this explanation which is equally applicable to overcoming the tendency to negativeness due to Neptune thought-cell activity.

Chapter 10

Serial No. 225
Original Copyright 1949
Elbert Benjamine

Copyright
August 2002
Church of Light

What To Eat When Venus Or Mars Is Afflicted

Chapter 10

What To Eat When Venus Or Mars Is Afflicted

**VENUS
AFFLICTED**

CALLS FOR

**VITAMIN A,
VITAMIN E,
IODINE AND
COPPER**

IN observing the influence of the thought-cell activity mapped by the two social planets we are quickly struck by the similarity of their effect upon certain functions, and by the opposite trend of their effect where other functions are concerned. Both have a direct influence upon the kidneys, both are progressed constants of heart disease, both influence the blood pressure and the gonad glands. It is difficult to draw hard and fast lines differentiating their influence on the condition or functioning of the kidneys, the blood pressure, or the sex organs.

Broadly speaking, Venus is the planet of love and affection, and Mars is the planet of energy, violence and passion. Yet without the energy of Mars present in some degree any expression of love is a weak, sickly thing. It has no force or vitality. The higher expression of love requires abundant energy from Mars, directed by the affectional trends of Venus.

The Gonad Glands

—It is the hormone from the gonad glands which determines the sex characteristics. The hormones of the other glands play a part in hastening or retarding sex development, and some also give directivity to the hormone of the gonads. The hormone of the pineal gland and the hormone of the thymus gland tend to retard and neutralize the hormone of the gonad glands. Hormones of the front pituitary gland contribute to the development of masculine characteristics, and a hormone of the back pituitary gland contributes to the development of feminine characteristics. If the gonad glands are

**MARS
AFFLICTED**

CALLS FOR

**VITAMIN A,
VITAMIN B-1,
VITAMIN C, IRON,
LOW PROTEIN
AND VARIETY OF
PROTEIN**

removed the woman becomes masculine and the man becomes feminine. It is the male gonad hormone which makes a man manly, and the female gonad hormone which makes a woman womanly. And if the secretion is weak the normal manliness or womanliness is lacking.

Because the hormone of the male gonads is responsible for those characteristics which we recognize as male, we might be sure the energies of the planet Mars have a strong influence over them, and this is borne out by astrological research. And because the hormone of the female gonads is responsible for those characteristics which we recognize as female, we might be sure the energies of the planet Venus have a strong influence over them, and this also has been borne out by astrological research.

But we must not hastily conclude that a progressed aspect involving Mars, or birthchart afflictions of Mars, has no influence upon the ovaries or their internal secretion. And we must not hastily conclude that a progressed aspect involving Venus, or a birthchart affliction of Venus, has no influence upon the testes and their internal secretion. The thought-cell activity of Venus and Mars is too closely associated in their influence upon the reproductive functions and upon the kidneys to permit any such clear cut separation. The thought-cell activity mapped by either planet has some influence upon the gonads of both sexes, although that mapped by Mars has more influence over the male, and that mapped by Venus has more influence over the female. Also, thyroxin, adrenaline and cortin all stimulate the heart and increase the blood pressure.

Some years ago the hormone of the gonads gained much notoriety in connection with experiments in rejuvenation. Transplanted glands from monkeys and goats apparently renewed the youth of aged men and women in a marvelous manner, so that those previously sterile were reported to have been able to enjoy the blessing of children. Gland extracts were prepared for a similar purpose with varying success. It became a fad, and as fads do, attracted many incompetent persons who marketed worthless preparations. And, as fads do, it ran its course and sank largely from public notice.

The difficulty encountered in such rejuvenation is chiefly that the endocrine hormones are an interlocking system, each affecting, and depending upon, the action of others. As other glands which are necessary to support the gonad activity also usually had become weakened with age, or were not sufficiently strong to maintain the necessary chemical balance when the gonad hormones were suddenly added to the blood stream in quality, the rejuvenation usually was but temporary.

Yet it is the secretion from these gonad glands which keeps up the tone and strength of the other glands of the endocrine system. Its action extends to every cell of the body, not merely stimulating, but tending to restore and give youth to all the tissues, including those of the skin, muscle, nerve and bone. Its action is typical of the creative energy of Mars, the builder, together with the harmonious binding together of the love qualities of Venus.

Whenever there is a progressed affliction involving either Venus or Mars the thought-cell activity set in motion tends toward an imbalance in the secretion of the gonad hormone. This imbalance may be in excess secretion which through strain results later in depletion, as when a fiery planet such as the Sun makes the affliction, or it may be a poverty of secretion and lack of creative energy, as is the case when a cold planet such as Saturn takes part in the affliction. Furthermore, the progressed afflictions involving Venus are more serious in this particular respect in a woman's chart, and the progressed afflictions involving Mars are more serious in this particular respect in a man's chart.

Such imbalance of the gonad secretion has a powerful influence to direct the thinking. And, of course, thoughts of sex directly and powerfully affect the gonad secretion. If the hormone of these glands is present in the blood in normal amounts the thinking, especially as it relates to all affectional and social matters, is much more easily directed into the proper channels. Yet in spite of any amount of thinking, if certain factors are lacking in the food there can be no normal secretion of these rejuvenating hormones.

Venus and the Ovarian Hormone

—Within the ovary the eggs are surrounded by follicles. It is the follicle which secretes estrone, the typical hormone of the ovaries. The active principle of estrone, Alphaestradiol, was synthesized in 1932 by Schwenk. The corpus luteum which forms where the follicle ruptures manufactures the hormone of pregnancy, progestin.

Estrone, secreted by the ovaries, acts as a brake on the secretion of the front pituitary gland, helping to maintain a proper balance among the other glands which the pituitary controls. It also influences the growth of the feminine bodily contours and the womb, and has a marked influence on the mental and emotional outlook of woman.

When the egg matures the follicle ruptures at the surface of the ovary, and the egg travels through the oviduct toward the uterus. In this passage it may become fertilized. Due to one of the two back pituitary hormones—not pituitin—the follicle where the cavity was ruptured is transformed into the corpus luteum which secretes progestin. This, in turn, prepares the lining of the womb for the reception of the fertilized egg. The fertilized egg is thus embedded in the womb and menstruation ceases. If the egg is not fertilized, considerable of the lining of the womb is sloughed off in the process of menstruation. Progestin has been successfully used to overcome sterility in women when due to insufficient development of the organs involved.

Estrone has been valuable in treating women who suffer depression after their ovaries have been surgically removed, and other women at the time of menopause. The irritation, emotional instability and other difficulties that often arise at that time are due to lack of balance among the hormones. Estrogenic hormone also has been used with some success in treating men for cancer of the prostate gland.

But its indiscriminate use should be discouraged; for it has become evident that its use after menopause, or too liberal dosing after forty, or liberal doses given men for prostate difficulty, encourages cancerous growth. It seems that its power to promote cell development turns toward the growth of wild cells if the other hormones which encourage and assist pregnancy are not present. The influence of estrone on the breasts is striking, bringing about enlargement and change of color.

Of the foods which are particularly important when Venus is afflicted the most important is vitamin E. Extensive experiments on animals show that when the diet is otherwise well balanced but is deficient in vitamin E the normal cycles do not occur in the female and the ova becomes fertilized but abortion always occurs. There is a deficiency of the gonad hormone which prevents the growth of the placenta Without vitamin E the female-is clinically sterile.

Sterility is also produced in the male when the food is deficient in vitamin E. But the effect is first noticed on the sperm, which loses its fertilizing power. Then, if vitamin E deficiency is continued, there is complete absence of the sperm, and this is followed by complete loss of sex interest, degeneration of the glands, and complete and incurable sterility.

Vitamin E, which is of chief importance when Venus is afflicted, and which also should be considered when Mars is afflicted because the relation of Mars and Venus is so close, is to be found in the foods given in the table on page 162 of lesson No 221. It is fat soluble, and its activity is rapidly destroyed when the fat or oil containing it becomes rancid.

Venus, in addition to affecting the gonad secretion, rules the skin, the hair, the venous blood and the veins. People who have suffered from hemorrhoids and varicose veins often have been greatly relieved soon after starting to take tocopherex (vitamin E). Wheat germ is an excellent source of vitamin E. And many persons who have had had an unusually sensitive skin, being frequently annoyed by skin rash, have become free from this trouble shortly after ceasing to eat pastries, and each day sprinkling several tablespoons of wheat germ on their cereal, dessert or salad. It can also be eaten with fruit juice or milk. And all that many women who suffer from irregular periods, or from excessive or deficient flow, need to restore them to normal health in this respect is sufficient vitamin E. When vitamin E was discovered in 1922 by Dr. Herbert M. Evans of the University of California, it was labeled the fertility vitamin because of its pronounced influence upon reproduction. Women who had lost three or more babies, when supplied with abundant vitamin E—of which normally there is more in the body than all other vitamins put together—were able to bear healthy children 80 per cent of the time.

But later it was found that rabbits, guinea pigs, turkeys and puppies fed diets lacking in vitamin E became paralyzed. Examination showed this was due to changes in the muscles. This led to the successful use of vitamin E in the treatment of fibrositis and other types of muscular pain.

The present view is that this vitamin protects fats and certain vitamins from being oxidized when they are being digested in the body. The human body is saturated with oxygen, and it is believed that vitamin E may act like a fire sprinkler system, keeping oxidation under control.

The muscles are ruled by Mars. But Venus in most of their functions cooperates closely with Mars. And if the present view is confirmed by later experience, that vitamin E not only is essential to keep the muscles healthy, but that it has a preservative effect on bodily processes by keeping them working at the right speed and thus preventing premature aging, and that it is of great benefit in treating heart trouble—the heart being the most important muscle of all—it will indicate still other instances of their close cooperation.

Next in importance when Venus is afflicted is to provide vitamin A. A diet deficient in vitamin A upsets the feminine cycle, tending to make it continuous instead of periodic, with a reduction in the ova and lowered fertility. Some of the vitamin B factors are also essential to reproduction. A table of the best food sources of vitamin A is given on page 290.

Venus and the Thyroid Gland

—The function of the thyroid gland, and the necessity of supplying it with iodine in the food was discussed under the heading, The Sun and the Thyroid Gland, in lesson No. 223. As the thyroid gland, and its hormone, thyroxin, respond with alacrity to the thought-cell activity mapped by Venus as well as to the thought-cell activity mapped by the Sun, what was there said is equally applicable when Venus is afflicted. Special pains should be taken to insure iodine in the food during the time there is a progressed affliction involving Venus.

Venus rules the carbohydrates (sugars and starches), the more readily available fuel, but the Sun and Venus exercise control over its combustion. The general rate of fuel combustion is directly under the influence of thyroxin, the hormone of the thyroid gland; and thyroxin is released in response to one front pituitary hormone which is secreted under Sun thought-cell activity and in response to Venus thought-cell activity. The front pituitary hormone which responds to the Sun works powerfully to maintain energy production; but the thyroid responds with more readiness to the thought-cell activity mapped by Venus; for the thyroid is really an accessory sex gland.

In fact, in certain lower forms of life it is a sex gland; vitality and sex power in these forms being almost identical. It thus becomes the transformer also; for without it a tadpole never becomes a frog, yet by feeding thyroxin to a tadpole less than a day old it may be transformed into a frog, a miniature frog, yet mature in all its functions. Not that we are interested in frogs and other animals which have been experimented with; but a human cretin is one who has insufficient thyroxin to develop, or transform, into a normal person. And this is quite important to the neophyte striving for adeptship because the electromagnetic radiations essential to the higher states of consciousness cannot be attained and maintained by one whose body is deficient in thyroxin.

Pride and shame, self-display and self effacement, superiority complexes and inferiority complexes are directly related to the thyroid, as are the feeling of love and affection. It has been noticed, for instance, that women having fibroid tumors are prevalently those whose love life has been unusually distressing. And in these cases thyroid disturbance is present. Thus it is that a healthy thyroid manifests as symmetrical features, beauty of hair and skin, alertness of mind, grace of movement, buoyancy of life in general, all related to the planet Venus. And for these there must be a constant supply of iodine to maintain the proper amount of thyroxin in the tissues. And it is curious to note that for hundreds of years the Chinese have used sponges in the treatment of cretinism. But we do not need to eat sponges to get iodine; for practically all sea foods are rich in iodine, and fruits and vegetables grown on marine deposit soil contain it.

In lesson No. 223 the effects of thyroxin deficiency were mentioned. But too much thyroxin causes quite as much trouble. This difficulty, called hyperthyroidism, is a nerve-fraying and body wasting ailment resulting from too swift metabolism. The individual suffering from too much thyroxin is in a perpetual state of excitement, no matter how much he eats he remains frail and thin, and his nerves are in a constant state of jitters. In the past this condition has chiefly been treated by the surgical removal of about seven-eighths of the gland. But it is now being treated with radioactive iodine, and with a newly discovered chemical compound known as 6-n-propyl thiouracil.

The cause, unless due to toxins in the blood which thyroxin is trying to neutralize, is over emotional reaction to some condition. People with Venus prominent and severely afflicted at birth may require no special shock to develop it, as they may be temperamentally emotional. Thyroxin regulates energy production, and emotions call for more energy. Thus other people develop it only after some harrowing experience, such as being in an auto crash, seeing some other person killed, suddenly losing their life's savings, or when involved in recurrent family discords. A great many women developed it right after their sons entered the service in World War II; and it was reported that during the Nazi occupation of Denmark hyperthyroidism among the Danish people increased 500 or 600 per cent.

Venus and the Veins

—The arterial blood and the arteries are ruled by Jupiter. The venous blood and the veins are ruled by Venus. The red blood corpuscles in the blood stream are powerfully affected by Mars which rules the proteins and the iron which are essential to their formation and functioning.

When a vein is dilated, knotty and tortuous, it is called varicose. Tortuosity may be due to the lengthening of the vein, and the veins more commonly affected are those of the lower limbs, although veins in almost any location may become varicose. The most common vein to become varicose is the long saphenous one which passes up on the inner side of the leg and thigh.

Anything which impedes the circulation in a vein may influence it to become varicose, and the weight of the blood itself in a long vein may lead to a varicose condition in a person who stands long hours on his feet. But the immediate cause is a weakness in the vein walls which permits them to become damaged by whatever strain has been placed upon them. As the predisposition to varicose veins is indicated by Venus afflicted in the chart of birth, and as at the time the difficulty develops there is a progressed aspect involving Venus, with other progressed afflictions, usually involving Mars, we may be sure that the thought-cell activity mapped by Venus is largely responsible for this condition.

However, we cannot entirely overlook the action of Mars, as the Mars thought-cells and the Venus thought-cells are so interlocked in their influence over the kidneys, the blood and the gonad secretions. It is evident that irritants in the blood stream weaken the walls of the veins. If the adrenaline supply becomes depleted, under discordant Mars thought-cell activity or discordant Saturn thought-cell activity, the acids and toxins in the blood are not properly neutralized by adrenaline. If the thyroxin supply is depleted, due to discordant Sun thought-cell activity or discordant Venus thought-cell activity, the acids and toxins in the blood are not properly neutralized by thyroxin. If, under discordant Venus thought-cell activity or discordant Mars thought-cell activity the kidneys are unable to handle the acids and toxins, they remain in the blood in sufficient strength to irritate the walls of the blood vessels, and weaken them. Under such conditions if the Sun thought-cells are powerful, high blood pressure (hypertension) may result, or if the Venus thought-cells are active varicose veins may develop. If the Venus thought-cells are heavily discordant the food should contain ample vitamin A, vitamin E, iodine and copper.

While the Mars thought-cells chiefly determine the ability to handle the proteins, the dose association between the influence of the Mars thought-cells and the Venus thought-cells is illustrated in relation to thyroid activity in that the presence of ample thyroxin stimulates the combustion of proteins, and protein stimulates the activity of thyroxin. Animals without a thyroid cannot develop a fever when infected or poisoned. Thus Mars, as well as Venus, contributes to the strength of the veins.

And as Venus rules the skin and the veins, the importance of vitamin A and vitamin E not only for a healthy skin but for strong vein walls is apparent. In the absence of vitamin A the skin gets dry and scaly and may lose its sensitivity to touch, and the lining of the organs and the vein walls suffer. And many people when there is insufficient vitamin E acquire skin blemishes.

Iron, copper, manganese, zinc and aluminum are sometimes called “the Little Giants of Nutrition,” because they are present in such small amounts, yet are so essential to the proper functioning of the body, and are so important in blood formation. Of these minerals, iron is present in the largest amount, and is the only one of the group which has a structural as well as a catalytic function.

In spite of any amount of iron salts in the diet an individual may become anemic unless there is also copper; for in some way copper, ruled by Venus, is the companion metal of iron and helps transform iron from the food into the blood and hold it there, and good red blood cannot be formed without it. Zinc, aluminum and especially manganese also perform a function, as mentioned; but the foods supplying copper commonly also supply these in sufficient quantity. Copper is the essential harmonious binding metal and, when Venus is afflicted, especially by progressed aspect, care should be taken that it is present in the food. The table on page 291 indicates the best food sources of copper.

Use Harmonious Saturn Thoughts and Harmonious Sun Thoughts to Neutralize Discordant Venus Thought-Cell Activity

—Excesses of emotion, and discordant emotions which arise in relation to the affections are most quickly and effectively modified beneficially by the application of thoughts of caution, system and foresight which are ruled by Saturn. The Saturn thoughts are the natural antidotes of the Venus thoughts, but in applying them care must be exercised that no trace of selfishness, greed or fear creep in; for these Saturn tendencies are basically discordant and to whatever thought-cell compound they are added they tend to attract loss and disappointment.

It should be recognized that the Venus thought-cells cannot build strong veins, insure proper combustion of fuel in the body, support fertility and contribute to rejuvenation unless vitamin A, vitamin E, iodine and copper are furnished in the food. But it should equally be recognized that however abundantly these food materials may be supplied, the Venus thought-cells will be unable to do the mentioned work if the individual is in a recurrent state of emotional excitement, or if he keeps emotionally upset due to discords arising where friendship, affection or the love-life is concerned.

Few things are more important than a harmonious love-life; but love is a harmonious emotion that may express satisfactorily on a wide variety of levels. When felt for children the secretion of the back pituitary gland assists in developing the electrical condition. The electrical condition permitting the more refined types of love and affection are linked with the thyroid gland. Those of sexual attraction are generated chiefly by the secretion of the gonad glands. The gonad hormone acting upon the

nervous system generates electrical energies in the nervous system which build up a certain tension which is felt as physical attraction toward the opposite sex. This electrical energy, however, is capable of being diverted, much as the electrical current flowing over an ordinary power line is, and it is capable of being stepped up or stepped down in voltage, so that it can be made to sustain discord and gross passion, or tender love, ecstasy, and the highest and noblest feelings of which man is capable. But to feel any of these things there must be appropriate electrical energies in the nervous system; for it is their action which is felt.

When electrical energies are present in the nervous system and the Venus thought-cell activity is harmonious, the life is filled with joy and happiness which tends to prolong youth and give health. But when electrical energies are present in the nervous system and the Venus thought-cell activity is discordant, the person easily becomes emotionally upset, and the health suffers from the chemical imbalance induced by the over secretion or depletion of thyroxin and the gonad hormone.

The Saturn thoughts mentioned provide a satisfactory antidote; but these as well as the Venus thoughts tend to increase the negative condition, and thus decrease control. To handle the electrical energies, and thus control the emotions, rather than be controlled by them, it is necessary for the brain to have at its command electrical potentials higher than those generated by the emotions. Even as when the negativeness is due to Saturn thought-cell activity or Neptune thought-cell activity, Sun thoughts of power, vitality and self respect should be employed, and the feeling maintained that the energies of the mind and body are slightly pressing outward.

And whether it be this Sun mood of power and control which does not permit any situation which may arise to create emotional discord, or some less desirable condition, it should be remembered that the more often a given emotional state is experienced and the more intensely it is felt, the easier it is to experience it again, as through repetition the energies become conditioned to flow into a given channel.

Mars and Testosterone

—The male sex hormone testosterone, secreted by the testes, has been given great publicity as a generator of male virility. Estrone in the lives of women, and testosterone in the lives of men have the natural function of toning up the other glands and rejuvenating the whole body. And in addition to their action extending to all the cells and tissues, tending to restore them, they exercise a profound influence upon the generation of electrical energies by the nervous system.

Testosterone has been successfully used to bring about the masculine change in boys who still have high pitched voices and feminine attitudes after they have reached the age of puberty. It will change a thirteen-year or fourteen-year old boy of the feminine type, whose sex glands have failed to develop, into a fairly competent male. It will also bring about a trend toward masculinity which is important in giving a happier life to effeminate young men of adult age. But its use also has its dangers, for too much can cause sterility and stop the growth of bone.

The gonad secretion, testosterone or estrone, is essential to creative work of any kind. The artist, the inventor, and the writer must have it abundantly. Whenever it is over abundant it should be put to constructive use through diverting the energies into wholesome creative effort of some sort. When deficient, it should be encouraged by a wholesome love life and the cultivation of harmonious but strong affections. It responds to the activities of both the Mars thought-cells and the Venus thought-cells, but the secretion of testosterone responds with greater alacrity to the thought-cells mapped by Mars.

For the manufacture of testosterone the body should be supplied with vitamin A, vitamin B-1, vitamin E, and the proteins in sufficient variety to insure the presence of the amino acids required in this substance.

Mars and the Red Blood Corpuscles

—Discordant activity of the thought-cells mapped by Mars tends to imbalances which affect the adrenal glands, the gonads, the kidneys, the red corpuscles of the blood and the blood pressure. The Mars thought-cells in particular govern the ability to handle the protein foods, chiefly through the action of cortin, the typical Mars secretion of the cortex of the adrenal glands. And they also govern the handling of iron.

Iron enters directly into the construction of hemoglobin in the red blood corpuscles which carry the oxygen from the lungs to the tissues. When there are too few red blood corpuscles, or too little of the red hemoglobin in the red corpuscles, not enough oxygen is delivered to the cells of the body, and they are unable to breathe properly. Such oxygen starvation takes place in anemia.

Iron, ruled by Mars, is not merely essential for blood building, but it is the carrier of oxygen to all the cells, and must be present for their continuous oxidation and life. Brain and muscle cannot carry out their functions in the absence of iron.

The red blood cells live about thirty days, and new ones are being created all the time to take the place of those worn out. If these new cells are to have the proper amount of the red hemoglobin there must be an adequate iron supply present. In the case of a deficiency of calcium, the system begins to use the reserve stored in the bones, when additional fuel is needed the liver is called upon to furnish the sugar, and when there is great need of salt (sodium chloride), that which is stored in the skin is requisitioned. But there is no such provision in the body for a reserve of iron. Consequently, if the daily iron intake does not equal that lost through the wear and tear of the life processes the blood becomes poor in hemoglobin and an anemic condition develops.

Because milk is nature's sole food for the young mammal during the sucking period it has been too common to assume that milk constitutes the perfect food. But such is by no means the case as it lacks one of the essential proteins and is decidedly deficient in iron.

Guinea pigs and such other mammals as feed on green leaves and other iron-containing food immediately after birth, being born with teeth to chew coarse food, have no reserve store of iron in their livers. But in the case of the human infant there is taken from the mother's body, during the last three months before birth, iron and the other minerals necessary for blood building, and they are stored in the liver of the unborn child. The amount of iron thus stored in the liver of the human infant at birth is about enough to carry it through the first year.

If the mother has had an iron deficient diet before the birth of the child, if the child is born prematurely before sufficient iron has been stored, or if a case of twins in which the mother is unable to supply iron for both, anemia will develop unless additional iron is supplied in the diet. In certain sections where herbage is rich in minerals due to the underlying soil, such as in the Blue Grass Country of South Carolina, the milk of the cows contains considerable iron; but the general run of cow's milk is decidedly deficient in it. Furthermore it must not be overlooked that there must be the Venus metal, copper, present in order to utilize the iron. A table is given on page 291 showing the best food sources of iron. Calves' liver of recent years has come into much demand because in it has been stored iron enough to carry the calf through the suckling period.

Mars and the Proteins

—But the minerals are not the only requisites for the formation of hemoglobin and red blood. Hemoglobin is a compound of red iron-containing pigment, called hemastin, and a certain protein, called globin. It takes the hormone cortin, ruled by Mars, to handle the proteins satisfactorily; and for the manufacture of globin the amino acid called histadine is essential. And very little histadine is contained in milk.

It is true the proteins are abundant in milk. But the human system requires for its proper functioning four different protein compounds which it seems unable to manufacture from other proteins. Therefore, the proteins taken should not be confined to a single food, but be given sufficient variety to afford all four types. Milk, for instance, as indicated, does not afford all four in sufficient quantity. Being deficient in histadine, a straight milk diet, even on milk containing the mineral elements, leads to impoverished blood.

The proteins form the structural material of all cells. Forming the muscles and the glands they are composed of various amino acids, twenty of which are known. When protein foods have been eaten, the digestive juices tear them asunder into their various amino components. Thus broken up these amino acids are absorbed into the blood, and the proteins of the body are built from them.

The proteins which constitute the cells of the body are not all alike. In fact, there is a great variety of proteins in the human body. Yet these, as well as thousands of others of vegetable and animal origin, all are composed of the twenty amino acids in various combinations. As there are twenty of these protein builders, and they may combine with each other not only in various amounts but in various relations to each other, the

number of proteins that might be formed is beyond computation. With twenty bricks, how many different combinations of bricks may be had, two bricks or more to each combination? This can be answered mathematically. But if each of the bricks were capable of being given an unlimited variety of sizes, the problem would become complicated.

And thus the amino acids are present in various quantities as well as in various unions with some of the other amino acids.

The really significant thing about these proteins in so far as we are concerned is not their great variety, but that the human body is incapable of building up certain proteins out of certain other proteins. In order for the body to build its necessary cells there are four different amino acids which must be present, as it is not equipped to manufacture them from the raw materials.

The red cells of the blood not only require iron for their manufacture, but protein; and new ones to take the place of those disintegrated must be manufactured from the bone marrow about every thirty days. Skin, hair, nails, and the cells of the intestines and kidneys are constantly lost, and along with other cells, must be replaced. To take care of this constant protein loss, there should be a certain protein intake in the food daily. New living matter is constructed all the time to maintain the balance between the blood cells, the skin and nails, and the cells of the internal organs. And unless the proper proteins for this replacement are furnished in the food the body itself supplies them, destroying less necessary cells to provide material for the cells which are most essential.

This replacement of lost tissue, however, is not the sole function of protein. It also has a stimulating function. This is due to the liberation of certain of the amino acids during digestion. These stimulating amino acids are not the four which are essential to the replacement of outworn tissue; but are usually present whenever sufficient protein is eaten for replacement purposes.

This influence of protein to accelerate combustion of sugar and fat in those with strong thyroid and front pituitary glands, and the lack of such acceleration in those with weak thyroid and pituitary glands, ruled by the Sun, was commented on in some detail when considering proteins in lesson No 153. It has been demonstrated experimentally that in the absence of the secretion of the thyroid the stimulating effect of protein is not present. And as already mentioned, animals without a thyroid cannot develop a fever when infected or poisoned. Thyroxin stimulates the destruction of protein, and protein stimulates the activity of thyroxin.

As indicated in lesson No 153, there is a wide variation in the ability of people to handle protein. Not only thyroxin, but cortin, the typically Mars hormone, is involved; and the activity of the kidneys, ruled by Venus and Mars, must be considered. But other things being equal, when the thyroid gland is too active, as when the Sun or Venus is unduly stimulated by a progressed aspect, a diet high in protein (Mars) tends to accentuate the excitable tendencies. Under such conditions, therefore, the diet should be low in proteins and high in sugars and starches. But other

things being equal, when the thyroid gland is sluggish, as when the Sun or Venus is unduly depressed by a progressed aspect, there is little ability to handle sugars and starches, and a higher intake of protein (Mars), within the limit of the thyroid's ability to respond to such stimulation, will stimulate the thyroid to increased activity. That is, more protein (Mars) gives the thyroid the energy to perform its work, if its responsive power has not become too depleted.

Mars and the Adrenal Cortex

—Adrenaline, the secretion of the medulla of the adrenal glands, responds with equal alacrity to the thought-cell activity mapped by either Saturn or Mars; but cortin, the secretion of the cortex of the adrenal glands does not respond to Saturn, but primarily to Mars, and in less degree to Pluto. It also responds to the stimulation of one of the two front pituitary secretions that are released by Sun thought-cell activity. The secretion of the pineal gland and the secretion of the thymus gland tend to check, suppress and neutralize the action of cortin, the typically Man hormone; and it is the relation of the cortin supply to the adrenaline supply which determines in an emergency whether the reaction is to be combat or flight. The front pituitary hormone ruled by the Sun and the front pituitary hormone ruled by Pluto have the opposite effect on cortin that the hormones of the pineal gland and the thymus gland do. They not only assist and stimulate the secretion of cortin, but they contribute stability and poise and sustaining power to the courage they thus aid.

It is the amount of cortin in the blood, however, which chiefly determines whether the reaction is to fight or to flee from the enemy. Fighting animals have abundant adrenal cortex, while timid animals have this portion of the gland small. Depleted cortin, in relation to the amount of adrenaline—and it may be inadequate due to the action of pineal hormone or thymus hormone—gives the typical fear reaction. But when cortin is abundant in proportion to the adrenaline, especially when the front pituitary hormones ruled by the Sun and Pluto are active—for these not only tend to stimulate the secretion of cortin but seem to cooperate in some way with it—no fear is felt, and instead there is a strong desire present to attack and destroy the opposition.

Cortin is more effective in neutralizing acids and toxins in the blood stream than adrenaline, and much more so than thyroxin. It is the most powerful chemical the body possesses to fight invasion and neutralize the waste material from the life processes of protozoa, bacteria and viruses. And it is intimately connected with the handling of the proteins. The removal of the adrenal glands is followed in a few days by death from toxic poisoning. But injections of cortin into the blood stream will enable the animal thus poisoned to survive as long as the injections continue.

Experiments have shown that vitamin A is unusually important in the maintenance of the normal cortin production, and that vitamin C also plays a part. And as adrenaline, which also responds to Mars thought-cell activity seems basically composed of the amino acid tyrosin, protein food containing it is needed under Mars afflictions, and this may be insured through variety of proteins. Vitamin C is one of the vitamins

which should be provided under afflictions involving Saturn; but it is also called for under afflictions involving Mars. And here again the action of Mars and Venus are difficult to separate; for vitamin C deficiency affects the skin and the walls of capillaries, which become fragile and bleed; and vitamin E deficiency affects adversely the muscles, which are ruled by Man.

Many years ago when the main diet of sea going vessels consisted of salt meat and hard-tack, a disease was prevalent known as curvy. And at later dates Arctic explorers, denied fresh vegetables and fruits, developed this disease. There were hemorrhages of the mucous membranes, skin, joints and marrow, ulcerated gums, pains and swellings in the joints and limbs, fragility of the bones due to loss of calcium, and the teeth loosened and fell out.

The British Navy carried out experiments as early as the middle of the eighteenth century in the endeavor to find the cause and cure of this disease. They found that dried vegetables and dried fruits would not prevent or cure scurvy, but that fresh vegetables and fruits would. This resulted in the adoption of lemon-juice syrup as part of the regular rations of all their sailors Limes came thus to be used on all sailing vessels as a means of preventing scurvy, and such vessels, because of the regularity of lime-juice in the rations, came to be known as “limejuicers”.

Arctic explorers were quick to note that the first manifestations of this dread disease were lassitude combined with quarrelsomeness. This was followed by blue, spongy gums, and complete loss of endurance. Vitamin C, which acts to bind the tissues together (it is the function of Venus to bind harmoniously) cured this condition, and is essential in the food for normal tooth formation and maintenance. Recent studies also indicate that vitamin C is essential for the proper handling of calcium.

Of course, we do not expect, even under Saturn, Mars and Venus afflictions, scurvy to develop where the diet is even near the common standards; but vitamin C deficiency has an influence on both the health and the thinking, even when the deficiency is not unusually marked. It manifests in these instances as listlessness and laziness combined with irritability. A table showing the best sources of vitamin C is given on page 258 of lesson No 224.

Use Harmonious Discordant Moon Thoughts to Neutralize Discordant Mars Thought-Cell Activity

—When Man is afflicted it makes the work of the thought-cell easier in the effort to maintain health if the food contains plenty of vitamin A, vitamin B-1, vitamin C, iron, not too much protein, but plenty of variety of protein. Yet for the Mars thought-cells properly to handle these foods they must not be discordant The best way to harmonize them is to add harmonious Moon thoughts to the compound of which they are composed.

These Moon thoughts have to do with helping the weak, helpless and unfortunate. They may be applied harmoniously to the Mars thought-cells through devising some plan, project or work in which pleasure can be experienced, having to do with the comfort of the family, or which contributes to the welfare of the aged or young or those otherwise helpless. Then when anger, irritation, lust, the feeling of antagonism or the tendency to strife, undue haste, or undue expenditure of energy begins to be felt, turn the attention to thought of this work. Not only use the Mars energy in some constructive effort, but think about and do something to benefit those unable to help themselves. The thought antidote thus provided will enter into the compound of which the Man thought-cells are composed and these thought-cells will then attract much more fortunate events into the life, including better health.