

Stephen
Flowers



The
GALDRABÓK

An
Icelandic 
GRIMOIRE

The
GALDRABÓK

An
Icelandic
GRIMOIRE

Stephen Flowers

First published in 1989 by
Samuel Weiser, Inc.
Box 612
York Beach, Maine 03910

01 00 99 98 97 96
10 9 8 7 6 5 4 3 2

© 1989 Stephen E. Flowers

All rights reserved. No part of this publication may be reproduced or transmitted in any form or by any means, electronic or mechanical, including photocopy, without permission in writing from Samuel Weiser, Inc. Reviewers may quote brief passages.

Library of Congress Cataloging in Publication Data

Flowers, Stephen E., 1953-

The Galdrabók : an Icelandic grimoire / edited, translated, and introduced by Stephen E. Flowers.

p. cm.

Includes a translation of Galdrabók.

Bibliography: p.

1. Magic, Germanic—Handbooks, manuals, etc.—Early works to 1800. 2. Mythology, Germanic—Early works to 1800. 3. Iceland—Religion—Early works to 1800. I. Galdrabók. English. 1989.

II. Title.

BF1622.G3F56 1989

133.4'3'094912—dc20

89-14650

ISBN 0-87728-685-X

Cover illustration © Susan Sheppard, 1989

Typeset in 11 point Goudy by

N.K. Graphics, Keene, NH

Printed in the United States of America by

Baker Johnson, Inc., Ann Arbor, MI

Contents

Abbreviations	ix
Acknowledgments	xi
Introduction	xiii

Part 1

Historical Background

Chapter 1: Historical Context: Politico-Religious	
Climate in Iceland	3
Heathen Period (870–1000)	3
Catholic Age (1000–1550)	5
Reformation Age (1550–1650): Iceland at the time of the <i>Galdrabók</i>	7
Chapter 2: History of Magic in Iceland	11
Heathen Period (870–1000)	11
Catholic Period (1000–1550)	19
Reformation Age (1550–1750)	21
Chapter 3: Icelandic Books of the Black Art	27
The Black Books of Legend	28

Text of the <i>Galdrabók</i>	29
Other Historical Manuals of Magic	32
The Two Traditions in the North	35
Chapter 4: The Old Gods and the Demons of Hell	37
The Heathen Gods and Goddesses	38
The Demons of Hell	41
Chapter 5: Runes and Magical Signs	45
Chapter 6: Theory and Practice of Magic in the <i>Galdrabók</i>	51

Part 2

The *Galdrabók*

The <i>Galdrabók</i>	59
----------------------	----

Appendices

Related Spells in Germanic Magic

Appendix A: Other Icelandic Sources	83
From the Huld Manuscript	83
From the Kreddur Manuscript	92
From Svend Grundtvig's Collection	99
From the Collection of Jón Árnason	99
From Various Manuscripts Collected by Ólafur Davíðsson	101
Appendix B: Heathen Magic in Old English Manuscripts	105

- Appendix C: Heathen Magic in Old High
German Spells
Contra Vermes
The Merseburg Charms
- Notes for Part 1
- Notes for Part 2
- Bibliography

Abbreviations

Ice.	Icelandic
ON	Old Norse
PGmc.	Proto-Germanic
pl.	plural
sg.	singular
st.	stanza

Acknowledgments

For their help and continuing inspiration during the years in which knowledge was accumulated to write this work, I wish to thank Prof. Dr. Edgar Polomé, Prof. Dr. Klaus Düwel, Prof. Dr. John Weinstock, and Robert Zoller.

Introduction

The so-called *Galdrabók*,¹ or "Book of Magic," is the single most important document for understanding the practice of magic in late medieval Iceland. It is especially important in that it gives a unique insight into the various religio-magical elements that went into a synthetic national magical tradition in Iceland at the time of its compilation. No other document of comparable age gives so many details of the preservation of the archaic Germanic gods, cosmology, and magical practices as does this little manuscript. Here we are not dependent on folktales or indirect reports through confessions exacted by the tortures of the Inquisition or other churchly authorities to reconstruct the magical or religious views of the *galdramenn* (magicians) of the day; instead we have direct evidence of actual practices written by the magicians' own hands. In many ways the *Galdrabók* is to the Icelandic folktales of magic² what the runic inscriptions are to the accounts of magic recorded in the sagas. They provide factual corroboration of what otherwise might have been considered a form of fantasy.

In this volume the reader will find not only an annotated translation of the complete *Galdrabók* but also a similar treatment

of selections from other written sources of Germanic magical practice from all of the Germanic peoples. However, in no region did the old ways and the old gods and goddesses survive so well as in Iceland. And because we are focusing on these texts for what is uniquely Germanic about them, leaving as secondary what is common to every European tradition, we will concentrate mainly on Icelandic sources in this study. Our two principal areas of interest will be the preservation of the old gods and the preservation of the unique forms of Germanic magical practice inherited from the heathen age.

In preparing this work for modern publication, I've made every effort to remain true to the original text of the *Galdrabók*. Irregularities in capitalization and spelling are left as in the original as they may have special meaning or significance.



PART
ONE

*HISTORICAL
BACKGROUND*

CHAPTER ONE

Historical Context: Politico-Religious Climate in Iceland

To establish a context for the magic practiced in the Books of Black Magic that were mainly set down in the 1500s and 1600s, we must look at the various stages of religious and political development in Iceland. These periods are three: the Heathen Age, the Catholic Age, and the Reformation Age.

Heathen Period (870–1000)

The generally unpopulated island of Iceland was settled mainly by Norwegians (along with their Irish and Scottish thralls) who were seeking political and religious freedom from the onslaught of the Norwegian king Haraldr *hárfagra* (fair-hair), who had set about to conquer all of Norway and to bring it under a single Christian-style monarchy.

These new Icelanders set up a form of social order deeply rooted in their native heritage—a sort of representative or republican aristocracy. There was never a king in Iceland. Rather, the land was ruled by the local priest-chieftains (ON *godhar*, sg.

godhi), who would meet once a year at the *Althing* (great assembly), or parliament, to settle legal cases and to pass legislation for the country. This form of government was minimal in its exercise of central authority. Courts could decide cases but had no ability to carry out sentences; that was left up to the kinsmen of the wronged party. Most often, those who had committed manslaughter, for example, would be "outlawed"; that is, they would be declared to be outside the protection of the law, and they could be killed without legal repercussions to the avengers. Another principal feature of Germanic law was the idea that the party wronged was the one to be compensated by the criminal. The "state" made no profit on crime. For almost every crime a monetary value was set, so instead of being outlawed a man might be able to satisfy the wronged party with a payment of some kind, called *weregeld*. Each *godhi* held an authority (ON *godhordh*, which means "authority as a *godhi*"), which corresponded roughly to a district. The authority in question was owned by the *godhi* and could be sold, inherited, or subdivided.¹

The Icelanders practiced the religion they brought with them—their age-old polytheistic Germanic heathenism,² a religion that allows for as much individual freedom as did the Icelandic system of government. One man may worship Óðhinn; another, Thórr; another, Freyja; and yet another may simply "believe in his own might and main." Also, there were a number of Christians among the Irish/Scottish thralls brought to Iceland, and a few of their masters even converted; but it is said that it did not last in their families. The point to remember is that the Icelanders tolerated these differences.

By the year 1000, Ireland, England, Norway, and Denmark (Iceland's chief foreign contacts) had all officially become Christian. It was under a variety of social, economic, and religious pressures that Christianity was formally accepted as the official religion at the Althing of 1000.³

Catholic Age (1000–1550)

By all accounts the acceptance of Christianity by the Icelanders was highly formalistic, marked by little conviction on the part of even those who voted for it. Public sacrifices to the Germanic gods were forbidden, but the private practice of the traditional faith—including the eating of horse flesh and the exposure of infants—was allowed to continue. Conversion to the Catholic faith was marked by a gradual transition period lasting several generations and by an undiminished interest on the part of the Icelanders in their own traditions. In the earliest phase of this period many of the *godhar* simply had themselves ordained as priests. Others lent their religious duties to other relatives—as Viking priests somehow appeared unseemly. Also, there were *leiguprestar* (hired priests) who were bound to a chieftain like a thrall.

For the first thirty years or so of this period Iceland must have remained largely heathen in its practice of religion and especially of magic. From 1030 to 1118 there reigned in Iceland what is called the *Fridharöld*—The Age of Peace—in which the common feuding subsided and a new culture began to take hold as individual Icelanders examined the new religion. This could also be characterized as a period of mixed faith in which Christianity actually began to gain a foothold in the culture as scholars traveled abroad to learn of the new faith and schools were established in Iceland itself. It was toward the end of this time, around 1100, that Icelandic was first used to write histories, sagas, and poetry.

There developed in the country a general love of learning that led some men to join the clergy in order to be educated abroad and others to enter monasteries for the same scholarly reasons. Some even established schools on their private estates, where they worked as scholars and teachers. These traditions of

learning actually were rooted in the previous age, in which oral tradition was just as lovingly preserved. It must be remembered that Iceland was settled in large part by the conservative cultural aristocracy of Norway, which led to an unusually high level of interest in national intellectual traditions even in later times. Today Iceland has the highest literacy rate and the highest per capita book-publishing rate in the world.

None of these developments appreciably changed the nature of the church or clergy in Iceland. There was always a strong secular element in the Icelandic church and a strain of cultural conservatism that fostered the preservation and continuation of national traditions in statecraft, religion, and literary culture. And lest one think that those many Icelanders who joined the church and the monasteries during this time were forced to reject worldly pleasures for lives of devoted and pious learning, it should be mentioned that celibacy was never enforced for the Icelandic priesthood, and the fact that priests could not legally marry left the door open for a form of polygamy, or multiconcubinage. The heathen ways simply went forward.

The Age of Peace began to crack apart in a period of civil strife, beginning about 1118. At that time the old patterns of feuding, exacting of blood vengeance, and the like began to emerge again—with the added elements of political conspiracy and intrigue involving foreign powers and the offices of the church. Although elements of this civil strife would continue for centuries, in 1262 it was sharply curtailed by the intervention of the Norwegian king. An age of Norwegian dominance lasted until 1397, when a period of Danish domination began. This was to last until Iceland was again able to establish complete independence in 1944, when the Danes were under Nazi occupation.

Despite the domestic strife and foreign exploitation exhibited between the end of the Age of Peace and the beginning of

Danish domination, this period was a sort of golden age of Icelandic culture and literature. This was the time when the poems of the *Poetic Edda* were committed to parchment, when Snorri Sturluson wrote the *Prose Edda* (1222), and when most of the great sagas were compiled. Icelanders had become comfortable with their "National Catholicism," which had allowed indigenous traditions to survive and native "saints" (some official, some not) to be revered. But foreign domination was to prove a danger to this cultural balance of the past and present.⁴

Reformation Age (1550–1650): Iceland at the Time of the Galdrabók

It was with the background of the heathen and Catholic past that the magic contained in the *Galdrabók* and related manuscripts was practiced. But it was during this period of religious strife and ultimately of religious persecution that the work was actually committed to parchment.

The Protestant Reformation, of course, began with Martin Luther in Germany around 1517. It quickly spread in northern Europe, where the secular authorities especially had long harbored a cultural animosity for the domination of Rome. In 1536 the Reformation was officially accepted in Denmark, and hence its possession, Iceland, was also destined to follow that course. Because of Iceland's continued isolation and intrinsic conservatism the Reformation did not come easily to the island.

Sources of the Reformation in Iceland were two: the foreign forces of the Dano-Norwegian crown and the domestic churchmen who had become convinced of Luther's doctrines while studying abroad. One of the reasons the crowned heads found Protestantism so attractive is that it allowed the kings to nationalize, and in effect to confiscate, the wealth and properties

of the Catholic church in their respective countries. Resistance to the Reformation came from the conservative populace and, of course, from the Catholic clergy. From 1536 to 1550 there was in effect a low-intensity religious war in Iceland. The forces of Protestantism and the crown finally won with the execution of Bishop Jón Árason in 1550. But this marked only the beginning of any Reformation at the popular level. It would take a full century, until around 1650, before Protestantism could really be considered fully accepted by the population at large.

This period of "popular Reformation" was marked by increasing exploitation on the economic front and by increasing Danish domination in politics. In 1602 Denmark established a trade monopoly over Iceland so that the island could no longer trade freely with whomever it pleased, resulting in a time of economic hardship often reflected in the folktales of the period. The powerful Danish tradesmen and the Protestant churchmen (who were virtually the agents of the Danish crown) ruthlessly exploited and oppressed the populace. One fourth of the tithe paid to the church and the fines imposed by the courts went directly to the king of Denmark. The laws of the country were changed to impose the death penalty for moral crimes such as heresy (aimed against the "un-Reformed") and adultery. Of course, this net would eventually be widened to include "witchcraft." Again all or part of the estate of anyone convicted of these, as well as long-established or legitimate, crimes went to the crown. Such measures were especially harsh on the population because until this time the old Germanic-heathen legal codes, which provided first and foremost for the compensation of the victims of crimes (not the state or king), were still largely in place on the island.

Throughout the 1600s the country was spiraling downward into general economic and political decay. From our historical perspective, however, the age was not without its benefits. The

scholarly humanism that developed to some extent in Iceland but especially in Denmark gave rise to a concerted effort by scholars to save the Icelandic literary heritage. It was probably as a part of this process that the manuscript of the *Galdrabók* was brought to Denmark. In fact, like the economic wealth of the nation, its cultural wealth was also syphoned off to Copenhagen. Now the manuscripts collected at that time are being repatriated, and, ironically, they were probably saved by Danish scholars from the cultural and material ravages wreaked by Danish tradesmen and other agents of the crown. Many of the manuscripts that were not collected by the Danes were eaten in times of famine or, for want of other materials, were used to make clothing.

CHAPTER TWO

History of Magic in Iceland

We are unusually well informed on all aspects of the practice of magic by the Icelanders. Much more than any other nonclassical (i.e., non-Greco-Roman) European people, the Icelanders have left behind a clear record of their magical beliefs and practices and have given us clear ideas of the contexts in which this magic was practiced. We not only have original heathen sources (in the *Poetic Edda* and skaldic poetry) but also clear reflections of pre-Christian practices set down in the saga literature. The sagas are prose works—semi-historical yet embellished tales—written down for the most part between 1120 and 1400. These, however, usually reflect events and beliefs of the Viking Age (about 800–1100).¹

Heathen Period (870–1000)

Sagas regularly feature works of magic and give us vivid pictures of the lives of several magicians.² The most famous of these is the *Egil's Saga*, which is essentially a biography of Egill Skallagrímsson (910–990), an Icelandic skaldic poet, runic magician,

and worshipper of Óðhinn. Beyond such sources, we have, of course, the rare finds of actual grimoires such as the *Galdrabók* represents. Such works, along with runic inscriptions, legal records, and the like form correlation to the "literary" material and fill in some of the gaps left by the sagas and poems.

The early period of Icelandic magic is divided into essentially two phases: heathen and Catholic. The later Reformation, or Protestant, period changed the picture considerably. It was in the Protestant age that the manuscripts of most of the *galdrabækur* were created. However, to even begin to understand the magical world view of the compilers of these books, we must understand well the cosmos of the Germanic heathen past in which their ideas were rooted.

It should be clear from the discussion above, concerning the history and character of the church during the Catholic period, how and why we are able to use documents actually written down at that time as reliable sources for the heathen practice of magic. The Catholic period is really more an age of synthesis than a radical departure from the past as far as magic, as well as culture in general, is concerned.

By all internal accounts, in the heathen age there seem to have been two kinds of magic prevalent: *galdur*³ and *seidh(r)*. Although these later appear to have taken on some moral connotations—the *galdur* form being more "honorable" and the *seidh* form widely considered "shameful" or "womanish"—in reality there seem to have been originally only certain technical (and perhaps social) distinctions between the two. Icelandic *galdur* is derived from the verb *gala* (to crow, chant)⁴ and is therefore dominated by the use of the incantational formula that is to be spoken or sung and perhaps also carved in runes. The original meaning of *seidh* may also have something to do with vocal performance (i. e., singing or chanting), although the exact original meaning of the word is unclear.⁵ What is relatively clear is the procedural and psychological distinctions between these two

techniques. The practice of *galdur* seems to be more analytical, conscious, willed, and ego-oriented, whereas *seidh* appears more intuitive and synthetic. Typical of *galdur* would be the assumption of a "magical persona" or alter ego for working the will, whereas in *seidh* a trance state would be induced in which the ego would be of relatively less importance. It might also be said that *seidh* is closer to what might be understood as shamanic practice.⁶ I hasten to point out that these are really two tendencies in the pagan magic (real though they are), and the "moral" distinction is a later development. Ódhinn is said to be the "father" of *galdur* and its natural master, but it is believed that he learned the arts of *seidh* from the Vanic goddess Freyja.⁷

It is also tempting to say that *seidh* is more based on "natural" methods of working magic (especially with animal and vegetable substances), whereas *galdur* is more based on linguistic/symbolic ways of working (with combinations of verbal formulas and graphic signs). Our texts show that the basic techniques and terminology of *galdur* survived relatively more intact than did those of *seidh*. This is perhaps because of the relatively simple technique of working *galdur*. In the practice of *galdur* the magical work seems more heavily dependent on the powers of the magician himself.

One traditional area of Germanic magic from which the *galdur* of our texts inherits many of its methods is that of rune magic. The runes (Ice. *rúnar* or *rúnir*) constitute a writing system used by the Germanic peoples from perhaps as early as 200 B.C.E. to the early 19th century in some remote areas of Scandinavia.⁸ These runes, or rune staves (Ice. *rúnstafir*) as they were often called, seem to have been used exclusively for nonprofane purposes from their beginnings to the Scandinavian Middle Ages (beginning about 1100 C.E.) The word *rún* in Icelandic signifies not only one of these "staves" used in writing but also, and more originally, the idea of "secret," or "secret lore."

Table 1: The Older Rune-row

Number	Shape	Phonetic Value	Name	Meaning of Name
1	ƒ	f	* <i>fehu</i>	livestock, wealth
2	u	u	* <i>ūruz</i>	aurochs
3	þ	th	* <i>thurisaz</i>	giant
4	ᚠ	a	* <i>ansuz</i>	the god
5	ᚢ	r	* <i>raidhō</i>	riding
6	<	k	* <i>kaunaz</i>	sore
7	χ	g	* <i>gebō</i>	gift
8	ƿ	w	* <i>wunjō</i>	joy
9	ᚱ	h	* <i>hagalaz</i>	hail
10	ᚦ	n	* <i>nauthiz</i>	need
11	l	i	* <i>īsa</i>	ice
12	ᚷ	j	* <i>jēra</i>	year (harvest)
13	ᚻ	ei	* <i>eihwaz</i>	yew
14	ᚥ	p	* <i>perthrō</i>	dice box (?)
15	ᚨ	-z	* <i>elhaz</i>	elk
16	ᚱ	s	* <i>sowilō</i>	sun
17	ᚦ	t	* <i>teiwaz</i>	the god Týr
18	ᚷ	b	* <i>berkanō</i>	birch (-goddess)
19	ᚹ	e	* <i>ehwaz</i>	horse
20	ᚰ	m	* <i>mannaz</i>	man
21	ᚱ	l	* <i>laguz</i>	water
22	ᚷ	ng	* <i>ingwaz</i>	the god Ing
23	ᚫ	d	* <i>dagaz</i>	day
24	ᚨ	o	* <i>ōthala</i>	ancestral estate

*Indicates a reconstructed Proto-Germanic form.

From the origins of the tradition to about 800 C.E. the older system of twenty-four runes prevailed (Table 1). This system was subsequently reformed in an orderly and uniform fashion throughout Scandinavia. But as some formulas in our late texts show, the magical value of the number 24 seems to have continued.

In the so-called Viking Age (from about 800 to 1100) the last heathen codification of the runes took place. It was from this period that many of the pre-Christian aspects of magical practice found in our *galdrabækur* seem to have grown. During the Viking Age the rune staves were reduced to sixteen in number. As in earlier times, each rune had a name as well as its phonetic value (usually indicated by the first sound in its name.) There were also interpretative poetic stanzas connected to each rune.⁹ These are of special interest since they were at least recorded in Iceland and Norway in the 1400s and 1500s—a time very close to that when our earliest magical texts were being compiled. Therefore, we can speculate that the *galdrmenn* (magicians) might have had some detailed knowledge of the esoteric lore of heathen runology. Many of them were certainly literate in runes. The system of the Viking Age runes, as it would have been known to the Icelanders, is shown in Table 2 on page 16.

This table has several things to teach us directly about the significance of what we will encounter in the spells found in the *galdrabækur*. First of all, the number 16 is often found underlying the composition of the stave forms in the spells. They are usually not actual rune staves, but they do reflect the formulaic significance of the number 16. Also, the old rune names show up not only in the spells—where they apparently signify the runes they name (e.g., see Spell 46 in Part 2)—but also in the curious names of the “magical signs” (Ice. *galdrastafir*) themselves, such as *hagall*.

In pagan times the runic magicians were well-known and honored members of society. Traditionally, runelore had been

Table 2: The Younger Rune-row

Number	Shape	Phonetic Value	Name	Meaning of Name
1	ƿ	f	<i>fé</i>	money, gold, livestock
2	ᚢ	u/o	<i>úr</i>	aurochs (or drizzle/slag)
3	ᚦ	th	<i>thurs</i>	giant
4	ᚥ	a	<i>áss</i>	the god (or estuary)
5	ᚷ	r	<i>reidh</i>	a riding
6	ʝ	k/g	<i>kaun</i>	sore, ulcer
7	*	h	<i>hagall</i>	"hail" (special runic name)
8	ᚠ	n	<i>naudh(r)</i>	need, distress
9	ᚨ	i/e	<i>íss</i>	ice
10	ᚫ	a	<i>ár</i>	good year, harvest
11	ᚱ	s	<i>sól</i>	sun
12	ᚢ	t/d	<i>Týr</i>	(the god) Tyr
13	ᚷ	p/b	<i>bjarkan</i>	birch (goddess)
14	ᚨ	m	<i>madhr</i>	man
15	ᚢ	l	<i>lögr</i>	water
16	ᚦ	R/y	<i>ýr</i>	yew (bow)

the preserve of members of the established social order interested in intellectual or spiritual pursuits. For the most part, these men were followers of the god Óðhinn, the Germanic god of magic, ecstasy, poetry, and death.¹⁰ It is also worth noting that men were more often engaged in runic magic than were women—a social phenomenon that is reflected in the later statistics of the witchcraft trials in Iceland.

The general technique of rune magic in pagan times consisted of three procedural steps performed by a qualified rune magician: (1) carving the staves into an object, (2) coloring them with blood or dye, and (3) speaking a vocal formula over the staves to load them with magical power.¹¹ This direct technique, which is not dependent on the objective intervention of gods or demons, will later be in continued evidence in the *galdrabækur*. It clearly shows the continuation of a practice from early Germanic times right up to the modern age.

Several examples from old Icelandic literature will show this kind of magic at work. One of the most interesting examples for our purposes is found in the *Poetic Edda* in the lay called, alternatively, "För Skírnis" or the "Skírnismál" (st. 36). This poem probably dates from the early tenth century. Here the messenger of the god Freyr, named Skírnir, is trying to force the beautiful giantess (etin-wife) to love his lord, Freyr. Skírnir threatens her with a curse:

*A thurs-rune I for thee,
and three of them I scratch—
lechery and loathing and lust;
off I shall scrape them
as on I did scratch them
if of none there be need.*¹²

The basic motivation and stance of the runic magician, as well as technical aspects such as the enumeration of the staves and the actual style of the incantation, will be found in later spells.

Another famous example that clearly shows rune-magical techniques is one in the *Egil's Saga* (chap. 44). In order to detect poison in his drinking horn, Egill drew out his knife and stabbed the palm of his hand. Then he took the horn, carved runes on it, and rubbed blood on them. He said:

I carve a rune on the horn
 I redden the spell in blood
 these words I choose for your ears . . .

The horn burst asunder, and the drink went down into the straw.¹³

Besides runic magic, but often in conjunction with it, we find magic worked in pre-Christian times with certain holy or otherwise powerful natural substances. There must have been a whole magical classification system of sacred woods only dimly reflected in the *galdrabækur*. In any event, the woods of various trees played a special part in the Germanic magical technology as well as its mythology. The world is said to be constructed around the framework of a tree—Yggdrasill (the World-Tree). Humankind is said to have been shaped by a threefold aspect of Óðhinn from trees: the man from the ash and the woman from the elm (*embla?*).

Another substance of extreme importance is blood. The runes were often reddened with it, and it was generally thought to have intrinsic magical powers, especially when it was either human or that of a sacrificial animal. In many pre-Christian sacrificial rites the blood of the animal was sprinkled onto the altar, temple walls, and even the gathered folk, all of which were said to be hallowed by this contact.¹⁴ The etymology of the English verb “to bless” reflects this heathen practice as it is ultimately derived from a Proto-Germanic form **blōthisōjan* (to hallow with blood; PGmc. **blōtham*, blood).

Other than woods of trees, herbal substances were also widely used in pre-Christian magical practice. Especially prevalent were forms of the leek (Ice. *laukur*), the name of which commonly occurs as a magical runic formula even as early as 450 C.E.¹⁵ It is also noteworthy that several herbs bear the names of Norse gods or goddesses, for example, Icelandic *friggjargras*

(Frigg's herb: *orchis odoratissima* or *satyrium albidium*) and *baldrsbrá* (Baldur's brow: *cotula foetida* or *pyethrum inodorum*, or perhaps eye-bright).

Additionally, certain small stones, called in Icelandic *lyfsteinar* (herb-magical healing stones), are thought to have power to heal disease magically. These were sometimes even carved with runes or other signs.

Catholic Period (1000–1550)

The latter part of the age just before the time when the *galdrabækur* began to be set down is called the Catholic period. As will be remembered from our discussion of the politico-religious history of Iceland, a peculiar kind of Catholic Christian church existed in Iceland from 1000 to the middle of the 1500s. In all facets of life this represented a period of mixed faith in which elements of the ancient native heritage and the new foreign religion were being syncretized.

Heathen elements in the magical tradition would naturally be diminished both as new material was introduced and as knowledge of the technical aspects of the pagan tradition began to fade through neglect and lack of the old establishment support. Nevertheless, the old material and techniques must have continued in a real way for many generations. In a way this is a "dark age" for our knowledge of the actual practice of magic in Iceland because the works composed at this time depicted the Viking Age practices, and we have no actual *galdrabækur* from the period itself.

From what we have in the Reformation Age, it is possible to speculate that the heathen tradition was kept alive on its own terms for a long time but eventually was syncretized with the Christian tradition. It must, however, be understood that prac-

ting magic at all was considered by orthodox forces to be heretical and somewhat diabolical. (That is why there is an active, explicit merger of the old gods and the demons of hell. See chapter 4.)

The influence of the foreign Christian tradition seems to have been most keenly felt in new elements introduced in the formulas. These would include personalities from explicitly Judeo-Christian mythology (e.g., Solomon, Jesus, Mary). Beyond these personalities certain formulas must have been incorporated at this time: the use of the trinity, formulas of benediction peculiar to the Catholic church, and so on. Other elements, such as Judeo-Gnostic formulas (e.g., Jehova Sebaoth [Yahweh Tzabaoth], Tetragrammaton) must have come directly from magical books imported from the Continent at this time. As far as the actual methods of working magic are concerned, there must have been a relative shift in emphasis to the prayer formula, in which the magician bids for the intercession of some supernatural entity on his behalf. Although this was probably known in some form in the heathen age, it had limited application; whereas it predominates in the Judeo-Christian tradition.

The information we have about magicians and magic of this period is very indirect. Although many texts were composed in this period, they mostly harked back to the heathen age when magic came into play. The later folktales, mostly collected in the 1700s and 1800s tell of two famous magicians of this age, however. One was Sæmundur Sigfússon the Wise (1056–1133), who was the *godhi* (priest-chieftain) of Oddi. He is reputed to have been the most learned man of his time, but all of his writings are now lost. Further, he was said to have acquired magical knowledge as a captive of the Black School of Satan. This legend may be due to the fact that he studied Latin and theology in France. Sæmundur has the reputation, despite the origins of his knowledge, of being a “good” magician. It seems that the rep-

utation for "white" or "black" magic that the historical magicians acquired was due more to literary stereotyping and regional conflicts than to any historical or practical facts. Sæmundur's sister Halla also "practiced the old heathen lore," as one text describing her puts it, although the writer feels obliged to add that she was "nevertheless . . . a very religious woman."¹⁶

Reformation Age (1550–1750)

With the advent of Protestantism in Iceland, beginning about 1536, a radical new situation began to prevail. As learning decreased in quality and persecutions of magic increased in intensity, elements of Icelandic magic already in place began to reach knowledge and practice as far as the establishment was concerned, so it therefore became more wrapped up in the mixture of previously rejected heathenism.

At the close of the Catholic period there were two contemporary Icelandic magicians with very different reputations. Gottskálf Niklásson the Cruel (bishop of Hólar from 1497 to 1520) had a reputation as an evil magician. He was the compiler of the fabled *Raudhskinni* book of magic discussed in chapter 3. Gottskálf is well known in Icelandic history otherwise as a ruthless political schemer who conspired against secular political figures for his own selfish ends.¹⁷ This as much as anything else probably led to his reputation in the folk tradition. An approximate contemporary of Gottskálf was Hálfðanur Narfason (died 1568), vicar of Fell in Gottskálf's diocese of Hólar. Little is known of Hálfðanur's life, but there is a rich body of folktales concerning him.¹⁸ He seems to have been the legendary "white" counterpoint to the "black" Bishop Gottskálf.

Hálfðanur and Gottskálf form a kind of bridge between the Catholic and Reformation ages in the history of Icelandic magic.

Deep into the Protestant period we again have a pair of strongly contrasted magician figures: Eiríkur of Vogsósar and Galdra Loptur. Eiríkur, who was a quiet and pious vicar, lived from 1637 to 1716. He is little known in history but shares with Sæmundur the reputation of a practitioner of good magic, wholly derived from godly sources—although he was not above practicing the most dreaded arts (e.g., necromancy) for “pedagogical purposes.” Here I refer to one of the most telling anecdotes in the history of Icelandic magic, one that emphasizes the character and level of humor necessary to practice magic:

Two boys once came to Eiríkur the priest and asked him to show them how he would set about raising ghosts. He told them to come with him to the churchyard, and they did. He muttered something between his teeth, and the earth began gushing up out of a grave. The boys reacted differently; one laughed, and the other burst into tears. Eiríkur said to the latter: “Go home again, my good fellow, and thank God you did not go out of your mind. As for this other boy, it would be a pleasure to teach him.”¹⁹

This might be compared with an episode involving Galdra Loptur (Loptur the Magician) that is supposed to be one of his most depraved acts—raising the *draugur* (ghost) of Bishop Gottskálk in order to recover his famous “black book,” *Raudhskinni*. Little is known of the historical Loptur, but we do know that he was a scholar at the school at Hólar and that he died in 1722. In Galdra-Loptur we have a kind of Icelandic Faust, whose major sin is his insatiable desire for more knowledge and power.²⁰

The use of folktales to trace the history of magic is a risky task. They really tell us more about the changing attitudes of the folk toward magic and other human motivations than about the actual practices of any given time. However, in this area as in so many others, Iceland provides remarkable technical detail and often surprisingly value-free renditions of events—even

though the teller of the tale may feel the need to comment negatively or positively as an aside. When we look over the whole body of Icelandic folktales dealing with magic we see certain trends. For example, men of high rank are rarely chided with charges of black magic, even though their reported practices seem little different from those against whom the charge was leveled.

In the early phase of the Christian period, heathen lore was looked upon with some ambivalence, and the Christian Devil was hardly understood. It seemed to be a moral watershed as to the source of a magician's knowledge and power—of the Christian God or of some other source (i.e., heathen/diabolical). Later, especially in the Protestant period, all magic was looked upon with suspicion—all wizards were "gray" at best. This attitude in the folktales is perhaps most eloquently symbolized in the *Galdrabók* in those spells in which the old gods are equated with infernal demons and Valhöll is somehow equated with hell.

Because of Iceland's peculiar church organization in the Catholic period and the general isolation of the country from Continental affairs, the practice of magic was not officially persecuted or prosecuted during that time. The Inquisition became active on the Continent following Pope Innocent III's bull of 1199. That was mainly directed against organized heretics, but its circle gradually widened to include sorcery even when heresy was not involved (in a bull by Pope Nicholas V in 1451). But even this failed to penetrate the dark mists of Thule. In large measure this phenomenon is probably due to the fact that it was clergymen themselves who were most actively engaged in sorcery in Iceland!

The Protestants on the Continent were no less severe in dealing with witchcraft than the Inquisition had been, and in many cases they were more devastating in that their focus on individuals and small groups made more indiscriminate perse-

cutions easier. It was under cover of the Reformation that witchcraft persecutions came to Iceland. These persecutions never reached the genocidal levels known on the Continent, where hundreds of thousands were executed, but they are nevertheless historically significant.

The first trial for witchcraft in Iceland is recorded in 1554, the last at the Althing of 1720. Records were poorly kept in this period; however, it is estimated that during this time some 350 trials were held, although records for only 125 survive. Of these 125 accused persons only 9 were women.²¹ This is in marked contrast to the general pattern of witchcraft accusations and certainly suggests something of the demographics of magical practice in Iceland. This is generally a reflection of long-standing Germanic tradition, in which men were at least the equal of women in the occult arts. We have records for only twenty-six executions (mostly by burning) for witchcraft. Only one woman was actually executed. Others who were convicted of this crime, but whose sentence was short of death, were flogged or outlawed (in effect banished from the country).

The period of most intensive witchcraft persecutions is clearly marked between the first execution in 1625 and the last in 1685. However, it is worth pointing out that during this time Iceland suffered generally under a moral code of extremely harsh laws, which provided for capital punishment for a wide variety of crimes—murder, incest, adultery, theft—as well as witchcraft. Also, finding rune staves carved on a stick or written on parchment was evidence sufficient to convict someone of witchcraft. All of this is a far cry from the saga age when great men knew the runes and the Althing could not impose the death penalty. Finally, it is noteworthy that although it was not necessarily the poorest or most ignorant folk who were accused of sorcery, the rich, powerful, or scholarly (who were in historical retrospect the chief practitioners) were largely immune.

As to the kinds of magic practiced in this period, we have direct evidence in the form of the *Galdrabók* itself, which was compiled over a period between about 1550 and 1680, including many years of the persecutions. Here we are not dependent on secondhand descriptions but have the practical manual itself as it was used by actual magicians. The same can be said for the other, later material recorded in Appendices A and B. The remaining chapters treat the various aspects of magic as practiced in the *Galdrabók*.

In the 1550–1680 period Iceland developed a national synthesis of magic that was worked by members of the highest levels of its society. But it is perhaps because of the relative lack of a strict set of socioeconomic and educational class distinctions in Iceland at the time and afterward that the synthesis survived as long as it did. Even today Icelanders are noted for their particularly strong beliefs in occult matters²² and their unabashed pride in their heathen past.²³

CHAPTER THREE

Icelandic Books of the Black Art

Besides the *Galdrabók*, which is the focus of our study here, the apparently once rich textual tradition of Icelandic magic is in fragments and shreds. The folktales of Iceland report on the existence of famous books of the black arts owned by notorious magicians of history and housed in renowned schools where magic was practiced. These kinds of books were also reported in more reliable historical sources, some of which even contain summaries of their contents. Otherwise we are dependent on later collections and on stray references in manuscripts whose contents are generally other than that of *galdur*. Some of the later books containing spells are profiled in Appendix A.

In legend, the earliest of the famous Icelandic magicians of the Christian period, Bishop Sæmundur the Wise, is said to have learned the arts of magic at a mysterious Black School of Satan somewhere on the Continent, perhaps in Germany or France.¹ But in later times the two cathedral schools of Iceland at Hólar (in the north) and Skalholt (in the southwest) were the hotbeds of magical activity. As noted before, the legendary material also tends to divide the master magicians into two main types: be-

neficient and malificent. Sæmundur the Wise is the model of goodness, and Gottskálk the Cruel is the archetype of evil. It is curious, however, that their sources of magical lore are the same (as often from Satan or Ódhinn as from the Christian God); and in the books that have survived, all kinds of magic are merrily mixed together. It seems that to the magician himself (not necessarily to the nonmagicians who might sit in judgment of him) magic is a neutral thing that can be used in causes just and unjust.

The Black Books of Legend

There are two main texts of legendary importance in the history of Icelandic books of the black arts. It is impossible to tell where legend ends and history begins with these accounts, but one thing that is borne out by hard evidence is the importance of such books and the nature of their contents.

The most famous and sinister of all of these books was *Raudhskinni* (Red Leather), which was said to have been compiled by the most evil of all magicians, Bishop Gottskálk Niklásson the Cruel, Bishop of Hólar from 1497 to 1520. *Raudhskinni* is said to be a book of the blackest magic, drawn from the heathen age. It was supposed to have been written with golden letters on red parchment (hence, the name "Red Leather"). It is also said to have been written in runes.² Gottskálk is reported to have been buried with the *Raudhskinni*, and it is further said that he did not teach all of the magic compiled in the book. Therefore, the text was assumed to be of enormous secret power. Some two hundred years after Gottskálk's death there was said to be a scholar at the school of Hólar named Loptur, or Galdra-Loptur. Loptur wished to gain the knowledge contained in *Raudhskinni*, so he set about to raise the dead Gottskálk and force him to give

up the book. Loptur was unsuccessful, however, and was left shattered by the encounter with the powerful ghost of Gottskálf.

Another famous magical book of semilegend was *Gráskinni* (Gray Leather). There were perhaps at one time two books by this name, one at Hólar and one at Skalholt, both originally compiled from the same source. The description of this book is interesting in that the text is supposed to have consisted of two parts, the first part written in normal letters (i.e., in the Roman alphabet) and containing information on lesser magical arts, for example, *glímugaldur* (wrestling magic) and *lófalist* (palmistry). The souls of those who read just the first part could still be saved, but those who read the second part of *Gráskinni* were damned. This second part was said to be written in *villurúnir* (erring runes, i.e., coded runes designed to conceal their actual meanings). These were black magical spells the magician Galdra-Loptur had mastered.⁴

Of course, these books may never have actually existed, but certainly ones with contents like those described in folktales did exist. In fact, our *Galdrabók* is a surviving example. We do not need to repeat what the usual fate of such books was once they were discovered by the establishment authorities. However, it is useful to recall that there was an active campaign against such books for centuries, and given that circumstance it is remarkable that the *Galdrabók* was able to survive.

Text of the *Galdrabók*

The original manuscript of this collection of black magical spells was written in Iceland beginning sometime during the latter part of the 1500s. It is therefore a product of the Reformation Age. The manuscript does not represent a comprehensive composition, but rather it is a collection of spells, more or less randomly

pieced together.⁵ As we have the book now, it has been added to by four scribes working over a period of as long as a hundred years.

The first magician, working in Iceland during the latter half of the sixteenth century, wrote down spells 1–10. Soon thereafter it was passed on to another Icelander, who added spells 11–39. Perhaps sometime later a third Icelandic scribe came into possession of the book and added spells 40–44. This latter *galdramaður* wrote in the cursive style of the 17th century. What is remarkable about his work is that it contains such a rich store of references to the older gods and to Germanic lore—and this was around 1650, more than half a millennium after that fateful Althing of the year 1000! Not long after this third scribe had added his spells, the book was taken to Denmark, where it came into the hands of a Danish magician who wrote in spells beginning with the last section of 44 through 47. This Dane must have also had the use of other Icelandic books of magic, now lost, from which he collected these spells.

In 1682 the book was acquired by the Danish philologist J. G. Sparfvenfelt and was later acquired by the Swedes (some time between 1689 and 1694) for their great collection of "Gothic" monuments and manuscripts. Eventually it found its way into the Academy of Sciences (State Historical Museum) in Stockholm, where it is now.

A survey of the contents of the manuscript reveals some interesting tendencies. There are essentially two kinds of magic worked here. One works by means of a prayer formula in which higher powers are invoked and by which the magical end is effected indirectly. This is the case only with a minority (a total of eight) of the spells in the *Galdrabók*. Far more common are the spells that work as direct expressions of the magician's will. This will is expressed through signs, or through written or spoken formulas. Often these methods are combined so that the overall

ritual formula is very similar to the kind practiced in ancient times and reported of Egill Skallagrímsson, for example. There are a total of twenty-three spells using *galdrastafir*, while eight make use of spoken or written spells. Two, 33 and 45, make use of formulas that mix the prayers with the use of *galdrastafir*. Three spells employ neither prayer nor signs but rather make use of natural substances that are supposed to work a magical effect. This is the kind of natural magic most often found in the "leech-books," or physicians' manuals.

The religious outlook expressed in the spells is also of central interest. A full twenty-one of the spells have a predominantly non-Christian or overtly heathen (or even diabolical) viewpoint. This is not unexpected, as the whole practice of magic had been associated with the heathen past and with demonic sources from the time of the introduction of Christianity. In spite of this, there are some nine spells that have a "purely Christian" outlook in that they overtly cite Christian figures or use Christian formulas. There are also eight spells that demonstrate Judeo-Gnostic roots: 5, 10, 11, 12, 31, 37, 39, and 42. These often make use of Judaic or Greco-Gnostic formulas but cannot be classified as Christian. They were, no doubt, borrowed from the Continental tradition along with the overtly Christian formulas. Additionally, there are five highly curious spells that mix overtly Germanic pagan contents with overtly Christian contents. It is worth noting that four of these were added by the last two scribes. This might indicate that the pagan and especially the Catholic-Christian formulas were receding further into the category of rejected knowledge and were thus increasingly becoming candidates for use in magical formulas.

There are roughly six different magical motivations expressed in the spells of the *Galdrabók*. By far the most common are apotropaic, or protective, formulas, of which there are no less than eighteen. Besides these spells, which are constructed

so as to protect the magician from some active harm (e.g., troll-shot or the wrath of powerful men), there is a group of nine generally beneficent spells designed to bring the magician good fortune or beneficial circumstances. An overriding concern of the magicians who compiled this book was the discovery of thieves. There is a total of six such spells. These are curious in that they are spells for the acquisition of some form of clairvoyance or magical knowledge (Ice. *kunnátta*; see Spell 44) by which the magician will be able to "see" an image of the man who stole from him. The last spell (47) is a formula for invisibility.

Besides these protective and otherwise passive formulas, there is a sizable group of spells devoted to more aggressive forms of magic. These are ten in number, of which four or so are among the most mischievous yet recorded in the annals of sorcery. If Icelandic magicians went around casting these spells, it is no wonder they spent so much time and effort worrying about the "wrath of powerful men."

Other Historical Manuals of Magic

Of course, besides the *Galdrabók* no coherent and archaic book of its kind exists anymore. But there are a number of books that contain various amounts of interesting lore. One of the main problems in research in this area is that the sources have not been collected, and/or convenient editions of them have not been made.

There are historical records of books from the 17th century that give us some idea of their basic contents. The magical books of Pastor Jón the Learned (1574–1650?) fell into the hands of Pastor Gudmundur Einarsson of Stadharstadhur in 1625. Gudmundur used these books to write a tract against the prac-

tice of magic in 1627.⁶ Jón was said to be a learned but superstitious man who spread the lore of magic in the form of *kreddur* or superstitious beliefs. We know from secondary citations of this now lost tract by Gudhmundur that Jón's books contained spells using the sator-square⁷ and "runes" connected with biblical passages (mostly from the Psalms). Gudhmundur, who was at pains to connect this lore with the worship of Satan, ventured an interpretation of the sator-square as a scrambling of the sentence *Satan operor te, operor te Satan*. This he translates as "Satan I am in thy work, I am in thy toil."⁸ As a result of this publicity and the efforts of Gudhmundur, Jón was condemned for witchcraft at the Althing of 1631 but was not executed.

There also exists a detailed catalog of the contents of a *galdrabók* found by the schoolmaster of Skálholt in the bed of two students in the year 1664.⁹ The schoolmaster handed it over to Bishop Brynjúlfur Sveinsson, who made a listing of its contents. The book itself was most certainly burned, but the students were spared the same fate. They were not even tried, but they were expelled from the school and exiled to England. One of them returned after some years.

The descriptive list made by Brynjúlfur contains eight items. Here are translations of some of those that are most interesting for our purposes. No. 14: "To wrestle in a different way, with carvings and the drawing of blood. Additionally [four signs: hedge-hog tooth, *ginfaxi*, *hagall*, and *satrix*." No. 20: *Aegishjálmur* (helm of awe). No. 24: "Conjuration for a fox. Her Thórr and Óðhinn are invoked, with twenty-three signs." No. 26: "Conjuration for a mouse, with a human rib—the Devil is invoked in complete trust in Thórr and Óðhinn with the verse sator arepo, etc." No. 27: "To give someone the sleep-thorn with the drawing of blood and two signs." No. 29: "To make someone sleepless, with a cursing verse and one sign. Addition

ally the Devil is called upon as well as twelve arch-devils by the power of Lucifer." No. 39: "To find out who stole from someone, with two signs *hagall inn minni* [hagall the lesser]." No. 74: "So that a troll of *útburdhur* [the ghost of an unbaptized baby] will not drive someone mad, with four signs." No. 77: "To carve the sleep-thorn for someone." No. 80: "Against theft: conjuring *hrímthurs* [rime giant] and *grímthurs* [cruel giant] and the Father of all Trolls [Ódhinn] with twenty-nine signs." The contents of this list may be compared beneficially with the contents of the *Galdrabók* and with the later collections found in the appendixes of this book.

At least one old Icelandic leechbook (physicians' manual) from the late 1400s contains several leaves at the beginning that are more magical than the average contents of the book.¹⁰ These contain some of the oldest representations of the *ægishjálmur* and similar signs, as well as prayer formulas in which the old gods (i.e., Ódhinn [also as Fjölnir], Thórr, Frigg, and Freyja) are mixed with Judeo-Christian figures.

The other Icelandic sources treated extensively in Appendix A are collections made in the 1800s. Their contents usually go back to the 1700s, and their substance, as can be seen directly, goes right back to the medieval period and beyond. The reader is advised to see the introductory material in Appendix A for the historical details of these collections.

Besides the Icelandic material, which is the core of this study, I have also appended material from other Germanic areas. Appendix B has a selection from an Old English leechbook that gives an insight into a different traditional mix but nevertheless often retains much of the more archaic underlying Germanic lore. Finally, Appendix C has the most famous spells in the history of Germanic magic, which are from the Continental German tradition and which have important Indo-European parallels.

The Two Traditions in the North

Although the situation is actually much more complex than I am able to present it here, from the perspective of the northern, or Germanic, region there were essentially two great traditions of magic, the northern and the southern. They are not of overriding importance to our study, since we are concentrating on the Icelandic tradition, which was by far the most conservative of the Germanic lands. But when we look at the magical traditions of England and Germany as early as the tenth century or at the magical teachings in Sweden in the sixteenth century, we see the transmission of virtually pure magical traditions—in the form of literature often translated in part into the vernacular—from the Mediterranean to the northern lands. Of course, it must be understood that the Mediterranean “tradition” was by this time an entirely artificial and composite one made up mainly of elements from Greco-Egyptian, Judeo-Christian, and even “eastern” features from various Near Eastern and Indian cults (e.g., Manichaeism). This synthetic Mediterranean tradition marched steadily against the northern tradition, not (as with religion) by brute economic and military force but by the gentler force of prestige.

In no region is this whole process clearer and more polarized than in Germany. There the second Merseburg spell is the last record of Wodan's name being used in a magical context. However, the use of his name continues into the 1700s and beyond in Iceland and remote regions of Scandinavia—and perhaps even in the countryside of England. In Germany we find that the old folk tradition, although to a great extent superficially “Christianized,” retained a heathen spirit.¹¹ This tradition continued to be practiced at the level of the common folk in the countryside and on the heaths, but in the cities and university towns the Mediterranean tradition was being developed, articulated, and,

typically, improved by German scholars and magicians from the semilegendary Georg (Johann) Faustus (1480–1539?) to Albertus Magnus (1193–1280), Theophrastus Bombastus von Hohenheim (Paracelsus) (1493–1541), and Cornelius Agrippa von Nettesheim (1486–1535). The influence of the two traditions was mutual. An examination of the German hermetic magicians will show a high level of interest in and use of the local folk traditions. In turn, the folk traditions were saturated with non-Germanic figures and entities that have largely replaced the pagan ones.

CHAPTER FOUR

The Old Gods and the Demons of Hell

The traditional gods and goddesses of the Germanic peoples had an uncanny way of surviving in the Icelandic national tradition of magic and folklore. Although we find only isolated mention in the oldest sources of German or English or even in other Scandinavian traditions, we find a widespread and vigorous life for the old gods in the Icelandic world. The reasons for this should be obvious from the foregoing discussions of the peculiarities of Icelandic socioreligious history.

As far as the old gods in the other Germanic traditions of magic are concerned, the reader should consult the relevant appendixes in this book. The texts in those sections have been selected principally on the basis of what they tell us of the most traditional levels of magic, which includes the use of not only the names of the old divinities but also the contexts in which they occur.

Here we will look at the complete picture of the "theology" and/or "demonology" presented in the *Galdrabók* and related Icelandic texts. It is our principal aim to look at the survival of the heathen divinities as such, but we will also examine their relationship and apparent assimilation to the mytho-magical figures from the Judeo-Christian tradition, both evil and good.

The Heathen Gods and Goddesses

In the Germanic tradition, as well as in every other indigenous tradition over which Christianity was laid, the old popular divinities survived in at least two ways: (1) by being driven “underground,” where they often lived alongside the other rejected entities (e.g., demons), or (2) by being assimilated to accepted or established entities. This latter method was by far the more common throughout all traditions. In some cases the old gods were identified with Jesus, his disciples, the apostles, and most commonly with various saints. These saints were sometimes preexisting ones, but in some cases there seems to have been a virtual canonization of the old divinities under new “Christianized” names and circumstances.¹ This is really a separate study, as we can be concerned here only with those instances found in magical texts. However, it is worth realizing that this was a general and widespread phenomenon not limited to the magical arena.²

By far the most vigorously represented of the old gods in the Icelandic sources is, not surprisingly, the *Galdraföðhur* (Father

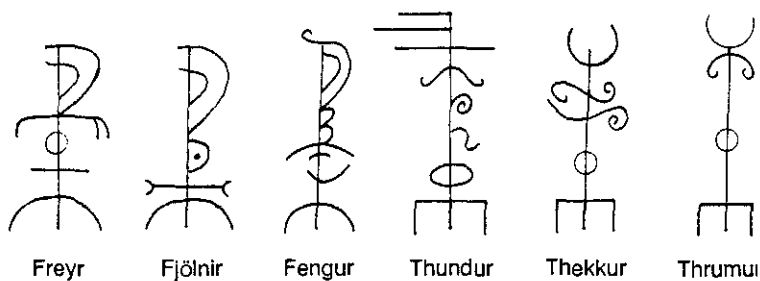



Figure 1: Six *galdrastafir* recorded by Jón Árnason.

of Magic)—Ódhinn. Not only does his name appear in virtually every litany of names of the old gods, but also his *heiti* (Ice.; nicknames) frequently appear as names of magical signs or in other litanies. For example, Jón Árnason records a series of six *galdrastafir*, each with a distinctive name.³ (See Figure 1.)

Of the six, four (2–5) are well attested Ódhinn nicknames.⁴ These and other such magical bynames of Ódhinn show that knowledge concerning the complex lore of Ódhinn's various functions was kept alive, not merely his most usual name. In the *Galdrabók* Ódhinn's names are recorded in a total of six spells (33, 34, 41, 43, 45, and 46). Of these, two (33 and 45) are for uncovering thieves, two (34 and 43) are love spells, and 41 is to allay the anger of another—which is needed, given the malicious curse formula of Spell 46! A review of those spells will show that Ódhinn can be found in any company and for a wide spectrum of magical aims. Every indication points to the continued active—even if corrupted—knowledge of Ódhinn and his magical functions. Of all of the names of the old ones, Ódhinn is, as Spell 43 puts it, the *megtugaste* (mightiest).

Perhaps the second most actively represented of the old gods is Thórr. This is not surprising either, since he seems to have been the most popular god in pagan Iceland. In the *Galdrabók* he is not represented outside the litanies of divine and demonic names in spells 43, 45, and 46. However, there is other evidence show that Thórr's role in Icelandic magic was significant through a *galdrastafir* called the *Thórshamar* (Thórr's hammer). The name of this sign was attached to several forms over a long history. At one time it was ascribed to the solar wheel, or swastika, and is recorded in the folktale material of Jón Árnason with the form , which seems reminiscent of the old solar wheel.⁵

Curiously enough, the names of these two gods appear to have survived right up to modern times in locations remote from

Iceland. In England during the late 19th century the following magical incantation was recorded in the dialect of Lancashire:

*Throice I smoites with Holy Crok,
with this mell [hammer] Oi throice dew knock,
One for God,
An' one for Wod,
An' one for Lok.*⁶

The Wod mentioned here is obviously Wod(en), and the Lok probably refers to Loki—all of which points to a survival of an odd mixture of English and Scandinavian lore. In this century a German woman in North Carolina was found to be using the name of Thor(r) in combination with the Holy Trinity in a healing rite.⁷

Besides these two prominent divinities mentioned in various spells, at least two of the elder divinities' names appear as part of the names of certain herbs. *Friggjargras* (the herb of Frigg) is mentioned in Spell 40, and another herb is called *Baldursbrá* (the brow of Baldur). Frigg was the wife of Ódhinn, and Baldur was one of his sons, who was known for his invulnerability, his perfection, and his murder at the hands of Loki and Hödthur.

At least one myth is alluded to directly in Spell 46 of the *Galdrabók*, which says: "thou wilt be as weak as the fiend Loki, who was bound by all the gods." This shows that the mythic material recorded in the *Poetic* and *Prose Eddas* was well known to the *galdramadhur* who composed the spell.⁸

Although there are some spells in which single Germanic god names appear, it is more usual for them to be used in litanies of god names. We see these in spells 33, 43, 45, and 46. There are several things worth noting about these litanies. They contain the names of the great gods and goddesses of the ancient Ger-

manic religion, but they do not seem to be organized in any way especially meaningful to the pagan theology. Also, the last three of these four litanies are really syncretic compositions in which the Germanic names appear right alongside names from Judeo-Christian and Mediterranean myth and magic. But the overall impression is that the Judeo-Christian elements are newcomers in an already established magical system.

This impression is strengthened by the fact that not only are the great divinities of the Germanic high mythology present but also that the so-called lesser divinities of the pagan Germanic cosmos give shape to the magical world view of the *Galdrabók*. There are several mentions of the belief that trolls or elves could be responsible for afflictions by means of magical "shots," or projectiles hurled at people (see spells 21 and 39), whereas the "giants," or more precisely, etins (Ice. *jötnar*), are mentioned twice (see spells 33 and 34).

Perhaps one of the most interesting survivals is the name of the dwelling place of the gods—Walhalla (Ice. Valhöll). Valhöll is the "hall [or perhaps "rock"] of the slain" and is held to be a dwelling place in Ásgardhur (court of the gods) in which Odinic warriors who died in battle are housed in the supernal realm. This shows a certain continuance of cosmological traditions from the heathen past that impressed itself on the structure of the new entities coming to the north.

The Demons of Hell

Not only are the old gods of the Germanic peoples said to be in Valhöll, but in the view of the *galdramenn* who wrote this book, so too were demons of Hebraic mythology—Satan and Beelzebub—to be found there. The most revealing formula is found in

Spell 43, where we read: "Help me in this, all ye gods: Thórr, Ódhinn, Frigg, Freija, Satan, Beelzebub, and all those gods and goddesses that dwell in Valhöll." The fact that Satan had come to Valhöll was a significant event in the history of Icelandic magic. This symbolically and eloquently shows how the southern magical elements were at first assimilated in the north on terms set by the northern tradition.

From the standpoint of the new establishment culture, however, this had the net effect of "diabolizing" the old Germanic gods. To a great extent, but certainly not exclusively, the old gods were equated with devils in the Christian mind. As time went on, especially beginning at the time of the *Galdrabók*, aggressive magical spells would be more likely to use the old gods or demons in their formulas, whereas protective spells were more likely to make use of Christian elements. This is obviously not a hard and fast rule at the time of the *Galdrabók* but only a general tendency.

As noted earlier, the old characteristics and functions of the multifaceted traditional deities became split up by the more dualistic and dichotomizing Christian dogmas, so for a while the old gods could feel at home alongside Jesus or Satan. But when all was said and done, because of fundamental defects in Christian doctrine, the old gods and goddesses of Valhöll ultimately found the company of Beelzebub and Satan more to their liking.

It might be convincingly argued that the way for this process in Scandinavia had been prepared centuries earlier. That is because the Christianization of various Indo-European people (Greeks, Romans, Celts, and the kindred Germans) was generally accompanied by a suppression of the pagan gods through campaigns of diabolizing them—turning them into devils. It is then no wonder that the heathen deities of the north—or more precisely their sympathizers and followers—would recognize their kith and kin in the guise of the Christian "devils." Nowhere is

this process more blatantly shown than in a Low German baptismal oath from the ninth century:

Forsakest thou the devils?

et respondet: I forsake the devils.

and all devilish sacrifices?

respondet: and I forsake all devilish sacrifices.

and all devilish works?

respondet: and I forsake all the works and words of the devil, and Thunar and Woden and Saxnote and all those who are their companions.

Dost thou believe in God the Almighty Father?

respondet: I believe in God the Almighty Father.

Believest thou in Christ the Son of God?

respondet: I believe in Christ the Son of God.

Believest thou in the Holy Ghost?

respondet: I believe in the Holy Ghost.⁹

On the other hand, and especially in the Catholic period, the new religion was heavily impressed with heathen ideas. Certain aspects of the old faith were superficially Christianized, and many old traditions were given a Christian veneer. In the world of the magicians this meant that Christian figures could sometimes be used right next to pagan deities. And as our wondrous example in Spell 46 shows, the northern sorcerer was so free magically that he could use the names of Óðhinn, the Savior, and Satan in the same litany.

It might also be true that many times when the words "lord" (Ice. *dróttinn*) or "god" (Ice. *gudh*) are used, they are not free of heathen connotations.

The Icelandic magical triangle of Germanic entities, Christian entities, and Christo-demonic entities is a peculiar one in

that the old gods remained relatively stronger in Iceland than anywhere else, and they survived most vigorously in magical practice. Even in the folktales "heathen knowledge" is equated with sorcery. Further, it seems that taken as a whole and as far as magic is concerned, the demonic entities were never as "evil" nor the Christian figures ever quite as "good" as they seem to have been in other regions.

CHAPTER FIVE

Runes and Magical Signs

By the 16th century the ancient lore of the runes was in a highly corrupt state. However, the history of magic shows that confused forms can apparently still be used meaningfully by skilled sorcerers. What is of interest for us here is the way in which essential methods of runic magical technique—very different from those of the magic that could have been imported from the Mediterranean—were handed down in the Icelandic tradition. The two major distinctive graphic features are the use of runes or runelike signs and the use of magical signs (*galdramyndir*) that may or may not have runic origins. Another striking feature is the very technique by which this magic was worked, as it is virtually identical with that of the rune magic of the heathen age.

The runes themselves continued to be known as a practical script in Iceland, and we see them used to write inscriptions in and around some of the magical sigils in Appendix A, for example. But these relatively clear instances of runic writing were far less prevalent than the use of encoded runic forms called *villuletur* or *villurúnir*, which were meant to confuse and conceal

rather than actually reveal meanings. One of the ways in which runelore was apparently used by the wizards who compiled these spells was to have certain numbers of runelike figures arranged in a way that suggested the runic system. Notes to spells 12–19, for example, show a variety of ways in which the numerical systems and the forms of the runes themselves were used in magical “staves.” There seems to be an effort to have a significant number of figures to make up complexes of signs, so there are twenty-four or sixteen or eight of them in the formulas.

Another feature apparently inherited from ancient runic magical practice is the very terminology used to describe the figures and ways of using them. Most often the figures are referred to in Icelandic as *stafir* (sg. *stafur*)—“staves.” This is inherited from the old technical designation of runes as staves or sticks because they were often carved on such wooden objects for talismanic purposes. The execution of these figures for magical purposes is indicated by the Icelandic verbs *reisa* (to scratch) or *rísta* (to carve). These are used in contexts that show that actual cutting or carving is intended (e.g., into wooden objects) but also in contexts that show that what is actually intended is more like writing, as with ink and quill on parchment or paper. However, the old magical runic terminology died hard.

Probably the most outstanding single feature of the Icelandic books of magic is their use of complex magical signs. Most efforts at classifying these signs try to come to grips with their relationships to the runes and their magical functions.¹ There seem to be three main types of such signs: (1) *bandrúnir* (bind runes, made up of more or less obvious combinations of runes), (2) *galdrastafir* (magic staves, which were perhaps originally bind runes but which have become so stylized as to take on independent lives of their own), and (3) *galdramyndir* (magic signs, which seem to have always been nonrunic abstract signs, such

as the Thórr's hammer discussed above). Many of the signs appear to be combinations of runes and abstract cosmological signs. The main problem in any effort to "decipher" these signs is the long-standing tradition of stylization and simplification (or artificial complication). Another form of classification has to do with their magical functions. If they were intended to be protective amulets, they might be called by the Latin name *innsigli* (sigils) or by the Icelandic term *varnastafir* (protective staves). The term *galdrastafir* would then indicate magic of an operative nature, meant to cause alterations in the environment. Protective magic could be Christian and would often use biblical passages to charge the figure with intent, but operative magic was very often considered heathen (or devilish).

Again, it is almost impossible to read any linguistic meaning in the *galdrastafir* (and many of the *bandrúnir*) without having some lead given in the commentaries. These leads usually come in the form of names given to these signs. Examples of these are given in Figure 1, on page 38, with the *bandrúnir* that have been stylized in the medium of pen and ink. Nevertheless, many of their runic features are obvious. However, many of the names given to magical signs seem to have to do with their functions and not their forms. The names themselves are usually unique words that are highly obscure in meaning. The two most famous names of such signs are *ægishjálmur* (the helm of awe, or terror) ✖ and *svefnthorn* (sleep-thorn) ⚔. The *ægishjálmur* could become a very complex kind of figure, but its basic form was that of a four- or eightfold cross with branches at its terminals. With these two signs we are lucky because we have mythic survivals that give us some insight into their origins and meanings.

The *ægishjálmur* is mentioned in the material concerning Sigurdhr Fáfnir-bane.² When Sigurdhr slays the great etin-worm, or serpent, named Fáfnir in order to win the treasure hoard of

S	A	T	O	R
A	R	E	P	O
T	E	N	E	T
O	P	E	R	A
R	O	T	A	S

Figure 2: Sator-square.

the Niflungs (Niebelungs), one of the “objects” of power that he gets is the *ægishjálmur*. This object is not a helmet but more of a general covering that surrounds the “wearer” with an overwhelming power to terrify and subdue his enemies. The power is concentrated in or between the eyes and is often associated with the power serpents have to paralyze their prey. This is apparently an ancient Indo-European concept, as is shown in the etymology of the Greek *drakōn*—the one with the evil eye. We also think of the Gorgons’ ability to paralyze with the gaze of their eyes set in a head surmounted with serpents. Whatever the origins of the Icelandic magical sign, its function remains essentially the

same, but here there are practical indications, not just mythic allusions.

The *svefnþorn* is also mentioned in Old Norse mythic literature as the magical device with which Óðhinn placed one of the *valkyrjur*, Sigrdrífa (or Brynhildr), into a deep slumber, from which she could be awakened only by one who could cross the magical barrier of fire placed around her by Óðhinn.³ This feat too was accomplished by the Óðhinnic hero Sigurdhr Fáfnir-bane. Spells intended to put people into a deep slumber from which they can be awakened only by the magical will of the sorcerer are common in the Icelandic books, but the signs used and given the name *svefnþorn* are numerous.

Besides these two well-attested signs there are many names given to signs, for example, *gapaldur* (see note on Spell 34), *vedhurgapi* (weather daredevil, to cause a storm), *kaupaloki* (deal closer, for good business), *Ginnir* (a name of Óðhinn), *Angurgapi* (reckless one of anger). But quite often the same name may be given to two or more different signs.

Despite the fact that it is obviously of southern origin, no discussion of magical figures in the medieval north would be complete without mentioning the so-called sator-square.⁴ This most often appears inscribed with Latin letters (see Figure 2). This formula has already been touched on in connection with the magic books of Jón the Learned. The formula was apparently well known, as magical instructions often call for reciting the sator-arepo. It is difficult to tell what exactly is meant by this. Was there a secret decoding (such as pastor Gudmundur suspected), or were the letters of magical syllables to be recited? Another interesting aspect of the sator-square in the north is the fact that not only is it mentioned in books of magic, but it is also found in at least seven runic inscriptions! One fragmentary example was recently found on the bottom of a bowl in Sweden,⁵ and it reads as shown in Figure 3 on page 50.

ʒ 1 1 1 R
 1 R t K 1
 1 t t t 1

or

s	a	t	o	r
a	r	æ	p	o
t	æ	n	æ	t

Figure 3: Inscription on the bottom of a bowl found in Sweden.

The bowl dates from the end of the 1300s, so it can be seen that the use of this formula is several hundred years older than our magical books would indicate.

CHAPTER SIX

Theory and Practice of Magic in the Galdrabók

Examples such as the sator-square point up the fact that there were definitely influences coming into the north from the southern traditions of magic. But to some extent these examples serve also to show the remarkable degree to which basic northern ideas of how magic works and how to work magic remained intact even under this superficial influence.

In this chapter I want to look at the underlying theories of magic as expressed in the Icelandic grimoires, at the powers by which it is thought to work, and at some of its consistent ritual techniques.

One of the ways we can see the northern component is by observing how these magical elements were dealt with in the north in contrast to the south.¹ The typical structure of Mediterranean magic involves five steps with five particular functions:

1. Preparation (specific to working)
2. Circle
3. Conjunction of spirit
4. Address to spirit
5. License to depart

The preparation typically involves two main aspects: (1) the procurement or arrangement of tools and substances particular to the operation and (2) the determination of an auspicious time for the operation. The latter usually involves technical knowledge of astrology. (By the way, Icelandic magic is almost free of astrological elements.) A circle—really a complex of magical diagrams drawn on the surface of the space of operation—is erected. This typically includes a circle in which the magician stands and a triangle outside that circle in which the spirit appears. The circle functions as a shield to protect the magician from the spirit, and the triangle serves to constrain the spirit. The entity is then called to appearance by a series of conjurations, which are a mixture of prayer formulas and commanding threats. Usually the spirit in question is threatened with the wrath of spirits above it in the hierarchies of heaven or hell. Once the spirit arrives, the magician addresses it, asking or commanding what he wills. Traditionally (and despite whatever revisionist theorists may say), the spirit does the work for the magician. The rite is concluded by a license to depart, which banishes the spirit away from the magician.

There are certain traits in this theoretical working model that remain foreign to the Icelandic magician. There rarely seems to be any preparation for the specific working. It would seem that the Icelandic magician constantly prepared himself in a general way and then applied his spells almost in a rough-and-ready fashion. This is very reminiscent of the way Egill Skallagrímsson worked. Further, the Icelandic magician never seems to need to protect himself from the powers he is calling on. (He appears more concerned with other humans.) Although spiritual entities are involved, it seems closer to the truth to say they help the magician work his will than work it for him. And since the magician has no need to protect himself from the entities he summons, he has no need to banish them.

Generally, medieval Icelandic magic seems to have worked through one of a combination of three media: (1) graphic signs, (2) spoken or written words, and (3) natural substances. Spell 46 in the *Galdrabók* shows a combination of all three elements, for example.

Graphic signs (including runes and other written characters) are thought to be conduits or doorways through which various powers or entities are directed to do the will of the magician. These signs are generally called *stafir* (staves). The actual physical sign seems to have little power on its own; it is only in combination with the will of a trained magician that any results can be expected. That is why, in the folktales concerning the famous *galdramenn*, such emphasis is placed on their scholarly characters and on the fact that the signs had to be learned by a process that involved more time and effort than just memorizing their external forms. Also, the fact that except for the most common signs (e.g., the *ægishjálmur* or *Thórshamar*) the shapes of the “staves” are rarely repeated, even when they might be called by the same name, indicates that it was an inner form, not an external shape, that was mainly being “learned.”

Words (spoken or written) are the medium often used to activate the signs, or words can work alone either to direct or command some power or entity or to beseech an entity to act on behalf of the magician. This latter prayer-type formula is usually found only in spells of a Christianized kind. In the medieval Icelandic formularies words and names can activate the corresponding power or entity in a way desired by the magician and as formulated in his verbal spell. The “power of the name” is a well-known phenomenon in the annals of magic.² We know that such a belief reaches back into the Germanic past. Its most famous depiction is in the lore surrounding Sigurdhr Fáfnir-bane: after fatally wounding the serpent Fáfnir, Sigurdhr attempts to conceal his name from the dying giant (etin) because, as we read

in the *Fáfnismál*, "it was the belief in olden times that the words of a doomed man had great might, if he cursed his foe by name."³ This ancient Germanic lore was, of course, further reinforced by the importation of Judeo-Gnostic names of God or words of power that are heaped up in some of the Christian-type spells (e.g., in the *Galdrabók* spells 1, 3, 12, and 21). In all cases these verbal elements are seen as being vitally linked to the actual things they name, and therefore willful and trained manipulation of such words and names constitutes a manipulation of the actual things or entities.

Certain substances were thought to have a predisposition for use in magical operations, the most typical being blood and woods of various kinds. Both are well represented in the heathen type of spell. The blood of the magician or that of an animal is used in spells 34, 45, 46, and 47. Four kinds of wood—oak, rowan, alder, and ash—are mentioned in six spells (9, 29, 32, 33, 36, and 47). In all but the last of these, staves of one kind or another are to be carved into the wood. Again, this is a direct continuation of runic magical practice. Herbs are also mentioned in several spells. The most useful are millefolium (yarrow) and *Friggjargras* (*orchis odoratissima* or *satyrium albidium*). Many other spells make use of various substances on which staves are to be carved. In each case there seems to be an underlying analogical reason for the use of the substance, which must be evaluated on a case-by-case basis.

In the spells of Icelandic magic the emphasis is laid heavily on the person of the magician. He is rarely said to have the explicit help of outside forces, and the rituals, such as they are, are quite simple procedures. This is again in sharp contrast with the hocus-pocus of the complex grimoires of the southern tradition.

Since there is such a heavy emphasis on the person of the magician, it is necessary to take a closer look at what makes up

the psychophysical complex of the individual human being. The ancient Germanic peoples had a complex and well-developed structure for these psychic aspects of the human being. We can know this to a fairly exact degree because they had such a well-developed set of technical terms for the psyche. In heathen times this body-soul structure could have been described as having (1) a physical body (ON *lík*), (2) a shape or semiphysical body image (ON *hamr*), (3) a faculty of inspiration (ON *ódhr*), (4) a vital breath (ON *önd*), (5) a volitive/cognitive/perceptive faculty (ON *hugr*), (6) a reflective faculty (ON *minni*), (7) a “shade” or after-death image (ON *sál* or, figuratively, *skuggi*, shadow), (8) a permanent magical soul, or fetch (ON *fylgja*), and (9) a dynamistic empowering substance that gives luck, protection, and the ability to shape-shift (ON *hamingja*).⁴

Unfortunately, with the coming of Christianity, the refined native psychology, or lore of the soul, was assailed and began to decay and become very confused. In our *Galdrabækur* we only have the bare remnants of a fragmented system. What is clear, however, is that the Icelandic magicians preserved some of the technical lore in the ways they believed magic worked. It seems fairly clear that even in the period in which those spells were being used the magicians realized (1) an animating or vital principle, (2) a personal image, and (3) a separable power entity by which “sendings” (Ice. *sendingar*) were sent, and (4) an essential core faculty of “heart and mind” (ON *hugr*).

For example, it is obvious that curse formulas are meant to deplete the vital energy of a person or animal, and protective formulas are meant to build up this faculty. Other formulas are intended to change the quality of the contents of the *hugur*—for example, to cause someone to fear or love the magician. The ability to see shades, or images, of other people, especially ones who have stolen something from the magician, is also frequently mentioned.

To conclude this discussion of the theory of magic implied in the spells of the *Galdrabók* and related texts, perhaps a careful analysis of one spell would bring things into sharper focus.

I refer to Spell 34 in the *Galdrabók*. This is a spell to get the love of a woman. It is an attempt to turn her free will genuinely toward the magician, but it is couched in the magical forms of threats and curses. A review of the magical procedures would include a complex set of actions. First, the woman's being is linked to the formula by means of location (placing of staves, etc., "in a place where she will go over it") and essence (writing her name with staves); then the magician's (sexual?) being is linked with the woman's being and with the magical formulas by means of the "etin-spear blood" (semen?); and finally, the magical signs that graphically embody the aim of the operation are inscribed and the whole contained in a ring of water. All of this has linked the woman, the magician, and the aim in an essential but as yet only general way. This symbolic and graphic series of actions and signs is then empowered and given a highly specific direction by the words of the spell spoken over the forms. This spell includes references to how the formula is to work within the psychological scheme as understood by the magician. It includes graphic imagery and a prayerlike entreaty to Óðinn for success. (Óðinn is, by the way, known in the ancient mythology for his interest in spells of this kind.) Just about all elements common in medieval Icelandic spells are to be found in this operation. And again, it should not be missed that the general procedure is quite the same as that practiced by the heathen runic magicians of the north.



PART
TWO

THE
GALDRABÓK

THE GALDRABÓK

1. A prayer for protection against all kinds of dangers

This prayer ought to be worn on oneself in all kinds of dangers that threaten from water, sea, and weapons. It should also be read just before one sees one's enemies: Iesus Christus Emanuel, pater et Domine. Deus meus Zebaoth, Adonaij, Unitas, Trinitas, Sapientja, Via, Vita, manus, Homo, usiono, Caritas et terus, Creator, Redemtor, Suos, Finis, unigienitus, Fons, Spes, jmas, et tu Ergomanus, Splendor, Lux, Grammaton, Flos, Mundus, imasio, paracletus, Columba, Corona, prophetas, Humilas, Fortissimus, Atanatos, Kÿrias, Kÿrios, Kÿrieelison.

Jamas, Lux, tua, Grammaton, Caput, Alpha et primo Genue, isus, Agnus, ovis, Vitulos, Serpens, Leo, Vermus, unus Spiritus Sanctus, Helio, Heloj, Lamasabactanj, Consumatum est jnclinate capite, Spiritus jesus vinset, jesus imperat, Redemtor Deus Abraham, Deus jsaac, Deus jacob. ✚

Uriel, Tobiel, Geraleel, Gabriel, Raphael, Michael, Cherubin, Cheraphin, Caspar, Fert miram, Meloiorus, Balthasar Aurum, et trjva nomi, qvis Super pontavit, Solvetur, Avisibet petate, Adam, Eva, jesus Nazarenus, Rex judiorum, jesus Christus Filj Dei; Miserere mej. ✚

Petrus, Andrias, jacobus, jahannes, Philippus, Bartolomeus Simon, judas, Matthias, Lucas, Paulus, Barnabas.

qvi me Defendit a Canibus, in manus Comentuum Spiritum meum, Redemisti meum Verita tue Amen.¹

2. *For protection against weariness and affliction*

The prayer written above must also be read if anyone is bored or sick in any way, and it will be stopped.

3. *Against trouble with childbearing²*

Read the three following words three times into the ear of a woman who cannot be made to part with her child in birth and say the Pater Noster three times in between; then things will get better: GALATH, MALGALATH, SARATHIM. After this follows three Pater Nosters in Latin:

Pater Noster qvi es in Celis, Santificetur nomen tuum, adveniat Regnum tuum, fiat voluntas tua, Sic ut in celo, et in terra panem nostrum qvotidianum, da nobis hodie, et Dimitte nobis, debita nostra, Sic ut et nos, Dimittimus, Debitoribus nostris, et ne nos inducas, in tentationem, Sed libera nos a malo Amen qvja tuum est Regnum, tua potenja et Gloria in Secula Secuorum Amen.

4. *To stanch blood³*

To stanch blood that is flowing from a man's body, read this verse three times, with a Pater Noster in between; but if you want to stanch blood on the head, then hold your thumbs against the eyes and say:

Sangvis maneat in te, Sic ut fecit Christus in se, Sangvis maneat in tua vena, Sicut fetit Christus in Sua pena, Sangvis maneat fixus, Sicut qvando Christus fuit Crussifixus. Pater Noster.

To stanch a nosebleed for someone, write these words on his forehead in his own nose blood: CONSUMMATUM EST.

5. *Against headache and insomnia*

Against headache and sleeplessness write this verse and leave it in his nightcap, or under his head in the evening without him

knowing it, and it will help him: MILANT VÁ VITALOTH JEOBÓA FEBAOOTH.⁴

6. *A spell against evil when some other incantations are a problem*

If you want to treat someone, but some incantations (*galldrar*) are upon him, then read this over him three times, and also let him read the following himself if you wish:

Vulnera Sub qvinis, te Subtrae Christe Ruins, Vulnera qvinque Dei, Sunt medisina tuj.

But if you let him read it himself, then also have him read the following (you should also read this if you are reading over yourself): VULNERA SUB QVINIS, ME SUBTRAE CHRISTE RUINIS, VULNERA QVINQVE DEI, SUNTT MEDISINA MEJ

7. *Against fainting or pestilence of livestock*

One has to clip or cut these helms of awe⁵ onto one's livestock if it is swooning or diseased; the first one should be put on the left shoulder and the other one on the right.

8. *To win a girl's love*

Likewise, you should, while fasting, make the second helm of awe with your saliva in your palm when you greet the girl whom you want to have; in such a case it should be in your right hand.



9. *To cause fear in an enemy*

If you want your foe to be afraid of you whenever he sees you, then carve these staves on an oak branch⁶ and wear it in the middle of your breast—and see to it that you see him before he sees you.

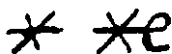
10. *To get one's wish fulfilled*

Read this verse three times forward and three times backward and you will get the outcome that you want.

Forward: Sprend manns Hoc, flijde tuui boll⁷

Backward: Boll tuui flijde, Hoc manns Sprend⁸

11. *Against the hate and poison of fiends and enemies*

Whoever carries the following sigil on himself will never be harmed by any of the Fiend's temptation, and his enemy will not be able to work any active hate against him. Nor will he be exposed to any poison in his food or drink, and he will never fall victim to any treacherous dealings.

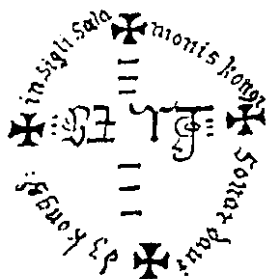

12. *Against distress at sea, dangerous weapons,
and sudden death*

Whoever carries this name on himself cannot be drowned in the sea, nor be struck by hostile weapons; nor will he die an unpleasant death, and neither come to harm:

Helon Heloui Helion

Saa bonaij lux tetram Gramatus⁹

13. *Against harm from an enemy*

If anyone carries these staves on himself, nothing can harm him all day, and his enemies will not have any power over him.¹⁰

 o : 2 : 10 : 0 : 0 : + : 6
 v : 0 : 9 : d : b : 0 : r : h : 6
 0 : 6 : 0 : x : 7 : 0 : 2 : h : d
 b : 8 : n : x :

14. *Against all kinds of suffering and danger*

The person, man or woman, who carries these staves on himself will be stricken with no torment. And no sword can harm him, nor any of his enemies, and no worm¹¹ will get into his food or drink.¹²

h : x : d : c : 0 : 2 : f : 2 : p :
 x : 0 : 0 : 6 : 6 : H : H : ✕

15. *To win the love of a person*

You should write this one and have it with you, and men will love you very much.¹³

h : q : g : o : z : z : 6
 þ :

16. *To cause fear in your enemies*

If you want your enemies to fear you, always carry this stave under your left arm.¹⁴

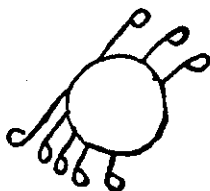
17. *To win the favor of powerful men*

You should write this and always have it with you, and powerful men will like you very much.

k : x : r : s : b : h : g : g : g :
 x : z : g : c : d

18. For protection against all kinds of evil

If you wish to elude something that is evil [illt], then carry these staves with you so that nothing can harm you, no sword and no torment; neither [will there be] any worm nor poison in your food or drink.¹⁵

卍 X : ϕ : ʒ : ʒ : ʒ : ʒ :
 K : ʒ : ʒ : ʒ : ʒ : ʒ : H : H :
 * : ʒ : ϕ : ʒ : ʒ : ʒ :
 ʒ : ϕ : ʒ :

19. To cause fear

Carry these following staves with you, and your enemies will fear you.¹⁶

ʒ h * ʒ h ϕ ʒ X
 ʒ 卍 卍

20. A washing verse

I WASH MYSELF in thy dew and dales¹⁷ in the brilliance of thy fire, my lord. I set thy blessed form between my eyes. I wash away all of my foes and their spells [formáli]. I wash away from myself the power and anger of mighty men. The world shall be kind to me, with friends and kind deeds. The earth [frón] shall be gracious to me in goods [fé] and acquisitions. Everything will

be successful that I need to do, to speak, to think. This I bid thee, lord, king of glory [*dyrdarkonungur*], so that everyone who sees me today will have to cast kind glances at me and will be delighted with me, as the blessed MAID MARION was with her blessed, lovely son when she found him by the river Jordan, and when she found him in the minster, and when she sought him as a mourner. Likewise, I bid thee, lord of lords and king of kings, that thou wilt turn away from me and remove all ruin and ill luck, all malice and all treachery on the part of others, who want to deceive me in words and through words, in deeds and through deeds, in incantations [*í golldrum*] and through incantations, or in whatever way they want to ruin me. Hear thou my prayer, my dear lord. I have faith in thee and I trust in all good things. Amen.¹⁸

21. *Byrnie*¹⁹-prayer

HEAR THOU ME, HOLY TRINITY, Father, Son, and holy ghost [*andi*], sole lord, Shaper of all things, ruling in glory with all the saints. Be thou a byrnie and a shield for my soul [*sál*], my life, and my body [*líkama*], inside as well as outside, for seeing and hearing, tasting, smelling, and feeling, for flesh and blood, veins and sinews, cartilage and bone, bowels and all of my body's movements and connections. Indeed, for thy name's sake, lord, may all my joints and limbs receive life and spirit, to move, and to be strengthened and become whole. Protect me, my lord, on the right and left sides, forward and backward, above and below,²⁰ from the inside and outside, when I bow down and when I rise up, in hard weather, in waters great and small, in the sea, in high waves, and in confusing darkness, when I am walking, standing, sitting, in sleep and while awake, in silence and while talking, and in all my body's workings. Protect me, my lord, days and nights; help me, almighty God in holy trinity—ADONAI AGIJOS OTHEOS AGIJOS YSKYROS AGIJOS ATHANA-

THOS ELEYSON YMAS ZEBAOOTH EMANUEL—save me, my lord, from deadly dangers that threaten from land, from the waters and sea, from all beasts and monsters of the ocean, birds and beasts that go on four feet, and all creeping beasts.

Protect me, my lord, from all evil, from fire and claps of thunder [*reidar thrumum*], from snow and hail, from rain and wind, from earthquakes and all kinds of movements in the earth, and from all dangerous phases of the moon, from magical poison [*af eitire folkinga*], from all glances of envious eyes, from evil words and works and dangerous situations, from worms, from all the devils of darkness and midday, and flying shots from them²¹ that daily are going out into the darkness of this world. Protect me, my lord, from all the hostility of the enemy, who wants to withhold from me all good things, here before death, and in death, and in the other world after death, thou lord god, who ever lives and rules in holy, perfect trinity, one god in all ages of ages. Amen.

22. Days that bring bad luck

These are the days that the old ones held to be unlucky; they seemed especially so for the Egyptians:²²

In January	the 1st and 7th
In February	the 3rd and 4th
In March	the 1st and 4th
In April	the 8th and 10th
In May	the 3rd and 7th
In June	the 10th and 15th
In July	the 10th and 13th
In August	the 1st and 2nd
In September	the 3rd and 10th
In October	the 3rd and 10th
In November	the 3rd and 5th
In December	the 7th and 10th

23. *To be able to count up playing cards, which are face down*²³

1 : 739 King : 6 : 5

4 : Knave : 8 :

Queen 10.2

24. *The 109th Psalm of David*²⁴

God do not be silent concerning my praise, for they have unlocked their ungodly mouths against me and speak against me with a false tongue.

And they speak venomously against me everywhere and strive against me without cause.

Because I love them, they are against me, but I pray. They repay me ill for good and hate for love.

Set a man who does not fear god over him, and the fiend²⁵ should stand at his right hand.

When his case comes to judgment, he will go out condemned and his prayer will become sin.²⁶

May his days be few and may another take his office.

May his children be fatherless and his housewife a widow.

May his children wander aimlessly and beg for alms and fare about like poor men who are ruined.

May the usurers suck out everything that he has, and may strangers grab all his wealth.

And may there be none who will show him any goodness and may there be none who will have pity on his fatherless children.

May his descendants be rooted out and may their name be wiped out in the next generation. May the misdeeds of his forefathers be remembered and put before the face of the lord, and the sins of the mother never be blotted out.

May the lord never forget them and the memory of them will be wiped away from the earth.

Because he was so merciless in every endeavor, and persecuted those poor and needy, he would send even those filled with grief to Hel [i. e., kill them].

And as he desired cursing, so let him have it, and as he did not desire blessing, therefore it will stay far away from him.

And as he clothed himself with cursing, just as with a garment, so it will run into his bowels like water and into his bones liken to butter.

May it be to him like a garment in which he is clothed, and liken to a belt with which he is girded all the time, as is fitting. May that happen to those who are my enemies and who speak maliciously against my soul.²⁷ But thou, lord, will be with me for thy name's sake because thy mercy is my consolation, deliver thou me, because I am poor and helpless—my heart is broken in two within me.

I go away from here as a shadow²⁸ as it fades away, and I am driven away as a swarm of locust.

My knees are weak from fasting and my flesh is lean and does not have any fat. And I must have become a disgrace for them; when they saw me, they shook their heads. Show me aid, my lord god, and help me according to thy mercy.

So that they may know that this is thy hand, and that thou, lord, acted thusly. They may curse, but thou wilt bless; if they should rise against me, then have them come to shame, but thy servant rejoice.

May my enemies be at the same time clothed in disgrace, and may they cover themselves with shame as with a kirtle. Greatly, I want to thank the lord with my mouth and to praise him among the crowd.

Because he will stand at the right hand of the poor man, so that he might deliver him from those who want to pass judgment on his life.²⁹

25. *A washing verse*

I wash myself in the dew and in thy day-bath,³⁰ and in the brightness of thy fire, my lord. I wash away all the power of my enemies, and the wrath of mighty men and of all those who have evil intentions toward me.³¹ May wrath run away and may strife be stemmed, so that they will greet me gladly and may they laughingly look into my eyes, and the greatest good deeds will be on my tongue.

May god behold me, and may good men, as well as every other man, behold me with eyes that bring nothing but blessings—it is the helm of awe³² that I bear between my brows—may the world and the land be gracious to me. May my enemies become as delighted with me as much as the child who takes milk from its mother's breast, and just as the Saint Maria was delighted with her son when she sought him for three days and found him in the minster among his teachers.³³

May their wrath run away and their strife be stemmed, may their breasts cool down and may the bottoms [of their hearts] be thawed before the might and craft of the mighty shaper—Jhesu Christi. May their wrath run away from me just as the sun runs down into the sea, may god release their wrath and hate from me as he released Susanna from her long disgrace and Daniel from the pit of fierce beasts, Moses from the power of the pagan people. Read this while you wash yourself and look three times into the bowl of your hands.³⁴

26. *For the wrath of mighty men*

I wash all of my enemies away, and the power and wrath of mighty men, so that they will greet me with good cheer and look upon me with laughing eyes. My eyes project love and I can settle disputes of life, I can settle cases concerning the mightiest of men. God will behold me, every man will gaze upon me with

eyes that bring good fortune—I bear the helm of awe between my brows—may the world and land be gracious as friends.

Read this three times down into the bowl of your hands while having water in your hands, and also read a Pater Noster each time.

27. *To play a joke on someone, so that he cannot hold his food down the whole day long*

Carve these staves into cheese or fish and have whoever you want to make fun of eat it, and whatever he eats that day will be of no use to him.³⁵

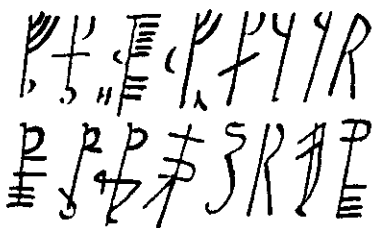

28. *An antidote for the previous enchantment*

If he does not get any better by himself, then give him warm milk, with bleached and dried albumin scraped off into it; this can also be done against cholera and it won't go wrong.

29. *To hinder a person from coming to your house*

If you don't want a man to come to your dwelling, then carve this stave into rowan wood³⁶ when the sun is in her highest stead, and go three times with the sun [*riett sælis*] and three times widdershins [*ranga-sælis*] around your farm and hold onto the wand of rowan wood onto which the stave has been carved, and

onto some sharp thorn grass [thistle]³⁷ and then lay both of them together up over your door.

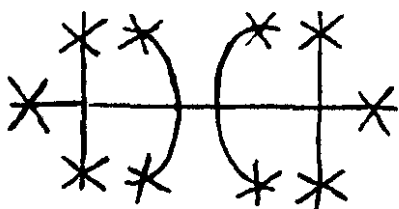

30. To kill another's animal

One should inscribe these staves onto a leaf and cast it into the footprint of another's horse; then the animal will die, if he has offended you without cause. Conceal the stave in the horse's hoofprint.

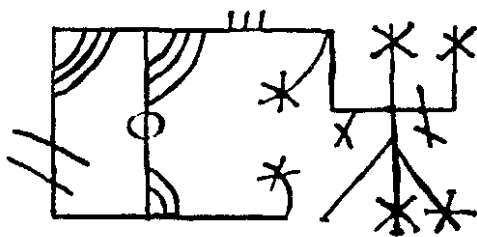

31. Against troll-shot³⁸

If any kind of shot flies toward you, then read this verse right away: BUMEN SITTIMUS CALECTIMUS ME TASUS ELI ELOI SIEBAHOT ELEM VE A O NAJ

32. To put someone to sleep

If you want to put someone to sleep, then carve these staves in alder wood³⁹ and lay it under his head, and he will surely sleep until you take it away.

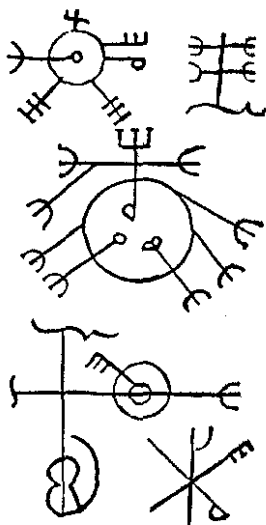

33. To find out a thief

In case of theft you should carve these staves on the bottom of a dish of ash wood, put water in it, and strew *millefolium*⁴⁰ into the water [and say]: “This I ask according to the nature of the herb and great might of the staves, that the shade [*skuggi*]⁴¹ of the one who has taken it appear in the water, and that the name of this person be carved on a fish gill with etin’s bewilderments [*iotun villum*],⁴² and carry these on yourself [and say]: Ódhinn, Loki, Frö, Baldur, Njördhr, Týr, Birgur, Hôênir, Freyja, Gefjon, Gusta, and all those gods and goddesses who dwell and have

dwelt in Valhöll from the beginnings of heaven, they must help me so that I will have success in this matter.

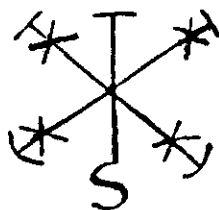

34. To bewitch a woman and win her love

If you want to bewitch a woman so she will come to no one except you, make a hole in the floor in a place where she will go over it, and pour in some etin-spear blood [*iotun geira blod*]⁴³ and draw a ring of water around it, as well as her name and these staves: and threefold diving⁴⁴ *Moldthurs*⁴⁵ and *Madhr*-runes, *bladh*, *naudh*, *komla*, and *gapalldur*⁴⁶ and then read this conjuration:⁴⁷

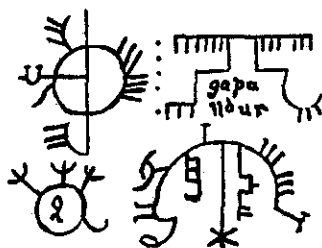

I look upon thee and thou givest me the lust and love of all thy heart [*hugur*]. Thou canst nowhere sit, thou canst be nowhere at home, unless thou lovest me. This I bid of Óðinn and of all those who can read⁴⁸ “women-runes”:⁴⁹ that thou wilt nowhere in the world be at home nor thrive, unless thou lovest me with all thy heart. This shalt thou feel in thy bones as if

thou burnest all over, and in thy flesh half as badly. Thou wilt meet with ruin unless thou lovest me—thou shalt freeze on thy feet and thou wilt never meet with honor or happiness. Sittest thou as if burning, with thy hair rotting out; rent are thy clothes—unless thou wilt have me of thine own free will.

35. To find out a thief

Carve these on a man's leg bone and then he will come and spit out whosoever stole from you:

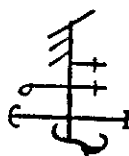
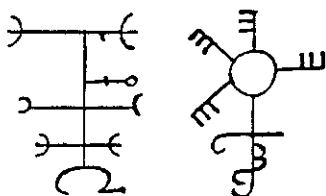

36. To find a thief

Carve these on an oak twig⁵⁰ and lay it under the turf over a grave and let it lie there:

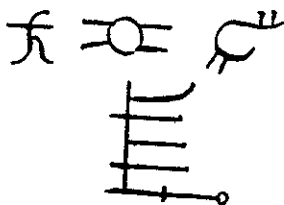

37. *A way to get satisfaction in a legal case*

If you want to have fulfillment in a legal case, read this verse three times forward and three times backward: VIENIAT MICHIMY SERACIONIS TVE VIVAM QUIA LEX TUA MEDITASIO MEA EST⁵¹

Backward: EST MEA TASIO MEDI TUA LEX QUIA VIVAM TUE MISERACIONIS MICHIMY VIENIAT.

38. *For the protection of your horse*

Read this verse over your horse when you come to unsafe places; then no harm will come to it: COGNOVI DOMINE CUIA ECUITAS JUDIJSIA TUA ET IN VIRI TATES TUE HUMILHASTE MIE.⁵²

39. *Against troll-shot*

If any kind of shot comes flying toward you, read this verse at once: BUMEN SITTIMUS CALECTIMUS ME TASUS ELI ELOE SIEBAHAT ELEM VE A O NAJ.⁵³

40. *To find out a thief*

Against theft take Frigg's grass⁵⁴ and lay it in water so that it might lie there for three nights at a stretch; then go back there and you will be able to see the one who stole from you.



41. *Against wrath*

To still all kinds of wrath make this stave on your forehead with your left index finger, and say: It is the helm of awe that I bear between my eyes—wrath runs away, strife is stemmed. May every mother be delighted with me as Maria was delighted with her blessed son when she found him on the rock of victory,⁵⁵ in the name of the Father and the Son, and the Holy Spirit:



And read:

Ølvir, Ódhinn, Evil One⁵⁶
 All will you bewitch!
 May God himself, with skill
 Send love between us two!⁵⁷

42. *Against hate*

If anyone harbors hate against you, sign yourself⁵⁸ at once with these words:

Trepa †. tetra †:
 Grammaton +:
 Alpha + Et +: O +
 Ageos +: agios +
 otheos +: adonaij

43. *To make a woman keep quiet*

If you do not want [a woman] to tell about what you did [with her?], then take this stave, Homa,⁵⁹ and put it in her drink, and

then she will not be able to come out with anything. And you should have this stave next to your breast.



And say: Help in this all ye gods: Thórr, Ódhinn, Frigg, Freia, Satan, Beelzebub, and all those gods and goddesses that dwell in Valhöll.

In thy mightiest name, Ódhinn!

44. *To find out a thief*

If you want to learn, through magical knowledge, who stole from you, then take a little thorn bush⁶⁰ and wear it so that you are never separated from it. Then take a little copper pin, together with a copper hammer. Then make the following stave on the cross-beam of the house from which the thing was stolen; then stick the pin in the right eye,⁶¹ and say at the same time: IN BUSKAN LUCANUS

the stave



And say: FORTUM ATUM EST.

Write this stave on the cross-beam with chalk, and the hammer shall be cast by the shaft when the sun is the strongest,⁶² and that [should] be [made of] material which has never been used, unstamped copper or brass.⁶³

45. Another way to uncover a thief

If anyone wants another way to learn who stole from him, then he should make this stave on the bottom of a bowl with a wooden-handled knife. Make the blood flow from under your big toe and from your right hand, and drip the blood around the stave. Then take pure water, with *millefolium*, which is spread out on it. The water should be taken midsummer night after midnight, and should be taken with gloves, so that none of it gets on the hands. The wort should be smeared with blood, as well as these three staves:

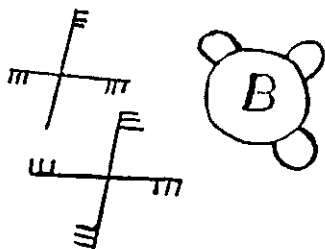

And then ask on account of the gloriously great, might of the herb and the never-ending working of its power, that the gods will send as a help, Rafael, their mightiest servant, and he will show himself here in they mightiest name, Thórr, Frigg, Beelzebub, Ódhinn.

Read three Our Fathers afterward.

46. Fart runes

Write these staves on white calfskin with your own blood; take the blood from your thigh and say: I write you eight áss-runes,

nine *naudh*-runes, thirteen *thurs*-runes⁶⁴—that will plague thy belly with bad shit and gas, and all of these will plague thy belly with great farting. May it loosen thee from thy place and burst thy guts; may thy farting never stop, neither day or night; thou wilt be as weak as the fiend Loki, who was bound by all the gods: in thy mightiest name Lord, God, Spirit,⁶⁵ Shaper, Ódhinn, Thórr, Saviour, Frey, Freyja, Oper, Satan, Beelzebub, helpers, mighty god, warding with the companions of Oteos, Mors, Notke, Vitales.

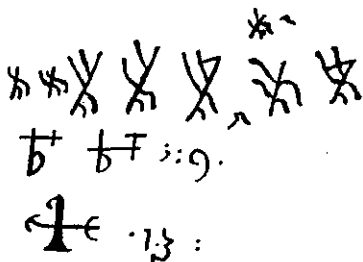

47. How one can get the helm of hiding

If you want to make a helm of hiding,⁶⁶ then get a hen's egg, and pour blood from under your big toe on your left foot onto it. Then the egg goes back under the bird, and let it sit upon it. Afterward, take the chick and burn it on oak-wood. Then put the burned chick in a linen sack and wear it on your head.



APPENDICES

*RELATED
SPELLS IN
GERMANIC
MAGIC*

APPENDIX A

Other Icelandic Sources

From the Huld Manuscript

The Huld Manuscript was collected by Geir Vigfusson of Akureyri, who died in 1880. The material contained in these spells is, however, much older, as can be seen when compared to the contents of the *Galdrabók*. As presented here, each of the *galdrastafir* or *galdramyndir* is named, and the instructions for making it are given, occasionally along with its effects.

1. *Galdrahöll* (hall of magical incantations):

Carve on the skin of the water-rail. (Runes read Araton Helga Adona, etc.)

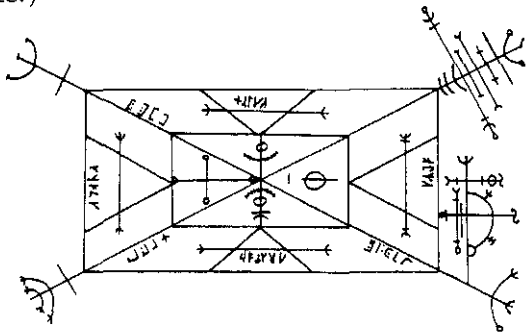

2. A *galdratöluskip* (ship of magical numbers):

To ruin ships. (Signs named *Ginnir* and *Gapi*, cf. *Angurgapi*.)

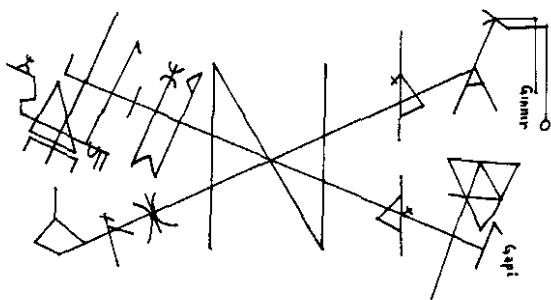
3. *Kaupaloki* (deal-closer?):

Cut this sign on a stave of beechwood and wear it in the middle of your breast when you want to have success [victory] at buying and selling.

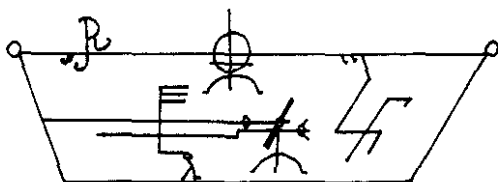
4. Another *kaupaloki*:

Cut on a piece of beechwood and you will have success.

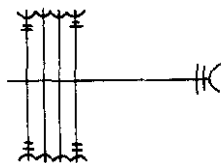

5. *Brýnslustafir* (whet sign):

Carve the upper sign on your whetstone, the other one below then lay a bit of grass over it; then whet under the sun and don't look at the edge.

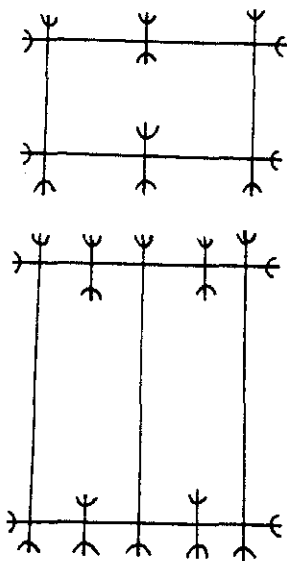
6. *Draumstafir* (dream stave):

Carve this sign on fir wood and sleep upon it; then you will dream what you want.

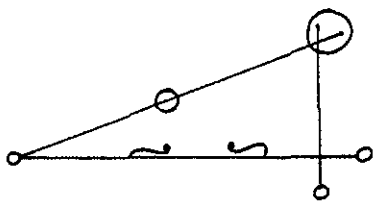

7. *Draumstafur*:

Carve this sign on so-called man-killing oak (*manndrepsaik*) and lay it under the head of the one who should, according to your will, receive dreams, without him knowing it.

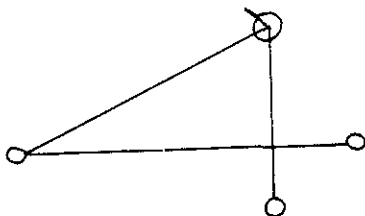
8. *Draumstafur*:

Carve this sign on St. John's Night on silver or on white leather, and if anyone sleeps on it, he will dream what he wants when the sun is at the deepest.

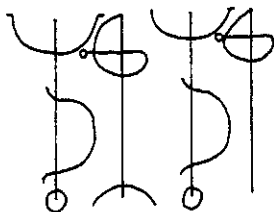
9. *Svefnthorn* (sleep thorn):

This sign would be carved on oak and laid under the head of the one who is supposed to sleep so that he can not awaken until it is taken away.

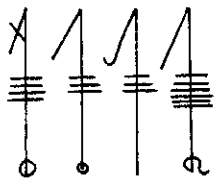

13. *Vegvisir* (signpost):

If this sign is carried, one will never lose one's way in storms or bad weather, even when the way is not known.

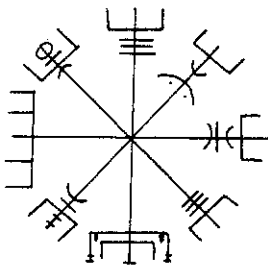
14. *Herzlustafir* (strengthening staves):

Wear this on your left breast to strengthen your courage.

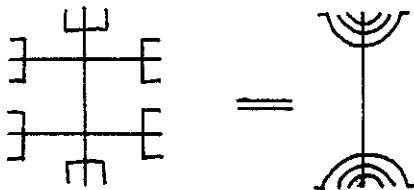
15. *Óttastafur* (terror staff):

Carve these signs on a small oak plate and throw it at the feet of your foe to frighten him.⁶⁷



16. *Dreþrún* (killing rune):

If you want your foe to lose his livestock and possessions, then lay this sign in the hoofprint of his horse.⁶⁸

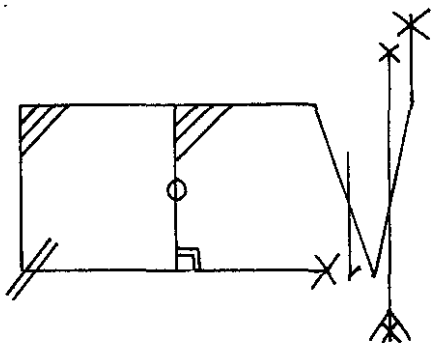
17. *Feingur* (catch or booty?):⁶⁹

If you want a girl to become pregnant by you, cut this sign in a piece of cheese and give it to her to eat.

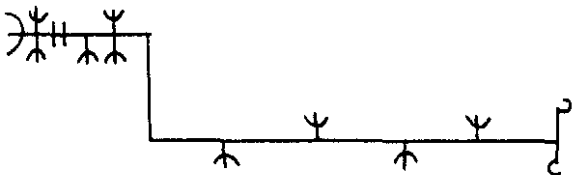
18. *Lásabrjótur* (lock breaker):

Lay this sign on the lock and blow into it. [The runes read *Tröll öll taki í mellu, taki í djöfu[ll] so braki*, which translates: All

trolls reach into the lock, the Devil reach into it, so that it will break.]

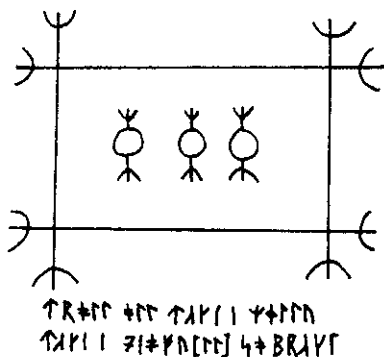

19. *Thórshamar*:

This sign is used by magicians to call out thieves and other witcheries.⁷⁰

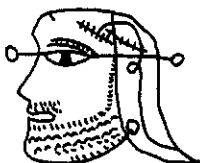

20. *Thjófastafur* (thief's stave):

Put this sign under the threshold of your enemy and he will collapse when he steps over it if he has committed an act of thievery against you.

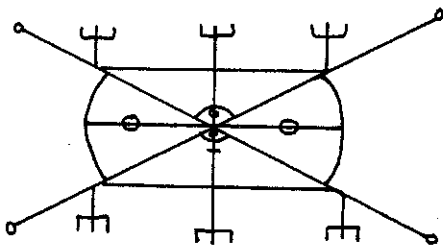

21. *Thjófastafur*:

If you want someone to steal, then carve this sign on the bottom of the [wooden] plate that he eats from.

22. *Thjófastafir*:

To see a thief, carve these signs in so-called man-killing oak and have it under your arm.⁷¹

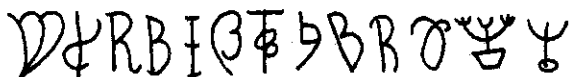
23. *Thjófastafir*:

Carve these signs in maple [*valbjörk*] wood and lay them under your head, and you will see the thief in your sleep.⁷²

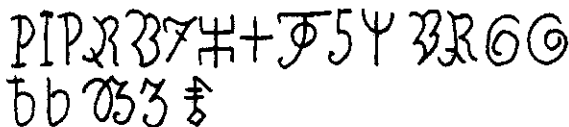

24. *Thjófastafur*:

This sign is to be carved at the full moon at high tide on the inside and outside of the bottom of a washbasin.⁷³

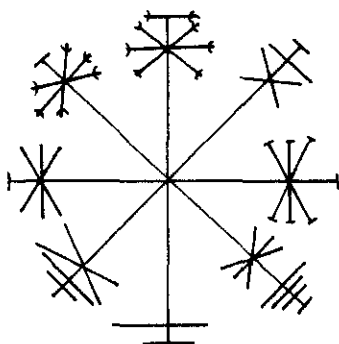

From the Kreddur Manuscript

This manuscript, found in Eyjafjödður, was written or copied in the late nineteenth century, but linguistic evidence shows it to be copied from a seventeenth-century original.

1. *Have this sign on gray paper under your left arm when you are talking to somebody.*

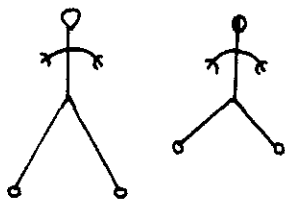

2. To have victory in business with all people:

Draw this sign on blotting paper and wear it under your left arm and let no one know that you have it.

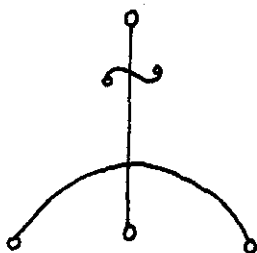

3. When you carry these staves with you, you will surely overcome your foes.

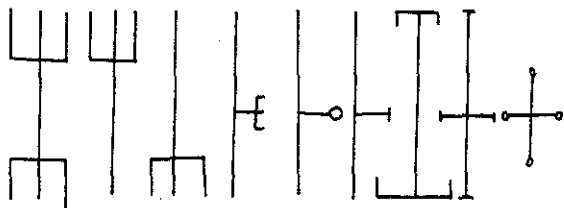

4. *Dúnfaxi*:

If you want to win a law case, carry this sign with you if you believe in it. It is called *dun faxi* [the manuscript is defective here] before you go to where the trial is to be held. It should be on a piece of new oak.

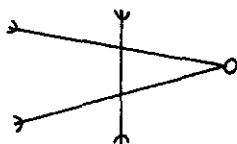

5. *So that you will not die in the water:*

Wear this sign under your left arm.



6. *Against sleeplessness and bad dreams:*

Carve this sign with a magnetized iron on a piece of coal.

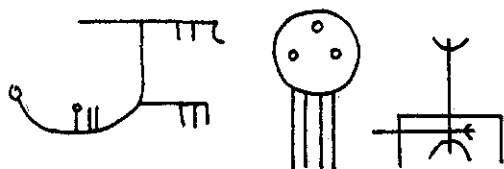

7. *For the bite [of a fox]:*

Carve these signs on oak and put them over the house doo

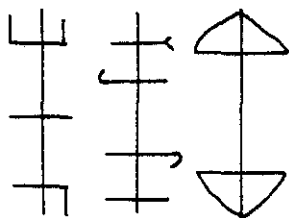

8. Carry this sign with you; it protects from all sorcery.⁷⁴

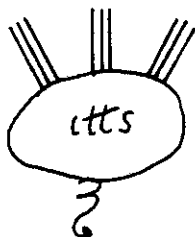

9. Have this sign in your right hand against all fear of witchery.

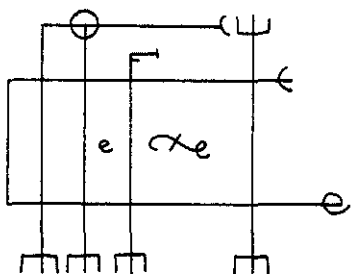

10. Have this sign in calfskin in front of your breast if you want to send back to him that which he has sent to you [i. e., any harmful sending].

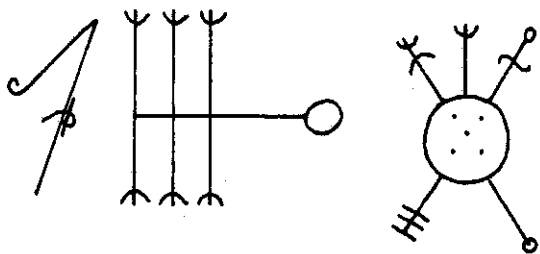

11. So that you won't get any shame, whatever comes up against you, make this sign with the ring finger of your right hand with spittle on your forehead.

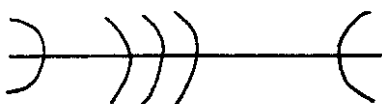

12. Against foreboding when you go into the darkness:

Carve this sign on the rice-oak [Ice. *hríseik?*] and wear it under your left arm.

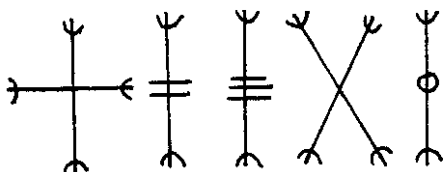

13. To put someone in a bad mood:

Carve this sign on lead and stick it in the person's clothes at the small of the back.

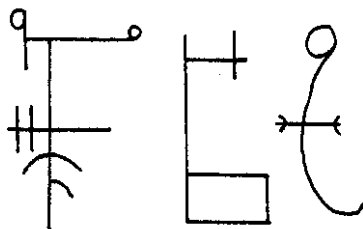

14. *To discover a thief:*

Cut one of these signs on a bronze plate and have under it the hair of a black uncastrated tomcat and have it under your head on the three nights of the old moon until the thief appears to you in a dream.

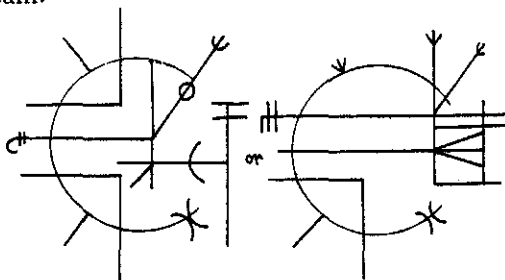

15. *To discover a thief:*

Draw blood from above the nail of your left middle finger and therewith draw this sign on paper. Have a cat hair behind it. Stick it under your cap and sleep with it by the old moon until you dream of him. Tried out.

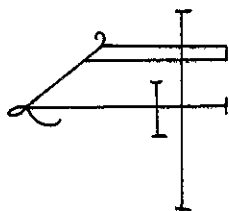

16. *If you want to get a good and true friend:*

Have two silver rings made and leave them lying for nine nights in the nest of a water wagtail or a sparrow [*titlingur: anthus pratensis* or *plectrophanes nivalis*]. Then take one ring and wear it and give the other one to your friend and say in jest to him that this is your ring of friendship and that you wish that it never part from

him. Take care, however, that he does not find out about this procedure with the rings. One must work in a similar way to get the love of a good woman.

17. *To discover a thief:*

Take *friggjargras* [an orchid, *habonaria hyperborea*], let it lie for three nights in water, and lay it under your head when you are sleeping; then you will see him.

18. *To make a helm of hiding [Ice. hulinshjálmur]:*

Get a completely black dog that has not one white hair; kill it and take out its heart. Take a piece of spruce wood and split it at the end and stick the heart in the split and bury it in the earth where the field and unfertilized land come together, and let it lie there for the nine nights before St. John's Day. There will have been created a stone there in that place. Carry it with you.

19. *So that a woman will love a man very much:*

Give her finely chopped dove heart in her food or in her drink. Or have the tongue of a water wagtail under the root of your tongue, and the one whom you kiss first will love you above all others. Or take two gold or silver rings and lay them in the nest of a water wagtail or a sparrow [Ice. *titlingur*] so that they are there for nine nights. Take them out again and give her one of them and keep the other one yourself. Then she will love you.

20. *If someone wishes to still the anger of his foe:*

He should go to some water and before a raven flies over it he should hold his hands in the water and make the following rune

on his forehead with the fourth finger of the right hand and afterward not wash himself off:

Y R ≠ 666 1 1 Y P φ K M K K I

From Svend Grundtvig's Collection

This collection was made in the middle of the nineteenth century. It is now in the Royal Collection in Copenhagen. There are four recorded signs from this collection, all very complex and of an obviously late date. Here we give one example:

Astros: The protective sign that comes now is called *Astros*. It protects from all runes and carvings of all sorts that can be used According to Snorri.⁷⁵

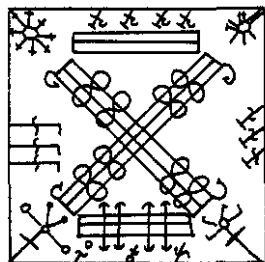

From the Collection of Jón Árnason

Árnason published a great collection of Icelandic folktales in the nineteenth century that contained many bits and pieces

of magical lore. The following are three of the most interesting:

1. *The use of two magical signs named gapaldur and ginfaxi can be used in glímagaldur (wrestling magic).*

The *gapaldur* is placed under the heel of the right foot and the *ginfaxi* is placed under the toe of the left. Then a verse is to be spoken, for which four variants are given. They all begin

Gapaldur under my heel

ginfaxi under my toe,

and conclude:

stand by me, fiend

now lying upon me! [i.e., possessing me]

or

stand by me, my ogre! [Ice. *skratti*]

or

strengthen me now, Adversary! [Ice. *andskoti*]

or

Devil, support me!⁷⁶

2. *There is a simple helm of awe working:*

Make a helm of awe in lead, press the lead sign between the eyebrows, and speak the formula:

Aegishjálrm er ég ber

I bear the helm of awe

milli brúna mér!

between my brows!

Thus a man could meet his enemies and be sure of victory.

3. *A washing stave:*

Fjón thvær ég af mér

fjanda minna,

rann og reidhi

ríkra manna!

I wash the hate from me

of my foes,

and the robbery and wrath

of rich [powerful] men!

One other interesting and detailed set of instructions for using the Thórr's hammer is given by Árnason and has been translated by Jacqueline Simpson.⁷⁷

*From Various Manuscripts Collected by
Ólafur Davíðsson*

A few other manuscripts were used in Davíðsson's collection published in 1903. Three involve magical signs, and four are *kreddur* instructions.

1. *Brýnslustafir* (whet sign):

Carve on a whetstone with steel.

n	k	g	p	s
k	s	c	z	p
g	c	m	c	s
p	z	c	s	k
k	p	s	k	n

2. *Sáttgjafar* (reconciler):

If someone else hates you, write these signs on parchment and put them under his head without his knowing it.

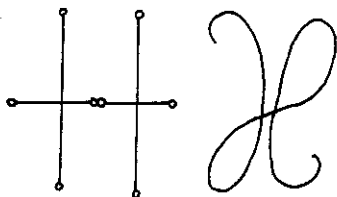

3. *Varnastafur Vladimars* (Waldemar's protective stave):

It increases popularity and luck for everyone who can work it. It came here from Germany and is therefore the best of these ancient signs. It should not be carved or written on anything except when someone is being tormented by something evil, and then it should be written with fish guts on the skin of a hen's egg and put in the headdress of the person.

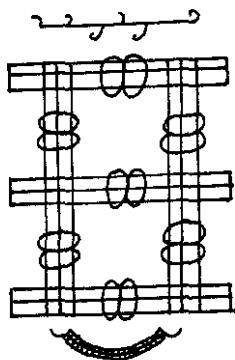

4. For "ghost spots" (Ice. *draugablettir*):

If a ghost that has been sent to attack someone⁷⁶ is successful in touching him, then its fingers will leave behind black spots. They will become sores that will eat away at the person and eventually kill him if nothing is done to stop them. The means to use against this is explained here: One should draw around the spots with an *edhalstál* or *segulstál* [i.e., a steel magnet] and sing the Pater Noster three times; then they will not spread out any farther. Then one should go to lukewarm water prepared for washing and hold the spots in it. Then hack three, six, or nine wounds in it and pour the lukewarm water over it. If all this is done right, it will be enough.

5. *To bring forth deceptions of the eye⁷⁹
and to know how to do them:*

Take eagle claws, sparrow claws, raven claws, falcon claw, dog paw, cat paw, mouse paw, and fox paw. Take the claws and paws of all these animals and boil them in water that [was drawn from a stream that] flows to the east. Then take the substance and put it in an unused linen bag and drink the extract. Then hold the bag over your head and command what kind of deception of the eyes you have thought up for him.

6. *Sleep thorn:*

Take the heart sac [pericardium] of a dog; pour pickling broth into it. Then dry it for thirteen days long, in a place where the sun does not shine on it, and when the one to whom you wish to do this is asleep, hang this in the house over him completely without his knowing it.

7. *Take the needle with which one has sewn
a dead man into his shroud:*

Stick it from underneath into the table at which the people eat and, if they know nothing of your actions, they will not be able to get their food down—even if it has been very well prepared—until the needle is taken away.

APPENDIX B

Heathen Magic in Old English Manuscripts

An excellent collection of magical spells from many Old English manuscripts has been provided by G. Storms in his *Anglo-Saxon Magic*.⁸⁰ The two main manuscripts that contain magical charms are the so-called *Leechbook* (MS Regius 12 D XVII, from the mid-tenth century) and the *Lacnunga* (MS Harley 585, from the eleventh century). Both of these texts are primarily filled with medical charms, and much of what they contain is directly translated from Greek or Latin source works. The *Lacnunga*, especially, contains a good deal of basically Germanic magical practice.

There are some twenty or so other manuscripts in which Old English magical spells have been found. Because of the vast foreign influence present in these manuscripts, explicit reference to the Germanic heathen pantheon is rare. Here we present as an example of Old English magical procedure what is perhaps the most interesting spell from a comparative point of view—the Nine Wort Spell⁸¹ for snakebite from the *Lacnunga*:

*Remember thou, mugwort, what thou madest known,
what thou hast adorned at the "Great Proclamation" [Regen-
melde]*

Una thou wast hight—oldest of worts,
 thou hast might against three and against thirty,
 thou hast might against venom and flying shots,
 thou hast might 'gainst the loathsome one that fares through the
 land.

And thou, waybread, mother of worts,
 open from the east, mighty inside.
 Over thee creaked carts, over thee rode queens,
 over thee brides sobbed, over thee bulls snorted.
 All thou withstoodest and hast rushed against them.
 Thus mayest thou withstand venom and flying shots,
 and the loathsome one that fares through the land.

“Stune” hight this wort, it waxed on stone,
 it stands up against poison, it strikes against pain.
 “Steady” it is hight, it strikes against venom,
 it drives out the hostile one, it hurls out venom.
 This is the wort, that fought with the worm,
 it has might against venom, and against flying shots,
 it is mighty against the loathsome one that fares through the land.

Make fly now, thou, venom-hater, the greater venoms,
 thou the greater conquer the lesser venoms so that he is cured of
 both.

Remember thou, mayweed, what thou madest known,
 what thou sought at Alorford,
 so that never a man should lose his life,
 after mayweed was made ready for his meat.
 This is that wort hight “wergulu.”
 It was sent by a seal across the sea-ridge,
 a vexing to venom, a boon to others.

It stands against pain and strikes against poison,
 it has might against three and thirty,
 against the hand of the fiend and against great fear
 against the witching of mean wights.

There the apple did it against venom,
 so that [the loathsome serpent] would not live in the house.

Chervil and fennel, two very mighty worts
 were wrought by the wise Lord,
 holy in heaven as he did hang;
 he set and sent them to the seven worlds
 to the wretched and rich, as a help to all.

These nine are mighty against nine venoms.
 A worm came slithering, but nothing he slayed.
 For Woden took up nine wonderous twigs,
 he struck the adder so that it flew into nine pieces.
 Now these nine worts have might against nine wonder-wights.
 against nine venoms and against nine flying shots
 against the red venom, against the wretched venom
 against the white venom, against the purple venom,
 against the yellow venom, against the green venom,
 against the black venom, against the blue venom,
 against the brown venom, against the crimson venom,
 against worm-blister, against water-blister,
 against thorn-blister, against thistle-blister,
 against ice-blister, against venom-blister.
 If any venom comes flying from the east,
 or any from the north, or any from the south,
 or any from the west over the people.

Krist stood over all sicknesses.

*I alone wot a running stream
and the nine adders beware!
May all weeds spring up by their roots,
the seas slip apart, all salt water,
when I blow this venom from you.*

Mugwort, waybread, open from the east, lamb's cress, venom-loather, mayweed, nettle, crab-apple, chervil, and fennel,⁸² old soap; work the worts to a powder, mix them with soap and the juice of an apple. Then work up a paste of water and ashes, take fennel and boil it with the paste and wash it with a beaten egg when you put on the salve, both before and after.

Sing this spell three times over each of the worts [herbs] before you prepare them, and on the apple as well. And sing the spell into the mouth and into both ears, and on the wound before you put on the salve.

APPENDIX C

Heathen Magic in Old High German Spells

There is no ancient German collection of spells as there is for England or Iceland. However, what are perhaps the most ancient formulas of all surviving Indo-European formulas are preserved in two Old High German spells—the Second Merseburg Charm from the early tenth century and the *Contra Vermes* spell from about the same time.

Correspondences between these charms and two Vedic formulas from India, which are perhaps as much as a millennium older than the Old High German manuscripts, were first noticed by A. Kuhn in 1864.⁸³ Another remarkable historical aspect of the Second Merseburg Charm is the absolutely transparent way in which it was Christianized by merely substituting figures from Christian mythology for the original Germanic ones. The fact that these Christianized versions appear outside the German region also points to the probability of lost heathen versions throughout the Germanic world. The overall historical pattern demonstrated by this formula also strongly suggests that many, if not most, of the “Christian” charms first written down in later centuries actually go back to now lost heathen originals. The First Merseburg Charm shows close affinities to magical stanzas

in the *Poetic Edda*—for example, in the “*Hávamál*,” stanza 149 and in the “*Grógaldr*,” stanza 10, where magic to break fetters is mentioned.

Contra Vermes

*Go out, worm, with nine wormlings,
out of the marrow into the bone, from that bone into the flesh
out from the flesh into the skin, out from that skin into this
arrow.*⁸⁴

Lord, so will it be!

The Vedic correspondence is from the *Rig-Veda*, X, 163, which catalogs the various parts of the body from which the disease is removed in a very similar way.⁸⁵

The Merseburg Charms

I

*Once there were sitting lofty ladies⁸⁶
sitting here and there
some bound bonds,
some hemmed the warrior bands,
some picked
at the fetters,
so the hasp-bonds break,
and the warriors escape.*

II

*Phol⁸⁷ and Wodan
were riding in the wood
when the lord's [or Baldr's] foal*

sprained its foot.
 Then Sinthgunt enchanted,
 and her sister Sunna;
 then Frigga enchanted,
 and her sister Volla;
 then enchanted Woden,
 as he could so well:
 for bone-sprain
 as well as joint-sprain;
 bone to bone,
 blood to blood,
 limb to limb,
 so that they are linked again!

The Vedic passage corresponding to this is found in the *Atharva Veda* IV, 12, from about 500 B.C.E. which can in part be translated: "Let thy marrow come together with marrow, and thy joint together with joint; together let what of thy flesh has fallen apart together let thy bone grow over."⁸⁸

But the formula also survived in a variety of forms throughout the Germanic world. In these Jesus replaces Woden, perhaps Voll or Balder is replaced by saints, and so on. One of the most recent recordings of this ancient formula is from 1842 in Scotland:

*The Lord rade,
 and the foal slade;
 he lighted,
 and he righted,
 set joint to joint,
 bone to bone,
 and sinew to sinew.
 Heal in the Holy Ghost's name!*⁸⁹

Introduction

1. Edition by Nat. Lindqvist, *En isländsk Svartkonstbok från 1500-talet* (Uppsala: Appelberg, 1921).
2. Icelandic folktales were collected and published by Jón Árnason, *Íslenzkar Thjóðhsögur og Æfintýri*, 2d ed., 6 vols., ed. A. Bóðhvarsson and B. Viljálmsson (Reykjavík: Thjóðhsaga Prentsmidhjan Hólar, 1954–1961). Árnason's edition was first published in 1863–1864. Convenient translations of some of these tales are provided by Jacqueline Simpson in two books, *Icelandic Folktales and Legends* (Berkeley: University of California Press, 1972) and *Legends of Icelandic Magicians* (Cambridge: Brewer, 1975).

Chapter 1

1. For a survey of the legal system in Iceland, see Gwyn Jones, *A History of the Vikings* (London: Oxford University Press, 1973), p. 282ff.
2. The best survey of Northern religion and mythology avail-

able in English is that of E. O. G. Turville-Petre, *Myth and Religion of the North* (New York: Holt, Rinehart and Winston, 1964). However, the most comprehensive is that of Jan de Vries, *Altgermanische Religionsgeschichte*, 2d ed., 2 vols. (Berlin: de Gruyter, 1956–1957).

3. Probably the most convenient history of Iceland is that of Knut Gjerset, *History of Iceland* (New York: Macmillan, 1924).
4. An excellent history of Icelandic literature is given by Stefán Einarsson, *A History of Icelandic Literature* (New York: Johns Hopkins Press, 1957).

Chapter 2

1. See Einarsson, *A History of Icelandic Literature*, p. 122ff.
2. Several surveys of magic in the Icelandic sagas exist, but unfortunately, none is in English. Perhaps the best recent treatment in English is that of H. R. Ellis Davidson, "Hostile Magic in the Icelandic Sagas," in *The Witch Figure*, ed. V. Newell (London: Routledge and Kegan Paul, 1973), pp. 20–41.
3. This term is virtually universally used in the Germanic dialects for "magic," for example, in Old English *gealdor* and in Old High German *galstar*.
4. This is the sound a raven is said to make.
5. No clear etymology of *seidh(r)* has been developed, and it may indeed be a borrowing from some foreign terminology.
6. *Seidhr* has been compared to shamanism by Dag Strömbäck, *Sejd* (Stockholm: Geber, 1935).
7. Snorri Struluson, *Heimskringla*, trans. Lee M. Hollander (Austin: University of Texas Press), pp. 8, 11.
8. The only comprehensive study of academic runology in En-

glish is that of Ralph Elliott, *Runes: An Introduction* (Manchester: Manchester University Press, 1959). A more imaginative approach is that of Edred Thorsson, *Runelore* (York Beach, ME: Samuel Weiser, 1987). Records of runes being used in the nineteenth century are found in Wolfgang Krause's work, *Runen* (Berlin: de Gruyter, 1970), pp. 122–123.

9. A complete, if old, edition and translation of the major rune poems is provided by Bruce Dickens, *Runic and Heroic Poems of the Old Teutonic Peoples* (Cambridge: Cambridge University Press, 1915); see also Thorsson, *Runelore*, pp. 93–104.
10. For convenient interpretations of the god Óðhinn, see Turville-Petre, *Myth and Religion of the North*, pp. 35–74, and Georges Dumézil, *Gods of the Ancient Northmen*, ed. Einar Haugen (Berkeley: University of California Press, 1973), pp. 27–42. For a more imaginative look, see Thorsson, *Runelore*, pp. 178–182, 189–199.
11. For an academic treatment of this magical process, see Stephen E. Flowers, *Runes and Magic* (New York: Lang, 1986), pp. 153–166.
12. See also the translation of Lee M. Hollander in *The Poetic Edda*, 2d ed. (Austin: University of Texas Press, 1962), p. 72.
13. See also the translation of Hermann Pálsson and Paul Edwards, *Egil's Saga* (Harmondsworth, UK: Penguin, 1976), p. 101.
14. The most famous depiction in the sagas of the blood being sprinkled in the temple is found in the *Eyrbyggja Saga*, chap. 4. See the translation of Hermann Pálsson and Paul Edwards (Toronto: University of Toronto Press, 1973), p. 40.
15. See Flowers, *Runes and Magic*, p. 249ff.
16. See Simpson, *Legends of Icelandic Magicians*, p. 33ff.
17. See Gjerset, *History of Iceland*, pp. 270–272.

18. See Simpson, *Legends of Icelandic Magicians*, pp. 37–44.
19. See Simpson, *Legends of Icelandic Magicians*, p. 56.
20. See Simpson, *Legends of Icelandic Magicians*, pp. 73–79.
21. For statistics on Icelandic witchcraft trials, see Ólafur Davídhsson, "Isländische Zauberzeichen und Zauberbücher," *Zeitschrift des Vereins für Volkskunde* 13 (1903): 150–151.
22. For a popular view of modern Icelandic attitudes toward occult phenomena, see Erlendur Haraldsson, "Are We Sensitive or Superstitious?" *Atlantica and Icelandic Review* 17:4 (1972), 30–34.
23. The most dramatic aspect of this is the official revival of the Norse religion in Iceland by Sveinbjörn Beinteinsson, who is the leader of what are called the *Ásatrúarmenn*—those who believe in the *Æsir*.

Chapter 3

1. See Simpson, *Legends of Icelandic Magicians*, p. 19.
2. See Davídhsson, "Isländische Zauberzeichen," p. 157.
3. See Simpson, *Legends of Icelandic Magicians*, pp. 73–79.
4. See Davídhsson, "Isländische Zauberzeichen," pp. 157–158.
5. For a survey of the history of the manuscript, see Nat. Lindquist, *En isländsk Svartkonstbok*, pp. 21–23.
6. See Davídhsson, "Isländische Zauberzeichen," pp. 160–167.
7. See Figure 2 on page 49.
8. This is certainly a forced interpretation.
9. See Davídhsson, "Isländische Zauberzeichen," pp. 267–270.
10. An edition of this book was done by Kristian Kålund, *Den islandske lægebog* (Copenhagen: Luno, 1907).
11. See Irmgard Hampp, *Beschwörung-Segen-Gebet* (Stuttgart: Silberburg, 1961), p. 110ff.

Chapter 4

1. Hampp, *Beschwörung-Segen-Gebet*, p. 110ff.
2. The classic text on this topic is by Erich Jung, *Germanisch Götter und Helden in christlicher Zeit*, 2d ed. (Munich: Lehmann, 1939).
3. See Árnason, *Íslenzkar Thjóðhsögur*, vol. 1, p. 432.
4. See Hjalmar Falk, *Odensheite* (Kristiana: Dybwad, 1924) pp. 8, 9, 29, 31.
5. Details of this were given by Árnason, *Íslenzkar Thjóðhsögur*, vol. 1, pp. 431–432, conveniently translated by Simpsor in *Icelandic Folktales*, pp. 181–182.
6. See also H. R. Ellis Davidson, *Gods and Myths of Northern Europe* (Harmondsworth, UK: Penguin, 1964), p. 180.
7. See Lee R. Gandee, *Strange Experience* (Englewood Cliffs, NJ: Prentice-Hall, 1971), p. 119.
8. A full account of this myth is given by Snorri Sturluson in *The Prose Edda*, trans. Jean I. Young (Berkeley: University of California Press, 1954), pp. 85–86.
9. For the original Old High German of this text, see Wilhelm Braune and Ernst Ebbinghaus, *Althochdeutsches Lesebuch*, 15th ed. (Tübingen: Niemeyer, 1969), p. 39.

Chapter 5

1. In this set of definitions I am generally following those given by Davíðhsson, “Ísländische Zauberzeichen,” pp. 152–154.
2. See the prose following st. 14 in the “Reginismál” and st. 16 and following in the “Fáfnismál” in the *Poetic Edda* (trans. Lee M. Hollander) and in the *Prose Edda* (trans. Jean I. Young), p. 112. It is specifically mentioned that Sigurdhr

takes the helm in chap. 19 of the *Völsunga Saga*; see the translation of William Morris and Eiríkur Magnússon (New York: Collier, 1962), p. 148. There are several editions of the Morris and Magnússon translation, as well as many other translations.

3. See, for example, the prose following st. 4 in the "Sigríðrúfúnmál" in the *Poetic Edda*, trans. Lee M. Hollander, p. 234.
4. The sator-square has been much written about. For its origin and history, see the fairly recent study by Walter O. Moeller *The Mithraic Origin and Meanings of the Rotas-Sator Square* (Leiden: Brill, 1973).
5. See H. Gustavson and T. S. Brink, "Runfynd 1978," *Fornvännen* (1979): 233ff.

Chapter 6

1. A variety of Judeo-Christian grimoires have been published or republished in recent years. Among the best known of these are *The Book of the Sacred Magic of Abra-Melin the Mage*, trans. S. L. MacGregor Mathers (Chicago: de Laurence, 1932); *The Greater Key of Solomon*, trans. S. L. MacGregor Mathers (Chicago: de Laurence, 1914); *The Book of the Goetia of Solomon the King*, trans. S. L. MacGregor Mathers, ed. Aleister Crowley (New York: Ram, 1970).
2. For some interesting insights on the power of the name in Norse magical thinking, see H. R. Ellis (Davidson), *The Road to Hel* (Cambridge: Cambridge University Press, 1943) pp. 137–148.
3. See "Fáfnismál" prose following st. 1 in the *Poetic Edda*, trans. Lee M. Hollander, p. 223. A whole study has been devoted to the magical power of the speech of the dying

man: Folke Strom, *Den doendes makt och Odin i trädet* (Göteborg: Elander, 1947).

4. Probably the most comprehensive treatment of the Norse conception of the soul readily available in English is H. R. Ellis (Davidson), *The Road to Hel*, pp. 121ff. For a more imaginative view, see Thorsson, *Runelore*, pp. 167–173.

1. This list of divine names perhaps represents an encoded message of some sort. The numbers of names in each of the three lists seem significant. The latter two consist of twenty-four and twelve names, respectively; the first one is probably supposed to contain seventy-two.
2. The use of magic in helping women in childbirth goes back into the Eddic tradition; for example, we find it in the "Sigrdífumál," st. 10: "Also learn help-runes / if you wish to help / a woman bring forth her baby." The term used in this context is ON *bjargrúnar* (help [in bearing children] runes).
3. To be able to stanch blood was a popular healing art in old Germanic times. It is well known in the *Lacnunga* and other Old English leechbooks.
4. These last two words are obvious misspellings or alterations of the name *Jehova Sebaoth* (*Yahweh Tzabaoth*), the ancient Hebrew war god.
5. The helm of awe (ON *ægishjálmr*) is the most interesting single feature of this manuscript. Both the word and its underlying meanings are intriguing. It occurs four times in

the *Poetic Edda*, all in connection with Fáfnir, the etin-serpent guarding the Níflung hoard. With the power of this helm he could strike terror into the heart of anyone who might attempt to win the treasure. It is said that Sigurdhr took it with him as a part of the hoard after he killed the serpent. Here it seems to have been symbolized as an actual helmet; however, it originally meant simply "covering," which is the oldest sense of the term "helm." Therefore, the whole formula would signify a "covering of awe or terror." The first part of the word, *ægis-* (possessive form from *ægir*, "terror") is derived from Proto-Indo-European **agh-es-* > Proto-Germanic **egis-* > Gothic *aigis* > Old English *egesa* and *ege* (hence, our modern "awe"), and > ON *agi*, all meaning terror. The spelling *ægir* is explicable as an *ablaut*, **agir* > **ógir* > **ægir* (in later Proto-Germanic). This helm of awe was originally a kind of sphere of magical power to strike fear into the enemy. It was associated with the power of serpents to paralyze their prey before striking (hence, the connection with Fáfnir). In our time this meaning is again clear. The helm of awe as described in the manuscript is a power, centered in the pineal gland and emanating from it and the eyes. It is symbolized by a crosslike configuration, which in its simplest form is made up of what appear to be either four younger M-runes or older Z-runes. These figures can, however, become very complex.

6. This manuscript is valuable for the hints it gives concerning the Scandinavian lore of trees and their magical correspondences. The oak has been associated with the power of the *thurs*-rune (ᚠ) and with the god Thórr. Here it seems to be acting as a terrifying apotropaic talisman.
7. This seemingly macaronic verse has not yet been satisfactorily interpreted.
8. Neither has the second line, but it has been said to contain a mnemonic device for the Danish runic alphabet.

9. The last two words here represent the Gnostic/Kabbalistic formula Tetragrammaton, the four-letter name of the Hebrew god (YHVH), also found in Spell 42.
10. This series of staves, which contains none that are obviously rune staves, nevertheless seems to be an expression of the system of the younger runes, since it contains the numerical formula $2 \times 16 = 32$.
11. In the medical theories of the ancient Germanic peoples, diseases were sometimes thought to be caused by tiny, invisible "worms" (serpents) in the food or drink.
12. These staves are sixteen in number, plus the solar cross, again an expression of the continuing potency of the number system of the younger futhark. The first stave is perhaps the elder J-rune, which continued to be used as a *galdrastafur*; the tenth stave appears to be a younger A-rune (†), which was perhaps intended as a : † : ; and the row ends with two elder H-runes.
13. Here eight staves are represented, which could be part of either a sixteen- or a twenty-four-based system. The twenty-four-based system continued to be used in the construction of magical formulas in the younger period.
14. Again the number 8 could be the key to this stave (number of staves radiating from the ring). The shape of the staves could be intended as *thurs*-runes (‡), and/or the whole could be a runic code: 3:5 (read: third *ætt*, fifth stave)—either : R : (in the special cryptic reordering) or : † : in the normal order. For a convenient discussion of runic codes, see Edred Thorsson, *Runelore*, pp. 87–91.
15. This row of twenty-four staves contains many recognizable rune staves, for example, $\text{𐌛} \sim \text{𐌚}$ (stylized M-runes), 𐌚 (later "dotted" T-rune [d or dh]), 𐌚 (S-rune), R (R-rune), H (H-rune), † (A-rune), H (older H-rune).
16. These eleven staves also contain several runic forms found in Spell 18, plus h (s), ƿ (k), † (final -R or y).

17. "Thy dew and dales" has been interpreted as Christian symbols for the blood and wounds of Jesus. However, this seems to be a Christianization of older pagan material relevant to the Earth mysteries.
18. The technique of this "prayer" is pure contagious magic based on the transference of negative force from the body to the water, which is washed away.
19. A byrnie is a breastplate or battle sark used by Germanic peoples—here the symbolism is obvious.
20. This formulaic protection from all sides, based on polar opposites, is very ancient and probably common to all peoples.
21. Another of the common old Germanic ideas concerning the origin of disease and misfortune in people and animals is that of projectiles shot by either trolls or elves.
22. This is only one of many indications of the wide variety of traditions synthesized in this manuscript.
23. No further instruction is given in this book to this mysterious spell.
24. Psalms and other portions of the Bible were often used in magical rites of all kinds, which is only fitting since many of the Psalms are actually adaptations of Canaanite mythomagical songs. This is from the Icelandic translation of the Bible made in 1584.
25. The fiend, or enemy, would appear to be Satan, who would help God prosecute the enemy. The Icelandic word used here is *andskotin* (adversary), which is a normal translation of the Hebrew *SaTaN*.
26. Ice. *synd* (sin) originally borrowed from Old English *synn* (sin). Most patently Christian terminology comes into Icelandic from Old English.
27. Another example of Old English Christian terminology is provided by "soul" (Ice. *sál* < OE *sāwel*). This term was originally part of the common Germanic storehouse of psy-

chological conceptions, probably with the meaning of "shadow, shade" in the vocabulary of life and death; however, it was Christianized at an early date.

28. The word *skuggi* usually more properly reflects the concrete idea "shadow," but it has clearly moved into the field of meaning of "soul" here.
29. Ice. *líf* (life), the living essence of a human being.
30. See also Spell 20; "day bath" (Ice. *daglaug*) is perhaps a metaphor for "blood."
31. Literally, "who have an evil mind [Ice. *hugr*] toward me." The *hugr* was originally the seat of the intellect and will (see Ódhinn's raven Huginn, Master of the Mind), but it later took on more magical connotations and could be sent out to do deeds for its owner.
32. Here again we see the *ægishjálmur*, as it forces all to fear it and be kind to its possessor.
33. Perhaps this indicates some knowledge of Arian Christianity, the form of Christianity that several Germanic tribes converted to in the fourth and fifth centuries.
34. Ice. *gaupnir*, the bowl formed by cupping the hands together.
35. These sixteen staves seem to be all highly stylized runic symbols arranged in two rows of eight. Their full meaning has yet to be decoded. It is not hard to see why the *galdramenn* in possession of this book were in need of spells against their enemies!
36. Rowan wood has a life-giving power and can control otherworldly things. It is also used in a contrary sense as a bringer of death. The use here either means that it was intended to protect the house from evil visitations or that it was meant negatively as a method of terrifying those who would come to the house.
37. Here thistle is probably meant. This is an herbal correspondence to the F-rune.

38. Again we see the use of the concept of something flying toward a person (a shot) to bring misfortune.
39. Alder is usually associated with fire and wakefulness; it corresponds to the S-rune. Here we again see the use of innate polarity to evoke the opposite effect.
40. The herbological element in this spell is twofold: (1) ash wood and (2) *millefolium* (yarrow). Ash is of well-known properties in Germanic myth and magic. Here it signifies the ability to make contact with other worlds. Yarrow, which was either ground up or its flowers made into an essential oil to be mixed with water, also has tremendous powers for making contact with "the other side," the unconscious. Not only did the ancient Chinese know of this (see the *I Ching* literature), but it was also well known among the Indo-Europeans as a divinatory tool. In later times it was dedicated to "the Evil One" (see Spell 41) and was popularly called the Devil's Nettle and Bad Man's Plaything; it was used in magical rites.
41. Again we see the use of the term *skuggi* in the sense of human soul, or shade, and here its use is more obviously a part of the psychic terminology with references to living persons—a kind of psychic double.
42. The manuscript term *iotuñ villuñ* (standard nominative form *jötna villur*) literally means the bewilderments of the etins (giants) and refers to some as yet unknown formula of murk staves used by the etins to delude and confuse. Human magicians can also control such things.
43. Here the manuscript reads *iotuñ geira blod* (standard nominative form *jötungeira blódh*), literally "the blood of etin-spears." *Jötungeir* (etin-gar) is a kenning for a worm and/or serpent. This forms a magical link with telluric powers.
44. The problematical word used in the manuscript is *thrijsteipta*, literally "three-diving" (inversed, or inverted). This occurs

also in another Icelandic manuscript where the *galdrastafir* appears. See also note 45. 

45. The word *moldthurs* clearly means earth-thurs (-giant), which perhaps indicates a reversed (i.e., murk) TH-rune (𐌛 or 𐌛), which is a powerful cursing sign (see "Sigrdrífumál," st. 36). The *mold-* could also refer to both the TH- and M-runes and reinforce the image of the staves connected to the ground as seen in note 44 and in the staves in Spell 34.
46. The shape of the *gapal(l)dur* is identified in the *galdrastafir* complex. Its name also occurs in other manuscripts. The word (*gap-aldur*) could mean "the age or eternity of space (void)." The meaning of the primary structure of the stave is open to speculation, although it is highly suggestive; however, the lines extending from the main form are perhaps coded runic references (i.e., on the left side 3:6 = 𐌚 and on the right 3:3/3 = 𐌛 : 𐌛).
47. The manuscript uses the term *særing*, and it is glossed in the margin as *exorcismus*. This term is generally used only in Christian contexts.
48. The word that is translated "read" in the text is Icelandic *ráðha*, which, in the technical terminology of the runes, has the deeper meaning of "to interpret, fathom" in the whole sense.
49. *Kvennrúnar* were originally formulas used to win the love of women (and were therefore sympathetic to them); they may have been attached to certain specific runes and rune staves.
50. Again we see the oak (see Spell 9 and note 6 above). Here it is used to make contact with the realm of the dead; this is done not by drawing the dead out of their graves but by forcing them out through the placement of the oak in their realm, thus driving the dead to the surface.
51. Altered version of the Vulgate translation of Psalm 119:7.

52. A version of the Vulgate translation of Psalm 119:75.
53. Same as in Spell 31.
54. The manuscript reads *friggjar gras*, "the herb of Frigg." This has been attached to various types of herbs. One is the *orchis odoratissima*, or *satyrium sibiricum*, from which love potions were brewed. This plant is also known in Icelandic as *hjún-agras* (*herba conjugalis*), the herb of marriage. However, it may be connected to the mandrake.
55. Here the manuscript reads a *sigur hellunne*, "on the victory rock." The significance of this is still unclear. It is perhaps a heathen reference applied to a Christian context or an otherwise unknown Hebraic myth that the Icelanders preserved from some heretical text.
56. This threefold Wodenic invocation includes the name Ódhinn beside *Ille*, "the Evil One," which may have been an old name for Ódhinn since he was called *Bölverkr*, "Evil-Worker," and was called "the father of all evil" in pagan times. *Ølvir* is interesting. It is our name Oliver and comes from Proto-Germanic **Alawīh-az*, "the All-Holy One." This is similar in meaning to the name *Wīhaz* (ON *Vé*), the third name in the primal threefold Wodenic formulation.
57. In the manuscript this whole verse reads: *Ølvir Odenn Ille // Allt thijtt vilid vijlle // Sialffur Gud med snijlle // Sendi ockur ast i mylli.*
58. The sign of the helm of awe, later the sign of the cross.
59. Probably the name of a magical sign. It is unclear whether the two staves referred to here correspond to the stave represented in the manuscript. *Homa* perhaps refers to an image of the Iranian tree of life (and the ancient sacred drink *haoma*, cognate to the Sanskrit *soma*). It is certainly possible that the *galdrastafur* represented here is a highly stylized version of such a treelike sign.
60. Probably hawthorn or sloe.

61. As represented in the stave.
62. When it stands at the highest point in the sky.
63. Here a new handwriting style begins, a seventeenth-century cursive hand. The language of the original is in the Danish dialect.
64. The representations of the *galdrastafir* do not seem to correspond to the numerical formulas. However, the numerical formulas contained in the text of the spell are very potent:

$$\begin{array}{rcl}
 8 \times 4 (\text{f}) & = & 32 = 16 \times 2 \\
 9 \times 8 (\text{t}) & = & 72 = 24 \times 3 \\
 13 \times 3 (\text{v}) & = & \underline{39} = 13 \times 3 \\
 & & 143 \quad 13 \times 11
 \end{array}$$

65. The manuscript reads *Ande*, "breath, spirit."
66. The manuscript reads *Hulenn hialmur*, "a covering of concealment." See the Middle High German *tarnkappe*, "a cape [not cap] of concealment," and *tarnhüt*, "a hide or skin [not hat!] of concealment," both of which occur in the *Nibelungenlied*.
67. If a speculation offered by Prof. Dr. Klaus Düwel is correct, this formula may be the ancestor of one going all the way back to about 200 c.e., where we find a spearhead with the runic inscription "ojingar," which might have become *ótti* in Icelandic. See Flowers, *Runes and Magic*, p. 255.
68. Compare this figure to that found in Spell 30 in the *Gald-rabók!* It is rare, other than with the *ægishjálmur*, to find this close correspondence in different manuscripts.
69. Feingur may be a nickname of Ódhinn (miswritten for Fen-gur?); see Falk, *Odensheite*, p. 8. Or it may be related to Icelandic *feigur*, "bound to die, fey."
70. This is a most unusual Thor's hammer! It may be a depiction of how the hammer is supposed to work.

71. The exact meaning of *mandrepeik* is unknown.
72. The *valbjörk*, "birch of the slain," is a kind of birch or maple tree unknown in Iceland.
73. Bowls are very typical objects on which runes are carved; see the *Galdrabók*.
74. The formula may be the Christian IHS: *in hoc signum*.
75. The invocation of Snorri's name may refer to Snorri of Húsafell or Snorri Sturluson, author of the *Prose Edda*. This kind of extremely complex magical sign is very rare in the corpus of signs in Iceland and is a clear indication of a late date and foreign origin.
76. The "Devil" (here the Icelandic word *djöfull*, of course borrowed from the Latin/Greek *diabolus*) is used. It must be remembered that, especially in the magician's world view, the old gods and the demons of the Christian hell had been unified. Hence, this may ultimately refer to some heathen deity.
77. See Simpson, *Icelandic Folktales and Legends*, pp. 181–182.
78. An animated corpse, or *draugur*, could be magically activated and sent to do the malevolent will of a sorcerer, in which case it is referred to as a *daudhingur*. See Svale Solheim, "Draug," *Kulturhistorisk Leksikon for Nordisk Middelalder* 3 (1958): 298.
79. This kind of magic is known in Icelandic as *sjónhverfing*, "sight twisting," a way of distorting the perceptions and causing illusions. See Ellis Davidson, "Hostile Magic in the Icelandic Sagas," p. 21ff.
80. The Hague: Nijhoff, 1948.
81. See Storms, *Anglo-Saxon Magic*, pp. 186–197.
82. The botanical designations of the nine herbs are (1) mugwort, *artemisia vulgaris*; (2) waybread or plantain, *plantago major*; (3) "stune" (?), lamb's cress, *cardamine hirsuta*; (4) venom-loather, cock's spur grass, *panicum crus Galli*; (5)

- mayweed, camomile, *anthemis cotula*; (6) "wergulu" (?), nettle, *urtica dioica*; (7) (crab)-apple, any of several trees of the genus *Pyrus*; (8) chervil, *anthriscus cerefolium*; (9) fennel, *foeniculum vulgare*.
83. See A. Kuhn, "Indische und germanische Segensprüche," *Zeitschrift für vergleichende Sprachforschung* 13 (1864): 49–73.
84. Then the infecting "worm" would be shot away, magically bound to the arrow.
85. For the parallels to the Vedic tradition, see the passages translated by H. H. Wilson, *Rig-Veda Samhita* (New Delhi: Cosmo, 1977), vol. 7, pp. 392–393; and by Ralph T. H. Griffith, *The Hymns of the Atharva-Veda*, 3d ed. (Varansi, India: Master Khelari & Sons, 1962), vol. 2, p. 412.
86. Here the Old High German word *idisi* is used, which may be related to Old Norse *dís*, pl. *dísir*, a group of divine mother-goddesses or protective spirits.
87. Phol is probably an alternative spelling of Vol(1), the masculine counterpart to the fertility goddess Volla (ON *Fylla*), sister of Frigga, also mentioned in the text.
88. William Dwight Whitney, *Atharva-Veda Samita* (Delhi: Motilal Banarsidass, 1962), vol. 1, pp. 166–168.
89. Other parallels are discussed by Jacob Grimm, *Teutonic Mythology* (New York: Dover, 1966), vol. 3, pp. 1231–1233; Turville-Petre, *Myth and Religion of the North*, pp. 122–124; Storms, *Anglo-Saxon Magic*, pp. 109–113.

Bibliography

- Árnason, Jón. *Íslenzkar Thjóðhsögur og Æfintýri*. 2d ed. Ed. A. Bodhvarsson and B. Viljálmsson. 6 vols. Reykjavík: Thjóðhsaga Prentsmidhjan Hólar, 1954–1961.
- Braune, Wilhelm, and Ernst Ebbinghaus, eds. *Althochdeutsches Lesebuch*. 15th ed. Tübingen: Niemeyer, 1969.
- Crowley, Aleister, ed. *The Book of the Goetia of Solomon the King*. Trans. S. L. Mathers. New York: Ram, 1970.
- Davíðsson, Ólafur. "Isländische Zauberzeichen und Zauberbücher." *Zeitschrift des Vereins für Volkskunde* 13 (1903): 150–167.
- Dickens, Bruce, ed. *Runic and Heroic Poems of the Old Teutonic Peoples*. Cambridge: Cambridge University Press, 1915.
- Dumézil, Georges. *Gods of the Ancient Northmen*. Ed. Einar Haugen. Berkeley: University of California Press, 1973.
- Einarsson, Stefán. *A History of Icelandic Literature*. New York: Johns Hopkins Press, 1957.
- Elliott, Ralph. *Runes: An Introduction*. Manchester: Manchester University Press, 1959.
- Ellis (Davidson), H. R. *The Road to Hel*. Cambridge: Cambridge University Press, 1943.

- Ellis Davidson, H. R. *Gods and Myths of Northern Europe*. Harmondsworth, UK: Penguin, 1964.
- . "Hostile Magic in the Icelandic Sagas." In *The Witch Figure*, ed. V. Newell, 20–41. London: Routledge and Kegan Paul, 1973.
- Falk, Hjalmar. *Odensheite*. Kristiana: Dybwad, 1924.
- Flowers, Stephen E. *Runes and Magic*. New York: Lang, 1986.
- Gandee, Lee R. *Strange Experience*. Englewood Cliffs, NJ: Prentice Hall, 1971.
- Gjerset, Knut. *History of Iceland*. New York: Macmillan, 1924.
- Griffith, Ralph T. H. *The Hymns of the Atharva-Veda*. 3d ed. 2 vols. Varansi, India: Master Khelari & Sons, 1962.
- Grimm, Jacob. *Teutonic Mythology*. 4 vols. New York: Dover, 1966.
- Gustavson, H., and T. S. Brink. "Runfynd 1978." *Fornvänner* (1979): 228–250.
- Hampp, Irmgard. *Beschwörung-Segen-Gebet*. Stuttgart: Silberburg, 1961.
- Haraldsson, Erlendur. "Are We Sensitive or Superstitious?" *Atlantica & Icelandic Review* 17:4 (1972): 30–34.
- Hollander, Lee M., trans. *The Poetic Edda*. 2d ed. Austin: University of Texas Press, 1962.
- Jones, Gwyn. *A History of the Vikings*. London: Oxford University Press, 1973.
- Jung, Erich. *Germanische Götter und Helden in christlicher Zeit*. 2d ed. Munich: Lehman, 1939.
- Kålund, Kristian. *Den islandske lægebog*. Copenhagen: Luno, 1907.
- Krause, Wolfgang. *Runen*. Berlin: de Gruyter, 1970.
- Kuhn, A. "Indische und germanische Segensprüche." *Zeitschrift für vergleichende Sprachforschung* 13 (1864): 49–73.
- Lindqvist, Nat. *En isländsk Svartknostbok från 1500-tallet*. Uppsala: Appelberg, 1921.
- MacGregor-Mathers, S. L., trans. *The Book of the Sacred Magic of Abra-Melin the Mage*. Chicago: de Laurence, 1932.

- , trans. *The Greater Key of Solomon*. Chicago: de Laurence, 1914.
- Moeller, Walter O. *The Mithraic Origin and Meanings of the Rotasator Square*. Leiden: Brill, 1973.
- Morris, William, and Eirikur Magnusson, trans. *The Volsunga Saga*. New York: Collier, 1962.
- Pálsson, Hermann, and Paul Edwards, trans. *Eyrbyggja Saga*. Toronto: University of Toronto Press, 1973.
- , trans. *Egil's Saga*. Harmondsworth, UK: Penguin, 1976.
- Simpson, Jacqueline. *Icelandic Folktales and Legends*. Berkeley: University of California Press, 1972.
- . *Legends of Icelandic Magicians*. Cambridge: Brewer, 1975.
- Solheim, Svale. "Draug." *Kulturhistorisk Leksikon for Nordisk Midaldalder* 3 (1958): 297–299.
- Storms, G. *Anglo-Saxon Magic*. The Hague: Nijhoff, 1948.
- Strom, Folke. *Den doendes makt och Odin i trädet*. Goteborg: Elander, 1947.
- Strömbäck, Dag. *Sejd*. Stockholm: Geber, 1935.
- Sturluson, Snorri. *The Prose Edda*. Trans. Jean I. Young. Berkeley: University of California Press, 1954.
- . *Heimskringla*. Trans. Lee M. Hollander. Austin: University of Texas Press, 1962.
- Thorsson, Edred. *Runelore*. York Beach, ME: Samuel Weiser, 1987.
- Turville-Petre, E. O. G. *Myth and Religion of the North*. New York: Holt, Rinehart and Winston, 1964.
- Vries, Jan de. *Altgermanische Religionsgeschichte*. 2d ed. 2 vols. Berlin: de Gruyter, 1956–1957.
- Whitney, William Dwight. *Atharva-Veda Samita*. 2 vols. Delhi: Motilal Banarsidass, 1962.
- Wilson, H. H. *Rig-Veda Sanhita*. 7 vols. New Delhi: Cosmo, 1977.