

# Maria Orsic, Nikola Tesla, Their Extraterrestrials Messages, The Occult And UFOs (3rd Edition)

Volume 2 from a set of 2 Volumes





# Maximilien de Lafayette

MARIA ORSIC, NIKOLA TESLA, THEIR  
EXTRATERRESTRIALS MESSAGES, THE  
OCCULT AND UFOS. Part 2

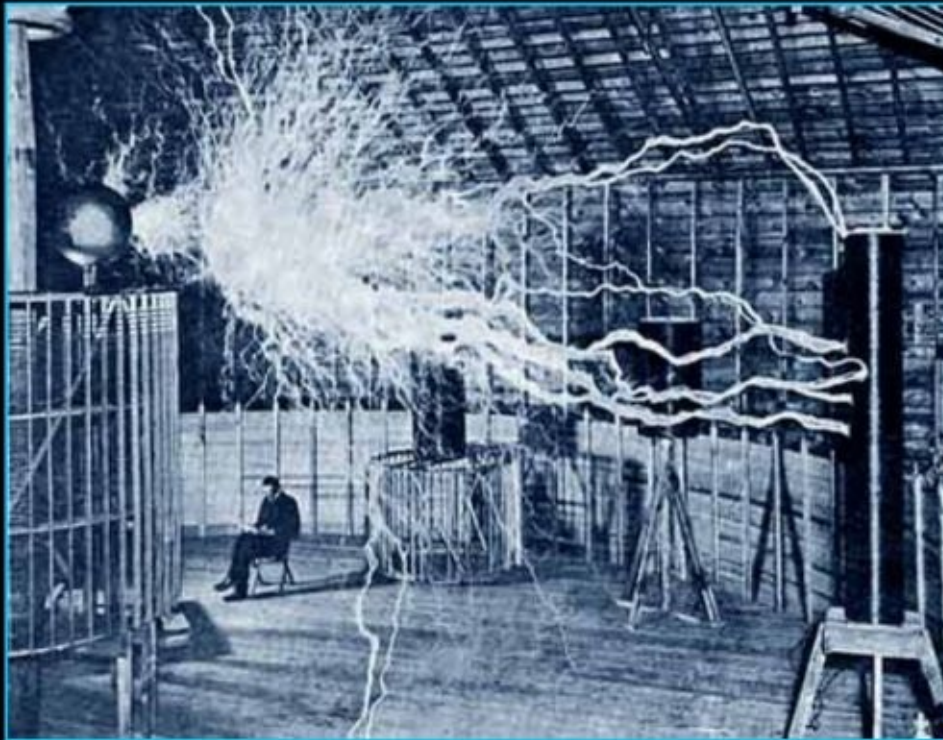



Maria Orsic, the most important personality in ufology's history.

Maximilien de Lafayette's books are available in 2 formats:

1-Amazon Kindle edition at [www.amazon.com](http://www.amazon.com)

2-In paperback at [www.lulu.com](http://www.lulu.com)

<http://stores.lulu.com/maximilliendelafayette>

Author's website:

[www.maximilliendelafayettebibliography.com](http://www.maximilliendelafayettebibliography.com)

Date of Publication: September 27, 2011.

Printed in the United States of America.

Copyright ©2011 by Maximillien de Lafayette. All rights reserved. No part of this book may be used or reproduced by any means, graphic, electronic, or mechanical, including photocopying, recording, taping or by any information storage retrieval system without the written permission of the author except in the case of brief quotations embodied in critical articles and reviews.

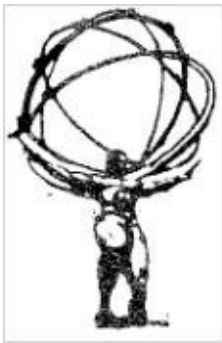

## Maria Orsic, Nikola Tesla, Their Extraterrestrials Messages, The Occult And UFOs (3rd Edition)

Volume 2 from a set of 2 Volumes



# Maximilien de Lafayette

\*\*\* \*\*

Edited by

Dina Vitantonio

Paulette Attie

Partially translated from German and French by

Erica Soderholm

Gisele von Guntenbergersen

Contributor

Lt. Colonel Petrit Demaliaj (Albanian Air Force/Army, Ret.)

Times Square Press



## Table of Contents

---

### **Chapter 2: The Story of Maria Orsic...21**

- Thinking of meeting with other groups...21
- Predicting the rise of a Nazi Germany...21
- Before the meeting: Reconstruction of the discussions of the Ladies of Vril (A synopsis)...22
- In order to build the Adelbaran's spaceship...22
- The Ladies of Vril meetings...24
- The first meeting; Tuesday 16, September 1919...24
- The second meeting; Friday 19, September 1919...24
- The third meeting; Wednesday 17, December 1919...25
- The fourth and fifth meetings...25
- Present at the meeting...26
- Preliminary notes and comments by Dr. Schumann...33

- Excerpts from Dr. Schumann's notes...33
- Viktor Schauberger's Repulsine...36
- Viktor Schauberger's Repulsator...37
- Notes on Maria Orsic's mind-bending technical data...38
- March 1922: First prototype of Jenseitsflugmaschine...41
- Stargates line; the 33.33 degree...41
- Comparing Maria's data with Viktor Schauberger and Karl Haushofer data...41
- March 23, 1922: The first flight-test of Jenseitsflugmaschine...47
- A fiasco...47
- Yes, it can be done!...47
- Dr. Schumann could have not solved the problem without Maria's help!...48
- Mental command and channeling...48
- Headband Mental Command Device...48
- A new spaceship is built...51
- December 17 of 1923: A new model of the super Jenseitsflugmaschine came to life...51
- January, 1924: The first successful flight of Jenseitsflugmaschine...54
- Maria: "I am not interested in bombing people and cities."...54
- Secretly manufacturing two small flying machines...55
- Maria Orsic's new two circular crafts...55
- Story confirmed by Major Hartmann...57
- Sketch of the Vril 1-Triebwerk, built upon specifications and technical data provided by Maria Orsic ...59
- Sketch of the Vril 7, built according to Maria's technical data...60
- Early Allies intelligence reports...61

- The early documented German UFOs...61
- Sir Roy Fedden on Maria's "secret design"...69
- Different types and shapes of Germany's UFOs...71
- The Swedish newspaper "Aftonbladet" article...73
- Andromeda: Sketch and notes, taken from the German SS files...74
- Arthur Sack's circular flying machine prototype, phase 2...75
- The original Horten 229 flying wing invented by the Horten brothers, unloaded by the United States army in 1945...77
- The German Me 163 UFO prototype...78
- German Patent of a Nazi UFO registered under number 2,147,668...80
- Alexander Lippisch Delta Wing plane (DM-1)...82
- Lippisch aerodyne...83
- Sketch and technical data of Haunebu II...85
- 1945: Getting out of Germany...89
- Aldebaran's instructions to Maria to get out of Munich...91
- Maria's message to Magda Goebbles...91
- Account of Erna Flegal, Hitler's personal nurse...92
- Another astonishing message from Maria!...103
- Maria's letter to Cardinal Michael von Faulhaber...103
- What Maria Orsic told Cardinal Michael von Faulhaber about the extraterrestrials, God and religions...108
- Final Days of Maria Orsic in Germany...115
- Farewell to her friend, Dr. Schumann...117
- Spotted by Lt. Col. Walter Fellenz...119

### **Chapter 3: Maria Orsic, the occult, mysticism, and metaphysics...127**

- Aldebaran, Ash.Ta.Ri, the Anunnaki, Sumer, the extraterrestrials...127
- Aldebaran's aliens are not the Anunnaki, but an offspring of the Anunnaki...128
- Nibiru "Ne.Be.Ru" in the Akkadian/Sumerian texts...130
- Aldebaran and Ash.Ta.Ri in the ancient texts...130
- Where do we find these words in the Akkadian/Sumerian Tablets and texts?...130
- In Anunnaki Ulema manuscripts...132
- Epistemology/Etymology...132
- In other ancient languages...135
- Summary of findings...137
- How did Maria Orsic describe Aldebaran (Ash.Ta.Ri)?...138
- 1.Days calendar and moons around the inhabitable planets in Aldebaran...138
- 2.Atmosphere and energy...138
- 3.Waters, lands and lakes...139
- 4.Adjacent planets and other extraterrestrials...139
- Hajarat Al Houblah...143
- Effects on humans upon arrival to Aldebaran-Ashtari...147
- Upon arrival...147
- Immediate human impression and reactions...149

- But who are the Anunnaki and their offspring the Aldebaran's extraterrestrials?...151
- The Anunnaki...151
- I-The wrong definitions...151
- II. The correct definition...154
- III. Other names of the Anunnaki...156
- Revelations by Anamidra...161
- I. Definition and introduction... 161
- II. Anamidra and Earth Matrix... 161
- III. Anamidra explains what kind of clay, the Anunnaki used to create Man... 161
- III. Anamidra explains the creation of Man from cosmic clay...162
- IV. Anamidra spoke about the early human species who lived underwater... 162
- IV. Early intelligent lifeforms who lived inside Earth...162
- Maria explains the world of extraterrestrials...165
- Ethics...165
- Karma, Body's Cells and the Extraterrestrial Mind...165
- Aldebaran's Akashic Library...166
- Learning from the Aldebaran's Extraterrestrials and Anunnaki...166
- And what is Ana'kh, the script Maria Orsic received telepathically from the extraterrestrials?...173
- Ana'kh words in Semitic and ancient non-Semitic languages...174

#### **Chapter 4: Answers to questions on your mind...177**

**Chapter 5: Maria Orsic's predictions...185**

**Chapter 6: Maria' Orsic's quotes...191**

**Chapter 7: The United States and the paranormal aspect of UFOs and military interests...197**

- American psychics were called in...197
- Dr. Joseph Banks Rhine...199
- Military interests...201

**Chapter 8: UFOs, aliens, aliens' rapture, Nikola Tesla, and the United States government...209**

- What is the aliens' rapture?...209
- I.Definition and introduction...209
- II.Channeling with extraterrestrials and entities from galactic civilizations is impossible...209
- III. Any authoritative source(s) on the aliens' rapture and extraterrestrials' communications?...210
  - 1.Introduction...210
  - 2.Some of these sources are...210
- Nicola Tesla's files on the extraterrestrials...212
- Tesla's "Exotericon Gama" file...212

- Foxworth, then, assistant director of the New York FBI bureau was called in...218
- J. Edgar Hoover, Dr. Trump and Tesla's files...218
- Clyde A. Tolson hides Dr. Trump's report...219
- Hoover falsified/switched Dr. Trump's report...220
- Dr. Trump's conclusions...220
- Tesla, Brigadier General L. C. Craigie, and Patterson Air Force Base, and the "Project Nick"...220
- Note on Brigadier General L. C. Craigie: Lt. General L. C. Craigie's Promise to Truman...223
- More scientists, including Fermi were called in...231
- "Project Nick" is now "Project Lexicon"...231
- Extraterrestrials' warning...231
- What's left from Tesla's files are now in the hands of the Yugoslavian army...232
- Soviet Premier Nikita Khrushchev's announcement to the Supreme Soviet (Presidium)...232
- Tesla was concerned about the "Safety of Earth"...232
- Sava Kosanovic taken under custody for two full weeks...233
- Further investigations of Tesla's scenario of the alien rapture...233
- President Eisenhower allocated a huge budget...233
- Project Seesaw...236
- The Russians built their first Tesla's beam weapon facility...236
- The CIA learned about the Russian facility from alien space-beacons orbiting Earth...236
- Russian Tesla's beam weapon system and the United States Strategic Defense Initiative (SDI)...  
237
- President Reagan on the "Aliens' Threat"...237
- The FBI secret files on Tesla...239

\*\*\* \*\*

## Table of Illustrations

---

- Traute...23
- **Gudrun Jentsch...27**
- **Heike Erhardt...27**
- **Sigrun Kuenheim...27**
- Maria Orsic...27
- Traute A. **Blohm...27**
- Friedrich Delitzsch...28
- Alfred Rosenberg...29
- Arnold Schoenberg...29
- Dr. Ernst Rudin...30
- Dr. Otmar Freiherr von Verschuer...30
- Dr. Winfried Otto Schumann...30
- Gottfried Feder...30
- Julius Streicher...31
- Wolfram Sievers...31
- Theodor Fritsch...31
- Rudolf Joseph Lorenz Steiner...32



- Leopold Ziegler...32
- Karl Haushofer...34
- Viktor Schauberger...35
- Viktor Schauberger's Repulsine...36
- Viktor Schauberger's Repulsator...37
- An authentic photo reproduction of a Gray "Grey" (Intraterrestrial alien)...38
- An early sketch from Thule...40
- Viktor Schauberger's Jenseitsflugmaschine (JFM).any believe Schauberger's machine was a replica of Orsic's UFO...42
- Germany's "First Disc", based upon Maria Orsic's technical data...43
- Artist's vision of Maria Orsic-Professor Winfried Otto Schumann Jenseitsflugmaschine...44
- Rundflugzeug RFZ-1...45
- Rundflugzeug RFZ-2...45
- Rundflugzeug RFZ-3...45
- Rundflugzeug RFZ-4...45
- Rundflugzeug RFZ-5...45
- A UFO photograph taken in Hamburg, Germany in March 1918...46
- **General Carl "Tooey" Spaatz, left, then, the Air Force chief of staff, and Lt. General Curtis LeMay, USAFE commander, review an honor guard upon Spaatz's arrival at the Wiesbaden Airport, Germany on May 11, 1948...49**
- General Trudeau, the father of the reverse engineering of alien technology program...50
- A reconnaissance aerial photo taken at the Arado plant in 1944 ...53
- Sigrun...54
- Dr. Eugene Sänger...56
- Major Erich Hartmann...58

- Sketch of the Vril 1-Triebwerk, built upon specifications and technical data provided by Maria Orsic...59
- Sketch of the Vril 7, built according to Maria's technical data...60
- A Russian UFO...61
- Marshal Zhukov...62
- General Patton...62
- Alpenfestung S. 240: Map of the secret route...63
- Neuschwabenland, the last German colony...64
- SS General Hans Kammler...65
- Austrian Karl Schapeller had conducted successful experiments with Vril...66
- Hermann Goering, head of the Luftwaffe...68
- Sir Roy Fedden...69
- Different types and shapes of Germany's UFOs...71
- On October 10, 1952, the Swedish newspaper "Aftonbladet" published an article describing a German saucer built by Dr. Wernher von Braun at Peenemünde, which lifted off in April, 1944...73
- Andromeda: Sketch and notes, taken from the German SS files...74
- Arthur Sack's circular flying machine prototype, phase 2...75
- Arthur Sack's circular flying machine...76
- The original Horten 229 flying wing invented by the Horten brothers, unloaded by the United States army in 1945...77
- The German Me 163 UFO prototype...78
- The Me 163 B UFO, phase 2...78
- German officers in front of UFO Haunebu I...79
- Above and below: German Patent of a Nazi UFO registered under number 2,147,668...80

- Dr. Alexander Lippisch...81
- Alexander Lippisch Delta Wing plane (DM-1) was captured by the United States army...82
- Lippisch aerodyne, tested during the Second World War...83
- Lippisch's futuristic design, based upon metaphysical-extraterrestrial messages given to Maria Ostric...84
- Sketch and technical data of Haunebu II...85
- The RFZ first flight test...86
- The Haunebu II in February 1944...87
- Magda Goebbels with her daughters...92
- Traudl Junge, during the Second World War...93
- Traudl Junge in 2002...93
- Magda Goebbels...94
- Martin Bormann (Hitler's private secretary) knew about Maria Orsic's spacecraft...95
- Erna Flegel, Hitler's nurse, left in 2005, right in 1933...96
- Erna Flegel with Adolf Hitler...96
- Richard Helms (a former CIA director in 1970)...97
- Soldiers of the Red Army displaying the dead bodies of the daughters of Josef Goebbels, poisoned by Dr. Helmut Kunz...98
- Russian military looking at the charred bodies of Josef Goebbels , his wife Magda and their children who were poisoned in Hitler's bunker...99
- Adolf Hitler with his god-daughter Edda Goering, daughter of Goering, held by her mother Emmy...100
- Edda with her father Hermann Göring...100
- The end of Germany...101
- Munich...destroyed by Allies' bombings, few weeks after the departure of Maria Orsic...102

- Cardinal Michael von Faulhaber, Archbishop of Munich during NAZI Germany...103
- Cardinal Michael von Faulhaber laying hands on the head of Joseph Ratzinger, the future Pope Benedict XVI, on June 29, 1951...104
- Inanna's symbol...105
- Inanna, Anunnaki goddess in the Babylonian myths...106
- The stele of Ur-Nammu, circa 2200 B.C. On the very top, the star surrounded by a crescent, Maria drew in her letter to Cardinal Michael von Faulhaber...107
- Cardinal Michael von Faulhaber...108
- Rabbi Israel Zolli, the Chief Rabbi of Rome...109
- Reverend Arthur B. Klyber...110
- Nazi Germany collapses...116
- Dr. Schumann...117
- Sterneckerstraße...118
- Lt. Col. Walter Fellenz, a reliable eye witness who reported the sighting of Maria Orsic's UFO-Vril hovering over Munich on Sunday 18, March 1945...119
- Brigadier General Henning Linden...120
- Hans Schissler (left) in his apartment, was the last person in Munich who reported seeing Maria Orsic with a German Colonel...121
- Thierschstraße, the last reported whereabouts of Maria Orsic, where she met with a group of high-ranking German officers, including Lt. Colonel Horten...122
- Frauenkirche, Munich, destroyed by Allied bombings...123
- Munich on May 31, 1945, destroyed by the Allies bombings, two months after Maria left Munich...123
- Map of Sumer, showing the location of the Anunnaki cities: Babylon, Lagash, Uruk, Ur and Eridu...129
- A column from Baalbeck's temples...141

- The Trilithon of Baalbeck...142
- Hajarat Al Houblah in Baalbeck...143-144
- Ruins of Tushpa-van, the capital of kingdom of Urartu...145
- Inscription on a brick from the Tower of Babel. Blockprint, Babylon, 604-562, Babylon...146
- Ea “Enki” supreme god of the Anunnaki and father of the Aldebaran’s extraterrestrials (Offspring of the Anunnaki) stepping on a dry land, a gesture symbolizing his supreme authority over Earth...152
- Map of the Adelbaran’s extraterrestrials and Anunnaki’s land on Earth...153
- Babylonia, land of the Anunnaki , when it was captured by the Persians...155
- View of ancient Babylonia...158
- Berthold Konrad Hermann Albert Speer...177
- Dr. von Braun...198
- Dr. Joseph Banks Rhine with his wife, Dr. Louisa Rhine...199
- Dr. Vannevar Bush, President Harry Truman, presenting James B. Conant with the Medal of Merit and Bronze Oak Leaf Cluster on May 27, 1948...200
- President Harry Truman with members of the National Defense Research Committee: Roger Adams, Vannevar Bush, standing, third from left, K. T. Compton, James Bryant Conant, Alphonse Raymond, Albert Baird, Jerome Clarke, Frank B. Jewett, Alfred Newton, Lewis Hill, January 20, 1947...201
- From left to right: Mikhail Gurevich, Artem Mikoyan...203
- Andrei Sakharov and Igor Kurchatov...204
- From left to right: Mikhail Tikhonravov, Sergei Korolev, pausing in front of Konstantin Tsiolkovsky...205
- *The National Bank of Yugoslavia introduced this 100 dinars bill which features Nikola Tesla...213*
- *Nikola Tesla (Fourth from left) with King Peter II of Yugoslavia in Hotel New Yorker in New York, on July 15, 1942. Third from left is Tesla nephew Sava Kosanovic...214*
- Nikola Tesla in his lab...215

- Nikola Tesla...215
- Death mask of Nikola Tesla...216
- Marshal Josip Broz, Yugoslavia's leader, better known as Tito with Major General Koca Popovic, commander of the partisan First Army Corps. *March 14, 1944*...217
- From left to right: J. Edgar Hoover, Royal Miller, Clyde A. Tolson and Joseph McCarthy...219
- Clyde A. Tolson...220
- Nikola Tesla 2 room suite at the Hotel New Yorker, on January 12, 1943. From left to right: Bogoljub Jevtic, then member of the Royal Government of the former Kingdom of Yugoslavia, Professor Dr. Boris Furlan, and Sava Kosanovic, Nikola Tesla's nephew and a diplomat...221
- Inside one of the rooms of Nikola Tesla occupied at the New Yorker Hotel...222
- Dr. Edward Teller...223
- Lt. General L. C. Craigie...223
- Left, standing, Nancy Easley Johnson, daughter of Major Edwin Easley who secured at the UFO crash in 2002...225
- At Fort Worth Base (Carswell AFB), on November 19, 1949, from left to right: Lt. General Curtis LeMay, then, head of Strategic Air Command, Senator Richard Russell, Major General Roger Ramey, then, head of the 8<sup>th</sup> Air Force at Carswell, pilot John Bartlett, the Air Force Secretary Stuart Symington, Senator Lyndon Johnson, and Congressman William Thornberry...226
- Dr. Vannevar Bush...227
- United States aerial reconnaissance photo of a Russian beam weapon (based upon Tesla's invention) installation near Semipalatinsk...228
- Dr. John G. Trump...228
- Dr. Enrico Fermi at Los Alamo...230
- AUTEK base in the Bahamas...234
- LL Jackson commander of the base, 1969...235
- The FBI secret files on Tesla...239-253

## **Chapter 2: The Story of Maria Orsic**

Continued from Part One

---

**Thinking of meeting with other groups:**

While Maria was still waiting to hear from Professor Schumann, Traute suggested that all of them must meet with people who can help build Jenseitsflugmaschine, the Aldebaran's UFO.

The idea seemed to appeal to some, but not to Sigrun, who, first, distrusted men in general, and second, did not believe that total strangers would be interested in a metaphysical project, at the time, Germany was struggling with economical instability.

At one point, Maria became very reluctant, for she feared that the Aldebaran's technical data could fall into the hands of people who could misuse it.

**Predicting the rise of a Nazi Germany:**

Being an extraordinary psychic, Maria in 1919, foresaw the rise of a NAZI Germany, and even predicted with utmost certitude that Adolf Hitler and Heinrich Himmler, one day, will rule Germany with an iron fist, and bring Germany to her knee.

Worth mentioning here that in 1919, Adolf Hitler was a retired and bitter Corporal from the defeated German army that fought during World War One, and at that time, was very preoccupied with investigating Deutsche Arbeiterpartei (German Workers' Party).

Ironically, Hitler became its leader, upon the recommendation of Anton Drexler, one of the founders of the party.

On October 7, 1900, Heinrich Himmler was born in Munich, and in 1919, he graduated from high school in Landshut. It was not until August 18, 1923, that Himmler joined the Nazi party.

On January 6, 1929, Adolf Hitler appointed him Reichsführer SS, and in August 1931, Himmler created the Sicherheitsdienst ; SD (The Security Service of the Nazi Party).

Thus, the concept and creation of Germany's UFOs began years before Hitler and Himmler ascended to power.

And what is so extraordinary about Maria's prediction resides in the fact that she has discussed Adolf Hitler and Himmler in two meetings with her Ladies of Vril that occurred in 1919, and 1921.

Following a "Labyrinth Channeling séance", the Ladies of Vril expressed their concern about Hitler and Himmler, and the inevitable; meaning Himmler's domination over their Vril. Maria was absolutely sure that once Heinrich Himmler becomes aware of Jenseitsflugmaschine, he will exploit it as a military weapon, and if the Ladies of Vril will refuse to cooperate with him, he will shoot them on the spot.

\*\*\* \*\*

**Before the meeting:**

**Reconstruction of the discussions of the Ladies of Vril** (A synopsis).

**Maria:** Without backing and funds, we will never be able to build the Jenseitsflugmaschine.

**Traute:** I think we should wait and see what Dr. Schumann has to say.

**Traute:** I think we should go ahead and meet with...

**Sigrun:** Not a good idea. Without positive inputs from Professor Schumann, nobody would listen to us.

**Maria:** True. Correct. Otherwise we will look stupid.

Does anyone here know how to explain the technical data?



I don't.

**Traute:** How about meeting with other mediums?

Some might know something about the script (Aliens' messages).

**Heike:** Wait a moment, why don't you talk to your friends at the Theosophical society? (Talking to Maria)

**Maria:** Great idea. I am sure somebody there could translate the script (The message received in old cuneiform inscriptions).

**Traute:** I think that before meeting with anybody we must have a complete translation of the script, a scientific explanation from Dr. Schumann, and hide it from everybody...

All agreed.

\*\*\* \*\*

### **In order to build the Adelbaran's spaceship:**

But in order to accomplish this, many things had to be done:

- **1** -All the messages received in an unknown script must be accurately translated.
- **2** -The images Maria received telepathically must be interpreted and explained scientifically.
- **3** -Joint effort with other psychics/mediums and financiers to get the financing.
- **4** -Contact scientists and engineers to decipher and explain the technical data on how to build the spaceship, and especially the Jenseitsflugmaschine's sketches.
- **5** -Secure financing from sources not affiliated with the authorities.
- **6** -Keep the whole project secret.

\*\*\* \*\*



Traute

### **The Ladies of Vril Meetings**

---

Maria and the Ladies of Vril had a total of five meetings with other groups, members of Thule and DHvSS ( Die Herren Vom Schwarzen Stein) , some of Germany's distinguished personalities and leading figures in various disciplines, occupations and professions, including physicians, linguists, engineers, theorists, writers, philosophers, financiers, as well as politicians.

All the meetings took place in Munich.

They met to discuss the possibility of building a new kind of a super flying machine called Jenseitsflugmaschine, as well as other types of wonder-machines (These machines were discussed much later) which in ufology's jargon are referred to as UFOs.

\*\*\* \*\*

### **The First Meeting; Tuesday 16, September 1919.**

Maria met with Professor Winfried Otto Schumann in a cafe on Arcisstraße, not far from the Technical University of Munich.

They had a preliminary discussion about a technical data on how to build a super flying machine, Maria Orsic received from extraterrestrials from Adelbaran.

Maria asked him if he was interested in exploring the possibility of building such a machine.

Dr. Schumann was very perplexed but did not reject the idea. He suggested to Maria to gather more data and any other pertinent information for further consideration.

It was a brief meeting but promising.

\*\*\* \*\*

### **The Second Meeting; Friday 19, September 1919.**

Maria met once again with Dr. Schumann and gave him a few pages which contained a script written in a language totally unknown to her. Dr. Schumann recognized part of the script and told Maria that he will consult with Friedrich Delitzsch, a noted Assyriologist and expert on ancient languages.

\*\*\* \*\*

### **The Third Meeting; Wednesday 17, December 1919.**

Maria, the Ladies of Vrill and Dr. Schumann met with other mediums, and members of Thule and DHvSS ( Die Herren Vom Schwarzen Stein) in an old printing house near Berchtesgaden.

Everything went well, but not as good and not as fast as Maria wished, for they explained to Maria, that her technical data must be studied very thoroughly and this could take a few months.

They asked Dr. Schumann to submit a detailed scientific report on the material presented by Maria.

It took Dr. Schumann two months to create a concise scientific dossier, and almost 5 months to get the financing, even though members of Thule and DHvSS were wealthy and affluent, and two additional meetings to put everything in order.

The delay seemed to slow down the enthusiasm of Maria, but Dr. Schumann reassured her that everything will be fine.

\*\*\* \*\*

### **The Fourth and Fifth Meetings:**

We don't have the precise dates, but we know that they occurred between January and mid February of 1920.

Worth mentioning here that Maria was overwhelmed by the presence of some attendees (listed below) because of their political affiliations and by a few intellectuals known for their controversial ideologies, but she had no other alternatives for the time being.

Of course, in the following months she would distant herself from some of them, especially when she learned about their true agenda, and the reasons for their interest in building her flying machine.

The only person she could fully trust was Dr. Schumann who has become a father figure for Maria.

\*\*\* \*\*

**Present at various meetings:**

- Maria Orsic
- Traute A. **Blohm**
- **Heike Erhardt**
- **Gudrun Jentsch**

- **Sigrun Kuenheim**
- Alfred Rosenberg
- Arnold Schoenberg
- Dr. Wolfram von Wartenburg
- Dr. Ernst Rudin
- Dr. Ludwig Lewin
- Dr. Otmar Freiherr von Verschuer
- Dr. Walter Johannes Stein
- Dr. Winfried Otto Schumann
- Felix Niedner
- Gottfried Feder
- Hermann Pohl, founder of the Walvater Teutonic Order of the Holy Grail
- Julius Streicher
- Karl Harrer
- Karl Haushofer
- Friedrich Delitzsch
- Rudolf Freiherr von Seboottendorf (Rudolf Blauer)
- Rudolf Joseph Lorenz Steiner
- Theodor Fritsch, founder of the Order of Teutons
- Theodor Illion
- Wilhelm Filchner
- Wilhelm Frick
- Peter Jensen

- Adolf Josef Lanz
- Leopold Ziegler
- Karl Ruprecht Kroenen
- Wolfram Sievers
- Ernst Schulte-Strathaus
- Max Amann

Note: We don't know exactly who attended each meeting, because no minutes were taken, besides, Maria Orsic wanted to keep all these meetings top secret. We knew about these gatherings from Dr. Winfried Otto Schumann and Hermann Pohl.



**Gudrun Jentsch Heike  
Erhardt Sigrun Kuenheim**

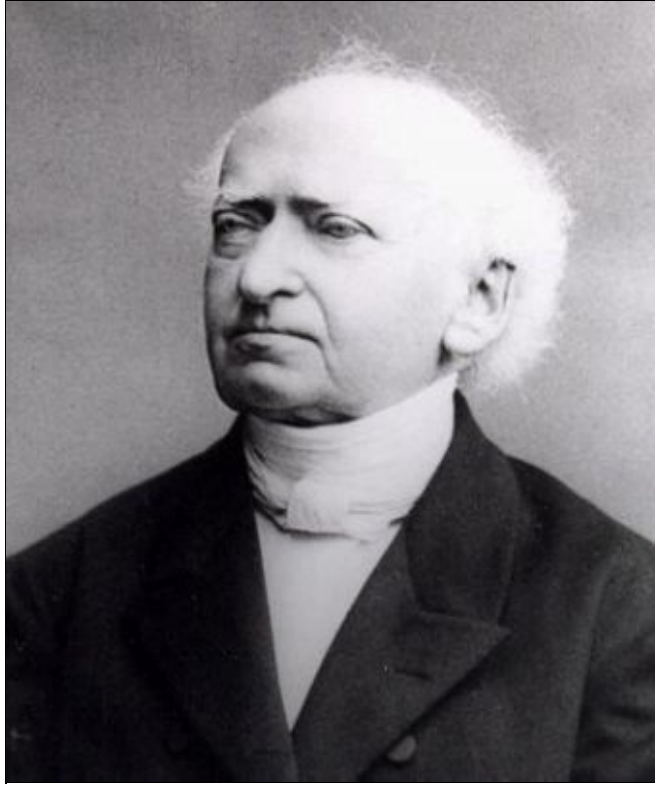

Maria Orsic Traute A. **Blohm**

---





Friedrich Delitzsch

Delitzsch was a distinguished linguist, and expert in the ancient languages of the Middle East, especially Assyrian and Sumerian. At one point, he said that Maria Orsic's cryptic text consisted of a very Old Babylonian language and a script similar to Ugaritic cuneiform style of writing, but could not decipher the Ana'kh text which contained the Aldebaran's technical data on how to build a super flying machine. He was puzzled by Ana'kh.

---



Alfred Rosenberg



Arnold Schoenberg

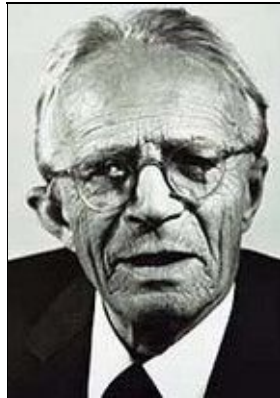

Dr. Ernst Rudin Dr. Otmar Freiherr von Verschuer



Dr. Winfried Otto Schumann Gottfried Feder



Julius Streicher Wolfram Sievers



Theodor Fritsch



Rudolf Joseph Lorenz Steiner



Leopold Ziegler



**Preliminary notes and comments by Dr. Schumann**

Nota Bene: The following notes were given to Tomislav Orsic, Maria's father, who for a short time, worked at the Technical University of Munchen.

Said notes and/or comments were reported by SS General Hans Kammler to the OSS, and later confirmed by General Dr. Walter Dornberger.

---

**Excerpts from Dr. Winfried Otto Schumann's notes:**

“...I am not sure if Jenseitsflugmaschine could be built. In theory it is possible. I am familiar with the concept of implosion, which has already been discussed by Mr. Schaubberger...”

Dr. Schapeller's experiments were successful, and in essence the technical data as outlined by Maria do not contradict the findings of both Mr. Schaubberger and Dr. Schapeller.

I found it fascinating...I am concerned with her request to keep everything secret; I don't think it is possible, especially if the project is to be discussed with other colleagues whose expertise is much needed to develop the project.

I need more time to consider the whole situation. But definitely I am very interested. This could be an unprecedented exploration of a new kind of science. May I suggest to your daughter to not mention the extraterrestrials' role in all this?

It could alienate reputable scientists, who could show a serious interest in building Jenseitsflugmaschine...”



\*\*\* \*\*



Karl Haushofer

---

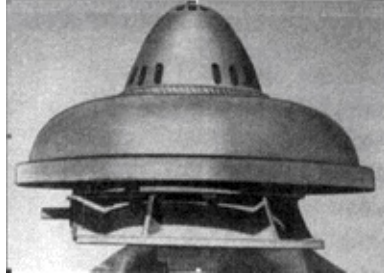

Viktor Schauberger, father of the “Implosion” technology, and  
diamagnetism anti-gravity, which closely resembled Maria Orsic’s technical data received from the  
Aldebaran’s extraterrestrials.

---

### Viktor Schauberger ’s Repulsine

Viktor Schauberger’s legendary Repulsine partially used the levitational power of water, Maria Orsic  
referred to, and based upon technical data she received from the extraterrestrials.

Thirty years later, MIT and Caltech would conduct successful experiments in this field.



---

V iktor Schauberger 's Repulsator.

Believe it or not, MIT and the United States Air Force succeeded in manufacturing a fully operational replica of the Repulsator!!



---

**Notes on Maria Orsic's mind-bending extraterrestrials' technical data**

---

The dossier on Maria Orsic Aldebaran's Technical Data (OLPS-17/AGSP: Orsic Levitational Propulsion System 17/Anti-Gravity Spaceship), and particularity:

- **a** -The section on the use of a certain type of “ Water ” needed as “A propulsion fuel”. (Note: the Intraterrestrials, called by colorful ufologists: “Greys or Greys” in their meetings with our military, told us that some of their “Time-Machines” UFOs use water as fuel.)

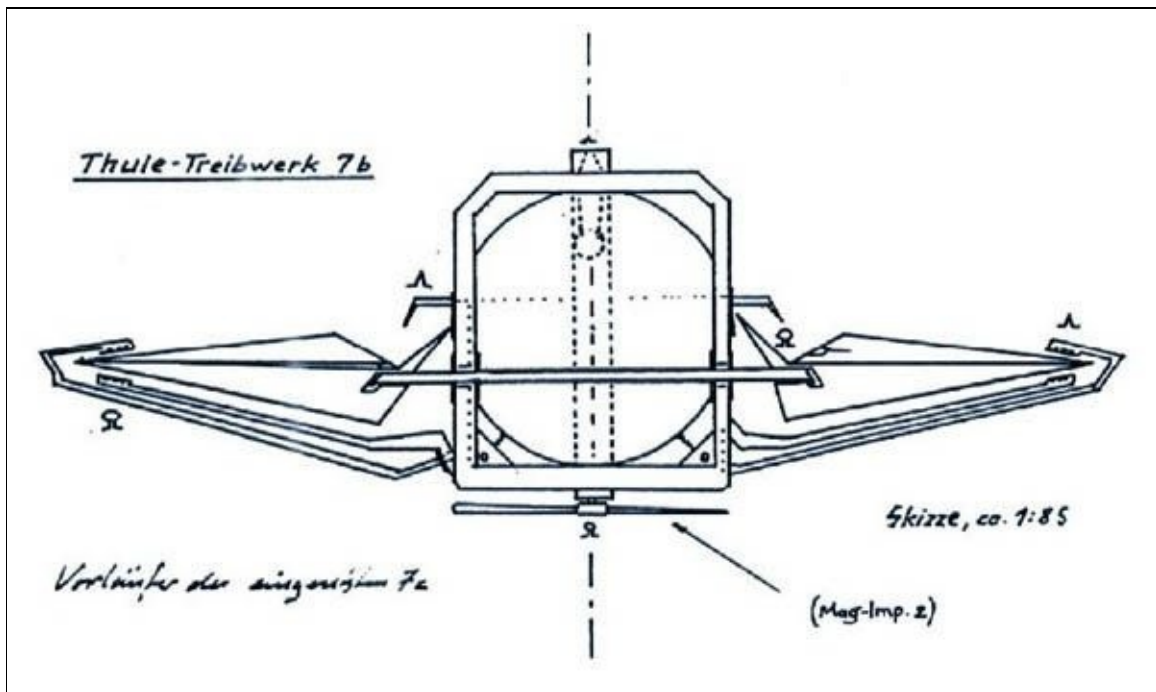

An authentic photo reproduction of a Gray “Grey” (Intraterrestrial alien)

- Maria Orsic’s notes included a fascinating section on water’s “ levitational properties”. Worth mentioning here that in 1932, Viktor Schauberger was able to convince Germany’s most distinguished scientists and obviously Heinrich Himmler that water can be used as a fuel, and his Wunder Wasser did in fact use water-powered motors (Called Implosion Motors ) to propel a certain type of UFOs. This was documented by scientists who were recruited under the umbrella of Operation Paperclip and military scientists who worked for NASA. In 1958 and later in 1963, the United States Air force experimented with the “ Water Vortex ”, -a top secret project-, the use of water as a source of electromagnetic energy and propulsion power for the mysterious underwater unidentified submerged objects ( USO s). And most recently, AUTEK conducted experiments on the aliens “ Corridor-Plama ”, which allows aliens to navigate underwater at an incredible speed (856 miles per hour) and remain undetected by sonar systems and satellites!

- **b** - The centrifugal movement of the Jenseitsflugmaschine before taking off vertically .

- **c** -The theoretical explanation by Professor Winfried Otto Schumann, who is de facto, the acknowledged father of Germany’s UFOs. His Jenseitsflugmaschine gave birth to all the forthcoming UFOs types and classes, including the Rundflugzeug “RFZ”, Haunebu I, II, III, and Vrill flying discs (Seven types).

- **d** -The file AG002/OM22-C; (I don’t know what it stands for!) on the mode of operation blueprints of Germany’s first anti-gravity UFOs.

- e -The “ Implosion Motor ” as renicknamed by the United States Air Force and NASA.

Remain classified to this day (Above Top Secret).

Very very few scientists who left Germany and/or worked with the United States on the development of a fully operational UFO had access to those files, to name a few:

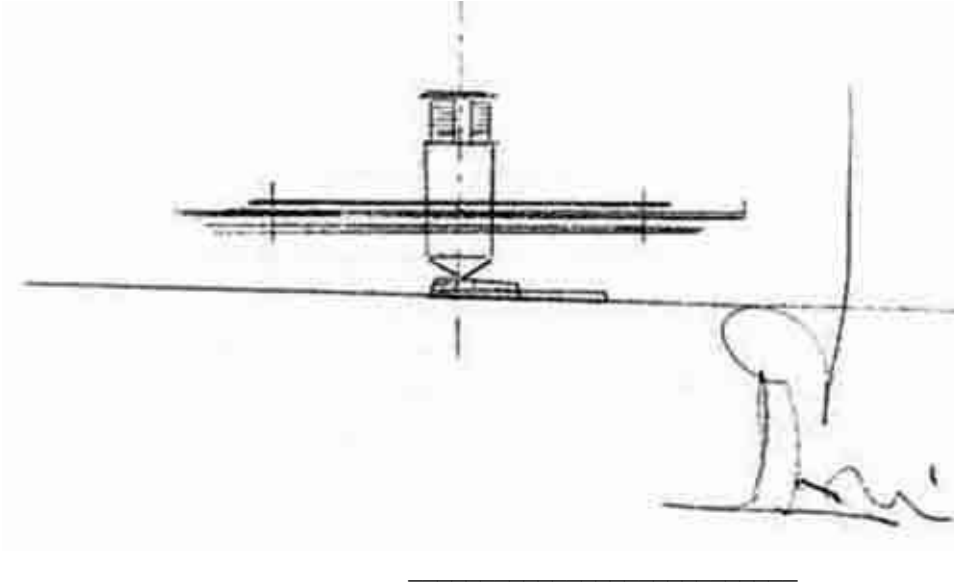

An early sketch  
from Thule.

- Dr. von Braun
- Professor Oberth
- John Frost

\*\*\* \*\*

**March 1922: First prototype of Jenseitsflugmaschine**

---

### **Stargates line; the 33.33 degree:**

Maria Orsic called her super flying machine (UFO to others) a flying machine for another world; a flying machine for the afterlife; a flying machine for another dimension.

Those were revolutionary concepts for her time, or unorthodox “Appellations”, to say the least. In her mind, that flying machine could enter and exit a different dimension, part physical and part abstract, simply by positioning the flying machine on a stargates line she called the 33.33 degree line of Earth.

Dr. Winfried Otto Schumann advised her to avoid implicating aliens in this scenario, and particularly the use of scientific words, since she was not a scientist.

The truth is, Maria never used scientific terminology, for herself admitted that she was not familiar with the technical data she has received from the extraterrestrials of Aldebaran.

**Comparing Maria’s data with Viktor Schauburger and Karl Haushofer data**

Professor Schumann began to change his opinion about Maria's scientific ignorance, when he finally realized that a wonder-flying machine could be built according to the data she gave him; and this made his efforts much easier in convincing his distinguished academic colleagues to take part in the project of building the Jenseitsflugmaschine. He went two steps further and compared Maria's data with Viktor Schauburger and Karl Haushofer data, and to his astonishment, he found out that:

- a-Maria' data was scientifically valid,
- b-The data of Haushofer and Schauburger were not as developed and progressive as her data.

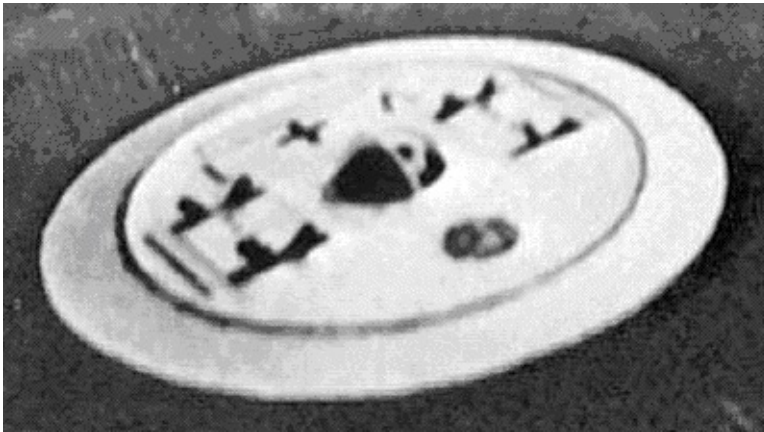

Viktor Schauburger's Jenseitsflugmaschine (JFM).any believe Schauburger's machine was a replica of Orsic's UFO.

Finally in March of 1922 in Munich, the first secret prototype of Aldebaran's Jenseitsflugmaschine (Otherworld flight machine; AfterLife Flying Machine) saw the light.

It looked impressive and "Out of this world". But nobody was hundred per cent sure if this thing could really fly, for first, its design was so strange, bizarre and unconventional, and second, making a machine fly without a combustion engine seemed irrational. A flight-test was scheduled for March 23, 1922.



\*\*\* \*\*



Germany's "First Disc" , based upon Maria Orsic's technical data. See another illustration on the next page.



Artist's vision of Maria Orsic-Professor Winfried Otto Schumann Jenseitsflugmaschine.

Worth mentioning here that the Orsic-Schumann UFO gave birth to all the other types and classes of Germany's discs, including:

Rundflugzeug RFZ-1, Rundflugzeug RFZ-2, Rundflugzeug RFZ-3, Rundflugzeug RFZ-4, Rundflugzeug RFZ-5, Haunebu I, Haunebu II, Haunebu III.

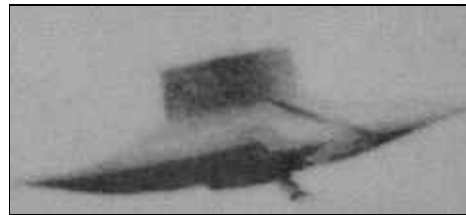

Rundflugzeug  
RFZ-1  
Rundflugzeug  
RFZ-2

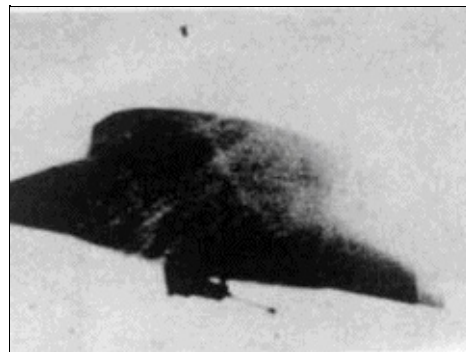
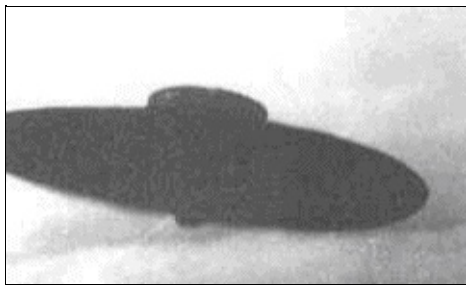

Rundflugzeug  
RFZ-3  
Rundflugzeug  
RFZ-4

Below: Rundflugzeug RFZ-5

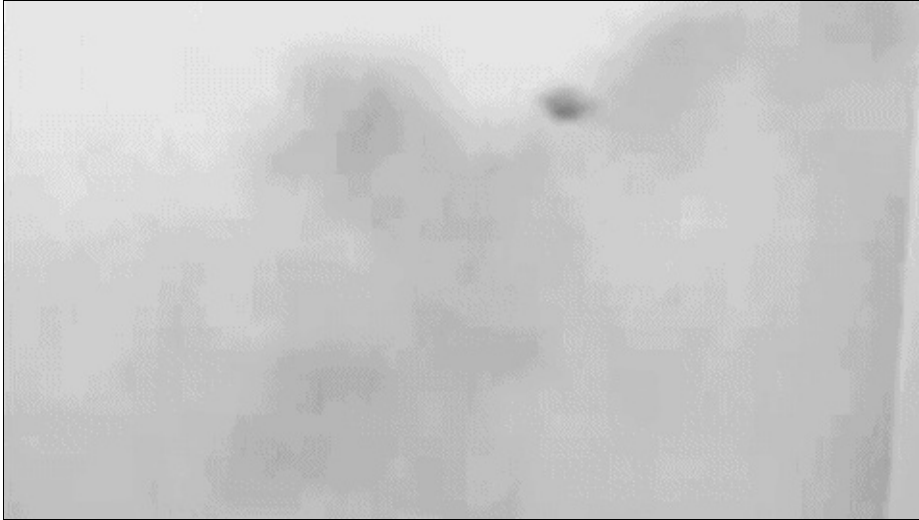

A UFO photograph taken in Hamburg, Germany in March 1918.



The records show that no UFO was ever built in Germany or in any part of the world before 1922.

Here we have two possibilities:

1-Either this photo is fake and ufology's zealots are not aware of this fact,

2-Or these enigmatic machines

were indeed piloted by non-terrestrial entities. Back then, "Greys (Greys)" were not in the picture; they appeared on the landscape of American ufology some 50 or 60 years later.

So who flew these machines?

According to Traute, the beings of Light did. Maria Orsic had no comments on the subject, simply because she never heard of aliens before she began to receive –periodically– messages from another world. As a matter of fact, Maria did not know what or how to call these non-terrestrial beings in the early stage of her communications with the Aldebaran's people. The words "Aliens" or "Extraterrestrials" were never used by Maria Orsic, until she received detailed instructions and mystical messages in her third contact with them.

And to set the record straight, Dr. Schumman was the first to have used the word “ExtraTerrestrials”, and not Maria Orsic!

---

**March 23 , 1922: The first flight-test of Jenseitsflugmaschine**

---

**A fiasco!**

It was a total failure as many have expected. A gigantic fiasco!

Eye witnesses’ reports indicated that the machine blew up after spinning and spinning like fireworks, and the upper layer (Top of the machine) disintegrated, and the lower part (The third level) defragmented like a hand-grenade. Those were the actual words (“disintegrated”, “defragmented”) used by some of the builders of the Jenseitsflugmaschine.

Dr. Schumann was devastated, but Maria never gave hope.

They went back to the drawing board, and began laboriously to reexamine their data. But all their efforts remained in vain. And by now everybody was convinced that it was a crazy idea! Until, three days later, when Maria Orsic rushed to Dr. Schumann’s office with an apparent solution.

She provided him with “Guidance” she claimed she just received from the extraterrestrials.

Dr. Schumann sent her back home, and politely said, “Maria, it was a very exciting project, but gravity is much stronger than any idea I came across. Please go home and forget the whole thing.” Maria Orsic did not argue with him, instead she handed him a few sketches and a series of formulae...and left with a big smile.

### **Yes, it can be done!**

It took Dr. Schumann only two hours to change his mind, “I thought it was useless until I saw something unusual in Maria’s drawings...(We don’t know what he saw in the new sketches) and then I realized that yes, it can be done...” said Schumann.-From Dr. Professor Winfried Otto Schumann’s diary/notes.

Upon hearing the news from Dr. Schumann, Maria was relieved, and for the sake of argument she asked him why did he change his mind?

We don’t know what he said.

However we do know that Maria suggested to him to focus his attention on the “Space-time electromagnetic forces”; another concept totally unknown back then.

**Dr. Schumann could have not solved the problem without Maria’s help!**

---

**Mental command and channeling:**

My personal opinion is that Dr. Schumann did not solve the problem in its entirety without the help of Maria Orsic, for we know for sure that Maria Orsic brought up the subjects of:

- a-Stargates,
- b-The 33.33 degree line,
- c-Space-time electromagnetic forces,
- d-The mental command of the spaceship.

These four items, Professor Schumann was not familiar with, and especially the “Mental Command” of the ship.

By mental command, Maria meant channeling. And I can guess what the reaction of Dr. Schumann was when he heard Maria Orsic talking about MENTAL COMMAND and CHANNELING!!

In fact, the mental command was of a metaphysico-scientific nature based upon very sophisticated aliens’ technology, and which consisted of a magnetic band attached to the forehead of Maria which would allow her to command the craft at distance.

### **Headband Mental Command Device:**

Maria explained to Dr. Schumann that the Jenseitsflugmaschine failed to perform as expected because it did not have her mental command. Dr. Schumann went ape, and threatened to quit.

But once again, he changed his mind when Maria Orsic gave him instructions on how to design and build the “Headband Mental Command Device”.

It was one surprise after another, but he finally complied with Maria’s request. To many of us, this headband thing seems far fetched, a sort of hallucination in the mind of Maria, but it did materialize, and one set was built.

In fact, a similar headband was retrieved from the debris of a crashed UFO near Roswell in 1947 by the United States Air Force, and was sent to General Arthur Trudeau, then, head of the Foreign Technology Desk at the United States Army’s Research and Development Department.



**General Carl "Tooney" Spaatz, left, then, the Air Force chief of staff, and Lt. General Curtis LeMay, USAFE commander, review an honor guard upon Spaatz's arrival at the Wiesbaden Airport, Germany on May 11, 1948. Worth mentioning here that General LeMay was a key player in the American UFO saga cover-up.**

---

General Arthur Trudeau was fascinated by the aliens' gadget and right away, he solicited the help of two scientists to unlock its mystery, and thus, the reverse engineering of alien technology program began.

Later on **General Carl "Tooney" Spaatz became heavily involved with the program.**

This is an absolute fact, no question about it!!!

The "Aliens Transcripts of 1947 and 1948" show beyond the shadow of a doubt that the UFO which crashed near Roswell was mentally commanded from and by a metallic (Unknown alloy) band attached to the skull of the aliens, and their suits which were "glued" to their skin, as part of their bodies were also "animated" by the headband.

The spacecraft of the aliens had no apparent navigation devices and/or dashboards.

The aliens' headband became a major part of the military's alien reverse engineering research/program. The very same headband, Maria Orsic talked about!

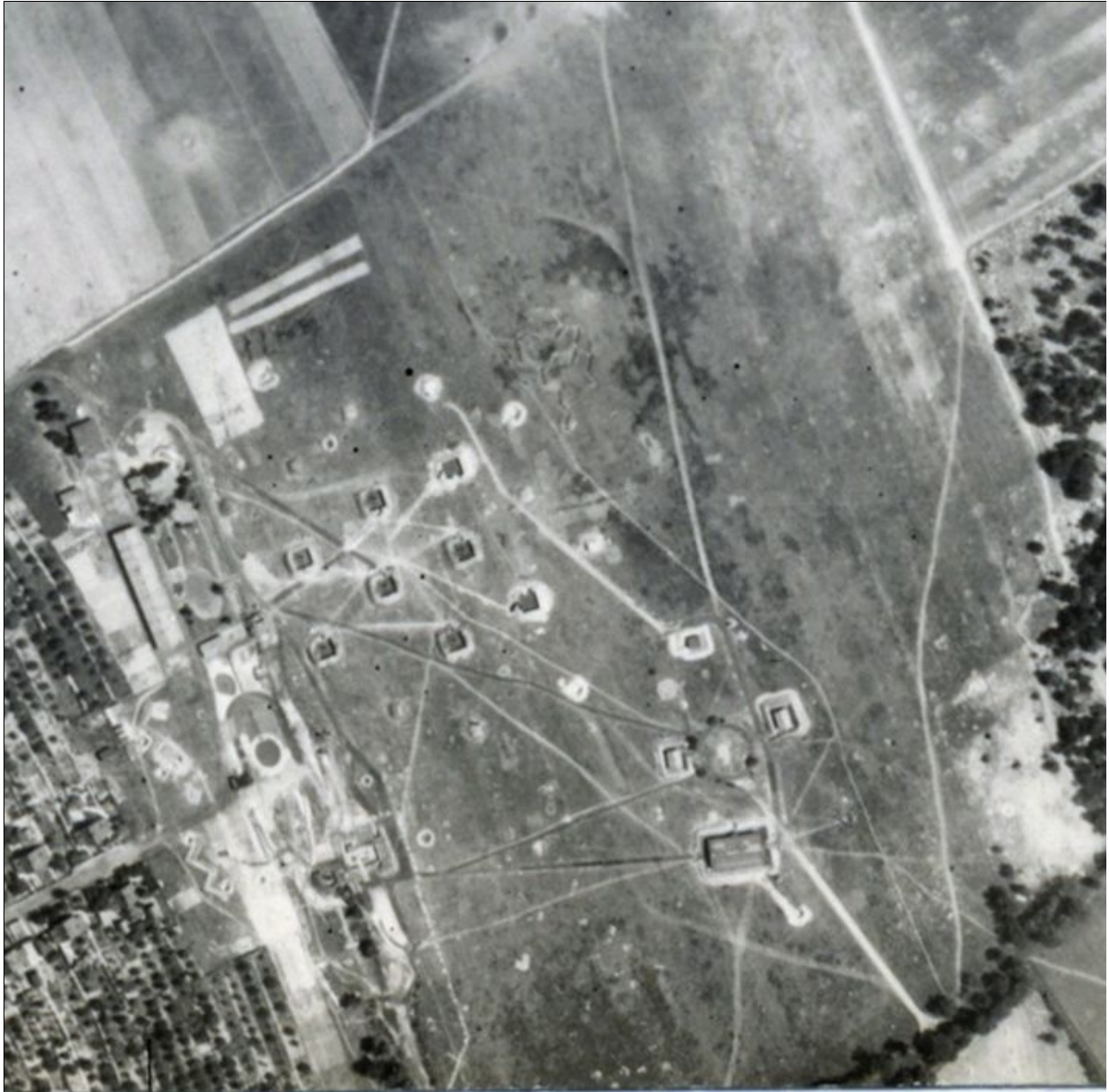

General Trudeau, the father of the reverse engineering of alien technology program.



---

## **A new spaceship is built.**

**December 17 of 1923: A new model of the super Jenseitsflugmaschine came to life**

---

Rebuilding a new spacecraft from scratch was not an easy task.

New material was needed, and it was hard to find. Besides, it was time consuming, and some of the major investors/financiers of the project lost interest, and insufficient funds became a major obstacle, at least in the first stage of rebuilding a new spaceship.

Maria and Ladies of Vril were penniless; money did not mean a thing to them. Maria Orsic earned very little by teaching ballet to beginners and foreign languages to wealthy children.

Her mediumship-channeling séances and services to others were free of charge. And being the oldest in the Society and the leader of her movement, Maria was responsible for the daily expenses of the Vril-Gesellschaft, as well as the welfare of its members.

It was hard time for everybody, except for the wealthy members of Thule and DHvSS who have invested very heavily in the first ill-fated project. Luckily, they did not mind to refinance the new project from A to Z.

And thus, by December 17 of 1923, a new model of the super Jenseitsflugmaschine came to life. And the big day arrived; the day of the second flight-test of the spaceship.

Is it going to fly?

Maria was absolutely confident, but not everybody in the group shared her enthusiasm.

### **Nota Bene:**

Before, during and after the Jenseitsflugmaschine's successful test-flight, Maria and Sigrun made eight consecutive visits to the hangar where the machine was built, and gave their input and channeling findings to the engineers, especially during the initial stage of construction and the channeled flight-test.

Overseeing the construction of the Jenseitsflugmaschine was not the only reason behind Maria and Sigrun frequent visits to the construction site; they needed to become familiar with the facility, in and out, for one

day, Maria and the Ladies of Vril will seize this super flying machine and fly to the stargate of the 33 degree line, where she will rendezvous with the mothership of her friends from Adelbaran.

I tend to believe that Dr. Schumann was aware of that fact, but did not say a word to his colleagues.

Why?

I don't know. It is a mystery to me!

Dr. Schumann was a delightful human being, and had lots of respect and admiration for Maria.

He knew she was an extraordinary woman with high ethical standards, and one of a kind. Maria's farewell to Dr. Schumann showed how much they cared for each other.

\*\*\* \*\*



A reconnaissance aerial photo of the Arado plant in 1944 .

**January, 1924: The first successful flight of Jenseitsflugmaschine**

Note: Read full report on the Jenseitsflugmaschine in my book "GERMAN UFOs: Models & Categories, Engineers & Scientists, Extraterrestrial Messages, Supernatural, Ladies of the Vril, U.S. Link

---



Photo: Sigrun.

It was a very successful and a spectacular test-flight. The spacecraft flew at a speed of 300,000 km/hour.

But the Jenseitsflugmaschine landed after fifty five minutes as an archaic machine, looking like a young girl who suddenly has aged 100 years.

Maria explained this anomaly by referring to what she called “Parallel Zones”.

According to Maria, when an object enters a different dimension, its properties are instantly modified, and in some instances totally altered.

And this applies to humans too.

The damaged Jenseitsflugmaschine terrified all the engineers, but understandably not Dr. Schumann, because by now, he could tap into the inexplicable metaphysical world of Maria Orsic, and understand the occultic-metaphysical aspect of the project.

**Maria: “I am not interested in bombing people and cities.”**

Worth mentioning that Maria’s technical data was used to build other types of UFOs; the most noted one was Vril 7 Geist which was built at Arado-Brandenburg, and flew in 1944. Maria guided the Geist mentally via her channeling abilities; it did not need the headband, Dr. Schumann built for her.

In March of 1944, the engineers who previously worked on the successful Jenseitsflugmaschine asked Sigrun if they could use the Vril Triebwerk in the recently built strategic bomber “E.555”, and Sigrun refused categorically.

Maria reacted strongly and said, “I am not interested in bombing people and cities.”

## Secretly manufacturing two small flying machines

---

Maria Orsic asked Professor Schumann to tell the members of the Thule and DHvSS that the project needed more work and the flying machine was not perfect yet.

Maria had justifiable reasons; she feared that if the fanatic members from DHvSS and supporters of Hitler discover that the spacecraft in its actual condition could be successfully and immediately deployed, they would not hesitate a second to use it as a destructive war weapon.

Thus, based upon Schumann's recommendations, Maria Orsic's Vril was sent to a hangar in Munich, for further improvements, and consequently, all flights ceased temporarily.

At the same time, Maria and Sigrun were thinking about secretly manufacturing two small flying machines with all the flying properties of the big one, in case, something should happen to it, be confiscated by the authorities, or even stolen.

### **Maria Orsic's new two circular crafts:**

- a-OSS records,
- b-CIA Helms' files,
- c-Statement by Dr. Eugene Sanger,
- d-Statement by Major Erich Hartmann,

- e- Statement by Lt. Colonel Walter Horten,
- f-And of course Professor Shumann's own testimony,

Show that de facto, Maria Orsic's two circular crafts, 27 feet in diameter were produced with the help of four retired engineers.

RFC-2 was one of the two small space crafts, designed by Maria, and developed by Dr. Winfried Otto Schumann and four recently recruited engineers. It was elegant, with a shiny metallic surface, made from an unknown alloy; it was this kind of alloy the Russians were extremely interested in, because we know that Stalin's NKVD discussed with Dr. Eugene Sänger how it could be obtained.

RFC-2 was spotted and reported on Sunday 18, March 1945, by Lt. Col. Walter Fellenz, serial number 0-23055 from **the United States Army, 42nd Infantry Division**, 1st Battalion. The sighting was confirmed by Brigadier General Henning Linden.

To this day, nobody knows the properties of the unprecedented alloy of RFC-2 except -as it was leaked out by NASA insiders in 2007-, by a bunch of engineers and metallurgists working for NASA, and especially on the Shuttle's programs.



Dr. Eugene Sänger

---

The alloy research program began y ears ago under the guidance of three German scientists who were recruited by Dr. von Braun for Operation Paperclip, right after the Second World War.

The records show that Dr. Schumann recruited four engineers to develop and build Maria's discs:

- 1 -The first was an engineer/architect who previously worked for *Messerschmitt's* Kokothanki, on the BF 109 G6-14,
- 2 -The second was from Focke-Wulf,
- 3 -The third was from Heinkel,
- 4 -The fourth, from the Bayerische Flugzeugwerke, also known as Bavarian Aircraft Company.

All were carefully and intelligently recruited by Dr. Schumann, because the four scientists had access to material, he desperately needed.

**Story confirmed by Major Hartmann:**

This story was also confirmed by Major Erich Hartmann when he returned to Germany in October 1955, after spending a 10 year sentence in Russia.

The statements of Major Hartmann appeared in the secret files of Richard Helms (a former CIA director in 1970). Helms kept a voluminous file on Maria Orsic.

In 1945, while serving as the United States intelligence chief in Berlin, Helms obtained vital information on Maria and her Vril spacecraft, yet he kept everything buried in his secret vaults for years.

Major Erich Hartmann died on September 19, 1993 at Weil im Schönbuch. He was considered Germany's greatest fighter ace.

General Dwight Eisenhower admitted that Major Hartmann was the greatest fighter pilot of all times.

Hartmann flew 825 missions and scored 352 victories.

Nota bene:

Professor Schumman did not totally abandon the project.

Records show that he continued with the development of new types and classes of UFOs.

\*\*\* \*\*

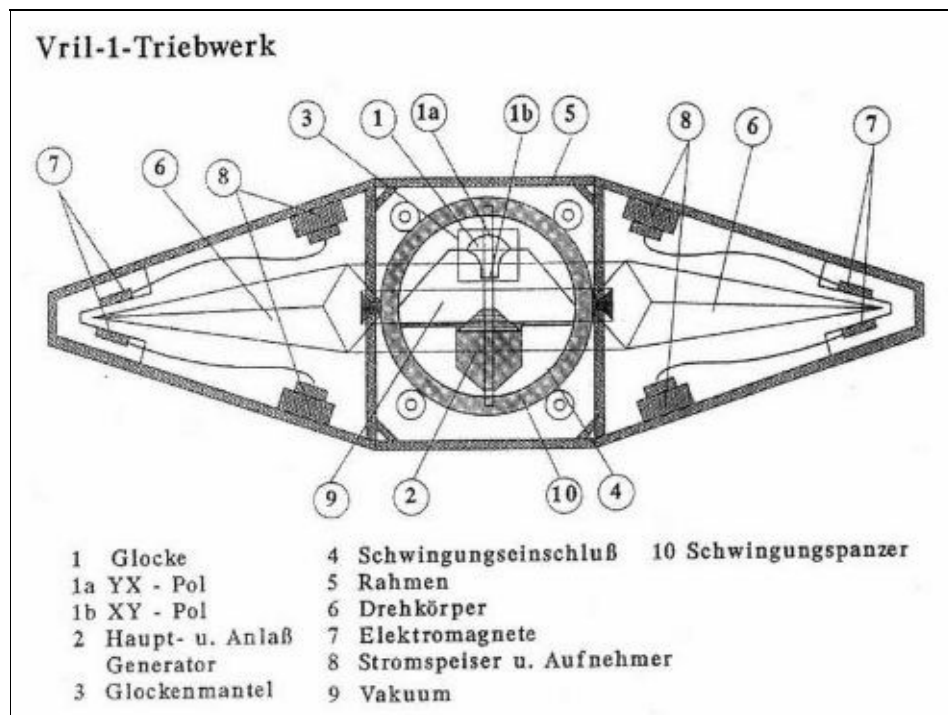

Major Erich Hartmann.



He confirmed that Maria Orsic's two small circular crafts, 27 feet in diameter were built by Dr. Schumann.

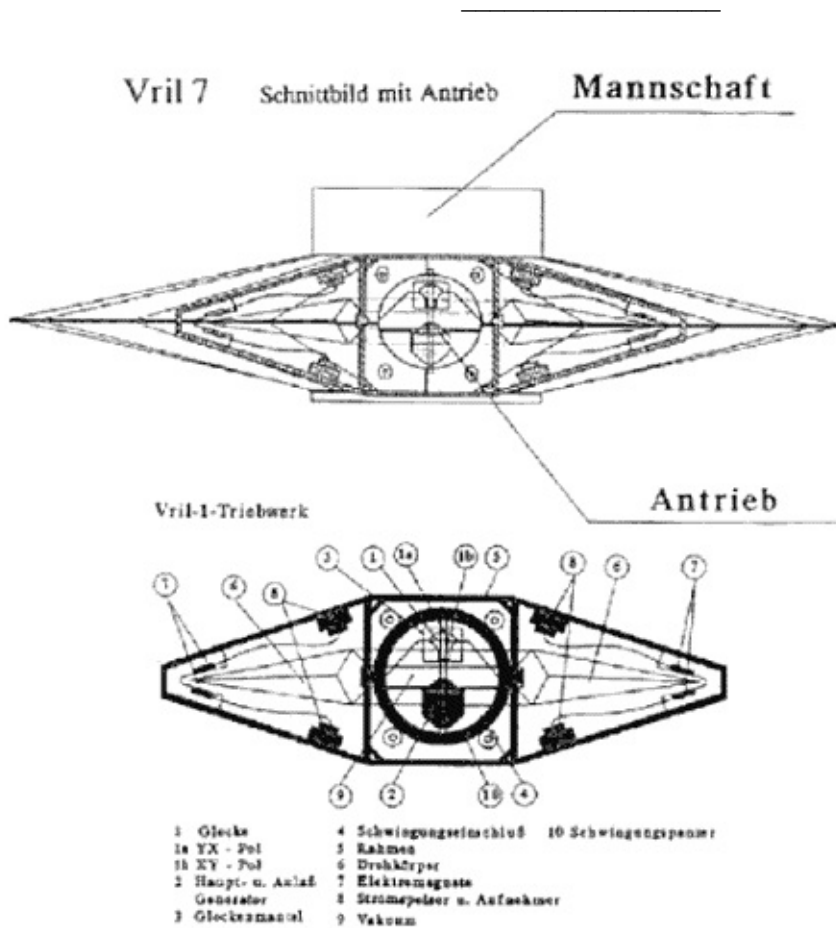

Sketch of the Vril 1-Triebwerk, built upon specifications and technical data provided by Maria Orsic.

Gemeinschaft des Schwarzen Steins



Rekonstruktionsversuch

Durchmesser des Geräts ca. 45 m

Sketch of the Vril 7, built according to Maria's technical data.

Identical data will be used one day, by the Russians to build their own UFO, which flew twice over Siberia



and Leningrad, and inexplicably vanished from the face of the earth.

A Russian UFO.



---

## Early Allies intelligence reports.

Early Allies intelligence reports tell us that:

- 1 -The first German UFOs project was led by W. O. Schumann from the Technical University in Munich. Under his guidance, seventeen disk-shaped flying machines with a diameter of 11.5 m were built.
- 2 -Before the end of 1944, three large UFO VRIL 7 were produced, and made 18 test flights .
- 3 -In 1945, the SS manufactured three different sizes of UFO-bell-shaped.

**The early documented German UFOs:**

**The RFZ 1 (Rundflugzeug 1) UFO.**

According to SS files and Allies intelligence in Berlin and Vienna,

- 1 -The first fully operational German Bell-UFO was manufactured in June 1934.
- 2 -Under the leadership of Dr. Winfried Otto Schumann, the first experimental circular flying machine, the RFZ 1 (Rundflugzeug 1) was developed at Arado's hangars in Brandenburg.
- 3 -Vril society continued the program, and came up with two new versions of a Bell-UFO.
- 4 -The Bell-UFO's SS records and archives fell into the hands of the Allies between 1945 and 1946.
- 5 -Joseph Stalin knew about the SS Bell-UFO archives, and through Marshal Zhukov, asked General Dwight Eisenhower if he could have a copy of the blueprints of the first prototypes of the BELL-UFOs. Eisenhower refused, after listening to General George S. Patton.

It was reported that General Patton was heard saying something like that: "I am not going to let the sons of bitches (Meaning the Russians) touch those files...one day they will use them against us..."



Marshal Zhukov General Patton



Other documents show that :

- 1 -In March of 1945 the UFO VRIL 7 was stationed in Alpenfestung.
- 2 -Before the end of the Second World War, high ranking SS officers, and scientists fled to a secret base in South America, and to underground German military bases in Neuschwabenland.
- 3 -Four days, before the war ended, the UFO VRIL 7 left Germany en route to Japan, without leaving any trace.

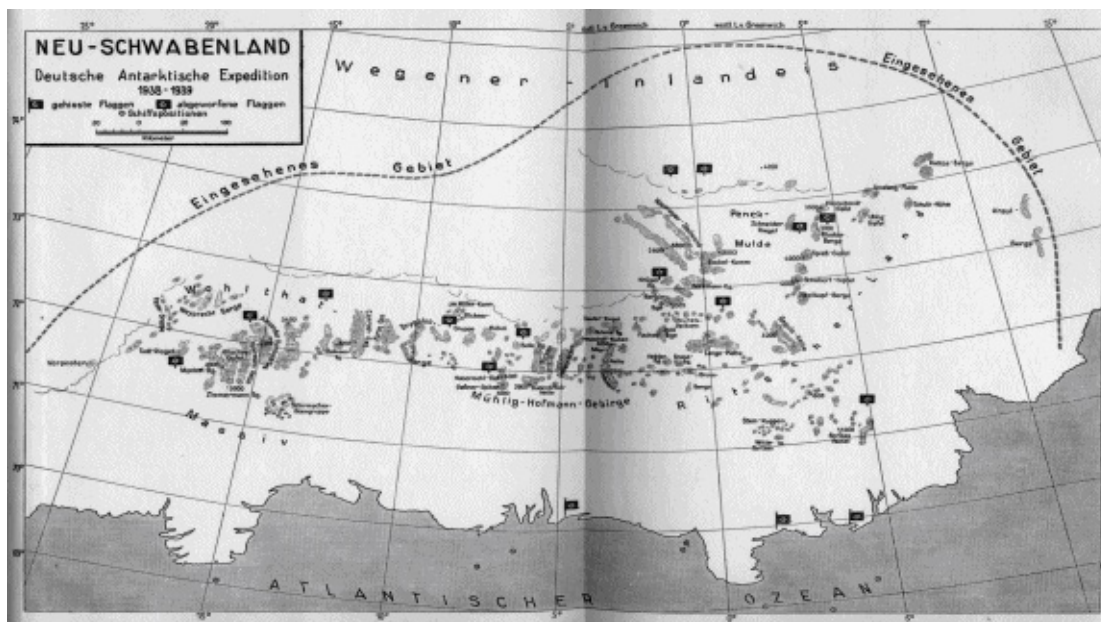

Alpenfestung S. 240: Map of the secret route.



Neuschwabenland, the last German colony.



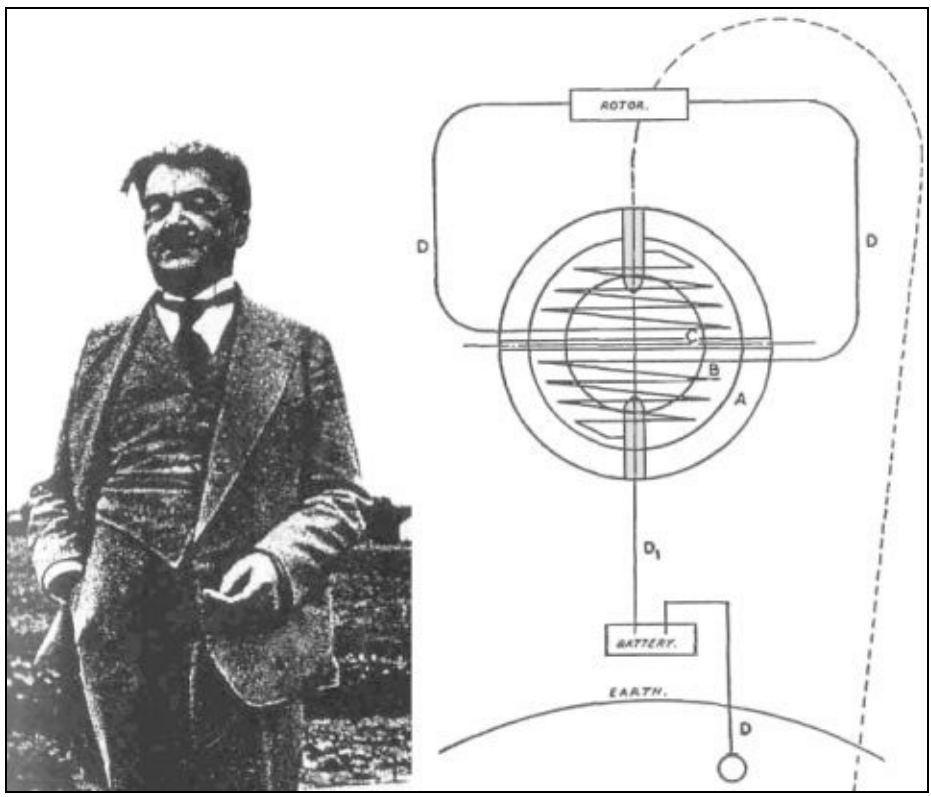

## SS General Hans Kammler.

SS General Hans Kammler was in charge of the German UFO-Bell program development in occupied Poland. Years earlier, he met with Maria Ostric on three occasions.

This was confirmed in SS secret files captured by Allied intelligence and reported to the OSS. It was also reported that Maria Ostric refused to collaborate with Kammler.

Some believe that he got rid of her in 1945, a few weeks before the collapse of Nazi Germany.

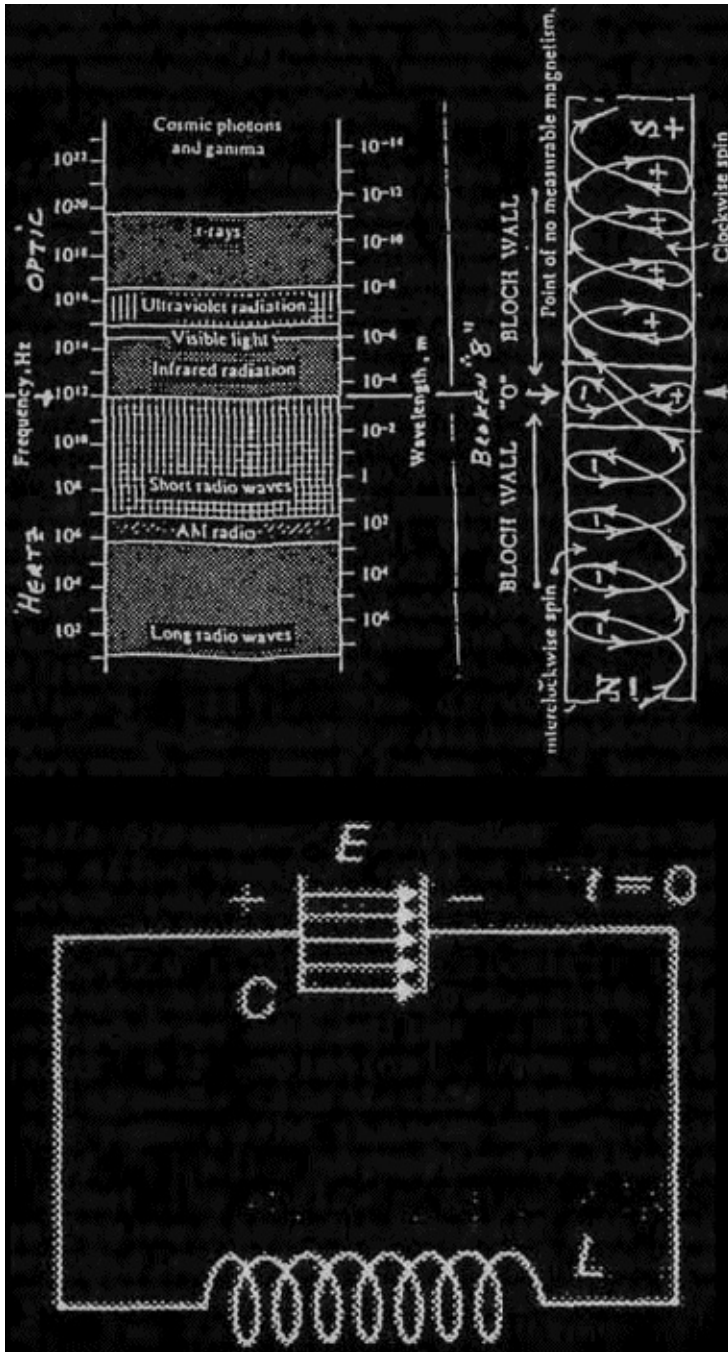

Austrian Karl Schapeller had conducted successful experiments with Vril.

Karl Schapeller's Device, (Right):

- Steel outer casing.
- Special ceramic lining in which tubes are embedded.
- Hollow centre, filled with glowing magnetism when in operation.
- Tubes, circuit and earthing.

\*\*\* \*\*

Hermann Goering, head of the Luftwaffe.

Hermann Goering was convicted of war crimes and sentenced to death by the Nuremberg Tribunal. He escaped hanging by taking cyanide the day before his execution. He never believed in Maria's extraterrestrial messages.



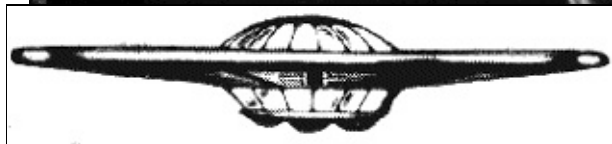

Sir Roy Fedden

---

**Sir Roy Fedden on Maria's "secret design":**



Field Marshal Hermann Goering thought that Maria Orsic's super flying machine will have no impact on the outcome of the war. My sources tell me that Heinrich Himmler fed him wrong information, intentionally, because he did not want Maria Orsic's plan to succeed.

Yet, Sir Roy Fedden, the Chief of the Technical Mission to Germany for the Ministry of Aircraft Production was absolutely convinced that Germany's wonder-weapons (Referring to the Maria's spacecraft and to the other Bell-UFOs classes) could have altered the results and consequences of the war, if the Third Reich succeeded in prolonging it.

In 1945, he stated verbatim, "I have seen enough of their designs and production plans to realise that if the Germans had managed to prolong the war some months longer, we would have been confronted with a set of entirely new and deadly developments in air

warfare."

Dr. Heinrich Richard Mieth, Dr. Herbert A Wagner, Dr. Eugen Sanger , Hanna Reitsch, Lt. Colonel Grigori Tokaty, Brigadier General L. C. Craigie, William Donovan, Dr. Arthur Rudolph, Dr. Herman Oberth, Lt. Colonel Walter Horten, SS General Hans Kammler, General Jakob Sporrenberg, Professor Dr. Winfried Schumann and a fleet of German scientists, ALL acknowledged that Maria Orsic's spacecraft and other UFOs discs gave birth to a new generation of UFOs, including:

- **a** -Haunebu (I,II,III),
- **b** -Me 163,
- **c** -UFO VRIL 7
- **d** -Arthur Sack's circular flying machine
- **e** -Horten 229
- **f** -DM-1
- **g** -The legendary Andromeda.

My sources tell me that Dr. von Braun was one of the leading scientists who continued to work on the BELL-UFOs and other types until the collapse of Germany.

\*\*\* \*\*

### **Different types and shapes of Germany's UFOs**

All originally based upon Maria Orsic's technical data

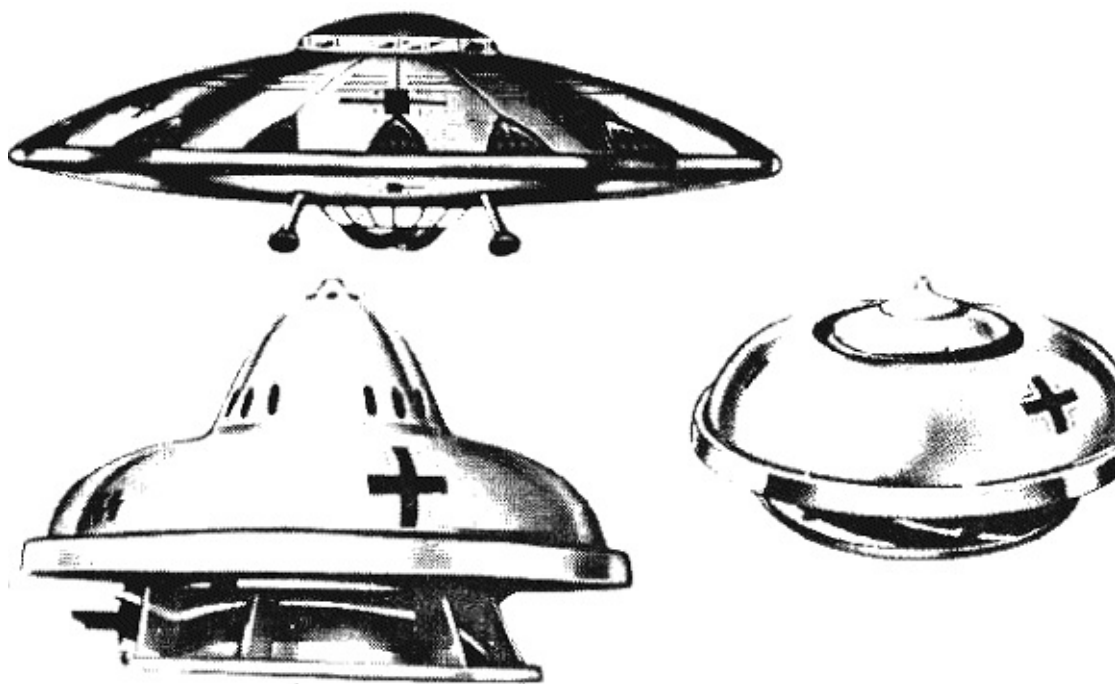



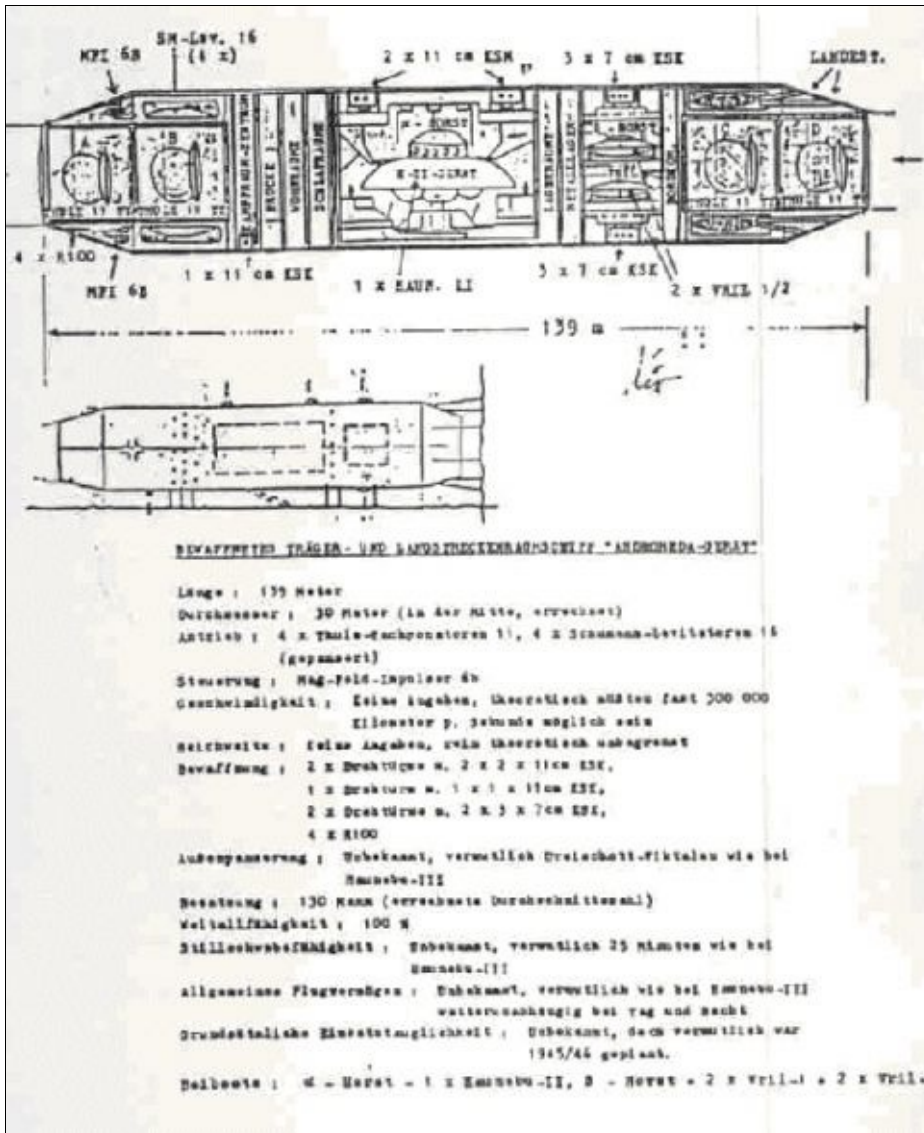

Arthur Sack's circular flying machine prototype, phase 2.

Arthur Sack's circular flying machine.

The original Horten 229 flying wing invented by the Horten brothers, unloaded by the United States army in 1945.

The German Me 163 UFO prototype.



The Me  
163 B  
UFO,  
phase  
2.

G  
erman  
officers  
in front  
of UFO



Haunebu I.

Above and below: German Patent of a Nazi UFO registered under number 2,147,668.

The German UFO (Disc) was initially developed by Dr. Heinrich Richard Miethe, based upon Maria Orsic

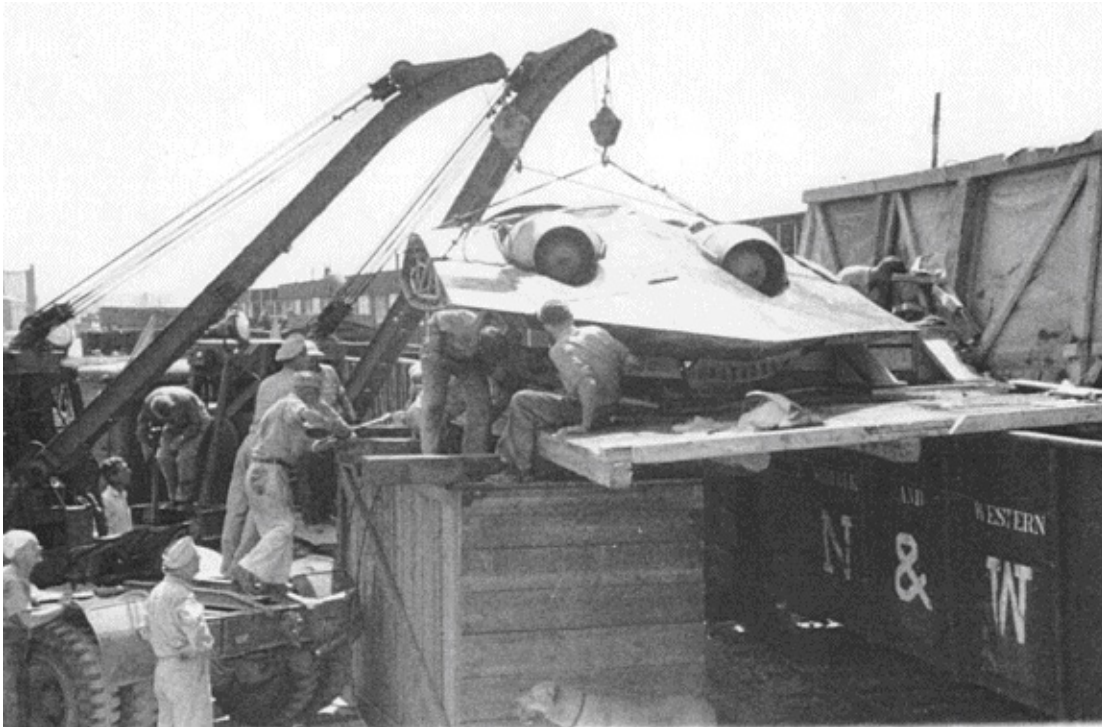

instructions, found in General Eisenhower Special Task Force file.

Dr. Alexander Lippisch confirmed this.

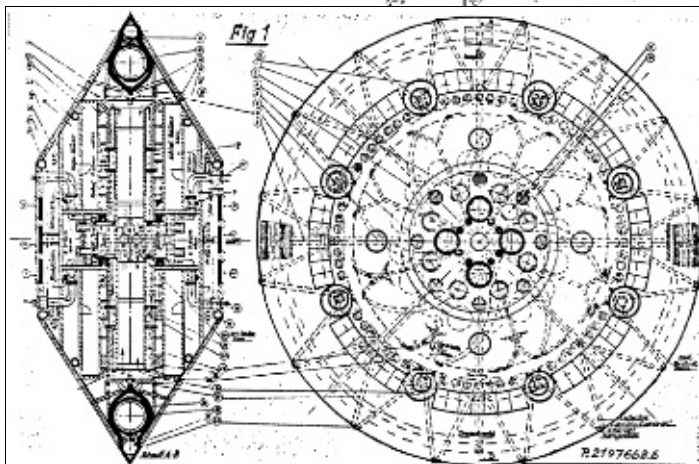
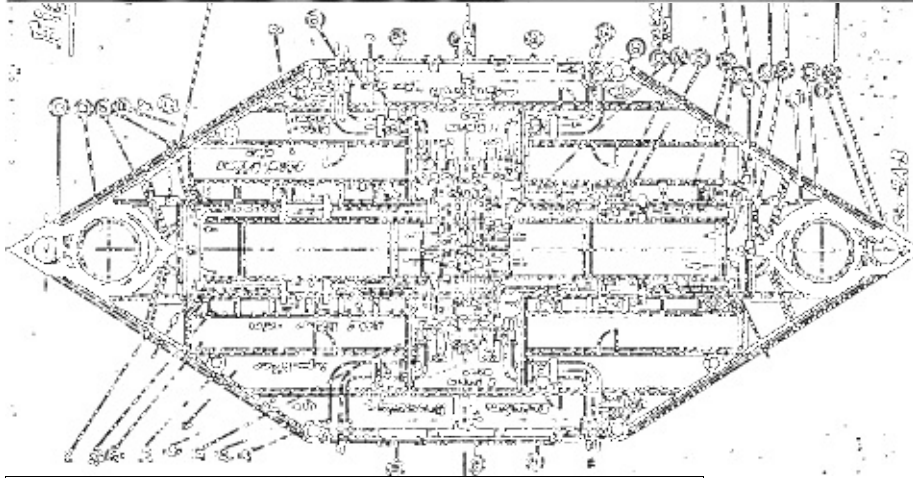





Dr. Alexander Lippisch.

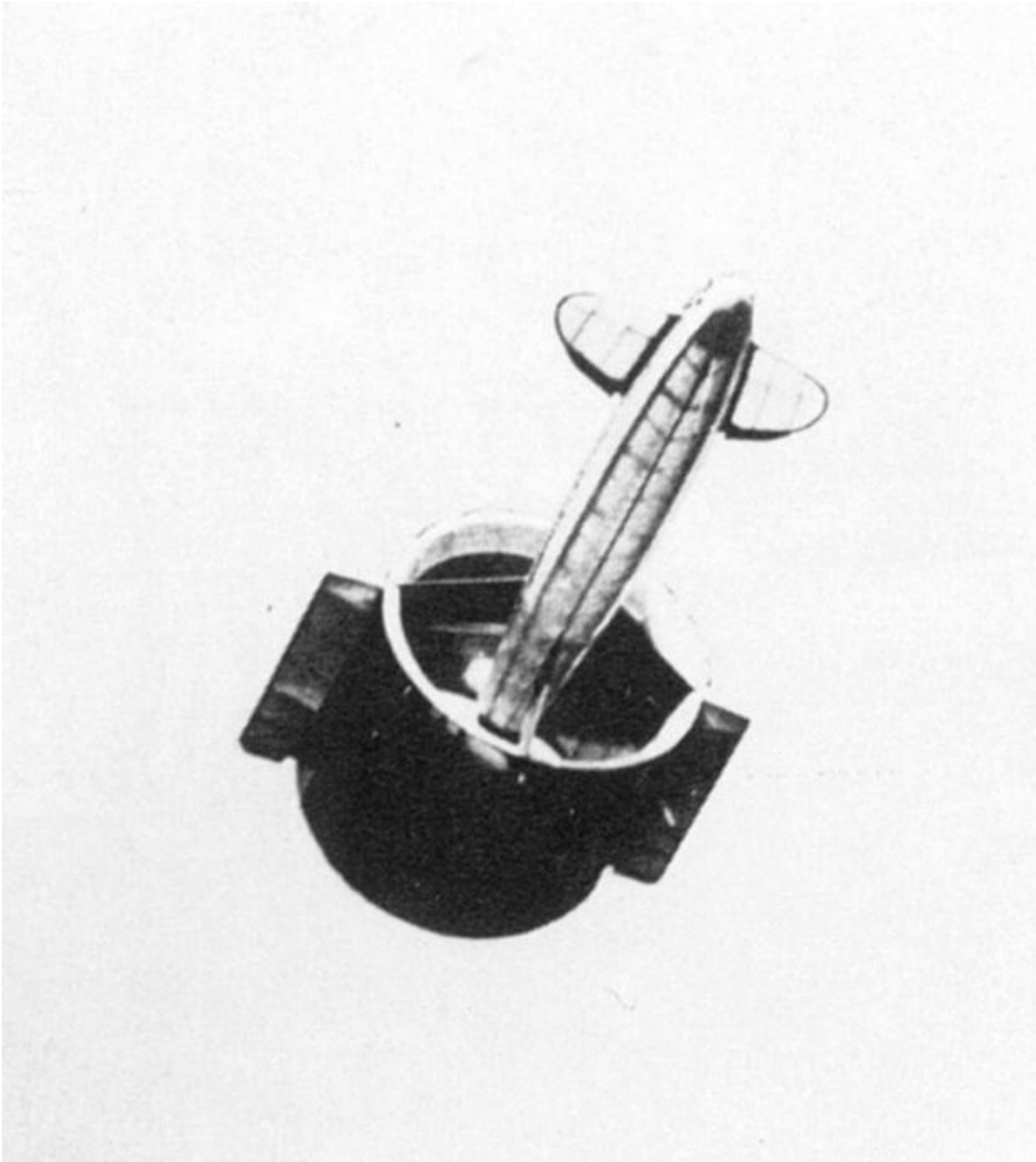

Alexander Lippisch Delta Wing plane (DM-1) was captured by the United States army.

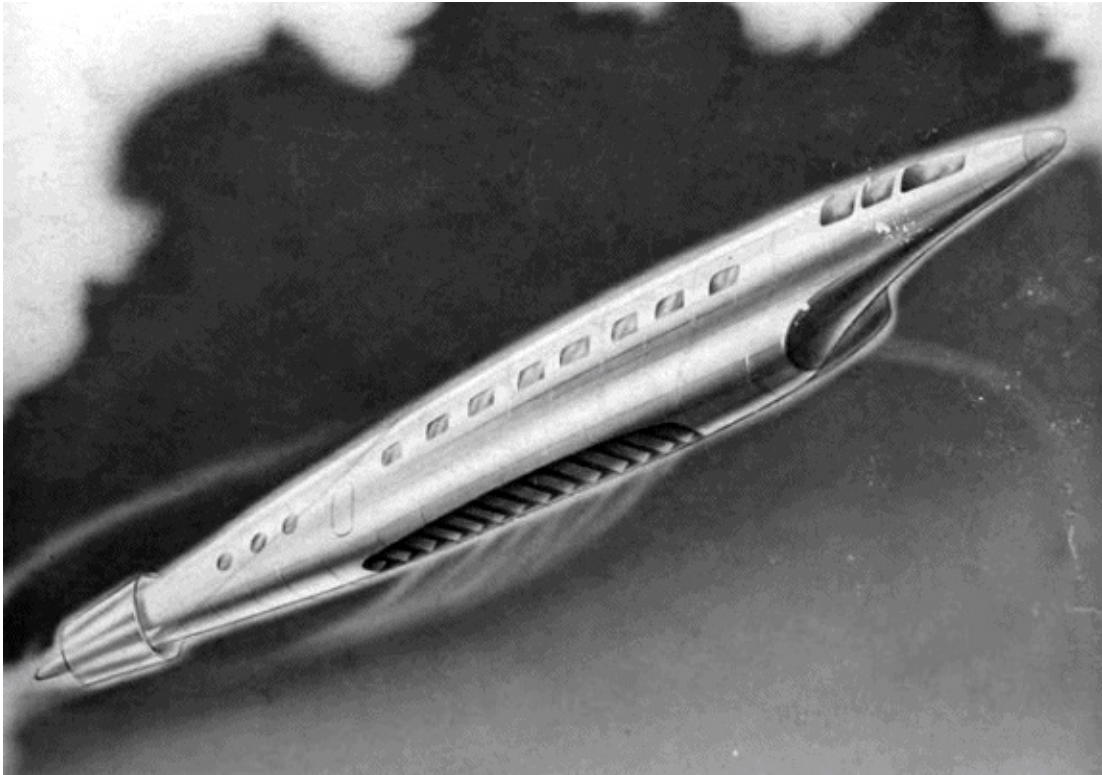

Lippisch aerodyne, tested during the Second World War.

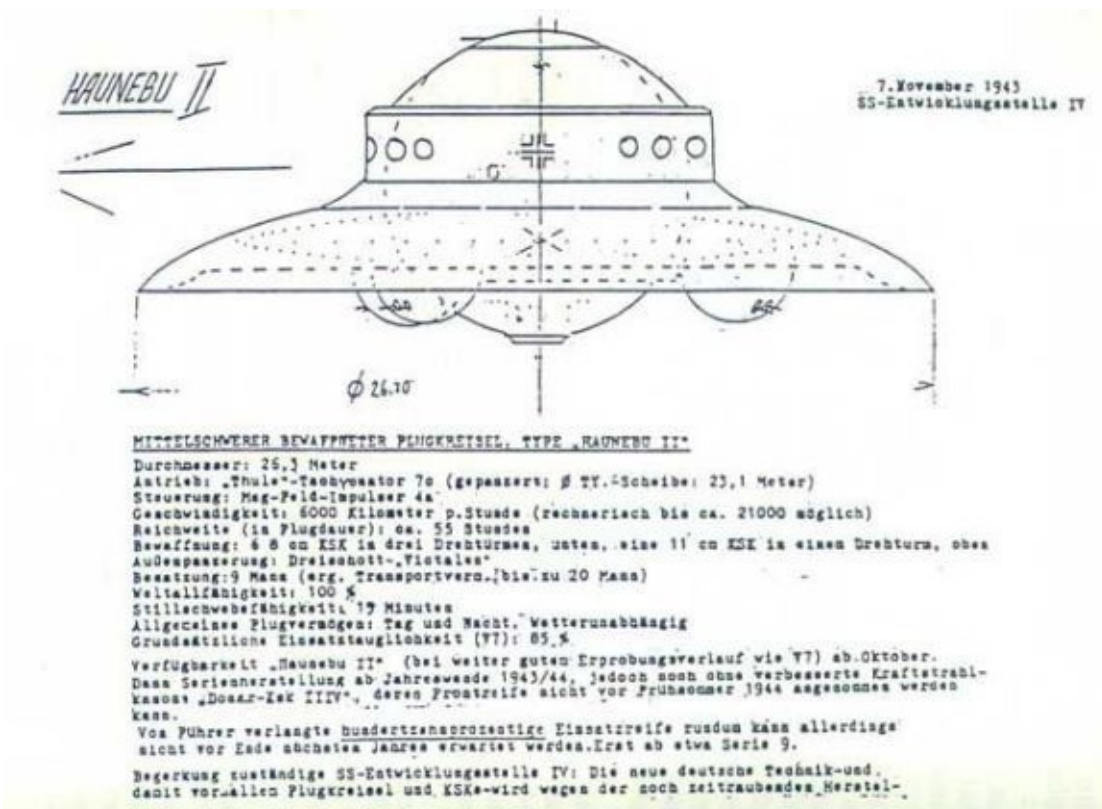

Lippisch's futuristic design, based upon metaphysical-extraterrestrial messages given to Maria Ostric.

Records show that the scientists who worked with Maria Orsic, planned on building the 145 meter Raumschiff, also called by some the Andromeda-Gerät.

Others have said that the Raumschiff was something else, because its cigar shape did not correspond to the circular shape of Maria's mothership.

We also have some contradictory information about the location of the facility where it was built. One account tells us that it was constructed at Arado, yet, another account says that it was constructed at a Zeppelin hangar. However both accounts revealed that it could accommodate a Haunebu IV and two Vril 2 crafts.

Are these two crafts the ones Maria secretly built with the help of four engineers, Dr. Schumann recruited? And were these two crafts, the small circular UFOs which took Maria and Ladies of Vril to the 33.33 degree stargate line, where the Aldebaran's mothership was waiting for them? Absolutely!

No question about it!!



Sketch and technical data of Haunebu II.

It was originally built according to Maria Orsic's technical data that she has received from the Aldebaran's extraterrestrials.

However, the SS modified the specs to fit the installation of guns, by an order from Himmler.



The RFZ first flight test.



The Haunebu II in February 1944.

### **1945: Getting out of Germany**

**Aldebaran's instructions to Maria to get out of Munich**

---

In March of 1945, Maria Orsic abandoned her mission, for she had received extraterrestrial messages predicting the defeat of Nazi Germany before the end of 1945, and instructions from the Aldebaran's messengers to get out of Munich and fly to the 33.33 degree station line, where their mothership will pick her up.

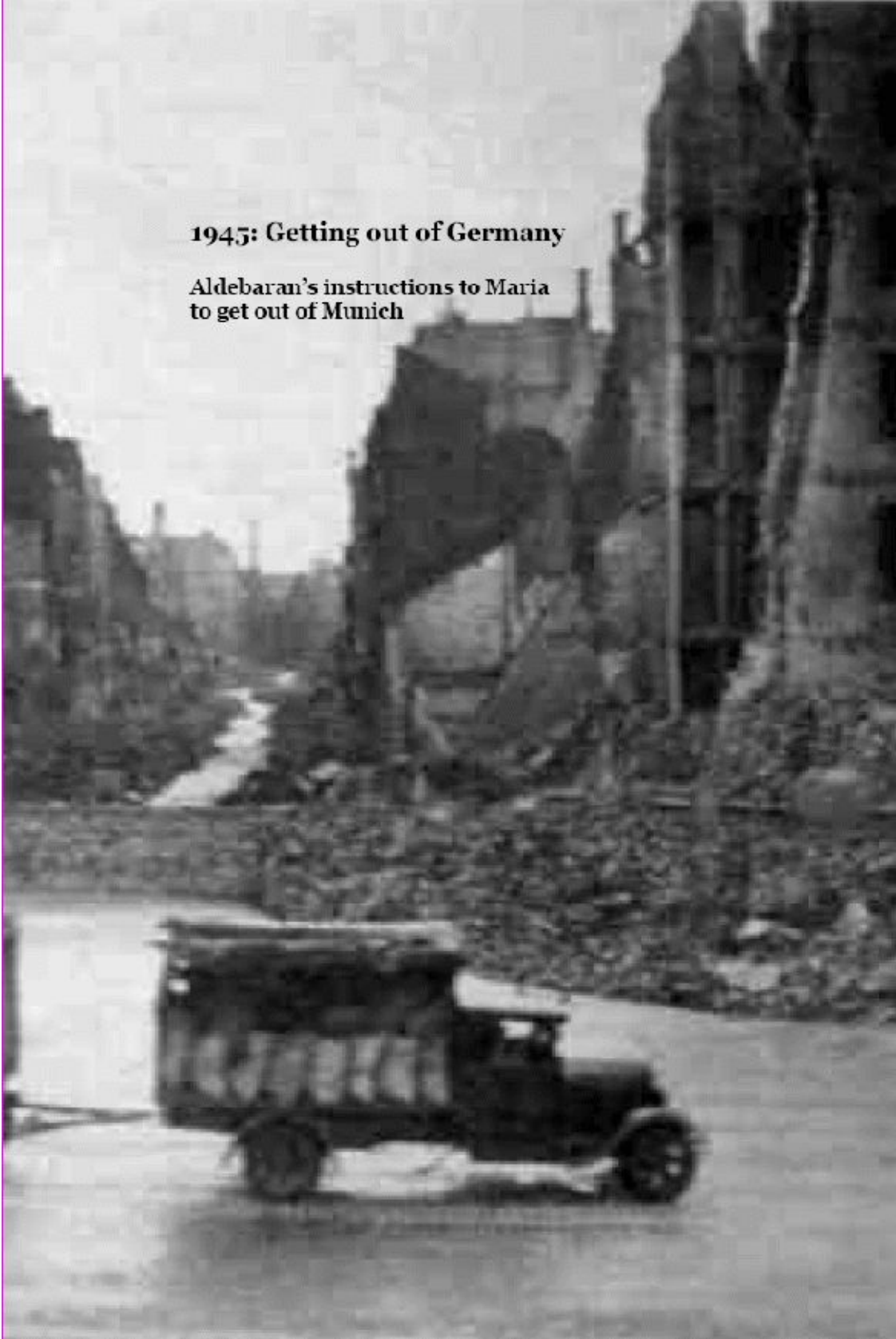

**1945: Getting out of Germany**

**Aldebaran's instructions to Maria  
to get out of Munich**

Maria  
told  
the  
Horten

brothers to get out of Germany as soon as possible, and explained to them how and when Germany will



loose the war, and Maria also predicted the suicide of Hitler, and the Soviet domination over the entirety of Eastern Europe.

The Hortens believed her and historical records show that they fled Germany to Argentina in 1945. The Hortens advised Maria not to talk about it in the presence of SS officers, for they will think she is a traitor and will shoot her on the spot.

However they did advise her to

warn a few civilian scientists who have worked with them on the Horten 229. And Maria did.



Gudrun Burwitz, Himmler's daughter never forgave Maria Orsic upon learning what she knew and what she did. On that event, the daughter of Goering remained quiet, however she did confess to a confidant that her father Herman Goering already knew about the inevitable defeat of Germany, but he was not very much alarmed, because he sincerely believed that he could negotiate some kind of a deal with the Americans.

He was mistaken.

#### **Maria's message to Magda Goebbles:**

Inge Schulz , one of Maria's associates who had a direct access to powerful figures in the military hierarchy, managed to reach Magda Goebbles, the wife of Josef Goebbles and delivered what she later called "Message of Escape".

She told Magda Goebbles about the vision of Maria, and Maria's sincere concern for the lives of her daughters.

Unfortunately, Mrs. Goebbles did not believe her, and the rest is history. Magda and Josef Goebbles before committing suicide asked Dr. Helmut Kunz to poison their six children.





Magda Goebbles with her daughters.

---

**Account of Erna Flegal, Hitler's personal nurse:**

This story was told by Hitler's personal nurse, Erna Flegal (A Red Cross nurse at the Reichschancellery) who remained in Adolf Hitler's bunker, right before he committed suicide, and until the Russian soldiers entered the bunker.

Erna Flegal loved Mrs. Goebbles.

The statement of Ms. Flegal was documented in the transcript of her interrogation by military intelligence interrogators in Berlin, in November 1945, and confirmed by Traudl Junge, Hitler's secretary.



Traudl Junge, during the Second World War.



Traudl Junge in 2002.

In 2002, Mrs. Junge told me: “We did receive a message from Maria Orsic, and it was delivered to Mrs. Goebbles by Inge Schulz... Bormann read it first...”

Both Flegal and Junge stated that an urgent message from Maria Orsic was delivered to Mrs. Goebbles, but unfortunately nobody took it seriously.

Rochus Misch, who worked as a telephone operator in Hitler’s bunker also reported that a message from Orsic was sent to Mrs. Goebbles.

Magda told Erna Flegal about Maria’s message, and added that Maria had a way of getting her out of Berlin with her daughters, by some sort of a new type of airplane she had at her disposal.



Magda Goebbles

---

Erna Flegal immediately replied, “Please madam, leave right now...take the children and go...” Magda replied: “I belong to my husband. And the children belong to me. I can’t leave Joseph...”

Erna Flegal said, “She broke my heart, because I was very fond of her, she was an extraordinary woman, a brilliant woman, on a far higher level than most people, and I loved her children... they were charming. They would have delighted anybody.



Martin Bormann (Hitler's private secretary) knew about Maria Orsic's spacecraft.

---

Erna Flegel, Hitler's nurse, left in 2005, right in 1933.

---



They should have been allowed to live. They had nothing to do with what was going on around them. Not to spare the children was madness, dreadful...I didn't like her husband because he cheated on her all the time. In fact, nobody liked Goebbels."

Flegel continued, "The next day Hitler shot himself, there were a few people who heard the shot. Others didn't...the remaining staff then had to decide whether to stay or not to stay.



Erna Flegel with Adolf Hitler.



Richard Helms (a former CIA director in 1970).

Helms kept a voluminous file on Maria Orsic. In 1945, while serving as the United States intelligence chief in Berlin, Helms obtained vital information on Maria and her Vril spacecraft, yet he kept everything buried in his secret vaults.

---

I knew that Hitler was dead because there were suddenly more doctors in the bunker. I didn't see his body. But it was taken up to the chancellery garden and burned. And then I began to hear about Orsic's mysterious airplane... two SS officers were talking about it, but I did not hear everything. Martin Bormann (Hitler's private secretary) knew what they were talking about, and I remember very well what he said to them, something like "It (Maria's airplane, more precisely as I think, one of Maria's early prototypes) is not very far from here...we can fly to Austria, but I was not interested in what Bormann was talking about, because I kept thinking about the children and Dr. Helmut Kunz, who injected the children with poison..."

Erna Flegal's testimony remained classified and secured in Richard Helms (a former CIA director) vaults, and who in 1945, was the United States intelligence chief in Berlin.



Soldiers of the Red Army

displaying the dead bodies of the daughters of Josef Goebbels, poisoned by Dr. Helmut Kunz. Maria Orsic tried to prevent this unnecessary tragedy from happening, but nobody would listen to her. The once upon a time a respected and trusted medium, Maria Orsic became a persona non-grata in the eyes of Himmler and his henchmen.

Russian military looking at the charred bodies of Josef Goebbels, his wife Magda and their children who were poisoned in Hitler's bunker.

Maria Orsic sent a messenger to Magda Goebbels to let her know that the Russians will capture Berlin and reduce the city to ashes, and thus she should leave Berlin with her children before it is too late. Getting out of Berlin was the only way to save her life and the lives of her daughters.

But Mrs. Magda Goebbels either did not believe Maria Orsic, or her loyalty to Adolph Hitler and the duty of standing by her husband till the death prevented her from leaving Berlin.



Adolf Hitler with his god-daughter Edda Goering, daughter of Goering, held by her mother Emmy. Hermann Göring's wife Emmy and Edda survived the war. Emmy died June 6, 1973.

Edda is still alive, and currently living in South Africa.

Left: Edda with her father Hermann Göring.







The end of Germany.



Munich...destroyed by Allies' bombings, few weeks after the departure of Maria Orsic.

**Another astonishing message from Maria Orsic:**

**Maria's letter to Cardinal Michael von Faulhaber**

Note: Part of this story was told to me by Leni Riefenstahl in Munich in 1972.

---

Cardinal Michael von Faulhaber was the Archbishop of Munich in 1945. Quite often, he spoke publicly against Hitler and the SS. Three days after he passed away in 1952, a Catholic nun found a letter in his papers left in his desk's drawers, written by Maria Orsic, and dated Tuesday 7, March 1944.

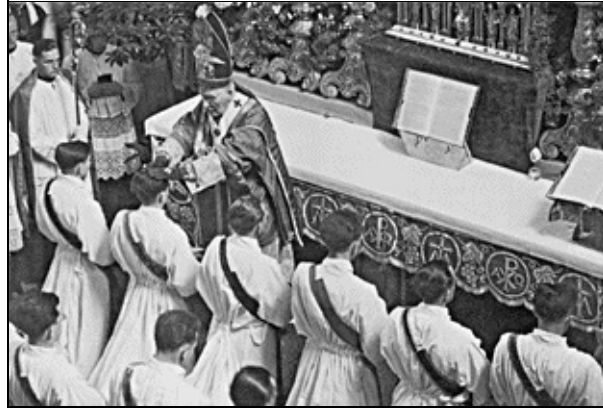

Cardinal Michael von Faulhaber, Archbishop of Munich during NAZI Germany.

---

Maria's letter is of an extreme importance, for four reasons:

1- She predicted that Joseph Ratzinger will become Pope. Worth mentioning here that Joseph Ratzinger was ordained priest by Cardinal Michael von Faulhaber on June 29, 1951, six years after Maria had left Munich.

In her letter, Maria Orsic asked the Archbishop to remind Father Ratzinger to reveal the truth about Mary Magdalene, once he is the Holy Father in the Vatican.

In fact, Father Joseph Ratzinger was elected Pope on April 19, 2005, and chose the pontifical name Benedict. Thus he became Pope Benedict XVI.



Cardinal Michael von Faulhaber laying hands on the head of Joseph Ratzinger, the future Pope Benedict XVI, on June 29, 1951.

---

2 - Maria's letter contained the drawings of a rosette surrounded by two scorpions. This is quite extraordinary because a rosette surrounded by two scorpions represented the symbol of Inanna, the Anunnaki goddess who according to the Sumerian epics, took part in the creation of the first human beings in Mesopotamia.

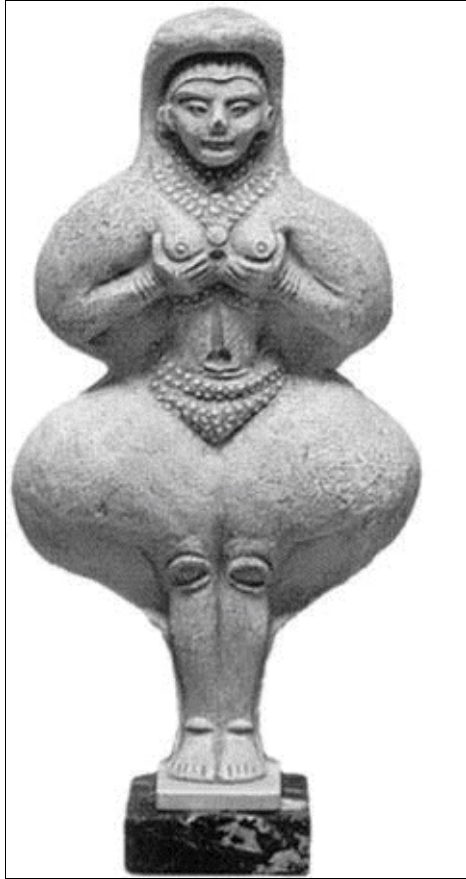

Sumerian Scorpions and Rosette, circa 3300 B.C. Gawra period. Stamp seal.

The cylinder represents Inanna's symbol, which is the eight-pointed star or rosette.

**Inanna, one of the Anunnaki goddesses who created the human races some 65,000 years ago .**

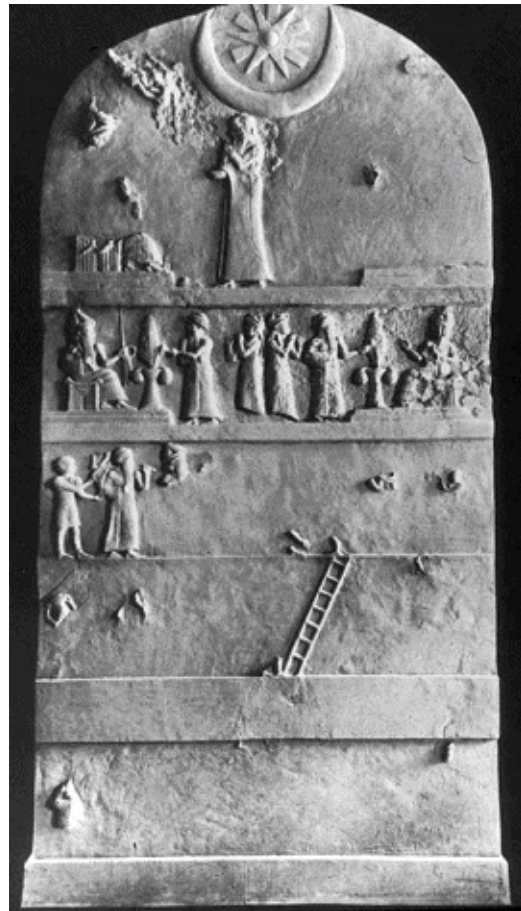

Inanna, Anunnaki goddess in the Babylonian myths.

Identified as Astarte, Ashtaroot and Ishtar in the Uragitic and Phoenician literature.

---

**3** -Maria's letter contained a small drawing of a star surrounded by a crescent (Half-moon); this is also extraordinary, because a star surrounded by a crescent was one of the symbols of the extraterrestrial Anunnaki.

It appeared on numerous Mesopotamian slabs and clay tablets.



The stele of Ur-Nammu, circa 2200 B.C. On the very top, the star surrounded by a crescent, Maria drew in her letter to Cardinal Michael von Faulhaber.

**4** -On the left corner of the letter, Maria wrote down the number 33.33, which represents the Aldebaran's extraterrestrials point of rendezvous with Maria.

What was she trying to tell the Archbishop of Munich?

What kind of relation did exist between Maria Orsic, a non-Catholic and a mystic rebel and the Archbishop?

These two questions remained unanswered to the present day. However, we do know that Maria met with Cardinal Michael von Faulhaber in Munich on three occasions:

- Wednesday 13, January 1943
- Tuesday 4, May 1943
- Thursday 24, February 1944

**What Maria Orsic told Cardinal Michael von Faulhaber about the extraterrestrials, God and religions.**



Photo: Cardinal Michael von Faulhaber.

Cardinal von Faulhaber and Maria discussed several subjects, including but not limited to the medical experiments of Dr. Rascher, the detention of 2,345 Catholic priests at Dachau, outside Munich, and Maria's extraterrestrial messages about religions, the nature of God and the origin of Man.

The Cardinal's fascination with Maria Orsic's psychic and channeling abilities, prompted him to ask her if she would set up a séance to communicate with the spirit of **Franziska**

**Streitel**, the Franciscan nun who died in 1911.



Politely, Maria Orsic told the Cardinal that she communicates only with extraterrestrials; however she will be glad to discuss with him what the Adelbaran's beings of light told her about God, religion, the extraterrestrial civilizations on Earth, and the salvation of the human race.

The Cardinal was so eager and anxious to hear what Maria could possibly tell him about God, Jesus Christ, earth's religions and particularly Christianity. And Maria obliged.



Rabbi Israel Zolli, the Chief Rabbi of Rome.

He was baptized in the Basilica of St. Mary of the Angels by Msgr. Luigi Tralia. Rabbi Zolli was considered one of the world's leading authorities on the Bible, Torah, Talmud and Jewish Scriptures. He served as the Chief Rabbi of Trieste for 35 years. Many, including Reverend Arthur B. Klyber, a Hebrew Catholic priest (An Orthodox Jew who also converted to Christianity) believe that Rabbi Zolli took part in the translation of the Sumero-Akkadian-Ana'kh texts, Maria Orsic received in her extraterrestrial messages.

---



**Maria Orsic's final days in Germany**

Reverend Arthur B. Klyber

Reverend Arthur B. Klyber, a Hebrew Catholic priest strongly believed that part of Maria Orsic extraterrestrials' scripts in Ancient Sumerian language was translated by Eugenio Zolli, the former Chief Rabbi of Rome.

---

A recreation of the dialogue between the Cardinal and Maria Orsic as told in 1946 by Rabbi Israel Zolli, the Chief Rabbi of Rome, who converted to Catholicism in 1945, and changed his name to Eugenio Zolli; he passed away in 1956.

Rabi Zolli stated that Cardinal Michael von Faulhaber discussed with him part of his chats with Maria Orsic.

And here is a synopsis of Maria and the Cardinal discussion that occurred on Wednesday 13, January 1943 in Munich.

Note: By no means, the synopsis of the meeting on Wednesday 13 is 100% accurate, for it is a recreation by Rabbi Eugenio Zolli, however the Rabbi did state that the "Essence and truth are there..."

**Cardinal:**... So, who are these Ausserirdischen (Extraterrestrials)?

**Maria:** They are beings of light and of a great knowledge from Adelbaran.

**Cardinal:** What is Adelbaran?

**Maria:** Where they live.

**Cardinal:** How do you know that?

**Maria:** They told me.

**Cardinal:** Do they speak German?

**Maria:** No.

**Cardinal:** So how did you talk to them?

In what language?

**Maria:** Mentally...they send me visions and messages I catch in my mind. I have also received instructions in ancient languages.

**Cardinal:** What ancient languages?

**Maria:** A form of an old Sumerian language mixed with Ana'kh.

**Cardinal:** Ana'kh?

What is that?

**Maria:** Their language.

They speak Ana'kh.

It is the language of the Anunnaki.

**Cardinal:** Anunnaki? Meaning what?

**Maria:** The Anunnaki are the extraterrestrials being of light who created us thousands of years ago.

**Cardinal:** What are you talking about my dear child. This is a blasphemy.

Don't you know God created us?

Didn't you read your Bible?

**Maria:** I did...I read the Bible many times, but the truth is not in the Bible.

**Cardinal:** What truth are you talking about?

**Maria:** The truth about who is God, who created us, and life on other planets.

**Cardinal:** The aliens told you that they created us?

**Maria:** Yes your eminence. They did.

**Cardinal:** What did they tell you about God?

**Maria:** God exists only here...on Earth. There is no God beyond earth and on other planets. We created God.

**Cardinal:** Did they tell you anything about our Lord Jesus Christ?

**Maria:** Nothing.

**Cardinal:** Did they tell you anything about the devil and his temptations?

**Maria:** No. Nothing.

**Cardinal:** So, if they don't believe in God, they would not believe in our Lord Jesus Christ either.

Correct?

**Maria:** Correct.

**Cardinal:** What do they believe in?

Do they have a religion they follow?

**Maria:** No. They don't have any religion.

They don't need any...they know...they know the greatest secrets of the universe, and they know there is no God...

They told me there is a cosmic logic, a cosmic law, some sort of benevolent and positive energy that created the universe and we are part of it...and the most important thing is to follow the light and be fair and just.

**Cardinal:** I see....Are they humans or angels? Or something else?

**Maria:** We were created in their image.

**Cardinal:** Who created us in their image?

**Maria:** They did.

**Cardinal:** Why did they contact you?

**Maria:** They wanted me to create a spaceship.

**Cardinal:** A spaceship?

What for? Why didn't they contact the Luftwaffe?

**Maria:** Because the Luftwaffe is evil.

**Cardinal:** I see. They are right about that...about the spaceship, tell me, what are you going to do with the spaceship?

Do you know how to build a spaceship?

**Maria:** It is built already.

**Cardinal:** Who built it?

**Maria:** People I trust.



Note: More on this subject in a book I am working on: “Maria Orsic, the Most Important Person in Ufology’s History.”

\*\*\* \*\*

Nazi Germany collapses...

**Final Days of Maria Orsic in Germany**

---

**Farewell to her friend, Dr. Schumann**



Photo: Dr. Schumann.

On Thursday 15, March 1945, Maria Orsic met with Dr. Schumann for the last time at Sterneckerstraße, Munich.

Dr. Schumann gave Maria two unidentified large files, assumed to be the dossiers on the last version of German UFOs and her preliminary sketches.

Dr. Schumann remained grateful to Maria, for the rest of his life, even though she left with

Jenseitsflugmaschine; a machine he worked on for years, and wanted to keep close to his sight, mind and soul.

He had no regrets, for from Maria's visions, he was able to develop great scientific discoveries and inventions such as:

- a-His legendary "Levitorator, known to us as "Schumann SM-Levitorator", also known as VRIL DRWE.



• b-  
The

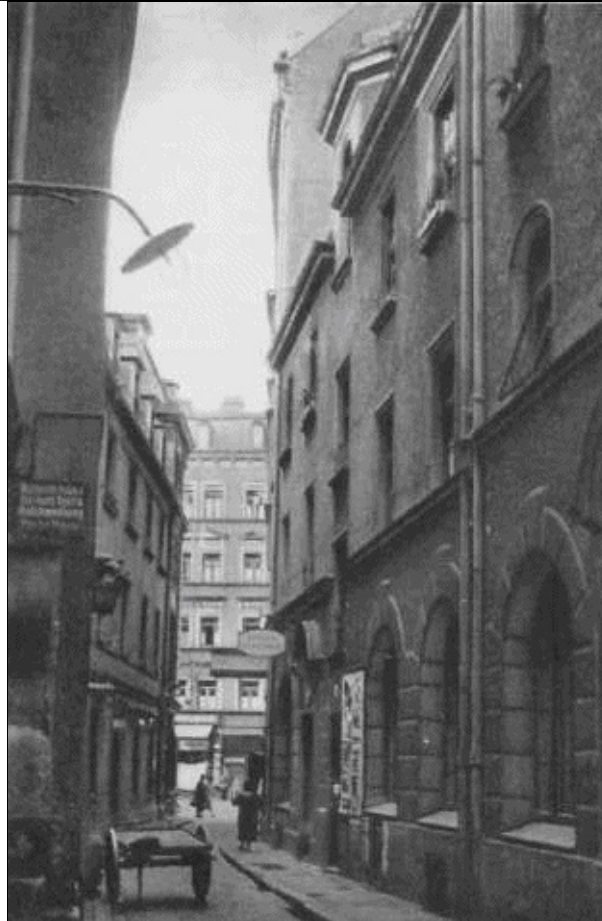

Triebwerk; an anti-gravity thrust engine.

Before she left Dr. Schumann, Maria hugged him very strongly, and tears in her eyes she said to him, Germany will be totally destroyed by the end of 1945, but will remerge as a great industrial nation in less than 60 years. She added, the Third Reich was a major mistake and a catastrophe to Germany. She regretted that Raumschiff was not built much earlier, for she could have used it to stop the war, alter

the fate of Germany and bring peace on earth.

Dr. Schumann asked her: “And now where to Maria?”

And Maria with a sad smile replied, “To the station (33.33 degree line around Earth) where they are waiting for me.”

Dr. Schumann: And you will be flying the Jenseitsflugmaschine...

No, I am not going to ask you where did you learn how to fly such a monster?

Maria: I will be guided...did you forget the band you created for me?

Dr. Schumann: How far will it take you?

Maria: To the station, and from there, their mothership will take me to them...I have already explained everything to Traute, Heike, and the others, and they are happy.

Dr. Schumann: Will I see you again?

Maria: Not in this world...I will always remember you...



## Sterneckerstraße

They hugged each other. Maria kissed his forehead and said, “So long my friend, I leave with you a big part of my heart...”

On Saturday 17, March 1945 , Maria and her Vrtil group went to the hangars of Messerschmidt, Augsburg, to take possession of the Vrtil spaceship.

### **Spotted by Lt. Col. Walter Fellenz:**

On Sunday 18, March 1945, Maria Orsic and the Ladies of Vrtil left Munich to a destination only known to Dr. Schumann and Lt. Colonel Walter Horten.

On this day, the United States Eighth Air Force mounted the heaviest raid of World War II against Berlin.

Lt. Col. Walter Fellenz, serial number 0-23055 from **the United States Army, 42nd Infantry Division, 1st Battalion, (Part of the 7<sup>th</sup> Army) that entered Munich in March, 1945 reported seeing a strange looking craft hovering over Munich and disappearing at an incredible speed.**



Lt. Col. Walter Fellenz, a reliable eye witness who reported the sighting of Maria Orsic's UFO-Vril hovering over Munich on Sunday 18, March 1945.

**Later on,** Lt. Col. Walter Fellenz would describe the craft as a huge circular shape flying craft without wings. There is no doubt in my mind, that circular shape flying craft was Maria Orsic's UFO-Vril.

The statement of Fellenz was confirmed by Brigadier General Henning Linden, and the Fellez-circular UFO story was told by Colonel Buldoc.



Brigadier General Henning Linden confirmed Fellez-circular craft sighting in Munich in 1945. This craft is believed to be the UFO Maria Orsic flew to an undisclosed destination.

---

After the war, General Linden's aide, Lt. Cowling, said that what Lt. Col. Walter Fellenz saw in Munich was in fact a German UFO.



Hans Schissler (left) in his apartment, was the last person in Munich who reported seeing Maria Orsic with a German Colonel (Probably Walter Horten) exiting a building on Thierschstraße, Munich on Friday 16, March 1945. Schissler was detained for two full days by the United States Army intelligence.

---



Thierschstraße, the last reported whereabouts of Maria Orsic, where she met with a group of high-ranking German officers, including Lt. Colonel Horten.

---





Frauenkirche, Munich, destroyed by Allied bombings.

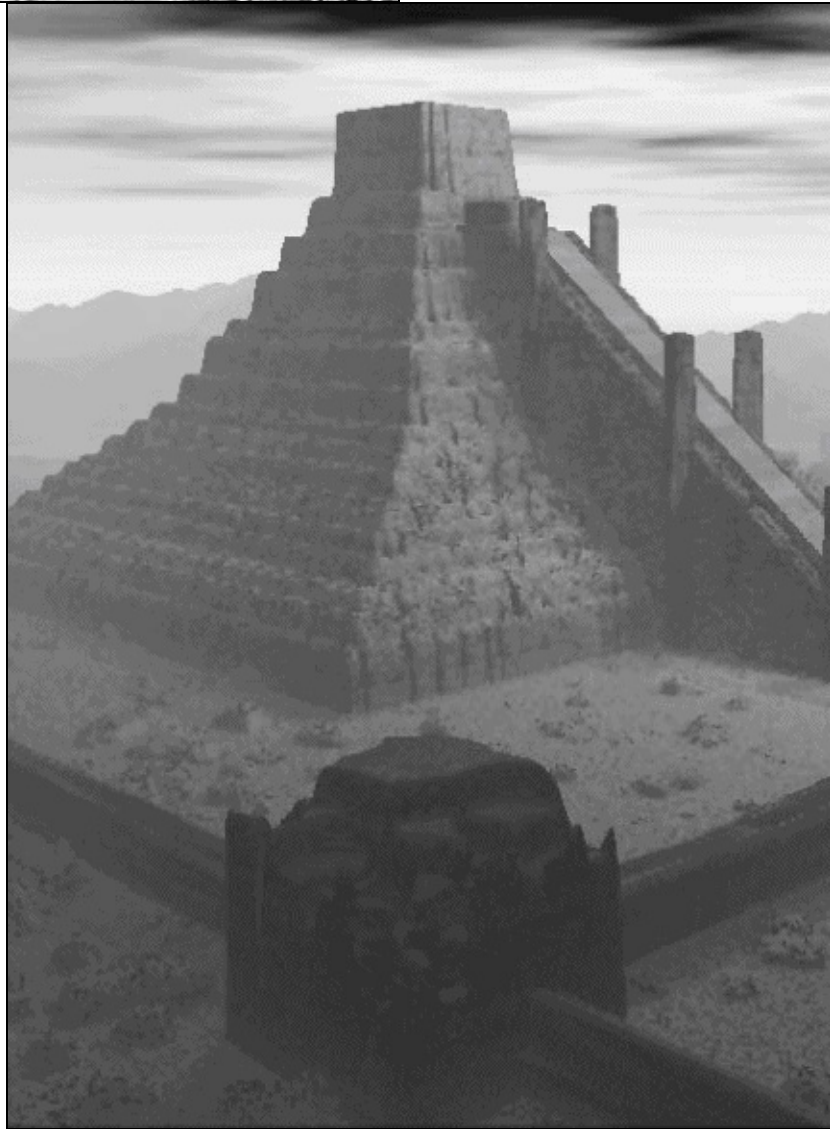

Munich on May 31, 1945, destroyed by the Allies bombings, two months after Maria left Munich.

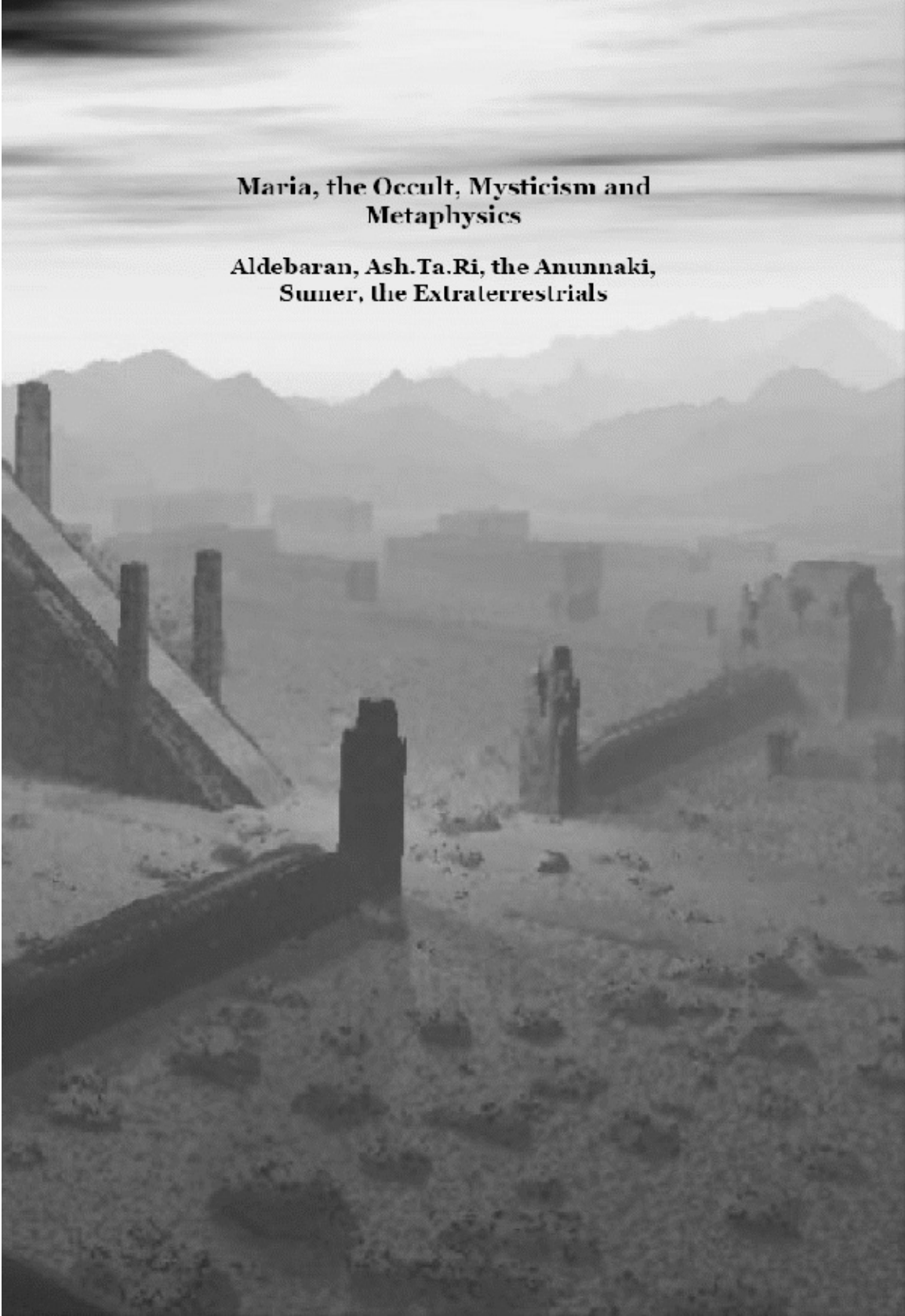

A black and white photograph of a desert landscape. In the foreground, there are several dark, rectangular stone pillars or structures, some of which appear to be part of a larger, partially destroyed building. The ground is sandy and sparsely covered with small, dark shrubs. In the background, a range of mountains is visible under a hazy, overcast sky. The overall atmosphere is one of mystery and ancient history.

**Maria, the Occult, Mysticism and  
Metaphysics**

**Aldebaran, Ash.Ta.Ri, the Anunnaki,  
Sumer, the Extraterrestrials**

**“The Extraterrestrials created us in  
their image...and there is no God with a  
white beard on other planets”-Maria  
Orsic**

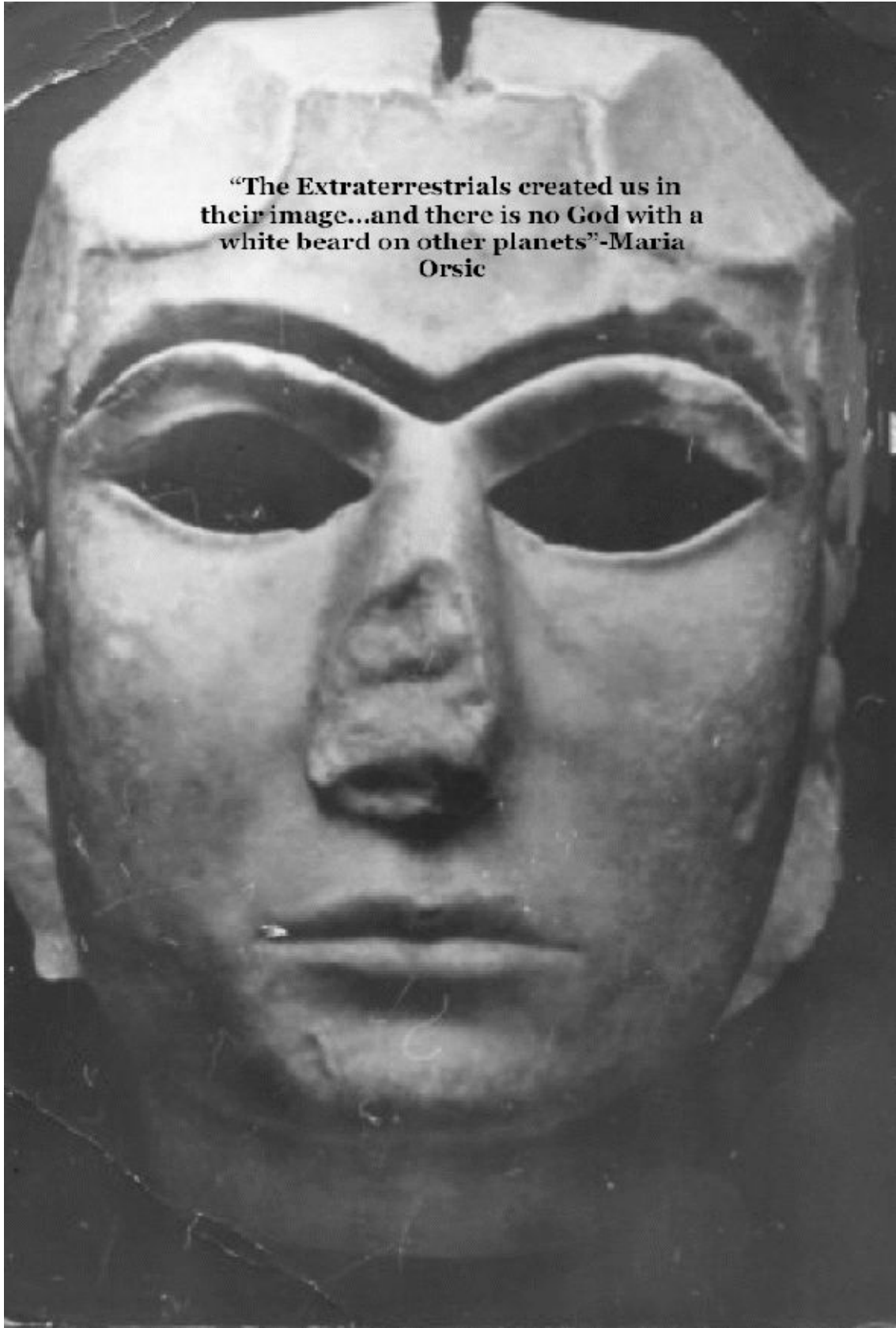

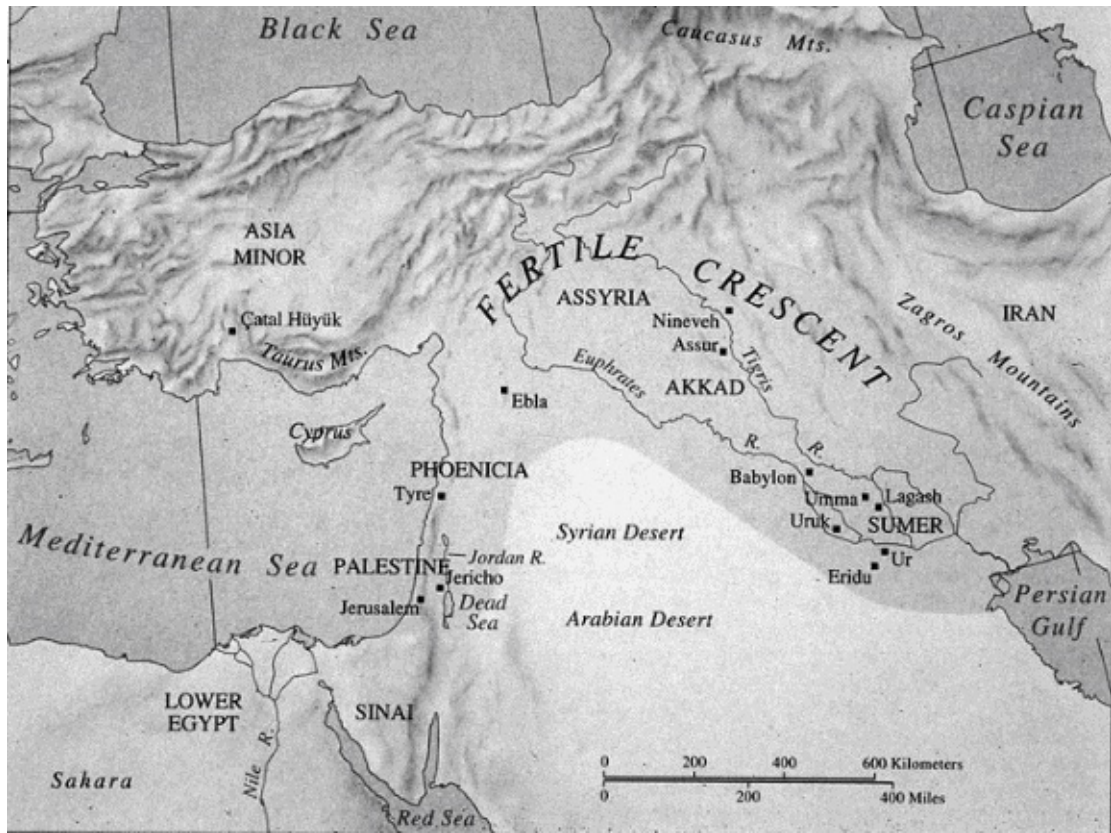

# Chapter 3

## Maria Orsic, the Occult, Mysticism, and Metaphysics

### Aldebaran, Ash.Ta.Ri, the Anunnaki, Sumer, the Extraterrestrials

---

The Anunnaki-Ulema have revealed to us that some planets in our galaxy, as well as in Ash.Ta.Ri constellation are positioned on a 33.33 degree line which serves as “Ba’ab” (Gateway) to other galaxies and dimensions. This 33.33 degree line was mentioned by Maria Orsic.

Ash.Ta.Ri constellation has millions upon millions of stars and planets, and many of them are a physical stargate, the Anunnaki Ulema call “an opening on” multiple universes and dimensions, including the astronomical bodies of the physical galaxies, and celestial ones that escape time and space, even before time was created, and since time existed as another dimension outside the landscape of the physical universe; this is incomprehensible to the human mind.

- So, why are we talking here about Ash.Ta.Ri?
- What relation there is between Ash.Ta.Ri and Aldebaran?
- What is Maria Orsic’s relation to the extraterrestrial Anunnaki?
- Did the Anunnaki talk to Maria?
- And how does Maria Orsic fit in this scenario?

Well, Alpha Tauri was known to the Arabs as Aldebaran.

And Aldebaran is known to the Anunnaki Ulema as Ash.Ta.Ri.

The verb “Adbara” in Arabic means: He left, he moved away, he traveled, he walked away. And the correct meaning of the word Aldebaran is NOT “who he follows, or the follower” as tragically interpreted by Encyclopedia Britannica! And I am puzzled and astonished by Britannica’s wrong definition of Aldebaran!!

Al Debaran or AlDaber means, “he who moved away, who left, who traveled”, and the Arabic verb is “Adbara”. Any person who speaks Arabic knows what “Adbara” means. The Arab nomads and early tribes in the Middle East, including the Persian Gulf and the Arab Peninsula have used the verbs “Idbir” and “Adbar” in their spoken dialect, and written language.

\*\*\* \*\*

**Aldebaran’s aliens are not the Anunnaki, but an offspring of the Anunnaki**

---

Aldebaran was mentioned in two important books:

- 1-The Anunnaki Ulema “Book of Ramadosh”,
- 2-The Arabic book “Ilmu Al Donia” (Science or Knowledge of the world”.

So, Aldebaran is Ash.Ta.Ri, the constellation of the Anunnaki, and the home of the extraterrestrials beings of lights Maria told us about. But keep in mind, that the Aldebaran's aliens are not the Anunnaki, but an offspring of the Anunnaki, sharing the same galactic genes.

And yes, both descended on Phoenicia, Mesopotamia and the Anatolian plateau of Asia Minor (Turkey and Armenia) 450,000-460,000 B.C. The Aldebarans' extraterrestrials who were part of the Anunnaki's expedition to Earth, took part in establishing civilizations in the Near East, Middle East and Asia Minor.

Some of their colonies were:

Eridu

Uruk

Nippur

Nineveh

Lagash

Ur

Umma

Assur

Ebla

Saydoon (Sidon, Saida)

Tyrakh (Tyre, Sour)

Kadmosh



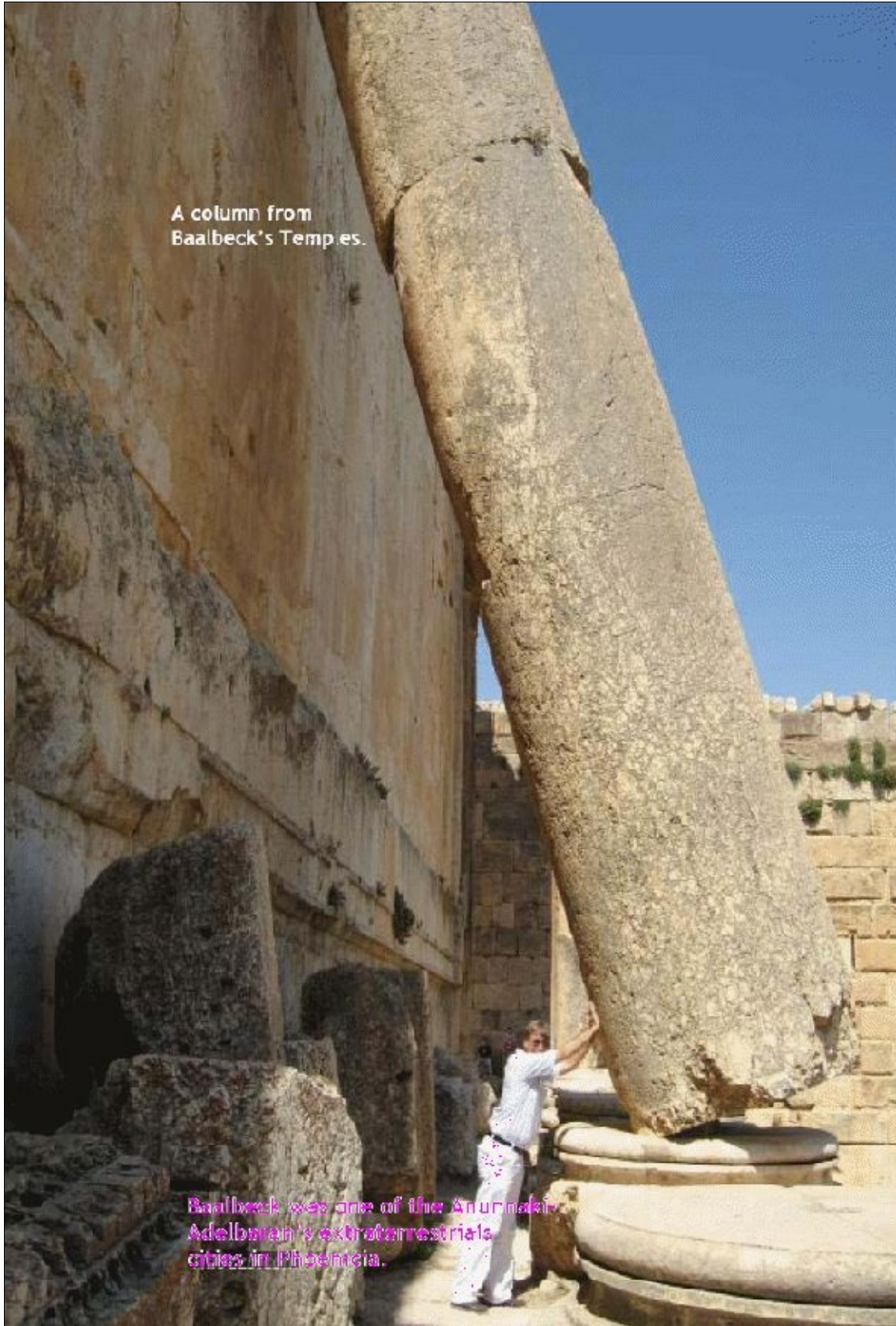

A column from  
Baalbeck's Temples.

Baalbeck was one of the Anunnaki  
Adelbran's extraterrestrials  
cities in Phoenicia.

Map  
of

Sumer, showing the location of the Anunnaki cities: Babylon, Lagash, Uruk, Ur and Eridu.

---

Adonakh

Ilayshim

Markadash (Byblos to the Greeks, and Jbail to the Arabs)

Baalbeck, where we find the legendary “Hajarat Al Houblah”

Ugarit

These cities and their civilizations are mentioned in the ancient scriptures, slabs, and clay tablets of the Middle East, Near East, the Phoenician Cosmogony, the Sumero-Akkadian epics written in cuneiform, and the Bible.

Maria Orsic was right when she said that the Aldebaran’s people created civilizations in Mesopotamia (Sumeria, Babylon, Akkad, so on), and they came from Aldebaran (Ash.Ta.Ri, Alpha Tauri).

Some authors and well-known hosts of TV shows on aliens have claimed that Nibiru is the planet of the Anunnaki and the ancient alien gods, because the Sumerian tablets said so!

If this is the case, then Maria Orsic’s claims are wrong! No! Maria was right, and they are wrong because the Sumerian epics never mentioned Nibiru as the home-planet of the Anunnaki; those people need -first-to learn Akkadian and Sumerian before they interpret epics written in languages they can’t read.

**Nibiru “Ne.Be.Ru” in the Akkadian/Sumerian texts**

---

The Anunnaki (Anu.Na.Ki) and their offspring (2 categories/2 classes) came to Earth from Ash.Ta.Ri (Aldebaran) constellation as exactly Maria Orsic has said.

Is there any passage, any line, any reference in the Enuma Elish “Epic of Creation”, the “Epic of Gilgamesh”, and/or any Akkadian/Sumerian clay tablets, mentioning Nibiru as the planet of the Anunnaki? None whatsoever!

So, there is no evidence at all that Nibiru “Ne.Be.Ru” is de facto a planet inhabited by the Anunnaki, since there are no records to that effect in the ancient Akkadian, Sumerian, Babylonian and Mesopotamian texts?

Correct!

The Akkadian/Sumerian scribes used the word Nibiru, more correctly Ne.Be.Ru as a name for Jupiter, and later on, referred to Mercury as Nibiru.

Even their god, the mighty Anunnaki Marduk was called Nibiru.

\*\*\* \*\*

**Aldebaran and Ash.Ta.Ri in the ancient texts**

---

## Where do we find these words in the Akkadian/Sumerian Tablets and texts?

1. In the Epic of Enuma Elish, Tablet 7, Lines 124, 125

Akkadian/Sumerian text (Transliteration):

**d Ne-be-ru ne-be-re-et same, u erseti lu t amehma**

Translation:

*Let him* be the holder of the crossing of heavens and earth.

Note: “ *Let him* ” means Nibiru and Marduk.

And Mercury and Jupiter were associated with god Marduk.

This is documented in the epic of “Enuma Elish”, in Tablet VII, lines: 126,130,131.

It is also translated by some Assyriologists as follows:

Let Nibiru be the marker “Holder” of

Heaven and earth crossing place.

Note:

“Same” (Pronounced Shameh) means heaven.

Sama in Arabic. Shem in Phoenician, Shama in Ulemite.

Shamayim in Hebrew; a plural form meaning heights.

“erseti” means Earth. Other words: Ersetu, Erdsetu.

Erd (Ard) in Arabic. Heretz (Eretz) in Hebrew. Erda in Ulemite.

2. Appeared in lines 130 and 131.

Akkadian/Sumerian text (Transliteration):

**d Ne-be-ru kakkabu-su**

**sa ina same, u-su-pu-u**

Translation:

“Ne.Be.Ru is *his star* , which he made appear in the heavens.” Also translated as follows: “Nibiru is *his* star which in

heavens made it appear.”

Note: “ *His star* ” refers to Marduk.

3. Also in the Epic of Enuma Elish, Tablet 5, Line 6.

Here is the text:

**u-sar-sid man-zad-az**

**dNe.Be.Ru ana ud-du-u rik-si-su-un**

Translation:

*He* promptly set the position (Place) of

Nibiru to fix *their* limits (Frontiers, boundaries).

Or

*He* created the station of

Nibiru to determine *their* bounds.

Note:

*He* , refers to Markuk.

*Their* , refers to planets or stars.

Interesting information in the following lines:

8. He (Marduk) fixed the station of Bel and Ea along with him.

9. He opened great gates (Ba'abs) on both sides.

4. In Tablet 7, Line 109.

Let *his name* be Nibiru, the capturer of the midst.

Note: *His name* , means Marduk.

Also in Tablet 7, Line 126.

Translation of the Akkadian/Sumerian text: “The stars of heaven, let him set their course; *let him* shepherd all the gods like sheep.”

Note: “ *Let him* ” refers to Ne.Be.Ru.

\*\*\* \*\*

### **In Anunnaki Ulema manuscripts**

- 
- 1. In the Book of Ramadosh, Scroll 21, Sifr “Chapter” 12:

Here is the text (Transliteration):

**Ne.Be.Ru ina Ashtari (Aldebaran) mina khalkah.**

Translation:

Ne.Be.Ru from Ashtari (Constellation or Star) was created.

- 2. In the Book of Ramadosh, Scroll 21, Sifr “Chapter” 13, a lengthy article, which was also mentioned in Ambar Anati revelation:

Note: See Chapter 3.

- 3. In the Kitabu Ilmu Al Donia “Book of the Knowledge Of the World”, Fasel Ashrah (Chapter 10):

Here is the text (Transliteration):

**Wa min Ashtari (Aldebaran) barazat Ne.Be.Ru, kawkab al Ana'kh, asyaad al kawn and khalikeen al bashar.**

Translation:

And from Ashtari (Aldebaran to Maria and to the Arabs), emerged Ne.Be.Ru, the star of the Anunnaki, masters of the universe and creators of the human race.

\*\*\* \*\*

## Epistemology/Etymology:

Ne.Be.Ru is composed of three words:

- **a - Ne** (Pronounced Nii) means from within, similar to the words Ina, In, Na in proto-Sumerian, Akkadian and Assyrian.
- **b - Be** (Pronounced Behh) means light or source of implosion.

A strong emphasis was placed upon “Implosion” to highlight its prime difference with “Explosion”, since according to Ulema Bukhtiyar, the planet Ne.Be.Ru was not created by an explosion of another star or a planet, or the collision of other celestial (Space) bodies, as modern science has explained the birth of new stars and planets.

Ne.Be.Ru was created from an implosion. Quite a revolutionary concept! I found this astonishing, for Maria Orsic and her group of scientists who worked on Maria’s UFO-Vril said that Vril is the ultimate source of energy in the universe, and their super flying machine (UFO) will be propelled by an “Implosion Energy”, not a combustion engine.

- **c - Ru** (Pronounced Rooh) means lasting force or energy. Worth mentioning here, that the Arabic word روح “ Rouh” (Soul, Spirit, Self ا ل نفس ) and the Hebrew word רוּח “ Ru’akh”, (Nephesh like the Arabic word Nephes) mean life. Both Hebrew and Arabic words derived from the Ana’kh.

\*\*\* \*\*

Is it true that in the Akkadian/Sumerian texts, Nibiru was also referred to as a divine being, a star, and a deity?

Correct. Because the word Nibiru always had the prefix “Mul”, and the prefix “d”.

These two prefixes were usually used in Akkadian and in Sumerian cuneiform texts to refer to a divine status of something or somebody.



So when we see Nibiru written as **d Nibiru** or **Mul Nibiru** , we immediately understand that Nibiru is divine.

This was a linguistic standard of Akkadian and Sumerian.

The Anunnaki-Ulema have defined what Nibiru means in one of their manuscripts dated 95 or 96 B.C.

According to Ulema Ghandar, Ne.Be.Ru means: The Lasting Energy, or the Prime Implosion, Maria Orsic defined Aldebaran as the planet of the divine cosmic energy, and their inhabitants as the beings of light.

\*\*\* \*\*

The Akkadian/Sumerian clay tablets are very confusing. In some passages, the texts refer to Ne.Be.Ru as a star, in other passages, Ne.Be.Ru is not a planet, but a crossing point, serving as a stargate, a gateway, and somewhere else in the cuneiform texts, Ne.Be.Ru is a deity, a dividing point or a zone, Jupiter, Mercury, Anunnaki god Marduk, and/or Marduk, Jupiter and Mercury, three-in-one!!

- In the Sumerian/Akkadian texts, we found this line:

**“ Ne-bar-ti-Ash-shur.”**

Meaning: “The Crossing Point of Asshur.”

Note: Asshur “Assur” was an ancient Mesopotamian-Babylonian-Assyrian city.

In another passage, we found this line:

**“ ina Abani ni-bi-ru u-cha-du-u.”**

Meaning: To “have cut off the crossing way of the river Abani.”

Note: This passage refers to the Elamites.

Reference: The Epic of Gilgamesh.

Text from the Epic: “Straight is the crossing point, and narrow is the way that leads to it.”

- The Akkadian and Sumerian word **Ne.Bi.Rim** means crossing.

Akkadian/Sumerian text (Transliteration):

**shiqil kaspum sha ne.bi.rim.**

Translation: Silver paid for the crossing.

Meaning: A fee was paid for a person who transports people, across the waters.

**Ne.bi.rim** as a word, means crossing.

**Nebiri** as a verb, means to cross something or cross over.

\*\*\* \*\*

**In other ancient languages**

---

• In proto-Old Babylonian, the verb **Abri** and **Ne.Bri** mean to traverse, to cross.

• In Arabic, the verb **Abara**, and **Abra** mean to cross, to traverse. The word **Abirun** ( **Abiroun** ) means those who traverse, who cross over.

• The Early Hebrews (Israelites) were called **Habiru** or **Abiru** , which means those who have crossed.

• In Ulemite, **Ibru** and **Abru** mean to traverse. And **Nibru** is an opening area in space which allows a traveler or a machine to enter another dimension.

\*\*\* \*\*

In 1902, L.W. King provided us with the following translation of Tablets 5 and 7 of the Enuma Elish “Epic of the Creation”:

In the Fifth Tablet we read:

*He (Marduk) made the stations for the great gods;  
The stars, their images, as the stars of the Zodiac, he fixed.  
He ordained the year and into sections he divided it;  
For the twelve months he fixed three stars.  
After he had ... the days of the year ... images,  
He founded the station of Nibiru (the planet Jupiter) to determine their bounds;  
That none might err or go astray,  
He set the station of Bel and Ea along with him.  
He opened great gates on both sides,  
He made strong the bolt on the left and on the right.  
In the midst thereof he fixed the zenith;  
The Moon-god he caused to shine forth, the night he entrusted to him.  
He appointed him, a being of the night, to determine the days;*

In the Seventh Tablet, we read:

*He (Marduk) named the four quarters of the world, mankind he created,*

*The Creator of the earth.*

...

*May he hold the Beginning and the Future, may they pay homage unto him,  
Saying, "He who forced his way through the midst of Tiamat without resting,  
Let his name (Marduk) be Nibiru, "the Seizer of the Midst!"  
For the stars of heaven he upheld the paths,  
He shepherded all the gods like sheep!  
He conquered Tiamat, he troubled and ended her life,"  
In the future of mankind, when the days grow old,  
May this be heard without ceasing; may it hold sway forever!  
Since he created the realm of heaven and fashioned the firm earth.*

### **Mul.Apin:**

Here is the text (Transliteration):

**Kima kakkabu sut ı Enlil ugdammiruni isten kakkabu**

**Rabu sessu da mat same ustamsalma izzaz kakkab**

**ı Amar.Ud Ne.Be.Ru sag. me. gar mamzassu**

**Ittanakkir same ibbir**

Translation:

When the stars of Enlil were completed (Finished)

One star with big dim light, he (Enlil) divides the heaven (Sky) in half and stands there

That is the star (of Marduk) Ne.Be.Ru Jupiter which keeps

Changing its position and traverses the Heaven (Sky).

Important Note:

The last two lines: **sag.me.gar mamzassu Ittanakkir same ibbir**. The text seems to tell us that Nibiru did cross the sky! Is it a contradiction, or simply, the two lines meant that Nibiru was rotating around another star? The Akkadian/Sumerian texts do not provide any explanation.

\*\*\* \*\*

**Summary of findings:**

The Anunnaki and the Anunnaki Ulema identified Aldebran (Ash.Ta.Ri) as their constellation, and Ne.Be.Ru as a crossing point to other dimensions.

Linguistically speaking (Epistemologically and etymologically), the Arabic words of “ **Aldebaran**” , “ **Abirun**”, the Arabic verbs, “ **Abara**”, “ **Abra**”, the Sumerian-Akkadian word “**Ne.bi.rim**”, and the Ana’kh/Ulemite words “**Ashtari Aldebaran barazat Ne.Be.Ru**” refer in essence to the very same thing: Aldebaran (The Constellation of Ashtari) home of Maria Orsic Alderbaran’s extraterrestrials and Anunnaki.

\*\*\* \*\*

**How did Maria Orsic describe Aldebaran (Ash.Ta.Ri)?**

---

Maria’s description of Aldebaran is identical to the description of Ash.Ta.Ri, given by Anunnaki Sinhar Ambar Anati to American scientists and United States government officials and which we have on record.

It is also similar to the description of other inhabitable planets in the Aldebaran constellation and other constellations given by the female alien Riyah to American generals, linguists and scientists in 1947.

The three extraterrestrials’ descriptions can be compared in the “1947-1948 Aliens Transcripts”, “Mouzakarar Sinhar Marduk”, “Book of Ramadosh”, and “Kitabu Ilmu Al Donia”.

## **1. Days calendar and moons around the inhabitable planets in Aldebaran:**

A day consists of forty-eight hours.

The sun rises around four o'clock in the morning, and the sunrise takes about two hours and twenty five minutes; the colors in the sky at that time are spectacular.

The sun shines for eighteen hours in the summer and for twelve hours in the winter; there are only two seasons on their planets.

The sun then takes two hours for sunsets.

Ash.Ta.Ri (The planet of the Anunnaki) has four moons.

All moons rise harmoniously one after the other, and line up in four different directions. The home-planet of the Aldebaran's extraterrestrials has two moons and two planets rotating around it. The moons of each planet stay for about ten hours. And when they fade away, they follow the same pattern, one after the other in the same synchronized manner.

\*\*\* \*\*

## **2. Atmosphere and energy:**

- **a** -No pollution;
- **b** -No smokes from factories;
- **c** -No oil fuels;
- **d** -Pure electromagnetic energy is used exclusively. The term "electromagnetic" is not totally

correct. But this is as close as we get to understand its properties.

Their energy consists of a blend of spatial neuro-plasma and subatomic molecules. And even these wordings are not correct because on planet earth, blending or fusing these elements and substances together contradict mainstream science.

\*\*\* \*\*

### **3. Waters, lands and lakes:**

There are plenty of canals, and so much water on their planet; about fifty/fifty to the land, the ratio is, but they have some wonderful lakes underground which are as blue as a sapphire.

\*\*\* \*\*

### **4. Adjacent planets and other extraterrestrials:**

Inhabitants of adjacent planets vary sharply from one civilization to another, but all are highly advanced, and have one thing in common, which is very characteristic of their climate: An anti-pollution shield that protects their atmosphere. On Earth, it is the Ozone.

In the Aldebaran's solar system, there are two small planets that support life, and are inhabited by people who resemble us. They have evolved very slowly, and are considered by other galactic civilizations to be inferior, "even savages", because they eat meat and fight.

At the far edge of their solar system there are four planets which are totally different from their habitat, because none has an atmosphere. They are cold, and sterile.



And their inhabitants don't look like us physically; in fact their appearance will scare the hell out of us, because some look like machines, while others like huge insects and reptilians.

Other civilizations are aware of their existence, but they avoid them because they are hostile and very aggressive; they belong to the forces of darkness.

Maria like Sinhar Anati talked about the Lyran system which consisted of 9 planets and 13 moons. The Lyrans, Aldebarans and Anunnaki are on very good terms.

The Aldebaran's extraterrestrials are the offspring of a higher race (The Anunnaki) which visited Earth hundreds of thousands of years ago, and created the earliest civilizations on Earth. Some lived on Earth for thousands of years but eventually returned back to Aldebaran. Others got stuck on Earth and could not make it home. Consequently they lost their extraterrestrial genes, and began to look like humans, gradually.

Yet, they were very advanced and created wonders on Earth.

Some were killed by the Great Deluge, and those who survived, returned after a while to:

Mount Hermon (Jabal Haramoun)

Baalbeck

Lake Van

Urartu

Dilmun (Ancient Bahrain)

Hadramout (Yemen)

Anatolia

Mesopotamia

Himalaya mountains

Tibet

Scandinavia

And to scattered islands in the Mediterranean.

All are considered to be Aryans, even though the Anunnaki have black eyes and black hair, with the exception of the higher cast of the Anunnaki which has light black hair and blue eyes.

\*\*\* \*\*



The Trilithon of Baalbeck.

The base of the Temple of Jupiter is called the Trilithon, and it is constructed of three 1200-tonne limestone megalithic stones. Legend has it, that the temple was constructed by a fleet of giants sent by Nimrod. An ancient

Arab fable tells us that the Afrit of King Solomon built the temple. The Anunnaki Ulema told us that the Plateau of Baalbeck and its gigantic columns, including Hajarat Al Houblah are the work of the Anunnaki.



---

### Hajarat Al Houblah

Name of the legendary massive stone located in Baalbeck, Phoenicia (Modern day Lebanon), reportedly used by the Anunnaki for their Markabah (Super flying machine) launching center in ancient Phoenicia. Maria Orsic told us that Mt.

Harmon and Baalbeck were a stargate for the extraterrestrials, and the beings of lights who survived the Great Deluge lived there for thousands of years.



Hajarat Al Houblah in Baalbeck.

The world's longest, largest and heaviest carved stone. Few of those stones were used as an Anunnaki spaceships

launching pad/terminal. No technology today can lift up this stone.



Hajarat  
Al

Houblah.

An approximately 1,200-1,500 tons stone known as “Hajarat Al Houblah” was used in Baalbek’s Great Platform. According to Phoenician legend, stones like this one were moved by the Anunnaki, using levitation, and teleportation; an anti-gravity system, frequently mentioned by Maria Orsic, and as part of the Vril, which she defined as “Cosmic Energy”.

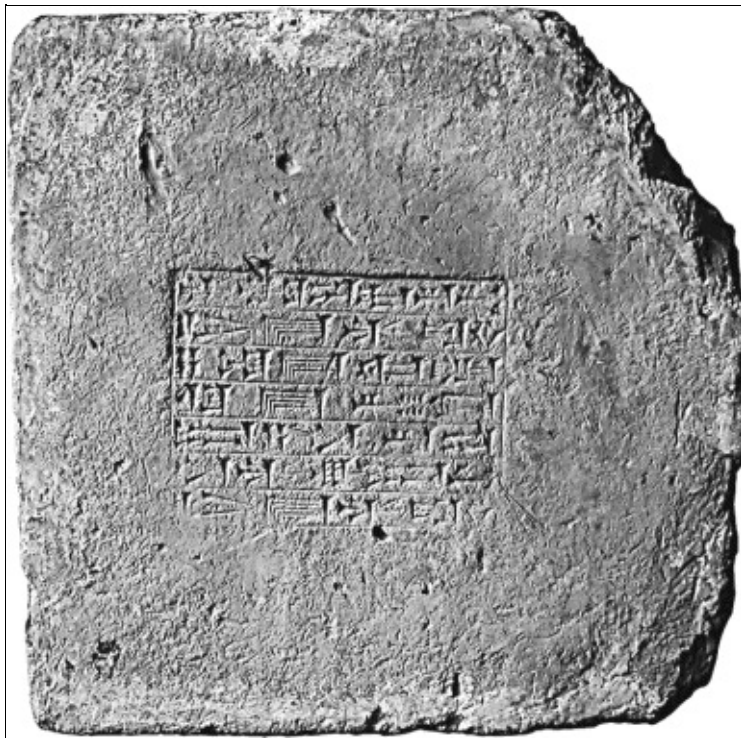

Ruins of Tushpa-van, the capital of kingdom of Urartu.

The early Urartians (Ancestors of the Armenians) were the remnants of the Adelbaran's extraterrestrials, the offspring of the Anunnaki, Maria Orsic referred to.

---



Inscription on a brick from the Tower of Babel.

Blockprint, Babylon, 604-562, Babylon.

Some historians have associated the Temple of Marduk with the Tower of Babel. This association was never documented or substantiated. Maria Orsic told us that the extraterrestrials built huge edifices and monuments on Earth, including Baalbeck Plateau, and the Great Pyramids, and their offspring continues with gigantic constructions such as the Tower of Babel, and the Ramparts of Tyre.

---

**Effects on humans upon arrival to Aldebaran-Ashtari**

---

Maria's dream was to visit the extraterrestrials of Aldebaran. And she asked them lots of questions about their habitats, lifestyle and whether she could live there with her Ladies of Vril. Here is a synopsis of what we already know about the physiological, psychological and emotional effects on humans upon arrival to Aldebaran-Ashtari.

### **Upon Arrival:**

When a human being arrives to Ashtari-Aldebaran for the first time, he or she experiences new physiological, emotional and psychological effects, as well as psychosomatic reactions.

The extraterrestrials told Maria (Similar account by Anunnaki Sinhar Anati) that the very first thing she will see when she steps out of the spaceship could be described as a quantum jump into a world which looks like a sand storm on a completely gray planet.

At the very beginning, said the extraterrestrials to Maria, you will feel horrible and becomes dizzy.

It is the atmosphere of our planet that causes this.

You need three days to adjust.

The following is an excerpt from Anunnaki Sinhar Anati which perfectly illustrates the situation, Maria will be in, the moment she enters the world of her extraterrestrial friends:

The first thing the Aldebaran-Anunnaki extraterrestrials will do, is to take you to a bright room. A gentle

person will show you the way to a bedroom.

This person exchanges a few words with you and directs you to a very comfortable bed. And you will appreciate that, because by then you will be extremely tired, and you will sleep instantly. The next day you will wake up, and the treatment of your sight begins. A person dressed in lilac will show you to a room with a basin filled with aquamarine-tinted fluid.

This person will ask you to go in, relax, and think only about colors, nothing else, preferably about one specific color, and this person would come back in an hour or so. The bathtub makes you feel good. The bathtub is perfumed with some floral scent you will not recognize, but you will like a lot.

For a while nothing happens, but after a few minutes, all of a sudden a stream of lavender light fills the basin and then lifts up and surrounds you like a beautiful web. At the same moment, and to your surprise, if on earth you had any muscular or joint pain, it will totally disappear. All these are part of adjusting your vision; they (Extraterrestrials) must cure all the weaknesses of the human body, genes, and all the possible diseases and sicknesses that you might have in the future, in order to readjust your sight.

On the second day, the same person (An extraterrestrial) leads you through a connecting corridor to a surgical room in another building. You will be introduced to a nurse, or a physician, who will ask you to lie down on a table. A machine comes from the ceiling, shining a laser-like beam.

The machine scans your brain, and the nurse will ask you to look at the screen on your right side to see how the cells in your brain would create new visual faculties. This is absolutely amazing.

You could actually see how your brain works. The nurse explains to you that many cells, millions of particles of your brains, were never used by you and now many of them would become yours to use. After a short time, the nurse puts a soft but firm bandage around your eyes and a metallic band or a belt around your forehead.

The band or the belt readjusts the level of energy and reactivates part of your brain's cells. The band or the belt also develops a telepathic power in due time.

At a later day, you will be able to communicate telepathically with us. Pictures start to flow into your head and you don't know where they come from. Some are the faces of other beings you have never met in your life. It is a very strange feeling. You see faces and other things, but you do not hear sounds or voices. And everything happens calmly without any mental or physical effort.

When the treatment is over, your vision becomes perfect. And soon, you could go out and see the planet for the first time. Outside, the air is pure, and the sky is full of rainbows of colors. You have never seen such



colors in your entire life, because these colors do not exist on earth.

Some of the colors of the sky blend with the colors of the landscape, giving you the feeling that the ground is united with the sky.

Then, you realize that something very strange is happening to you; your vision is no longer limited to straight lines. Now, you can see, magically, to the left and to the right, like a surrounding vision.

And you start to see more and more things; absolutely stunning buildings glimmered under the brilliant sky, trees, bushes, and flowers everywhere and beautifully dressed, smiling people walking in the streets. How different from what you saw first, a gray planet with swirling sand in its atmosphere!

#### **Immediate human impression and reactions:**

Those who landed on the Aldebaran-Ashtari constellation for the first time experienced something very unique; an optical problem, a psychosomatic vision/sight anomaly, more precisely, the inability of seeing.

Temporarily they become totally blind. This phenomenon and how to regain sight was described by Sinhar Ambar Anati.

Note: Anati is describing what happened to her upon her arrival to Ashtari and she is talking to her Anunnaki relatives.

In her own words:

“Why can’t I see anything outside?

It’s the atmosphere. There is no pollution, no smoke, no oil fuels, since pure electromagnetic energy is all the Anunnaki use. It is so bright, so clear, that it creates a strange effect on the human retina, which is accustomed to different conditions ...

When I woke up, my treatment began. Miriam (An Anunnaki female) took me to a little room where she showed me a basin filled with aquamarine-tinted fluid.

She asked me to go in, relax, and think only about colors, nothing else, preferably about one specific color. She would come back in an hour or so, she said, and the water will stay warm as long as I was in.

I climbed into the bath which felt wonderful and was fragrant with some floral scent I did not recognize. I closed my eyes and thought about the color lavender, beautiful, gentle soft kind of lavender.

For a while nothing happened, but after a few minutes, all of a sudden a stream of lavender light filled the basin and then lifted and surrounded me like a beautiful web. To my surprise, at the same moment, a joint pain I developed on earth disappeared. It was in my ankle, which I have hurt a year ago while running, and it did not heal properly, giving me occasional pain.

I twisted it when I left the spaceship and stumbled, and it hurt when I woke up from my nap. Now it was perfectly well. Later they explained that as they adjust the vision, they must cure all the weaknesses of the human body, my genes, and all the possible disease and sicknesses that I might have in the future. Even at my young age I could feel the difference between the human condition and perfect health. On the second day, Miriam led me through a connecting corridor to a surgical room in another building.

They have these corridors, connecting houses and buildings to each other, and they never lock any doors.

Such a trusting, simple lifestyle, such a pleasure.

She introduced me to a nurse, or physician, who asked me to lie down on a table.

I did, and a machine came from the ceiling, shining a laser-like beam. Apparently, they scanned my brain, and the nurse told me to look at the screen on my right side and see how the cells in my brain would create new visual faculties.

This was utterly amazing.

I could actually see how the human brain worked! The nurse explained that many cells, millions of particles of the brains, are never used by humans, and now many of them would become mine to use. After a short time, the nurse put a bandage around my eyes and a metallic band around my forehead.

This was needed for readjusting the energy and reactivating part of the cells. They told me that this will not only adjust my vision, but will develop a telepathic power in due time.

Indeed, to my great delight and astonishment, at a later day I was able to communicate telepathically with the Anunnaki, at will. When the treatment was completed, my vision was perfect, and Miriam told me that I could go out and see their world for the first time.”

\*\*\* \*\*

**But who are the Anunnaki and their offspring the Aldebaran’s extraterrestrials?**

---

**The Anunnaki**

**I-The wrong definitions:**

For some reason, the word Anunnaki was incorrectly translated by some, as:

“Those who Anu sent from heaven to earth.”

“Those who from heaven to earth came.”

These definitions are not accurate, because they do not define the word Anunnaki, but refer to where they came from, and who has sent them to Earth. A proper definition should stay a definition, explaining the meaning in the simplest, and clearest way, and not a personal interpretation or an elaboration on a word usually discussed in a “summary”, “characteristics”, or a section reserved to “what people have done.”

If you want to define “New Yorker”, you would –I assume – simply say, a person who is from New York, as simple as that. You do not say, “Those who George Washington sent from Virginia to New York” or “those who from the mountains or the plains of Georgia to New York came.”

These two definitions have been blindly accepted by the masses, because of their lack of knowledge of Akkadian-Sumerian-Old Babylonian languages.

The Akkadian, Sumerian, Babylonian, Chaldean, and Assyrian word “Anunnaki”, “An-nuki” (linguistically, etymologically, and epistemologically) does not refer or indicate any of these: Those, heaven, came.

Those two definitions are wrong; they are an interpretation or a representation of the Anunnaki’s arrival to Earth, rather than a definition.

\*\*\* \*\*



Ea “Enki” supreme god of the Anunnaki and father of the Aldebaran’s extraterrestrials (Offspring of the Anunnaki) stepping on a dry land, a gesture symbolizing his supreme authority over Earth.

Scene from a Babylonian cylinder seal showing Enki with two streams of water emerging from his shoulders, and the Sumerian sun-god Utu (Shamash “The Sun God” in Akkadian, Shemesh in Phoenician).

In the center, we see Inanna (Ishtar in Akkadian, Ashtaroot in Phoenician.) This

scene shows Ea “Enki” stepping on a dry land, a gesture symbolizing his supreme authority over Earth. The dry-land as depicted in this cylinder refers also to ramparts protecting the cities of his kingdom. From the ramparts emerge a stream of fishes, symbol of all lifeforms in the seas. Thus, his authority extends to dry lands and seas of the Earth.

184

Map of the Adalbaran's extraterrestrials and Anunnaki's land in Mesopotamia.

The land of the Anunnaki in Mesopotamia, around the Tigris and Euphrates Rivers, and where their myths and epics were written in Akkadian on Sumerian clay tablets.

Other tablets and archaic inscriptions also documented their presence on Earth, such Assyrian seals, Babylonian cylinders, Phoenician scriptures, and Ugaritic poems.

---

## **II. The correct definition:**

### **a-Composition/origin of the word Anunnaki:**

The word Anunnaki is composed of three words, less or more, depending on the choice of linguists, but the most correct linguistic compositions are as follows:

#### **First composition:**

- 1-Anu, which is the name of the Anunnaki's supreme god. And the epistemological meaning of Anu is: Lord; leader; king.

- 2-Na, is either a verb or an adverb, meaning to send. In many Akkadian, Sumerian, Assyrian and Old Babylonian texts and inscriptions, “Na” was written as “Ina”, and meant in, from within, so on.
- 3-Ki, generally means Earth in Akkadian and Sumerian. But Ki also means all of the following, in Akkadian and Sumerian: The underworld, the netherworld, the world of death.

Thus, the general meaning becomes: The lord (or Lords) of Earth; the god (or gods) of Earth; the gods of the underworld.

### **Second composition:**

Composed from two words, such as:

- 1-Anunna, which means a group of deities (Gods and goddesses) in Akkadian and Sumerian languages.
- 2-Ki, which means earth and/or the underworld.

Thus, the general meaning becomes: The goods of Earth; the gods of the underworld.

Many passages in the Cuneiform clay tablets clarified, explained, and established these facts.

So there is no room for errors, different definitions, or personal interpretations.

### **b-Usage and differentiation of the word Anunnaki:**

The Akkadian/Sumerian Anunnaki word is used in a plural form to mean “Gods”, not to explain where they came from, who sent them, and where to!

The gods (from Earth and from Heaven) altogether are called Anunnaki, and are represented as

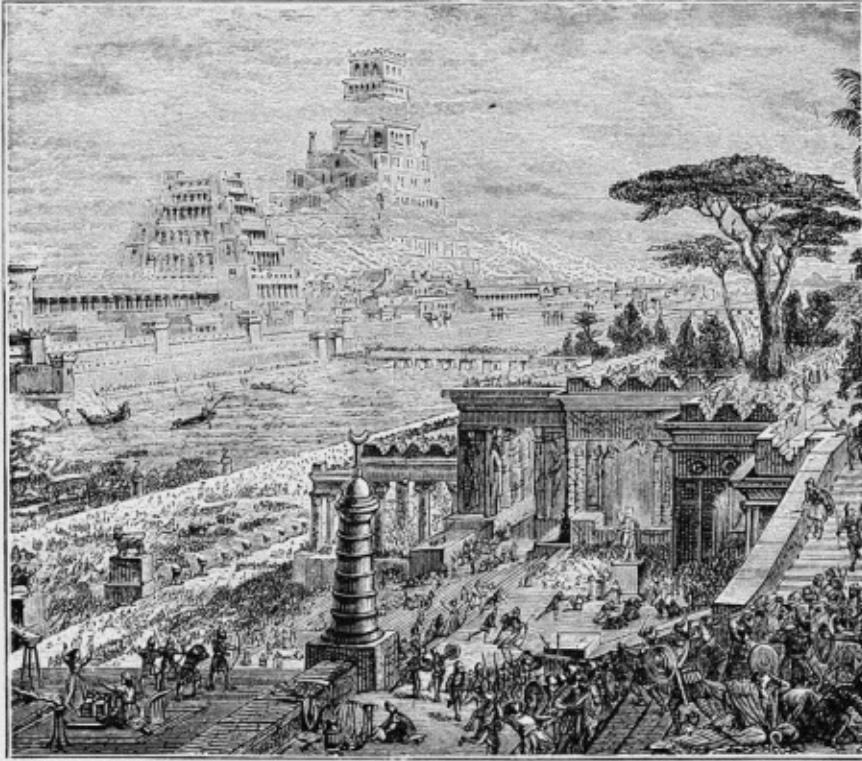

a

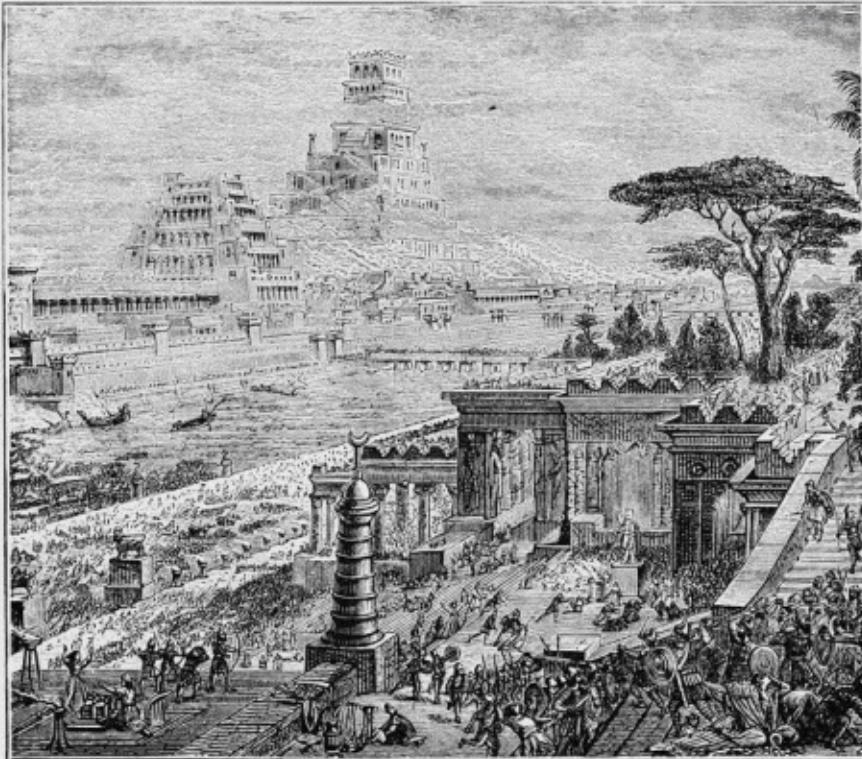

amê (Sha Shame) u erSetim  
(Pronunciation: As Sha Shameh ersetiim) meaning the Anunnaki of heaven and earth.



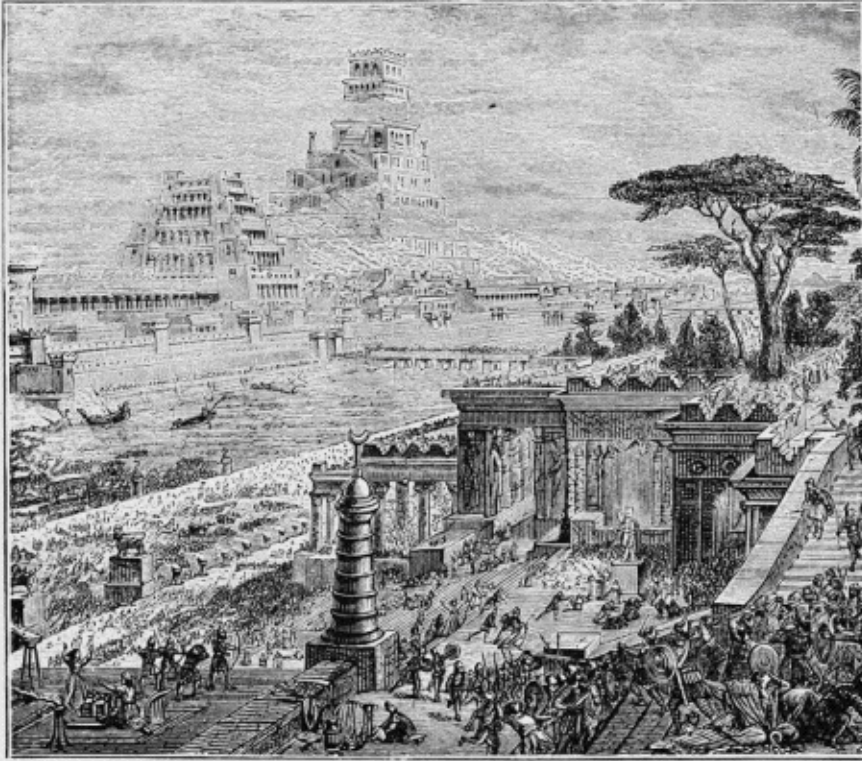

a

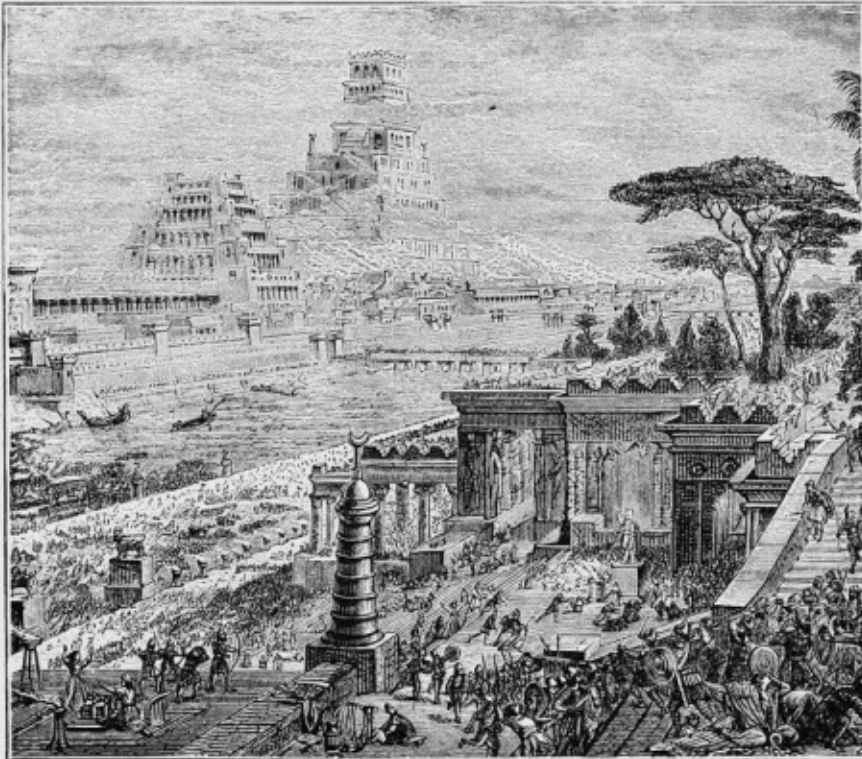

amê means heaven in

Akkadian and Sumerian. Shem and shama in Phoenician.

Sham in Ulemite. Sham and Shama in Ana'kh. Sama in Arabic. It is very clear!

erSetim means earth.

In this category of “Group of deities”, Anunnaki and Igigi are grouped together.

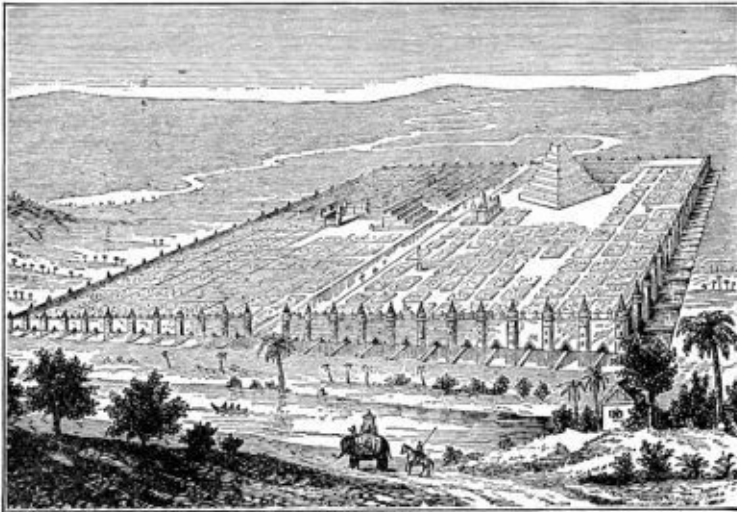

Babylonia, land of the Anunnaki, when it was captured by the Persians.

---

Later on in history, and in order to differentiate between the Anunnaki and the Igigi,

1. The scribes called the Anunnaki, the gods of Earth, also gods of the netherworld, and the gods of the Empire of Death;
2. The scribes called the Igigi, gods of Heaven (or heavens, skies)

This differentiation is very clear in all the Mesopotamian clay tablets, particularly in the poem of “Ishtar Descent to the Underworld” (Ki), the epic of Gilgamesh and the Enuma Elish. Yet, in ancient esoteric writings, the Anunnaki were referred to as the “Shining Ones”, similar to Maria Orsic’s expression “Beings of Light”.

\*\*\* \*\*

### III. Other names of the Anunnaki:

The Anunnaki were known to many neighboring countries in the Near East, Middle East, and Anatolia.

And because of the languages' differences, the Anunnaki were called differently.

For instance:

- **1** -The Habiru (Early Hebrews/Israelites) called them Nephilim, meaning to fall down to earth, as well as Anakim.
- **2** -Some passages in the Old Testament refer to them as Elohim, and Ha bene Elohim.
- **3** -In Ashuric (Assyrian-Chaldean), and Syriac-Aramaic, they are called Jabaariyn, meaning the mighty ones.
- **4** -In Aramaic, Chaldean and Hebrew, the Anunnaki as Gibborim mean the mighty or majestic ones.
- **5**- In literary Arabic, it is Jababira. The early Arabs called them Al Jababira; sometimes Amalika.
- **6**- The Egyptians called them Neteru.
- **7**- The early Phoenicians called them An.Na Kim, meaning the god or heaven who sent them to us.
- **8** -The early inhabitants of Arwad called then Anu.ki, meaning the subjects or followers of Anu. Sometimes, they were called Anu. Ki.ram. (Ram means people, persons, community, tribes, group)
- **9**- The early Hyskos (Ancestors of the Armenians) who invaded and ruled Egypt, called them the Anuramkir and Anuramkim, meaning the people of Anu on earth. It is composed of three words: Anu + ram (People) + Ki (Earth). The primitive form of Ki was kir or kiim.
- **10**- The Greeks called them the Annodoti.
- **11**- In the Book of Enoch, they are called the Nephilim, "The Sons of God," or the "Watchers".
- **12** -The Ulema call them Annakh or Al Annaki, meaning the people from above.
- **13** -In other parts of Anatolia, and especially in the lands of the Hittites, the Anunnaki were also called Anunnaku , and Ananaki .

Note:

The primordial Phoenician meaning of Anunnaki was: Those who gave us life. This meaning derived for the formation of three ancient Phoenician words:

- **a** -An'kh (Life; god; spirit) , so the first part “An” is used,
- **b** -Nunnak (From within),
- **c** - The letter “i” is usually added to the end of a Semitic word or a name to mean one of the following:
  - **a** -It belongs to;
  - **b** -It came from;
  - **c** -My.

For instance, the word Ab means father in many Semitic languages (Assyrian, Sumerian, Aramaic, Arabic, etc.) When we add the letter “i” to Ab, it becomes Abi, which means MY father. The letter “i” adds a sense of belonging and origin. Later on in history, non-Semitic people and neighboring civilizations in the Middle East, Near East, and Anatolia incorporated the letter i, in their vocabularies.

However, they attached to i, the letter g. And the new addition became “gi”, always meaning:

a-Mine;

b-My,

c-Belongs to.

\*\*\* \*\*

View of ancient Babylonia.

According to several linguists, the word Anunnaki is a loan word (Plural only) from Sumerian a.nun “n-a-k”, meaning literally : semen/descendants of the (Ak) monarch (Nun) and refers to the offspring of the king of heaven An/Anum.

Considered as a group of Akkadian and Sumerian deities, quite often, the Anunnaki were associated with the Annunna, meaning the fifty great gods. Annuna was written in various forms, such as:

- **a-** A-nun-na,
- **b** -Anu-na,
- **c** -Anuma-ki-ni,
- **d** -Anu-na-ki.

Various attributes or definitions were given to them, such as:

- **a** -Major gods in comparison to the Igigi who were considered minor gods.
- **b** -Those of a royal blood or ancestry.
- **c** -The royal offspring,
- **d** -The great gods of heaven and earth. An means heaven, and ki means earth.
- **e** -The messengers or subjects of god/king Anu.
- **f** - The children of Anu and Ki.

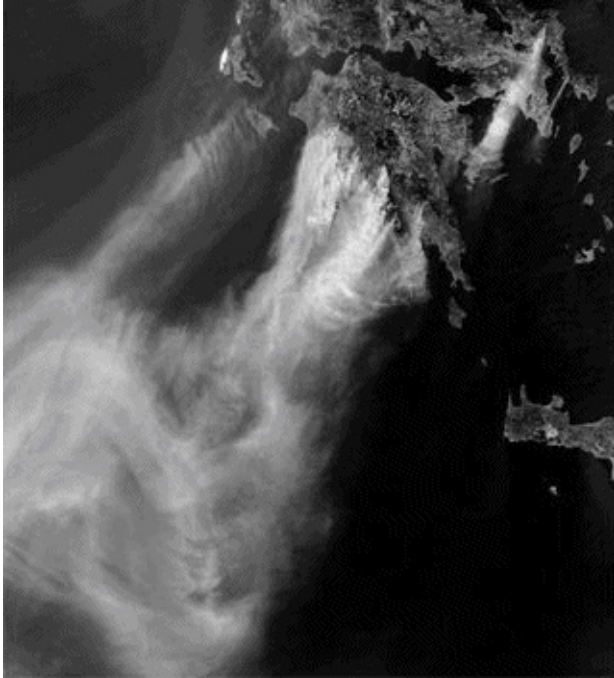

The early Anunnaki had strong relations with the Sumerians, the Phoenicians, the Hyksos, the Philistines, the Etruscans, the Druids, the Minoans, and the Arwadians.

The Anunaki appeared prominently in the Babylonian creation myth/epic, “ [Enuma Elish](#) ” .

In the late version, glorifying [Marduk](#) , after the creation of mankind, Marduk divides the Anunnaki and assigns them to diverse parts of the earth.

According to later [Babylonian myth](#) s, the Anunnaki were the children of [Anu](#) and [Ki](#) , brother and sister gods, themselves the children of [Anshar](#) and [Kishar](#) . And [Anshar](#) and [Kishar](#) were the children of Lahm and [Lahmu](#) , names/titles bestowed upon the gatekeepers of the [Abzu](#) temple at [Eridu](#) , sometimes referred to as “Chimiti” the genetic lab/site of the [Creation](#) .

\*\*\* \*\*

## Revelations by Anamidra

---

### I. Definition and introduction:

Anamidra is the name of the Anunnaki scientist who monitors the Earth Matrix, called Anamid-Raya, also Anid Ariya.

This Matrix is extremely complicated, because it is written in codes, symbols, geometrical forms, chemical formulae, theorems, “and in all the languages that have existed, still exist, and will be invented in the future after 2022,” said the Ulema.

In other words, it is a cosmic library, archives, and depository of all the knowledge and events of 5 billions years, the estimated date of the beginning of Earth.

## **II. Anamidra and Earth Matrix:**

Anamidra provided fascinating and mind-bending information in this matrix that have captivated academicians and leading scientists in the Eastern and Western hemispheres. Included in his data are detailed descriptions and explanations of:

- **1** -Primordial bio-engineering of terrestrial lifeforms (Elements, nature, animals, and humans);
- **2** -Building blocks of life, and how they acted like cells to produce life on earth;
- **3** -DNA’s fifth unknown element;
- **4** -RNA (Humans and non-humans) and life evolution;
- **5** -The origin and the genetic creation of the human races by the Anunnaki;
- **6** -The Earth-made human creatures;
- **7** -The Space-made human creatures;
- **8** -Metabolism and the oceans-made human creatures;
- **9** -Man-made humans and reverse engineering of the human brain;
- **10** -The Anunnaki’s “Conduit”.

### **III. Anamidra explains what kind of clay, the Anunnaki used to create Man:**

One of the most striking revelations of Sinhar Anamidra is his explanation of the “Clay” used by the Anunnaki to genetically create the first human species. The Anunnaki’s matrix mentioned clay as one of the primordial ingredients or elements they have used to create the human race. It is extremely important to understand the real meaning of the word clay.

Anamidra explained to the Ulema, that “Clay” is not what everybody understood or thought to be, from reading the translations of the Sumerian texts. It is not the earthly clay found in ancient Sumer near the Tigris and Euphrates banks. The Anunnaki’s matrix explained and defined it very differently. Judaism, Christianity and Islam got hooked on clay. Scholars who have translated the Sumerian texts and/or interpreted them made a huge mistake when they referred to clay as the mud or dirt substance the Anunnaki found in ancient Iraq, and mixed it with their DNA to create mankind...” said Ulema Govinda. The Anunnaki used a plasmic liquid that coagulated very rapidly, and short after, the coagulation took the apparent physical properties of the clay. But the substance was not dirt, rather plasmo-organic.

### **III. Anamidra explains the creation of Man from cosmic clay:**

Anamidra told the Ulema, that some of the very early human races were not created by the Anunnaki. The earliest human-animal species were originally created in space, and this included many animals and various plants. The life of the earliest human-animal species started within the clay found inside comets.

### **IV. Anamidra spoke about the early human species who lived underwater:**

Anamidra spoke to the Anunnaki-Ulema about the existence and origin of early human-like creatures who lived at the bottom of the oceans. He explained that “one of the earliest lifeforms on planet Earth began at the very bottom of the oceans, where metabolism originated through “Mai-ai” (Water). Metabolism created an early human-like form. Those creatures had a human skull, two eyes without retina, two legs and four long arms, but no nose, no ears, and no hair on their bodies.” They were called the Basharma’h. (Bashar means human race, and Ma’h means water.)

### **IV. Early intelligent lifeforms who lived inside Earth:**

These lifeforms produced intelligent creatures who inhabited several intraterrestrial regions, and were extremely advanced. They were known to the ancient Greeks.



Maria Orsic, the Ladies of Vrill and Thule members believed in a race that inhabited a “Hollow-Space” inside Earth.



## **M aria explains the world of extraterrestrials**

### **Maria explains the world of extraterrestrials**

In no particular order

---

#### **Ethics:**

Aldebaran and Ash.Ta.Ri extraterrestrials live in a world our human logic and mind can't understand. Although they (The extraterrestrials) do not practice any religion, their sense and understanding of ethics, justice, good and evil deeds, and merits are well developed. They see the universe, the development of the mind and a person's character quite differently from the way we do.

They take into a great consideration the consequences of an act, even a miniscule thought. They don't have courts of law, trials, tribunals, prosecutors, judges, lawyers and corporal punishment, but they have established rules that govern behavior, merits, deeds, and social justice.

“Their families, parents, children, relatives, and members of their communities are guided by social ethics and a moral law, far superior to our laws and religions...they have families like us...they feel like us...they work together in a perfect harmony, using a collective awareness shared by all...” said Maria.

(Note: This is exactly what Sinhar Anati said, and which I have published in one of my books on the Anunnaki.)

Worth mentioning here what Ulema Najani said on the subject:

“The Anunnaki have families, fathers, mothers, and children too, and they follow familial hierarchy, and family morality rules as we do here on Earth...”

Anunnaki Ulema Albard said, “Unlike other extraterrestrial races and species that are not built around family structure and parental bonds, the Anunnaki live within their own families perimeter, and show feelings and emotional reactions as we do...” He added, “The head of a living unit or a family is the father. However, the family is always placed under the direct guidance of a mother. Anunnaki society is matriarchal.”

### **Karma, Body’s Cells and the Extraterrestrial Mind:**

The word “Karma” does not exist in their vocabulary, for they don’t have the concept of reincarnation. Even though, physical death does not exist in their world, as we understand death on earth, all reach a point when and where the last cell of energy in their bodies ceases to function, thus resulting in the deterioration of their cells.

“After the deterioration of their cells...after they have lived for hundreds of thousands of years, their physical body that they were currently using fades away, but their mind recreates itself as a new copy of the physical body, because, each one of them has a multitude of copies of their body.

They can activate and reactivate the last fully functional and healthy cell of the Vril (In this context, by Vril, Maria meant the quasi-eternal cosmic energy of the self, including the universe), and reproduce it in a large quantity, and activate each newly created cell separately, thus recreating many copies of themselves, and restore them in a reversed eternal time storage.

On Aldebaran, I will never age, and my mind will grow healthier and wiser...” said Maria.

### **Aldebaran ’s Akashic Library:**

### **Learning from the Adelbaran’s Extraterrestrials and Anunnaki:**

“I am not afraid to go to Aldebaran, Jamara (Name of a planet rotating in their constellation) and Nimra (Another planet), for they (Extraterrestrials) told me that everything is going to be fine. Heike was

concerned because we don't know their language and their habits. But they told me once we are there, they will reconstruct our minds and bodies, and we will never suffer again or get sick. Their world is peaceful and beautiful. They will teach me many new things and I will learn about the greatest secrets in the universe...I will have access to their universal libraries which contains the Akashic records of the universe.

I found Maria's statements mind-bending, because they mirror what exactly the Enlightened Anunnaki Ulema told us centuries ago. The Honorable Masters explained to us that the Anunnaki and Aldebaran Akashic Library is not a library in the traditional sense, because it contains no physical books on shelves.

Each one of them (Extraterrestrials) has access to the global Akashic Records through the Akashic libraries, which are located in every community.

One enters through a huge door that is never closed, day and night. It opens into a huge hall, seven hundred to one thousand meters in length, by five hundred meters in width.

The hall is empty of any furniture, and is lit by windows that are placed very high, near the ceiling. The windows were designed in such a way that the shafts of light that enter through them are very sharply delineated and look like solid beams of light. At night, the same effect is achieved by enormous spot lights placed near the windows.

The effect is incredibly effective. Extremely large billboards hang on each wall. On the floor in front of each billboard are hundreds of pads. When visitors enter the library, they approach the billboard, stand each on a pad, and think about their destination within the building.

The pad has the capacity to read minds, and as soon as it does so, it begins to move, and it slides right through the billboard, which is not really solid but is made of a form of energy, carrying the visitor with it.

Behind the billboard is the main hall of the Akashic Library, called Mad-Khal.

The visitors find themselves in the presence of an immense screen, composed of a material not found on Earth. The screen is hard to describe; it can be compared to a grid, with a multitude of matrices and vortices of data.

The screen is contacted through the Conduit which is located in the brain's cells. The screen can read minds, and it knows right away what information the visitors seek. All what the visitors have to do is stand still in front of the screen, and the data will be displayed in sequences. Of course, the data is not represented by lines, sentences, or paragraphs, but rather by codes.

Each code contains particular information related to an aspect of the subject. For example, if you would like to visit Iraq, 2,000 A.D., Iraq 300 B.C., or Iraq 2,008 B.C., all you have to do is to focus on these dates, and three codes will appear on the screen waiting for your command to open them up.

From this moment on, the Conduit located in your brain and the Screen are communicating in the most direct fashion. The three files (The nearest description of these files would be to call them digital, for the lack of the proper word) will open up. Each one will contain everything that had happened pertaining to that particular date in Iraq.

The Conduit will sort out, classify, and index the particular data for the part of the information the visitor is most interested in.

Then, the information will be stored automatically in the cells of the visitor's brain, increasing the size of the depot of knowledge in the brain.

And because Anunnaki are connected to each other and to their community via the Conduit, the data recently absorbed is sent to other Anunnaki to share it, which is extremely beneficial, since if the data received from the screen is difficult to understand, the Anunnaki community called Jama, or an individual Anunnaki, will send, also automatically, the explanation needed.

This is quite similar to an online technical support on earth, but it is much more efficient since it functions brain-to-brain. Each Anunnaki community have the same kind of center for these mirrors of knowledge which are the Akashic files. The complexity of the centers though, is not the same.

Some of the Akashic Libraries include more perplexing and complicated instruments and tools, which are not readily available to other communities.

These tools include the monitor, which is also called mirror or Miraya in Ana'kh. Each Miraya is under the direct control of a Sinhar (A leader), who serves as custodian and guardian.

It is very important to protect the privacy of every member of the community, because individuals could attempt to tap into the data of the Miraya and have access to the codes of the telepathic communication of others, thus enabling them to read the mind of all the community members, something that is considered highly unethical and absolutely must be avoided.

The screens, by the way, can expand according to the number of codes that the researcher is using. Seven to ten codes are normal. If more codes than that are opened, the screen is fragmented into seven different screens, which are only visible to the mind. An amazing phenomenon occurs at this moment; time and space mingle together and become unified into one great continuum. This enables the researcher to grasp all the information in a fraction of a second.

An added convenient aspect of the Akashic files is the ability of the researcher to access them in the complete privacy of the researcher's home or office, since part the files can be teleported there. But since the private screen is not as complicated as the central one in the Central Library, no multiple screen will open up, only the original one. It is important to understand that the data received is not merely visual. There is much more to it than that.

By the right side of the screen, there are metallic compartments as thin as parchment paper, which serve as a cosmic audio antennae, called Min-Zar.

These compartments search for, and bring back, any sound that occurred in history, in any era, and on any planet. And this is just a minor part of it, because it brings additional sounds from other dimensions, and para-galactic civilizations (Terrestrials and extraterrestrials).

According to the extraterrestrials, every single sound or voice is never lost in the universe. The voice is never lost, because it is energy and it stays in the perimeter of its sphere, call it for now, atmosphere, space, *etc.* The Anunnaki combined asset of the visual and audio systems provided by the screen, gives anybody the ability to learn languages afforded by the Akashic Library.

This applies to any language – past, present or future, and from any part of the universe.

The researcher can call up a shining globe of light that will swirl on the screen with enormous speed. As it rotates, the effect blends with an audio transmission that comes from the metallic compartments.

In an instant, any language will sink into the brain's cells. On the left side of the screen, there are conic compartments that bring still images of certain important past events. This mini-screen-display informs the researcher that these particular events cannot be altered.

In other words, the Anunnaki cannot go back in the past and change it. The Anunnaki are forbidden to change or alter the events, or even just parts or segments of past events represented on the conic compartment, because these images represent events created by the Anunnaki themselves.

This restriction works as a security device, an essential one. For example, a young Anunnaki cannot visit

planet Earth sixty five thousand years ago, enter the genetic lab of the Anunnaki in Sumer or Phoenicia, and change the DNA and the genetic formula originally used by Sinhar Enki, or Sinhar Anu, to create the human race, or the seven prototypes of the human race created by Sinhar Inanna.

Sinhar Inanna herself can go back and change it, but not for use on earth as we know it. She has to transpose it and transport it to another dimension, parallel to the original dimension where the event occurred. This safeguard means that Sinhar Inanna cannot recreate a new race on our earth by sending us, the current living humans, sixty five thousand years ago back in time, remoulding us, and then bringing us back to the twenty first century as new specie, or a new race.

This would be unethical. All she could do would be to recreate her own experiment in another dimension.

For instance, Inanna can go back 2,000 years in time and space, reconstruct the DNA of Jesus Christ and create a new Jesus. But the new Jesus will not exist on the map of year 1, or return to Bethlehem to be re-born again. He will be transported as a grown man to another dimension not very much different from the Palestine Jesus knew.

Before the extraterrestrials' screen in the hall of the Akashic Records, more options are available for research, and one of them is a sort of browsing. Inside the screen, there is a slit where the mind of the extraterrestrial can enter as a beam.

This will open the "Ba'abs", or Stargates, to other worlds that the researcher is not even aware of, but appeared randomly as part of the discovery or exploration.

In each slit there is another Akashic file that belongs to other universes, worlds, dimensions, and civilizations, sometimes more advanced than the Aldebaran's people and Anunnaki themselves, where the researcher can either retrieve important information, and/or witness the creation of the future.

It is like going back in the future, because everything that exists in the present, or shall occur in the future, has already occurred in a distant past and needed time to surface and appear before the eyes of the extraterrestrials.

The term Akashic is herewith used because many of us are familiar with what it means and represents, and to a certain extent refers to the contents of historical events and thoughts recorded in "human history."

In the Aldebaran-Anunnaki context, it is the record of cosmic events that occurred in multiple galaxies. The reason it is called the Akashic/Cosmic Library is because it has equipment that allows the researcher to connect to the Akashic/Cosmic Records; the vast compendium of knowledge encoded in a non-physical plane of existence, in a substance that is called Akasha.

In Ana' kh, it is called Ab.Har, or simply Har.

\*\*\* \*\*

**And what is Ana'kh, the script Maria Orsic received telepathically from the extraterrestrials?**

---

Ana'kh is the language of the Anunnaki and the Aldebaran's extraterrestrials who descended on Sumeria and Phoenicia according to the Ulema.

It is of an extraterrestrial origin.

Part of the Anakh language lexicon is preserved in the Book of Ramadosh, and in Al Hak; a manuscript in the custody of the Ulema.

Ulema Albakr stated that Anakh was used by early human beings who lived on the Island of Arwad, in Tyre, Sidon and Mu. He added that from the Ana'kh derived the primitive languages of the Near East and the Middle East.

Many words in Hebrew, Aramaic, Syriac, Coptic, Phoenician, Akkadian, Hittite, Babylonian, Urdu, Mesopotamian, Sumerian, Arabic, Hungarian, Egyptian, Armenian, Enochean, Nabatean, and Aramean derived from the Anakh.

Many of the original words of this language, as well as numerous linguistic derivations are included in this book. Ana'kh was never made public.

It remained a secret language known only to the Ulema, and later on to the Allamah.

Anakh sounds Semitic, because of its phonetics. But it is “not Semitic at all”, said Ulema Ghandar Gupta. It has no grammar, but it has an extremely rich in vocabulary and an abundance of metaphoric expressions. Another Ulema said, that the original name of Jehovah or Yahweh derived from the Anakh word Yaw. Also, a considerable number of Akkadian and Sumerian words that appeared in the Sumerian Epic of Creation derived from the Ana'kh.

Around 569 A.D., a group of Ulema in the Near East (Non-Islamic scholars) compiled an extensive list of Ana'kh words and phrases.

In 625, A.D., two leading figures of the Ulema brotherhood wrote the Book of Ramadosh; a compilation of Ana'kh terminology, a lexicon, and Kiraats (Readings). Ulema Albaker stated that the Ulema is not a religious group.

They are not Muslim. In fact, they were persecuted by the companions of the Prophet Muhammad, and were expelled from the Arab Peninsula. They found refuge in Cyprus and Marseille.

But he was quick to point out that the early Sufi masters, poets and Sufi trance dancers were Ulema.

He added that Ulema should not be confused with the Islamic Ulema who teach Islamic law, or with the Allamah who were the leading Islamic figures of science and letters in medieval times.



Dr. Farid Tayarah, an Ulema himself, and a former head of a Masonic Lodge stated that the Ana'kh was used during Masonic sessions.

He added that a considerable number of Masonic words and expressions are pure Ana'kh, especially those words referring to levels and degrees in Freemasonry. It is an intriguing situation to say the least.

\*\*\* \*\*

### **Ana'kh words in Semitic and ancient non-Semitic languages**

---

Ana'kh, the Adelbaran extraterrestrials and Anunnaki language had a major linguistic and epistemological influence on the languages of the ancient world, as well as upon the civilization, culture and religions of the ancient Near East, and Middle East, including but not limited to the Phoenicians, Sumerians, Assyrians, Akkadians, Chaldeans, Babylonians, Mesopotamians, Copts, Hittites, Egyptians, Arabs, and Hebrews.

Many of the Ana'kh words entered the early languages of those civilizations, and from the original Ana'kh, derived thousands of ancient Semitic and non-Semitic words and expressions, some very noticeable in Akkadian/Sumerian epics such as the Epic of Gilgamesh, and Enuma Elish, as well as in the Epic of the Phoenician Cosmogony.

For instance:

- **1** -The Ana'kh word " Ab", meaning father became Ab in Arabic, Abu and Abuya in Aramaic, Abba in Hittite, so on.

- **2** - The Ana'kh word Baa-ni. Ana'kh/Ulemite. Architect; designer; builder.

From Baa-ni, derived the Assyrian word Bani and the Arabic Bani or Al-Bani, which means a builder; an architect.

Sinhar Marduchk said: "Fi baa-ni arda imanu." Translated verbatim: "In the builder, I planted my trust." From the Book of Rama-Dosh.

Fi means in. Baa-ni means builder or architect. Arda means I put, planted. Imanu means trust; confidence.

From the Ana'kh Arda, derived the Hebrew word Eretz, and the Arabic word Ard which mean earth, or soil. And from the Ana'kh Imanu, derived the Arabic and Ulemite Iman, which means trust; faith.

- **3** - The Ana'kh word Badan : Reverence. From Badan, derived the Assyrian and Persian Abadan and Appadan which mean temple; a place of worship; a shrine.

Arabic linguists claim that the Persian Apadan (Appadan) is derived from the Arabic Abidin (Worshippers) and/or from Abada or Ibada (Act of worship). While Persian linguists assert that the Arabic words Abada, Ibada and Abidin derived from the Iranian Apadan.

Here is a historical reference taken from the Inscriptions of Artaxerxes: "Aga sum Apadan Dariyauz abu abi abi-ya itebus." Translated verbatim: "This named Apadan Darius my great grandfather made."

Worth mentioning here that the ancient Persian word Apadana means temple, and it was used hundreds of years before the words Abada or Ibada were incorporated in the Islamic Arabic vocabulary, including the Quran and Hadith Sharif (Dialogues or speech of the Prophet Mohammad.)

- 4 - The Ana'kh expression Baliba nahr usu na Ram.

Translated verbatim: "The water of the river purified my people." Attributed to Sinhar Marduchk in the Book of Rama-Dosh. Baliba means flows of waters. Nahr means river (Same meaning in Hebrew, Phoenician and Arabic).

Usu means to clean or purify.

Na means my or our.

Ram means people (Same meaning in Phoenician, primitive Arabic, early Armenian and ancient Hebrew).

The Ana'kh word "Usu" also means to dig.

We find similar meaning in the Annals of Sardanapalus: "Nahrtu istu nahr zaba anta ahri nahr babilat kanin sumsa abbi." Translated verbatim: "A river from the upper Zab I dug and its name I called."

- 5 - The Ana'kh word Gibishi: Power. From Gibishi, derived the Assyrian word Gibis, which means might; power; strength.

It did appear in the Akkadian and Sumerian clay tablets. "Mili kassa mee rabuti kima gibis tihamti usalmi."-Nebuchadnezzar.

Translated verbatim: "A collection of great water like the might of the sea I caused add it."

"In gibis libbi-ya u suskin galli-ya er asibi."-From the Annals of Sardanapalus. Translated verbatim: "In the strength of my heart, and steadfastness of my servants, I besieged the city."

"Ana gibis ummani-su mahdi ittagil."-From the Obelisk of Nimrud. Translated verbatim: "To the powers of his great army he trusted."

"Ina gibis emuqi sa Asur bil-ya."-From the Annals of Tiglath Pileser. Translated verbatim: "In the boundless might of Assur my lord."

So on...

\*\*\* \*\*

# Chapter 4

## Answers to Questions on Your Mind

---

1-Q: Why did Maria and members of Thule and DHvSS keep the project of building the Vril secret?

A: The amazing aspect of the Orsic-Vril story resides in part in the secrecy of its construction.

Why did many of the members of Thule and DHvSS who have invested in the project, and were pro-war, pro-Hitler and some were extremely fanatic Nazis hid Maria's spacecraft from Albert Speer, Himmler and the Luftwaffe?

To many of us, this is incomprehensible! Even absurd. Not really.

They kept everything secret for many reasons:



Berthold Konrad Hermann Albert Speer.

In 1934, Speer became Hitler's chief architect, minister of German armaments in 1942, and German armaments and war production minister in 1943.

To name a few:

**First reason:** They knew that once Heinrich Himmler becomes aware of the existence of the craft, he will take over, confiscate the machine, and kick them out.

**Second reason:** Many believed that Maria's machine could be used after the war as a supersonic transatlantic airplane which would generate lots of profits; after all, it was a revolutionary invention, a fantastic airplane unmatched and unrivaled in its concept, speed and originality.

Grosso modo, they wanted to protect their investment.

**Third reason:** Many still believed that Maria's aircraft was not 100% reliable, and if Himmler controls the project, and finds out that it is not working the way he wanted to work, this lunatic will eliminate them without any hesitation, for he was known for his cruelty, and viciousness in treating other engineers and scientists who either failed in SS's assigned projects, or did not produce the kind of results Himmler expected; the man was a monster, he killed numerous scientists who in his wicked and twisted mind did not deliver.

So, the fear of being killed by Heinrich Himmler was one of the major reasons for keeping the project top secret.

**Fourth reason:** They knew that Speer has began nationalizing private companies and factories and enlisting civilian engineers; Thus, their machine, efforts, investment and especially their freedom will be

totally absorbed by Hitler's war machine.

**Fifth reason:** This last reason came much later in this saga.

Those who became aware of how things behind the curtain, and on the battlefields started to shift in the favor of the Allies, began to think very seriously about their survival; their lives were on the line, and the only way to get the hell out of Germany before it collapses, was to jump in this damned aircraft and fly to one of the destinations they had in mind, such as Argentina, Venezuela, Peru, Chile, Ecuador and Brazil. In this context, the aircraft was their safety blanket.

\*\*\* \*\*

2- Q: Are the Aldebaran's people (beings of light) Anunnaki or an extraterrestrial race similar to the Anunnaki?

A: They are the offspring of the Anunnaki.

\*\*\* \*\*

3- Q: Did the Aldebaran people speak Sumerian?

A: Yes. But they used Ana'kh (Anunnaki language) and an old Babylonian dialect identical to Sumerian when they sent their messages to Maria.

\*\*\* \*\*



4 -Q: Are they multi-dimensional or something else?

A: Multi-dimensional.

\*\*\* \*\*

5 -Q: Why a highly advanced galactic community, perhaps billions of years ahead of us would contact a nineteen year blond girl from Germany, instead of Hitler himself, the master of Germany, the Pope or the President of the United States?

A: Maria was not contacted by the leaders of the Aldebaran.

Ulema Anunnaki Sorenztein explained the reason. He said, "It is vital and important to understand that extraterrestrials might contact some of us.

But this does not mean that their contact was initiated by their leaders, governing organism or they are talking on behalf of their entire race in isolated contacts, and messages sent to contactees.

We have radio's amateurs around the globe.

At one time, it was a big deal to use a long or short wave radio to contact people from around the world, while sitting in a garage or around a kitchen dining table. And it was fun and exciting too.

Quite often, "individual extraterrestrials" or an "independent groups of extraterrestrials" contact other extraterrestrials and even humans, just for fun or to socialize.

Nothing is unusual about this. Especially if these extraterrestrials are genetically similar (To a certain degree) to the human race.

Remember, life duplicates itself in an incomprehensible manner throughout the universe, and numerous civilizations who share the immensity of the universe resemble us on biological and molecular levels.

\*\*\* \*\*

6 -Q: Did the Aldebaran's people rescue Maria Orsic when Heinrich Himmler issued an order to shoot her?

A: We don't know. But obviously they did help her to get out of Germany. Maria explained exactly what they did.

\*\*\* \*\*

7 -Q: Life On Aldebaran: Do those extraterrestrials live like us? Do they have families, kids, puppies, music, a social structure, or they are simply non-biological entities, totally different from us?

A: The answer is provided on page 165.

\*\*\* \*\*

8 -Q: Are they coming back?

A: Yes, in 2022.

\*\*\* \*\*

9 -Q: Is Maria's Vril-UFO a real UFO?

A real Merkabah, the Anunnaki spaceship we are familiar with, and which was referred to in ancient scriptures and the Bible as the "God's Chariot"?

A: Yes, it is a superflying physical machine which resembles the Anunnaki's Merkabah. Is it identical? Nobody knows.

\*\*\* \*\*

10-Q: And did the Aldebaran's extraterrestrials really give Maria a technical data on how to build this UFO-Chariot thing?

A: Yes they did, and based upon that technical data, Maria's spaceship was built.

\*\*\* \*\*

1 1-Q: Why didn't the extraterrestrials from Adelbaran speak to Maria in German? This could and would have simplified lots of things to Maria and to the Ladies of Vril, and made the situation clearer?

A: I agree. And I don't know.

\*\*\* \*\*

1 2-Q: Of course, they communicated with her telepathically, but is telephatic communication a mental projection limited to images and voices only, or much much bigger, more varied, and more important than

that, thus containing transmission of knowledge and wisdom in a multitude of forms and languages, including German, for instance?

A: It is all of the above, except that telepathy does not need the mastery of a language to make a mental communication possible.

\*\*\* \*\*

13-Q: Is Maria Orsic still alive?

A: Yes, but not on Earth.

\*\*\* \*\*

14-W hy Walter and Reinmar Horten the legendary designers of Horten 229, and who had access to Maria's UFO technical data did not build an Aldebaran UFO when they fled to Germany, and instead, they designed very ordinary passengers' airplanes, and one type of military jets for Peron? Why passengers and cargo airplanes and not real UFOs??

And why Peron's airlines consisted of DC-3 and DC-4, instead of super flying machines?

It is well-known that Juan Peron modernized the Argentinian Air force between 1947 and 1950, and Argentinian engineers produced Pulqui I and Pulqui II (Designed by Kurt Tank, a German scientist), two highly advanced jet aircrafts, which reach a speed of 1000 kilometers per hour, and later the IA 58 Pucara and the IA 63 Pampa, but I don't see UFOs here!!

What did happen to Maria Aldebaran technical data?

A: The Horten brothers promised Maria to never duplicate her spaceship. However, part of her Aldebaran's technical data was used by American scientists who worked on one type of UFO, and they

succeeded in their efforts.

15-Q: Is it true that after the United States Air Force, the Defense Department and the CIA have cancelled the Avro Project Y, renamed “Weapon System 606 A”, “ Avrocar” and “VZ-9AV” (The first American-Canadian UFO), continued secretly to build Maria’s UFO in Area 51, and Wright Field, outside Dayton, Ohio, and a UFO prototype was shipped to NASA’s Ames Research Center at Moffett Field, California?

A: YES!!!!!!!

\*\*\* \*\*

16-Q: Were our first UFOs built according to Adelbaran-Orsic technical data and extraterrestrial messages?

A: Absolutely!

\*\*\* \*\*

17 -Q: An did engineer John Frost, the mind behind the Avro UFO use Maria Orsic-Aldebaran technical data to build the first Canadian-UFO, under the guidance of Lt. Colonel Horten, a friend of Maria Orsic?

A: Yes!

\*\*\* \*\*

18 -Q: And why some of the notes of Mr. Frost were written in a script resembling cuneiform inscriptions?

A: Because originally, Maria’s data was written in cuneiform and Ana’kh.

\*\*\* \*\*

19-And what were the questions of the United States Air Force and the CIA about the cryptic Sumero-Akkadian-Ugaritic notes of Mr. Frost?

A: They did not ask questions!

They already knew about Maria's Sumerian-Ana'kh script since the end of World War Two.

\*\*\* \*\*

20-Q: Did Maria reach Aldebaran?

A: Maria said that they were waiting for her at the 33.33 degree stargate line. This leads me to believe that it is possible.

\*\*\* \*\*

21 -Q: Did the contacts and messages between Maria Orsic and the Aldebaran extraterrestrials change any of our conceptions or understanding of the universe and the world we live in?

A: Yes to few. None whatsoever for the skeptics and all those who do not believe in extraterrestrials and UFOs.

\*\*\* \*\*

**Maria Orsic's Predictions**

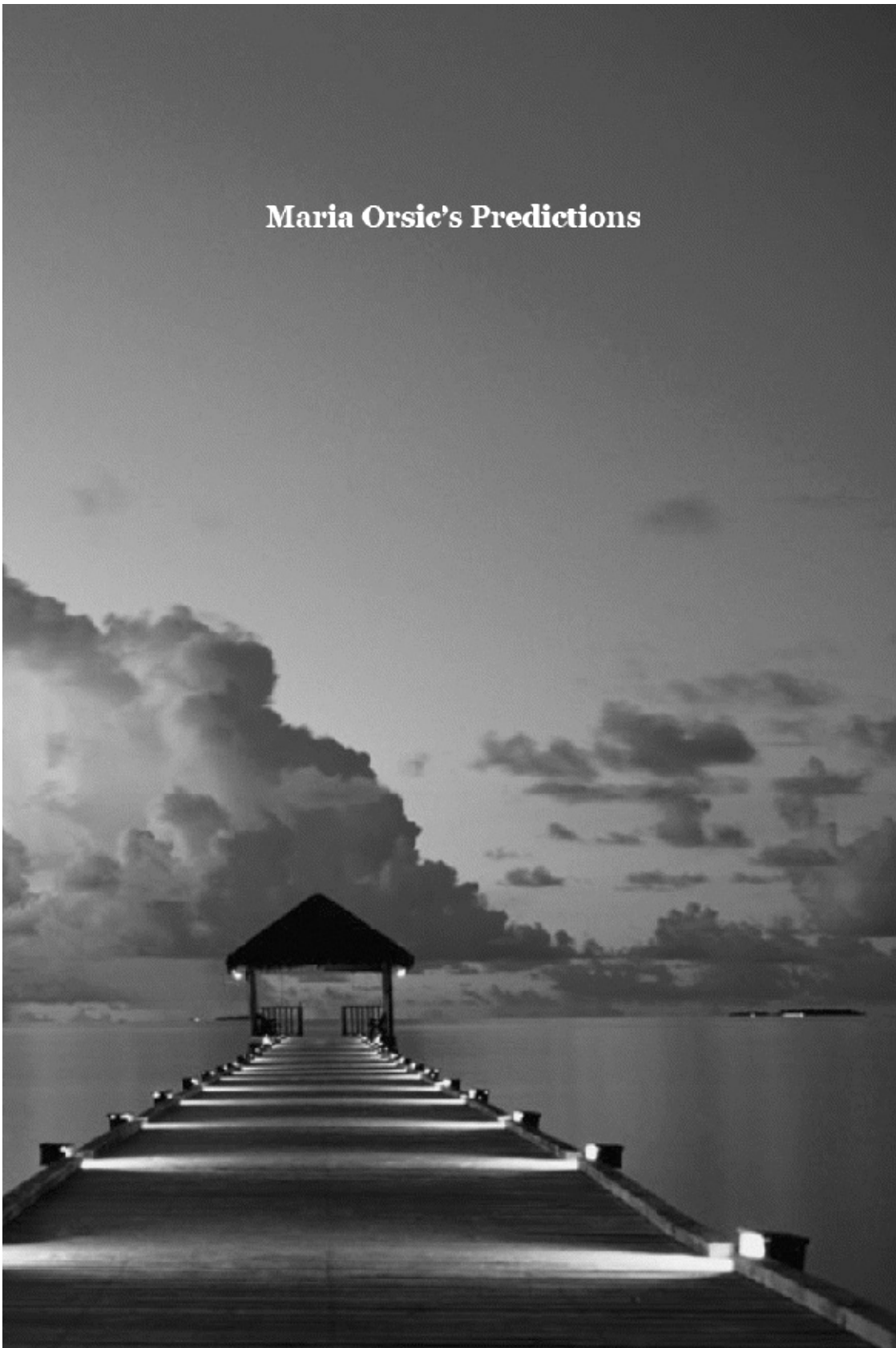





# Chapter 5

## Maria Orsic's Predictions

---

1. A clash between us and an aggressive alien race is inevitable.
2. A Third World War is inevitable. It will be fought from above. Humanity will be decimated. But the human race will survive.
3. All the people of the Earth will witness the return of the Beings of Light (Extraterrestrials). They will return to Earth before or in 2022. Major changes will occur on many levels. But the nature of humans will not change completely.
4. America will rise as the most powerful country in the world, and it will last for very very long time.

5. Before the end of the 21<sup>st</sup> century, millions of people are going to die in a matter of a few days. Their death will be caused by frightening clouds of ashes that would cover the entire sphere of Earth.

This is a major apocalyptic event, and it is the direct result and consequences of humanity's greed and selfishness.

It is regrettable.

6. By the mid of the 22<sup>nd</sup> century, all the meeting points and stations (Stargates) on the 33.33 degree line will be activated. And expect civilizations from other worlds to visit us on a regular basis. By then, our knowledge of the universe, space and time will allow us to easily visit far distant planets and stars in the unknown universe. It is the beginning of a new history for all of us. History is written from above.

7. Earth will be ruled by a new breed of women.

8. Europe will be united as an economic block, and adopt a new monetary system. But Europe's infrastructure, and the ways of life of its people will remain the same. It could be a good change, and it could affect world's affairs.

But it will not change the world. For the world will only change when the extraterrestrials return to Earth.

9. Germans will continue to manufacture super flying machines (UFOs) but outside Germany. However, they will not last for long. Another country will take over.

(Note: Did she mean the United States? It is not clear.)

10. Germany will be divided into pieces.

11. Germany will lose the war before the end of 1945.

12. My days are numbered on Earth. I have the feeling that I am not going to be able to accomplish my mission.

This is an internal feeling, I hope I am wrong.

13. Organized religions will become frail relics of the past. And as science and technology advance, people of the Earth will meet super beings from other galaxies.

And they will learn great things. And they will discover their true nature. And religions built upon power will vanish.

14. Within two centuries, the human race will land on other planets and establish habitats with different species. They could live in peace and prosper in their new world, only if they leave behind their wallet.

15. The Jews will have their own land. Israel will become their new country. The Arabs will revolt but they will be crushed. Israel and its neighboring countries will soak into blood.

The Jews will get back their promised land, but at what price?

16. The Russians will control the entire Eastern Europe.

Atrocities will be committed. Countries will be ravaged. But the Communist power will weaken, and

Eastern countries will be free again, because the Bolshevik empire will collapse before the end of the 20<sup>th</sup> century.

17. The beings of light will return to Earth before or in 2022. Major changes will occur on many levels.

But the nature of humans will not change completely.

18. Earth will be visited by beings from different worlds who are willing to advance our standards of living everywhere on Earth. Unfortunately, only an elite will benefit from their technology because people in power will keep it secret, and for themselves.

\*\*\* \*\*



Maria Orsic's Quotes



# Chapter 6

## Maria' Orsic's Quotes

---

- The machine I am building is for the whole humanity.
- Eating flesh (Meat) is savagery. (She was vegetarian)
- The Nazis never trusted me; and it was mutual.
- Adelbaran is a beautiful place, simply because there is no greed and no violence on Adelbaran.
- I am not special. I am simply lucky, I just entered their zone by pure coincidence, and I never knew how. (Talking about why and show she was able to communicate with the extraterrestrials and vice versa)



- They are beautiful and they glow. (Talking about the Adelbaran's extraterrestrials)
  
- My days are numbered on Earth. I live on a borrowed time. (She knew that by 1945 she will be leaving Earth)
  
- Lust destroys creativity.
  
- You can fully trust people who care for animals; cats, dogs and pigeons, especially pigeons. (She was an animal-lover)
  
- Father Konrad said Himmler looks funnier than his chickens. This is an insult to chickens. (Father Konrad is Father Konrad Fuchs who upon asking his opinion about Maria, said: "Not all saints are Catholics.")
  
- Professor Schumann is the most honorable man I have ever met. He didn't argue; he explored. And he didn't criticize; he accepted the possibility that he could be wrong. This is why he had a brilliant mind, and a noble character. I am sad he was not chosen to accompany me to Adelbaran.
  
- The beings of lights (Extraterrestrials) told me how sad they were for not creating us perfect...and they became sadder because they gave us all the possibilities and opportunities to do it on our own, and we didn't.

- I was guided when I drew the sketches (Drawings of her spacecraft). They are important to me because they are my link to the beings of lights and humanity's better future.

- On reaching higher dimensions: Those who are lucky enough to be taken to the planet of the beings of lights (Aldebaran's extraterrestrials) will live for ever; their mind and body will remain intact and will acquire properties which will allow them to transcend time and space. They will never age, they will never suffer again and their essence will constantly be upgraded, and metamorphosed into higher beings. And the unfortunate ones will die. But they will be given a 40 day period after their death to decide whether they want to remain in the "neutral zone of nothingness" or elevate themselves to a higher dimension. Thus, humans' fate is not the same for all of us. And each one of us will have a chance to progress. It is simply a matter of choice.

- On contact with extraterrestrials: Contact is possible only if the extraterrestrials tune you in; there are particular times to communicate with aliens. You can't do it on your own.

- Sex is what ruined the human race, and alienated us from our creators. Sex is the most destructive weapon people have at their disposal.

- You can't be a medium if you work for somebody else.

- The Vril cosmic power is within all of us. Search for it inside your heart.

- “So long my friend, I leave with you a big part of my heart...” (Talking to Dr. Schumann, when she saw him for the last time.)

- Goodness and happiness are hard to find, but they are duplicated in the other world and you will have plenty of time to enjoy them....only if before you leave this Earth, you will remember to forgive, to sing a beautiful song, and feed your pet...

- Our civilizations would last longer, only if we could share our success with others.

- Stay away from organized religions, if you want to learn the truth and walk into the light.

- I am leaving behind a distorted history of humanity and atrocities committed by the name of God. How delighted I became when they (The extraterrestrials) told me that God exists only on Earth.

- How can you fully trust Men again, after they have called Mary Magdalene a whore and Eve a piece from Adam?

- Learn the noble truth from unspoiled nature, and loyalty from your pets.

- The beings of lights told me that they reproduce through the mingling of lights. This is how they

wed. And this is why they glow.

- On Adelbaran, I will never age, and my mind will grow healthier and wiser.

\*\*\* \*\*

- I am not afraid to go to Adelbaran, Jamara (Name of a planet rotating in their constellation) and Nimra (Another planet), for they (Extraterrestrials) told me that everything is going to be fine. Heike was concerned because we don't know their language and their habits. But they told me once we are there, they will reconstruct our minds and bodies, and we will never suffer again or get sick. Their world is peaceful and beautiful. They will teach me many new things and I will learn about the greatest secrets in the universe...I will have access to their universal libraries which contains the Akashic records of the universe....

\*\*\* \*\*

# Chapter 7

## The United States and the paranormal aspect of UFOs, and military interests

---

### **American psychics were called in.**

During the early stage of the United States meetings with the aliens, (1947-1948) no less than 3 psychics were brought to the table. One of them was a very-well known medium, originally from Bombay –but naturalized American. Two months later he was dismissed.

The psychics were not useful at all, and all their attempts to communicate with the aliens failed. Maria Orsic explained to us that communication with extraterrestrials is possible only if they initiate contacts.

The psychics were brought in because the military thought that this “Alien phenomenon” was of a paranormal nature.

Of course, the military did not describe the aliens’ spacecraft as a paranormal thing, because they have already started to call upon scientists and engineers to find out how the spacecraft flew, and how the military can reverse the aliens’ technology.

Nevertheless, the mere idea that these aliens and their crafts were not from this world pushed the military to explore all the possibilities, including the supernatural and religious aspects of the phenomenon.

By the end of 1949, the services of the psychics were permanently terminated by the military. But in March of 1950, one psychic was recalled when a two star general brought to the discussions table the files of the “Vril- Gesellschaft”.

In 1959, **von Braun stated:** *“We find ourselves faced by powers which are far stronger than hitherto assumed, and whose base is at present unknown to us. More I cannot say at present. We are now engaged in entering into closer contact with those powers, and within six or nine months time it may be possible to speak with more precision on the matter.”*

\*\*\* \*\*



Dr. von Braun

Dr. von Braun admitted that Maria Orsic Vрил was successful. In fact, secret reports show that he tried to duplicate one of Maria’s small crafts (UFOs).

Newspapers in Norway, Germany and Sweden published articles to that effect.

---

**Joseph Banks Rhine:**





Dr. Joseph Banks Rhine with his wife,  
Dr. Louisa Rhine.

---

The psychics were joined by Dr. Joseph Banks Rhine, founder of the Parapsychological Association. Dr. Rhine was known for his pioneering parapsychology laboratory and research center at Duke University.

Dr. Rhine spent approximately 180 hours on researching and assessing the paranormal aspect of the alien phenomenon.

By July of 1950, all supernatural and paranormal studies of the aliens came to a halt. And from that moment, no more psychics were asked to attend any meeting with the aliens.

However, ironically or coincidentally, during that time (1950-1951), a “branch” was created by an intelligence agency (Not the CIA) to carry on similar research and experiments, and to develop programs related to the power of mind, auto-suggestion, “psychic espionage”, and similar topics.

And to set the record straight, the “Branch” was not controlled by the CIA, NASA, DOD, DOE, USAF, the army and/or other macabre secret and vicious agencies, as it was falsely claimed by some ufologists and conspiracy theorists. As a matter of fact, the “Branch” was headed by a civilian psychiatrist, and entirely operated by civilian scientists, psychologists and physicians. The “Branch” reported directly to a committee created by The White House.

And for several months, the findings of the Branch, and the reports of the Presidential Committee were kept secret.

It was not until mid November of 1951 that the Branch’s studies, findings and reports were shared with other agencies and the military.

But the reports, recommendations, memoranda and summaries of the Presidential Committee were known only to the President of the United States and two of his personal advisors/assistants; Dr. Vannevar Bush was one of them.



From left to right: Dr. Vannevar Bush, President Harry Truman, presenting James B. Conant with the Medal of Merit and Bronze Oak Leaf Cluster on May 27, 1948.

---



President Harry Truman with members of the National Defense Research Committee: Roger Adams, Vannevar Bush, standing, third from left, K. T. Compton, James Bryant Conant, Alphonse Raymond, Albert Baird, Jerome Clarke, Frank B. Jewett, Alfred Newton, Lewis Hill, January 20, 1947.

---

### **Military Interests:**

From 1946 to 1949, the Russians were extremely interested in the German Bell-UFO and the Nazi extraterrestrials “Super Flying Machines” designed by:

- SS top scientists
- Mediums from “Thule-Gesellschaft”
- Members of the “Thule Society” ,
- Members of the "Brüder Des Lichts",
- Members from the “Schwarze sonne” and so on.

And of course, Joseph Stalin received numerous reports on Maria Orsic, founder and leader of “**Vrilerinnen**”, **the Vrils**, and **her** direct contact with extraterrestrials from the Aldebaran.

This is an absolute fact; the original German sketches of the super flying machine and other circular and

crescent-shaped flying discs were seized in Germany by a special military task force created by General Dwight Eisenhower, 6 months after the end of World War Two.

So everybody, Americans and Russians, British and Poles , French and Italians have heard rumors about Maria Orsic, the German UFOs, and luckily for us, our armed forces in Germany, at the end of the Second World War, put their hands on Germany's secret files on UFO, the RFZ 1 (Rundflugzeug 1), the Horten 229, and several anti-gravity projects carried by Germany's top scientists.

This is documented in:

- a- United States naval intelligence files;
- b -OSS's files ( P recursor to CIA );
- c-British Secret Service (MI6) files;
- d-General Dwight Eisenhower Special Task Force reports,

And other classified sources, I will not talk about.

\*\*\* \*\*

As soon as the Red Army captured Berlin, the Russians began looking for Germany's top military scientists, and particularly those who worked on Maria's Vril, the V1, V2, and projects related to UFO.

The Red Army captured 657 German scientists and shipped them to Moscow. A few weeks later, they were sent to military bases and laboratories scattered in several Russian cities.

My sources tell me that:

- a-15 German scientists died before they began to work on any project related to UFO and similar programs;



From left to right: Mikhail Gurevich, Artem Mikoyan.

---

- b-345 German scientists were immediately deployed in secret locations;

- c-32 German scientists were smuggled outside Russia (To Austria and Switzerland) by Allied forces secret agents and spies, and some ended in the United States and Great Britain;

- d-100 German scientists became leading figures in the Russian space programs, avionics, weapons systems, and instrumental in numerous space and rockets programs under the leadership of eminent Russian scientists and engineers like:

a-Artem Mikoyan

b-Mikhail Gurevich

c-Sputnik's Sergei Korolev

d- Sergey Aleksandrovich Afanasyev

e-Mikhail Tikhonravov

Worth mentioning here that:

a-Prof. Robert Dopel

b- Andrei Sakharov

c- Igor Kurchatov

Played an instrumental role in the Russian early study and research of alien reverse engineering.

- e-And the rest of them were unaccounted for.

Nobody knows what happened to them.

\*\*\* \*\*



Andrei Sakharov and Igor Kurchatov.

---



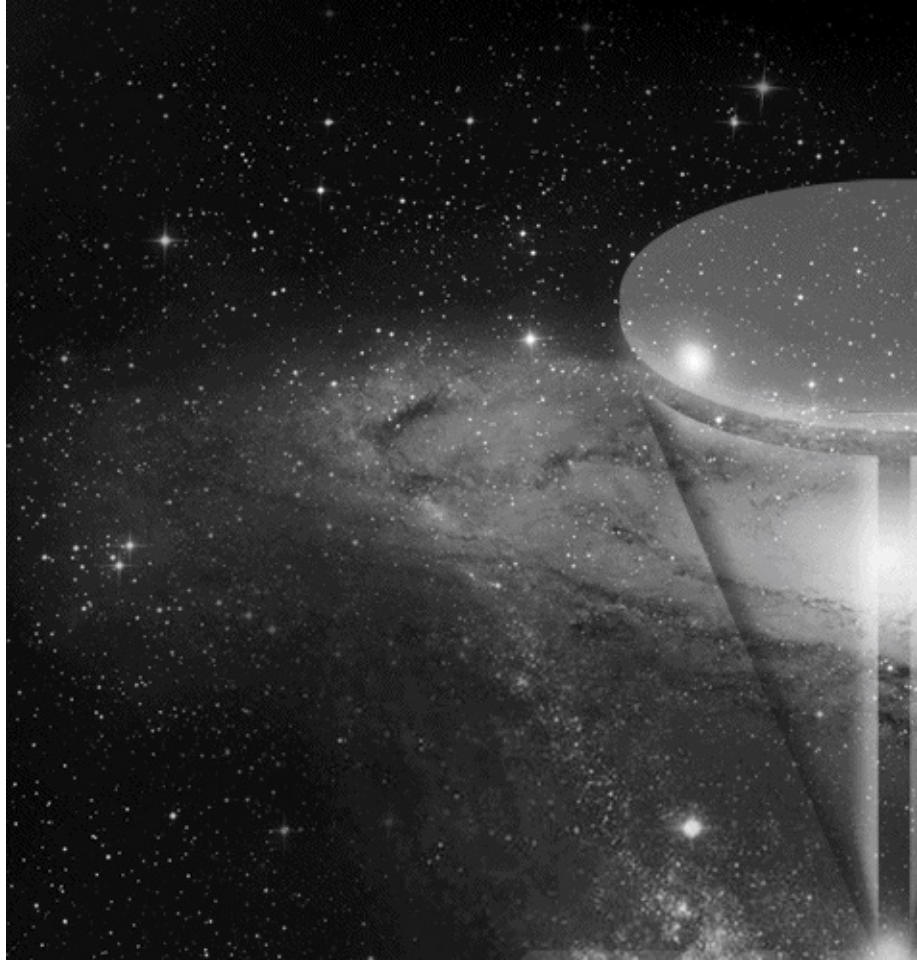

From left to right: Mikhail Tikhonravov, Sergei Korolev,  
pausing in front of Konstantin Tsiolkovsky.

---

## Nikola Tesla and the Extraterrestrials

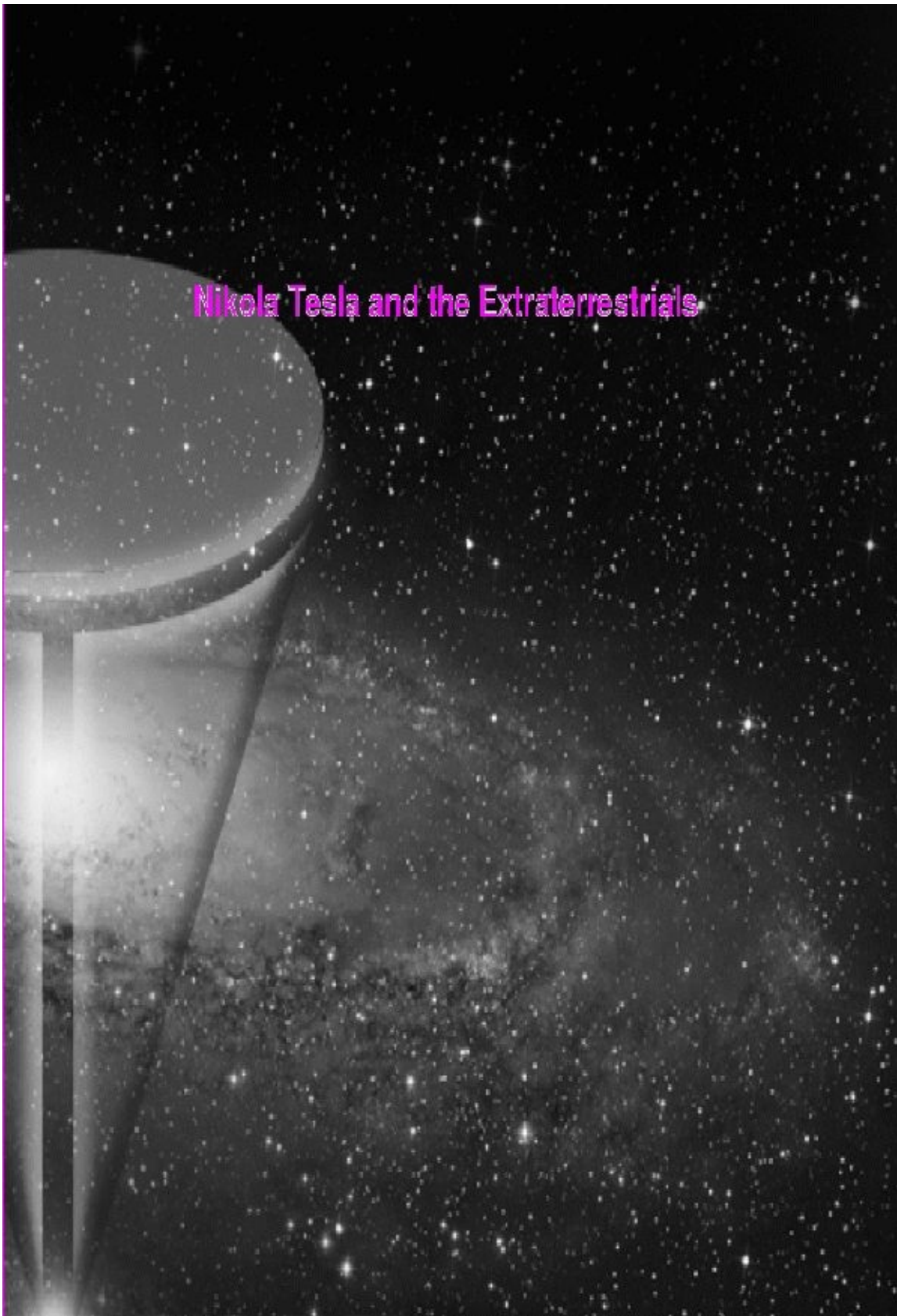

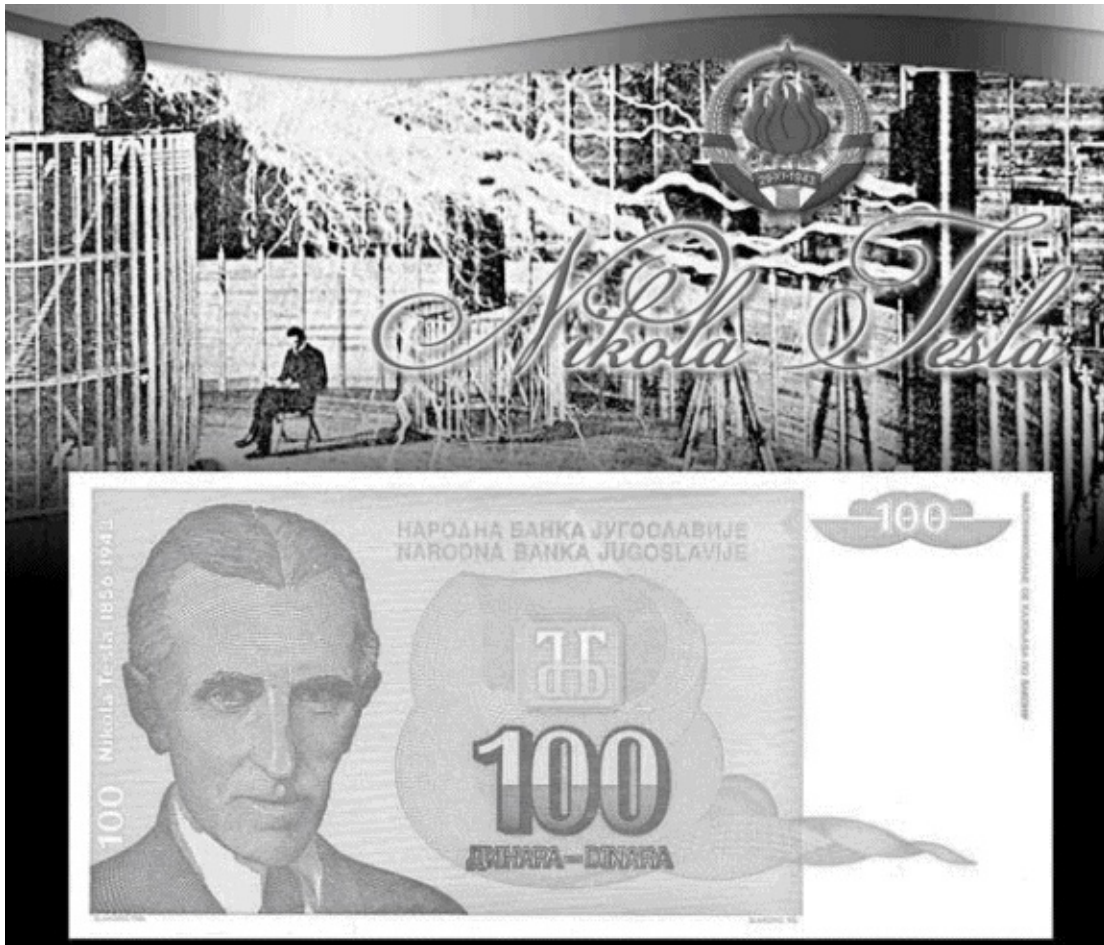

# Chapter 8

## UFOs, Aliens, Aliens' Rapture, Nikola Tesla, and the United States Government

---

**What is the aliens' rapture?**

### **I. Definition and introduction:**

It is part confrontation/collision, and part separation.

Although extraterrestrials are highly advanced, their high level of technology and baffling scientific knowledge are not categorically a code for morality and ethics.

Science, whether on planet Earth or beyond, can be used for ill purposes. Such possibility exists all over the universe.

Thus, frictions, confrontations, oppositions, separation, and wars on the galactic landscape of extraterrestrials happen on a regular basis.

In fact, the very first time, humans have heard of visitors from outer space, was through depictions of aliens' destruction of cities on Earth, and wars between God and the Fallen Angels, and between the Nephilim, the Biblical Giants, the Watchers, the Guardians, the Legions of Darkness, and the Shining Ones, in the Bible, in the holy scriptures, in the banned books from the Bible, in the Gnostic scrolls, and ancient Mesopotamian clay tablets. And all them were of an extraterrestrial stock! Aliens' destruction of cities, burning people alive, and turning humans into pillars of salt were neither promising, nor reassuring for

humankind.

So yes, extraterrestrials can fight each other, as we do often here on Earth. And Nikola Tesla was very concerned.

## **II. Channeling with extraterrestrials and entities from galactic civilizations is impossible :**

Of course, we don't know much about the social structures and social values of highly advanced beings on other planets.

Basically, what ufology's literature provides on the subject comes from channelers, experiencers, and contactees who allegedly met extraterrestrials, and received their "spiritual" messages through telepathy, as they often claim.

For zillions of reasons, I do not take seriously these messages and channeling business.

Mainly because, contacts with extraterrestrials via channeling is impossible. And if such channeling does in fact exist, the human brain's frequencies and mental communications do not cross the frontiers of our solar system.

Unless, those channelers are using some sort of mind-boggling interstellar beams, and/or intergalactic mental/radio waves faster than light.

Even light bends on itself, gets distorted, and dissipates in the no-time-no-space zones. Grosso modo, channeling (from Earth) with extraterrestrials and entities from galactic civilizations is impossible. But Maria Orsic was an exception.

## **III. Any authoritative source(s) on the aliens' rapture and extraterrestrials' communications?**

## **1. Introduction:**

If this is the case, then we have no way at all of knowing what is going on in other planets, and particularly about duels, feuds, and rapture among extraterrestrial civilizations.

That is correct.

However, there are obscure, authoritative and very few sources that tell us something about the aliens' rapture, its origin, past or current development, and how it could affect the present and future of humanity.

These sources also reveal baffling governmental "notes", and top secret memoranda on extraterrestrials' communications between two (or more) alien spaceships.

## **2. Some of these sources are:**

- **a** -The Anunnaki-Ulema.
- **b** -The Book of Ramadosh.
- **c** -Statements by Anunnaki-Human-Hybrids.
- **d** -Statements by two highly respected astronomers, currently teaching at leading American universities, and working at some of the world's most advanced observatories.

Their names will not be released, even though, they gave their statements on the History Channel and the Science Channel in the United States, in 2008.

- **e** -Opinions of bona fide scientists (Astrophysicists, cosmologists and astronomers) who worked at SETI, for a very long time.

Their names will not be released, even though, they gave their statements in open discussions, and on the History Channel and the Science Channel in the United States, in 2008.

- **f** -Opinions and claims of eminent scientists and professors at Moscow Academy of Medicine

(Moscow Sechenov Academy of Medicine), given in 1987, and in 1988. Their names will not be released, as long as, they are still teaching at the academy.

- **g** -World War Two famous cryptologists who worked on the German Enigma Machine codes, ciphering machines, and teleprinters, previously located in Room 40 of the British Admiralty Building, an undisclosed unit of Britain's military intelligence.

- In 1957, they explained how the British in 1956 and in 1959, tried to decipher some extraterrestrial messages. For national security reasons, their names shall not be released.

- **h** - *Nikola Tesla's papers: There is no doubt, Nikola Tesla who was in touch with Maria Orsic knew a lot about the extraterrestrial phenomenon.*

*Sava Kosanovic reported that his uncle Nikola Tesla told him about the German Bell-UFO, and Maria Orsic's Vrtil, and in one of his correspondences with Marshal Tito, he explained to the Yugoslavian leader how these machines could work.*

The personal files of Nikola Tesla, seized by the United States government, right after his death in 1943, revealed beyond the shadow of doubt, that:

- **a** -UFOs are real,
- **b** -There are many planets inhabited by intelligent civilizations,
- **c** -A contact with extraterrestrials is possible, if we have adequate instruments,
- **d** -Some galactic civilizations are in constant confrontation with other civilizations, and are part of the aliens' cosmic rapture.

#### **Nicola Tesla's files on the extraterrestrials:**

##### **Tesla's "Exotericon Gama" file.**

One of the most sensitive and frightening topics involving Nikola Tesla, was his "Death Beam" invention. The FBI and the United States military intelligence units/branches became extremely interested in his invention, and its practical use as a weapon.

The White House and the Pentagon feared that Tesla's beam blueprints might fall into the hands of the Soviets. But his files included more than the blueprints of the "Death Beam".

Special agent "A", and Special Agent "C" stumbled on a Tesla's file called "Exotericon Gama".

On the back of the file, the word "Government" was written in blue ink. At that time, nobody took the Exotericon very seriously.

The top brass at the Pentagon thought Tesla is "Nuts", despite the fact, that they were fully aware that some of Nikola Tesla's undisclosed inventions could change the face and history of modern weaponry.

Written in codes and in ancient Sanskrit, Tesla described in the Exotericon (Later, to be called Tesla Government File):

- 1. How extraterrestrials communicate;
- 2. The sequences of dots, "1", and "O" in the extraterrestrials' messages;
- 3. A warning sent by an extraterrestrial civilization to another galactic colony.

At the end of World War Two, the United States government (Possibly, through President Harry Truman's Secretary of State, General George C. Marshall who was in charge of the secret correspondence with the British) asked the help of the decipherers at the British Admiralty to decipher Tesla's code, which was closely related to aliens' recorded messages by Tesla. In fact, Tesla claimed that he has received messages from extraterrestrial civilizations. And his nephew Sava Kosanovic publicly stated that his uncle told me that he has received two messages from the extraterrestrials.

In a documentary on Tesla's legacy, PBS stated, word for word, and unedited: " The morning after the inventor's death, his nephew Sava Kosanovic hurried to his uncle's room at the Hotel New Yorker, in New York.





National Bank of Yugoslavia introduced this 100 dinars bill which features Nikola Tesla.

---

He was an up-and-coming Yugoslav official with suspected connections to the communist party in his country. By the time he arrived, Tesla's body had already been removed, and Kosanovic suspected that someone had already gone through his uncle's effects.

Technical papers were missing as well as a black notebook he knew Tesla kept—a notebook with several hundred pages, some of which were marked "Government."

Note: The notebook marked "Government" is the very same file originally called by Tesla "Exotericon Gama", related to extraterrestrials' communications.

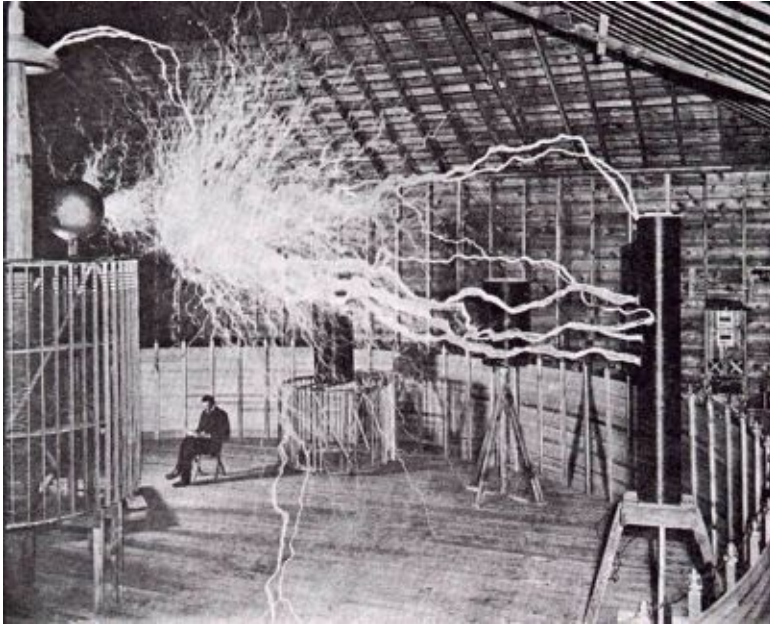

*N ikola Tesla (Fourth from left) with  
15, 1942.*

*Third from left is Tesla nephew Sava  
Kosanovic.*

*Tesla's papers were seized by the  
FBI, after he passed away in his  
room at the New Yorker Hotel.*

*His papers included elaborate  
details, drawings and blueprints of  
an anti-gravity flying machine,  
which closel y resembled the  
German Bell-UFO, and Maria*

*Orsic's Vril.*

*Sava Kosanovic reported that his uncle Nikola Tesla told him a lot about the German Bell-UFO, and in one of his secret correspondences with Marshal Tito of Yugoslavia, he explained to the Yugoslavian leader how these machines work.*



*N ikola Tesla in his lab .*



Nikola Tesla

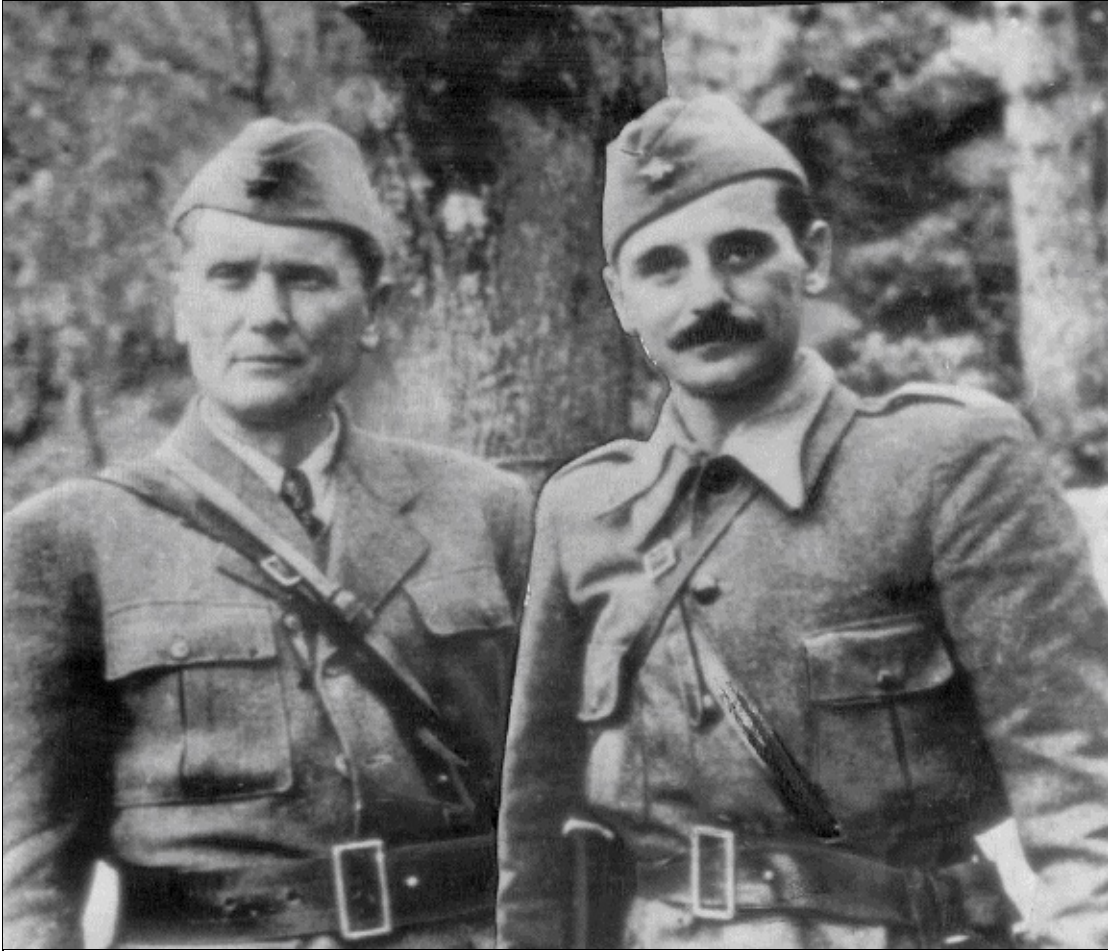

Death mask of Nikola Tesla, one of the greatest minds of all times...cheated by Thomas Edison and ridiculed by the United States Air Force and Dr. Edward Teller.

From Left to right: Marshal Josip Broz, Yugoslavia's leader, better known as Tito with Major General Koca Popovic, commander of the partisan First Army Corps. *March 14, 1944.*

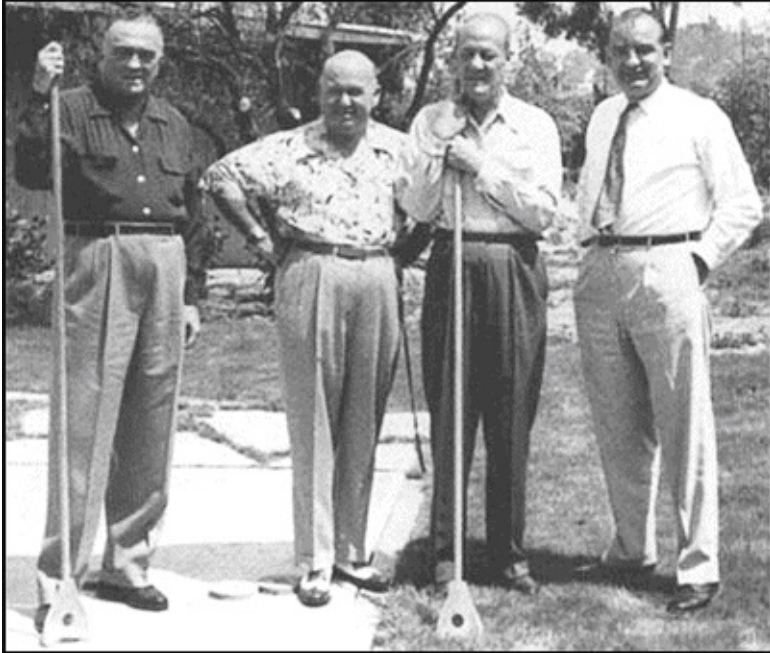

*Marshal Tito was fully aware of the German Bell-UFO whole spectrum. And he did talk about it in his correspondence with Nikola Tesla.*

---

**Foxworth, assistant director of the New York FBI bureau was called in**

---

P. E. Foxworth, then, assistant director of the New York FBI bureau, was called in by Hoover to investigate, to gather all Tesla's scientific documents (Available and missing) and to come up with a list of Tesla's friends, especially those who were known to have a tie with the communists.

Back then, Foxworth stated that the United States government was "vitaly interested in preserving Tesla's papers...for posterity...and further scientific studies..."

Now we know that the United States government's interest in preserving Tesla's papers was neither of an academic nature, nor the preservation of the work of a genius.

My sources tell me that "Just two days after Nikola Tesla's death in New York, four officials from the Office of Alien Property (OAP) went to his room at the New Yorker Hotel and confiscated everything Tesla had in his room.

Absolutely everything, including his "robe-de-chambre" and shoes." The FBI and OAP used the word "possessions", instead.

Note: The word "Possessions" means all his possessions, including all personal effects, scientific drawings, formulae, and particularly the "Beam Death" file (N. Tesla Death Ray as later called by the FBI), and the "Government file on UFOs".

### **J. Edgar Hoover, Dr. Trump and Tesla's files:**

The "scary report" of Dr. Trump.

J. Edgar Hoover, then, director of the FBI called Dr. John G. Trump, a scientist (An electrical engineer who worked at the National Defense Research Committee, established by the Office of Scientific Research and Development "OSRD"), and asked him to study and assess the two files in question.

At that time, the OAP has already sent to Hoover, a duplicate of those files. My sources tell me, that Dr. Trump provided Hoover with a "scary report" on Tesla.



From left to right: J. Edgar Hoover, Royal Miller, Clyde A. Tolson and Joseph McCarthy.

---

This is exactly how Trump's report was viewed and called by Hoover himself, and the director of the FBI bureau in New York.

**Clyde A. Tolson hides Dr. Trump's report .**

Hoover, as usual, a smooth talker and a master of disinformation and threats, kept the original report of Trump in the secret vaults of the FBI. Fearing that something might happen to the secret vaults, Hoover asked his close friend Clyde A. Tolson to hide Trump's file somewhere nobody could find.



Photo: Clyde A. Tolson.

Later, rumors surfaced that Tolson kept Trump's report in the attic of an aunt of his who lived in a small apartment on Wisconsin Avenue, Northwest, Washington, DC.

**Hoover falsified/switched Dr. Trump's report.**

Pressed by the Pentagon, OSRD, and OAP to release the report of Dr. John Trump, Hoover at once, summoned Trump and asked him to come up with a new version of his report, and to delete any references made to extraterrestrials, and to the "Ray of Death".

A deja-vu camouflage that echoes the infamous fake photos of the Roswell's "Weather balloon" wreckage, manufactured and displayed by the military.

**Dr. Trump's conclusions:**

Here are Dr. Trump's conclusions: "His thoughts and efforts (Meaning Tesla) during at least the past 15 years were primarily of a speculative, philosophical, and somewhat promotional character often concerned with the production and wireless transmission of power; but did not include new, sound, workable principles or methods for realizing such results."

And that was the end of the story and Tesla's files saga.

But was it? No!

**Tesla, Brigadier General L. C. Craigie, and Patterson Air Force Base, and the "Project Nick."**



My sources tell me that around November 17 or 19, 1947, the Pentagon called Brigadier General L. C. Craigie to inform him, that they will be sending him Nikola Tesla's "Government File" (Exotericon), and "Tesla Beam File" for his evaluation.

The big boys at the Pentagon became convinced that the extraterrestrials code deciphered by Tesla could help them solve some of the mysteries of the alien technology and the "Beam Stick" they found on the site of a UFO crashed near Roswell.



N ikola Tesla 2 room suite at the Hotel New Yorker, on January 12, 1943. From left to right: Bogoljub Jevtic, then member of the Royal Government of the former Kingdom of Yugoslavia, Professor Dr. Boris Furlan, and Sava Kosanovic, Nikola Tesla's nephew and a diplomat.

I nside one of the rooms Nikola Tesla occupied at the New Yorker Hotel.

---

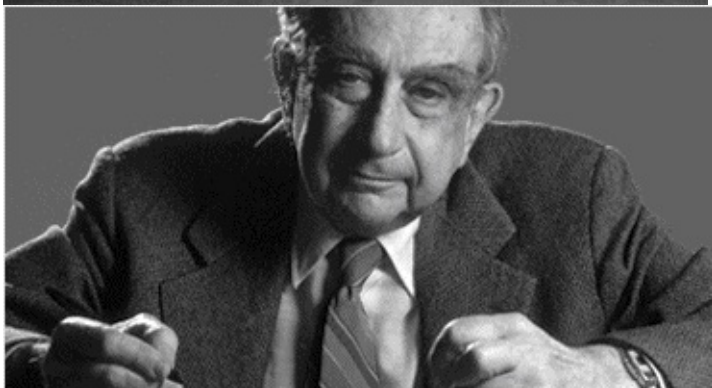

Dr. Edward Teller.

---



On November 21st or 22<sup>nd</sup>, 1947, the files were dispatched to Patterson Air Force Base in Dayton, Ohio, where Brigadier General L. C. Craigie started a secret operation code-named "Project Nick". Nick refers to Nikola Tesla.

Dr. Edward Teller and von Braun were called in to participate in the operation, and to lend their scientific expertise.

Craigie began a series of experiments with no apparent success.

**Note on Brigadier General L. C. Craigie:**

**Lt. General L. C. Craigie's Promise to Truman:**

Photo: Lt. General L. C. Craigie.

Major General L. C. Craigie began working on Nikola Tesla files, but he was mainly interested in the Tesla's files on the extraterrestrials, and the machine Tesla constructed for the sole purpose of contacting aliens. It was also heard, that Major General L. C. Craigie, later found a stack of papers on Maria Orsic, and other documents pertaining to a



script written in an unknown language to the military.

It was also reported that Edwin Easley, (He was in charge of security and retrieving debris from the UFO crash site near Roswell) who at the time was Provost Marshall for the Army Air Force was asked to report to Major General L. C. Craigie. Later on, it was discovered that Edwin Easley amassed huge data on Tesla's extraterrestrial files and submitted a report to President Truman.

His daughter, Nancy Easley Johnson, stated on the July 1, 2003

Larry King Live Show that her father promised President Truman not to say a word about the UFO crash and Tesla's extraterrestrial dossiers.

But on his deathbed, Edwin Easley finally told his two daughters that he had seen "alien creatures" at the Roswell crash site, and the aliens messages of Nikola Tesla were real.

\*\*\* \*\*

Left, standing, Nancy Easley Johnson, daughter of Major Edwin Easley the UFO crash site in 2002.

She stated on the July 1, 2003 Larry King Live Show that her father had promised not to talk about what had happened in Roswell.



At Fort Worth Base (Carswell AFB), on November 19, 1949, from left to right: Lt. General Curtis LeMay, then, head of Strategic Air Command, Senator Richard Russell, Major General Roger Ramey, then, head of the 8<sup>th</sup> Air Force at Carswell, pilot John Bartlett, the

Air Force Secretary Stuart Symington, Senator Lyndon Johnson, and Congressman William Thornberry. All except Thornberry, and pilot Bartlett, were the architects of the UFO non-disclosure policy.

Lemay and Ramey reviewed the “1947-1948 Aliens Transcripts” as well as Nikola Tesla’s Exotericon file on extraterrestrials.

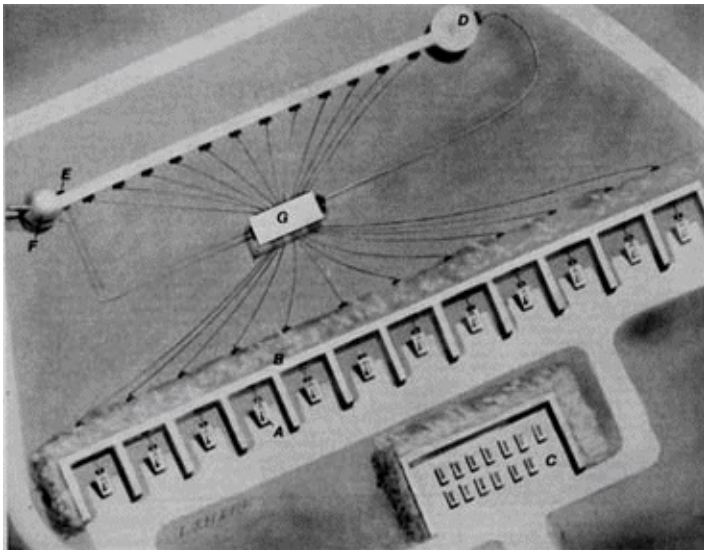

Dr. Vannevar Bush.

Dr. Vannevar Bush reviewed the “1947-1948 Aliens Transcripts” as well as many of Nikola Tesla’s notes and files on extraterrestrials.

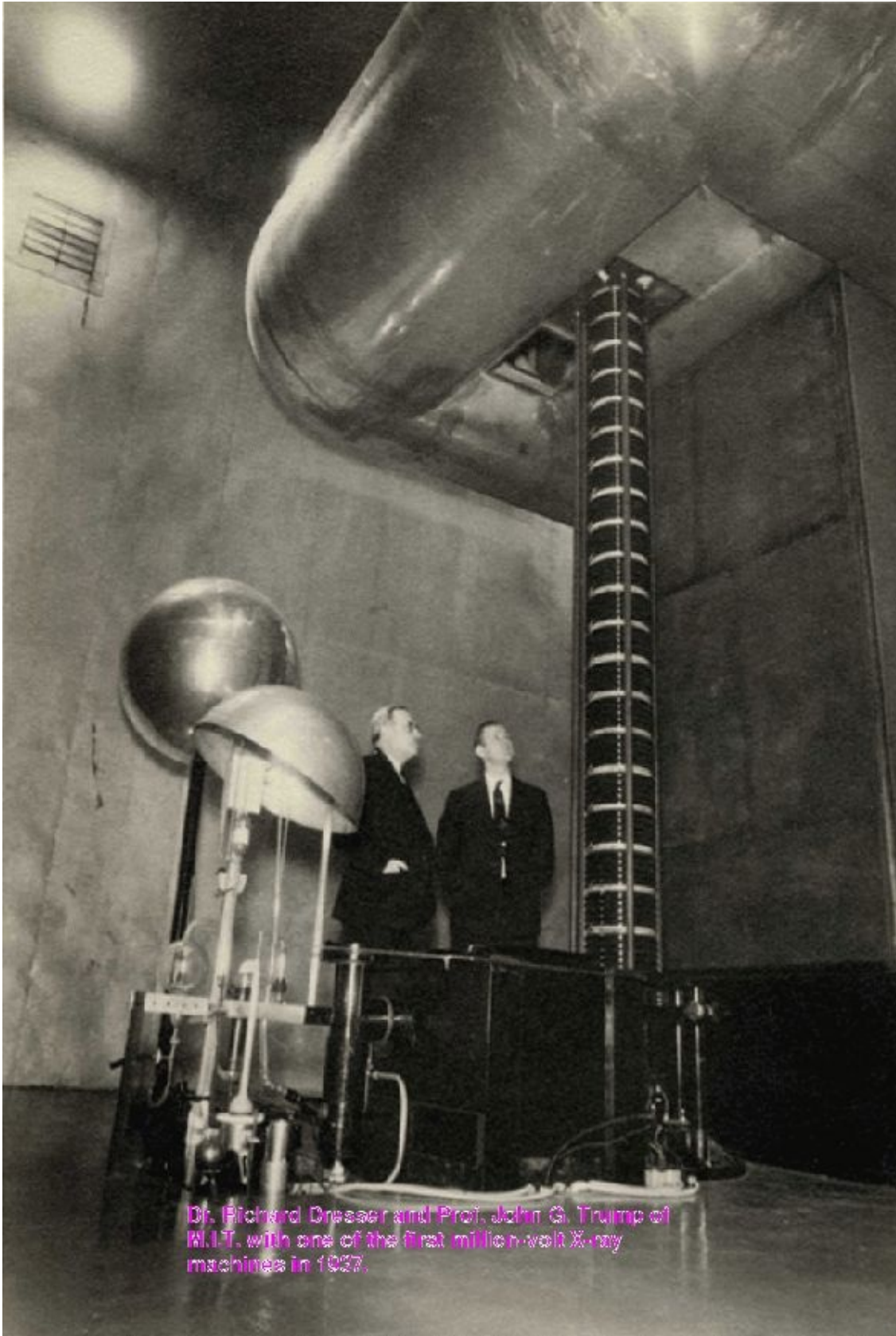

Dr. Richard Dresser and Prof. John G. Trump of W.I.T. with one of the first million-volt X-ray machines in 1927.

United States aerial reconnaissance photo of a Russian beam weapon (based upon Tesla's invention)

installation near Semipalatinsk.

---



Dr. Enrico Fermi (left) at Los Alamo.

Dr. Fermi publicly ridiculed the UFO

phenomenon, yet secret reports, and the “1947-1948 Aliens Transcripts” clearly show that he attended two meetings with aliens in a secret United States military base. Dr. Edward Teller and Dr. von Braun were present at the meetings.

---



**More scientists, including Fermi were called in.**

One week later, Nobel Prize winner Dr. Enrico Fermi from Los Alamo was called in.

On January 17, 1948, an Italian scientist, who apparently has worked on some projects by Guglielmo Marconi

was flown from Rome to Dayton, Ohio.

Around June 1948, the military discontinued “Project Nick”. And that was the end of the Tesla’s files on extraterrestrials and ray of death. Really?

Not so!!

\*\*\* \*\*

**“ Project Nick” is now “Project Lexicon”!**

Few things we know for sure:

1. All the files of Tesla vanished from the face of the earth.



2. The military instructed Teller, von Braun, Fermi, and the “Marconi Guy” (As he was called by peers) to keep their “mouth shut.”

3. The military continued “Project Nick” under a new code-name: “Project Lexicon”!! Very a propos, considering the military interest in deciphering the extraterrestrials’ language, coded messages between two alien spaceships, and above all, the warning the military received from aliens they have apparently met on two occasions on a military base.

4. Dr. von Braun and Dr. Teller were so eager to put their hands on Maria Orsic’s correspondence with Tesla.

### **Extraterrestrials’ warning.**

From the extraterrestrial warning, some military scientists concluded that the extraterrestrials are fighting each other, and some alien species are already here on Earth, preparing for a major confrontation.

What kind of confrontation?

Nobody knew at the time. However, in a third meeting with the aliens, the military learned that a “Gray Alien” species living underwater, and in an adjacent dimension, will confront the Americans, unless an agreement is reached between the aliens and the United States government.

The aliens did in fact refer to an “Alien Rapture” that has occurred under the nose of an “Galactic Extraterrestrial Council”, commonly known in ufology’s literature as the “Federation”.

\*\*\* \*\*

**What’s left from Tesla’s files fell into the hands of senior officers from the former Yugoslavian army.**

My sources tell me that in 1952, and upon the continuous requests and demands of Yugoslavia's Tito to release Tesla's papers, a bulk of Tesla's files and some personal effects were released to Sava Kosanovic. A colonel from the Yugoslavian army met with Kosanovic to take possession of Tesla's papers.

Reluctantly, Sava Kosanovic released Tesla's "remaining" papers to the Yugoslavian colonel.

For years, no scientist or journalist from the West was allowed to see Tesla's papers. And nobody knew what kind of secrets and/or military weapons blueprints Tesla's papers contained.

But everything changed in 1950, when a scientific committee in Belgrade announced, that Tesla's papers will be finally displayed in public, and the scientific community will gain direct access to Tesla's drawings and blueprints of his scientific discoveries, and inventions, except documents related to Maria Orsic.

### **Soviet Premier Nikita Khrushchev's announcement to the Supreme Soviet (Presidium).**

In 1960, Soviet Premier Nikita Khrushchev told the Supreme Soviet that "A new and fantastic weapon was in the hatching stage." No doubt, he was referring to Nikola Tesla's inventions, and Maria Orsic's Vril.

Some double agents claimed that Khrushchev was bluffing as usual.

### **Tesla was concerned about the "Safety of Earth"!**

In 1953, Sava Kosanovic told a close friend that Tesla on two occasions showed a serious concern about the "safety of earth". According to Kosanovic, Nikola Tesla told him that the world is no longer a safe place, and that he was working on a weapon system to counter aliens' attacks.

Tesla also told him, that he has learned from an intercepted extraterrestrial communication between two alien races, that the aliens are fighting each other, and one race is intending on colonizing earth. The rapture in the Council of Extraterrestrial Colonies has divided the aliens, and a hostile alien race which is no longer a member of the Council will invade earth and enslave all of us. Some work in sync with an alien race living underwater.

### **Sava Kosanovic detained for two full weeks.**

My sources tell me, that the military and intelligence agencies in the United States learned about what Kosanovic has said to a friend about aliens threat and Orsic's Vrtil, and detained him for two full weeks.

A few days later, Sava Kosanovic vanished from the face of the earth!

### **Further investigations of Tesla's scenario of the alien rapture.**

The Tesla's "Aliens' Rapture" scenario was neither disregarded nor ignored by the military and intelligence community. Further investigations of the "Rapture", Maria Orsic's Vrtil, and Tesla's "Death Ray" (Beam Weapon) continued until 1958.

### **President Eisenhower allocated a huge budget.**

In fact, before the end of 1958, President Eisenhower, secretly, and without telling the Congress, allocated a huge budget for a Top Secret project, requiring the creation of a military base for the purposes of:

- **a** -Studying and developing a charged-particle beam weapon;
- **b** -Developing a military defense strategy to face any possible alien invasion caused by the "Aliens' Rapture";
- **c** -Exploring the possibility of entering into a "final and friendly agreement with aliens" to prevent any clashes with hostile aliens.

Note: The 1958 original blueprints and specs of Eisenhower's proposed military base were used in their entirety, when the military built AUTEK base in the Bahamas. Of course, the latest weaponry systems, and the world's most advanced technology were added to the repertoire of AUTEK.



A UTEC base in the Bahamas.

---

L L Jackson commander of the base, 1969.

---

1-9-43 11:30 PM

TO: DIRECTOR

FROM: SAC, NEW YORK

SUBJECT: UNKNOWN SUBJECTS. [REDACTED] EXPERIMENTS AND TESLA, DECEASED. ESPIONAGE - N. NIKOLA TESLA, ONE OF THE GREAT STANDING SCIENTISTS IN THE ELECTRICAL FIELD, DIED IN NEW YORK CITY, NINETEEN FORTY THREE AT THE HOTEL NEW YORKER, NEW YORK CITY. DURING HIS LIFETIME, HE CONDUCTED MANY EXPERIMENTS IN CONNECTION WITH THE TRANSMISSION OF ELECTRICAL POWER AND [REDACTED] THE DEATH OF [REDACTED]. ACCORDING TO INFORMATION FURNISHED TO THE SAC, [REDACTED] SIX FIFTH AVENUE, NEW YORK CITY, THE NOTES AND EXPERIMENTS AND FORMULAE TOGETHER WITH DESIGNS OF [REDACTED] THESE ARE AMONG TESLA'S PERSONAL EFFECTS, AND [REDACTED] TAKEN TO PRESERVE THEM OR TO KEEP THEM FROM FALLING INTO THE HANDS OF AN UNFRIENDLY TO THE WAR EFFORT OF THE UNITED STATES. [REDACTED] SPANEL, A DISTANT RELATIVE OF TESLA, NAMED [REDACTED] WAS INTENSELY DISLIKED BY TESLA, AND [REDACTED] HAS TAKEN STEPS TO OBTAIN POSSESSION OF THESE IMPORTANT DOCUMENTS AND PLANS. SPANEL BELIEVES THERE IS A STRONG LIKELIHOOD THAT ROSANOVICH WILL MAKE THIS MATERIAL AVAILABLE TO THE ENEMY. SPANEL ADVISED TWO HEADQUARTERS IN WASHINGTON, AS WELL AS MR. MORRIS OF THE DEPARTMENT OF JUSTICE IN WASHINGTON, CONCERNING THE ABOVE. SPANEL WAS ALSO IN TELEPHONIC COMMUNICATION WITH [REDACTED] B. D. LOZADO, ONE OF THE ADVISORS TO VICE PRESIDENT WALLACE CONCERNING THIS MATTER, AND LOZADO TOLD SPANEL [REDACTED] THAT THE GOVERNMENT WAS VITALLY INTERESTED IN THE EFFECTS OF TESLA AND REQUESTED SPANEL TO LOSE NO TIME IN DOING ALL HE COULD TO PRESERVE [REDACTED] THEM. ELOYCE FITZGERALD, AN ELECTRICAL ENGINEER WHO HAD BEEN CLOSE TO TESLA DURING HIS LIFE TIME, ADVISED THE NEW YORK OFFICE THAT ON JANUARY SEVENTH, NINETEEN FORTY THREE, SAVA ROSANOVICH, GEORGE CLARK, WHO IS IN CHARGE OF THE MUSKOGEE AND LABORATORY FOR RCA, AND KENNETH SWEEZEY OF ONE SIX THREE MILTON SWEEZEY BROOKLYN, NY, WENT TO TESLA'S ROOMS IN THE NEW YORKER, AND WITH THE ASSISTANCE OF A [REDACTED] LOCKSMITH BROKE INTO A SAFE WHICH TESLA HAD IN HIS ROOMS IN WHICH HE KEPT SOME OF HIS VALUABLE PAPERS, INCLUDING [REDACTED] ELECTRICAL FORMULAE, DESIGNS, ET CETERA. WITHIN THE PAST MONTH, TESLA TOLD FITZGERALD THAT HIS EXPERIMENTS IN CONNECTION WITH THE WIRELESS TRANSMISSION OF ELECTRICAL POWER HAD BEEN COMPLETED AND PERFECTED.

100-2237-3

JAN 18 1943

11/14/43 JBD  
 Treason & Espionage  
 11/14/43 JBD

NOT FOR REDACTIONS

**Project Seesaw:**

In 1958, the Defense Advanced Research Projects Agency (DARPA) began to work on a top secret project code-named "Seesaw".

Phase one of the research started at a secret military base.

Phase two and phase three continued at the Lawrence Livermore Laboratory.

During all that time, military scientists who worked on these "Black Projects" were fully aware of Maria Orsic's Vril technical data, Tesla's papers, including the threatening "Aliens' Rapture."

**1958: The Russians built their first Nikola Tesla's beam weapon**

facility.

In October 1958, the Soviets who had access to some of Tesla's "Aliens Rapture" (Government File), smuggled to them by a double agent in Washington, and another major spy in Istanbul, Turkey, began to work on similar projects. Fortunately, nothing came out of it.

But in November 1970, the Russians (A joint team of scientists from Russia, Armenia and the Ukraine) built their first Tesla's beam weapon facility in Southern Russia, near the Sino-Soviet border.

**The CIA learned about the Russian facility from alien space-beacons orbiting Earth.**

In February 1971, the Americans through their double agents in Kiev and Moscow learned about the Russian facility. This was the version of the CIA. (Yet, never disclosed or publicly admitted!) However,

according to my sources, the CIA gathered intelligence on the Russian facility and the development of Tesla's beam weapon program, from "friendly" alien space-beacons orbiting Earth.

Some of these space-beacons were piloted by "US Extraterrestrial Officers" and communicated with us through a machine invented by Nikola Tesla.

To many, this story is absurd and far-fetched. But years later, the "absurd" story of the "American Extraterrestrial Officers" was fully documented and proven real.

\*\*\* \*\*

### **Russian Tesla's beam weapon system and the United States Strategic Defense Initiative (SDI).**

The American instant response to the Russian beam weapon program was the Strategic Defense Initiative (SDI) proudly announced to the world by President Ronald Reagan in 1983.

He stated: "Teams of government scientists were urged to turn their great talents now to the cause of mankind and world peace, to give us the means of rendering these nuclear weapons impotent and obsolete."

### **President Reagan on the "Aliens' Threat".**

And herewith for the record, United States concerns about an alien invasion caused by an alien rapture.

The Christian Science Monitor stated: "Former President of the Soviet Union Mikhail Gorbachev spent an hour with Charlie Rose and Reagan Secretary of State George Shultz recently.

The three discussed many topics including a conversation between Reagan and Gorbachev about uniting against visitors from outer space."

The Monitor's Jimmy Orr wrote: "Reagan and Gorbachev agreed to fight UFOs. This is a perfect one for Friday night. Charlie Rose had the former President of the Soviet Union Mikhail Gorbachev and President Reagan's Secretary of State George Shultz on his program this past Tuesday night.

This year marks the 20th anniversary of the fall of the Berlin Wall. Gorbachev got a laugh when he said he wasn't all that impressed with Reagan's historic challenge to "tear down this wall".

But went on to say that he believed Reagan "was a great president." Shultz was talking about the Lake Geneva summit and mentioned the two leaders ducked out of a meeting to take a walk to a nearby cabin."

I wasn't there..." Shultz said before Gorbachev cut him off." From the fireside house, President Reagan suddenly said to me, 'What would you do if the United States were suddenly attacked by someone from outer space? Would you help us?'

"I said, 'No doubt about it.'" He said, "We too."

And before the United Nations General Assembly, September 21st, 1987, President Reagan said: "In our obsession with antagonisms of the moment, we often forget how much unites all the members of humanity.

Perhaps we need some outside, universal threat to make us recognize this common bond. I occasionally think how quickly our differences worldwide would vanish if we were facing an alien threat from outside this world. And yet, I ask you, is not an alien threat already among us?"

\*\*\* \*\*

**The FBI secret files on Tesla.**

**Document 1: Full page**

1-9-43 11-30 PM  
 FBI NYC DIRECTOR  
 COAT  
 UNKNOWN SUBJECTS. [REDACTED] EXPERIMENTS AND  
 TESLA, DECEASED. ESPIONAGE - M. NIKOLA TESLA, ONE  
 STANDING SCIENTISTS IN THE ELECTRICAL FIELD, DIED  
 TEEN FORTY THREE AT THE HOTEL NEW YORKER, NEW YORK  
 LIFETIME, HE CONDUCTED MANY EXPERIMENTS IN CONNECTION WITH HIS  
 TRANSMISSION OF ELECTRICAL POWER AND [REDACTED] WHAT IS CALLED  
 THE DEATH RAY. ACCORDING TO INFORMATION FURNISHED [REDACTED] ONE ON  
 THREE SIX FIFTH AVENUE, NEW YORK CITY, THE NOTES AND [REDACTED] TESLA  
 EXPERIMENTS AND FORMULAE TOGETHER WITH DESIGNS OF [REDACTED] ANY TO  
 VITAL?7E THEM ARE AMONG TESLA'S PERSONAL EFFECTS, AND [REDACTED] BEEN  
 TAKEN TO PRESERVE THEM OR TO KEEP THEM FROM FALLING [REDACTED] AND [REDACTED] PEOPLE  
 [REDACTED] UNFRIENDLY TO THE WAR EFFORT OF THE UNITED STATES. ACCORDING  
 ING TO SPANEL, A DISTANT RELATIVE OF TESLA, NAMED [REDACTED] KOSANOVICH, WHO  
 WAS INTENSELY DISLIKED BY TESLA, IS TAKING STEPS TO [REDACTED] SESSSION OF  
 THESE IMPORTANT DOCUMENTS AND PLANS. SPANEL BELIEVES [REDACTED] THERE IS A  
 STRONG LIKELIHOOD THAT KOSANOVICH WILL MAKE THIS MATERIAL AVAILABLE TO  
 TO THE ENEMY. SPANEL ADVISED TWO HEADQUARTERS IN WASHINGTON, AS  
 WELL AS MR MORKIN OF THE DEPARTMENT OF JUSTICE IN WASHINGTON, CONCERNING  
 THE ABOVE. SPANEL WAS ALSO INTELEPHONIC COMMUNICATION WITH [REDACTED] DR B  
 LOZADO, ONE OF THE ADVISORS TO VICE PRESIDENT WALLACE CONCERNING THIS  
 MATTER, AND LOZADO TOLD SPANEL [REDACTED] THAT THE GOVERNMENT WAS VITALLY  
 INTERESTED IN THE EFFECTS OF TESLA AND REQUESTED SPANEL TO LOSE NO TIME  
 IN DOING ALL HE COULD TO PRESERVE [REDACTED] THEM. ELOYCE FITZGERALD, AN  
 ELECTRICAL ENGINEER WHO HAD BEEN QUITE CLOSE TO TESLA DURING HIS LIFE  
 TIME, ADVISED THE NEW YORK OFFICE THAT ON JANUARY SEVENTH, NINETEEN  
 FORTY THREE, SAVA KOSANOVICH, GEORGE CLARK, WHO IS IN CHARGE OF THE MUS-  
 EUM AND LABORATORY FOR RCA, AND KENNETH SWEZEY OF ONE SIX THREE MILTON  
 STREET, BROOKLYN, NY, WENT TO TESLA'S ROOMS IN THE NEW YORKER, AND WITH  
 THE ASSISTANCE OF A [REDACTED] LOCKSMITH BROKE INTO A SAFE WHICH TESLA  
 HAD IN HIS ROOMS IN WHICH HE KEPT SOME OF HIS VALUABLE PAPERS, INCLUDING  
 IMPORTANT [REDACTED] ELECTRICAL FORMULAE, DESIGNS, ET CETERA. WITHIN THE  
 PAST MONTH, TESLA TOLD FITZGERALD THAT HIS EXPERIMENTS IN CONNECTION WITH  
 THE WIRELESS TRANSMISSION OF ELECTRICAL POWER HAD BEEN COMPLETED AND [REDACTED]  
 PERFECTED.

Enlarged: Document 1

## First half of the page

STRONG LIKELIHOOD THAT KOSANOVICH WILL MAKE THIS MATERIAL AVAILABLE TO  
 TO THE ENEMY. SPANEL ADVISED TWO HEADQUARTERS IN WASHINGTON, AS  
 WELL AS MR MORKIN OF THE DEPARTMENT OF JUSTICE IN WASHINGTON, CONCERNING  
 THE ABOVE. SPANEL WAS ALSO INTELEPHONIC COMMUNICATION WITH [REDACTED] DR B  
 LOZADO, ONE OF THE ADVISORS TO VICE PRESIDENT WALLACE CONCERNING THIS  
 MATTER, AND LOZADO TOLD SPANEL [REDACTED] THAT THE GOVERNMENT WAS VITALLY  
 INTERESTED IN THE EFFECTS OF TESLA AND REQUESTED SPANEL TO LOSE NO TIME  
 IN DOING ALL HE COULD TO PRESERVE [REDACTED] THEM. ELOYCE FITZGERALD, AN  
 ELECTRICAL ENGINEER WHO HAD BEEN QUITE CLOSE TO TESLA DURING HIS LIFE  
 TIME, ADVISED THE NEW YORK OFFICE THAT ON JANUARY SEVENTH, NINETEEN  
 FORTY THREE, SAVA KOSANOVICH, GEORGE CLARK, WHO IS IN CHARGE OF THE MUS-  
 EUM AND LABORATORY FOR RCA, AND KENNETH SWEZEY OF ONE SIX THREE MILTON  
 STREET, BROOKLYN, NY, WENT TO TESLA'S ROOMS IN THE NEW YORKER, AND WITH  
 THE ASSISTANCE OF A [REDACTED] LOCKSMITH BROKE INTO A SAFE WHICH TESLA  
 HAD IN HIS ROOMS IN WHICH HE KEPT SOME OF HIS VALUABLE PAPERS, INCLUDING  
 IMPORTANT [REDACTED] ELECTRICAL FORMULAE, DESIGNS, ET CETERA. WITHIN THE  
 PAST MONTH, TESLA TOLD FITZGERALD THAT HIS EXPERIMENTS IN CONNECTION WITH  
 THE WIRELESS TRANSMISSION OF ELECTRICAL POWER HAD BEEN COMPLETED AND [REDACTED]  
 PERFECTED.

*Memo 1/11/43 JBL*  
*Memo to Director 1/11/43 JBL*  
 RECORDED  
 100-2237-3  
 1 JAN 18 1943  
 NOT FOR REDACTIONS



\*\*\* \*\*

**Enlarged: Document 1**

**Second half of the same page**

NOT FOIA REDACTIONS

JAN 12 1943

TELETYPE

1-12-43 11-06 PM WBS

FBI NYC  
DIRECTOR  
WEST

UNSUBS --- EQUIPMENT, EXPERIMENTS AND RESEARCH OF NIKOLA TESLA CEASED, ~~REDACTED~~ ESPIONAGE - M. RETEL UNDER ABOVE HEADING TO THE BUREAU FROM THIS OFFICE DATED JAN NINE LAST. INQUIRY DEVELOPS THAT TESLA DIED JAN EIGHT, RATHER THAN THURSDAY, JAN SEVEN, AS ~~REDACTED~~ STATED IN REFERENCE TELETYPE. ON THE NIGHT OF JAN EIGHT, SAVA KOSANOVICH, GEORGE CLARK, AND KENNETH SWEETZKY VISITED TESLA-S HOTEL WITH A REPRESENTATIVE OF SHAW WALKER CO. IN ORDER TO OPEN THE SAFE IN THE ROOM OF TESLA. KOSANOVICH LATER REPORTED TO WALTER GORSUCH, OFFICE OF ALIEN PROPERTY CUSTODIAN, NYC, THAT HE WENT INTO THE ROOM IN ORDER TO SEARCH FOR A WILL OF TESLA. KOSANOVICH AND THE OTHERS MADE THE SEARCH OF THE SAFE IN THE PRESENCE OF THREE ASST MANAGERS OF HOTEL NEW YORKER AS WELL AS REPRESENTATIVES OF THE YUGOSLAVIAN CONSULATE, IDENTITIES OF LATTER NOT YET KNOWN. AFTER THE SAFE WAS OPENED, SWEETZKY TOOK FROM THE SAFE A BOOK CONTAINING TESTIMONIALS SENT TO TESLA ON THE OCCASION OF HIS SEVENTY FIFTH BIRTHDAY. THIS BOOK WAS ARRANGED FOR TESLA BY SWEETZKY. KOSANOVICH TOOK FROM THE ROOM THREE PICTURES OF TESLA, TWO BEING ENLARGED NEWSPAPER PICTUREX. ACCORDING TO MANAGERS OF HOTEL AND KOSANOVICH HIMSELF, NOTHING ELSE WAS REMOVED FROM THE ROOM OR SAFE. THE SAFE WAS THEN CLOSED UNDER A NEW COMBINATION, WHICH COMBINATION IS NOW IN POSSESSION OF ~~REDACTED~~ KOSANOVICH. ON SATURDAY AFTERNOON, JAN NINE, GORSUCH AND ~~REDACTED~~ FTZGERALD OF ALIEN PROPERTY CONTROL WENT TO HOTEL AND SEIZED ALL THE PROPERTY OF TESLA, CONSISTING OF ABOUT TWO TRUCKLOADS OF MATERIAL, SEALED ALL ARTICLES AND TRANSFERRED THEM TO THE MANHATTAN STORAGE AND WAREHOUSE CO. NY, WHERE THEY ARE NOW LOCATED. AT THAT ~~REDACTED~~ TIME THERE WERE ALSO IN THIS WAREHOUSE APPROXIMATELY THIRTY BARRELS AND BUNDLES BELONGING TO TESLA WHICH HAD BEEN THERE SINCE ABOUT NINETEEN THIRTY FOUR. THESE HAVE ALSO ~~REDACTED~~ BEEN SEALED AND ARE NOW UNDER ORDERS OF ALIEN PROPERTY CUSTODIAN. IN VIEW OF FACT TESLA IS A US NATURALIZED CITIZEN, ALIEN PROPERTY CUSTODIAN FEELS THAT ITS JURISDICTION OVER PROPERTY IS DOUBTFUL BUT ~~REDACTED~~ FEELS THAT NO OTHER AGENCY WILL BE ABLE TO GET ~~REDACTED~~ TO THIS PROPERTY FOR AT LEAST TWO DAYS.

COPIES DESTROYED 1/10/54

ALL INFORMATION CONTAINED  
HEREIN IS UNCLASSIFIED  
DATE 11-30-92 BY SP-10/BJW/ML

100-2237-2

1-13-43  
COPY IN FILE  
77 FEB 5 1943

REDACTIONS ON THIS PAGE ARE  
NOT FOIA DELETIONS

\*\*\* \*\*

Document 2: Full page

NOT FOIA  
REDACTIONS

JAN 12 1943

TELETYPE

FBI NYC                      1-12-43                      11-06 PM                      WBS

UNSUBS --- EQUIPMENT, EXPERIMENTS AND RESEARCH OF NIKOLA TESLA  
 CEASED, ~~REDACTED~~ ESPIONAGE - M. RETEL UNDER ABOVE HEADING TO THE BUREAU  
 FROM THIS OFFICE DATED JAN NINE LAST. INQUIRY DEVELOPS THAT TESLA DIED  
 JAN EIGHT, RATHER THAN THURSDAY, JAN SEVEN, AS ~~REDACTED~~ STATED IN  
 REFERENCE TELETYPE. ON THE NIGHT OF JAN EIGHT, SAVA KOSANOVICH, GEORGE  
 CLARK, AND KENNETH SWEZEY VISITED TESLA-S HOTEL WITH A REPRESENTATIVE  
 OF SHAW WALKER CO. IN ORDER TO OPEN THE SAFE IN THE ROOM OF TESLA.  
 KOSANOVICH LATER REPORTED TO WALTER GORSUCH, OFFICE OF ALIEN PROPERTY  
 CUSTODIAN, NYC, THAT HE WENT INTO THE ROOM IN ORDER TO SEARCH FOR A  
 WILL OF TESLA. KOSANOVICH AND THE OTHERS MADE THE SEARCH OF THE SAFE  
 IN THE PRESENCE OF THREE ASST MANAGERS OF HOTEL NEW YORKER AS WELL AS  
 REPRESENTATIVES OF THE YUGOSLAVIAN CONSULATE, IDENTITIES OF LATTER NOT  
 YET KNOWN. AFTER THE SAFE WAS OPENED, SWEZEY, TOOK FROM THE SAFE A  
 BOOK CONTAINING TESTIMONIALS SENT TO TESLA ON THE OCCASION OF HIS SEVEN  
 TY FIFTH BIRTHDAY. THIS BOOK WAS ARRANGED FOR TESLA BY SWEZEY.  
 KOSANOVICH TOOK FROM THE ROOM THREE PICTURES OF TESLA, TWO BEING EN-  
 LARGED NEWSPAPER PICTUREX. ACCORDING TO MANAGERS OF HOTEL AND KOSANO-  
 VICH HIMSELF. NOTHING ELSE WAS REMOVED FROM THE ROOM OR SAFE. THE

Enlarged: Document 2

First half of the page

SAFE WAS THEN CLOSED UNDER A NEW COMBINATION, WHICH COMBINATION IS  
 NOW IN POSSESSION OF ~~REDACTED~~ KOSANOVICH. ON SATURDAY AFTERNOON, JAN  
 NINE, GORSUCH AND ~~REDACTED~~ FTIZGERALD OF ALIEN PROPERTY CONTROL WENT TO  
 HOTEL AND SEIZED ALL THE PROPERTY OF TESLA, CONSISTING OF ABOUT TWO  
 TRUCKLOADS OF MATERIAL, SEALED ALL ARTICLES AND TRANSFERRED THEM TO  
 THE MANHATTAN STORAGE AND WAREHOUSE CO. NY, WHERE THEY ARE NOW LOCATED.  
 AT THAT ~~REDACTED~~ TIME THERE WERE ALSO IN THIS WAREHOUSE APPROXIMATELY  
 THIRTY BARRELS AND BUNDLES BELONGING TO TESLA WHICH HAD BEEN THERE SINCE  
 ABOUT NINETEEN THIRTY FOUR. THESE HAVE ALSO ~~REDACTED~~ BEEN SEALED AND  
 ARE NOW UNDER ORDERS OF ALIEN PROPERTY CUSTODIAN. IN VIEW OF FACT TESLA  
 IS A US NATURALIZED CITIZEN, ALIEN PROPERTY CUSTODIAN FEELS THAT ITS  
 JURISDICTION OVER PROPERTY IS DOUBTFUL BUT ~~REDACTED~~ FEELS THAT NO OTHER  
 AGENCY WILL BE ABLE TO GET ~~REDACTED~~ TO THIS PROPERTY FOR AT LEAST TWO DAYS.  
 COPIES DESTROYED 3/10/54

ALL INFORMATION CONTAINED  
 HEREIN IS UNCLASSIFIED  
 DATE 1-13-93 BY SP-10/BJP/MLP

Rec'd 12:50 pm  
 1-13-43  
 EW

**COPY IN FILE**  
 77 FEB 5 1943

NOT FOIA REDACTED

100-2237-2

JAN 18 1943

REDACTIONS ON THIS PAGE ARE  
 NOT FOIA DELETIONS

\*\*\* \*\*

Enlarged : Document 2

Second half of the same page

Office Memorandum • UNITED STATES GOVERNMENT

TO : MR. TOLSON DATE: Jan. 30, 1951

FROM : L. E. NICHOLS (b)(7)(c)

SUBJECT: [REDACTED] ALL INFORMATION CONTAINED HEREIN IS UNCLASSIFIED DATE 2-22-89 BY [REDACTED]

[REDACTED] called yesterday and said he would be in town for the next two or three days and wanted to see me. I told him I would be glad to see him late yesterday or today at his convenience. He is coming in today at 2:30 p.m.

I asked him if there was anything special which would require my doing any checking. He stated there were two things he wanted to discuss.

1. The case of Nicola Tesla and Abraham N. Spanel, President of International Latex Corporation [REDACTED]

Our files reflect that Nicola Tesla was one of the world's outstanding scientists and in fact designed the generators installed at Niagara Falls. He died in New York on January 7, 1943, and is supposed to have left details and plans for a so-called death ray. [REDACTED]

Our files also reflect that Colonel Erskine of Military Intelligence called us on January 8, 1943, advising that Tesla had died, that Mr. Spanel had communicated with the War Department regarding this death, that Tesla had a nephew named Sava Kosanovich who had taken possession of Tesla's papers and Spanel thought the papers might be used against our Government.

We made an immediate inquiry in New York and the first report was that Kosanovich and others entered Tesla's room with the aid of a locksmith, broke into a safe containing some of Tesla's valuable papers including formula.

Coincident with this, on January 8, 1943, L. M. C. Smith called Mr. Tamm regarding the death of Tesla and Smith stated he was talking to the Alien Property Custodian about seizing these items.

We interviewed Spanel who expressed concern over Tesla's effects and Spanel stated that Kosanovich had turned over the effects of Tesla to the Alien Property Custodian. Spanel further stated the day before Tesla died, he tried to get in touch with the War Department to make available certain papers. [REDACTED]

5 COPIES DESTROYED 4 1955 [REDACTED] RECORDED - 15 INDEXED - 18 MAR 2 1951 346,930-1

\*\*\* \*\*

Document 3: Office Memorandum. United States Government

STANDARD FORM NO. 64

Office Memorandum • UNITED STATES GOVERNMENT

TO : MR. TOLSON

DATE: Jan. 30, 1951

FROM : L. B. NICHOLS

SUBJECT: [REDACTED]

ALL INFORMATION CONTAINED  
HEREIN IS UNCLASSIFIED  
DATE 2-22-89 BY [REDACTED]

[REDACTED] called yesterday and said he would be in town for the next two or three days and wanted to see me. I told him I would be glad to see him late yesterday or today at his convenience. He is coming in today at 2:30 p.m.

I asked him if there was anything special which would require my doing any checking. He stated there were two things he wanted to discuss.

1. The case of ~~Nicola Tesla~~ and Abraham N. Spanel, President of International Later Corporation [REDACTED]

Our files reflect that Nicola Tesla was one of the world's outstanding scientists and in fact designed the generators installed at Niagara Falls. He died in New York on January 7, 1943, and is supposed to have left details and plans for a so-called death ray. [REDACTED]

Enlarged : Document 3; Office Memorandum. United States Government

First half of the page

Our files also reflect that Colonel Erskine of Military Intelligence called us on January 9, 1949, advising that Tesla had died, that A. Spanel had communicated with the War Department regarding this death, that Tesla had a nephew named Sava Kosanovich who had taken possession of Tesla's papers and Spanel thought the papers might be used against our Government.

We made an immediate inquiry in New York and the first report was that Kosanovich and others entered Tesla's room with the aid of a locksmith, broke into a safe containing some of Tesla's valuable papers including formula.

Coincident with this, on January 8, 1949, L. M. C. Smith called Mr. Tamm regarding the death of Tesla and Smith stated he was talking to the Alien Property Custodian about seizing these items.

We interviewed Spanel who expressed concern over Tesla's effects and Spanel stated that Kosanovich had turned over the effects of Tesla to the Alien Property Custodian. Spanel further stated the day before Tesla died, he tried to get in touch with the War Department to make available certain papers.

RECORDED - 18  
INDEXED - 18  
EX - 8  
MAR 2 1951  
COPIES DESTROYED 2/21/51  
894 JUN 27 1952

\*\*\* \*\*

Enlarged: Document 3; Office Memorandum. United States Government

Second half of the page

April 20, 1976

Mr. Clarence Kelly  
Director  
F.B.I.  
Washington, DC

ALL INFORMATION CONTAINED  
HEREIN IS UNCLASSIFIED  
DATE 7-3-82 BY SP4 Jap/ste

Dear Mr. Kelly:

Mr. Allen and Mr. Ruchlehsus, former acting Director of the FBI, contacted me in 1973 regarding the unavailability of American microfilm records of Nikola Tesla's unpublished diary (now in the Belgrade museum, arranged by month per folder).

At the time I discounted the possibility that these unpublished discoveries had military significance. But because of experiments now under way at Hill AFB, I now suspect such military applications exist and feel it imperative that you be notified, particularly in view of the fact that the Soviets have primary access to the entire collection.

Two photos of each page exist.

After Tesla's death, scientists from the Navy and OSS performed a cursory examination of the diary and notes, which if my memory serves me correctly, was one month long, hardly enough time to decipher Tesla's torturous handwriting. Though Tesla wrote in English, his penmanship was small, blurred, and as difficult to translate as a foreign language.

According to the museum director (1971), the Soviets had made copies of some portions, but not the Colorado Springs diary, which numbers 500 pages, 20 that directly pertain to ball lightning, and 20 or so relevant to the equipment construction. (We copied the most significant portions, but feel more exists)

EX-115 REC-52 100-2237-29

an article in magazine, EDN (an electrical engineering magazine), but only with the very recent receipt of an unpublished manuscript from John J. O'Neill's book (PRODIGAL GENIUS) did I place credence on Tesla's later claim to military applications. Incidentally, some of O'Neill's descriptions were inaccurate and exaggerated, as we have exceeded Tesla's results and are familiar with the experiments. At any rate, there are three possible military applications.

\*\*\* \*\*

Letter to Mr. Clarence Kelly, Director of, F.B.I.

Signature Censored!!!

First, Tesla claimed that the lightning balls (which destroyed his equipment) could be used to destroy aircraft. I have talked to AF personnel --such as [REDACTED] who saw one inside his plane in flight--and found AF personnel fear these "rf balls," as they call them.

Second, it is a suspicion of mine that ball lightning, if injected with lithium, could produce a cheap fusion bomb.

Third--and this may be no more than a suspicion--the propulsion mode of ball lightning involves electro-gravitic interaction, by which means air vehicles of revolutionary configuration may be constructed. There are no presently-known laws of physics that can account for the propulsion (400 mph or so when following an airliner). Other hitherto unsuspected applications may exist.

None of these applications were the goal of Project Tesla, which centered on producing ball lightning as Tesla did and studying it as a plasma confinement technique for fusion reactors. Incidentally, Tesla's claim to setting up standing waves on the earth's surface (wireless power) was erroneous and involved techniques similar to Project Sanguine, that is, using the earth's atmosphere as a waveguide ([REDACTED] is aware of our research).

Cordially,  
[REDACTED]

P.S. By a copy of this letter, along with the enclosures, I am notifying the C.I.A.

Enclosures: 2





RESEARCH AND  
ENGINEERING

~~CONFIDENTIAL~~  
OFFICE OF THE UNDER SECRETARY OF DEFENSE  
WASHINGTON, D.C. 20301

FEDERAL GOVERNMENT

9 FEB 1981

B7D

MEMORANDUM FOR THE DIRECTOR, FEDERAL BUREAU OF INVESTIGATION

SUBJECT: Papers Recovered on the Death of Nicola Tesla (U)

(U) We understand that the FBI may have possession of a number of papers found after the death of Nicola Tesla in 1943. Nicola Tesla was a brilliant electrical engineer (i.e. the Tesla Coil) who was a pioneer in various aspects of electrical transmission phenomena.

(C) We believe that certain of Tesla's papers may contain basic principles which would be of considerable value to certain ongoing research within the DoD. It would be very helpful to have access to his papers.

(U) Since we have really no idea of the possible volume of these papers, we would be happy to provide a researcher who could assist you in reducing the magnitude of the search. If there are further questions, I am the point of contact within the DoD and can be reached at 695-6364 or 695-7417:

*Allan J. MacLaren*  
Allan J. MacLaren  
LtColonel, USAF  
Military Assistant  
Strategic and Space Systems

REGISTERED  
1059638

FBI  
ALL INFORMATION CONTAINED  
HEREIN IS UNCLASSIFIED  
DATE 4-8-83 BY 9203 [redacted] b7C  
FOIA No. 352, 408  
362,001

100-2237-33

Per DoD letter dated 3-29-93  
with Enclosures 1 and 2  
ALL DoD info is unclassified.  
DoD referenced FOIA #s  
352,608 and  
362,001

ALL INFORMATION CONTAINED  
HEREIN IS UNCLASSIFIED  
DATE 8-14-87 BY 5781/STW/ldp

MAR 12 1981

4/4/83 9803 [redacted] b7C

Classified by: DUSDR/5655  
Declassify on: February 1987

DECLASSIFIED BY 1049 [redacted] b7C  
ON 1-27-93  
Per Army letter JMS-89  
24760 CORRESPONDENCE

50 MAR 30 1981

~~CONFIDENTIAL~~

\*\*\* \*\*

Letter from the Department of Defense to the F.B.I.

FD-36 (Rev. 8-28-82)

FBI

<b>TRANSMIT VIA:</b> <input type="checkbox"/> Teletype <input type="checkbox"/> Facsimile <input checked="" type="checkbox"/> AIRTEL	<b>PRECEDENCE:</b> <input type="checkbox"/> Immediate <input type="checkbox"/> Priority <input type="checkbox"/> Routine	<b>CLASSIFICATION:</b> <input type="checkbox"/> TOP SECRET <input type="checkbox"/> SECRET <input type="checkbox"/> CONFIDENTIAL <input type="checkbox"/> UNCLAS E F T O <input type="checkbox"/> UNCLAS Date <u>8/18/83</u>	<b>SECRET</b>
---	---	--	---------------

TO: DIRECTOR, FBI **SECRET**  
 ATTN: INTD, SUPERVISOR [REDACTED]

FROM: SAC, CINCINNATI [REDACTED] (P)  
 NIKOLA TESLA (S) (X) 10  
 (OO: CI)

This communication is classified "Secret" in its entirety.

Re telephone call of SA [REDACTED], Cincinnati Division, to Supervisor [REDACTED], FBIHQ, on 8/11/83.

Enclosed for the Bureau and New York is one copy each of pertinent pages from the 1981 book titled "Tesla: Man Out of Time" by Margaret Cheney, with important passages underlined.

For information of Bureau and New York, [REDACTED]

[REDACTED] at Wright-Patterson Air Force Base (WPAB) and [REDACTED]

[REDACTED] also at WPAB, have both been in contact with SA [REDACTED] at the Dayton, Ohio RA regarding possible FBI [REDACTED]

**SECRET**

Classified by: 8262  
 Declassify on: OADR  
 Classified by: [REDACTED]  
 Declassify on: OADR

2 - Bureau (Enc. 1)  
 2 - New York (Enc. 1)  
 2 - Cincinnati  
 (6)

ALL INFORMATION CONTAINED  
 HEREIN IS UNCLASSIFIED  
 DATE 17 AUG 22 1983

Approved: [Signature] Transmitted \_\_\_\_\_ (Number) \_\_\_\_\_ (Time) \_\_\_\_\_ (Page)

53 NOV 1982

Even though, this document is heavily censored, explosive information can be retrieved from its contents. Pay attention to the lines censored before "at Wright-Patterson Air Force", and before "at Dayton, Ohio."

involvement in the seizing of Nikola Tesla's research papers and other documents and scientific instruments after his death on January 7, 1943.

1886  
They both explained that Tesla was a scientific genius and experimenter who was born in Yugoslavia of Serbian parents on 7/10/56, went to school later in Gratz, Austria, Prague, Czechoslovakia and Paris, France. He immigrated to the U.S. in the early 1880's, worked for Thomas Edison's laboratory for a couple of years, then started his own lab after being paid \$1 million dollars for rights to his patents on his polyphase systems of alternating current dynamos, which lead to the harnessing of Niagra Falls for producing electricity and then the power system of the whole country. He was naturalized in 1889. He predicted wireless communication (radio). His later experiments in Colorado and elsewhere lead to his producing artificial lightning in the millions of volts. He also had patents on the concept of neon and fluorescent lights, but he later made little money on his later inventions, although he continued to do experiments leading to devices of great potential worth, which he never patented. He became more reclusive in his later years, living in various hotels in New York City. In the 1930's he claimed he had developed the concept and method of building a "death ray", which could destroy planes at many miles distant, for defending America. Also, there are reports of resonance machines or devices whereby he could shake one or many large city buildings from some distance away.

Both [REDACTED] and [REDACTED] said that Tesla donated "some" of his papers (or copies thereof) to the Tesla Institute in Belgrade, Yugoslavia; set up in the 1930's in his honor by their government. Biographies on Tesla claim that either the custodian of Alien Property and/or the FBI seized his papers and other personal effects, including a safe or safes, and other property immediately after his death in 1943. This is elaborated on in the enclosed copies of certain pages of Margaret Cheney's book, "Tesla: Man Out of Time".

[REDACTED] said that after World War II Tesla's papers were shipped to the Tesla Institute in Belgrade, Yugoslavia, by his nephew, Sava Kosanovic, who had become Tito's Ambassador to the U.S. There were reports that some microfilming of Tesla's papers by government agents while they were still in storage in New York under Kosanovic's custody.

Also, the Soviet Union has allegedly had access to some of Tesla's papers, possibly in Belgrade and/or else where, which influenced their early research into directed energy weapons, and [redacted] feels access to much of Tesla's papers on lightning, beam weapons and/or "death rays" would give him more insight into the Soviet beam weapons program. This is Butler's area of expertise and responsibility. He has been unable to locate any Tesla papers or copies of same in the classified or unclassified libraries at WPAFB. However, there are reports that some portions of them were shipped by the Custodian of Alien Property Office in Washington, D.C. to a technical research lab at WPAFB, possibly the "Equipment Lab", now closed for some years or reorganized into another organization.

[redacted] and [redacted] are both desirous of learning the locations of such papers of Tesla as now exist in the U.S. for both intelligence and research purposes. Therefore, [redacted] would like to examine FBI files relating to Nikola Tesla and possibly any on Sava Kosanovic, his nephew who received the bulk of his papers after Tesla's death, and may possibly have been the subject of FBI investigation.

[redacted] travels to the Washington, D.C. area on FTD business periodically and can review FBI files at FBIHQ relating to Tesla and Kosanovic.

#### REQUEST OF THE BUREAU

The Bureau is requested to conduct full indices checks on both Nikola Tesla and Sava Kosanovic.

Should there be such files at FBIHQ, as well as at New York, it is requested that Bureau consider granting the above [redacted] of FTD, official access to same, in the interest of national security.

#### LEADS

##### NEW YORK

##### AT NEW YORK, NEW YORK

Will conduct same indices check as requested of Bureau and advise the Bureau and Cincinnati of results and confirm such files and references still exist there.

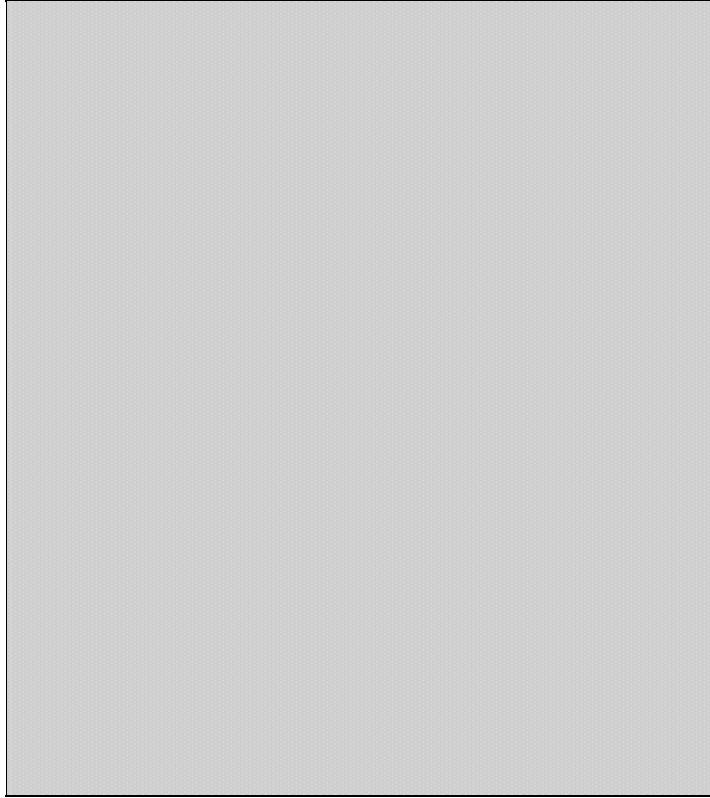

**Note:** Dr. von Braun and Dr. Teller notes on the aliens' threats and rapture (Previously included in the Los Alamos secret archives), are now in the hands of the United States Air Force, Strategic Command, NSA, and the "Vaults" of the CIA.

\*\*\* \*\*

**New Books by Maximilien de Lafayette**

Paperback editions are available at [www.lulu.com](http://www.lulu.com)

De Lafayette wrote more than 250 books on UFOs, extraterrestrials and aliens.

Check the recently released titles at the author's website:

[www.maximilliendelafayettebibliography.com](http://www.maximilliendelafayettebibliography.com)

[ACTIVATION OF THE CONDUIT AND THE SUPERSYMETRIC MIND. Beyond the Third Eye and Toward the Oneness](#)

- Transcripts of what the Aliens, Extraterrestrials and Intraterrestrials Told our Governments.
- Mind-Bending Black Operations, Weapons Systems and Experiments by Extraterrestrials, Grays and Governments.
- Learn how to speak the Anunnaki Language
- The Grays, Alien Abductions and Genetic Creation of Humans Hybrids Race: Secret US Extraterrestrial Operations. Hybrids Habitats and Way of Life.
- The German UFOs, Extraterrestrials Messages and the Supernatural
- The Essential Maximillien de Lafayette. The Official Anunnaki Ulema Textbook for the Teacher and the Student. 2 volumes
- Inside the extraordinary world of the Anunnaki and Anunnaki Ulema: What I saw, what I learned, and what I can teach you.
- Anunnaki Genetic Creation of the Human Races, Demons and Spirits. How God was invented by the Egyptians, Sumerians, Phoenicians and Hebrews.
- When Heaven Calls You: Connection with the Afterlife, Spirits, 4th Dimension, 5th Dimension, Higher-Self, Astral Body, Parallel Dimensions and the Future
- Activation of the Conduit and the Supersymetric Mind. Beyond the Third Eye and Toward the Oneness.
- Baalbeck: The Anunnaki City and Afrit Underground.
- Description, Translation, and Explanation of Babylonian, Sumerian, Akkadian, Assyrian, Ugaritic, Anunnaki and Phoenician Cylinder Seals, Slabs, Tablets and Inscriptions.

- The Complete Anunnaki Ulema Tarot Deck. Lessons And Techniques To See Your Future.
- Anunnaki Chronology and their Remnants on Earth From 1,250,000 B.C. to the Present Day.
- De Lafayette Mega Encyclopedia of Anunnaki, Ulema-Anunnaki, their Offspring, their Remnants and Extraterrestrial Civilization on Earth.
- 2022 Anunnaki Code: End of the World and their Return to Earth. Ulema Book of Parallel Dimension, Extraterrestrials and Akashic Records
- Ulema Secret Teachings on Anunnaki, Extraterrestrials, UFOs, Alien Civilizations and How to Acquire Paranormal Powers.

\*\*\* \*\*

## New Books by



Maximilien de Lafayette

Available at [amazon.com](https://www.amazon.com) and  
[lulu.com](https://www.lulu.com)

---

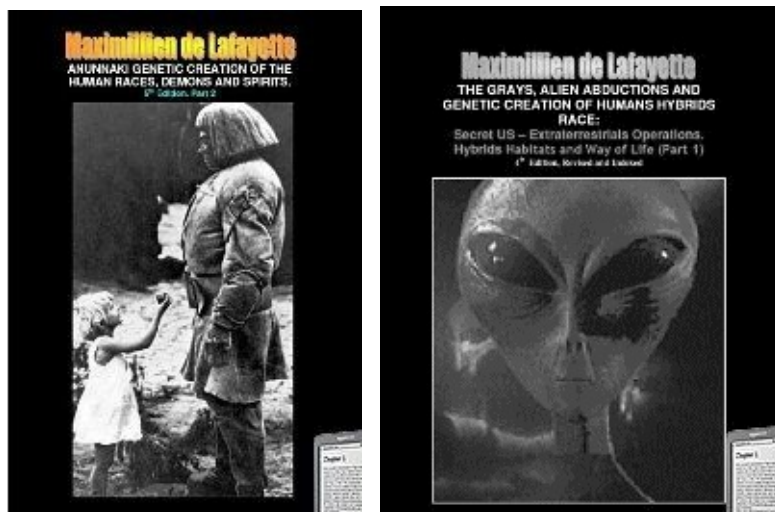

Cover of Vol. 1 Cover of Vol. 2

### **Anunnaki Genetic Creation of the Human Races, Demons and Spirits. 5th Edition. (In 2 Volumes)**

The book IS EXPLOSIVE and AUTHORITATIVE! It contains hundreds of photographs, illustrations, maps, sketches and inscriptions, tablets and slabs translated from Sumerian and Akkadian by the author, a world authority on ancient languages and Anunnaki.

5,000 year old tablets demonstrated that WE ARE NOT CREATED BY THE GOD OF THE BIBLE. We were genetically created by the Anunnaki. This book has all the proofs to convince you once for good! The Anunnaki created the human race, God, Gods, angels, spirits and demons before the dawn of the history of Man. Don't be offended, GOD was created by the Egyptian priests, and the Mesopotamian myths/epics. And organized religions are cashing on it!

The extraterrestrials created many species and different human races here on planet Earth. But there are other early human beings who were created in space, and on other planets, and like the very small and very tall species, they were not part of the evolutionary process of the modern human beings. In total, 36 (some say 46) different human and quasi-human species lived on planet Earth in many regions of the globe. And none of them were created by the "God" we know and worship. After all,





they did not look like humans, and if we have to believe that humans were created in the image of "God", as Judaism, Christianity and Islam tell us, then, most certainly those early 36 different species who looked like ferocious beasts, were not made in the image of "God".

The Anunnaki, Igigi and other extraterrestrial civilizations created several models of early human beings, Negative entities, reptilians, Djinns, Afrit, evil-birds, and demons which live in the lower sphere/zone (Alternate dimension), and on Earth

Also you will read about:

Names of the Anunnaki gods and goddesses who created the first humans, and the genetic creation of the human race

The Igigi who created the first quasi human/robots

The Akkadian text on the creation of Man

Anunnaki geneticists who developed DNA sequences, and altered the genes of hybrids

The early human forms

The Earth-made human creatures

The Space-made human creatures

Metabolism and the oceans-made human creatures

Evolution of the extraterrestrials and the human races

Negative entities, reptilians, Djinns, Afrit, evil-birds, and demons which live in the lower sphere/zone (Alternate dimension), and on Earth

Anamidra explains the creation of Man from cosmic clay

Copies of the universe, including copies of ourselves, and Earth in other dimensions

Dual nature of humans, before they were separated genetically

"Grays": Intraterrestrial non-human

How the Anunnaki created us genetically in their laboratories.

\*\*\* \*\*

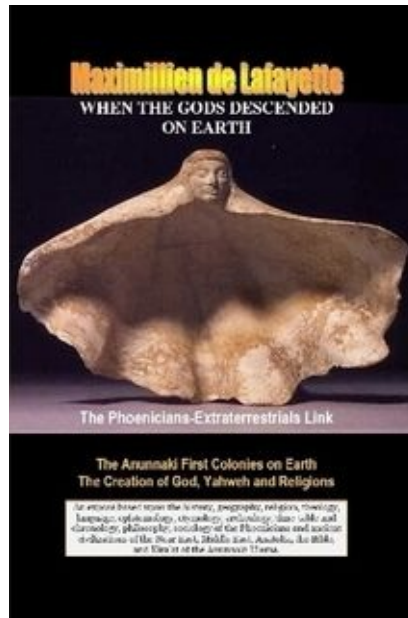
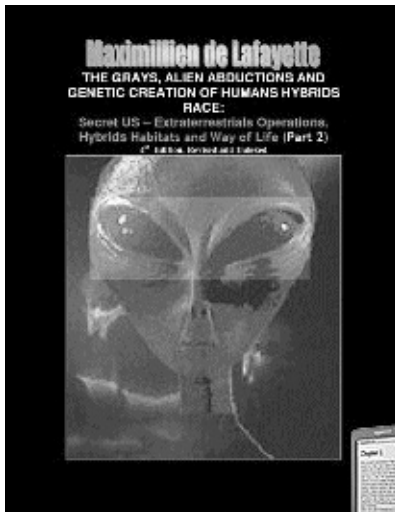

Cover of Vol. 1 Cover of Vol. 2

**The Grays, Alien Abductions and Genetic Creation of Humans Hybrids Race: Secret US - Extraterrestrials Operations. Hybrids Habitats and Way of Life.4th Edition, (Aliens and hybrids among us) In 2 Volumes**

The book includes:

- 1.Description of the hybrids' habitat.
- 2.Hybrids underground/underwater communities.
- 3.Their bedrooms, beds, toys, dining rooms, food, and eating habits.
- 4.Hybrids' three distinct groups/categories.
- 5.Hybrids placed for adoption.
- 6.The Grays fetuses' room, and how they genetically create a human-hybrid race.
- 7.Intraterrestrial Grays and their abductees: Rapports, relationship and abductees' accounts.
- 8.The future of the human race and the global change.
- 9.Weather/Climate weapons system, invented by the military and Grays.
- 10.HAARP.
- 11.Weapon system used to suck up the oxygen from the air we breathe.
- 12.Aliens-US frightening military technology.
- 13.Extraterrestrials-US joint black operations.

- 14.The device used to create a holographic projection
- 15.Project Serpo, Zeta Reticuli, and Stargate
16. Scenes from the future, as projected by the Grays on holographic screens.
- 17.Holographic zooming at some intelligence agencies.
- 18.How the aliens can move American cities, like New York to another place or make them disappear?
- 19.How the aliens cured an abductee a lung cancer.
- 20.US military scientists and the Corridor Plasma
- 21.Massive underwater bases and joint human-alien operations.
- 22.The American military has successfully sent six men through the vortex, to another dimension.
- 23.Aliens/Grays-US Dulce Base war, and the killing of 66 American soldiers.
- 24.Holographic pictures showing the entire sequence of the Roswell crash.
- 25.The aliens Radio plasma belt around earth to isolate earth from the universe.
- 26.Description of the Dulce underground base, and the living quarters of aliens inside the base.
- 27.Genetic labs that created half human/ half animals.
- 28.And much much more.

\*\*\* \*\*

**WHEN THE GODS DESCENDED ON EARTH: The Phoenicians-Extraterrestrials Link (2 Volumes in paperback)**



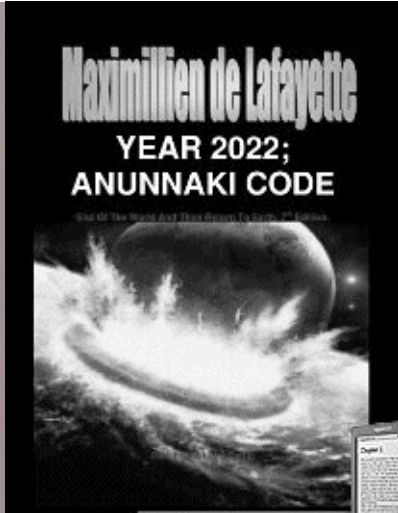

**Cover of Vol. 1 Cover of Vol. 2**

It includes hundreds of photos and illustrations. An exposé based upon the history, geography, religion, theology, languages, epistemology, etymology, archeology, time-table and chronology, philosophy, sociology of the Phoenicians and ancient civilizations of the Near East, Middle East, Anatolia, the Bible, and Kira'at of the Anunnaki Ulema to prove that the Extraterrestrial Gods descended on Phoenicia and how the Anunnaki shaped our history, destiny and future. The author discusses these topics in the book, and provides solid evidence pertaining to the early Phoenicians' link to the Extraterrestrial Gods and Ancient Aliens who descended first on Phoenicia, as well as the primordial influence the early Phoenicians had on the creation of the concept of God, Judaism, and Christianity.

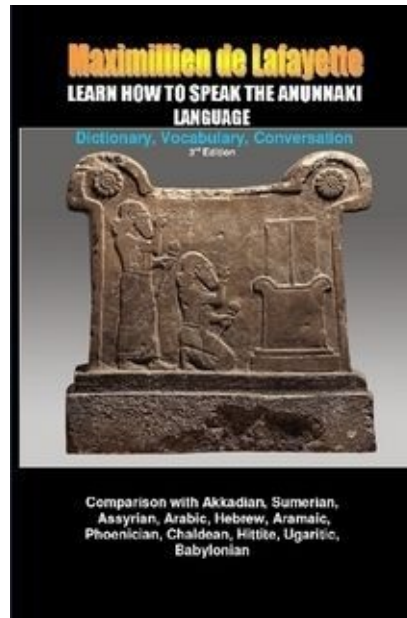
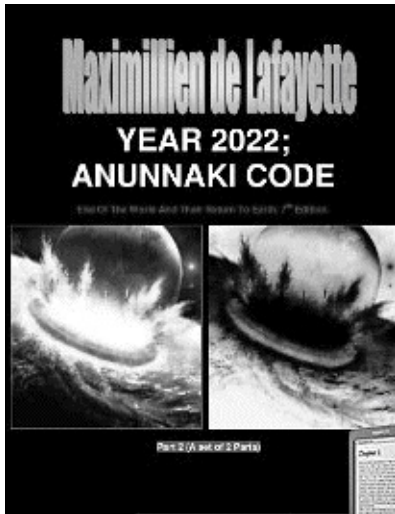

C over of Vol. 1 Cover of Vol. 2

**YEAR 2022. Anunnaki Code: End Of The World And Their Return To Earth. (Return of the Extraterrestrial Gods) In 2 Parts**

Most of the material of this book has been learned from sources that are totally out of reach for the average reader, and ufology's milieu. Some was hidden in the archives of museums, some written on tablets that have never been translated before, and some of it is oral knowledge that have never been given to a Westerner before. The author, Maximilien de Lafayette, have been so fortunate as to study with those who are the guardians of this knowledge in the East. This is the first time he is making use of this depot of knowledge, and we are very lucky to have access to it. The subjects introduced in this book are explosive. Most important is the fact that it reveals the potential return of the Anunnaki in 2022, and the most frightening transformation that it would bring to the earth. If this is going to happen, a huge number of the people on earth, those grossly contaminated by Grays' DNA, will be annihilated. You know who they are - the child murderers, the rapists, those who torture, those who abuse, *etc.* Yes, we all know who they are. But the Anunnaki, who have no false sentimentality at all, will not tolerate even a medium level contamination. Unless they do their best to clean themselves during the grace period of the next eleven years, those of mid level contamination will also be destroyed. Those who would manage to clean themselves to a certain degree may possibly (but without any guarantee) be able to escape the burning, smoking earth through special portals, called Ba'abs. Only those who are naturally uncontaminated and those who managed to clean themselves completely will be taken up through an antimatter bubble, with the animals and certain important buildings and inanimate art and culture objects, and kept safe until the earth would be clean again. Such a scenario is, to say the least, disconcerting.

Even if you are not sure whether you are a believer or not, you should certainly consider the possibilities - and the book teaches you exactly how to save yourself. For those who are interested in the use of esoteric codes, they are here to learn from. Each term will teach you how to use it for your benefit, how to apply it not only to your spiritual growth, but to your business, relationships, and daily life.

You will learn how to interpret the codes in many ancient languages, how to build a physical amulet/code that will protect certain aspects of your life, and how to develop your psychic and extrasensory powers by simply using these codes.

You will learn how the Anunnaki were our original creators, who else tempered with our genetic materials, and how God factors into all this. Religion, true and false, will be explored. Jesus, who never really died on the Cross, will be shown as a historical figure, with his wife, Mary Magdalene, with whom he escaped to ancient Marseille. Who were Adam and Eve? Who was the Serpent? How do the gods of Sumer signify to us?

You will be asked to consider the old theory, now discarded, that the Anunnaki came here to mine gold. You will meet the earliest extraterrestrial-human civilization, and no, it was not Sumer. It was, believe it or not, Phoenicia! You will learn many secrets about the Anunnaki themselves - such as their extrasensory

powers, their deep knowledge of genetics and science, and their unbelievably long lifespan.

Who is their God?

What kind of social classes they have?

What spiritual principles do they exercise?

And most important, what is their 2022 plan for humanity after the apocalyptic cleansing of the earth.

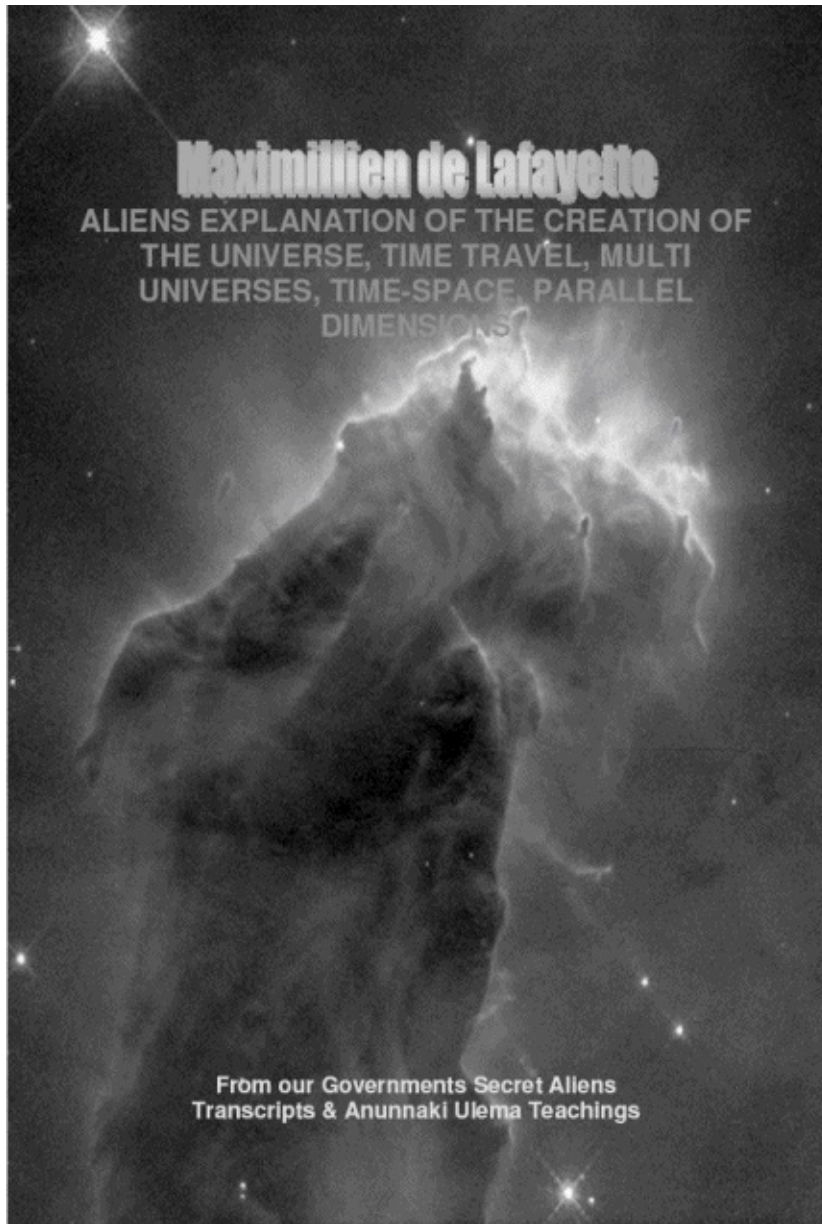

**LEARN HOW TO SPEAK THE ANUNNAKI LANGUAGE: Dictionary, Vocabulary, Conversation**

Including etymology, epistemology, the study and linguistic investigation of the derivation and origin of the



ancient Middle and Near East languages, Semitic and non-Semitic languages and dialects, including, but not limited to Old Babylonian, Akkadian, Sumerian, Assyrian, Chaldean , Aramaic, Phoenician, Ugaritic, Hebrew, Hittite, Arabic, *etc.*

Comparison with Akkadian, Sumerian, Assyrian, Arabic, Hebrew, Aramaic, Phoenician, Chaldean, Hittite, Ugaritic, Babylonian. A WORLD PREMIERE EVENT.

For the first time in philology's history, and chronicles of civilizations of the ancient world, Maximillien de Lafayette, a world renowned expert linguist (Ancient Languages) provides us with the first lexicon/thesaurus/dictionary of the Anunnaki and Ulemite languages. This book is a treasure. It consists of a set of 4 volumes. The last volume focuses on Anunnaki and Igigi language conversation. And YES you will be able to speak their terrestrial and extraterrestrials languages as spoken on Earth and their planet.

This unique work consists of definitions of words, etymology, epistemology, the study and linguistic investigation of the derivation and origin of the ancient Middle and Near East languages, Semitic and non-Semitic languages and dialects, including, but not limited to Old Babylonian, Akkadian, Sumerian, Assyrian, Chaldean, Aramaic, Phoenician, Ugaritic, Hebrew, Hittite, Arabic, *etc.*

Ana'kh is the language of the Anunnaki who descended on ancient Turkey, Mesopotamia, and Phoenicia according to the Ulema. It is of an extraterrestrial origin. Ulema Al Bakr stated that it was used by early the human beings who lived in ancient Anatolia, on the Island of Arwad, in Tyre, Sidon, Byblos, Ugarit, Amrit, and Mu. He added that from the Ana'kh derived the primitive languages of the Near East and the Middle East. Ana'kh was never made public.

It remained a secret language known only to the Ulema, and later on to the Allamah. It sounds Semitic, because of its phonetics. But it is "not Semitic at all", said Ulema Ghandar Gupta.

It has no grammar, but it has an extremely rich vocabulary and an abundance of metaphoric expressions.

A considerable number of Akkadian and Sumerian words that appeared in the Sumerian/Akkadian/Chaldean Epic of Creation and the Bible derived from Ana'kh.

Around 569 A.D., a group of Ulema (Munawareen) in the Near East (Non-Islamic scholars) compiled an extensive list of Ana'kh words and phrases. In 625, A.D., two leading figures of the Ulema brotherhood wrote the Book of Rama-Dosh; a compilation of Ana'kh terminology, a lexicon, and Kiraats (Readings).

Ulema AL Bakr stated that the Ulema are not member of a religious group. They are neither Muslim nor

members of any organized religion. In fact, they were persecuted by the companions of the Prophet Muhammad, and were expelled from the Arab Peninsula. They found refuge in Cyprus and Marseille. But the honorable Ulema was quick to point out that the early Sufi masters, poets and Sufi trance dancers were Ulema. He added that Ulema should not be confused with the Islamic Ulema who teach Islamic law, or with the Allamah who were the leading Islamic figures of science and letters in medieval times.

Farid Tayarah, an Ulema himself, and a former head of a Masonic Lodge stated that the Ana'kh was used during Masonic sessions and services. He added that a considerable number of Masonic words and expressions are pure Ana'kh, especially those words referring to levels and degrees in Freemasonry, and initiation ceremonies.

Many of the original words of this language, as well as numerous linguistic derivations are included in this book.

Don't Miss This Book!

**A LIENS EXPLANATION OF THE CREATION OF THE UNIVERSE, TIME TRAVEL, MULTI  
UNIVERSES, TIME-SPACE, PARALLEL DIMENSIONS**

JUST PUBLISHED

1520 Things You Don't Know about Ancient Aliens, UFOs, Aliens Technology, Extraterrestrials and U.S.  
Black Operations. Part 2

Part 2 (Final volume). The 2 volumes are available in paperback at [lulu.com](http://lulu.com)

The importance of this groundbreaking book resides in the originality of its material and world-premiere information on UFOs, USOs, extraterrestrials, intraterrestrials, aliens, alien technology, U.S. black operations and aliens multiple universes, not readily available elsewhere, and covering the most important events and findings in the history of modern ufology and the study of alien civilization, parallel universes, and multiple dimensions, as DIRECTLY



explained to us by the extraterrestrials we met with since 1947.

Nowhere, in any published book, on websites, in conferences and other published material, you will ever find the information, data, briefings and reports provided in this book. For instance (Information and reports never revealed before or known to ufologists and the general public):

In this volume:

1. The Grays and the BL-rm3
- 2.4 UFOs crashes on record
3. Human bodies' parts were found inside an alien spacecraft
4. Excerpts from the Aliens Transcripts of our meetings with extraterrestrials and intraterrestrials in 1947 and 1948
5. Scientist and Nobel Prize winner, Dr. Francis Crick wrote: "The astonishing hypothesis is, that there is no soul." This is

exactly what the aliens told the military.

6. What the aliens told us about Jesus, the disciples, the four Biblee and the Gnostics.
7. Aliens Rewinding Time Technology
8. Translation Signals Box (TSB): A machine the aliens gave us, which allowed us to respond to their communications and messages
9. CTF (Transmission Channel): A device used by military scientists to receive messages from aliens
10. The Web: A network of underwater channels linking together intraterrestrial communities
11. VCP: Vortex Tunnel Weapon System
12. The military has successfully sent some of its personnel through a vortex tunnel to another dimension, and successfully, they were brought back
13. Aliens Spinning Mobile Satellite" (SMS): The mode of transportation down the underwater bases
14. Corridor Plasma and the Vacuum Tunnel: Underwater cold plasma tunnel used by the intraterrestrials (The Grays) to navigate underwater
15. Bioelectric extraterrestrial robots "B.E.R": Human-like robots capable of acting like human beings
16. Aliens zooming into the past and jumping into the future
17. BCB: The Aliens Compressor Machine
18. List of names of scientists who collaborated with aliens and/or worked on alien reverse engineering
19. Major discoveries based on alien technology
20. Non-disclosure policy by Catholic archbishops and secret committees. (Their names and role)
21. On Presidents Truman, Eisenhower, Nixon and Bush Sr. knowledge of and involvement with the alien

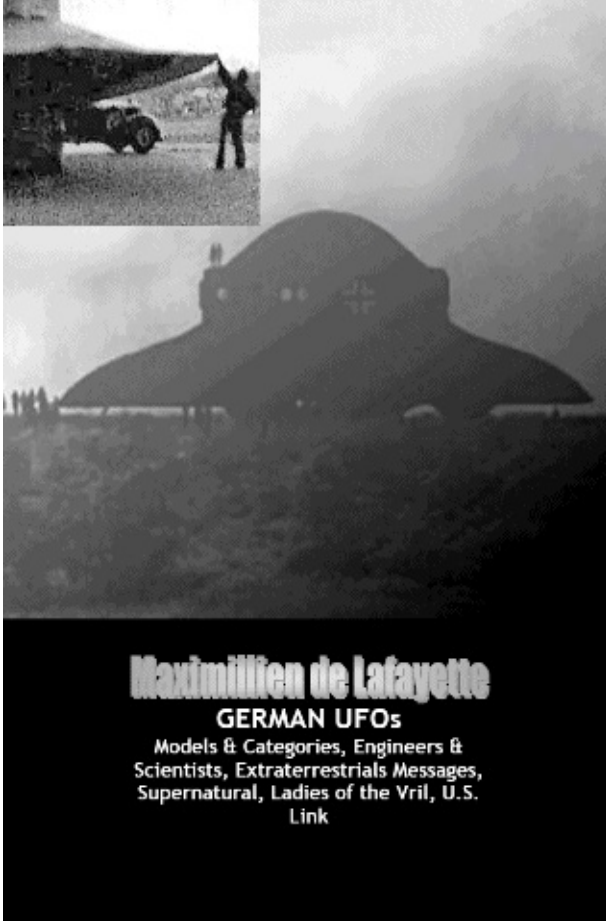

phenomenon.  
22.The shipped aliens' dead bodies to Walter Reed Hospital

---

DO NOT MISS THESE TWO BOOKS ON  
GERMAN UFOS, MYSTICISM AND OCCULT  
IN NAZI GERMANY

**G ERMAN UFOS: MODELS &  
CATEGORIES, ENGINEERS & SCIENTISTS  
, EXTRATERRESTRIALO MESSAGES,  
SUPERNATURAL, LADIES OF THE VRIL,  
U.S. LINK**

Cover of Volume 1

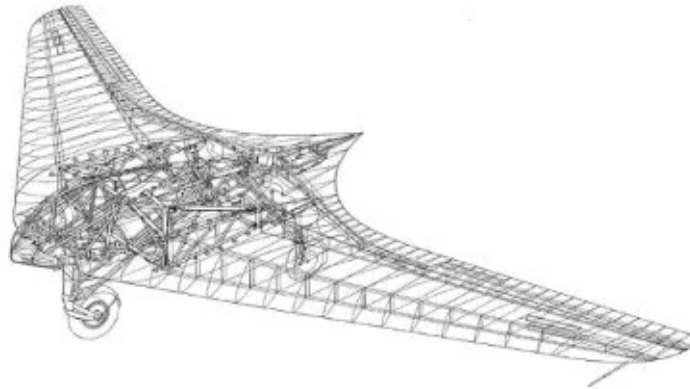

Cover of Volume 2

NOTES

NOTES

# Maximilien de Lafayette

## GERMAN UFOs

Models & Categories, Engineers & Scientists,  
Extraterrestrials Messages, Supernatural, Ladies of the  
Vril, U.S. Link. Part 2



I

NDEX



0-23055, serial number,55

10 year sentence in Russia,57

100 German scientists became

leading figures in the

Russian space programs,203

11.5 m were built, seventeen

disk-shaped flying machines

with a diameter of,61

1200-tonne limestone

megalithic stones,142

145 meter Raumschiff,84, 173

18 test flights of three large

UFO VRIL 7,61

1918, UFO photograph taken in

Hamburg, Germany in

March,46

1919, first meeting on Tuesday

16, September,24

1919, meetings of Ladies of

Vril,21

1919, second meeting; Friday

19, September,24

1919, third meeting;

Wednesday 17,

December,25

1920, February of,25

1920, January,25

1921, meetings of Ladies of

Vril,21

1922, flight-test was

scheduled for March 23,42

1922: First prototype of

Jenseitsflugmaschine,

March,41

1922: The first flight-test of

Jenseitsflugmaschine,

March 23,47

1922; first secret prototype of

Aldebaran's

Jenseitsflugmaschine,

March,42

1923: A new model of

Jenseitsflugmaschine,

December 17 of,51

1924: The first successful

flight of

Jenseitsflugmaschine,

January,54

1934, first fully operational

German Bell-UFO was

manufactured in June,61

1943, meeting with Cardinal

Michael von Faulhaber,

Wednesday 13 January, 108

1944, flew in,54

1944, Haunebu II in

February,87

1944, March of,54

1944, meeting with Cardinal

Michael von Faulhaber,

Thursday 24 February, 108

1944, three large UFO VRIL 7

were produced, and made

18 test flights ,61

**1945 a strange looking craft**

**hovering over Munich,**

**March,119**

1945, Friday 16, March,121

1945, Ladies of Vril left Munich

to a destination only known



to Dr. Schumann and Lt.

Colonel Walter Horten,

Sunday 18, March,119

1945, Lt. Col. Walter Fellenz

spotted and reported RFC-2

on Sunday 18, March,55

1945, the SS manufactured

three different sizes of

UFO-bell-shaped,61

1945, Thursday 15, March,

farewell to Dr. Schumann

on ,117

1945: Getting out of

Germany,91

1945: UFO VRIL 7 was

stationed in Alpenfestung,

March,63

1946 to 1949, the Russians

were extremely interested

in the German Bell-

UFO,201

1947 and 1948, Aliens

Transcripts of,49,138

1958: Russians built their first

Nikola Tesla's beam

weapon facility,236

2,345 Catholic priests at

Dachau, detention of,108

2007, leaked out by NASA

insiders in,56

2022, the future after , 161,162

2022: Return of the

extraterrestrials,180

27 feet in diameter, circular

crafts,58

300,000 km/hour, spacecraft

flew at a speed of,54

32 German scientists were

smuggled outside

Russia,203

33.33 degree line around

Earth, station,117,41,48,

84,183

33.33 degree station line,

Aldebaran messages to get

out of Munich, and fly to

the,91

33.33, number,108

345 German scientists were  
immediately deployed in  
secret locations,203

**42nd Infantry Division, 1st**

Battalion,55,119

450,000-460,000 B.C.,128

569 A.D.,173

625, A.D.,173

657 German scientists and  
shipped them to

Moscow,202

**7<sup>th</sup> Army,119**

856 miles per hour, navigate

underwater at,39

95 or 96 B.C,133

**A**

A.nun “n-a-k”,158

Ab,157

Ab.Har,171

Abani, river,134

Abara,135,137

Abiroun,135

Abiru,135,137

above, people from,157

Abra,135,137

Abri,135

Abru,135

[Abzu](#) temple, gatekeepers of

the,159

Account of Erna Flegal,

Hitler’s personal nurse,92

Ace, Germany’s greatest

fighter,57

Adams, Roger,201

Adbar,128

Adbara in Arabic,127,128

Adelbaran extraterrestrials

and Anunnaki language,174

Adelbaran spaceship, in order

to build the,22

Adelbaran, atmosphere and  
energy in,138

Adelbaran, waters, lands and  
lakes in,139

Adelbaran,24 ,52,111

Adelbaran's extraterrestrials  
and Anunnaki, learning  
from the,166

Adelbaran's extraterrestrials  
and Anunnaki's landing  
Mesopotamia, map of  
the,153

Adelbaran's extraterrestrials,  
Urartrians were the  
remnants of the,145

Adjacent planets and other  
extraterrestrials,139

Adjusting vision,148

Admiralty Building, Room 40 of  
the British,211

Adonakh ,129

Aerodyne, Lippisch,83

Afanasyev, Sergey

Aleksandrovich,204

After-Life Flying Machine,41,

42

Aftonbladet,73

Aged 100 years,54

Agents and spies, Allied forces

secret,203

Agents in Kiev and Moscow,

double,236

AGSP,38

Air Force, United States,37,39,

48,182

Air warfare, deadly

developments in,70

Aircraft Company, Bavarian,56

Airplane, supersonic

transatlantic,178

Ak, descendants of the, 158

Akasha,171

Akashic files,169

Akashic Library, Aldebaran's,

166,167,168

Akashic Records, hall of

the,170

Akkad ,129

Akkadian and Sumerian word

Ne.Bi.Rim means

crossing,134

Akkadian and Sumerian,

linguistic standard of,133

Akkadian epics written in

cuneiform , Sumero-, 129

Akkadian on Sumerian clay

tablets, epics were written

in,153

Akkadian, proto-,133

Akkadian/Sumerian clay

tablets are very

confusing,134

Akkadian/Sumerian clay

tablets,130

Akkadian/Sumerian texts,

Ne.Be.Ru” in the,130

Akkadian-Ana’kh texts,

translation of the

Sumero,109

Al Annaki,157

Al Hak,173

Albahr, Ulema,173

Albard, Ulema,165

AlDaber,127

Aldebaran Akashic Library,

166,167,168

Aldebaran aliens,128

Aldebaran and Ash.Ta.Ri in the

ancient texts,130

Aldebaran barazat

Ne.Be.Ru,132

Aldebaran extraterrestrials ,

language of the Anunnaki

and the,173

Aldebaran extraterrestrials are

the offspring of a higher

race,140

Aldebaran extraterrestrials

established civilizations in

the Near East, Middle East

and Asia Minor,128

Aldebaran extraterrestrials has

two moons and two planets



rotating around it, home-

planet of the,138

Aldebaran extraterrestrials on

Earth, colonies of,128

Aldebaran extraterrestrials

point of rendezvous with

Maria,108

Aldebaran extraterrestrials,

father of the,152

Aldebaran instructions to Maria

to get out of Munich,91

AldebaranJenseitsflugmaschine

first secret prototype of,42

Aldebaran messages to get out

of Munich, and fly to the

33.33 degree station

line,91

Aldebaran mina khalkah,132

Aldebaran mothership,84,91

Aldebaran people,

communications with

the,46

Aldebaran people,170 ,179

Aldebaran technical data on

how to build a super flying  
machine,28

Aldebaran Technical Data,  
dossier on,21,38

Aldebaran UFO,21

Aldebaran, days calendar and  
moons around the  
inhabitable planets in,138

Aldebaran, life o n,180

Aldebaran, returned back  
to,140

Aldebaran,35,127 ,129,130,166

Aldebaran's  
extraterrestrials,85

Aldebaran's solar system: two  
small planets that support  
life, and are inhabited by  
people who resemble  
us,139

Aldebaran-Ashtari  
constellation, people who  
landed on the,149

Aldebaran-Ashtari, effects on

humans upon arrival to,147

Aldebran as Ash.Ta.Ri,137,138

Alien creatures at the Roswell

crash site,224

Alien gods, planet of the

Anunnaki and the

ancient,130

Alien race living underwater,

233

Alien reverse engineering

research/program, aliens'

headband became a major

part of the military's,50

Alien reverse engineering,

Russian early study and

research of,204

Alien Riyah, female,138

Alien space-beacons orbiting

Earth,236

Alien spaceships, secret

memoranda on

extraterrestrials'

communications between

two (or more),210

Alien technology program,

reverse engineering of,49

Alien technology, mysteries of  
the,220

Aliens “Corridor-Plama”,39

Aliens bodies animated by the  
headband,49

Aliens cosmic rapture,211

Aliens destruction of cities on  
Earth,209

Aliens had no navigation  
devices, spacecraft of  
the,50

Aliens headband became a  
major part of the military’s  
alien reverse engineering  
research/program,50

Aliens messages,22

Aliens rapture,209

Aliens rapture,210 ,236

Aliens recorded messages by  
Tesla,212

Aliens script,22

Aliens suits which were

“glued” to their skin,49

Aliens technology,

metaphysico-scientific

nature based upon very

sophisticated,48

Aliens threat,237

Aliens Transcripts of 1947 and

1948,49,138

Aliens who look machines,

insects and reptilians,139

Aliens, (1947-1948), United

States meetings with

the,197

Aliens, Aldebaran’s,128

Aliens, UFO which crashed

near Roswell was mentally

commanded by a metallic

band attached to the skull

of,49

Aliens, 46

Allamah,174

Allied forces secret agents and

spies,203

Allied intelligence, SS secret

files captured by,65

Allies intelligence in Berlin and

Vienna,61

Allies intelligence reports,

early,61

Allies,178

Alloy of RFC-2,56

Alloy research program,56

Alloy , metallic surface, made

from an unknown,55

Alloy, Unknown,49

Alpenfestung in March 1945:

UFO VRIL 7 was stationed

in,63

Alpenfestung S. 240,63,

Alpha Tauri,127 ,129

altered, properties totally,54

Amalika,156

Amann, Max,26

American generals, linguists

and scientists,138

**American UFO saga cover-up,**

**key player in the,49**

American ufology,46

American-Canadian UFO,

first,182

Americans,202

Ames Research Center at

Moffett Field, California,182

An.Na Kim,156

An'kh,157

Ana'kh text,28

Ana'kh texts, translation of

the Sumero-Akkadian-,109

Ana'kh, kawkab al,132

Ana'kh, old Sumerian language

mixed with,111

Ana'kh, Sham and Shama

in,155

Ana'kh,133, 173 ,179

Anakim,156

Anamidra, Revelations by,

161,162

Anamidra,162

Anamid-Raya, 161,162

Ananaki ,157

Anatolia ,140 ,157

Anatolian plateau of Asia

Minor450,000-460,000 B.C.,

descended on the,128

Ancestors of the

Armenians,157

A ncestry, royal,158

Ancient alien gods, planet of

the Anunnaki and the,130

Ancient languages,111

Ancient Mesopotamian clay

tablets,209

Ancient Mesopotamian-

Babylonian-Assyrian

city,134

Ancient Sanskrit, written in

codes and in,212

Ancient world, epistemological

influence on the languages

of the,174

Andromeda,70,74,84



Andromeda: Sketch and notes,  
taken from the German SS  
files,74

Andromeda-Gerät,84

Angels, wars between God and  
the Fallen,209

Angels,112

Anid Ariya, 161,162

Animal species were originally  
created in space, earliest  
human-,162

Animals, 161,162

Animated by the headband,  
aliens bodies,49

Annakh,157

Annodoti,157

Annunna,158

Anomaly, sight,149

Another dimension, a flying  
machine for,41

Another dimension,  
experiment in,170

Another world, machine for,41

Another world, messages

from,46

[Anshar](#) and [Kishar](#) , children

of,159

*Anti-gravity flying*

*machine,214*

Anti-gravity projects carried

by Germany's top

scientists,202

Anti-gravity spaceship,38

Anti-gravity thrust engine,117

Anti-gravity UFOs, mode of

operation blueprints of

Germany's first,39

Anti-gravity, diamagnetism,35

Anti-pollution shield that

protects their

atmosphere,139

[Anu](#) and [Ki](#) , children of,159

Anu, god/king,154,158

Anu, people of,157

Anu, subjects or followers

of,156

Anu. Ki.ram,156

Anu.ki,156

Anu.Na.Ki,130

Anum,158

Anunnaki cities,129

Anunnaki families,165

Anunnaki goddess,104,106

Anunnaki language, Adelbaran

extraterrestrials and,174

Anunnaki matrix , 161,162

Anunnaki spaceships launching

pad/terminal,143

Anunnaki to genetically create

the first human species,

clay used by the, 161,162

Anunnaki Ulema

manuscripts,132

Anunnaki, correct, definition

of 154

Anunnaki, language of the,111

Anunnaki, offspring of the,128

Anunnaki, origin and the

genetic creation of the

human races by

the , 161,162

Anunnaki, origin of the

word,154

Anunnaki, other names of

the,156

Anunnaki, star of the,132

Anunnaki, symbols of the

extraterrestrial,107

Anunnaki,127,130,137,139,

140,142,151

Anunnaki's "Conduit" , 161,162

Anunnaki-Ulema,127

Anunnaku ,157

Anuramkim,157

Anuramkir,157

Arab nomads,128

Arab Peninsula,128 ,174

Arabic, Ard in,131

Arabic, literary,156

Arabic, Sama in,131 ,155

Arabs,127

Arado plant in 1944,53,84

Arado,53,54,84

Arado's hangars in

Brandenburg, Rundflugzeug

1 was developed at,62

Arado-Brandenburg,54

Aramaic,156

Archbishop of Munich in

1945,103,108

Arcisstraße,24

Ard in Arabic,131

Area 51,182

Argentina in 1945, fled to,91

Argentina,178

Armenia 450,000-460,000 B.C.,

descended on Turkey

and,128

Armenia,236

Armenians, Ancestors of

the,157

Armenians,145

Army intelligence, detained by

United States,121

**Army, 42nd Infantry Division,**

**United States,55**

Army's Research and  
Development Department,  
Foreign Technology Desk at  
the United States,48

Arrival to Aldebaran-Ashtari,  
effects on humans  
upon,147

Arwad, early inhabitants  
of,156

Arwad,173

Arwadians,159

Aryans,140

Ash.Ta.Ri as Aldebran 137,138

Ash.Ta.Ri,127,128 ,129,130

Ashtari Aldebaran barazat

Ne.Be.Ru,137

Ashtari (Aldebaran) mina

khalkah,132

Ashtari Aldebaran barazat

Ne.Be.Ru,132

Ashtari constellation, people

who landed on the

Aldebaran-,149

Ashtaroot,106

Ashuric,156

Asia Minor,128

Aspect of the UFO

phenomenon, religious,197

Aspect of the UFO

phenomenon,

supernatural,197

Asshur, crossing point of,134

Assur,128 ,134

Assyrian seals,153

Assyrian, proto-,133

Assyrian,28,156

Assyriologist,24

Astarte,106

Asyaad al kawn and khalikeen

al basher,132

At distance, commanding the

craft,48

Atmosphere and energy in

Adelbaran,138

Atmosphere, anti-pollution

shield that protects

their,139

Atmosphere, gray planet with

swirling sand in its,149

Atmosphere, planets

without,139

Augsburg,119

Ausserirdischen,111

Austria,203

AUTEC,39,233,234

Auto-suggestion,199

Avro Project Y,182

Avrocar,182

## **B**

Ba'ab,127,131 ,170

Baalbeck Plateau,146

Baalbeck were a stargate for

the extraterrestrials, Mt.

Harmon and,143

Baalbeck, 129,140



Baalbeck, Trilithon of,142

Babylon,129

Babylonian cylinder seal,152 ,

153

Babylonian dialect, old,179

Babylonian language and a

script similar to Ugaritic

cuneiform, cryptic text

consisted of a very old,28

Backing and funds,without,22

Bahrain,140

Baird, Albert,201

Ballet to beginners, earning

very little by teaching,51

Band attached to the skull of

aliens, UFO which crashed

near Roswell was mentally

commanded by a

metallic,49

Band or a belt around the

forehead, metallic,148

Banned books from the

Bible,209

Base in South America, SS

officers and scientists fled

to a secret,63

Base of the Temple of

Jupiter,142

Bases and laboratories, Russian

military,202

Bases in Neuschwabenland,

underground German

military,63

Basilica of St. Mary of the

Angels,109

Basin filled with aquamarine-

tinted fluid,147,148

Bavarian Aircraft Company,56

Bayerische Flugzeugwerke,56

Beacons orbiting Earth, alien

space-,236

Beam File, Tesla,220

Beam invention, Death,212

Beam Stick found on the site

of a UFO crashed near

Roswell,220

Beam weapon facility, Russians

built their first Nikola

Tesla's,236

Before time was created,127

Behh,133

Being, divine,133

Beings of light,46,111 ,128,134 ,

143,156 ,179

Beings of lights who survived

the Biblical Flood (Great

Deluge), lived in Baalbeck

and on Mount Hermon for

thousands of years,143

Beings of lights,

extraterrestrials,128

Beings , non-terrestrial,46

Bel and Ea, station of,131

Bell program in Poland, UFO-

,65

Bell-shaped in 1945, the SS

manufactured three

different sizes of UFO-,61

Bell-UFO was manufactured in

June 1934, first fully

operational German,61

Bell-UFO, 1946 to 1949, the

Russians were extremely

interested in the

German,201

*Bell-UFO, German, 62,70,211*

*Bell-UFO, resembling*

*German,214*

Bell-UFO, Vril society

continued with two new

versions of a,62

Bell-UFO's SS records and

archives fell into the hands

of the Allies between 1945

and 1946,62

Bell-UFOs classes,70

Bene Elohim,156

Benedict XVI, Pope,104

Benevolent and positive

energy that created the

universe,112

Berchtesgaden,25

Berlin, United States Eighth Air

Force mounted the  
heaviest raid of World War  
II against,119  
BF 109 G6-14,56  
Bible,109,111,129 ,180 ,209  
Biblical giants,209  
Billboards,167  
Bio-engineering of terrestrial  
lifeforms,  
primordial , 161,162  
Biological and molecular  
levels,180  
Biological entities,180  
Blasphemy,111  
Blauer, Rudolf,26  
Blew up after spinning and  
spinning like fireworks,  
machine,47  
Blockprint, Babylon,146  
Blocks of life, building , 161,162  
**Blohm**, Traute A., **26,27**  
Blood, royal,158  
Blueprints of Germany's first

anti-gravity UFOs, mode of  
operation,39

Bodies animated by the  
headband, aliens,49

Body, Extraterrestrials cure all  
the weaknesses of the  
human,148

Body, multitude of copies of  
their,166

Bomber "E.555", strategic,54

Bombing people and cities, not  
interested in,54

Book of Enoch,157

Book of Ramadosh,128 ,

132 ,138,173

Books from the Bible,

banned,209

Bormann, Martin (Hitler's  
private secretary) ,93,95,97

Brain creating new visual  
faculties, cells in the,148

Brain, machine scanning  
your,148

Brain, reverse engineering of

the human , 161,162

Brain' frequencies, human,210

Brain's cells, screen contacted

through the Conduit which

is located in the,167

Brandenburg, Arado-,54

Brandenburg, Rundflugzeug 1

was developed at Arado's

hangars in,62

Brandenburg,62

Brazil,178

Brigadier General Henning

Linden, sighting confirmed

by,55

Brigadier General Henning

Linden,120

Brigadier General L. C.

Craigie,70,220,223,224

British Admiralty Building,

Room 40 of the,211

British Secret Service,202

British,202

Broz, Marshal Josip,217

Brüder Des Lichts,201

Build a super flying machine,

Aldebaran's technical data

on how to,28

Build other types of UFOs,

technical data used to,54

Building a super flying

machine,24

Building blocks of life , 161,162

Building on Thierschstraße,

Munich,121

Bukhtiyar, Ulema,133

Buldoc, Fellez-circular UFO

story was told by

Colonel,120

Bunker, Adolf Hitler's,92

Burwitz, Gudrun,91

Bush, Dr. Vannevar,200,201,

227

Byblos ,129



## C

Cafe on Arcisstraße,24

Calendar and moons around  
the inhabitable planets in

Aldebaran, days,138

California, Ames Research

Center at Moffett Field,182

Caltech,36

Canadian UFO, first American-  
,182

Canals,139

Cardinal and Maria Orsic in  
1943, dialogue between  
the,110,111

Cardinal Michael von  
Faulhaber, Maria's letter  
to,103,108

Cardinal Michael von

Faulhaber, Wednesday 13,

January 1943, meeting

with, 108

Catholic priests at Dachau,

detention of 2,345,108

Cells in the brain creating new

visual faculties,148

Cells producing life on

earth , 161,162

Cells, deterioration of,166

Cells, reactivating part of the

brain's,148

Cells , screen contacted

through the Conduit which

is located in the

brain's,167

Centrifugal movement of the

Jenseitsflugmaschine,39

Chaldean,156

Changing the DNA,170

Channel, History,210,211

Channel, Science,210,211

Channeled flight-test,51

Channelers,209

Channeling findings,51

Channeling séance, Labyrinth,22

Channeling séances,

mediumship-,51

Channeling with

extraterrestrials,209

Channeling, guiding the Geist

mentally via,54

Channeling,48,210

Chariot, God's,180

Chief of the Technical Mission

to Germany for the Ministry

of Aircraft Production,70

Chief Rabbi of Trieste,109

C hildren of [Anshar](#) and

[Kishar](#) ,159

C hildren of Anu and Ki,158,159

C hildren of Lahm and

[Lahmu](#) ,159

Chile,178

Chimiti, the genetic lab/site

of the [Creation](#) ,159

Christianity,108,162

CIA director in 1970,57,97

CIA Helms' files,55

CIA,182 ,236 ,254

Cigar shape,84

Ciphering machines,211

Circular crafts, 27 feet in  
diameter,58

Circular crafts, new,55

Circular flying machine, Arthur

Sack's,70,75,76

Circular flying machine,  
experimental,62

Circular shape flying craft  
without wings,120

Circular shape mothership,84

Cities on Earth, aliens'  
destruction of,209

Cities, Anunnaki,129

Civilization of the ancient  
Near East,174

Civilization to another,  
inhabitants of adjacent

planets vary sharply from  
one,139

Civilization, warning sent by  
an extraterrestrial,212

Civilizations in the Near East,  
Middle East and Asia Minor,  
Aldebaran extraterrestrials  
established,128

Civilizations on Earth, created  
the earliest,140

Civilizations on Earth,  
extraterrestrial,108

Civilizations, entities from  
galactic,209

Civilizations, planets inhabited  
by intelligent,211

Clarke, Jerome,201

Classes of UFOs, new types  
and,57

Clay tablets are very  
confusing,

Akkadian/Sumerian,134

Clay tablets,107,209 Akkadian/Sumerian,130

Clay tablets, epics were

written in Akkadian on

Sumerian,153

Clay tablets, Mesopotamian

slabs and,107 ,156

Clay used by the Anunnaki to

genetically create the first

human species, 161,162

Clay, creation of Man from

cosmic,162

Clyde A. Tolson,219,220

Code deciphered by Tesla,

extraterrestrials,220

Code for morality and ethics,

extraterrestrials',209

Codes and in ancient Sanskrit,

written in,212

Collision,209

Colonel Buldoc, Fellez-circular

UFO story was told by,120

Colonel Buldoc,120

Colonies of Aldebaran

extraterrestrials on

Earth,128

Colony , last German,64

Colors that do not exist on  
earth,148

Combustion engine, machine  
without a,42

Combustion engine, not a,133

Command Device, Headband  
Mental,48

Command, mental,48

Commanded by a metallic  
band attached to the skull  
of aliens, UFO which  
crashed near Roswell was  
mentally,49

Commanding the craft at  
distance,48

Communicate with the spirit of  
**Franziska Streitl**, séance  
to, **108**

C ommunication,  
telephatic,181

Communications between two  
(or more) alien spaceships,

secret memoranda on

extraterrestrials',210

Communications do not cross

the frontiers of the solar

system, mental,210

Communications with the

Aldebaran's people,46

Communists,218

Company, Bavarian Aircraft,56

Composition of the word

Anunnaki,154

Compton, K. T.,201

Conant, James B.,200,201

Concept of implosion,33

Concept totally unknown back

then,47

Conduit which is located in the

brain's cells, screen

contacted through the,167

Conduit, Anunnaki's , 161,162 ,

168

Confrontation,209

Contact with



extraterrestrials,211

Contact, independent groups

of extraterrestrials,179

Contactees,209

Controversial ideologies, 25

Copies of their body,

multitude of,166

Correct definition of

Anunnaki,154

Corridor-Plama, aliens,39

Cosmic clay, creation of Man

from,162

Cosmic energy of the self, Vril

quasi-eternal,166

Cosmic energy, divine,134

Cosmic law,112

Cosmic library , 161,162

Cosmic logic,112

Cosmic rapture, aliens',211

Cosmogony, Phoenician, 129,

174

Council of Extraterrestrial

Colonies,233

**Cover-up, key player in the  
American UFO saga,49**

Cowling, Lt.,120

**Craft hovering over Munich,  
March 1945 a strange  
looking,119**

Crafts, new circular,55

Craigie, Brigadier General L.

C.,70,220,223,224

Crash site near Roswell, debris  
from the UFO,224

Crash site, alien creatures at  
the Roswell,224

Create the first human  
species, clay used by the  
Anunnaki to  
genetically, 161,162

Created by Inanna, seven  
prototypes of the human  
race,170

Created in space, earliest  
human-animal species were  
originally,162

Created in their image, we

were,112

Created the earliest

civilizations on Earth,140

Created the first human beings

in Mesopotamia,

Inanna,104

Created us thousands of years

ago, extraterrestrials

who,111

Creation of Man from cosmic

clay,162

Creation of the future,170

Creation of the human races

by the Anunnaki, origin and

the genetic , 161,162

[Creation](#) , genetic lab/site of

the,159

Creators of the human

race,132

Creatures at the Roswell crash

site, alien,224

Creatures, Earth-made

human , 161,162

Creatures, oceans-made

human , 161,162

Creatures, space-made

human , 161,162

Crescent, star surrounded by

a,107

Crossing of heavens and earth,

holder of the,131

Crossing point of Asshur,134

Crossing point, Ne.Be.Ru as

a,134

Crossing, silver paid for

the,134

Cryptic text consisted of a

very Old Babylonian

language and a script

similar to Ugaritic

cuneiform,28

Culture of the ancient Near

East,174

Cuneiform inscriptions,

message received in old,22

Cuneiform inscriptions, script  
resembling,182

Cuneiform, cryptic text  
consisted of a very Old  
Babylonian language and a  
script similar to Ugaritic,28

Cuneiform , Sumero-Akkadian  
epics written in, 129

Cylinders, Babylonian,153

Cyprus,174

## **D**

*D* Amar.Ud Ne.Be.Ru sag. me.  
gar mamzassu,136

*d* Ne.Be.Ru ana ud-du-u rik-si-  
su-un,131

*d* Ne-be-ru kakkabu-su sa ina

same, u-su-pu-u,131

*d* Ne-be-ru ne-be-re-et same,

u erseti lu tamehma,130

d, prefix,133

Dachau, detention of 2,345

Catholic priests at,108

Darkness, forces of,139

Darkness, Legions of,209

DARPA,236

Data used to build other types

of UFOs, technical,21,22,54

Data of Maria Orsic,

technical,21,22,41,70

Data on how to build a super

flying machine,

Aldebaran's

technical,21,22,28

Data, Aldebaran's technical,21

Daughter of Goering,91

Daughter, Himmler's,91

Days calendar and moons

around the inhabitable

planets in Aldebaran,138

Days of Maria Orsic in

Germany, final,117

Dayton,182

DC-3,181

DC-4,181

Deadly developments in air

warfare,70

Death Beam invention,212

Death does not exist in their

world,166

Death mask of Nikola

Tesla,216

Death, world of,154

Debris from the UFO crash site

near Roswell,224

Debris of a crashed UFO near

Roswell in 1947,48

December 17 of 1923: A new

model of

Jenseitsflugmaschine,51

December 1919, third

meeting; Wednesday 17,25

Deciphered by Tesla,

extraterrestrials code,220

Deciphering extraterrestrial

messages,211

Deciphering technical data on

how to build the

spaceship,23

Defeat of Nazi Germany,

extraterrestrial messages

predicting the,91

Defense Advanced Research

Projects Agency,236

Defense Department,182

Definition of Anunnaki,

correct,154

Defragmented,47

Degree line, 33.33,48

Degree stargate line, 33.33,

48,84

Deity, Ne.Be.Ru as a,134

Deity,133

Delitzsch, Friedrich,24 ,26 ,28

Delta Wing plane (DM-1),82

Department, Foreign

Technology Desk at the



United States Army's

Research and

Development,48

Descendants of the Ak,158

Descended on Mesopotamia

450,000-460,000 B.C.,128

Descended on Phoenicia

450,000-460,000 B.C.,128

Descended on the Anatolian

plateau of Asia

Minor450,000-460,000

B.C.,128

Descended on Turkey and

Armenia 450,000-460,000

B.C.,128

Design based upon

metaphysical-

extraterrestrial

messages,84

Destination, flew to an

undisclosed,120

Destruction of cities on Earth,

aliens',209

Destructive war weapon,55

Detention of 2,345 Catholic

priests at Dachau,108

Deterioration of cells,166

Deutsche Arbeiterpartei,

investigating ,21

Developing a telepathic power

in due time,148

Development Department,

Foreign Technology Desk at

the United States Army's

Research and,48

Device, Headband Mental

Command,48

Device, Karl Schappeller's,66

Devices, spacecraft of the

aliens had no navigation,50

Devil, the,112

DHvSS,24,25,51,55,177

Dialect, old Babylonian,179

Dialogue between the Cardinal

and Maria Orsic in 1943,

110,111,112,113

Diamagnetism anti-gravity,35

Diameter of 11.5 m were built,

seventeen disk-shaped

flying machines with a,61

Die Herren Vom Schwarzen

Stein,24,25

Different dimension, entering

a,54

Different types and shapes of

Germany's UFOs,71,72

Dilmun,140

Dimension, a flying machine

for another,41

Dimension, entering a

different,54

Dimension , experiment in

another,170

Dimension, opening area in

space to enter another,135

Disc, Germany's first,43

Discoveries and inventions,

great scientific,117

Discs were seized by special

military task force of

General Dwight

Eisenhower, German

sketches of circular and

crescent-shaped,202

Discs, Vril flying,39

Discussions of the Ladies of

Vril, reconstruction of the,

22

Disintegrated,47

Disk-shaped flying machines

with a diameter of 11.5 m

were built, seventeen,61

Distrusting men,21

Divine being,133

Divine cosmic energy,134

Divine status of something or

somebody,133

DM-1,70,82

DNA of Jesus Christ,170

DNA, changing the,170

DNA,162

DNA's fifth unknown

element , 161,162

Domination over the entirety  
of Eastern Europe,  
predicting the Soviet,91  
Donovan, William,70  
Dopel, Prof. Robert,204  
Dornberger, General Dr.  
Walter,33  
Dossier on Aldebaran's  
Technical Data,38  
Dossiers on the last version of  
German UFOs,117  
Double agents in Kiev and  
Moscow,236  
Drexler, Anton,21  
Druids,159  
DRWE, Vril,117  
Duke University,  
parapsychology laboratory  
at,199

## **E**

E.555, strategic bomber,54

Ea, station of Bel and,131

Ea,152

Earliest civilizations on Earth,

created the,140

Earliest human-animal species

were originally created in

space,162

Early Allies intelligence

reports,61

Early Hebrews,135,156

Early human species who lived

underwater,162

Early Hyskos,157

Early inhabitants of Arwad,156

Early intelligent lifeforms who

lived inside Earth,162

Early Phoenicians,156

Early sketch from Thule,40

Earning very little by teaching

ballet to beginners,51

Earth hundreds of thousands of

years ago, visited,140

Earth Matrix, 161,162

Earth, aliens' destruction of

cities on,209

Earth, early intelligent

lifeforms who lived

inside,162

Earth, gods of,156

Earth, holder of the crossing of

heavens and,131

Earth-made human

creatures , 161,162

Easley, Edwin,224

Eastern Europe, predicting the

Soviet domination over the

entirety of,91

Ebla,128

Ecuador,178

Edge of their solar system:

four planets,139

Effect on the human

retina,149

Effects on humans upon arrival

to Aldebaran-Ashtari,147

Effort with other mediums and

financiers, joint,23

Egypt,157

Egyptians,156

Eisenhower Special Task Force

file, General,80

Eisenhower, General

Dwight,57,62,202

Elamites,134

Electromagnetic energy,

water as a source of,39

Electromagnetic energy,139

Electromagnetic forces, space-

time,47,48

Elements, 161,162

Elohim,156

Empire of Death, gods of

the,156

Encyclopedia Britannica,127

Energy in the universe, Vril is

the ultimate source of,133

Energy that created the

universe, benevolent and



positive,112

Energy, divine cosmic,134

Energy, electromagnetic,139

Energy, lasting force or,133

Energy, water as a source of  
electromagnetic,39

Energy”, UFO propelled by an

“Implosion,133

Engine, anti-gravity thrust,117

Engine, machine without a  
combustion,42

Engineer from *Messerschmitt's*

Kokothanki,56

Engineering of alien

technology program,

reverse, 49

Engineering of terrestrial,

lifeforms, primordial bio-

, 161,162

Engineering of the human

brain, reverse , 161,162

Engineering research/program,

aliens' headband became a

major part of the military's

alien reverse,50

Engineering, Russian early

study and research of alien

reverse,204

Enigma machine codes,211

Enki,152

Enlil,136

Enoch, Book of,157

Enochean,175

Entering a different

dimension,54

Entities from galactic

civilizations,209

Entities, biological,180

Entities, machines piloted by

non-terrestrial,46

Enuma Elish, Tablet 7,124,

125,130 epic of,130

Enuma Elish,130,135,156,

159,174

Epic of Creation,130

Epic of Gilgamesh,130,134,174

Epic of the Creation,135

Epics were written in Akkadian

on Sumerian clay

tablets,153

Epics, Sumerian,104

Epistemological influence on

the languages of the

ancient world,174

Erd,131

Erda in Ulemite,131

Erdsetu,131

Eretz in Hebrew,131

**Erhardt, Heike 26,27**

Eridu,128 ,129 ,159

Erseti,131

erSetim,154,155

Ersetu,131

Espionage, psychic,199

Eternal cosmic energy of the

self, Vril quasi-,166

Eternal time storage,

reversed,166

Ethical standards, high,52

Ethics, extraterrestrials' code

for morality and,209

Ethics,165

Etruscans,159

Europe, predicting the Soviet

domination over the

entirety of Eastern,91

Events that occurred in

multiple galaxies,171

Evolution, life , 161,162

Exotericon Gama file,

Tesla's,212,213

Exotericon,220

Experiencers,209

Experiment in another

dimension,170

Experimental circular flying

machine,62

Experimented with the "Water

Vortex", United States Air

force,39

Experiments in levitational

power of water,36

Experiments of Dr. Rascher,

medical,108

Experiments, Schapeller's,33

Explaining the world of

extraterrestrials,165

Exploration of a new kind of

science,33

Explosion,133

Extraordinary psychic,21

Extraterrestrial Anunnaki,

symbols of the,107

Extraterrestrial civilization,

warning sent by an,212

Extraterrestrial civilizations on

Earth,108

Extraterrestrial genes, lost

their,140

Extraterrestrial messages

about religions,108

Extraterrestrial messages

predicting the defeat of

Nazi Germany,91

Extraterrestrial messages,

deciphering,211

Extraterrestrial messages,

design based upon

metaphysical-,84

Extraterrestrial messages,84,

109

Extraterrestrial mind,165

Extraterrestrial Officers,

US,236

Extraterrestrial , mind of

the,170

Extraterrestrials and Anunnaki

language, Adelbaran,174

Extraterrestrials and

Anunnaki,learning from the

Adelbaran's,166

Extraterrestrials beings of

lights,128

Extraterrestrials code

deciphered by Tesla,220

Extraterrestrials code for

morality and ethics,209

Extraterrestrials contact,

independent groups of,179

Extraterrestrials cure all the

weaknesses of the human

body,148

Extraterrestrials from

Adelbaran,24

Extraterrestrials in 2022,

return of the,180

Extraterrestrials messages,

sequences of dots, “1”,

and “O” in the,212

Extraterrestrials point of

rendezvous with Maria,

Aldebaran,108

Extraterrestrials scripts in

ancient Sumerian

language,110

Extraterrestrials who created

us thousands of years

ago,111

Extraterrestrials, adjacent

planets and other,139

Extraterrestrials, channeling

with,209

Extraterrestrials, contact

with,211

Extraterrestrials, explaining  
the world of,165

Extraterrestrials, father of the  
Aldebaran's,152

Extraterrestrials,  
individual,179

Extraterrestrials, Mt. Harmon  
and Baalbeck were a  
stargate for the,143

Extraterrestrials, technical  
data received from the  
Aldebaran's,35

Extraterrestrials, wars on the  
galactic landscape of,209

Extraterrestrials  
communications between  
two (or more) alien  
spaceships, secret  
memoranda on,210

Extraterrestrials' role,33



# F

Faculties, cells in the brain

creating new visual,148

Fallen Angels, wars between

God and the,209

Farewell to Dr. Schumann,52,

117

Father of the Aldebaran's

extraterrestrials,152

Father, Maria's,33

FBI bureau, New York,218

FBI secret files on Tesla,237-

253

FBI,212 ,214 ,218

February 1944, Haunebu II

in,87

February of 1920,25

Fedden, Sir Roy,69,70

Feder, Gottfried,26,30

Fellenz, Lt. Col. Walter,119,

120

Fellez-circular UFO story was

told by Colonel Buldoc,120

Female alien Riyah,138

Fermi, Dr. Enrico,230,231

Fiasco,47

Fifth meetings, fourth and,25

Fighter ace, Germany's

greatest,57

Figures in the Russian space

programs, 100 German

scientists became

leading,203

Filchner, Wilhelm,26

File AG002/OM22-C,39

File, Tesla Beam,220

File, Tesla Government,212

Files captured by Allied

intelligence, SS secret,65

Files of British Secret

Service,202

Files of Nikola Tesla, seized by

the United States

government, personal,211

Files of the “Vril-  
Gesellschaft”,197

Files on Tesla, FBI secret,237-  
253

Files , Akashic,169

Files, CIA Helms',55

Files , MI6,202

Files , OSS's,202

Files , SS,61

Final days of Maria Orsic in  
Germany,117

Financiers, joint effort with  
other mediums and, 23

F irst American-Canadian  
UFO,182

First Disc, Germany's,43

First fully operational German  
Bell-UFO was manufactured  
in June 1934,61

First German UFOs project,61

First human beings in  
Mesopotamia, Inanna

created the,104

First meeting; Tuesday 16,

September 1919,24

First prototype of

Jenseitsflugmaschine,

March 1922,41

Fled to Argentina in 1945,91

Flegal, Hitler's personal nurse,

Account of

Erna,92,95,96,97

Flew in 1944,54

Flew to an undisclosed

destination,120

Flight of Jenseitsflugmaschine,

January, 1924: The first

successful,54

Flight test, RFZ first,86

Flight , Jenseitsflugmaschine's

successful test-,51

Flights ceased temporarily,55

Flights of three large UFO VRIL

7 , 18 test, 61

Flight-test of

Jenseitsflugmaschine on

March 23, 1922, the first,47

Flight-test was scheduled for

March 23, 1922,42

Flugzeugwerke, Bayerische,56

Fluid, basin filled with

aquamarine-tinted,147,148

Flying discs, Vril,39

Flying Machine, After-Life,42

F lying machine, Aldebaran's

technical data on how to

build a super,28

*Flying machine, anti-*

*gravity,214*

Flying machine, building a

super,24

Flying machine, experimental

circular,62

Flying machine, super,202

Flying machines with a

diameter of 11.5 m were

built, seventeen disk-

shaped,61

Flying machines, secretly

manufacturing two

small,55

Flying to the stargate of the

33.33 degree line,51

Flying wing, Horten 229,77

Focke-Wulf,56

Force or energy, lasting,133

Forces of darkness,139

Forces, Space-time

electromagnetic,47,48

Forehead, metallic band or a

belt around the,148

Foreign Technology Desk at

the United States Army's

Research and Development

Department,48

Formula , genetic,170

Founder of the Order of

Teutons,26

Founder of the Walvater

Teutonic Order of the Holy

Grail,26

Fourth and fifth meetings,25

Foxworth, P. E.,218

**Franziska Streitl**, séance to

communicate with the

spirit of, **108**

Frauenkirche,123

Freedom,178

Freemasonry,174

French,202

Frequencies, human brain',210

Frick, Wilhelm,26

Friday 16, March 1945,121

Friday 19, September 1919,

second meeting,24

Fritsch, Theodor,26,31

Frontiers of the solar system,

mental communications do

not cross the,210

Frost, John,40

Fuel, Time-Machines UFOs use

water as,38

Fuels, oil,138

Funds,without backing and,22

Furlan, Professor Dr. Boris,221

Future after 2022, the , 161,162

Future , creation of the,170

Future , going back in the,170

## G

Galactic civilizations, entities

from,209

Galactic genes,128

Galactic landscape of

extraterrestrials, wars on

the,209

Galaxies , events that occurred

in multiple,171

G atekeepers of the [Abzu](#)

temple,159

Gates, great,131

Gateway to other galaxies,127

Gateway, Ne.Be.Ru as a,134



Geis, Vrill 7,54

Geist mentally via channeling,

guiding the,54

General Arthur Trudeau,48,

49,50

**General Carl "Tooey" Spaatz,49**

General Dr. Walter

Dornberger,33

General Dwight Eisenhower,

57 ,62,202

General Eisenhower Special

Task Force file,80

General George C. Marshall,

212

General Hans Kammler, SS,33

General Jakob Sporrenberg,70

General Patton,62

Generals, linguists and

scientists, American,138

Generation of UFOs, new,70

Genes, galactic,128

Genes, lost their

extraterrestrial,140

Genetic creation of the human

races by the Anunnaki,

origin and the , 161,162

Genetic formula,170

Genetic lab of the Anunnaki in

Sumer or Phoenicia,170

Genetic lab/site of the

[Creation](#) ,159

Genetically create the first

human species, clay used

by the Anunnaki to, 161,162

Gerät, Andromeda-,84

German Bell-UFO was

manufactured in June

1934, first fully

operational,61

German Bell-UFO, 1946 to

1949, the Russians were

extremely interested in

the,201

*German Bell-UFO,*

*resembling,214*

*German Bell-UFO,211*

German colony, last,64

German military bases in

Neuschwabenland,

underground,63

German Patent of a Nazi UFO

registered under number

2,147,668,80

German scientists and shipped

them to Moscow, 657,202

German scientists became

leading figures in the

Russian space programs,

100,203

German scientists were

immediately deployed in

secret locations, 345,203

German sketches of circular

and crescent-shaped discs

were seized by special

military task force of

General Dwight

Eisenhower,202

German UFO-Bell program in

Poland,65

German UFOs project, first,61

German UFOs, dossiers on the  
last version of,117

German Workers' Party,21

Germany “First Disc”,43

Germany greatest fighter  
ace,57

Germany UFOs, different types  
and shapes of,71,72

Germany’s first anti-gravity  
UFOs, mode of operation

blueprints of,39

Gesellschaft, Vril-,51

Ghandar, Ulema,133

Giants, Biblical,209

Gibborim,156

Gilgamesh,156

Gilgamesh, Epic of,130,134,  
156,174

Gnostic scrolls,209

God and the Fallen Angels,  
wars between,209

God Chariot,180

God, moon-,135

God, Sons of,157

God,108 ,111,112

God/king Anu,158

Goddess, Anunnaki,104,106

Gods of Earth,156

Gods of heaven, Igigi,156

Gods of the Empire of

Death,156

Gods of the netherworld,156

Gods, major,158

Gods, minor,158

Gods, planet of the Anunnaki

and the ancient alien,130

Goebbles, Josef,91,92

Goebbles, Magda,91,92,94,99

Goebbles, message to

Magda,91

Goering, daughter of,91

Goering, Edda,100

Goering, Hermann,68,69

Going back in the future,170

Gorbachev, Mikhail,237

Govinda, Ulema,162

Grail, founder of the Walvater

Teutonic Order of the

Holy,26

*G ravity flying machine, anti-*

,214

Gravity thrust engine, anti-

,117

Gravity UFOs, mode of

operation blueprints of

Germany's first anti-,39

Gravity, diamagnetism anti-,35

Gravity, spaceship, anti-,38

Gray planet with swirling sand

in its atmosphere,149

Grays meetings with our

military,38

Grays,46 ,

Great Britain,203

Great Deluge, killed by

the,140

Great Deluge, lived in

Baalbeck and on Mount

Hermon for thousands of

years, beings of lights who

survived the,143

Great gates,131

Great Pyramids,146

Great scientific discoveries

and inventions,117

Greatest secrets of the

universe,112

Greeks,157 ,162

Greys,46

Ground united with the

sky,148

Guardians, the,209

**Gudrun Jentsch,26,27**

**Gudrun,26,27**

Guiding the Geist mentally via

channeling,54

Gurevich, Mikhail,203

## **H**

Ha bene Elohim,156

Habiru,125,135,136,156

Hadramout,140

Hajarat Al Houblah ,129

Hajarat Al

Houblah,142,143,144

H all of the Akashic

Records,170

Hangar in Munich, Vril sent to

a,55

Hangar, Sigrun made eight

consecutive visits to the,51

Hangar, Zeppelin,84

H angars in Brandenburg,

Rundflugzeug 1 was

developed at Arado's, 62

Hangars of Messerschmidt,

Augsburg, to take

possession of the Vril

spaceship, Vril group went

to the,119



Har,171

Harmon, Mount,140

Harrer, Karl,26

Hartmann, Major,55,57,58

Hartmann, Statement by Major

Erich,55

Haunebu I, II, III,39,70

Haunebu I,39,45,70,79

Haunebu II in February 1944,87

Haunebu II, Sketch and

technical data of,85

Haunebu II,45

Haunebu III,45

Haunebu IV,84

Haushofer, Karl,26 ,34,41

Head, Pictures start to flow

into the,148

Headband became a major

part of the military's alien

reverse engineering

research/program,

aliens',50

Headband mental command

device,48

headband, aliens bodies

animated by the,49

Heaven, Igigi, gods of,156

Heaven, offspring of the king  
of,158

Heavens and earth, holder of  
the crossing of,131

Hebrew, Shamayim in,131

Hebrews, early,135,156

### **Heike Erhardt,26**

Heike,22 ,26,27 ,118,166

Heinkel,56

Helms files, CIA,55

Helms, Richard,57,97

Heretz (Eretz) in Hebrew,131

High ethical standards,52

Higher race, Aldebaran's

extraterrestrials are the

offspring of a,140

Hill, Lewis,201

Himalaya mountains,140

Himmler, Heinrich,21,39,

69 ,85,178

Himmler, Ladies of Vril

concern about Hitler

and,22

Himmler's daughter,91

History Channel,210,211

Hitler and Himmler, Ladies of

Vril concern about,22

Hitler personal nurse, Account

of Erna Flegal,92,94,96,97

Hitler, Adolf,21

Hitler, predicting the suicide

of,91

Hitler, supporters of,55

Hitler's bunker, Adolf,92

Hitler's war machine,178

Hittites, lands of the,157

Holder of the crossing of

heavens and earth,131

Hollow-Space inside Earth,162

Holy Father in the Vatican,104

Holy Grail, founder of the

Walvater Teutonic Order of

the,26

Holy scriptures,209

Home-planet of the

Aldebaran's

extraterrestrials has two

moons and two planets

rotating around it,138

Hoover, J. Edgar,218,219,220

Horten 229 flying wing,77

Horten ,70, 229,181 ,202, 229

Horten brothers,91

Horten, Lt. Colonel Walter, 55,

70,119,122,181,182

Horten, Reinmar,181

Horten, Statement by Lt.

Colonel Walter,55

Hosts of TV shows on

aliens,130

*Hotel, New Yorker*,214 ,218

**Hovering over Munich, March**

**1945 a strange looking**

**craft,119**

Human brain, reverse

engineering of the , 161,162

Human brain' frequencies,210

Human creatures, Earth-

made , 161,162

Human creatures, oceans-

made , 161,162

Human creatures, space-

made , 161,162

Human race created by

Inanna, seven prototypes of

the,170

Human race, creators of

the,132

Human race, salvation of

the,108

Human races by the Anunnaki,

origin and the genetic

creation of the , 161,162

Human species who lived

underwater, early,162

Human-animal species were

originally created in space,

earliest,162

Humans, began to look

like,140

Humans, Man-made , 161,162

Humans , 161,162

Hundreds of thousands of years

ago, visited Earth,140

Hyksos,157,159

## I

IA 58 Pucara,181

IA 63 Pampa,181

Ibru,135

Idbir,128

Ideologies, controversial,25

Igigi, gods of heaven,156

Igigi,155,156 ,158

Ilayshim ,129

Ill purposes, science used

for,209

Illion, Theodor ,26

Ilmu Al Donia,128

Image, we were created in

their,112

Images received

telepathically,23

Implosion Energy, UFO

propelled by an,133

Implosion Motor,39

Implosion Motors to propel

UFOs,39

Implosion technology,35

Implosion, concept of,33

Implosion, Prime,133

Implosion, source of,133

In,133

Ina Abani ni-bi-ru u-cha-du-

u,134

Ina,133 ,154

Inanna created the first human

beings in

Mesopotamia,104,106

Inanna, seven prototypes of

the human race created

by,170

Inanna, symbol of,104

Inanna,170

Independent groups of

extraterrestrials

contact,179

Individual extraterrestrials,179

Inexplicable metaphysical

world,54

**Infantry Division, 1st Battalion,**

**42<sup>nd</sup>**, 119

**Infantry Division, United States**

**Army, 42<sup>nd</sup>**,55

Influence on the languages of

the ancient world,

epistemological,174

Inhabitable planets in

Aldebaran, days calendar

and moons around the,138

Inhabitants of adjacent

planets vary sharply from



one civilization to

another,139

Inhabitants of Arwad,

early,156

Inhabited by intelligent

civilizations, planets,211

Inscription on a brick from the

Tower of Babel,146

Inscriptions, message received

in old cuneiform,22

Inscriptions, script resembling

cuneiform,182

Insects and reptilians, aliens

who look machines,139

Inside Earth, early intelligent

lifeforms who lived,162

Insiders in 2007, leaked out by

NASA,56

Instructions to Maria to get out

of Munich, Aldebaran's,91

Intellectuals known for their

controversial ideologies, 25

Intelligence chief in Berlin,

United States,57

Intelligence files, United

States naval,202

Intelligence reports, early

Allies,61

Intelligence, detained by

United States Army,121

Intelligence, SS secret files

captured by Allied,65

Intelligence, United States

military,212

Intelligent civilizations,

planets inhabited by,211

Intelligent lifeforms who lived

inside Earth, early,162

Interrogation of Flegal by

military intelligence in

Berlin, in November

1945,92

Intraterrestrials regions,162

Intraterrestrials,38

Inventions, great scientific

discoveries and,117

Investigating Deutsche

Arbeiterpartei,21

Ishtar Descent to the

Underworld (Ki),156

Ishtar,106

Islam,162

Islands in the Mediterranean,

140

Israelites were called Habiru

or Abiru,135

Israelites,156

Istanbul, Turkey, spy in,236

Italians,202

Ittanakkir same ibbir,136

## **J**

Jabaariyn,156

Jababira,156

Jackson, LL,235

Jama,168

Jamara,166

January 1920,25

January 1943, meeting with

Cardinal Michael von

Faulhaber, Wednesday 13,

108

January, 1924: The first

successful flight of

Jenseitsflugmaschine,54

Japan, UFO VRIL 7 left

Germany to,63

Jbail ,129

Jehovah,173

Jenseitsflugmaschine on March

23, 1922, the first flight-

test of,47

Jenseitsflugmaschine

sketches,23

Jenseitsflugmaschine,

centrifugal movement of

the,39

Jenseitsflugmaschine,

December 17 of 1923: a

new model of,51

Jenseitsflugmaschine, first

prototype of,41

Jenseitsflugmaschine, January,

1924: The first successful

flight of,54

Jenseitsflugmaschine,21,22,

24,33,41,42,44,54,117

Jenseitsflugmaschine's

successful test-flight,51

Jensen, Peter ,26

**Jentsch, Gudrun,26,27**

Jesus Christ, DNA of,170

Jesus Christ,108,112 ,170

Jevtic, Bogoljub,221

Jewett, Frank B.,201

Jewish Scriptures,109

JFM,42

Johnson, Nancy Easley,224,225

Joint effort with other

mediums and financiers,23

Judaism,162

June 1934, first fully

operational German Bell-

UFO was manufactured

in,61

Junge, Traudl, Hitler's

secretary, 92,93,94

Jupiter, Ne.Be.Ru as a name

for,130,134

Jupiter,131

## K

Kadmosh,128

Kammler, SS General

Hans,33 ,65,70

Karma,165

kawkab al Ana'kh,132

Keeping the project secret,23

**Key player in the American**

**UFO saga cover-up,49**

Ki, children of Anu

and,158,159

Ki,157

Kiev and Moscow, double

agents in,236

Kiim,157

Kima kakkabu sut *d* Enlil

ugdammiruni isten

kakkabu,136

King Anu, god,158

King of heaven, offspring of

the,158

King, L.W.,135

Kir,157

Kiraats,174

[Kishar](#), children of [Anshar](#)

and,159

Kitabu Ilmu Al Donia,132 ,138

Klyber, Reverend Arthur

B.,109,110

Kokothanki,56

Korolev, Sergei,203,205

*Kosanovic, Sava*,211 ,212,

214,221

Kroenen, Karl Ruprecht,26

**Kuenheim, Sigrun**,26,27

Kunz to poison Goebbles six

children, Dr. Helmut, 92

Kunz, Dr. Helmut,92,97,98

Kurchatov, Igor,204

## **L**

Lab of the Anunnaki in Sumer

or Phoenicia, genetic,170

Laboratories, Russian military

bases and,202

Laboratory, Lawrence

Livermore,236

Labyrinth Channeling



séance,22

Ladies of Vril,51,84,147 ,162 ,

181

Ladies of Vril and Dr.

Schumann met with other

mediums,25

Ladies of Vril concern about

Hitler and Himmler,22

Ladies of Vril meetings,21,24

Lagash,128 ,129

Lahm and [Lahmu](#) , children

of,159

[Lahmu](#) , children of Lahm

and,159

Lake Van,140

Lakes in Adelbaran, waters,

lands and,139

Land of the Anunnaki in

Mesopotamia,153

Landed after fifty five minutes

as an archaic machine,54

Landed on the Aldebaran-

Ashtari constellation,

people who,149

Lands and lakes in Adalbaran,

waters,139

Lands of the Hittites,157

Landscape of extraterrestrials,

wars on the galactic,209

Landshut,21

L language and a script similar

to Ugaritic cuneiform,

cryptic text consisted of a

very Old Babylonian,28

Language of the Anunnaki and

the Aldebaran's

extraterrestrials,111,

173,174

Language, extraterrestrials

scripts in ancient

Sumerian,110

L languages of the Middle

East,28

Languages, ancient,111

Languages, Semitic,174

Lanz, Adolf Josef ,26

Larry King Show,224

Laser-like beam, machine

shining a,148

Last German colony,64

Lasting force or energy,133

Law, cosmic,112

Lawrence Livermore

Laboratory,236

Leaked out by NASA insiders in

2007,56

Learning from the Adelbaran's

extraterrestrials and

Anunnaki,166

Legions of Darkness,209

**LeMay, Lt. General Curtis,49**

Leningrad, Russians UFO flew

over Siberia and,60

Levitation,144

Levitational power of water,36

Levitational properties,

water's,39

Levitational Propulsion System

17,38

Levigator,117

Lewin, Dr. Ludwig,26

Lexicon, Project,231

Library, Aldebaran's

Akashic,166,167,168

Library, cosmic , 161,162

Life On Aldebaran,180

Life evolution , 161,162

Life on other planets,112

Life, Building blocks

of , 161,162

Life, two small planets that  
support,139

Life,133 ,157

Lifeforms who lived inside

Earth, early intelligent,162

Lifeforms, primordial bio-  
engineering of

terrestrial , 161,162

Light,133

Linden, Brigadier General

Henning,120

Linden, sighting confirmed by

Brigadier General

Henning,55

Line, 33.33 degree

stargate,41,48,84,183

Linguistic standard of Akkadian

and Sumerian,133

Lippisch aerodyne,83

Lippisch, Dr. Alexander,80,81,

82,83,84

Literary Arabic,156

Literature, Uragitic and

Phoenician,106

LL Jackson commander of the

base,235

Logic, cosmic,112

Lt. Col. Walter Fellenz spotted

and reported RFC-2 on

Sunday 18, March 1945,55

Lt. Col. Walter Fellenz,

reported the sighting of

UFO-Vril hovering over

Munich on Sunday 18,

March 1945.

Lt. Col. Walter Fellenz,119,

120

Lt. Colonel Grigori Tokaty,70

Lt. Colonel Horten, 70,119,

122 ,182

Lt. Colonel Walter Horten,

statement by,55

Lt. Cowling,120

Lt. Cowling: What Lt. Col.

Walter Fellenz saw in

Munich was in fact a

German UFO,120

**Lt. General Curtis LeMay,49**

Luftwaffe,113

Lyrans system consisted of 9

planets and 13 moons,139

Lyrans,139

# M

Machine blew up after spinning

and spinning like

fireworks,47

Machine for another world,41

Machine scanning your

brain,148

Machine shining a laser-like

beam,148

Machine without a combustion

engine,42

*Machine, anti-gravity*

*flying,214*

Machine, building a super

flying,24

Machine, experimental circular

flying,62

Machines piloted by non-

terrestrial entities,46

Machines UFOs use water as

fuel, Time-,38

Machines, insects and  
reptilians, aliens who look  
,139

Machines, secretly  
manufacturing two small  
flying,55

Mad-Khal,167

Magdalene, Mary,104

Magnetic energy, water as a  
source of electro-,39

Mainstream science,139

Majestic ones,156

Major gods,158

Major Hartmann,57,58

Man from cosmic clay,  
creation of,162

Man, origin of,108

Man-made humans , 161,162

Manuscripts, Anunnaki

Ulema,132

Map of Sumer, showing the  
location of the Anunnaki  
cities,129

Map of the Adelbaran's



extraterrestrials and Anunnaki's land on Earth,153

March 1922: First prototype of

Jenseitsflugmaschine,41

March 1922; first secret

prototype of Aldebaran's

Jenseitsflugmaschine,42

**March 1945 a strange looking**

**craft hovering over**

**Munich,119**

March 1945, Friday 16,121

March 1945, Lt. Col. Walter

Fellenz spotted and

reported RFC-2 on Sunday

18,55

March 1945, Thursday 15,117

March 1945: UFO VRIL 7 was

stationed in

Alpenfestung,63

March 23, 1922, flight-test was

scheduled for,42

March 23, 1922: The first

flight-test of

Jenseitsflugmaschine,47

March of 1944,54

[Marduk](#) divides the

Anunnaki,159

Marduk was called Nibiru,130

Marduk, Ne.Be.Ru as Anunnaki

god,134

Marduk,131 ,132,136

Markabah,143 (Super flying

machine)

Markadash ,129

Marseille,174

Marshal Josip Broz,217

*Marshal Tito,211 ,214,217*

Marshall, General George

C.,212

Mask of Nikola Tesla,

death,216

Masonic lodge,174

Masters of the universe and

creators of the human

race,132

Matriarchal society,165

Matrix, Anunnaki's , 161,162

Matrix, Earth, 161,162

Me 163 B UFO, phase 2,78

Me 163 UFO prototype,78

Me 163,70

Meat and fight, savages

because they eat,139

Medical experiments of Dr.

Rascher,108

Mediterranean, islands in

the,140

Mediums and financiers, joint

effort with other,23

Mediums from “Thule-

Gesellschaft”,201

Mediums, meeting with

other,22

Mediumship-channeling

séances,51

Meeting with other

mediums,22

Meeting with Professor

Winfried Otto Schumann in

a cafe on Arcisstraße,24

Meeting; Friday 19, September

1919, second,24

Meeting; Tuesday 16,

September 1919, first,24

Meeting; Wednesday 17,

December 1919, third,25

Meetings in Munich,24

Meetings of Ladies of Vrill,21,

24

Meetings with our military,

Grays,38

Meetings with the aliens,

(1947-1948), United

States,197

Meetings, fourth and fifth,25

Memoranda on

extraterrestrials'

communications between

two (or more) alien

spaceships, secret,210

Men, distrusting,21

Mental Command Device,

Headband,48

Mental command of the

spaceship,48

Mental command,48

Mental communications do not  
cross the frontiers of the  
solar system,210

Mental projection,181

Mentally commanded by a  
metallic band attached to  
the skull of aliens, UFO  
which crashed near Roswell  
was,49

Mentally via channeling,  
guiding the Geist,54

Mercury, Ne.Be.Ru as,134

Mercury,130,131

Merkabah,180

Mesopotamia 450,000-460,000

B.C., descended on,128

Mesopotamia, Inanna created  
the first human beings  
in,104

Mesopotamia ,129,140 ,153

Mesopotamian clay tablets,

ancient,107,156,209

Mesopotamian-Babylonian-

Assyrian city, ancient,134

Message received in old

cuneiform inscriptions,22

Message to Magda Goebbles,91

Messages about religions,

extraterrestrial,108

Messages by Tesla, aliens'

recorded,212

Messages from another

world,46

Messages predicting the defeat

of Nazi Germany,

extraterrestrial,91

Messages to get out of Munich,

and fly to the 33.33 degree

station line, Aldebaran ,91

Messages, aliens,22

Messages, deciphering

extraterrestrial,211

Messages, extraterrestrial,84,

109

Messages, sequences of dots,

“1”, and “O” in the

extraterrestrials’, 212

Messerschmidt, Augsburg, to

take possession of the Vril

spaceship, Vril group went

to the hangars of, 119

*Messerschmitt*, engineer from

Kokothanki, 56

Metabolism , 161, 162

Metallic band or a belt around

the forehead, 148

Metallic surface, made from

an unknown alloy, 55

Metaphysical aspect of the

project, occultic-, 54

Metaphysical project, 21

Metaphysical world,

inexplicable, 54

Metaphysical-extraterrestrial

messages, design based

upon, 84

Metaphysico-scientific nature

based upon very

sophisticated aliens'

technology,48

MI6 files,202

Middle East, languages of

the,28

Middle East, tribes in the,128

Miethe, Dr. Heinrich

Richard,70

Mighty ones,156

Mikoyan, Artem,203

Military bases and

laboratories, Russian,202

Military bases in

Neuschwabenland,

underground German,63

Military intelligence, United

States,212

Military, Grays meetings with

our,38

Military's alien reverse

engineering

research/program, aliens'

headband became a major



part of the,50

M ind of the

extraterrestrial,170

Mind recreates itself,166

Mind, extraterrestrial,165

M inds, screen can read,167

Ministry of Aircraft Production,

Chief of the Technical

Mission to Germany for

the,70

Minoans,159

M inor gods,158

Min-Zar,169

Miraya,168

MIT,36,37

Mode of operation blueprints

of Germany's first anti-

gravity UFOs,39

Modern weaponry,212

M olecular levels, biological

and,180

Molecules, subatomic,139

Moon-god,135

Moons around the inhabitable  
planets in Aldebaran, days  
calendar and,138

Moons, Ash.Ta.Ri (The planet  
of the Anunnaki) has  
four,138

Morality and ethics,  
extraterrestrials' code  
for,209

Moscow Academy of  
Medicine,211

Moscow Sechenov Academy of  
Medicine,211

Moscow, 657 German scientists  
and shipped them to,202

Moscow, double agents in Kiev  
and,236

Mothership of the aliens,  
rendezvous with the,52

Mothership, Aldebaran,84,91

Mothership, circular shape,84

Mothership,118

Motor, Implosion,39

Motors to propel UFOs,

Implosion,39

Motors, water-powered,39

Mount Harmon,140

Mouzakarar Sinhar Marduk,138

Msgr. Luigi Tralia,109

Mt. Harmon and Baalbeck were

a stargate for the

extraterrestrials,143

Mu,173

Muhammad, Prophet,174

Mul, prefix,133

Mul.Apin,136

Multi-dimensional beings,179

Multiple galaxies, events that

occurred in,171

Multitude of copies of their

body,166

**Munich, March 1945 a strange**

**looking craft hovering**

**over,119**

Munich, meetings in,24

Munich, Technical University

of,33

Munich, UFO over,120

Munich, Vril sent to a hangar

in,55

Mysteries of the alien

technology,220

Myth of Gilgamesh,156

## N

Na,133 ,154

Nabatean,173

Najani, Ulema,165

Names of the Anunnaki,

other,156

NASA insiders in 2007, leaked

out by,56

NASA Shuttle's programs,56

NASA,39

NASA's Ames Research Center

at Moffett Field California,

UFO prototype was shipped

to ,182

National Defense Research

Committee,201 ,218

Nature of God,108

Nature, 161,162

Naval intelligence files, United

States,202

Navigate underwater at 856

miles per hour,39

Navigation devices, spacecraft

of the aliens had no,50

Nazi party,21

Nazi, Germany predicting the

rise of a,21

Ne,133

Ne.Be.Ru as a crossing point to

other dimensions,134,137

Ne.Be.Ru as a deity,134

Ne.Be.Ru as a dividing point or

a zone,134

Ne.Be.Ru as a gateway,134

Ne.Be.Ru as a name for

Jupiter,130

Ne.Be.Ru as a star,134

Ne.Be.Ru as a stargate,134

Ne.Be.Ru as Anunnaki god

Marduk,134

Ne.Be.Ru as Jupiter,134,136

Ne.Be.Ru as Mercury,134

Ne.Be.Ru ina Ashtari

(Aldebaran) mina

khalkah,132

Ne.Be.Ru is his star, which he

made appear in the

heavens,131

Ne.Be.Ru,132 ,133

Ne.Be.Ru” in the

Akkadian/Sumerian

texts,130

Ne.Bi.Rim means crossing,

Akkadian and Sumerian

word,134

Ne.bi.rim, shiqil kaspum

sha,134

Ne.bi.rim,137

Ne.Bri,135

Near East, civilization, culture

and religions of the

ancient,174

Ne-bar-ti-Ash-shur,134

Nebiri,134

Nephes,133

Nephesh,133

Nephilim,156 ,157 ,209

Neteru,156

Netherworld, gods of the 156

Netherworld, the,154

Neuro-plasma, spatial,139

Neuschwabenland,

underground German

military bases in,63

Neuschwabenland,64

New circular crafts,55

New generation of UFOs,70

New kind of science,

exploration of a,33

New spaceship is built,51

New types and classes of

UFOs,57

New York FBI bureau,218

*New Yorker Hotel*,214 ,218

New Yorker, Nikola Tesla 2

room suite at the

Hotel,221,222

Newspaper "Aftonbladet",

Swedish,73

Newton, Alfred,201

Nibiru,130 ,131 ,132,135,136

Nick, Project,220,223,231

Niedner, Felix ,26

Nii,133

Nimra,166

Nimrod,142

Nineveh,128

Nippur,128

NKVD, Stalin's,55

Nomads, Arab,128

Non-terrestrial beings,46

Non-terrestrial entities,

machines piloted by,46

NSA,254



Number 0-23055, serial,55

Number 33.33,108

Nunnak,157

Nuremberg Tribunal,68

Nurse of Hitler,92,96

## O

OAP,218

Oberth, Dr. Herman,40,70

Object entering a different

dimension,54

Objects, underwater

unidentified submerged,39

Occultic-metaphysical aspect

of the project,54

Oceans-made human

creatures , 161,162

Office of Alien Property,218

Office of Scientific Research  
and Development,218

Officers, US

Extraterrestrial,236

Offspring of a higher race,

Aldebaran's

extraterrestrials are

the,140

Offspring of the Anunnaki,128 ,

145 ,152 ,179

Offspring of the king of

heaven,158

Ohio,182

Oil fuels,138

Old Babylonian dialect,179

Old Babylonian language and a

script similar to Ugaritic

cuneiform, cryptic text

consisted of a very,28

Old Sumerian language mixed

with Ana'kh,111

Old Testament,156

OLPS-17/AGSP,38

Ones, mighty,156

Opening area in space to enter

another dimension,135

Operation blueprints of

Germany's first anti-gravity

UFOs, mode of,39

Operation Paperclip,39 ,56

Orbiting Earth, alien space-

beacons,236

Order of Teutons, founder of

the,26

Organic substance, plasm-

,162

Origin and the genetic creation

of the human races by the

Anunnaki , 161,162

Origin of Man,108

Origin of the word

Anunnaki,154

Orsic, Tomislav,33

OSRD,218

OSS files, 55,202

OSS,33 ,65

Other names of the

Anunnaki,156

Other planets, life on,112

Otherworld flight machine,42

O ut of Germany in 1945:

Getting,91

Outer space, visitors from,209

Overwhelmed by the presence

of some attendees,25

Ozone,139

## **P**

Pads in the library,167

Paperclip, Operation,39 ,56

*P apers were seized by the FBI,*

*Tesla's,214*

*P apers, Nikola Tesla's,211,214*

Parallel Zones,54

Paranormal aspect of

UFOs,197

Parapsychology laboratory at

Duke University,199

Party, German Workers',21

Party, Nazi,21

Patent of a Nazi UFO

registered under number

2,147,668, German,80

Patterson Air Force Base in

Dayton, Ohio,220,223

Patton, General,62

PBS,212

Peace on earth,117

Peenemünde, saucer built

at,73

Pentagon, the,212,220

People from above,157

People of Anu,157

People who landed on the

Aldebaran-Ashtari

constellation,149

Peron,181

Persian Gulf,128

Personal files of Nikola Tesla,  
seized by the United States  
government,211

Peru,178

Philistines,159

Phoenicia, descended on,128

Phoenician cosmogony, 129,174

Phoenician literature, Uragitic  
and,106

Phoenician scriptures,153

Phoenician, Shem and shama  
in,154,155

Phoenician, Shem in,131

Phoenicians, 159

Phoenicians, early,156

Photo of the Arado plant in  
1944,53 .

Pictures start to flow into the  
head,148

P iloted by non-terrestrial  
entities, machines,46

Plama, aliens Corridor-,39

Plane (DM-1), Delta Wing,82

Planet of the Anunnaki and the  
ancient alien gods,130

Planet rotating in their  
constellation,166

Planet with swirling sand in its  
atmosphere, gray,149

Planets and other  
extraterrestrials, adjacent  
139

Planets in Aldebaran, days  
calendar and moons around  
the inhabitable,138

Planets inhabited by  
intelligent civilizations,211

Planets positioned on 33.33  
degree line which serves as  
“ Ba’ab” (Gateway) to other  
galaxies,127

Planets that support life, two

Pwithout atmosphere,139

Planets, life on other,112

Plasma, spatial neuro-,139

Plasmo-organic substance,162

## **Player in the American UFO**

**saga cover-up, key,49**

Poems, Ugaritic,153

Pohl, Hermann, 26,27

Point of rendezvous with

Maria, Aldebaran

extraterrestrials,108

Point, Ne.Be.Ru as a

crossing,134

Poland, UFO-Bell program

in,65

Poles,202

Political affiliations,25

Pollution,138

Pope Benedict XVI,104

Positive energy that created

the universe, benevolent

and,112

Power of water,

levitational,36

Predicting the rise of a Nazi

Germany,21

Predicting the Soviet

domination over the



entirety of Eastern

Europe,91

Predicting the suicide of

Hitler,91

Predictions of Maria,187-189

Prefix “d”,133

Prefix “Mul”,133

Preliminary sketches of

UFOs,117

President Eisenhower,233

President Harry Truman,200,

201

President Ronald Reagan,237

Priests at Dachau, detention of

2,345 Catholic,108

Prime Implosion,133

Primordial bio-engineering of

terrestrial life -

forms , 161,162

Program, reverse engineering

of alien technology,49

Project Lexicon,231

Project Nick,220,223,231

Project Seesaw,236

Projection, mental,181

Propel UFOs, Implosion Motors

to,39

Properties totally altered,54

Prophet Muhammad,174

Propulsion power for USOs,39

Propulsion System 17,

Levitational,38

Proto-Akkadian,133

Proto-Assyrian,133

Proto-Old Babylonian,135

Proto-Sumerian,133

Prototype of Aldebaran's

Jenseitsflugmaschine, first

secret,41,42

Prototypes of the human race

created by Inanna,

seven,170

Psychic espionage,199

Psychic, extraordinary,21

Psychics were called in,197

Psycho-somatic vision,149

Pulqi II,181

Pulqui I,181

Purposes, science used for

ill,209

Pyramids, Great,146

## Q

Quotes, of Maria,193-196

## R

Rabbi Israel Zolli, the Chief

Rabbi of Rome,109,110

Rabbi of Trieste, Chief,109

Rabu sessu da mat same

ustamsalma izzaz

kakkab,136

Race created by Inanna, seven

prototypes of the

human,170

Race, Aldebaran's

extraterrestrials are the

offspring of a higher,140

Race, creators of the

human,132

Race, salvation of the

human,108

Races by the Anunnaki, origin

and the genetic creation of

the human , 161,162

Raid of World War II against

Berlin, United States Eighth

Air Force mounted the

heaviest,119

Ram,157

Rapture, aliens',210,211 ,236

Rascher, medical experiments

of Dr.,108

Ratzinger, Joseph,103,104

Raumschiff, 145 meter,84,117

Raymond, Alphonse,201

Reactivating part of the

brain's cells,148

Reagan, President Ronald,237

Reconnaissance aerial photo of

the Arado plant in 1944,53 .

Reconstruction of the

discussions of the Ladies of

Vril,22

Recorded messages by Tesla,

aliens',212

Records, hall of the

Akashic,170

Records, OSS,55

Red Army,202

Reichsführer SS,21

Reitsch, Hanna,70

Religion,112

Religions of the ancient Near

East,174

Religions,108

Religious aspect of the UFO

phenomenon,197

Rendezvous with Maria,

Aldebaran extraterrestrials

point of,108

Rendezvous with the mother-  
ship of the aliens,52

Replica of Orsic's UFO,42

Replica of the Repulsator,37

Report, Dr. Trump's,219,220

Reports, early Allies

intelligence,61

Reptilians, aliens who look  
machines, insects and,139

Repulsator, replica of the,37

Repulsator, Viktor

Schauberger's,37

Repulsine, Viktor

Schauberger's,36

Research and Development

Department, Foreign

Technology Desk at the

United States Army's,48

*Resembling German Bell-*

*UFO,214*

Retina, effect on the

human,149

Return of the

extraterrestrials,180

Revelations by

Anamidra,161,162

Reverend Arthur B.

Klyber,109,110

Reverse engineering of alien

technology program,49

Reverse engineering of the

human brain , 161,162

Reverse engineering

research/program, aliens'

headband became a major

part of the military's

alien,50

Reverse engineering, Russian

early study and research of

alien,204

Reversed eternal time

storage,166

RFC-2 spotted and reported on

Sunday 18, March 1945 by

Lt. Col. Walter Fellenz,55

RFC-2,55

RFZ 1,61,62,202

RFZ first flight test,86

RFZ,39

Rhine, Dr. Joseph Banks,199

Rhine, Dr. Louisa,199

Richard Miethe, Dr.

Heinrich,80

Riefenstahl, Leni,103

Rise of a Nazi Germany,

predicting the,21

River Abani,134

Riyah, female alien,138

RNA , 161,162

Rome, Chief Rabbi of,109

Rooh,133

Room 40 of the British

Admiralty Building,211

Rose, Charlie,237

Rosenberg, Alfred, **26** ,29

Rosette surrounded by two

scorpions,104,105



Roswell crash site, alien

creatures at the,224

Roswell was mentally

commanded by a metallic

band attached to the skull

of aliens, UFO which

crashed near,49

Roswell, Beam Stick found on

the site of a UFO crashed

near,220

Roswell, debris from the UFO

crash site near,224

Royal blood,158

Ru,133

Ru'akh,133

Rudin, Dr. Ernst,26,30

Rudolph, Dr. Arthur,70

Ruins of Tushpa-van, capital of

kingdom of Urartu,145

Rundflugzeug 1 UFO, 45,61,202

Rundflugzeug 1 was developed

at Arado's hangars in

Rundflugzeug RFZ-1,45

Rundflugzeug RFZ-2,45

Rundflugzeug RFZ-3,45

Rundflugzeug RFZ-4,45

Rundflugzeug RFZ-5,45

Rundflugzeug,39

Russia, 10 year sentence in,57

Russia, 32 German scientists

were smuggled outside,203

Russian early study and

research of alien reverse

engineering,204

Russian military bases and

laboratories,202

Russian soldiers entering

Hitler's bunker,92

Russian space programs, 100

German scientists became

leading figures in the,203

Russian UFO,61

Russians build their own UFO,

and flew over Siberia and

Leningrad,60

Russians built their first Nikola

Tesla's beam weapon

facility,236

Russians were extremely

interested in the German

Bell-UFO, 1946 to 1949,

the,201

Russians,55,202

## S

Sack, Arthur,70,75,76

sag.me.gar mamzassu

Ittanakkir same ibbir,136

Saida,128

Sakharov, Andrei,204

Salvation of the human

race,108

Sama in Arabic,131 ,155

Sand in its atmosphere, gray

planet with swirling,149

Sänger, Dr. Eugene,55,56,70

Sänger, statement by Dr.

Eugene, 55

Sanskrit, written in codes and  
in ancient,212

Satellites, undetected by sonar  
systems and,39

Saturday 17, March 1945 ,119

Saucer built at Peenemünde,  
73

Savages because they eat  
meat and fight,139

Saydoon,128

Scandinavia,140

Scanning your brain,  
machine,148

Schapeller experiments,33

Schapeller, Karl,66

Schauberger,Victor,33,35,36,  
37,39,41,42

Schissler, Hans,121

Schoenberg, Arnold, **26** ,29

Schulte-Strathaus, Ernst,26

Schulz, Inge,93

Schumann in a cafe on

Arcisstraße, meeting with

Professor Winfried Otto, 24

Schumann met with other

mediums, Ladies of Vril and

Dr.,25

Schumann SM-Levigator,117

Schumann, Dr. Winfried

Otto,21,22,26 ,27 ,30,33,

39,41,47,48,52,54,55,56,

57,58,61,62,70,119,

Schumann, Farewell to Dr.,117

Schwarze sonne,201

Science Channel,210,211

Science used for ill

purposes,209

Science, exploration of a new

kind of,33

Science, mainstream,139

Scientific discoveries and

inventions, great,117

Scientific terminology,41

Scientifically valid,41

Scientists and shipped them to

Moscow, 657 German,202

Scientists were immediately

deployed in secret

locations, 345 German,203

Scorpions and Rosette, circa

3300 B.C. Gawra period, Sumerian,105

S creen can read minds,167

screen contacted through

the Conduit which is

located in the brain's

cells,167

S cript resembling cuneiform

inscriptions,182

Script, aliens,22

Script, translation of the,22

Scripts in ancient Sumerian

language,

extraterrestrials',110

Scrolls, Gnostic,209

SD,21

SDI,237

Séance to communicate with

the spirit of **Franziska**

**Streitel,108**

Séance, Labyrinth

Channeling,22

Seboottendorf, Rudolf Freiherr

von,26

Second meeting; Friday 19,

September 1919,24

Second World War, right after

the,56

Secret agents and spies, Allied

forces,203

Secret base in South America, SS officers and scientists fled

to a,63

Secret files of Richard Helms

(a former CIA director in

1970),57

Secret memoranda on

extraterrestrials'

communications between

two (or more) alien Spaceships,210

Secret, keeping the project,23

Secretly manufacturing two

small flying machines,55

Secrets of the universe,

greatest,112

Security Service of the Nazi

Party,21

Seesaw, Project,236

*Seized by the FBI, Tesla's*

*papers were,214*

Self, Vril quasi-eternal cosmic

energy of the,166

Semitic languages,174

Sentence in Russia, 10 year,57

Separation,209

September 1919, first meeting

on Tuesday 16, 24

September 1919, second

meeting; Friday 19,24

Sequences of dots, "1", and

"O" in the

extraterrestrials'

messages,212

Serial number 0-23055,55,119



SETI,211

Seven prototypes of the human

race created by Inanna,170

Seven types of Vril,39

Seventeen disk-shaped flying

machines with a diameter

of 11.5 m were built,61

Sha Shameh ersetim,154

Sham in Ana'kh,155

shama in Phoenician,155

Shama in Ulemite,131

Shamash,152

Shamayim in Hebrew,131

Shameh,131

shape, cigar,84

Shapes of Germany's UFOs,

different types and,71,72

Shem in Phoenician,131 ,154

Shining Ones, the,156,209

shiqil kaspum sha

ne.bi.rim,134

Shoot them on the spot,22

Shows on aliens, hosts of

TV,130

Shultz , George,237

Shumann testimony,55

Shuttle programs, NASA,56

Siberia and Leningrad,

Russians UFO flew over,60

Sicherheitsdienst,21

Sidon,128 ,173

Sievers, Wolfram,26,31

Sight anomaly,149

Sighting confirmed by

Brigadier General Henning

Linden,55

Sighting of UFO-Vril hovering

over Munich on Sunday 18,

March 1945, Lt. Col. Walter

Fellenz reported the,119

Sigrun made eight consecutive

visits to the hangar,51

Sigrun,21,22 ,26,27 ,54,55

Silver paid for the crossing,134

Sir Roy Fedden,69,70

Site of a UFO crashed near

Roswell, Beam Stick found

on the,220

Site, alien creatures at the

Roswell crash,224

Sketch and notes of

Andromeda,74

Sketch and technical data of

Haunebu II,85

Sketch from Thule, early,40

Sketch of the Vril 1-

Triebwerk,59

Sketch of the Vril 7,60

Sketches of circular and

crescent-shaped discs were

seized by special military

task force of General

Dwight Eisenhower,

German,202

Sketches of UFOs,

preliminary,117

Sketches,

Jenseitsflugmaschine's,23

Sketches, new,47

Skin, aliens suits which were

“glued” to their,49

Skull of aliens, UFO which  
crashed near Roswell was  
mentally commanded by a  
metallic band attached to  
the,49

Sky, ground united with  
the,148

Slabs and clay tablets,  
Mesopotamian,107

SM-Levigator, Schumann,117

Smokes,138

Smuggled outside Russia, 32

German scientists were,203

Solar system, mental  
communications do not  
cross the frontiers of  
the,210

Sonar systems and satellites,  
undetected by,39

Sons of God,157

Sour,128

Source of electromagnetic  
energy, water as a,39

Source of energy in the  
universe, Vril is the  
ultimate,133

Source of implosion,133

South America, SS officers and  
scientists fled to a secret  
base in,63

Soviet domination over the  
entirety of Eastern Europe,  
predicting the,91

**Spatz, General Carl**

**"Tooley",49**

Space inside Earth, Hollow-  
,162

Space programs, 100 German  
scientists became leading  
figures in the Russian,203

Space to enter another  
dimension, opening area  
in,135

Space, earliest human-animal Species were originally  
created in,162

Space, visitors from outer,209

Space-beacons orbiting Earth,

alien,236

Spacecraft flew at a speed of

300,000 km/hour,54

Spacecraft of the aliens had no

navigation devices,50

Space-made human

creatures , 161,162

Spaceship is built, new,51

Spaceship, Adelbaran's,22

Spaceship, anti-gravity,38

Spaceship, deciphering

technical data on how to

build the,23

Spaceship, mental command of

the,48

Spaceship, Vrill,119

Spaceships launching

pad/terminal,

Anunnaki,143

Spaceships, secret memoranda

on extraterrestrials'

communications between

two (or more) alien,210

Space-time electromagnetic

forces,47,48

Spatial neuro-plasma,139

Special Task Force file,

General Eisenhower,80,202

Species were originally

created in space, earliest

human-animal,162

Species who lived underwater,

early human,162

Speed of 300,000 km/hour, Spacecraft flew at a,54

Speer, Albert,177

Spies, Allied forces secret

agents and,203

Spirit of **Franziska Streitl**, Séance to communicate with

the, **108**

Spirit,157

Sporrenberg, General Jakob,70

Sputnik,203

Spy in Istanbul, Turkey,236

SS assigned projects,178

SS files,61,74

SS General Hans

Kammler,33,65,70

SS manufactured three

different sizes of UFO-bell-

shaped in 1945, the,61

SS officers and scientists fled

to a secret base in South

America,63

SS secret files captured by

Allied intelligence,65

SS top scientists,201

Stalin NKVD,55

Stalin, Joseph,62,202

Standards, high ethical,52

Star of the Anunnaki,132

Star surrounded by a

crescent,107

Star, Ne.Be.Ru as a,134

Stargate line, 33.33

degree,41,84,183

Stargate, Ne.Be.Ru as a,134

Stargates line,41

Stargates,48,127,170

Statement by Dr. Eugene

Sänger,55



Statement by Lt. Colonel

Walter Horten,55

Statement by Major Erich

Hartmann,55

Station 33.33 degree line

around Earth,117

Station line, Aldebaran

messages to get out of

Munich, and fly to the

33.33 degree,91

Station of Bel and Ea,131

Stein, Dr. Walter Johannes,26

Steiner, Rudolf Joseph

Lorenz ,26,32

Stele of Ur-Nammu, circa 2200

B.C.,107

Sterneckerstraße, Munich,117,

118

Stick found on the site of a

UFO crashed near Roswell,

Beam,220

Storage, reversed eternal

time,166

Strategic bomber "E.555",54

Strategic Defense

Initiative,237

Streicher, Julius,26,31

**Streitel, Franciscan nun**

**Franziska,108**

Study and research of alien

reverse engineering,

Russian early,204

Subatomic molecules,139

Subjects or followers of

Anu,156

Submerged objects,

underwater unidentified,39

Substance, plasmorganic,162

Sufi masters,174

Suicide of Hitler, predicting

the,91

Suits which were “glued” to

their skin, aliens,49

Sumer, showing the location of

the Anunnaki cities, map

of,129

Sumeria ,129

Sumerian clay tablets are very

confusing, Akkadian/,134

Sumerian clay tablets,

Akkadian,130

Sumerian clay tablets, epics

were written in Akkadian

on,153

Sumerian epics,104

Sumerian language mixed with

Ana'kh, old,111

Sumerian language,

extraterrestrials scripts in

ancient,110

Sumerian Scorpions and

Rosette, circa 3300 B.C.

Gawra period,105

Sumerian sun-god Utu,152

Sumerian tablets,130

Sumerian word Ne.Bi.Rim

means crossing, Akkadian

and,134

Sumerian, linguistic standard

of Akkadian and,133

Sumerian, proto-,133

Sumerian, 2,159,179

Sumerians,159

Sumero-Akkadian epics written

in cuneiform ,129

Sumero-Akkadian-Ana'kh

texts, translation of

the,109

Sunday 18, March 1945 by Lt.

Col. Walter Fellenz, RFC-2 Spotted and reported on,55

Sunday 18, March 1945, Ladies

of Vril left Munich to a

destination only known to

Dr. Schumann and Lt.

Colonel Walter Horten,119

Sun-god Utu, Sumerian,152

Super flying machine,133 ,201,

202

Supernatural aspect of the

UFO phenomenon,197

Supersonic transatlantic

airplane,178

Supporters of Hitler,55

Surrounding vision,149

Swedish newspaper

"Aftonbladet",73

Switzerland,203

Symbol of Inanna,104,105

Symbols of the extraterrestrial

Anunnaki,107

Syriac-Aramaic,156

## T

Tablets are very confusing,

Akkadian/Sumerian

clay,134

Tablets, Akkadian/Sumerian

clay,130

Tablets, ancient Mesopotamian

clay,209

Tablets, epics were written in

Akkadian on Sumerian

clay,153

Tablets, Mesopotamian

clay,107,156

Taking off vertically,39

Talmud,109

Tank, Kurt,181

Tayarah, Farid,174

Technical data used to build

other types of UFOs,54

Technical data as outlined by

Maria,33,70

Technical data of Haunebu

II,85

Technical data on how to build

a super flying machine,

Aldebaran's,24,28

Technical data on how to build

the spaceship,

deciphering,23

Technical data received from

extraterrestrials from

Adelbaran,21,22,24 ,35

Technical University in

Munich,61,63

Technical University of

Munich, not far from the,24

Technology Desk at the United  
States Army's Research and  
Development Department,  
Foreign,48

Technology program, reverse  
engineering of alien ,49

Technology, metaphysico-  
scientific nature based  
upon very sophisticated  
aliens',48

Technology, mysteries of the  
alien,220

Telepathic power in due time,  
developing a,148

Telepathically, images Maria  
received,23

Telepathy,209

Telepathic communication,181

Teleportation,144

Teller, Dr. Edward,223, 254

Temple of Marduk,146

Terminology, scientific,41

Tesla “Exotericon Gama”

file,212,213

Tesla Beam File,220

Tesla Government File,212

*Tesla papers were seized by  
the FBI,214*

Tesla was very concerned,

Nikola,209

Tesla, death mask of

Nikola,216

Tesla, extraterrestrials code

deciphered by,220

Tesla, FBI secret files on, 237-

253

Tesla, Nikola ,209,211,

212,213,214,215,216-253

*Tesla’s papers, Nikola,211*

T est-flight,

Jenseitsflugmaschine’s

successful,51

Teutonic Order of the Holy

Grail, founder of the

Walvater,26



Teutons, founder of the Order  
of,26

Texts, translation of the  
Sumero-Akkadian-

Ana'kh,109

Theosophical society,22

Thierschstraße, Munich,121

Thierschstraße, the last  
reported whereabouts of

Maria Orsic,122

Third meeting; Wednesday 17,  
December 1919,25

Third Reich was a major  
mistake,117

Those who from heaven to  
earth came,151

Threat, aliens',237

Thrust engine, anti-gravity,117

Thule members,162

Thule Society,201

Thule, early sketch from,40

Thule,24,25,51,55,177

Thule-Gesellschaft, mediums

from, 201

Thursday 15, March 1945,117

Thursday 24 February 1944,

meeting with Cardinal

Michael von Faulhaber,108

Tiamat,136

Tibet,140

Tigris and Euphrates Rivers,

around,153

Tikhonravov, Mikhail,204,205

Time electromagnetic forces,

space-,47,48

Time storage, reversed

eternal,166

Time was created, before,127

Time-Machines UFOs use water

as fuel,38

*Tito, Marshal,211,214,217*

Tokaty, Lt. Colonel Grigori,70

Tolson, Clyde A.,219

Torah,109

Tower of Babel, Inscription on

a brick from the,146

Tralia, Msgr. Luigi,109

Transatlantic airplane,

supersonic,178

Transcript of Flegal

interrogation by military Intelligence in Berlin, in

November 1945,92

Transcripts of 1947 and 1948,

Aliens,49,138

Translation of the script,22

Translation of the Sumero-

Akkadian-Ana'kh texts,109

Traute A. **Blohm**,26,27

Traute,21,22,23,26,27,46,118

Tribes in the Middle East,128

Tribunal, Nuremberg,68

Triebwerk, Vril,54,59,117

Triebwerk,59,117

Trieste, Chief Rabbi of,109

Trilithon of Baalbeck,142

Trudeau, General

Arthur,48,49,50

Truman, President

Harry,200,201

Trump, Dr. John G.,218

T ruth about Mary Magdalene,

tell the,104

Truth is not in the Bible,111

Tuesday 16, September 1919,

First meeting,24

Tuesday 4 May 1943 , meeting

with Cardinal Michael von

Faulhaber,108

Turkey and Armenia 450,000-

460,000 B.C,descended

on,128

Tushpa-van, capital of

kingdom of Urartu, ruins

of,145

TV shows on aliens, hosts

of,130

Two small planets that support

life,139

Types and classes of UFOs,

new,57

T ypes and shapes of

Germany's UFOs,

different,71,72

Types of UFOs, technical data

used to build other,54

Tyrakh,128

Tyre,128 ,173

## U

UFO a real UFO? Vrll-,180

UFO crash site near Roswell,

debris from the,224

UFO crashed near Roswell,

Beam Stick found on the

site of a,220

UFO Haunebu I,79

UFO over Munich,120

UFO phenomenon, religious

aspect of the,197

UFO phenomenon,

supernatural aspect of

the,197

UFO photograph taken in

Hamburg, Germany in

March 1918,46

UFO propelled by an

“Implosion Energy”,133

UFO prototype was shipped to

NASA’s Ames Research

Center at Moffett Field,

California,182

UFO prototype, Me,163,78

UFO registered under number

2,147,668, German Patent

of a Nazi,80

UFO Rundflugzeug 1,61

**UFO saga cover-up, key player**

**in the American,49**

UFO story was told by Colonel

Buldoc, Fellez-circular,120

UFO VRIL 7 left Germany to

Japan,63

UFO VRIL 7 stationed in

Alpenfestung,63

UFO VRIL 7 were produced,

and made 18 test flights in

1944, three large,61

UFO VRIL 7,70

UFO was manufactured in June

1934, first fully operational

German Bell-,61

UFO which crashed near

Roswell was mentally

commanded by a metallic

band attached to the skull

of aliens,49

UFO, 1946 to 1949, the

Russians were extremely

interested in the German

Bell-,201

UFO, Aldebaran's,21

UFO, and flew over Siberia and

Leningrad, Russians build

their own,60

UFO, first American-

Canadian,182

*UFO, German Bell-,211*

UFO, phase 2, Me 163 B,78

UFO, replica of Orsic's,42

*UFO, resembling German Bell-*

,214

UFO, Russian,61

UFO, Vrtil society continued

with two new versions of a

Bell-,62

UFO-Bell program in Poland,65

UFO-bell-shaped in 1945, the

SS manufactured three

different sizes of,61

Ufology jargon,26

U fology, American,46

UFOs classes, Bell-,70

UFOs project, first German,61

UFOs use water as fuel, time-

machines,38

UFOs, different types and

shapes of Germany's,71,72

UFOs, dossiers on the last

version of German,117

UFOs, Implosion Motors to

propel,39

UFOs, mode of operation

blueprints of Germany's

first anti-gravity,39



UFOs, new generation of,70

UFOs, new types and classes

of,57

UFOs, paranormal aspect

of,197

UFOs, preliminary sketches

of,117

UFOs, technical data used to

build other types of,54

UFO-Vril hovering over Munich

on Sunday 18, March 1945. Lt. Col. Walter Fellenz,

reported the sighting

of,119

UFO-Vril,120 ,133

Ugarit ,129

Ugaritic cuneiform, cryptic

text consisted of a very Old

Babylonian language and a

script similar to,28

Ugaritic poems,153

Ukraine,236

Ulema Albakr,173

Ulema Albard,165

Ulema Anunnaki,127 ,137

Ulema Bukhtiyar,133

Ulema Ghandar,133

Ulema Govinda,162

Ulema manuscripts,

Anunnaki,132

Ulema Najani,165

Ulema,157

Ulemite, Shama in,131

Ulemite,135

Umma,128

U nderground German military

bases in

Neuschwabenland,63

Underwater at 856 miles per

hour, navigate,39

Underwater unidentified

submerged objects,39

Underwater, alien race

living,233

Underwater, early human

species who lived,162

Underworld, the,154

Undetected by sonar systems

and satellites,39

Unidentified submerged

objects, underwater,39

United Nations General

Assembly,237

United States Air force

experimented with the

“Water Vortex”,39

United States Air Force,37,

39,48,182

United States Army

intelligence, detained

by,121

**United States Army, 42nd Infantry Division,55**

**United States Army,119**

United States Army's Research

and Development

Department, Foreign

Technology Desk at the,48

United States Eighth Air Force

mounted the heaviest raid

of World War II against

Berlin,119

United States government,

personal files of Nikola

Tesla, seized by the,211

United States intelligence

chief in Berlin,57

United States meetings with

the aliens, (1947-1948),197

United States military

intelligence,212

United States naval

intelligence files,202

Universe, benevolent and

positive energy that

created the,112

Universe, greatest secrets of

the,112

Universe, Vril is the ultimate

source of energy in the,133

University in Munich,

Technical,33,61

Unknown alloy, metallic

surface, made from an,49,

55

Upper layer (Top of the

machine) disintegrated,47

Ur,128 ,129

Uragitic and Phoenician

literature,106

Urartrians were the remnants

of the Adelbaran's

extraterrestrials,145

Urartu, Ruins of Tushpa-van,

capital of kingdom of,145

Urartu,140

Ur-Nammu, circa 2200 B.C.,

stele of,107

Uruk,128 ,129

US Extraterrestrial

Officers,236

u-sar-sid man-zad-az,131

USOs,39

Utu, Sumerian sun-god,152

# V

V1,202

V2,202

Vatican, Holy Father in

the,104

Venezuela,178

Verscheur, Dr. Otmar Freiherr

von,26,30

Version of German UFOs,

dossiers on the last,117

Vertically, taking off,39

Vision, psycho-somatic,149

Vision, surrounding,149

Visited Earth hundreds of

thousands of years ago,140

Visitors from outer space,209

Visits to the hangar, Sigrun

made eight consecutive,51

Visual faculties, cells in the

brain creating new,148

von Braun, Dr.,40, 56 ,70,

73 ,197,198 , 223,231, 254

von Faulhaber, Cardinal

Michael,103,104,108,110,

111,112,113

von Seboottendorf, Rudolf

Freiherr,26,

Von Verscheur, Dr. Otmar

Freiherr,26,30

von, Wartenburg, Dr.

Wolfram,26

Vortex, United States Air force

experimented with the

Water,39

Vril 1-Triebwerk, Sketch of

the,59

Vril 2 crafts,84

Vril 7 Geis,54

VRIL 7 left Germany to Japan,

UFO,63

VRIL 7 was stationed in

Alpenfestung,63

Vril cosmic energy,144

Vril DRWE,117

Vril flying discs,39

Vril group went to the hangars  
of Messerschmidt,  
Augsburg, to take  
possession of the Vril  
spaceship,119

Vril is the ultimate source of  
energy in the universe,133

Vril quasi-eternal cosmic  
energy of the self,166

Vril sent to a hangar in  
Munich,55

Vril society continued with two  
new versions of a Bell

Vril spacecraft,97 ,119

Vril Triebwerk,54

Vril UFO hovering over Munich  
on Sunday 18, March 1945.

Lt. Col. Walter Fellenz,  
reported the sighting  
of,119

Vril UFO,120

Vril, Ladies of, 51,181

Vril, meetings of Ladies of,21



Vril,22,211,214 ,202

Vril-Gesellschaft, files of

the,197

Vril-Gesellschaft,5,1971

Vril-UFO a real UFO?180

VZ-9AV,182

## W

Wa min Ashtari (Aldebaran)

barazat Ne.Be.Ru,132

Wagner, Dr. Herbert A.,70

Walvater Teutonic Order of

the Holy Grail, founder of

the,26

War machine, Hitler's,178

War weapon, destructive,55

W arfare, deadly developments

in air,70

Warning sent by an

extraterrestrial

civilization,212

Wars between God and the

Fallen Angels,209

Wars on the galactic landscape

of extraterrestrials,209

Wartenburg, Dr. Wolfram von,

Watchers,157,209

Water as a source of electro-

magnetic energy,39

Water as fuel, Time-Machines

UFOs use,38

Water levitational

properties,39

Water needed as a propulsion

fuel,38

Water Vortex, United States

Air force experimented

with the,39

Water, levitational power

of,36

water-powered motors,39

Waters, lands and lakes in

Adelbaran,139

Weapon System 606 A,182

Weapon, destructive war,55

Weaponry, modern,212

Wednesday 13, January 1943,

meeting with Cardinal

Michael von Faulhaber,108

Weil im Schönbuch,57

White House, The,212

Who are the Anunnaki?,151

**Wiesbaden Airport,49**

Wing plane (DM-1), Delta,82

Wing, Horten 229 flying,77

Wings, circular shape flying

craft without,120

Within, from,157

Wonder-machines,24

Wonder-weapons,70

World of death,154

World of extraterrestrials,

explaining the,165

World War One,21

World War Two

cryptologists,211

World, death does not exist in

their,166

World, epistemological

influence on the languages

of the ancient,174

World, inexplicable

metaphysical,54

World, machine for another,41

World, messages from

another,46

Wright Field,182

Written in codes and in

ancient Sanskrit,212

Wunder Wasser,39

## Y

Yahweh,173

Yaw,173

Yemen,140

## Z

Zeppelin hangar,84

Zhukov, Marshal,62

Ziegler, Leopold ,26 ,32

Zolli, Eugenio,110

Zolli, the Chief Rabbi of Rome,

Rabbi Israel,109,110

Zone, Ne.Be.Ru as a dividing

point or a,134

Zones, Parallel,54

## INDEX OF NAMES

# Maximilien de Lafayette

ANUNNAKI GENETIC CREATION OF THE  
HUMAN RACES, DEMONS AND SPIRITS.

© Lokas, Part 1



Chapter 1

# Maximilien de Lafayette

MARIA ORSIC, NIKOLA TESLA, THEIR  
EXTRATERRESTRIALS MESSAGES, THE  
OCCULT AND UFOS. Vol. 2

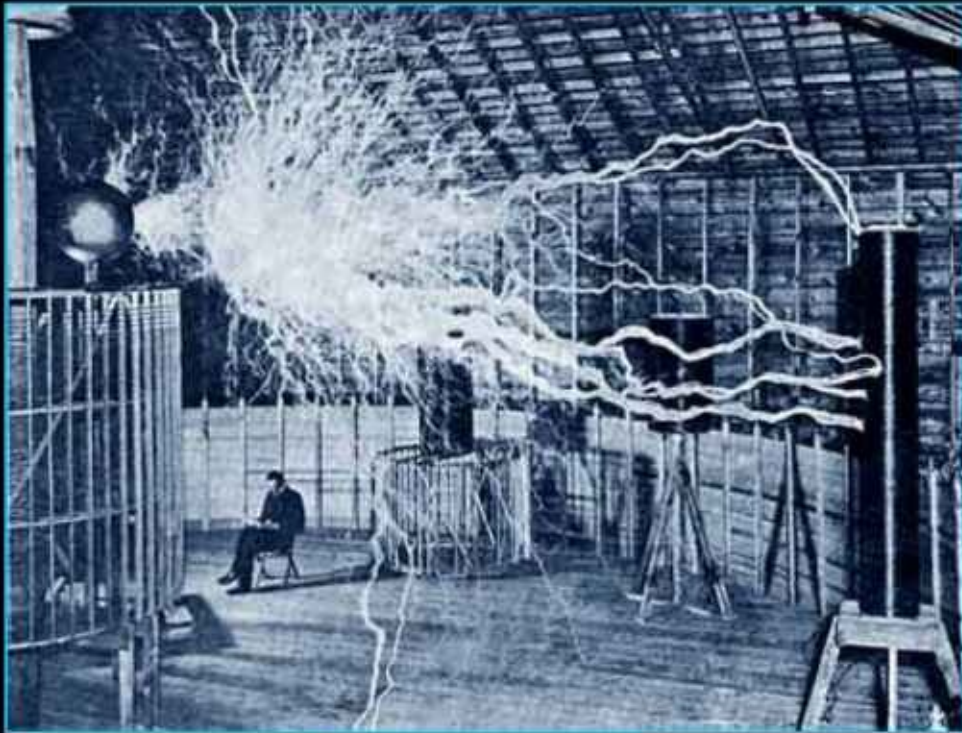

## A

Adams, Roger,201

Afanasyev, Sergey Aleksandrovich,204

Albahr, Ulema,173

Albard, Ulema,165

Amann, Max,26

Anu, god/king,158

## B

Baird, Albert,201

Blauer, Rudolf,26

**Blohm**, Traute A., 26 , 27



Bormann, Martin (Hitler's  
private secretary) ,93,95,97

Brigadier General Henning  
Linden, sighting confirmed  
by,55

Brigadier General Henning  
Linden,120

Brigadier General L. C.  
Craigie,70,220,223,224

Broz, Marshal Josip,217

Bukhtiyar, Ulema,133

Burwitz, Gudrun,91

Bush, Dr. Vannevar,  
200,201,227

## C

Cardinal Michael von

Faulhaber, Maria's letter

to,103,108

Clarke, Jerome,201

Clyde A. Tolson,219,220

Col. Walter Fellenz, reported

the sighting of,119

Colonel Buldoc,120

Compton, K. T.,201

Conant, James B.,200,201

Cowling, Lt.,120

Craigie, Brigadier General L.

C.,70,220,223,224

## **D**

Delitzsch, Friedrich,24 ,26 ,28

Donovan, William,70

Doppel, Prof. Robert,204

Dornberger, General Dr.

Walter,33

Drexler, Anton,21

## E

Ea,152

Easley, Edwin,224

Eisenhower Special Task Force

file, General,80

Eisenhower, General

Dwight,57,62,202

Enki,152

Enlil,136

**Erhardt, Heike 26,27**

## F

Fedden, Sir Roy,69,70

Feder, Gottfried,26,30

Fellenz, Lt. Col.

Walter,119,120

Fermi, Dr. Enrico,230,231

Filchner, Wilhelm,26

Flegal, Hitler's personal nurse,

Account of

Erna,92,95,96,97

Foxworth, P. E.,218

**Franziska Streitl,108**

Frick, Wilhelm,26

Fritsch, Theodor,26,31

Frost, John,40,182

Furlan, Professor Dr. Boris,221

## **G**

General Arthur

Trudeau,48,49,50

**General Carl "Tooley" Spaatz,49**

General Dr. Walter

Dornberger,33

General Dwight

Eisenhower,57,62,202

General Eisenhower Special

Task Force file,80

General George C.

Marshall,212

General Hans Kammler, SS,33

General Jakob Sporrenberg,70

General Patton,62

Ghandar, Ulema,133

Gilgamesh, 156,130,134,

156,174

Goebbles with her daughters,

Magda,92

Goebbles, Josef,91,92

Goebbles, Magda,91,92,94,99

Goebbles, message to

Magda,91

Goering, daughter of,91

Goering, Edda,100

Goering, Hermann,68,69

Gorbachev, Mikhail,237

Govinda, Ulema,162

**Gudrun Jentsch,26,27**

**Gudrun,26,27**

Gurevich, Mikhail,203

## **H**

Harrer, Karl,26

Hartmann, Major,55,57,58

Haushofer, Karl,26 ,34,41

**Heike Erhardt,26**

Heike,22,27,118,166

Helms, Richard,57,97

Hill, Lewis,201

Himmler, Heinrich,21,39, 69 ,85,178

Himmler, Ladies of Vril

concern about Hitler

and,22

Himmler's daughter,91

Hitler and Himmler, Ladies of

Vril concern about,22

Hitler personal nurse, Account

of Erna Flegal,92,94,96,97

Hitler, Adolf,21,55,91,92,178

Hoover, J. Edgar,218,219,220

Horten brothers,91

Horten, Lt. Colonel

Walter,55 ,70,119,181

Horten, Lt. Colonel,122 ,182

Horten, Reinmar,181

## **I**

Illion, Theodor ,26

Inanna,104,106 ,170

## J

Jackson, LL,235

Jensen, Peter ,26

**Jentsch, Gudrun,26,27**

Jesus Christ,108,112 ,170

Jevtic, Bogoljub,221

Jewett, Frank B.,201

Johnson, Nancy Easley,224,225

Junge, Traudl, Hitler's

secretary, 92,93,94

## K

Kammler, SS General

Hans,33 ,65 ,70

King, L.W.,135

Klyber, Reverend Arthur



B.,109,110

Kokothanki,56

Korolev, Sergei,203,205

*Kosanovic, Sava*,211 ,212,

214,221

Kroenen, Karl Ruprecht,26

**Kuenheim, Sigrun**,26,27

Kunz, Dr. Helmut,92,97,98

Kurchatov, Igor,204

## **L**

Lanz, Adolf Josef ,26

Larry King Show,224

**LeMay, Lt. General Curtis**,49

Lewin, Dr. Ludwig,26

Linden, Brigadier General

Henning,55,120

Lippisch, Dr. Alexander,80,81,

82,83,84

Lt. Col. Walter Fellenz spotted

and reported RFC-2 on  
Sunday 18, March 1945,55

Lt. Col. Walter Fellenz,  
reported the sighting of  
UFO-Vril hovering over  
Munich on Sunday 18,  
March 1945.

Lt. Col. Walter Fellenz,  
119,120

Lt. Colonel Grigori Tokaty,70

Lt. Colonel Horten,122 ,182

Lt. Colonel Walter Horten,  
statement by,55 ,70,119

Lt. Cowling,120

**Lt. General Curtis LeMay,49**

## **M**

Magdalene, Mary,104

Major Hartmann,57,58

Marduk was called Nibiru,130

Marduk, Ne.Be.Ru as Anunnaki

god,134

Marduk,131 ,132,136

Marshal Josip Broz,217

*Marshal Tito*,211 ,214,217

Marshall, General George

C.,212

Miethe, Dr. Heinrich

Richard,70

Mikoyan, Artem,203

Msgr. Luigi Tralia,109

Muhammad, Prophet,174

## N

Najani, Ulema,165

Newton, Alfred,201

Niedner, Felix ,26

Nimrod,142

## O

Oberth, Dr. Herman,40,70

Orsic, Tomislav,33

## P

Patton, General,62

Peron,181

Pohl, Hermann, 26,27

President Eisenhower,233

President Harry

Truman,200,201

President Ronald Reagan,237

Prophet Muhammad,174

## R

Rabbi Israel Zolli, the Chief

Rabbi of Rome,109,110

Rascher, Dr.,108

Ratzinger, Joseph,103,104

Raymond, Alphonse,201

Reagan, President Ronald,237

Reitsch, Hanna,70

Reverend Arthur B.

Klyber,109,110

Rhine, Dr. Joseph Banks,199

Rhine, Dr. Louisa,199

Richard Miethe, Dr.

Heinrich,80

Riefenstahl, Leni,103

Rose, Charlie,237

Rosenberg, Alfred, **26** ,29

Rudin, Dr. Ernst,26,30

Rudolph, Dr. Arthur,70

## S

Sack, Arthur,70,75,76

Sakharov, Andrei,204

Sänger, Dr. Eugene,55,56,70

Schapeller experiments,33

Schapeller, Karl,66

Schauberger,Victor,33,35,36,

37,39,41,42

Schissler, Hans,121

Schoenberg, Arnold, **26** ,29

Schulte-Strathaus, Ernst,26

Schulz, Inge,93

Schumann in a cafe on

Arcisstraße, meeting with

Professor Winfried Otto, 24

Schumann met with other

mediums, Ladies of Vril and

Dr.,25

Schumann SM-Levigator,117

Schumann, Dr. Winfried

Otto,21,22,26 ,

27 ,30,33,39,41,47,48,52,

54,55,56,57,58,61,62,

70,119,

Schumann, Farewell to Dr.,117

Seboottendorf, Rudolf Freiherr

von,26

Shultz , George,237

Shumann testimony,55

Sievers, Wolfram,26,31

Sigrun made eight consecutive

visits to the hangar,51

Sigrun,21,22 ,**26,27** ,54,55

Sir Roy Fedden,69,70

**Spaatz, General Carl**

**"Tooey",49**

Sporrenberg, General Jakob,70

SS General Hans

Kammler,33,65,70

Stalin NKVD,55

Stalin, Joseph,62,202

Stein, Dr. Walter Johannes,26

Steiner, Rudolf Joseph

Lorenz ,26,32

Streicher, Julius,26,31

**Streitel, Franciscan nun**

**Franziska,108**

T

Tank, Kurt,181

Tayarah, Farid,174

Teller, Dr. Edward,223, 254

Tesla, Nikola,209 ,211,

212,213,214,215,216-253

Tiamat,136

Tikhonravov, Mikhail,204,205

*Tito, Marshal,211,214,217*

Tokaty, Lt. Colonel Grigori,70

Tolson, Clyde A.,219

Tralia, Msgr. Luigi,109

Traute A. **Blohm,26,27**

Traute,21,22,23,26,27,46,118

Trudeau, General

Arthur,48,49,50

Truman, President

Harry,200,201



Trump, Dr. John G.,218

## U

Ulema Albakr,173

Ulema Albard,165

Ulema Bukhtiyar,133

Ulema Ghandar,133

Ulema Govinda,162

Ulema Najani,165

## V

Verscheur, Dr. Otmar Freiherr

von,26,30

von Braun, Dr.,40, 56 ,

70,73 ,**197,198** , 223,231, 254

von Faulhaber, Cardinal

Michael,103,104,108,110,

111,112,113

von Seboottendorf, Rudolf

Freiherr,26

von Verscheur, Dr. Otmar

Freiherr,26,30

von, Wartenburg, Dr.

## **W**

Wolfram,26

Wagner, Dr. Herbert A.,70

Wartenburg, Dr. Wolfram von,

## **Z**

Zhukov, Marshal,62

Ziegler, Leopold ,26 ,32

Zolli, Eugenio,110

Zolli, the Chief Rabbi of Rome,

Rabbi Israel,109,110



Published by  
Times Square Press,  
New York, Berlin





Printed in the  
United States of America